

THE  
GARDENER'S MAGAZINE,



CONDUCTED

By J. C. LOUDON, F.L.S. H.S. &c.

AUTHOR OF THE ENCYCLOPÆDIAS OF GARDENING AND OF AGRICULTURE, AND  
EDITOR OF THE ENCYCLOPÆDIA OF PLANTS.

---

LONDON:

PRINTED FOR

LONGMAN, REES, ORME, BROWN, AND GREEN,

PATERNOSTER-RROW.

1829.

LONDON:  
Printed by A. & R. Spottiswoode,  
New-Street-Square.



SB  
4  
G228  
V.5  
1829  
SCA4RB

## PREFACE.

---

THE most original professional facts recorded in this Volume are, the perfecting of the system of heating by hot water (p. 554.), and a new application of the mode of heating pine-pits by steam (p. 443.). The permanently useful subject of Horticultural Chemistry has been continued (p. 11. 127. and 404.), and commenced in connection with vegetable physiology and the operations of culture (p. 394.). The very complete forcing structures erected in the Duke of Northumberland's kitchen-garden at Syon have been described in detail (p. 502.); and a variety of other improvements in gardens, foreign and domestic, are noticed in the Tours of the Conductor on the Continent (p. 1. 113. 241. 369. 497. and 641.), and through different counties in England (p. 93. 222. 464. 557. and 671.). The subject of improving the condition of the labouring classes, at present in a most lamentable condition for want of employment, has been taken up by Mr. Spence (p. 125. 209.), by Captain Pole (p. 79.), by *Variegata* (p. 248.), by Y. (p. 390.), by R. S. (p. 550.); and by the Conductor, in a number of minor articles among the *Miscellaneous Intelligence*. Convinced as we are that the only effectual and permanent mode of benefiting the lowest classes of society is by raising their intellectual character; rendering every man, who has a wife and family, above absolute want, by a garden or piece of ground of at least a quarter of an acre attached to his cottage; and preventing early marriages by a prohibitory law; we would most earnestly recommend attention to what has incidentally dropped from us on these subjects (p. 69. 84. 94. 216. 223. 226. 328. 451. 540. 549. 556. 650. 659. 662.), and in the articles on Education (p. 692.), the Labouring Population (p. 706.), the Cultivation of Waste Lands (p. 704.), Parish Gardens (p. 714.), and in our different Tours. We wish it to be distinctly borne in mind, that all that we have recommended in the above passages has been for upwards of thirty years carried into execution in Wurtemberg, Bavaria, Baden, Silesia, Sweden, and other parts of the Continent, with the happiest effects. Whatever may be the general poverty of Germany and Sweden, and however

severe may appear to be the German law to prevent early marriages \*, it is certain that the poor of these countries, as Mr. Spence has remarked (p. 126.), are an independent, spirited, comfortable, and happy class, compared with the poor of Britain and Ireland. The reasons we have given; and they will be obvious to any person who may visit these countries, and examine them with attention.

The extraordinary improvement made in the application of steam to railroad and common carriages (p. 684.); a reaping machine brought to a high degree of perfection (p. 600.); a great improvement in ploughs and cultivators, by which 30 per cent will be saved in the power of draft (p. 651.); and a greatly improved water-closet, garden engine (p. 545.), and shower bath (p. 656.), have been recorded as of immediate value in domestic or rural economy, or as prophetic of great and general public benefits.

J. C. L.

*Bayswater, Nov. 25. 1829.*

---

\* See Hodgson's *Travels in Germany*. 8vo. 1815.

# CONTENTS.

## PART I. ORIGINAL COMMUNICATIONS.

### GENERAL SUBJECT.

Notes and Reflections made during a Tour through France and Germany, in the Autumn of the year 1823. By the Conductor	1. 113. 241. 369. 497. 642
Remarks on some Gardens and Country Residences in Surrey. By J. Gale, Esq.	9
Outlines of Horticultural Chemistry. By G. W. Johnson, Esq., of Great Totham, Essex	11. 127. 404
On the Tendency to Prejudice among Gardeners; and on the Importance of the Study of Botany for every Class of Cultivators. By W. D.	15
Remarks on the Conduct of some Master-Gardeners to their Journeymen. By R. S. E.	18
On some Recent Improvements in the Methods of heating Hot-houses and Hot-beds by Hot Water. By R. W. Byers, Esq.	20. 260
On a Winter Garden. By T. Rivère	23
Remarks on the Education and Amusements of the Lower Classes. By William Spence, Esq. F.L.S.	125
Vegetable Physiology, with a View to Vegetable Culture. By M. W. Hertz of Stuttgart, now in Kew Gardens	132
On the judicious Division and Employment of Time, especially addressed to Young Gardeners. By Juvenis Olitor	135
On Parochial Museums and Public Gardens, and on Dancing and Music, as Means of educating the Feelings of the Laborious Classes. By Variegata	248
Some Account of the Public Orangeries, or Public Winter Gardens, of Berlin. By M. G. A. Fintelmann of Potsdam	251
An Account of some Experiments in Physiological Botany, undertaken at Welbeck in 1823-24, and repeated in 1825, with a view to ascertain the probable Cause of Failure in Early Forced Grapes. By Mr. Joseph Thompson, Gardener to His Grace the Duke of Portland	253
An Essay on Physiological Botany, in Continuation of the Experiments described in the preceding Paper. By Mr. Jos. Thompson	257
Notice of a durable Number Tally of Earthenware. By Mr. William Anderson, F.L.S. H.S. Curator of the Chelsea Botanic Garden	263
Remarks on various Gardens about London, and in other Parts of England, visited in April and May, 1829. By M. Jacob Rinz, jun., Nurseryman, Frankfurt on the Main	379
Historical Notices of the Rise and Progress of Gardening in Bavaria; with a Description of the Royal Nurseries at Munich and Weyhenstephan. By William Hinkert, Royal Bavarian Court-Gardener, and Director of the Royal Central Fruit Tree Nursery at Weyhenstephan, Member of the Agricultural Society of Bavaria and of the Deputation for the Culture of the Silkworm there	384
On Practical Cooperative Societies as a means of ameliorating the Condition of the Laborious Classes, with some Account of the Brighton Cooperative Society. By Philanthropist	387
On the Introduction of Botany into the System of Education in Village Schools. By Y.	390
Hints with regard to the Drying of Botanical Specimens. By W. D.	391
On the Necessity and Advantage of enquiring scientifically into the Practices and Results of Horticulture. By Joseph Hayward, Esq., Author of <i>The Science of Horticulture</i> , and other Works	394

On the Climate of the Eastern and Middle States of North America, with reference to Horticulture. By Mr. W. Wilson of New York	409
Some Account of the Botanic Garden at Lisbon. By W. Churchill, Esq., Royal Marines	412
On Straw or Reed Mats, as a Covering for Hot-houses and Hot-beds. By Peter Lündegaard, Esq. C.M.H.S., Court-Gardener to the King of Denmark	414
Some Account of the Duke of Northumberland's Improvements in the Kitchen-Garden and Forcing-Department at Syon. By the Conductor	502

### GARDEN ARCHITECTURE AND LANDSCAPE-GARDENING.

On the Laying out and Planting of Burying-Grounds. By John H. Moggridge, Esq.	26
Plan of the Kitchen-Garden at Annat. By Mr. Archibald Gorrie, C.M.H.S.	28
On Landscape-Gardening as a Part of the Study and Business of Practical Gardeners. By a Landscape-Gardener	30. 264
On forming Artificial Seas in Ornamental Landscape, and on a New Sluice for regulating the Rise and Fall of the Tide in such Seas. By Mr. W. Aitken, Nurseryman, Castle Douglas, Author of <i>Navarino</i> , a Poem	137
Description of an ornamental Conservatory, in the Grecian Style of Architecture, built by Mr. Robert Roberts, Plumber, Glazier, and Gas Proprietor, Oswestry, Salop. By Mr. Roberts, and J. P.	268
Remarks on Metallic Hot-houses. By Mr. George M'Leish	416
Description of a Hot-house, combining a Pinery, Vinery, Succession Pit, and Winter Green-house, all heated by one Fire. By Abraham Caldicott, Esq., F.H.S.	418

### ARBORICULTURE.

On a Method of facilitating the Growth of Thorn Hedges on high and exposed Situations. By Mr. D. Anderson	42
On the Common Whin ( <i>Ulex europæus</i> ), as a Hedge Plant. By T. H.	43
A brief Description of the Timber Trees abounding in the Province of Chocó. By W. Hamilton, Esq. M.D.	44
On the Scotch Pine. By Agronome	139
Some Observations on the Rearing of Gorse Hedges ( <i>Ulex europæus</i> ). By Spinosa	270
On the Natural Succession of Forest Trees in North America. By J. M. Philadelphia	421
Notice of a Machine for transplanting large Trees, in Use in Thoresby Park, Nottinghamshire. In a Letter to Mr. Mackay, of the Clapton Nursery. By Mr. Bennet. C.M.H.S., Gardener at Thoresby. Communicated by Mr. Mackay, F.L.S. H.S.	422
Method of cultivating the Mulberry in the Government Mulberry Plantation at Nymphenburg, with a List of the different Species and Varieties grown there. By M. Bischof, Nursery-Gardener to the King of Bavaria	424

### FLORICULTURE.

On the Propagation of Cape Heaths. By C.L.B.	47
Observations on the Improvement of Flower-Gardens. By Mr. George M'Leish	48
Observations on the Cultivation of Ferns. By Mr. James Housman	49
Historical and Descriptive Notice of a Plant of the <i>Sabal Blackburnia</i> , now in the Gardens at	

Hale Hall, Lancashire, the Seat of John Blackburne, Esq. M.P. By Thomas Kirkland Glazebrook, Esq.	52
On the Culture of the Double Yellow Rose. By Mr. John Fraser, Gardener to the Hon. William Fraser	142
On the Cultivation of Dahlias (now Georginas). By a Florist	142
An improved Mode of cultivating the <i>Calceolaria corymbosa</i> . By Mr. James Rollins	272
On the Culture of the <i>Hydrangea hortensis</i> , as practised in the Potsdam Gardens. By M. G. A. Fintelmann	273
Description of a Flower-Stand, designed and constructed for the Honourable Mrs. Fox of St. Anne's Hill. Communicated by Mr. H. Tucker, Gardener to Mrs. Fox	274
On the Cultivation of the Hyacinth. By Thomas Fleetwood, Gardener, of Donnington. Read at the Meeting of the Vale of Evesham Horticultural Society, Sept. 24. 1828	426

## HORTICULTURE.

On destroying the Mealy Bug and White Scale on Pine Plants. By Mr. W. M'Murtrie, C.M.H.S.	57
On rendering Pear Trees and other Fruit Trees fruitful, by operating on the Borders, and by Natural Training. By Mr. Robert Hiver	60
On training the Gooseberry. By Mr. William Wilson, Merly Gardens, Dorset	62
A certain and expeditious Method of raising Mulberry Trees. By Superficial	63
Abridged Communications	64, 143
An effectual Mode of destroying Slugs among Cauliflowers and Cabbages. By Mr. Henry Pike, Gardener at Winkfield Park, Berkshire	143

On the Culture of the Sweet Potato ( <i>Convolvulus Batatas</i> ), as practised in the Neighbourhood of New York. By B. W. Strong, Esq. Communicated by Messrs. G. Thorburn and Son, Nurserymen, New York	275
On the Destruction of Wasps. By Thomas N. Parker, Esq. of Sweeney Hall, Shropshire	277
Catalogue of Fruits cultivated in the Government Botanic Garden at Sydney, in New South Wales. By Mr. Charles Fraser, C.M.H.S.	280
On the Culture of the Pine-apple without Pots, in the Royal Kitchen-Gardens at Nymphenburg. By Mr. Joseph Lang, Kitchen-Gardener to the King of Bavaria	427
On the Destruction of the Mealy Bug and Scale on Pine Plants. By Mr. James Dall	430
On introducing heated Air into Cucumber Frames and Pits. By Mr. F. Mould	435
Upon the Influence of Rocks on the Prosperity of Vine Plants, and upon the Quality of their Produce. By M. Metzger, Curator of the Botanic Garden and Public Arboretum at Heidelberg, Author of <i>Europäische Cerealeen, Der Rheinische Weinbau</i> and other Works. Communicated by J. Rennie, Esq. M.A.	436
A Plan for a Strawberry Wall. By Robt. Byers, Esq.	437
On the Destruction of Wasps. By Mr. James Dall	438
On destroying Slugs by Lime Water, in preference to chopped Straw. By Mr. W. P. Vaughan	440
On the Culture of the Cow Cabbage, or Cesa-rean Cole. By Mr. Bernard Saunders, Nurseryman, Island of Jersey	440
On the Day Lily ( <i>Heemerocallis fulva</i> ), as a Forage Plant. By Mr. J. Elles	441

## PART II. REVIEWS.

Transactions of the Horticultural Society of London. Vol. VII. Part II. 145. — Vol. VII. Part III.	285, 516
Memoirs of the Caledonian Horticultural Society. Vol. IV. Part II.	443

Catalogue of Works on Gardening, Agriculture, Botany, Rural Architecture, &c., lately published, with some Account of those considered the most interesting	149, 299, 445, 518
Literary Notices	207, 323, 455

## PART III. MISCELLANEOUS INTELLIGENCE.

General Notices	324, 543, 650
Foreign Notices:	
France	67, 208, 326, 456, 546
Germany	69, 209, 326, 457
Holland and the Netherlands	327
Switzerland	457, 548, 656
Italy	70, 458, 657
Sicily	657
Spain	71
Greece	549
Russia	73
Sweden	548
Denmark	71, 547
Poland,	458
Asia	74
India	549
Madagascar	549
North America	77, 210, 458, 549, 658
Australia	327, 550
Domestic Notices:	
England	78, 212, 328, 458, 551, 659
Scotland	82, 215, 332, 461, 552, 662
Ireland	84, 216, 338, 666
Calls	557
Domestic Economy	363, 667
Hints for Improvements	668
Garden Memorandums made during a Tour in Rutlandshire, Nottinghamshire, Lincolnshire, Yorkshire, Derbyshire, Staffordshire, Worcestershire, &c., in October, 1826	671
Steam Carriages, and their estimated Influence on Domestic and General Improvement	684
Hints for Breathing Places for the Metropolis, and for Country Towns and Villages, on fixed Principles	686
Hints for a Plan for saving the Manure lost in	

the Common Sewers of London, and for rendering the Thames Water fit for Domestic Purposes	690
Parochial Institutions; or an Outline of a Plan for a National Education Establishment, suitable to the Children of all Ranks, from Infancy to the Age of Puberty	692
Cultivation of Waste Lands	704
The Condition of the Labouring Classes	706
Hints for Prize Questions, submitted to Provincial Horticultural Societies	713
Workhouse Gardens and Gardeners	714
Garden Libraries	94, 226
General Education	223
Notices of Suburban Gardens	93
Gardens of the Pantheon, or Colosseum, Regent's Park	222
Arboretum in the Garden of the Horticultural Society	344
Commercial Horticultural Society	349
The Marquess of Hertford's Villa in the Regent's Park	464
The Improvements at Windsor Castle	604
Two Articles in the Constitution of the Dunfermline Florists' Society	618
Retrospective Criticism	95, 228, 364, 465, 607, 716
Queries and Answers	107, 232, 609, 728
Horticultural Society and Garden	85, 216, 342, 466, 611, 735
The London Nurseries	220, 338, 469, 612, 736
Covent Garden Market	85, 219, 341, 472, 616, 741
Provincial Horticultural Societies	89, 220, 349, 473, 618, 742
Biography	495
Obituary	112, 240, 496, 640, 752



## LIST OF CONTRIBUTORS.

A. B. Banbury, 459.	A. B. C. 101	J. S. L. 111.	J. S. L., Cl — n, 238
A Common Gardener	732	J. T. A.	212
A Constant Reader	458, 733	J. D. C. 731.	J. D. P. 731
A Florist	142, 731	Jessop, Mr. C. Hale	106
A. G. 108. A. G., near Barnsley, 208.	228, 239	J. M. of Philadelphia	421
Agronome	139, 727	J. M., White Leaf	610
Aitken, Mr. W.	137	Johns, William, Esq. M.D. F.L.S.	607
A Landscape-Gardener	30, 264	Johnson, G. W., Esq.	11, 127, 404
Alcock, T. S.	229	J. P. 670.	J. P. B. 622
Alpha	109, 340, 471, 615	J. S. H., Cambridge, 552.	J. T. 744
A Member of the Baldock Hort. Society	474	Juvenis Olitor	133
Anderson, Mr. D.	42	J. V. 669.	J. W. B. 613
Anderson, Mr. William, F.L.S. H.S. &c.	263, 459	Knight, T. A., Esq. F.R.S. &c.	366, 719, 720
An Amateur	231, 731	Lang, Mr. Joseph	427
An Artist	670	Lawrence, Mr. C.	731, 732
An East Lothian Correspondent	608	Limond, Mr. James	462
An Exonian	639	Lindegaard, Peter, Esq. C.M.H.S.	414
An Offset	111	L. R. — r,	209
An Old Gardener	109	M. 107. M — a, 457	M. A. 670
A Practical Gardener	465	Mackay, Mr. J. B., F.L.S. H.S. &c.	422
A Shipston Correspondent	729	Maslet, the Chevalier	208
A Subscriber and Well-wisher	610	Mearns, Mr. John, F.H.S.	717, 718
A Subscriber to the Gardener's Magazine	364	Mentor	81, 110
Atherstone, G. M.	239	Merrick, Mr. John	81
A Young Beginner	611	M'Leish, Mr. George	48, 416
A Young Gardener	111	Money, Mr. D., F.H.S.	739
B.	728	M'Murtrie, Mr. W., C.M.H.S.	57, 98, 232, 608
Bischof, Mr.	424	Moggridge, John H., Esq.	26
Blaikie, Thomas, Esq.	456	Mould, Mr. F.	435
Botanicus	543	M. P., Sheffield	215
Boyce, Mr. W.	730	Murray, John, Esq., F.A.S., &c.	65, 66, 106, 107
Bree, Rev. W. T.	81	M — y	326
Brown, Mr. Samuel	95	Neutral	101
Burnard, J. P., Esq.	349	Owen, Mr. John	611
Byers, R. W., Esq.	20, 260, 437	Parker, Thos. N., Esq.	213, 277
Caldicott, Abraham, Esq. F.H.S.	418	Pearson, Mr. John	717
Causidicus	82, 103, 230, 239, 671, 723, 732, 375	Perry, Mr. John	106
C. F. W., Drayton	103	Petersen, Jens Peter, C.M.C.H.S.	548, 640
Churchill, W., Esq., R. M.	412	Philagros	237
Clarke, Mr. J.	95	Philanthropist	387
C. L. 733.	C. L. B. 47	Pike, Mr. Henry	143
C. M., Norfolk	110	P. R. 724.	P. S. 611
Dall, Mr. James	430, 438	Q., Bristol	239
Donald, Mr., F.H.S.	143	Reid, Mr. Robert	107, 661
E. D.	730	R. F.	552
Elles, Mr. J.	364, 441	Rivière, T. R., Esq.	23
Errington, Mr. Robert	98, 107, 111	Rinz, Mr. Jacob, jun.	379
Falconar, David, Esq.	611, 664	Roberts, Mr.	268
Fenn, Mr. George, jun.	460	Rollins, Mr. James	102, 109, 272
Ferne, John, Esq.	337, 338, 664	R. S. 551.	R. S. E. 18
Fintelmann, M. G. A.	210, 251, 273	Rusticus	734
Fleetwood, Mr. Thomas	426	R. W.	661
Fraser, Mr. Charles, C.M.H.S.	280	Saul, Mr. M.	728
Fraser, Mr. John	142	Saunders, Mr. Bernard	440
French, Mr. D.	725, 730	S. B., Bristol	238
F. R. — d, 611.	F. R. S. 105	Sidey, Mr. Charles	464
G. A. E.	611	Smith, John	638
Gale, I., Esq.	9	Spence, William, Esq. F.L.S.	125
G. C.	219, 342, 470, 473, 613, 618, 742	Spinosa	270
G. G., Birmingham	239	Stoke, Mr. N.	332
Glazebrook, Thomas Kirkland, Esq.	52	Superficial	63, 97
Gordon, Mr. Alexander	215	Sweet, Mr. R., F.L.S.	106, 332
Gorrie, Mr. Archibald, C.M.H.S.	28	T. B., Bristol	96
Halcomb, William, Esq.	610	T. C., Kensington	332
Hamilton, W., Esq. M.D.	44, 100	T. H. 43. Thompson, Mr. Joseph,	253, 257
Hawkins, Mr. T.	239	Thorburn, Messrs. G. and Son	211, 275
Haycroft, Mr. John	733	Tucker, Mr. H.	274
Haythorn, Mr. J.	731, 732	Variiegata	248
Hayward, Joseph, Esq.	394	Vaughan, Mr. W. P.	440
Hertz, M. W.	132	Verjuice	104, 105
Hervey, Mr. John	237	Ward, S. B., Esq.	238, 239
Hinkert, Mr. William	384	W. B., Dropmore, 215.	W. D. 15, 337, 391
Hislop, Mr. John	722	Webster, Mr. C. F.	466
Hiver, Mr. Robert	60	W. G. W., Lancashire	111
Holmes, Mr. J.	350	W. H. 332.	W. H., Kew, 111
Housman, Mr. James	49, 232	Wilkie, Mr. James	653, 655
Howes, Mr. R. L.	98	Wilson, Mr. William	62, 409
Hunter, Perceval, Esq.	734	Winter, Mr. Joseph	110
J. H. 238, 338, 460.	J. L. 458	W. J., Bridport, 733.	W. Jersey, 496
J. M. 81.	J. M., Chelsea, 540, 722	W.M. 240. W.M., Argyleshire, 239, 240, 727, 728	
J. M., Inverness-shire	84	W. S., Brussels	209, 210
J. N., a Gentleman's Gardener	238	W. W.	733
Inglis, Mr. D.	618	X. Y. 112, 212, 458	X. Y. Z., near Renfrew, 664
J. P.	268	Y.	390



THE  
GARDENER'S MAGAZINE,  
FEBRUARY, 1829.

---

PART I.  
ORIGINAL CORRESPONDENCE.

---

ART. I. *Notes and Reflections made during a Tour through Part of France and Germany, in the Autumn of the Year 1828.* By the CONDUCTOR.

As every gardener desirous of keeping up his knowledge with the progress of improvement, will not only read whatever is new on the subject of his art, but visit, from time to time, the gardens of his neighbours; in like manner, the Conductor of a Gardener's Magazine should not only examine the gardens and garden literature of his own country, but those of others. In conformity with this opinion, we made a short tour in France and part of Germany, in the last four months of the year 1828, and we now present our readers with the fruits of that tour.

As much of the benefit to be derived from visiting foreign countries depends on the previous knowledge of the traveller, and on his manner of viewing those countries, we shall commence by stating our general theory: 1., as to the advantages to be derived from travelling for improvement in gardening, agriculture, and the branches of knowledge connected with these arts; 2., as to the knowledge required in the traveller; 3., as to the manner of viewing objects, and seeking after knowledge; and, 4., as to the application of these principles to the countries visited.

After giving this introduction we shall submit the details of our tour, allotting a section to each of the principal towns

which we visited, and comprehending, under each town, the gardening and cultivation of its neighbourhood.

1. The *advantages to be derived* by an individual from travelling, with a view to his improvement in the knowledge of any particular art, may be included under the discovery of new principles or practices in that art, or the confirmation of such as are already received and adopted. Mere novelty of aspect, seeing the same objects or the same culture in a different situation, under the care of a different description of persons, and carried on by different machinery, will give rise to new ideas. A garden or farm exhibiting an inferior degree of culture on the whole, will often exhibit particular points of excellence worthy of adoption into the best systems. A practice which is comparatively new in one country may be old in another, and will there better exhibit its good or bad effects; or it may be more extended in one country than in another, and, for this reason, may there develope new principles and new consequences. To even a superficial observer, the defective practices and inferior results of one country will lend confirmation to the more perfect practices of another. Finally, in passing through countries exhibiting different kinds of culture, under different degrees of perfection, the traveller reviews what may be called a living history of practices, from the inferior to the most perfect, by which he will be enabled to assign to each its proper value.

The advantages to be derived by society in general, from the recorded travels of individuals, are so great as almost to comprise all that is necessary to the progress of civilisation. By statistical records, the results of particular laws and practices are shown on a grand scale; and, from minute details, the individuals of every particular country may adopt from every other country what is congenial to their wants and wishes. Nations, like individuals, can only know themselves by comparing themselves with other nations; and, for this purpose, descriptive intercourse is the nearest approach that can be made to actual travelling.

2. The *knowledge required* by the traveller should extend to all that has been done or written in his own country; and all that has been written in others, and especially in the country to be visited, on the subject of his pursuits. He should also possess a knowledge of his own country and that to be visited, in respect to the progress of arts and civilisation generally. Such, for example, as may be got from the best books on geography, in the extensive manner in which that science is now treated.

3. On *the manner of viewing objects*, and seeking after



knowledge, much of the benefits to be derived from travelling depends. The traveller, before he sets out, may have conceived the idea that what he has to see will surpass every thing in his own country; or he may have conceived a contrary idea, and that the only benefit he can derive from seeing other countries, is to make him thankful for his own. Both extremes are to be avoided; and the traveller should, in the first instance, proceed to examine and describe all the particulars of a country as a botanist would examine and describe a plant. The description of the country, or of the practices of any particular art in it, being completed in his mind, he may then compare it with those of other countries, marking the resemblances and differences. In doing this, he should be particularly careful in applying the terms good and bad to the practices or people of any country; because these terms, in by far the greatest number of instances, are merely relative. The original causes of all the grand differences which appear in the productions of the earth, animal or vegetable, are climate and soil. It will almost always be found that similar climates and soils, or, speaking geographically, similar latitudes, naturally produce similar animals and vegetables; and that the actual differences in the practices of nations living in the same latitudes, depend on different degrees of civilisation. Therefore, of two kinds of agriculture and national manners, each may be very suitable for its own climate and soil, and yet totally unfit for the climate and soil of the other; and though such agriculture or manners may be said to be bad, relatively to that soil, yet they are by no means bad of themselves, but actually good. Of all the obstacles to self-improvement which a traveller has to contend with, the greatest will generally be found his own preconceived notions. We, in Britain, are particularly subject to this infirmity: first, naturally, and in common with all islanders; and, next, factitiously, from our commercial intercourse with all countries. Finding most countries inferior to us in useful arts and manufactures, we are too apt to consider them inferior to us in every thing else, or to set little value on those things in which they are allowed to surpass us. The great use of travelling is to neutralise this feeling, which, perhaps, more than any other is the bane of particular and general improvement. An impartial and careful examination of other countries by a Briton, will discover to him that though they may be inferior to his own country in point of the useful arts and wealth, yet that some of them are superior to it in point of the fine arts and taste; and what would he say, if he were to discover that in others the state of civilisation and the condition of society evinced a more general diffusion of happiness?

4. In applying these principles to those parts of the Continent comprehended in our tour (figs. 1. and 2.), we shall find instruction derivable from general novelty, particular points of excellence, and what may be called historical practice, or a view of arts and civilisation in different stages of their progress.

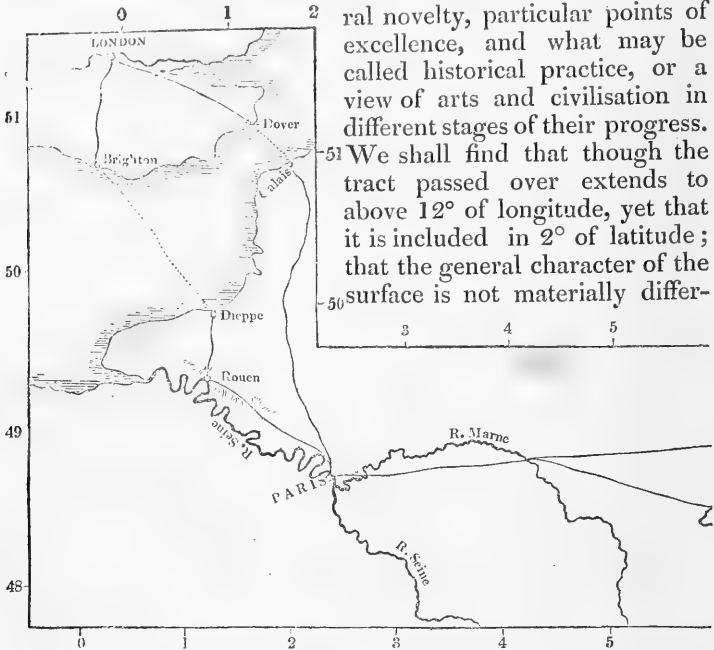

We shall find that though the tract passed over extends to above  $12^\circ$  of longitude, yet that it is included in  $2^\circ$  of latitude; that the general character of the surface is not materially differ-

ent, that the chief rocks are limestone, and that therefore the soil must be characterised by that earth; that the climate must be nearly alike, and in consequence, that the same indigenous animals and vegetables must prevail. The domesticated animals and vegetables, and the native character of man, must also be nearly the same. The causes of variation in this tract of country will be, the difference of latitude, which though it is only one degree, yet still the more northerly degree will be the colder; the difference in geographical position relatively to Britain, which, being low and surrounded by water, will have a humid and temperate climate; and the difference in elevation, by which Munich being very high and dry, its climate will be cold and its atmosphere clear. Another cause of variation may be traced to the two varieties of man which inhabit France and Germany, and are considered by some naturalists to be permanent and distinct, and to the mixture of varieties which inhabit Britain.

Comparing this theory with what actually exists in these countries and in Britain, we find the general character of the Continental surface undulating with some hills, but few mountains; the soil, for the most part, calcareous, on a cal-

careous subsoil; the plants chiefly herbaceous dicotyledones, grasses, and the amentaceous trees, as oaks, beeches, birches, &c., and coniferous trees, as pines, firs, and junipers. The artificial character of the domesticated quadrupeds may be considered the same, with some difference in their treatment at Munich, on account of the severity of the winter; the Dutch and Swiss breed of cows, the Flemish and English breed of horses, and the English and Spanish breed of sheep are found over the whole tract, and with proper treatment every where prospering.

The nature of the *agriculture* differs not essentially, but to a certain extent in the following points:— in the difference of latitude and of elevation preventing the culture of the vine, in the northerly degree in most places, and at Munich and

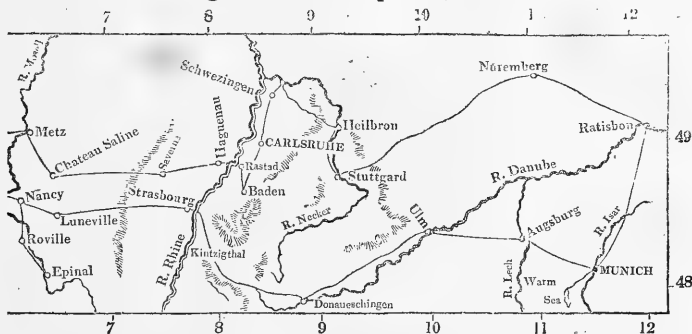

great part of Bavaria in the southern degree: in the open temperate winters of Britain admitting the growth of grass at that season; in consequence of which a great part of the surface is in pasture or meadow, and the country is subdivided into enclosed fields for the convenience of pasturing animals: in the clear warm summers of France and Germany ripening more early the corn crops, so as to admit of a second crop on the same soil, but at the same time burning up the grasses so as to render perpetual pastures rare, a disadvantage, however, which might be more than compensated by the facilities which it affords for destroying root weeds; and in the severe winters by which annual plants are destroyed, or the surface of the soil covered for two or three months with snow, by which field labours are interrupted, and cattle and sheep obliged to be kept in houses. The actual state of the agriculture of these countries, as compared with Britain, differs considerably, in some places, from defective skill and want of capital in the cultivators; in others, from the culture being of a different kind, as of vines; and, in most places, from the great division of property and the prevalence of the spade culture.

The *gardening* of the tract visited is farther advanced than that of England in some particulars, and not so far advanced in others. The principles of landscape-gardening are perhaps better understood in Germany than in England, from its professors being in general men of education: but the practical results, both there and in France, are inferior to those of England, from the want of verdure and compactness in the turf; want of colour and adhesiveness in the gravel; paucity of evergreen shrubs, and the want of order and high keeping. The kitchen-gardening is superior, at least in respect to the winter salading, partly owing to the greater demand for that article on the Continent, and partly owing to the greater dryness of the air there at that season. The culture of timber trees and the management of forests are more attended to in France and Germany than in England; because, in the former countries, in addition to all the usual uses of timber, it constitutes the principal fuel.

The *architecture* of the towns and villages on the Continent is in a higher taste than in Britain; because, the houses being larger, and the materials of a more durable and expensive nature, more consequence is attached to the building of a house, and hence more care and skill are called into exercise. Another cause which has contributed to the same effect is, that isolated cottages are not common; and thus the two and three storied houses of villages, each occupied by two or three families, and requiring to be built by regular mechanics, have not degenerated into two or three separate hovels, which the labourers occupying them build for themselves. The architecture of the public buildings on the Continent is proportionately superior to that of the public buildings in Britain; because, in the former case, the public taste is higher in proportion to the public wealth than in the latter.

The *domestic economy* of the tract visited, among the lowest class, differs less from that of the same class in Britain than might be imagined, because the bare necessities of life are almost the same in every country. In the middle and higher ranks it differs in the circumstance, on the Continent, of extent and show in houses and apartments being preferred to neatness, cleanness, and comfort; in the greater use of vegetables in cookery; in a more complex and refined cookery; and in the greater use of fruits, and the more moderate use of wines and spirituous liquors, at table.

The education of children comes within the province of domestic economy, and in consequence within the limit of our observations. It differs materially in different parts of the tract visited. In some parts of France it is in a great measure.



neglected; while in some parts of Germany it is carried farther, by the united influence of parents and the government; than has been done in Britain, or in any other country in the world.

The *manners* of the Continent differ from those of England in being more cultivated and refined, in proportion to the existence of knowledge and wealth; without doubt, principally owing to the influence of the more exhilarating climate on individual character; and in France, perhaps, in part to something in the original character of the race, in consequence of which, vivacity in conversation and gaiety are in that country necessities of life. This vivacity and personal action of the French may be the cause of the limited powers of their language, as the comparative slowness and tranquillity of the Germans are of the profundity and copiousness of theirs; and the simple structure of the English language may be traced to the taciturnity and bluntness of Englishmen. The extreme of the refinement and warmth of feeling in the French leads to officiousness or insincerity, as the extreme of the more simple manners of Britain leads to neglect or rudeness.

The honesty and sobriety of a people depend jointly on their degree of civilisation and the police of their government: France is in these respects superior to England, from her superior police and the prevalence of a better taste in regard to eating and drinking; and the parts of Germany we visited are greatly in advance both of France and England, from the joint effects of a superior police and general education.

Respect to the female character materially influences the happiness and dignity of a people, by the influence which it necessarily exercises on social manners and on the rising generation. In France this respect is less than in England, because women there do not receive the same education as the men; in Germany it is as great as in England, because there the education of the men and the women is alike. Respect to learned men, or men in any way intellectually eminent, is greater on the Continent than in England; while respect to wealth and titles is greater in England than on the Continent. Respect to religion is greater in England than abroad, because in England religion is generally connected with morality; whereas, on the Continent, morality rests chiefly on the utility and enjoyment which the exercise of it procures for society.

The *spirit of general improvement* pervades every part of the Continent, and is even more active in France than in Britain. In Britain the spirit of improvement is chiefly evinced in public works, and in the useful arts and manufactures, and its efforts are characterised much more by superfluity of

wealth \* than by science or refinement: in Germany this spirit is evinced in public buildings in a superior taste, in agriculture, and education; in France in the amelioration of public institutions, and, at this time more especially, in the establishment of a permanent system of national education.

Of all the different matters that attracted our attention during our tour, nothing struck us with so much force as the effects of general education in Wurtemberg; and the general and ardent desire to spread education throughout the lowest ranks, and to establish it on the best and firmest principles, in France. It is clearly proved in Wurtemberg and Baden, that a knowledge of the usual branches of education, such as grammar, writing, arithmetic, the French language, geography, natural history, natural philosophy, general history, and mythology, may be possessed by what is called the very lowest class of society, without endangering the safety of the state, and without preventing the rich from getting servants and workmen of every description. It is also found, that though the inhabitants of these countries are as poor as those of any country on the Continent, yet that they are as honest as any people in Europe, and that there are no mendicants among them, and very few imprisoned for debt or criminal offences. In France it is proved that all the education given in Germany, and a great deal more, in short all that is essentially useful and ornamental, may be communicated to children before the age of fifteen, by commencing at three years of age with infant schools, and continuing afterwards by means of the Lancasterian plan. The friends of France and of humanity are endeavouring to establish such a system of education on a permanent basis, and connected with such legal regulations, as shall insure its effectual application to every male and female child born in France. They are at present opposed by those who think it their interest to keep the people in ignorance; but that so grand a cause will ultimately prevail, those can only doubt who fear its effects. We sincerely hope that France will succeed in showing, to surrounding nations, what is to be effected in the world by rendering all mankind on a level, in point of useful knowledge and agreeable manners: for we are persuaded that this principle of high and equal education and manners, will produce in society what no other principle could produce; or rather, that, in its operation, it will give rise to every other ameliorating principle, and ultimately effect for the human race all the good of which their nature is susceptible.

\* Buckingham Palace, the Treasury, the water in Hyde Park and St. James's Park, &c.

After these general views, relatively to the subjects which embraced our attention, we shall proceed to give the details from which they originated, and commence in our next Number with Brighton and Dieppe.

(*To be continued.*)

---

ART. II. *Remarks on some Gardens and Country Residences in Surrey.* By J. GALE, Esq.

Sir,

THE south-east angle of England, comprising the counties of Kent, Surrey, and Sussex, possesses the best climate to be found in the island for the purpose of horticulture, and accordingly there we find the best common gardens and fruit orchards, hop gardens, and formerly vineyards. Having lately visited those counties, I made enquiries respecting the vineyard at Pains Hill, now overgrown by Scotch pine. It was originally planted with white grapes, procured from the neighbourhood of Paris, and a wine similar to champagne was made by confining the must or juice of the fruit in strong casks, bound round with cords, to prevent the force of the fermentation from bursting the casks, until the cold of the autumn frosts checked the fermentation. The soil was a poor sand, with a stony subsoil, having the advantage of a southern exposure on a steep slope. It appears to have been deficient in depth and fertility, and it is quite evident, if vines were to be cultivated in a vineyard in this climate, that every circumstance ought to be as favourable as possible. Pains Hill vineyard enjoyed only two advantages — exposure and dryness; it wanted fertility, and a loose and more porous subsoil. Claremont, the seat of Prince Leopold, has a magnificent kitchen-garden, with good hot-houses, but the collection of plants is not of the first order, as it seems that expense is rather too much considered by the present proprietor. The house is considered as the masterpiece of Brown, though, in many respects, very full of faults. The entrance hall is in the middle of the south front; consequently, the two other rooms, on right and left, having a south aspect, are separated by the hall. Claremont seems, on the whole, to be a place adapted for representation more than for comfort. The stables are too distant, and it is quite without a farm, at least no arable land is found within any reasonable distance. Oatlands has also an excellent kitchen-garden, now let to a market-gardener.

Having heard of a remarkable crop of mangold wurzel growing at Lord King's, I went to see it, and certainly a finer field was never seen. The rows are 3 ft. 6 in. or near 4 ft. distant, and the plants of a surprising size. The crop is supposed to weigh between 50 and 60 tons per acre, without the leaves: it will be taken up in the course of November, when, I was told, the leaves will be ploughed in, and the wheat sowed, without further manure or trouble, the land being in excellent order, and as clean as a garden. On enquiry, I was told that three of the largest plants grown here last year weighed 93 lbs., or 31 lbs. each root. The produce of these ten acres is really enormous, and very much exceeds any thing I have elsewhere observed. I did not exactly ascertain whether it was to be attributed to a superior mode of cultivation, or to a soil peculiarly favourable to that root. On examination, the soil is a fine friable sandy loam, very loose and deep. Never having heard any thing of the gardens at this place, I was most agreeably surprised to find a highly decorated and ornamented terrace, with a profusion of marble vases, stone balustrades, and a delightful mixture of columns and vegetation, each lending its aid to assist the charm, and I thought the description would be acceptable, as the garden appears to be exactly what is described in your Magazine (Vol. IV. p. 95.), as the best suited to our country mansions. The pleasure-gardens contain a fine collection of evergreens of the choicest sorts, the finest arbutus, bays, cypresses, and evergreen oaks, all in great perfection; indeed, the soil and exposure are as good as can be. One plant I had almost forgotten, a large *Bignonia grandiflora*, usually seen only in a conservatory, was here growing 20 ft. high, and covered with hundreds of its brilliant flowers. At the end of the house (but in a continued line with the terrace, which is a stone pavement 12 ft. wide) is a long arcade of, I suppose, 100 ft. or more in length, opening to a balustraded garden. This must furnish a very pleasant walk in rough wet weather, and is well worthy of imitation.

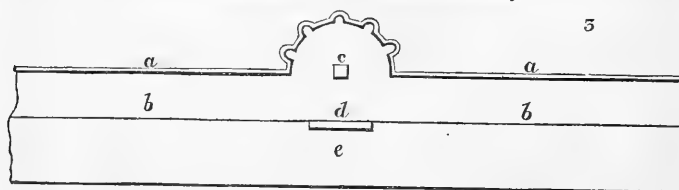

I went from this place to Albury, the seat of Mr. Drummond, situated in a lovely vale. The kitchen-garden is really beautiful; a quarter of a mile long, one straight wall (*fig. 3. a a*),

with a broad grass walk in front (*b b*). The centre of this wall forms a semicircle, ornamented with niches, and a fountain of pure spring water, conducted from the chalk hills (*c*), and beneath it is a grotto (*d*), which opens into the kitchen-garden (*e*). This place is a sweet, retired, and romantic seat, having only one defect, a want of sun in winter. It now, on the 1st of October, began to look gloomy, from the length of the shadow. In other respects, the soil is very warm and dry, and Mr. Drummond has been most successful in making water meadows, which I went particularly to see. The work is done in the best manner, at a great expense, it is true, but the early grass is invaluable for the ewes and lambs, and the hay is cut twice.

From this I went to Lord Onslow's, at Clandon, a vast cold mansion, now deserted, and never very habitable, having the garden, stable, and all appendages of a mansion at the distance of nearly half a mile. I finished my ride by looking at Lord Middleton's seat at Pepperharrow, a gentleman-like residence, on the banks of the Wey. In this county large crops of carrots are grown for the London market. If agreeable, I will send you an account of some gardens and farms in Kent for a future Number.

I am, Sir, &c.

October 10. 1828.

J. GALE.

THE continuation of our correspondent's remarks, we are sure, will be highly acceptable to our readers, and we should be most happy if he would supply us with a portion of his gardening tours for each succeeding Number, till he has described all that he has seen. Such papers are well calculated to excite emulation both in masters and servants, and they are also very gratifying to such as have little opportunity of travelling, and to foreign readers. — *Cond.*

---

ART. III. *Outlines of Horticultural Chemistry: — Vegetable Physiology.* By G. W. JOHNSON, Esq., Great Totham, Essex.

(Continued from Vol. IV. p. 452.)

THE *flowers and seeds* are those essential parts of a plant by which it is preserved from extinction. Linnæus has compendiously designated the parts of fructification "a temporary part of vegetables, terminating the old individual and beginning the new;" a definition, however, only strictly true when applied to annuals.

The *petals* of the flower evidently act an important part in nourishing the more essential parts of fructification, since, if they are removed from plants naturally possessing them, I am not aware of a single instance in which the seeds will advance a grade further towards maturity. The *stamens* and *pistils* are the most essential parts. The first are the members that secrete the pollen, or fecundating dust, without the application of which to the pistils the seed is never fertile. It is the *anther*, or summit of each stamen, that secretes this fecundating matter. The pollen appears to the unassisted vision merely a fine powder ; but, in fact, each grain is commonly a membranous bag, varying in form in different species. Pollen is chiefly discharged from the anthers during dry warm weather ; but each vesicle of it remains entire until it comes in contact with moisture, when it immediately bursts, and discharges its minute particles in a form absorbable by the small ducts of the pistil. The necessary degree of moisture usually exists upon the summit of the pistils, to which the bags of pollen cling, and thus more securely determine the impregnation of the seeds. We are furnished, by a knowledge of these facts, with a reason for the great injury occasioned to orchards, &c., by excessive wet weather during the time of flowering. The pollen is washed away from the anthers as it is secreted, and, exploding at the instant, either does not settle at all upon the pistils, or alights upon them whilst loaded with unnatural moisture which is again shaken off, or is prevented entering their orifice. They warn us, also, from watering or disturbing unnecessarily the herbage of plants under our care whilst they are in bloom. It is a fact of some importance to be known by the cultivators of hybrids and new varieties, that in dry weather pollen may be conveyed to a considerable distance uninjured. This is demonstrated by many observations on accidental impregnations by the agency of winds, &c. ; and still more decidedly by Linnæus, who kept some of the pollen of the *Játropha ùrens* in paper for more than a month, which afterwards fertilised the pistils to which it was applied. In the present general diffusion of botanical knowledge, it seems almost trite to observe that the seed-grower should neither exterminate the barren plants of the dioecious class, as in spinach, asparagus, &c., nor remove the unfertile flowers of cucumbers, &c. ; for, without these, the female blossoms would be equally unproductive. Many insects are highly injurious in the hot-house, &c., to the plants they contain ; but an indiscriminate destruction is not to be recommended. Many of them bear pollen on their wings, &c., to female flowers, which otherwise would remain unimpreg-

nated. The humblebee, above all other insects, I would have befriended, for its robust and hardy form enables it to get abroad and be employed in this useful work, when weaker insects are confined by inclement weather.

The stamens are changed into petals in double flowers, which are consequently unfertile: they are often likewise obliterated, either by excessive nourishment, or when the plant increases much by root, as in the Fiery Lily (*Lilium bulbiferum*). If this excessive production of root is very remarkable, it sometimes prevents the production of the flowers of the plant entirely, as is the case with some early varieties of the potato; for Mr. Knight demonstrated that if the tubers of such were removed as they were produced, the plants blossomed as freely as later-tubering varieties; and, *vice versâ*, the removal of the blossoms of tuberous-rooted plants promotes the size and number of the tubers. It is not to be supposed, however, that fibrous-rooted plants are not similarly affected. I have observed a gooseberry bush, that, from being under the shade of trees, &c., had never borne fruit during a series of years, to throw out annually a very excessive number of suckers. Again, fibrous-rooted land plants, which by accident are growing in water, increase the number of their radiculæ enormously, whilst their fructification is diminished and abortive in proportion.

Of the pistils, the two essential parts are the *stigma*, or orifice for the admission of the pollen, generally on the summit; and the *germen*, which is the rudiment of the future seed-vessel. Pistils, like stamens, are obliterated in double flowers, otherwise they are not so liable to become petals.

The production of the *seed* is "the being's end and aim" of every plant: all its other parts, by ministering in some way or other to its maturity, indicate its importance. Not perceiving that a description of the various parts of a seed would lead to any practical hints to the gardener, I shall proceed to the consideration of the phenomena of *germination*.

When a seed is placed in a situation favourable for vegetation, it soon swells, its skin, or *testa*, bursts, and a shoot, denominated the *radicle*, is protruded; and, in a short time, this is followed by a second, which is named the *plumula*. The radicle by degrees sinks into the earth, and becomes a perfect root; whilst the plumula rises above the surface, to expand, and complete the form of the perfect plant. The essentials for germination are several. The first of these appears to be the perfect maturity of the seed; for, although Sennebier found that peas will sometimes vegetate, though sown in a green and soft state, yet it is certain that the plants raised



from immature seed are always weak in their growth, and unproductive. Some seeds require to be sown immediately after they ripen. The coffee bean, and the seeds of angelica and fraxinella, refuse to germinate if not sown within five or six weeks after they have been gathered; but by far the majority of seeds retain their powers of vegetating, if carefully preserved, for years. Home sowed barley, which vegetated after being gathered 140 years. Farinaceous seeds, that is, such as contain a large proportion of starch, usually are those which retain their vitality the longest (barley, wheat, and oats, are of this number), inasmuch as that that constituent is very slow in decomposing. Oily seeds, and those enclosed in juicy berries, or other seed-vessels of a mucilaginous or saccharine quality, are the most liable to spoil. It is to be observed that, for the gardener, old seed is sometimes desirable; the plants from it run less luxuriantly in foliage, and produce their blossom and fruit more early than those from new seeds: hence, for melons, early and late crops of peas, &c., seed that is a year or two old is to be preferred.

No seed will germinate without oxygen gas, moisture, and a certain degree of heat are present. The requisite proportions of these vary in different individuals; but, in the total absence of any one, no seed will advance a single grade in vegetation. When all are present to a seed, carbonic acid gas is evolved, and oxygen absorbed. This gas is afforded to the seed from the atmosphere, in which we shall see hereafter it exists in the proportion of about 21 per cent. From the experiments of Saussure we learn that, weight for weight, wheat and barley, during germination, absorb less oxygen than peas; whilst these consume less than beans and kidneybeans. The first two may, therefore, be buried at a greater depth below the surface of the earth than the last three, without vegetation being prevented; for it is the want of a due supply of oxygen, at great depths from the surface, that prevents the germination of seeds so buried. Seeds that are thus situated, however, will often retain their vegetative power for an apparently unlimited period: hence earth, taken from a considerable depth, will often, when brought to the surface, be covered with thistles, charlock, &c. In botanic gardens, plants, that were supposed to be lost to the establishments, have often been recovered by the casual digging over the borders where they had been grown; some of their seed having been buried in by a previous turning over of the soil. Seeds abounding in oil have been observed to retain their vitality the longest when so buried.

Oxygen gas is so essential to germination, that any application to seeds that affords it to them in abundance greatly accelerates the process: hence, M. Humboldt found that chlorine, which yields abundance of that gas when in contact with water, by combining with its hydrogen and setting the oxygen at liberty, produced this acceleration of vegetation. At Vienna several seeds, which were of considerable age, and had constantly refused to germinate, did so readily when treated with it. Plants raised from such seeds are undoubtedly more weak than others raised from seed in which no such extra-stimulus is required. Mr. George Sinclair, author of the excellent *Hortus Gramineus Woburnensis*, however, informs me that he has employed chlorine with singular success. He obtains it by mixing a table-spoonful of muriatic acid with a similar quantity of black oxide of manganese, and half a pint of water. After allowing the mixture to remain two or three hours, the seed is to be immersed in the liquid for a similar period, and then sown. Another, and, I consider, the most eligible mode of applying the chlorine, was also suggested to me by the same distinguished horticulturist. In this way, he says, he has made tropical seeds vegetate, which refused to germinate by other modes of treatment. He placed the mixed ingredients mentioned above in a glass retort, inserting its bulb in the hot-bed, and bringing its beak under the pot in which the seeds were sown, connecting it with the draining aperture of the pot. The chlorine gas is gradually evolved, passing through the earth of the pot to the seeds, accordingly as the heat required for the different species induces.

Aghard and others have proved that seeds will not germinate in any gas without a mixture of oxygen.

(*To be continued.*)

---

ART. IV. *On the Tendency to Prejudice among Gardeners; and on the Importance of the Study of Botany for every Class of Cultivators.* By W. D.

Sir,

It is well known that, in many of the humbler professions of life, a great antipathy is generally manifested to every thing which bears on its face the appearance of novelty; and this prejudice is formed without any one ever taking the trouble to examine whether the novelty, whatever it may be, is decidedly an important one, and calculated to be of essential benefit, or not. This evil spirit, for we can call it by no more appro-

private name, has long prevailed in Scotland to a great extent, and has materially contributed, there can be little doubt, to retard its progress in the march of improvement. Even among our gardeners, this spirit long prevailed. The man who would have dared to change the customary working-tools, and substitute better in their place, or who adopted any new mode of treating plants, or who, in short, proposed the slightest innovation in the established mode of gardening, was, a good many years ago, regarded by his brethren as a person who invaded the sacred realms of antiquity, and brought forward his own idle and absurd fancies in place of those fixed opinions which had been sanctioned by, and derived a sort of reverence from, the usage and custom of their fathers. Thus our gardeners were decidedly hostile to every species of improvement. The contemplation of such a picture of decided and bigoted prejudice, as was, some thirty years ago, in existence, presents a degraded view of human nature; and it has been owing principally to three causes that this spirit has been suppressed. First of all, we may attribute its suppression to the labours and exertions of the higher classes, who, being fully able to appreciate the value of every new discovery, and having their minds unbiassed by any such prejudices as their servants entertained, willingly gave a fair trial to every thing which promised success; and, if useful, they adopted it; if not, it was rejected. But a somewhat severe task awaited the master in overcoming the prejudiced opinions of his gardener, and substituting in their place correct views and accurate judgments. This, sometimes, was difficult; and not few were those who, refusing to work on any but the old system, threw up their situations at once. The press, too, had a great effect in influencing men's minds, by giving room to free and impartial discussion, and by bringing forward the views of those whom all recognised as well calculated to examine and to judge. The example of those gardeners, also, whose minds were superior to any absurd prejudices like those of their brethren, had a great effect in influencing the rest. We now see the Scottish gardeners acknowledged by all to be possessed of a good deal of practical knowledge of their profession. This is their character in general; but some of them deserve a higher character, and to this practical knowledge unite a theoretical acquaintance with many of its more difficult and abstruse branches. Our gardeners are men of sober, industrious, honourable, and steady habits, having a taste for reading, which, in the evening, when their work is over, they frequently indulge in. Being removed, too, in a great measure, from all companionship, by the circumstance of residing on their master's property, this

relish for reading and study naturally gains ground; and, hence, of almost all the humbler classes of men, we find our gardeners by far the best informed, not only with regard to their own profession, but on various subjects totally disconnected with it. Indeed, I have often been surprised at the vast store of general knowledge which many gardeners possess. I myself had one, whose talent and observation were so great, that he used occasionally to compose articles for professional magazines, some of which, I had the pleasure to see, were inserted. Such a gardener is an invaluable treasure. You may rely on it, his work will never be neglected. It is the ignorant and unlettered, in general, who are obstinate and idle.

“ ’Tis education forms the common mind,  
Just as the twig is bent the tree's inclined.”

This excellent though trite observation is here, however, very applicable, and its spirit ought to be particularly attended to. From the peculiar advantages which gardeners enjoy, and the good wages which the efficient and valuable among them always receive, they possess the means, if not of purchasing books, at least of reading them at a very trifling expense. But it not unfrequently happens that books of amusement are more eagerly sought for, and read with greater relish, than works of usefulness and professional interest. This is, no doubt, to be deplored, and there is no cure for the evil. Some gardeners are of opinion that professional reading is unnecessary, and that much more is to be learned by actual practice than by theory. Upon such men as these, remonstrances and argument will prove very likely unavailing. But I am of opinion that every master who is himself a botanist, should direct, in some measure, the education of his gardener, by lending him books (which, indeed, may be done by every master), by directing his attention to particular circumstances connected with particular plants, and by a thousand other modes; and there can be no objection started that this inflicts a severe task on the master, and that his instructions will not, likely, be attended to by his servant. The observations made are not to be delivered in the dry uninteresting manner of a teacher to his pupil. Remarks made, casually and sparingly, will, if they be of any value, not fail to be remembered. I anticipate, from the increasing relish manifested by persons of every age and station, and of each sex, for the long neglected study of the vegetable kingdom, that we shall no longer meet with gardeners who have no zeal for their profession, going through its duties idly and listlessly, nor with masters who are ignorant of the names and qualities of the plants, trees, &c., in their possession. I do

not know exactly what is the case in your quarter; but in Edinburgh the study of botany is prosecuted by all. Old as I am myself, and long accustomed and habituated to another profession and other thoughts, I have begun, some time since, to this delightful study, and have prosecuted it with the greatest ardour; and this is not the ardour of youth, quick, fiery, and evanescent, which can be called away in a moment, to be fixed on some more attractive objects. With the excellent *Compendium* of Sir J. Smith in my pocket, and my tin boxes slung across my shoulders, many are the rambles I have taken to Pentland Hills, Roslin, and along the shores of our beautiful Firth; and great is the good I have derived from doing so, not only in the advancement of my botanical studies, but also in strengthening and invigorating my body, and enlivening my mind. The next time you visit Scotland, Mr. Editor, and happen to be in Edinburgh, you must see my *Hórtus Síccus*, which, I flatter myself, is worth looking at: and here I may be allowed to observe, that although it is not so much the province of the gardener as of the botanist to gather a *Hórtus Síccus*; yet, in my humble opinion, no gardener should be ignorant either of the proper time and season for collecting specimens, what parts of plants should, in preference to others, be selected, or of the manner of drying and preserving the specimens when collected. The desire which every one who pretends to even the slightest botanical knowledge, now feels to collect a herbarium, points out the necessity of this additional knowledge being acquired by all gardeners; and, as the labour and study are not great, nor of long continuance, less excuse can be pleaded for ignorance.

You will, perhaps, allow me, Mr. Editor, in the next Number of your valuable Magazine, to give a very few hints on this, in my opinion, interesting subject.

I am Sir, &c.

W. D.

ART. V. *Remarks on the Conduct of some Master-Gardeners to their Journey-men.* By R. S. E.

Sir,

I AM a constant reader of your Magazine, receiving from it both amusement and instruction. Among the many subjects which it embraces, the relative situations and deportment of masters and journey-men gardeners to each other are occasionally introduced. While I regard with the utmost respect the kind and attentive behaviour of many (I hope a great majority of)

masters to the young men under them, I am sorry, at the same time, to have cause to complain of and deplore the selfish feelings which seem to actuate others.

Some gardens which are celebrated for their extent, superiority of management, or for the ability or character of the superintendent, are those into which young men are anxious to gain admittance; but before they can obtain this advantage, they must submit to bribe the master by a *douceur* of a sum beyond their ability to pay, or to be able to furnish must suffer the most rigid self-denial and inconvenience. When such bonus is presented by the pupil or his friends, for favours and instructions received, it comes gracefully from the one party, and may be gracefully and fairly accepted by the other; because it is an offering of gratitude from the first, and is a tribute clearly due to the latter; but when we see certain men, whom fortunate circumstances have placed in such situations, sternly exacting this oppressive tax, as the absolute passport to their favour, I cannot help thinking that it is as degrading to themselves as it is oppressive to their journeymen.

In some cases, indeed, such a claim is perfectly fair: a labourer from the fields or pleasure-ground, and who has served no apprenticeship, is ambitious of becoming a gardener, and afterwards offering himself to the world as a pupil of the celebrated Mr. A——, from the gardens of the Duke of ——, or the Earl of ——; in this case, the rustic should certainly pay the master who teaches him a business: but the young man, who has served a regular apprenticeship, paid his fee, &c., while in pursuit of a further knowledge of his business, should not, I think, become the prey of rapacity, or have the doors of science shut against him, merely because he has not five guineas to fee the porter.

Master-gardeners should really consider this. If eminent in their business, they surely can demand adequate compensation from their employers, without leaning oppressively on their young assistants, and depriving them of the means of purchasing books, &c., so necessary for acquiring the principles, while they are learning the practice, of the art.

I am, Sir, yours, &c.

R. S. E.

*Edinburgh, May 19. 1828.*

ART. VI. *On some recent Improvements in the Methods of heating Hot-houses and Hot-beds by Hot Water.* By R. W. BYERS, Esq.

Sir,

THINKING that the following experiments may be interesting to the adopters of the admirable hot-water system, I beg to communicate them, with a few details of their application. For the last twelve months I have had nearly daily experience in my own small houses of the effect of hot water, in preserving heat and stimulating my plants; even, perhaps, more than I required: and had I not taken great care, I believe many of my *Amaryllidææ* would have suffered from the great heat given to the sand immediately above my delivering 4 in. pipe; but, examining the pots several times a day, I could raise them until the damper had taken effect, and reduced the water in the pipes to about  $90^{\circ}$  or  $100^{\circ}$ . (This I consider the maximum of heat where you apply bottom heat through a medium of damp sand.) As you may suppose, this plan of raising the pots occupied much time and labour; to obviate it, I resolved to try whether lateral branches might not be applied to the main delivering pipe; thus constituting it the boiler to the branch. Accordingly, I had an apparatus made of tin, 10 ft. long, with 4-inch pipes, not round, but oblate; from the delivering pipe of which proceeded laterals, of 1 in. diameter, and 10 ft. 6 in. long. (*fig. 4. a a*) This was tried, and fully answered,

and the branches became heated with the same rapidity as the main delivering pipe. Again, I had pipes, only three-eighths of an inch in dia-

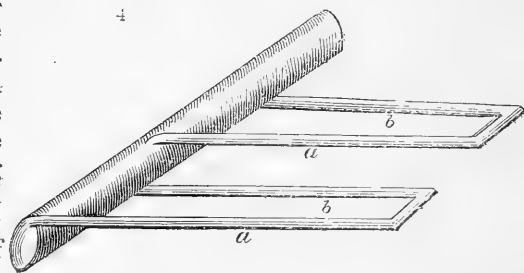

meter, attached to the main delivering pipe, purposely to see if the effect would be the same: the result was equally satisfactory. Again, I had a tray made (*fig. 5.*), 2 in. deep, 16 in.

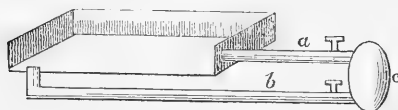

long, and 12 in. wide; at one end of which, at the side, a 1-inch pipe (*a*) was introduced; and at the opposite extremity, at the bottom, another 1-inch pipe (*b*) was soldered: this proceeded to, and entered the lower part of, the delivering main, like as

in the first experiment. (*fig. 4.*) When the apparatus was charged with water, and heat applied, I found the cold water in the tray gradually become warm on the surface; and as the large pipe became hotter, the water in the tray increased in heat, until the bottom became too hot to keep the hand there. Being desirous of knowing how long a time the particles of water occupied in coming from the bottom of the boiler to the tray, and the rapidity with which it moved in the apparatus, I threw into the boiler half an ounce of archil, which, from its gravity, descended to the bottom of the boiler, and in *half* a minute it had risen and passed through a space of 5 or 6 ft., and entered the tray. By colouring the water, I had an opportunity of remarking the action of the water as it proceeded from the boiler to the tray. It entered at the upper pipe, went direct to the opposite side, and, instead of descending through the returning pipe, the colour turned to the right and left, and came back again; and so continued moving backwards and forwards, until the all uncoloured water was expelled, when it began to follow the course of the pure water; affording a beautiful example of the difference in density between hot and cold water. In these experiments the water was heated to about  $130^{\circ}$ ; and the difference in the boiler and tray, where the hot water entered, was  $1^{\circ}$ ; but, at the end of the tray (in consequence of evaporation), it was about  $6^{\circ}$ . The heat can be cut off from the tray by corking slightly the lateral delivering pipe, as well as the returning pipe; or by stop-cocks, as in the sketch: so that by this means you can not only steam your house or frame, but increase its heat several degrees at will. I proved this by closing both lights of my frame, and opening the pipes of the tray: in ten minutes the heat had increased  $10^{\circ}$  throughout the bed. By introducing into the main delivering pipe a circular valve (working through a small tube as high as the top of the boiler, with a handle on the outside, to open or shut it), you would be enabled to turn the hot water on, or prevent it increasing the heat of the house or frame. Even were the water to boil in the boiler, by this valve it would be prevented from overheating the pipes; indeed, I should think you might regulate it to the exact heat required. (A stopcock would answer best, but they are expensive when large.)

As I think this may prove a most important application of hot water, I will not apologise for being minute. Having detailed these simple experiments, I will now attempt to describe the method I adopted in applying them. I did not require pipes so small as three-eighths of an inch in diameter, therefore I used my smallest 1-inch pipes, and my mains were



4 in., but pressed or flattened until they became oblate, and for this reason, that there might be sufficient fall or slope for the small returning pipe. I erected the apparatus in a two-light frame (*fig 6.*), at the end of which I built a very small

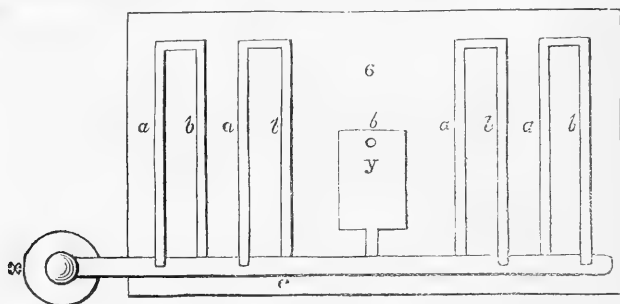

furnace, and inserted my boiler (*fig. 7.*), passing the main pipes along the *lower* end of the frame; from these proceeded the branches or laterals, amounting in all to near 40 ft., and about 10 ft. or rather more of main pipe; these were properly levelled on old tan and sawdust\*, and filled with water. In a short time the heated particles gradually proceeded through mains and laterals, and into the tray. I closed the sashes, and in a short time the bed was in a close heat of 72°. Having placed a few plants in it, I soon found they were covered with a soft dew, and having made up my fire for the night, in the morning I was delighted to find the bed had only lost 1°, it being 71°. My next object was to find the bottom heat, and by inserting a thermometer into several parts of the bed, I found it from about 86° to 90°. These results seem to offer several advantages; indeed, I may say, you may almost command every thing but light, through the agency of hot water. Should you require a dry heat, by hav-

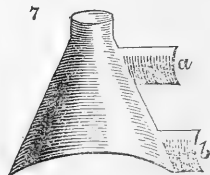

\* What I purpose using in my beds, is coarse sand; the other materials engender worms, fungi, &c. &c.

The method for damping the sand on which the pots stand (as they would be arranged in regular rows), would be, a pipe the length of the bed, or half the length, perforated with small holes on each side, and at the bottom about half an inch in diameter, with a piece 6 or 8 in. long, attached at right angles, with a funnel mouth, 5 or 4 in. in diameter. (*fig. 8.*) This perforated tube can be slipped between the pots, and the water poured in at the funnel, and when one side of the bed is watered to go round to the other, of course, introducing the pipe between each row. I think half the length better than the whole, as it would be more convenient.



ing stopcocks to the tray, no *steam* will arise; or, by having a cover to it, this can be effected. Should you require it for cucumbers, &c., you can have as much moist heat as you desire. Should the weather change to either more heat or cold, by allowing or not allowing the water its free course, you can command it. The roots of your pines cannot be burnt, and by properly managing the apparatus, your bottom heat may be what you please; and indeed by having stopcocks at each branch, you may cut off the bottom heat altogether, and yet have sufficient warmth from the mains at the bottom of the bed. My boiler would, I am convinced, heat six such beds, of course having mains and laterals sufficient for each bed, so little fire being necessary, and requiring but little attention, when once the water is hot. I closed the frame the other night at about 12 o'clock, at  $73^{\circ}$ , I also shut the furnace damper; at 9 in the morning the heat in the frame was  $72^{\circ}$ , the fire was then out, and at 12 o'clock noon I tried the water in the boiler, and found it to be  $118^{\circ}$ , quite sufficient for every thing, although neglected for twelve hours. My purpose is to continue my experiments, and try a few pines, as I really think I shall be able to do more and much sooner by these means than the usual methods of tan and smoke flues. I shall be happy to receive hints from any of your valuable correspondents on the subject, and should a more perfect explanation be required by any brother amateur, it will afford me much pleasure in assisting him.

I am, Sir, &c.

Swansea, Oct. 6. 1828.

ROBERT W. BYERS.

#### DESCRIPTION OF CUTS.

Fig. 4. Perspective sketch of delivering main pipe, with laterals; *a a*, delivering pipes; *b b*, returning pipes.

Fig. 5. Section of tray, with laterals proceeding from delivering main, *c*.

Fig. 6. Plan of frame with boiler, *x*; delivering main, *c*; tray, *y*; and laterals, *a a a a* and *b b b b*.

Fig. 7. Boiler, 13 in. in diameter at the bottom, 4 in. at the top, and 13 in. deep; *a* delivering pipe; *b* returning pipe.

---

#### ART. VII. *On a Winter Garden.* By T. R. RIVÈRE, Esq.

SPRING, the most delightful season of the year, wants no panegyric; it is felt, acknowledged, and enjoyed by all: even the heaths, moors, and forests present us with various tints and hues: indeed, the whole country blooms, and is a kind of garden, and affords more various beauties than are to be found even in a garden at another season. But art can do what nature, uncultivated, forbids; for in the most uncomfortable

parts of the year, we have gleams of sunshine and fair weather, and often, in November, January, &c., there are days as fine and agreeable as any in the summer months, which may be enjoyed by every lover of a country life when walking in a winter garden. Such a one I will endeavour to describe, or rather give you a description of such a one as I have formed at my cottage in the country. The cottage is situate about the middle of the garden, which consists of one acre: it is a parallelogram, or long square, being exactly as long again as it is broad, sloping gently to the east. One fourth of this spot I have endeavoured to convert into a winter garden. On the north side is a brick wall; on the south, plantations of evergreens; at the top, facing the east, the house stands; at bottom, facing the west, is a summer house. The wall is well clothed with bearing peaches and nectarines. About 18 inches from the wall, I have planted chrysanthemums, 4 ft. asunder, which, during the summer months, are tied up to strong sticks. About the 10th of October, when the fruit has been all gathered, I untie them from the sticks, expand, and tie them to the fruit trees, generally so that they completely cover the wall, at least from 2 ft. from the ground to the top, 8 ft. I find not the least impediment to the ripening of the fruit by the chrysanthemums, as sufficient sun and air come between them for that purpose; and they being 18 in. from the wall, there is plenty of room to manage the trees. As they decay, I cut them off, for nothing is more unsightly than decayed flowers or stalks in a well regulated flower-garden. On the south side, the back row is a perfect yew hedge; the border from which, 8 ft. wide, consists of boxes, Portugal laurels, arbor vitæ, yellow-berried privets, Chinese privets, *Arbutus*, *Symphòria* or snowberry; variegated and green hollies, of all the varieties, perhaps twenty; *laurustinus*, Alexander laurels, butcher's broom, *Aucuba japonica*, *Phillýrea*, bays, and others; all disposed according to their different heights: which border extends, in a semicircular turn, to the summer-house; on the other side of which, up to the wall, is a corresponding semicircular border, planted with the same mixture of evergreens. Likewise, at top, on each side of the house, there are similar borders; so that the area, or open space, is a long oval; dispersed over which there are a number of circular and oval clumps, of different sizes. In the middle of each is an evergreen, from 4 to 5 ft. high, of the more choice kinds, such as Scarlet *Arbutus*, *Magnòlia grandiflòra*, *Méspilus japonicus*, two or three fine hollies, &c.; and each clump has a proper number of chrysanthemums, of the hardier kinds, such as the crimson quilled, white, French white,

changeable pale buff, Spanish brown, buff, rose, bright yellow, &c., each separate sort on a clump; and I believe I am not the only one who admires flowers in masses. On each side of the summer-house there are edgings of the *Helléborus niger* or Christmas rose. Now, I must extend this description as long as nature continues to assume the aspect of winter, say till about Lady-day, for no deciduous trees or shrubs burst their buds till after that period.

Edgings of early spring flowers are round each clump, such as *Erānthus hyemālis* or winter aconite; hepaticas, white, blue, and red; snowdrops, Persian Iris, primroses, violets, &c., and a most extensive variety of crocus of all hues, more than twenty sorts; some of which are in bloom from the beginning of February till the end of March. Likewise, the front edge of the border, by the wall, consists of crocus; the edge of the evergreen border of *Amarýllis lùtea*, which, being in the shade, bloom late, and are in full flower from the beginning of November till Christmas.

I cannot describe the animating delight and satisfaction which I feel when, in a sunny day, I throw up my dining-room window, or am seated in the summer-house opposite, at any time from November till April (I certainly except frost and snow, for, as Virgil says, —

“Ante focus, si frigus erit, si messis, in umbra”); \*

I say my sensations are exquisite, when looking down on such a beautiful assemblage of delightful colours, brought together by the art of the horticulturist. In November the wall and clumps display all the various hues of that delightful autumnal flower, the chrysanthemum. Among the evergreens, the scarlet blossoms and fruit of the arbutus, the pure white of the snowberry, the yellow berries of the privet, the yellow and scarlet berries of the hollies, the blossoms of the laurustinus, the fiery berries of the *Pyracánthus*, are most conspicuous, not to mention the charming variety of colours displayed in the leaves of each kind. In December, to the end of the year, the later kinds of chrysanthemums are in bloom; indeed, they may be called the flower which links the autumnal and spring flowers, with perhaps the exception of one link, which January knocks out. That certainly is the only month in which the borders are devoid of flowers; for no sooner does February commence, than, as Milton finely describes, —

—— “When from mountain tops the dusky clouds  
Ascending, while the north wind sleeps, o’erspread  
Heaven’s cheerful face, the low’ring element

---

\* “Before the fire, if winter, if summer, in the shade.”

Scowls o'er the darken'd landskip snow, or shower,  
 If chance the radiant sun, with farewell sweet,  
 Extend his evening beam, the fields revive,  
 The birds their notes renew, and bleating herds  
 Attest their joy, that hill and valley rings."

Flora begins to delight the eye with the colours displayed in the winter aconite, Christmas rose, snowdrop, some early blooming crocus; and every succeeding fine day produces more beauties to the end of the month; and further, to the end of March, the winter garden is one glow of the most enchanting brilliancy. So ends my feeble description of a winter garden.

Every thing is more enjoyed and appreciated by contrarieties: for when I walk through the fields in November, the leaves fall, or are fallen; the gravel walks in my winter garden are as clean as a carpet, there being no deciduous trees to strew the ground with their falling leaves. In every succeeding month, till April, the trees and hedges are leafless, and no flowers to be seen: enter the winter garden, you are struck with something like a fairy scene; and the most unconcerned observer cannot help admiring the beauties of nature; so various, so charming, brought together into so small a spot by the art of the floriculturist.

Often, in October and November, there are sharp frosts for a night or two. I protect the chrysanthemums on the wall by hanging mats on iron hooks, about 4 in. from the wall. The same expedient I likewise use to protect the peaches, &c., when in bloom. Those in the borders I protect by hanging, on the top of each stick to which they are tied, conical paste-board caps. With this small trouble of protection, I insure a fine bloom; when those in the gardens of my neighbours, for want of such attention, are generally defaced by the frosts.

T. R. RIVÈRE.

*Hampden Cottage, Sawbridgeworth,  
 Hertfordshire, Jan. 2. 1829.*

---

ART. VIII. *On the laying out and planting of Burying-Grounds.*  
 By JOHN H. MOGGRIDGE, Esq.

Sir,

I WAS much pleased with the introduction of the subject of burying-grounds in the last (December) Number of your highly interesting Magazine, and with the promise of a fuller notice of it on some future occasion. It is a subject which I hope you will resume in your next Number; for I know of no one better qualified to originate the long wanted reform in

churchyards and burying-grounds of every description than yourself, nor of any one better deserving the honour of being the first to improve the taste of our countrymen in this respect. For myself, I freely own, that I am personally and peculiarly interested in the speedy redemption of your pledge, being at this moment in the act of enclosing a burying-ground of about half an acre, which I destine for the use of the inhabitants of my largest village (Blackwood), of the origin and progress of which I have before given you some accounts. The reform of parish churchyards, I fear, will be attended with some difficulty, or at least it may require considerable time and attention to mature such a plan for that purpose, as may not be frustrated by the self-interest of some persons, and the prejudices of others. As the consecration of my village burying-ground will be the mere act of setting it apart for the necessary purposes of a receptacle for the dead, no greater holiness will be conferred upon it in the eyes of the vulgar than the God of universal nature has conferred upon all his works, and therefore there will be no vulgar prejudices to be shocked; and as there will be no interest created in it, apart from its appropriate object, there will be no selfish feeling excited to hostility. A plan for laying out *such* a burying-ground, you, who have thought on the subject, will therefore find no difficulty in submitting to your readers. My intention is to have the whole area trenched, and cropped for one season, and as soon as prepared, to plant, this winter, a narrow belt of trees and shrubs all around it. These, I venture to surmise, will be a part of your directions in all cases; it is of the nature of plants to be employed, and the arrangement of the interior, and its appropriation to the dead and the living, and its after management, that I wish to see a particular account from your pen. I say appropriation to the *living* as well as to the *dead*, because until the whole of the ground be required for the latter, some disposition must be made, and care taken of what is not actually appropriated for burying in; and will you consider how far, and under what regulations the living should be either required or permitted to keep neat or ornament the graves of their relatives and friends? Such of your readers as have felt an interest in the statements I have sent you respecting my village system, or who are concerned for the improvement of the moral and personal condition of the labouring classes of society, will be pleased to hear that the system I have adopted continues to "work well." The three villages on my property in this neighbourhood now contain two thousand inhabitants, a considerable proportion of the male part of which have freehold leases. Since my last letter addressed

to you on this subject, the school-room in Blackwood village has been fitted up as a chapel also, in which divine service is performed twice every Sunday to respectable congregations; and in order to offend the prejudices of none, and to include within its benefits as many as possible, this service is meant to be practical rather than theoretical; but where doctrinal points are necessarily touched upon, the express words of Scripture are preferably used. A Sunday school has been lately established in the same village, and a society for free enquiry, which promises to flourish, has held its weekly meetings by permission in the school-room, and they are meant to be continued every Wednesday evening.

I am, Sir, yours truly, JOHN H. MOGGRIDGE.  
*Woodfield, Monmouthshire, Dec. 12. 1828.*

WE shall have great pleasure in complying with the request of our much valued correspondent in a future Number; at present (Jan. 19.), having staid rather long in Paris, we have hardly time to prepare the present for the press. — *Cond.*

---

ART. IX. *Plan of the Kitchen-Garden at Annat.*  
 By Mr. ARCHIBALD GORRIE, C.M.H.S.

Sir,

I BELIEVE with your correspondent, Mr. Wilson (Vol. IV. p. 353.), that it is both possible and desirable to make “a kitchen-garden as agreeable and as interesting a scene as any other part of a country residence.” Utility is very closely connected with our ideas of beauty, and I know of no spot of ground within the landlord’s demesnes, of equal value with the kitchen and fruit garden.

Irregular figures, which resemble the freaks of nature, cannot indeed with propriety be admitted within a walled garden. To facilitate the operation of straight row planting, it is in some degree necessary to have the plots rectilinear, at least on two sides. An opinion too prevails, that walls which form any segment of a circle promote injurious reverberation of winds, and hence, in a majority of instances, straight-lined walls are adopted; and this regularity in the building must be accompanied by a similar style in the ground plots. Where “every alley must have its brother,” the variety which pleases in viewing natural objects is absent.

After long experience, I cannot subscribe to an opinion which I believe to be pretty general, that curvilinear walls are

more injurious, or less protecting to tender fruit trees, than such as run in straight lines. On circular walls I have always found the fruit and wood as early, and as well ripened, as the same variety on the same aspect on straight-lined walls. Where such walls form a parallelogram, I have always observed that at and near the corners the wood was small, drawn, and unhealthy; the blossom scanty, and the fruit few, puny, and insipid. Through the kind indulgence of one of the very best of masters (the late Lieut. General R. Stuart, of Rait), I was allowed, twenty years ago, to lay out Annat garden agreeably to my own fancy, a plan of which I shall subjoin (*fig. 9.*).

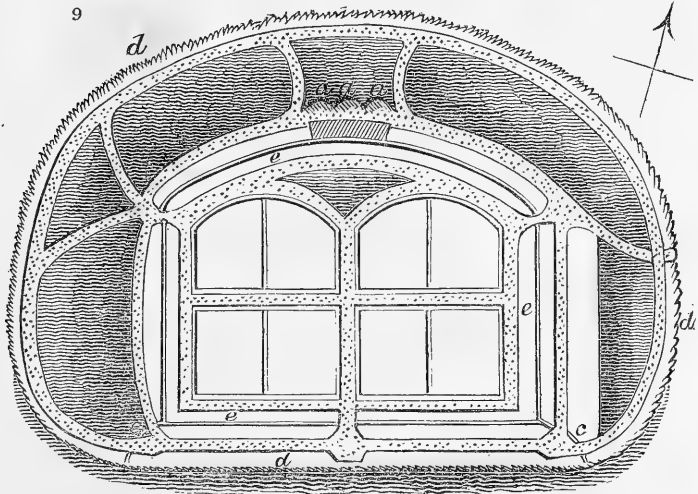

The curve in the north wall admitted of similar curves in the adjacent lines; the south outside and inside walks and borders are level across, rising very gently from the middle to the east and west walls. From the inside of the interior border the ground rises towards the north wall a foot in twelve. The wall-borders and walks on the outsides of the west, north, and east walls are also level across; the banks which form the slip on these sides, rise with a regular slope from the low walks, which bound the wall-borders to the height of 14 ft., the upper walk is thus on a level with the top of the garden wall. As the garden is situate on a sloping bank about 130 ft. higher than the adjacent low Carse of Gowrie, the upper walk on the top of these banks forms a delightful promenade; and to render it interesting to the lover of botany, a collection of herbageous plants, arranged after the sexual system, commences at the south side of the east outer gate, and is continued in the



border next the hedge, all round, and terminates at the north side of the same gate. The south outside border forms a terrace, and is enclosed by a holly hedge on the top of a sunk fence. The rest of the slip is bounded by a hedge of thorn and holly alternately, enclosing in all an area of  $2\frac{1}{2}$  Scotch acres, in which space the length of walks is 1230 yards, leading to considerable variety of ground and objects, without the appearance of being crowded. A few fruit trees are planted irregularly in the banks, and the ground is occupied as a nursery. *a a a* are three semicircular sloping walls, recently made, to give Mr. Henderson of Brechin's mode a fair trial; *c c* are beech hedges, 14 ft. high, to correspond with the height of the wall, separating the south outside walk and borders from the rest of the slip, which gives that place an air of retirement; *e e e*, the brick walls; *d d*, the hedge round the slip. My time does not at present allow me to give a transverse section, but I trust the inclination of the ground will be easily understood from the description.

If you insert this in your valuable Magazine, it may induce others of my brethren to communicate plans of such gardens as they may have laid out, and thus by *criticising* our works, you may promote the embellishment of the kitchen-garden, as well as confer a favour on, Sir, yours most respectfully,  
*Annat Garden, near Errol, Perthshire,* ARCHD. GORRIE.  
 January 6. 1829.

---

ART. X. *On Landscape-Gardening, as a Part of the Study and Business of Practical Gardeners.* By a LANDSCAPE-GARDENER.

(Continued from Vol. IV. p. 476.)

**OF BUILDINGS.**—Although buildings are not the immediate concern of the landscape-gardener, yet as they have a relative and imposing effect on his dispositions, and very often govern many of his operations, it is necessary he should understand as much of architecture, as will enable him to judge how far the style, magnitude, and situation of a mansion is in consonance with the character of the grounds. Without such knowledge he will be unable to adapt new features with propriety, or correct incongruous features which exist, so as to produce a harmonious whole.

If a picturesque building stands on a district of the same character the improver's task is easy; or, if a beautiful Grecian house be surrounded by beautifully disposed grounds, his business is equally so. The magnitude of the building in

either case directs the magnitude and style of the accompaniments.

If such congruous circumstances be reversed, much address will be required to make a consistent whole. To change beautiful ground or scenery into that of a picturesque character, though perfectly practicable, would incur heavy expense, and occasion many ridiculous exploits; and to reduce picturesque scenery to that of beauty, would require such a system of leveling and smoothing operation as would offend every eye of real taste.

If it be necessary that the gardener should know enough of architecture to be able to accommodate his features to the character and magnitude of a mansion, it is no less necessary that the architect should be conversant with the principles of landscape, in order that no such incongruities of architecture and natural scenery above alluded to should ever occur. Indeed a question has arisen, whether the architect or landscape-gardener should be *first* employed in the formation or improvement of a country seat; that is, whether the site of a new house should be fixed by the former or the latter. On the one hand it is admitted, that, as the architect must be accountable for all the comforts, the stability, and the external appearance of the dwelling, he should certainly have his choice of the spot where it could best stand. This granted, the gardener would only have to dovetail his accompaniments of wood, water, &c. to complete the place. But, says the gardener, the natural features and character of the country, the uncontrollable "genius of the place" should govern the architect as well as himself. The natural character is fixed; and there is almost always a central point which commands the greater share of the surrounding surface, or at least the most interesting parts of the landscape, all circumstances of convenience, aspect, and propriety considered. The principal windows of the house should command the best views; and if this has been neglected by the architect, the gardener's business is rendered difficult, it will be beyond his power to form a consistent whole; his general design, which the character of the place imposes, will be deranged, and, consequently, imperfect.

This shows that the artists should understand something of each other's business, and should always regard each other's opinion.

When, however, this very material point has been neglected by the architect (and which is too often the case), all the gardener can do in such circumstances is to make the immediate accompaniments of the house partake as much as possible of

its character, and improve the distant scenery as will best accord with its natural character.

With respect to ornamental or horticultural buildings, their place is usually fixed by the gardener, and the structure, in course, is arranged by the architect, the style of the house being the basis.

The foregoing observations are preliminary to the practical remarks which follow, and which are intended to show more directly their application. This will be easiest done by choosing well known subjects, where the landscape-gardener's art is always displayed.

*The Royal Palace.* — Royal palaces are generally in the environs of the metropolis. Champain scenery can but rarely be appropriated as an appendage, but whatever portion of ground may belong to the royal residence, it must be disposed in a style which at every step should impress ideas of grandeur and pre-eminence. Had the architect and gardener a choice, they would place the palace on a considerable eminence; its front overlooking the city; its gilded domes surmounting all other objects, and commanding as extensive views as possible of the subject territory.

The architect would place the palace on a raised terrace, faced on the front and flank sides in the same architectural style as the palace itself, surmounted by a balustrade, and all the objects of Italian gardening; in the rear will be placed the various offices, closely surrounded by thick plantations, in which may be shady rides, &c.

The gardener's business here will be to apply the principles of Dutch gardening, by tracing from the three fronts, direct, and very wide glades or approaches to, or openings from the the palace, each terminated by suitable buildings as gates, or pavilions. The sides of these openings should be planted with double or treble ranks of regular-growing trees, as limes, elms, planes, or chestnuts. Two intermediate glades may diverge from the angles of the principal front also regularly planted. The angular spaces contained between those diverging avenues should be filled with dense masses of trees, intersected by right-lined vistas from different parts of one opening to another. No kind of variety, intricacy, or irregularity should be admitted here; nothing should distract the eye, or call the mind from the serene dignity of the scene. The architecture, masses of vegetation, expanses of lawn and water, and walks, should all assimilate in amplitude.

Country residences for royalty have no peculiar distinction from those of the nobility, save only, perhaps, regal emblems on the gates, and among the architectural ornaments of the

buildings. Temporary residences, as pavilions, cottages, &c., may be decorated as fancy may suggest; it is impossible that any rule of art or taste can be applied, in blending the insignia of a palace with the humble structure and homely exterior of a hut.

*The Episcopal Palace.* — Seclusion and solemn quiet are the principal characteristics of a bishop's palace. It is but seldom that such a place is formed anew. If the gardener is called on to improve, he has only to preserve every mark of antiquity, and add such features as will assimilate with its character. The ancient avenue leading to the venerable pile: groves of full-grown trees, in which the spreading cedar, cypress, yew, and towering pines prevail; shady walks leading from the cloistered wings; the well-stocked fish-pond, and the walled garden, are the usual accompaniments of such a residence. Evergreen shrubs should prevail to the embowering privacy of the home walks. Distant views may be admitted, but so as not to expose the palace; and intermediate scenery may be improved, as will best accord with the general character of the domain.

*Abbeys, Priors, &c.* — These old religious establishments are now chiefly lay property. Where they have been changed into private dwellings, the original Saxon or Gothic style of building, in many instances, has been preserved, and consequently imposes a corresponding style of accompaniment. Many fine old places of this description have been sadly denuded by systematic levellers, without taste or reflection; and the old stately mansion thrust out upon a naked lawn, completely stripped of all its former honours.

When the gardener is called on to improve such places, he will do well to preserve some of the old contemporary accompaniments of the house, restore such as are wanting, save all the oldest trees, and endeavour, by a judicious disposition and choice of young ones, to give the whole a bold picturesque character. Tufted-headed trees, as the evergreen and common oak, elm, &c., contrast well with the perpendicular lines and shadows of Gothic architecture; and the mature forms of the cedars and Scotch fir, produce a contrast quite suitable with this style of building. Such buildings also require to be more closely concealed by wood than those of more modern date; for which purpose, the glades through which they are seen should be closer; separate parts of them only shown in detail.

*Castellated Mansions.* — Many of those Norman structures still remain as country seats of noblemen and gentlemen, and many new buildings have been erected in imitation of them.

As the complexion of a castle declares it to be for defence and security, the deceit may be carried a little farther for the sake of consistency, by giving the ground some impressions from the science of fortification. The *scarp*, *fosse*, and *counter-scarp*, may be well and rationally imitated in forming a terrace. The ha-ha may represent a line of *circumvallation* beyond a *glacis* of lawn. *Approaches* may be quite in character. If water be in the composition, a *tête du pont* would be no mean embellishment; and *covered ways* may be introduced with perfect propriety. In short, an uncle Toby designer might ichnographically make out a very clever thing; and altogether as rational, as planting a park in the order of some famous battle.

But as these castellated mansions (designed in the office of the architect, perhaps, without reference to their intended site) are often seen standing in the midst of beautiful grounds, the gardener can hardly determine what to do with them. Nothing that he can do will be at once consistent with such a building and such a place. The character of the building requires the boldest description of picturesque scenery; but this cannot be done upon a surface which is simply beautiful.

But when such buildings stand on a site which justifies their character, where the difficulty of approach and commanding height gives the idea of impregnability, like the aerie of an eagle built on high; crowning the highest peak of a promontory, or the top of an insulated rock in the middle of an extensive vale; where the surrounding country is of a mountainous character, here shooting boldly forward in disjointed cliffs, and there receding back in deep winding dells; such position for a castle is in every respect appropriate. As the dread of hostile attack no longer exists, all the enrichments of planting may be given, even up to the ramparts; on the surrounding heights; on the sloping sides of the dells; on the shelves of the rocks, and in detached groups in the vale, to checker the verdant mead. Water usually abounds in such situations; and whether as a partly surrounding lake, or river, much may be made of it. Bridges, islets, sailing vessels, with all its gay reflections.

Fortunate is the possessor of such a romantic spot; every kind of scenic gratification may be his. Happy the designer who has such a spot to decorate; it allows full scope for the exercise of his powers, the most ample field for the display of his talents. Beauty may be presented playing on the banks of the lake; picturesqueness will appear in the irregular elevations and outlines of the buildings, and from the broken and shaggy fronts of the higher grounds; and even impres-

sions of sublimity may be felt in the contemplation of such a union of the works of nature, heightened by those of art.

*Country Seats.* — The manner in which a great majority of those delightful residences are laid out and improved by the landscape-gardener, has created a style which has acquired the distinction of English gardening. The finely wooded state of the kingdom at the time the present fashion was introduced, enabled the designers to execute this peculiar style with very fine effect. Even entirely new places, taken in from commons within the last fourscore years, have risen into admirable beauty and value. Many of them are perfect types of the chastely beautiful, the interestingly picturesque, and numbers, from their extent and magnitude of design, truly magnificent.

Such places deserve imitation, as they are examples of our national taste; but it is impossible to lay down any thing like rules for the execution. The character of the country, of the place, its buildings, woods, peculiar features, and situation, form the basis, on which whatever the improver may see fit to add or take away must be founded.

*The Ferme ornée.* — To surround a country residence with beautiful scenery, invariably requires a sacrifice of useful land, not always agreeable to proprietors of limited fortune or possessions. To get rid of this difficulty, it has been urged that no marks of useful and necessary cultivation can possibly offend the eye of taste, provided they are not forced into notice; that a walk or ride through fruitful trees, waving corn, and thriving sheep is as interesting, and may be made as inviting, as the devious drive through open groves, exotic shrubs, and dappled deer. An ornamented farm has therefore been admitted as a legitimate expedient of uniting the beauties of landscape with all the advantages of a fertile soil. A farming gentleman may have “a painter’s eye,” and, in disposing his farm, will wish to keep a moderate space before his windows in highly dressed order; next, his meadows and pastures in a park-like state, and his arable fields in the off-scape. These last he will intersect with rides or green drives along his hedge-row elms, or through irregular groups of unlopped trees, that he may visit at pleasure his ploughman’s furrows, his mower’s swathes, or “reaper train.”

Such things have been executed with great success, and chiefly by the highly talented proprietors themselves. Some of the most interesting estates in Britain are laid out in this manner. It has the peculiar charm of uniting the sweet with the useful; and, though such a disposition cannot be allowed with propriety to break in upon the high keeping of a noble-

man's seat, it is by far the most suitable for that of a private country gentleman. No landscape-gardener, however, is equal to the task of doing this properly, who has not an intimate knowledge of the necessary convenience, operations, and practical routine of agriculture.

*The Manor House.*—This building, with its “hall of grey renown,” requires no particular embellishment from the gardener, save what the lord (if he be a resident) or his agent may wish, to distinguish it from the farm-houses around. If it has no old marks of superiority about itself, a few groups of conspicuous trees, planted near it, will sufficiently answer the purpose.

*The Hunting Box.*—This is erected on manors, or portions of the estate at a distance from the principal seat. Intended as an occasional residence, the house itself is small, but with ample additions of stabling, kennels, boiling-houses, &c. The pasture ground is divided into paddocks, diverging from extensive circular sheds or hovels near the stables, for the convenience of turning out and feeding the stud. The fences between the paddocks should be high and thick hedges. Several clumps of shady trees should be planted in each paddock, and supplied with water, either in ponds or troughs.

*The Rural Villa.*—These dwellings appear in the neighbourhood of country villages. Placed near the end of a square meadow, a little dressed ground for shrubs and flowers in front, a garden and meadow behind, surrounded by a planted walk of trees and shrubs, in a belt within the outer fence, completes the place.

*Town Villas* resemble the foregoing, only the house is larger, and the premises are surrounded by walls and iron palisades. The disposition of the interior is more a work of fancy than of taste.

*Ornamental Cottages.*—Much of “this kind of thing” is done in all parts of the country. All the extravagances of fancy and whimsical conceit, are exercised in torturing costly materials into all the accidentally rude members of the poor man's hut. The gaudy colours, and fantastic forms, with which some of these erections are bedizened, seem to be nothing more than the romantic devices of a citizenelle. Muslin or silken curtains, flapping through the lattice-glazed window, plastic figures from the antique, and the most valuable exotic shrubs grace the little lawn; a Grecian or Gothic portico screens the front door, while the rats and sparrows are nestling in the frowning thatch. Rational taste is not wanted, and very seldom consulted in such affairs; still castellated cottages

arise, and not unfrequently do they appear in the semblance of Gothic chapels.

Notwithstanding such freaks of tasteless expenditure, it is, upon the whole, not amiss, as encouraging mechanical trade; and an indication of the improving taste, however defective, of the country. A man "who pleases to want" such things, and is gratified with showy plants, furniture, and a conspicuous house, evinces superior intellect; he is above the sordid feeling of getting all he can, and keeping all he can get; besides, such a fashion dresses the face of the country, and is, unquestionably, a sign of national prosperity.

*Of the Entrance or Approach.* — The tracing out and execution of this material appendage to a country mansion, is an affair which requires particular attention. The outer gate and porter's lodge ought to partake of the architecture of the house, and be, in character and design, proportionable thereto. Its place should be at some inviting point, at a proper distance from, and before coming abreast of, the house, and, if possible, where the public road appears to diverge therefrom. The approach should rather ascend to the house than otherwise. The easiest line for a carriage will also be found the most graceful. No attempt at great display of the mansion and park should be made immediately on entering the latter; a glimpse only of the former may be had; and at which point, as much of the carriage-road as is seen in advance, should appear to trend towards the house. No more of the house should be seen, till almost arrived at the hall-door. No interior gate should be allowed. If, from inequality of ground, the road must be conducted in various directions, much of the line must not be visible at once; and, for every such turning, there must also be a visible reason; the deviation and the cause should always appear together; nothing is more ridiculous than proceeding over a vacant space, without some leading object. A house, trees, bridge, or gate, are objects which can only justify any departure from a direct course. For the sake of easy sweeps, or for gaining some very interesting point in proceeding from the outer gate to the house, obstacles may be placed or planted after such sweeps are made. This is perfectly justifiable, if good reasons can be given for it.

The properties of a well-made carriage-road are, firmness, dryness, smoothness, and durability. To obtain these, much depends on the quality of the material. If gravel, or stone of sufficient hardness can be had, a good and substantially firm road may be made. First dig out the bed of the road, to the depth of fifteen or more inches (if the subsoil be clay, or soft earth), which may be carted or wheeled away, except what



may be wanted to make up the sides in passing through hollows. Fill this bed or trench, two thirds of its depth, with the coarsest of the metal, i. e. stones of from six to three inches in diameter, well compacted together. On this foundation, lay a stratum of screened gravel, or finely broken stone, two inches thick, also well and equally trodden down; and, lastly, cover over with a thin coat of fine sandy gravel or road-sand. The surface should be very nearly level across, leaving it but slightly raised in the middle; and the utmost care must be taken *not to level it* longitudinally, but gradually and almost imperceptibly undulating, so that no surface water may lie, particular care being taken that it be drained off into the turf, at every dip or depression. A road which is longitudinally level, never dries quickly; on which account, it is also less durable. This is the greatest error of public-road makers; M'Adam himself not excepted; because, a road guttered by carriage-wheels prevents water running off transversely.

With respect to the width of a carriage-road, it should be, more or less, according to the size of the place, or to the quality and firmness of the ground over which it passes; for, if this be firm enough to bear a carriage in breaking out of the way of another, it will save the expense of making the road wide enough for two carriages to pass. A uselessly wide road is not only expensive to make at first, but for ever after expensive to keep clean (and, if not kept clean, is ever upbraiding the owner with neglect), and occupies unnecessarily land which would look much better covered with grass. Such considerations would not enter the mind of a landscape-gardener in laying out an approach to a palace, or any thing like a palace; but, for a *Ferme ornée* seven feet wide is quit sufficient. This width will be mostly kept clean by the repair of carriages, and if the road be constructed with materials and in manner above stated, no ruts, or quarters will ever appear on it after being fairly settled, and attended to during its settling.

Such a road should not have elevated edges; the turf should die into the gravel without any very visibly cutting line; and, if any thing, the gravel should be rather lower than the turf, in order that it may not be seen in looking across it from distant parts of the park.

Although the materials of which it is composed will assist to keep the road dry as well as firm, yet it must not be forgotten that such a trench as this, cut into a bed of clay, will be a receptacle for water, as well as for hard materials; but this the designer will be aware of, and provide against, by open or covered drains, while employed in the formation.

The other appendages of a country seat usually arranged by the designer are the gardens, &c. Their extent is always in proportion to the size of the house and family establishment. The domestic offices are generally comprised in a quadrangle behind the mansion; beyond this the kitchen-garden, with its appurtenances of walls, hot-houses, &c. All these are most conveniently concealed and surrounded by shrubbery and walks, bounded by a sunk fence, dividing it from the park. This pleasure-ground is varied with turf, flowers, shrubs, and trees, and arranged with special reference to the principal views of the park, of which it should be considered as only a more dressed part. In this is placed the green-house, conservatory, and flower-garden. Here, also, the most rare and beautiful trees and flowering shrubs are disposed, arranged, and intermixed near the house with architectural and sculptural ornaments, in the Italian manner.

As this portion of the gardens is solely intended for pedestrian exercise and recreation, every thing here should be contributory thereto: general smoothness of walks and turf, the gayest flowers, the sweetest plants, shady bowers with seats, chairs, &c. Here, also, should be placed the arboretum, lapidarium for rock plants, and aquarium for those which thrive only in water. The extent will depend on the character of the place, local circumstances, or the taste of the owner. The whole should form a kind of terrace, from which the scenery of the park or distant country may be seen. To such scenes it becomes the fore-ground, and consequently must be laid out and planted accordingly.

The extreme smoothness of the fore-ground in English gardening is, in the estimation of painters, its greatest blemish. Levelling the surface, and especially under groves and groups of trees, which only present an aggregation of naked stems to the eye, adds to the monotony. This is a point on which there is much difference of opinion. The painter is desirous of having all his nearest objects boldly relieved by a back-ground, and supported or accompanied by under-growths, but is totally indifferent what the back-ground or under-growths may be; but the man who is engaged in creating or improving park scenery, uninfluenced by the painter's ideas, cannot easily divest himself of the endeavour to impress some degree of polish. Inequalities of surface are therefore unconsciously levelled; roughnesses, especially if caused by the presence of uncultivated plants, are designedly cleared away; and, though this may reflect credit on the improver, it would most assuredly be undervalued by the painter.

The reason is this: plants have other peculiarities besides those of contour or colour; some are poisonous, others savage, hostile, noxious. If a painter were also a botanist or gardener, he would probably hesitate to place monstrous docks, hemlock, or odious nettles on his fore-ground; and, if a naturalist, would hardly admit hobgoblin plants which *neither naturalist nor gardener ever saw*.

Here the artists differ: the gardener is compelled to attend to the character of his plants, the painter regards only their form in composition. Were the latter to execute on the ground what he feels necessary, and delights to depict on the canvass, the pleasing marks of cultivation and propriety would be sacrificed to pictorial effect.

This, however, would be hideous in real landscape; and, notwithstanding all that has been said and written in justification of such attempts, we must not suppose that the late Mr. Knight (author of *The Landscape*), or Sir Uvedale Price himself, would advise such absurdity. All those accomplished arbiters of fine taste wished to inculcate is, that, in forming real landscape, the principles of pictorial composition should be studied, and imitated, as far as possible, by the gardener.

In uniting the features of the pleasure-ground with those of the park, therefore, attention must be given to plant the connecting masses of the former, so as to fall in properly with the latter. The marginal plants on this enclosed fore-ground should be of some *strongly marked character*, in order that they may be a good contrast to the softened forms and foliage in the distance. Sometimes the groups within the fence must be continued on the outside by trees or shrubs of self-protecting character; and the nearest groups of trees in the park should have a shrubbery-like appearance given them, by being thickly planted with suitable under-growths.

As the practicability of this process, viz. the disposing trees and shrubs so as to produce the effect so much admired by painters, has been much questioned by writers on the subject, it is necessary that the question should be stated here, with the circumstances bearing upon it, and the means which may be available in the gardener's hands for its accomplishment.

It has already been said that the favourite sylvan scenery of the painter is only met with on uncultivated land, or in forests where neglect or accident have produced those combinations so suitable for his pencil. The peculiar charms of such scenes, however, fly before the wand of the cultivator. Painters and others, notwithstanding, imagined that such scenery might be composed by art. On this supposition, the destruction of the Italian style, and the introduction of English gar-

dening, were sanctioned and founded. This was indeed an advance from extreme stiffness to the freedom of nature. But it was soon found that the banishment of right lines, and throwing the features of a park into irregular forms, did not answer the painter's expectations. The comfort, convenience, and necessary cultivation round the dwellings of man, with the requisite range for cattle for his use, profit, or pleasure, imposed a wide expanse of tameness, as fatiguing to the eye of taste as was the abolished formality.

The fact is, "neglect and accident" cannot be imitated. There is something ridiculous in the very idea! The pencil, by a random movement, can produce irregular intricacy without detection and without reproach; but to see men and horses, with all kinds of pioneering apparatus, employed digging cavities, raising hillocks, breaking lines, mutilating trees, or building ruins, would be not only very foolish, but contemptible. Such freaks, however, have been recommended, and actually in some instances executed; but rational taste has nothing to do in such proceedings, any farther than preserving such features where they happen to exist.

But to return to the question: — Can nothing be done in polished scenery to produce those harmonious associations which we so much admire in the uncultivated woodlands? Yes, much; and perhaps more than has ever yet been fairly tried.

It has already been observed, that our parks are deficient in variety and intricacy, chiefly from the general smoothness of surface which prevails. The groups, or clumps, of trees are meagre and unsightly; too much insulated and unconnected with the turf and with each other. The browsing line is too cutting and apparent. This defect is entirely owing to the want of suitable undergrowths. Every practical planter is aware of the difficulty of protecting trees, and especially shrubs, from the depredations of cattle; it is in fact the principal obstacle to planting undergrowths; and is the immediate cause of the blank and vacant air of our parks.

To get rid of this objection to our most valuable scenery, to add that trait of accompaniment which would give depth and massiveness to our groups and woods, so pleasing to the eye of taste, we have only to select such plants, as, while they produce the desired effect, will also, from their own properties of self-defence, be safe from the effects of cattle. Such plants are plentiful and well known, and only require to be named.

The first is the common holly: it thrives on almost every kind of soil; is hostile to cattle; sufficiently ornamental for

any situation, and accommodates itself to the margin or to the interior of woods; creeping horizontally on the former, or rising to considerable elevation in the latter situation.

The next is the white, or haw, thorn. This well known plant is fit to be exposed anywhere. Planted singly on lawns, they are handsome objects; and when in bloom are particularly admired; though at such time, of all others, the most frightful to the landscape-painter! Such conspicuous white spots on the canvass would destroy the whole tone or keeping of his piece. I mention this by the way, to show that a fine landscape and a fine picture are not always the same thing. For thickening or diversifying open groves, however, the white thorn is invaluable; as they grow tolerably well in the shade of trees. The buckthorn may be used for the same purpose, as well as the blackthorn, and all the sorts of the dogrose. Furze, heath, and common broom are also suitable undergrowths, and form a sweet and beautiful fringe to woodland at a proper distance from the mansion. But no plant forms a better base to groups of trees than the common juniper; it makes a fine back ground to the boles of such as stand detached from the denser mass of the wood, and creeping irregularly out on the lawn in separate patches, forms the finest gradation from the surface of the ground to the lower branches of the overhanging trees.

*(To be continued.)*

---

ART. XI. *On a Method of facilitating the Growth of Thorn Hedges on high and exposed Situations.* By Mr. D. ANDERSON.

Sir,

It has usually been considered difficult to obtain good quick fences upon the high and open parts of the Wolds; but since the mode of planting in strips has been adopted, this difficulty has been greatly overcome.

Sir Henry Wright Wilson had an open farm at Kilham, on the Yorkshire Wolds, which he desired me to divide and enclose. I planted near twenty acres in stripes of 22 yards wide, chiefly with larch, which divided the farm into fields of from thirty to forty acres each. I planted a line of thorns on both sides of the plantation; then put down posts and three rails on the outside. These posts and rails were kept up for nearly ten years, during which time the ground about the

thorns being well and constantly pointed up and cleaned, became a sheep fence, and the trees a thriving shelter of from 14 to 16 ft. high.

But I beg leave to suggest to those who may have similar high and open farms to enclose and shelter, that a quick fence may be obtained much sooner, by running the quick in the middle of the plantation, and leaving a space of two yards on each side of the quick, which will give good room for light, air, cleaning, &c.; putting the posts and rails on the outside of the plantation, as before. Here there is a saving of thorn plants of one half in the first instance, and a saving of one half the expense in cleaning afterwards: and as the young hedge will be sheltered on both sides by the plantation, I suppose a sufficient fence will be obtained in two thirds of the time it will take in any other way, and at the end of eight or nine years, when the posts and rails begin to fail, the thorn fence will be effective, and the timber trees on each side of it in such a state as not to be injured by sheep. Indeed no cattle will eat any of the pine and fir tribe, more especially the larch, and that tree is found to succeed the best of any in these high, dry, and exposed situations.

I am, Sir, &c.

D. ANDERSON.

*Driffeld, Yorkshire, November 15. 1828.*

---

ART. XII. *On the Common Whin (Ulex europæus), as a Hedge Plant.* By T. H.

Sir,

It is the general opinion that the common *whin* is a very troublesome guest, and one which seems only to cumber the ground; but in the course of my wanderings this summer, I have frequently observed them put to a very good use, particularly in the neighbourhood of Mr. Ginge's splendid mansion at the entrance to the Devil's Glen, in Wicklow, where I observed the cultivation of *whins* into hedges, and right excellent fences they make. Perhaps they may require to be planted on embankments, but whether they do so or not, certainly nothing could be more secure and unbroken than those on Mr. Ginge's property. Nor are these uncommon in Ireland. I have observed them in other counties, and better hedges could scarcely be, unless it were holly; and furze grows where holly will not, and in at least one fiftieth part of the time. Add to this, they bloom in the most beautiful

manner possible twice in the year, and the more they are browsed by cattle or sheep, the thicker and more perfect they become.

I hope you will excuse the length of this communication; but the practical virtues of this plant seem to be little known. And what is considered as a plague in the wilds of Wales or of Scotland might, with a little care, be easily converted into an instrument for enclosing the country with secure and durable fences. I am, Sir, yours, &c.

T. H.

Linlithgowshire, August 28. 1828.

ART. XIII. *A brief Description of the Timber Trees abounding in the Province of Chocó.* By W. HAMILTON, Esq. M. D.

1. *CHIBOGA*. — A dark durable wood; grows very large, and forms the finest and largest canoes. Cubic foot, 52 lb. 13 oz. 286 gr.

2. *Geneni*. — One of the most magnificent trees, and most valuable woods of the province. It is used for the largest canoes, and lasts above twenty years. Weight of cubic foot, 48 lb. 10 oz. 499 gr.

3. *Caydita* (*Quercus*). — Used for canoes and portios; not very durable; tree bears a fruit like an acorn. Cubic foot, 29 lb. 10 oz. 420 gr.

4. *Canaleti*. — A very valuable wood used for canoes, paddles, and window frames. Cubic foot, 39 lb. 9 oz. 315 gr.

5. *Encibi*. — Is used for canoes, door and window frames. Cubic foot, 31 lb. 4 oz. 343 gr.

6. *Pretendie*. — Appears a useful wood, but is used by the natives as firewood only; the tree grows by river sides. Cubic foot, 41 lb. 3 oz. 277 gr.

7. *Niaragè*. — A durable wood, used principally for shafts and lances. Weight of cubic foot, 49 lb. 7 oz. 168 gr.

8. *Ceibo* (*Bómbax Ceiba?*) and 9. *Mestizo*. — Soft, useless woods; sometimes small portios are made of it; not durable, and occasionally used as firewood. *Ceibo*, cubic foot, 33 lb. 8 oz.; *Mestizo*, cubic foot, 36 lb. 8 oz. 112 gr.

10. *Guayaba dulce*. — This wood is only used as firewood. Cubic foot, 30 lb. 3 oz. 280 gr.

11. *Carbonera*. — Used for making charcoal, and burning. Weight of the cubic foot, 47 lb. 12 oz. 287 gr.

12. *Capitan*. — An acacia; a fine wood, used for canoes and firewood. Cubic foot, 39 lb. 9 oz. 315 gr.

13. *Guama chorima*. — A wild Guama, esteemed one of the best firewoods. Cubic foot, 28 lb. 7 oz. 105 gr.

14. *Manteca blanca*. — Used as firewood principally. Cubic foot, 52 lb. 2 oz. 287 gr.

15. *Ormiga*. — Used as firewood principally.

16. *Neenecuca*. — The heart of this wood is in great esteem for sticks, some of which are valued at from eight to sixteen dollars; it is beautifully marked. Specimen wanting.

17. *Anime*. — Used chiefly as firewood. Not the wood of the *Hymenæa Courbaril*. Cubic foot, 36 lb. 12 oz. 126 gr.

18. *Flor Azul*. — Cubic foot, 28 lb. 1 oz. 438 gr.

19. *Yaruma*. — Soft, useless wood; when perfectly dry readily takes fire. *Cecròpia peltata*, as I am inclined to imagine. Cubic foot, 29 lb. 4 oz. 210 gr.

20. *Nuanimo*. — Soft wood, used only as firewood. Cubic foot, 41 lb. 6 oz. 147 gr.

21. *Tarabi*. — A species of *Canalèti*, used for the same purposes. Cubic foot, 31 lb. 12 oz. 378 gr.

22. *Algaro*. — A hard, reddish wood, appears calculated for general purposes, but I am not aware of its particular use, nor have I seen the tree. Weight of cubic foot, 48 lb. 2 oz. 140 gr.

23. *Guayacan Guegara*. — The finest species of the wood generally termed Guayacan; is used for walking sticks and posts for houses. It is hard and difficult to work, but is one of the most valuable woods of the province of Chocó. Weight the cubic foot, 70 lb. 2 oz. 322 gr.

24. *Guayacan negro*. — This is inferior to the former, both in hardness and beauty, but is very durable, and generally used for building houses. Weight of the cubic foot, 51 lb. 2 oz. 29 gr.

25. *Mora*. — A fine yellow wood, called occasionally Guayacan amarilla; it is an inferior species of *Fustic* (*Brousso-netia*?).

26. *Cabo de Hacha*. — A fine-grained hard wood, vying in toughness with the European ash; it is used, as the name imports, to form axe-handles, lance-heads, and articles which require toughness and strength. Cubic foot, 53 lb. 5 oz. 221 gr.

27. *Guayaba del monte*. — A fine wood, but not generally used by the natives.

28. *Fruito Sabalo*. — A hard wood, used for making plates, and burning; it is not very common; it grows on the banks of the river. Cubic foot, 34 lb. 13 oz. 144 gr.

29. *Pantàno*. — Cubic foot, 38 lb. 8 oz. 245 gr.

30. *Carey*. — A very large tree; the wood is hard, and used for burning; from the spurs of this tree, which are thin



and broad, the natives make the doors of their houses. Cubic foot, 38 lb. 0 oz. 217 gr.

31. *Tan careña*. — Cubic foot, 42 lb. 6 oz. 287 gr.

32. *Mata Palo*. — So called from destroying the trees near it; the wood is hard, but principally used in burning. Specimen wanting.

33. *Manteca Colorado*. — Cubic foot, 57 lb. 3 oz. 186 gr.

34. *Tuabi*. — A coarse-grained yellow wood, used for canoes. Cubic foot, 34 lb. 13 oz. 144 gr.

35. *Chagual*. — Specimen missing.

36. *Druny*. — A hard wood; I do not know its uses.

Weight of the cubic foot, 71 lb. 0 oz. 91 gr.

37. *Cedar*. — Too well known to require description; there are three species which are rather named after the bark than the colour of the wood; the black is most esteemed. *Quere*, *Cedrèla odoràta*? Certainly not a *Bignònia*. Several *Bignonias* are called Cedars, as the *B. pentaphýlla* and *B. leucóxylon*, the timber of which is white, and grain different. The colour of my specimen is red; the grain is similar to that of the Garlic Cedar (*Cedrèla odoràta*), but by no means equally close or fine. Cubic foot, 24 lb. 6 oz. 175 gr.

38. *Coosaña*. — A hard, durable, and beautiful wood, used in making walking-sticks, &c. Specimen wanting.

39. *Palo sangre*. — So called from its astringent qualities in suffusions of blood; it is a durable and beautifully stained wood; it is also called, from its blossom, *Clavelina* (*Brównea coccínea*); it resembles rosewood, and would, doubtless, answer for the same purposes. Cubic foot, 60 lb. 14 oz. 333 gr.

40. *Granadilla*. — A fine wood; the heart is dark and very durable. Specimen wanting.

41. *Curabano*. — Said to be a species of *Guayacan*; it appears a good wood. Weight of the cubic foot, 50 lb. 7 oz. 321 gr.

42. *Roble*. — A light wood, but not generally used. Cubic foot, 27 lb. 12 oz. 112 gr.

43. *Guayacan colorado*. — A hard durable wood, next in hardness to the *Guayacan Guegaro*, and used for the same purposes. Weight of the cubic foot, 70 lb. 10 oz. 294 gr.

44. *A variety of Canalèti*. — Used for the same purposes. Cubic foot, 28 lb. 9 oz. 312 gr.

Besides these, there are many others very valuable, among which are —

45. *Bedoquerà*, or *Balsamo*. — The wood and bark highly scented, and used by the Indians for ornaments for the neck; it yields a pungent aromatic resin. Specimen wanting.

46. *Choobar*. — This is a very magnificent tree, bearing a profusion of purple blossoms; the wood is very hard, and consequently useless to the natives; it is also called *Quebra Hacha*.

47. *Orejuela*. — A species of *Acacia*, called, in Panama, *Curato*; it is a very durable wood, and is said to resist the worm both of salt and fresh water. I am, Sir, &c.

W. HAMILTON.

*Oxford Place, Plymouth, Sept. 2. 1828.*

ART. XIV. *On the Propagation of Cape Heaths.* By C. L. B.

Sir,

J. DODDS (Vol. IV. p. 535.) says he was once told by a great heath-grower, that he, the said heath-grower, had struck twelve hundred cuttings of the *Erica vestita*, in one season, from two plants, but declined making known to him his method of treatment. I therefore beg leave to transmit, through the medium of your valuable Magazine, to J. Dodds, or any other person who may stand in need of such information, my mode of treatment. And I flatter myself that I am perfectly competent to come in competition with "the great heath-grower of Acre Lane," without being the least afraid that his "secret art" would give him more plants, from the same number of cuttings, than the one I practise and communicate.

The season for striking heaths, is any time from the first of February to the end of July, when young shoots fit can be obtained; the said shoots, in some kinds, as the *Sebana*, &c., can seldom be had more than half an inch in length; others, free growers, as the *Pilosa*, &c. a little longer. I seldom, however, put them in longer than an inch. Previous to collecting or preparing the cuttings let the pot or pots for their reception be prepared as follows: fit the pot with a bell-glass that will stand (when filled with compost) a quarter of an inch within the rim, then place two inches of drain at the bottom, fill up to within half an inch or an inch, according to the length of the intended cuttings, with proper heath mould; then fill up the pot with fine river sand, or if that cannot be got, pit sand, washed clean, and mixed with one fourth common white house sand. Give it a gentle watering to make it firm, and let it stand, for that purpose, while the cuttings are preparing, which is done by carefully stripping off the foliage, at least the half length of the cutting. Lay the root end upon the thumb-

nail, and, with a sharp penknife cut it through at right angles, as near a joint as possible, and where there is not the least appearance of ripened wood, but at the same time feels firm under the edge of the knife. The nearer the mould the end of the cutting, when planted, the better, that, as soon as roots are emitted they may find their natural food, and are of course sooner fit for potting out.

A bell-glass, 6 in. in diameter, will cover fifty of these little cuttings, when neatly planted in rows across the pot, in which way, a number of kinds may be put in, marked with their names, if required. After planting give a gentle watering to consolidate the sand, and, after standing a few minutes to dry, place the glass over them; press it into the sand, so as to exclude the air, and never remove it until the cuttings are struck, save for the purpose of giving water, which must be duly attended to, otherwise the cuttings will become hard, and the emission of roots much protracted, or altogether destroyed. The pots may be placed on a shelf in a warm part of the green-house, or the coldest part of a plant stove, at a distance from the flue. Cover the glasses when the sun is upon them, but by no means set them in a shady situation. Bottom heat is not necessary.

I have been the more minute, as I am convinced, from ocular observation as well as report, that there are a great many gardeners still unacquainted with the propagation of that beautiful family of plants. Hence, our green-houses are deprived of one of their greatest and most lasting ornaments. Hence, too, the admirer is induced to sacrifice the enjoyment, from the frequent calls upon the purse, necessary to keep in view the object of admiration.

I am, Sir, &c.

January 7. 1829.

C. L. B.

---

ART. XV. *Observations on the Improvement of Flower-Gardens.*  
By Mr. GEORGE M<sup>c</sup>LEISH.

Sir,

A FLOWER-GARDEN is a spot which, when tastefully disposed, is calculated to afford some of the purest and most rational of our pleasures. To the sons and daughters of elegance and refinement, to the scholar, the botanist, and the peasant, it is equally a source of amusement and pleasure.

The erection of artificial rocks, as an accompaniment of the flower-garden, is a practice as common as it is in many in-

stances ridiculous. No true taste is displayed in the arrangement; they are always too insignificant: at best they are but an uninteresting assemblage of stones; and I am sorry to have cause to add, that they remind one more of the refuse of a stone quarry, or the heaps which Mr. Macadam has ordered to be laid by the road-side, than as objects capable of yielding the least pleasurable idea.

Of all artificial scenery, a flower-garden should be the least disfigured by any kind of ruggedness, unless it be on such a scale as would be respectable in itself, worthy of the talent of the designer, and produce that effect which we often feel in the wilder scenes of uncultivated nature, and which we might desire to imitate.

To obtain such effect, I would propose that advantage be taken of any natural mound abutting on the side of the flower-garden; or, if no such thing exist, I would advise forming an artificial mound, by a collection of all kinds of rubbish and earth which may be near the spot. The face of this mound, next the garden, I would make as precipitous as possible, inserting into it as many massive fragments of stone as could be piled thereon, clothing the whole with alpine trees, shrubs, and herbaceous plants. To make this feature more complete, I would have water led to the top by pipes, which might be allowed to trickle over a jutting stone, or ooze out from a crevice of the same, into a pool or basin at the base. Here would be a correct resemblance of what is often seen in the mossy dell, and a suitable habitat for our beautiful alpine and aquatic rareties.

I am, Sir, &c.

Blandford, Feb. 20. 1827.

GEO. M<sup>C</sup>LEISH.

ART. XVI. *Observations on the Cultivation of Ferns.*  
By Mr. JAMES HOUSMAN.

Sir,

THE very valuable communication, with a list and figures of ferns, in a former number of your Magazine (Vol. IV. p. 1.), reminded me of something which I had written on the same subject; and, though I could have no wish to interpose any thing of my own in preference to any communication which has had precedence of mine, yet I beg leave to suggest whether the papers might not throw some light on each other, and more fully illustrate the history of Ferns, and bring into notice what I consider a beautiful and too much neglected tribe of plants.

It is only within these few years that naturalists were satisfied that ferns could be raised from seed; indeed, some very eminent botanists doubted whether they bore seed; and it was only owing, perhaps, to popular superstition, that we owe our first knowledge of the fact. It was customary, on Midsummer-eve, to gather fern seed for magical purposes, it being considered as an invisible entity! hence Shakspeare's allusion in *Henry Fourth*, making Gadshill say, "We have the receipt of fern-seed, we walk invisible." Morrison was the first botanist who observed the seeds of ferns to vegetate; but the first account we have of raising plants in pots is by Lindsay. Mr. Shepherd, jun., of the Liverpool garden, has lately raised above sixty species from seed, one of which is named after himself. Among other new species, he raised some specimens from the hortus siccus of the late Dr. John Forster, now in that of the Liverpool garden, and which is about fifty years old.

Mr. Shepherd, my much-esteemed instructor, has paid particular attention to this tribe of plants: he excels in the knowledge and cultivation of it, and consequently his collection surpasses all others in the kingdom. From his instructions, and my own experience, I shall state my method of raising and cultivating hardy ferns, which has succeeded to my utmost wishes.

Provide middle-sized pots, with glasses to fit just within their rims, and fill them with the following compost:—fine rotten wood, or leaves, and loam, in equal parts, sifted as fine as possible. The pots must be well drained by broken tiles at bottom; and, when filled, level and smooth the surface. Sow the seed by holding the frond over the pot, scraping off the seed, capsules, and all thereon; being careful the wind does not blow away the seeds. Fix on the glasses, and set the pots in pans, which must be kept regularly full of water (none ever being given above), and place them in a warm shady part of the hot-house. In a short time the cotyledons will appear, and not unlike the *Marchántia polymórpha*. Soon after this, raise the glasses a little, to prevent damping off; and in a few weeks after remove them entirely; and when they have two or three fronds, transplant them into 48-sized pots. Those unacquainted with the seed of ferns (and it is to those only I address myself) must not suppose, that the seed can be gathered and sown like large seeds: they are ripe as soon as the capsules become brown, and if sown as above directed, there need be no fear of failure.

Within these few years several of this genus have been divided, many of their names changed, and new genera esta-

blished. I therefore add a list of those only which are best known, and easily procured, rather than of kinds almost unknown, and which it would be difficult to obtain; as it may be useful to those who have inclination and means to begin a collection.

Connected with this subject, permit me to add a few observations. Every opportunity should be taken by those who have distant or foreign correspondents, to engage them in collecting the fronds of ferns. It is an easy task: they are light of carriage, and may prove, when sent to a friend or cultivator, an acceptable and useful present. They may be raised from seed with the greatest ease. Their natural habitat may be imitated either in hot-houses, or in the open garden; whether inhabitants of the dry or moist rock, the shady wood, or open plain; whether found growing on sound or decayed timber, on clay, loam, or decomposed vegetable earth; all these substances can be transferred with the plants, and placed in such parts of the flower-garden as will correspond with their respective habits and character.

In a collection of ferns in a garden, they should always be accompanied with the other plants of cryptogamous description usually found united with them in their native bed: of such are various mosses, lichens, &c.

## LIST OF BRITISH FERNS.

Ophioglossum vulgatum.	Aspidium Oreopteris.
Botrychium Lunaria.	Aspidium cristatum.
Osmunda regalis.	Aspidium dilatatum.
Grammitis Ceterach.	Aspidium lobatum.
Pteris aquilina.	Aspidium Felix mas.
Pteris crispa.	Aspidium fontanum.
Scolopendrium officinarum.	Aspidium rhæticum.
Scolopendrium crispum, var.	Asplenium Trichomanes.
Scolopendrium multifidum.	Asplenium viride.
Scolopendrium undulatum.	Asplenium marinum.
Polypodium vulgare.	Asplenium septentrionale.
Polypodium cambricum.	Asplenium alternifolium.
Polypodium Phegopteris.	Asplenium Ruta-muraria.
Polypodium Dryopteris.	Asplenium Adiantum-nigrum.
Bléchnum boreale.	Asplenium lanceolatum.
Polypodium calcareum.	Trichomanes brevisetum.
Woodsia hyperborea.	Adiantum Capillus Veneris.
Aspidium aculeatum.	Hymenophyllum tunbridgense.
Aspidium spinulosum.	* Aspidium bulbiferum.
Aspidium Thelypteris	* Aspidium marginale.
Aspidium irriguum.	* Woodwardia radicans.
Aspidium Felix femina.	* Onoclea Struthiopteris.
Aspidium dentatum.	* Osmunda cinnamomea.
Aspidium fragile.	* Adiantum pedatum.
Aspidium regium.	* Aspidium patens.
Aspidium Lonchitis.	* Osmunda Claytoniana.

Those marked thus (\*) are exotics, but sufficiently hardy to endure the open air. The *Aspidium bulbiferum* is raised from bulbs produced on the back of the fronds; and the *Adiantum pedatum* from young plants formed at the ends of the fronds.

LIST OF EXOTIC FERNS REQUIRING TO BE TREATED AS GREEN-HOUSE PLANTS.

<i>Davallia pyxidata</i> .	<i>Dicksonia arborescens</i> .
<i>Davallia canariensis</i> .	<i>Cheilanthes pteroides</i> .
<i>Aspidium trifoliatum</i> .	<i>Adiantum reniforme</i> .
<i>Aspidium auriculatum</i> .	<i>Adiantum tenerum</i> .
<i>Polypodium Phyllitidis</i> .	<i>Aspidium exaltatum</i> .
<i>Polypodium auriculatum</i> .	<i>Asplenium Shepherdii</i> .
<i>Polypodium pectinatum</i> .	<i>Asplenium Hemionitis</i> .
<i>Polypodium aureum</i> .	<i>Asplenium præmorsum</i> .
<i>Polypodium effusum</i> .	<i>Asplenium ebenum</i> .
<i>Diplazium grandifolium</i> .	<i>Asplenium rhizophyllum</i> .
<i>Bléchnum australe</i> .	<i>Doódia áspera</i> .
<i>Bléchnum occidentale</i> .	<i>Ptèris longifolia</i> .
<i>Hemionitis dealbata</i> .	<i>Ptèris serrulata</i> .
<i>Hemionitis rufa</i> .	<i>Ptèris arguta</i> .
<i>Acróstichum alciórne</i> .	

The above are all to be had at the Liverpool garden. I could give the names of many more species, but not knowing where they may be purchased, I omit them. The above, however, when united with a collection of the most curious and rare British plants, will make a considerable addition to the flower garden. I am, Sir, yours, &c.

JAMES HOUSMAN.

London, Feb. 11. 1828.

---

ART. XVII. *Historical and Descriptive Notice of a Plant of the Sabal Blackburnia, now in the Gardens at Hale Hall, Lancashire, the Seat of John Blackburne, Esq. M.P.* By THOMAS KIRKLAND GLAZEBROOK, Esq.

THE flowering of what was popularly called the "Great Palm," at Hale, the seat of John Blackburne, Esq. M.P., in May, 1818, excited very great attention. An opinion prevailed that the plant would die when the seeds arrived at maturity, and, consequently, the progress of fructification was anxiously watched. The contrary, however, was the case; as the palm flourished amazingly, and has continued to produce flowers and fruit almost annually, up to the present moment (July 15. 1828).

It was presented, when a small plant, to the grandfather of our worthy Member for the County, by Lord Petre, of Essex, who was a relation of his through his sister-in-law. Mr. Blackburne, sen., then resided at Orford Hall, near Warrington, where he had a very large collection, and an excellent assortment of rare and valuable plants. Indeed, the gardens were considered so fine, and the acquirements of the scientific possessor held in such high estimation, that it has been said Linnæus himself visited Orford Hall.\*

Forster, who sailed round the world with Captain Cooke, has perpetuated the name of Blackburne in the vegetable world, in the *Blackbúrnia pinnàta* †, out of respect to the elder Mr. Blackburne and his daughter; and Pennant has equally consigned it to posterity, in the animal kingdom, in the *Sylvia Blackbúrnia*, out of compliment to Mrs. Anne Blackburne.

This lady was an excellent ornithologist, and had a truly valuable collection of birds, and other subjects of natural history. So indefatigable was Mrs. Anne in her favourite pursuits, that she studied and acquired a knowledge of Latin, in order to enable her to correspond with Linnæus. The letters are preserved, and are highly spoken of.

The palm remained at Orford till 1817, when it was taken to Hale. The fears which were entertained as to the effect its removal might produce were soon allayed, by the rapid growth and improvement of the plant. †

\* There is some doubt whether this took place, no memorandum of such a visit having been found. Two of Linnæus's pupils, however, Swedes, came down, one of whom was named Fabricius. They spoke English tolerably, but Latin fluently. The present Mr. Blackburne recollects conversing with them in the latter language, and remarking, at the time, how well they spoke it. The elder Mr. Blackburne was in the habit of receiving many eminent naturalists.

† "Blackbúrnia, sic ob ingentia merita in rem naturalem appellata a Joanne Blackburne, Armig., qui Orfordiæ, Lancastriensis Comitatus, in horto amœnissimo plurimas exoticas plantas colit; et ab ejus filia Anna Blackburne quæ non solum eodem in plantas amore fertur, verum etiam incredibili solertia, aves, insecta, testacea innumera undique collegit. Pater et filia mihi in Warringtoniâ degenti usum horti et musei instructissimi lubentissimè obtulerunt." (*Characteres Generum Plantarum, &c., J. et G. Forster. 1776.*)

[The *Blackbúrnia* received its name in commemoration of John Blackburne, Esq., an excellent naturalist, who cultivated many exotic plants in his delightful garden at Orford in Lancashire; and also of his daughter Anne, an ardent lover of botany, and a diligent collector of birds, insects, and testacea. During my residence at Warrington, both father and daughter kindly offered me the use of the garden and excellent museum.]

Jussieu has ranged this plant under the genus *Ptelea*.

‡ Hale Hall is situated on the banks of the river Mersey, about eleven miles south-east of Liverpool, on the Lancashire side. Latitude, about 55° 20' N.; and longitude, west from Greenwich, about 2° 47'.



“Palms,” says our late lamented president, Sir James Edward Smith, “are formed of successive circular crowns of leaves, which spring directly from the root. These leaves and

10



their footstalks are furnished with bundles of large sap vessels and returning vessels, like the leaves of our trees. When one circle of them has performed its office, another is formed

within it, which, being confined below, necessarily rises a little above the former. Thus successive circles grow one above the other, by which the vertical increase of the plant is almost without end." This is fully exemplified in the palm at Hale. In 1818 the insertion of the lowest leaf was only about 2 ft. from the ground; it is now 5 ft. 2 in., and the "spurious stem," as Sir James calls it, is strongly marked by the remains of the former footstalks. These are about 8 ft.



long from the stem to the base of the frond. The latter 10 ft. across its largest diameter, and 6 ft. 6 in. from the insertion of the footstalk to its apex. The largest fronds, and those whose insertion is about 10 ft. from the ground, are obliged to be tied down, or it would be impossible for the palm to grow, the house being only 21 ft. 6 in. in the centre. The total height of the plant is 22 ft., and the total length of the leaves 16 ft., and their breadth 10 ft. The number of leaves is thirty.

The annexed drawing (*fig. 10.*) may serve to convey some idea of the palm; but it is by no means satisfactory, as it is impossible, on so small a scale, to do it justice. It will be evident, also, that, in order to show the flowers and fruit, I have been obliged to exhibit only a few leaves, and those in so stiff and formal a manner, as to destroy the graceful and magnificent appearance of the plant itself. A sketch I made in May, 1818, (*fig. 11.*) will give a better idea of the number of leaves.

The mode of inflorescence may be described, pretty accurately, in the words of the distinguished naturalist just alluded to. "Flower stalks much branched, invested with one large common sheath, and many partial ones."

A large upright spathe is deeply inserted in the centre, at the base of the footstalks, protruding through that fibrous texture so peculiar to the palm. Out of this the principal flower stalk arises, forming a panicle 3 ft. high, and 4 ft. in diameter at the base. The appearance of the flower is graceful; the curves of the spiculæ intermingling with each other, adding to its beauty.

The flowers (*fig. 12. a*) are sessile; they are hermaphrodite, hexandrous, and monogynous. The corolla (*b*) is tripetalous; the petals oval, concave, and beautifully white, but very small.

The filaments of the stamens are white, with bright orange-coloured cordate anthers. (*c*) The pistil is canalicate, divided into three at its base, and has a blunt stigma (*d*).

The calyx is three-cleft, green at its base, but softening into a delicate white (*e*). Each apex is tinged with reddish-brown, so as to be distinctly visible.

The three germs (*f*), are coadunate and monospermous. One of these only, in almost every instance, comes to perfection. The others decay, ejected by the growth and increase of the fruitful division of the germ.

The berry is globular, about two inches and three-eighths in circumference, filled with albumen, finally becoming hard, or horny. The embryo very small. The whole has very much the appearance of an immense bunch of large grapes. (*fig. 13.*)

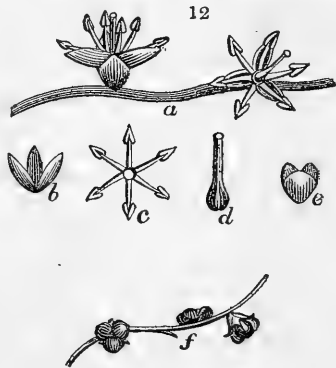

The clusters are pendulous. One of these weighed 35 lbs., and contained 5640 berries. The seeds (*a*) are hemispherical, and by dissection show the lateral embryo (*b*).

As the flowers are sessile (*fig. 12.f*), so are the germs (*e*); and were each of the divisions to increase, it does not appear probable that there would be sufficient space left on the stalk for them to attain perfection.

Mr. Nickson, the intelligent gardener at Hale, has been so good as to furnish me with the following details respecting its culture:—

It is planted in light sandy soil, in a sort of well, 6 ft. square, and 3 ft. 6 in. deep. During summer it requires 100 gallons of water once a week; in autumn much less; and, in winter, fifty gallons only once a month. As spring advances, a regular increase takes place, till the heat of the weather renders its largest supply necessary. In fine weather, also, at this period, it is sprinkled with the engine every afternoon, and closed up with a strong heat. To produce a constant exhalation of warm moisture, the paths of the house are copiously watered. The palm grows too luxuriantly, and Mr. Nickson is of opinion, that less heat would not be injurious; but as there are much tenderer plants in the same house, it is essential to keep the heat regularly up.

The house is 44 ft. long, 24 ft. broad, and 21 ft. 8 in. in the centre, and the general temperature ranges from 70° to 75° in summer, and to about 60° in winter.

This palm has been successively named, by those who have seen it, "*Corypha umbraculifera*, *Corypha umbraculifera minor*, *Corypha minor*, and *Sabal Blackburniana*." The latter, I am led to understand, is its present appellation, as well as being considered the most correct. Of this I will not presume to decide.

T. K. GLAZEBROOK.

Orford Lodge, Warrington, July 15. 1828.

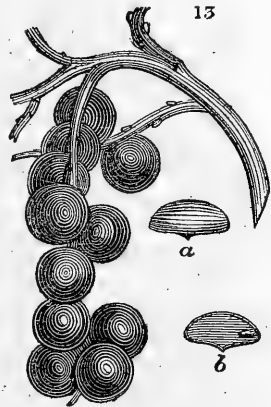

---

ART. XVIII. *On destroying the Mealy Bug and White Scale on Pine Plants.* By Mr. W. M<sup>c</sup>MURTRIE, C.M.H.S.

Sir,

AMONG the many different methods recommended for destroying the mealy bug and white scale, which pine plants are

so liable to be infested with, I send you the following, which, as I can recommend it with the utmost confidence, I hope will be found serviceable to those gardeners whose pines are unfortunately so situated. As one cannot be too particular in communicating information of this sort, and as a full description has double the effect of the sending you a mere recipe, unaccompanied with a detail of the operations, I shall minutely relate the measures I took, until I finally succeeded in clearing my plants of those pernicious insects.

When I first came to Shugborough, I found the pine plants literally covered with the mealy bug and white scale; the former had likewise so completely overrun the vines, that every bunch of grapes had to undergo an entire cleansing before it could be presented to table. In the course of my experience I had never met with the mealy bug before; and I was told by old and experienced gardeners, that I never should be able to get rid of it, and that my best plan was to throw away the plants, and get a fresh stock. This, however, I was unwilling to do, as the stock was large (never having less than a thousand plants here), so I determined to attempt to destroy the insects. For this purpose, I adopted Mr. Nichol's recommendation (mentioned in his *Forcing Gardener*): I got 2 lb. soft soap, 2 lb. flour of sulphur, 1 lb. leaf-tobacco, 2 oz. nux vomica, and I added 1 quart train-oil, and boiled them all up together, in 8 gallons of soft water. I had the plants taken up, shook them out of the pots, and cut off the roots of the greater part of them; they were then washed all over with the mixture: the rafters, trellises, &c. were all washed with it, as hot as it could be applied. I then took about 1 ft. of the surface of the bark-beds off, which I thought quite sufficient (instead of taking out all the bark, as is recommended by some), as it is not possible that insects or their eggs can exist below that; and after adding fresh tan, and turning the beds just as usual, the plants were replunged. This dressing completely destroyed the mealy bug, and I have never seen it in the place since. I thought I had destroyed the scale likewise; but, in about twelve months after, it again made its appearance upon some of the plants. As soon as I perceived it, I had the plants taken up and dressed with the same stuff; but, notwithstanding my utmost vigilance, which I continued for five or six years in this way, I found the insect increasing on my hands. I should have then given the whole stock a dressing; for, if it once gets amongst pines, it is in vain to expect to get rid of it by partial clearing; but I was unwilling to do this, because of an important objection I had to the former mixture, as it stunted the growth of the plants, and gave them an unhealthy appearance.

I had likewise been making experiments with another composition, and so successfully, that I determined to dress my whole stock with it. The materials in this case are, simply, equal proportions of soot and flour of sulphur, with a little pounded camphor added, in the proportion of  $\frac{1}{2}$  oz. to 2 lb. of the mixture of soot and sulphur, to be dusted all over the plants, after having been washed with a lotion of soft soap and water, say 1 lb. soft soap dissolved in 2 gallons of water.

In this manner I dressed my whole stock, and the cure was most effectual, never having seen a vestige of scale on any of my plants since, which is eight or nine years ago. This plan has the advantage of the mixture Mr. Nichol recommends, as it is not so injurious to the plants, nor does it disfigure their appearance so much, the mixture being nearly the colour of the foliage. I subjoin an account of how I proceeded:— After the plants were taken out of the bark-bed, I made two men look them well over, and with dry brushes rub the insects and all dirt off them. I then had two or three inches of the mould taken off the surface of the pots; they were then handed to two more men, who washed them well over with the lotion of soft soap; two more then dusted them well over with the mixture, with puffs, or dry brushes will answer as well, taking care not to let it get into the hearts of the plants, as the insect is seldom found there, or the case must be bad indeed. They were then cased with fresh mould; and, after the bark-bed had been treated as before mentioned, they were replunged, and the business finished.

I must add, by way of caution, that great care must be taken not to exceed the proportion of camphor mentioned, as it would be injurious to the plants; particularly if water is allowed to touch it, as in that case it kills the leaves.

The operation should therefore be performed in October, as from that time till spring the plants require but little water, which should not at this time be poured amongst the leaves for the reason assigned. Indeed, unless the plants are very much infected, I am of opinion the camphor might be omitted altogether. After such a dressing, and if the plants are grown in a moist atmosphere afterwards, which, by the way, they should always have to be grown well, I am confident the insects will be for ever banished.

I have recommended this cure to several gardeners, and it has never failed of the effect, when done as directed.

I am Sir, &c.

W. M<sup>c</sup>MURTRIE.

*Shugborough Gardens, Jan. 1. 1829.*

ART. XIX. *On rendering Pear Trees and other Fruit Trees fruitful, by operating on the Borders, and by Natural Training.*  
By Mr. ROBERT HIVER.

Sir,

THERE are few subjects in horticulture which can be more acceptable to your readers than a system by which good crops of fruit may be obtained from pear trees planted against the east and west walls in gentlemen's gardens; the bad crops these trees have afforded have been proverbial ever since I can remember; and the unnatural schemes which are now resorted to, such as strangulation, ringing, depressing of the branches, and reverse-grafting, show that a good system of cultivation is not yet established. This failure has generally been imputed by gardeners to the climate; but as the trees are seldom without fruit at the extremity of the branches, the supposition may be considered erroneous.

It is about twenty years ago since I noticed a brown Beurrée pear tree, trained against the east front of a farmer's cottage. This tree grew upon a limestone rock, where there was very little earth, yet it never failed to yield, yearly, plenty of large and well-flavoured fruit. From what I observed of this tree, it appeared evident that the rich and deep border, usually prepared by gardeners, was decidedly wrong, as the plants in this case generated too much sap, which always induces disease and barrenness; and, I believe, it will be found in the tree, as in the human constitution, that the state of health consists in the medium between emptiness and repletion. Sir H. Davy has shown the utility of stones in agricultural crops; and I have found them exceedingly beneficial in the formation of fruit-tree borders; they prevent the accumulation of water in very wet weather, and also retain sufficient moisture for the purposes of the plant in dry seasons. In 1813, I replanted an old pear wall, 240 ft. long; the border for these trees was 12 ft. wide, and only 26 in. deep, 8 in. of which were filled with stones, such as could be most readily procured in the neighbourhood, and the remaining 18 with the mould which composed the old border.

By this scanty supply of earth for the roots of these plants I have succeeded in obtaining a fruitful and healthy growth, equally remote from debility and luxuriance; and by this simple process I procure fruit all over the tree, as regularly as if it had been mechanically placed, both plentifully up the main stem, and on the lowest horizontal branches. My trees are fan-trained in the best manner; the shoots are kept as uniform and straight as the plications of the instrument from

whence the term is derived, and, when the fruit is full-grown, exhibit one of the most interesting scenes to be met with within the confines of a garden.

With regard to pruning, the knife should be used as sparingly as possible; I conceive it to be as injurious to this tribe of fruit-trees, as the lancet is to animal life; it creates those inconveniences which it is employed to remove: whoever indulges in its free use, most certainly defeats his own purpose. Let any man who is inclined to dissent from this opinion, consider the common thorn confined in a hedge, where it annually undergoes the operation of clipping, and the shrub in its primitive growth, and he will want no arguments to convince him of the impropriety of the practice. But my plants require very little assistance from the knife: they make no breast-wood, the energies of the tree being chiefly engaged in forming blossom-buds for the future crop.

It may be justly inferred, from what is here stated, that the bad success which most gardeners have experienced in the cultivation of this valuable fruit, arises principally from the luxuriant state of their trees; the limited space which they occupy on the wall is so disproportionate to their natural growth, that it is almost impossible, with deep and highly-manured borders, to reclaim them from a habit of plethorical sterility. The farina, and the whole fructification, partake of this unhealthy condition; and it may be observed, that fruits fecundated with bad pollen scarcely ever resist the atmospheric changes which they afterwards encounter.

From observations made in vegetable physiology, I am persuaded that the tree is principally the produce of the earth, and the fruit of the atmosphere; a great diminution of vigour may take place in the one, without any perceptible alteration in the other. It is, therefore, the first object of the cultivator to proportion the supply of nutriment to the extent of his tree, and this will be best effected by the shallow border above described.

These are the remarks of a man long devoted to the difficulties of his profession, such as have been suggested by nature, and confirmed by experience; and if they are found to be sufficiently instructive for the pages of your useful miscellany, I shall feel happy in being numbered amongst your many correspondents.

I am, Sir, yours, &c.

October 24. 1828.

ROBERT HIVER.



We shall feel particularly obliged to this scientific and experienced writer, if he will communicate as frequently as possible. We consider the above letter as worth half a Magazine. We have always stated it as our opinion, that ringing, and all the unnatural schemes of training and pruning trees, in order to produce blossoms or fruit, were only ingenious expedients of temporary application : that there is only one mode of training, viz. the fan-manner ; and one mode of reducing the over-luxuriance of a tree, viz. that of operating on the soil. The various ingenious devices of training, pruning, culture, &c., which appear in the *Horticultural Transactions* of different Societies, and in *this Magazine*, are all exceedingly useful to young gardeners and amateurs, as physiological exercises ; but those points of culture and propagation fit to enter into the general gardening or agriculture of a country are few indeed, and as simple as they are few. — *Cond.*

---

ART. XX. *On training the Gooseberry.* By Mr. WILLIAM WILSON, Merly Gardens, Dorset.

Sir,

AVAILING myself of the privilege afforded by your truly useful Magazine, I beg leave to offer a few remarks on training the gooseberry on trellises in the open garden, as practised by me here for the last six years.

I would recommend it to all who are restricted to a limited space of ground ; to the tradesman, mechanic, or cottager, it is by far the most convenient and economical plan : it requires but a small share of the garden, and in the vicinity of towns this is a most material consideration. Even to the nobility and gentry it offers advantages, by furnishing an earlier supply of fruit for culinary purposes ; and at the same time, by careful thinning, enough of superior fruit may be left for the table.

To those who may be inclined to try my plan (I mean those not practising gardening, for I neither need, nor would I presume, to teach professional men) I shall describe my process as briefly as possible. About six years ago I planted a considerable number of gooseberry trees on a border in the kitchen-garden. The trees were three years from the cuttings, and had been previously trained to two shoots each. They were planted out finally in the month of February, at a distance of 4 ft. apart ; one branch being trained horizontally on each side at about 3 in. from the ground. Being intended to be trained to a trellis, composed of upright stakes,

placed 6 in. apart, shoots were directed from the horizontal branches up each stake. The trees being 4 ft. distant, each consequently had eight upright branches; these were selected in the spring, all others being displaced. With few exceptions, all the stakes were furnished with shoots; and in the second summer many of them reached the top, which was full 5 ft. in height. The third summer after planting, the trellis was completely covered, and the trees yielded a very fair crop of fruit.

For the two last years they have continued to bear plentiful crops: pains are taken to thin the fruit regularly, by which means the greatest number, and those of inferior size, serve for kitchen uses; and the superiors are forwarded to high perfection. The wood trellis has since been replaced by a light one of iron wire, sufficiently substantial to support the trees; the whole having a light and remarkably neat appearance. Besides the orderly look of this trellis in a garden, and the saving of ground for other useful purposes, I am convinced the crop is equally abundant, and certainly of a superior quality.

I am, Sir, yours, &c.

*Merly Gardens, May 15. 1827.*

W. WILSON.

---

---

ART. XXI. *A certain and expeditious Method of raising Mulberry Trees.* By SUPERFICIAL.

Sir,

OBSERVING in your Magazine (Vol. III. p. 217.) an article on the quickest and most certain mode of raising the Mulberry tree, permit me to add a few facts, which I think curious, and to refer those who have doubts of my account, to the specimens actually growing at this time, as sufficient proof.

We are all delighted with the fruit; but we Cockney gardeners, especially, are deterred from planting, for three strong reasons; viz. the expense of the trees, the chance of failure, and the time they take before they get into bearing. I have heard the phrase used, "you are going to plant for your grandchildren," when I talked of planting a mulberry; but, so far from this being the case, and from the facts I am about to state to you, no one need be afraid of obtaining a young fruitful tree in a very few years. The history of this new discovery is shortly this:—Walking in the garden of Mr. Keene, maltster, Paradise Street, Lambeth, about three summers ago, I was surprised to see a mulberry tree open in its growth, and

bearing fine and early ripe fruit. Expressing my astonishment, he told me that, about sixteen years previous, he received, from the gardener at Lambeth Palace, a large branch, which had been blown down, and lay on the ground all winter, from a tree that, tradition says, was the first of the kind imported into England by Cardinal Pole (who died in 1558); from which branch he cut off about a foot of the thick end, and planted it. The first year's shoots were luxuriant. In four years it was in partial bearing; in seven, in full bearing, and continuing ever since. On my saying I thought he possessed the greatest curiosity in England, he desired me to look round, and pointed out another, which he had rescued from the fire, to which it had been condemned by a neighbour, by exchanging some of his own fire-wood for the mutilated mulberry stump. This Mr. Keene planted in his paved court, where it still grows, though exhibiting sad marks of the bad treatment it had met with. The fruit of this last, though black, was very inferior to the first mentioned (by the by, I do not recollect any book on gardening which notices two sorts of black mulberries, though I have seen, in a treatise on silk, published in the *Transactions of the Society of Arts*, vol. xliii. p. 221., two sorts mentioned, and that the fruit of one is inferior to the other, which may account for the difference of the trees in question); and it appears, that either may be raised by planting parts of their branches or stems; and that they may succeed, it appears necessary that the branch should lie some time on the ground, in order that the sap may thicken before the truncheon is planted.

As many persons may not like to trouble Mr. Keene on this business, they may look down the gateway, and will see the second-mentioned tree; and should they want good malt, a necessary ingredient in the beverage which makes gardeners work, they will find a truly honest tradesman in the owner.

Since writing the above, I find there is a variety of the black mulberry, having jagged leaves and smaller fruit; but it was too late to ascertain whether the last-mentioned tree was this.

Yours, &c.

*Brixton Villa, December.*

SUPERFICIAL.

ART. XXII. *Abridged Communications.*

*COW CABBAGE.* — I received a packet of the seed of this extraordinary cabbage, from a gentleman of Cirencester, who brought it from Jersey, and have sown it. In his garden, I have seen five healthy plants, which weathered last winter, in

the open garden, remarkably well, and seem to be equally hardy with their congeners. I subjoin a sketch (*fig. 14.*) and description of this curious esculent, as supplied me in a communication from this friend.

14



“The above is somewhat the appearance of a plot of a variety of cow cabbage that I saw growing in Jersey. It is much cultivated there, and attains the height of from 4 ft. to 10 ft. or 12 ft. The little farmers feed their cows with the leaves, plucking them from the stem as they grow, and leaving a bunch or head at the top. The stems are very strong, and used for roofing small out-buildings; and after this purpose is answered, and they are become dry, they are used for fuel. When the gathering of the leaves is finished at the end of the year, the terminating bud or head is boiled, and said to be particularly sweet.” — *John Murray.*

*Correction of Miasmata arising from the decaying Vegetation in a Conservatory, &c.* — The chloride of lime in solution would certainly correct various gases and vapours arising from this cause. The Hon. Henry Cavendish, by transmitting a successive series of electric sparks through a confined quantity of atmospheric air, soon obtained evident traces of the production of nitrous acid gas, in the red vapour which arose. The chemical constitution of atmospheric air is 21 oxygen, and 79 azote, or nitrogen, independent of the minute proportional of carbonic acid gas, which has been variously estimated. Now, a reversal of these proportionals would form nitrous acid; and there can be no doubt whatever, that a quantity of nitrous acid gas is formed in every thunder-storm, one of the most powerful disinfecting agents in existence; that, in truth, employed

with eminent success by Dr. Carmichael Smyth. We certainly know that vegetation wears a greener livery, and healthier aspect, after the thunder-storm, which, in its meteorological character, serves obviously to restore the balance of temperature, and promote an equable distribution of moisture; and its effects in relation to vegetation may not so much depend on its electric affinity with the circulation of the sap in vegetation, as on the evolution of nitrous acid gas in the atmosphere, in the decomposition of miasmata, or aerial poisons, hurtful to, or destructive of vegetation, and healing abraded and decaying surfaces; perhaps, too, destructive to animalculæ, &c., as the Coccus, Aphis, &c., which prey on the vital juices of the plant, and "drink its marrow up." In exotic vegetation, limited to the precincts of the stove or conservatory, and their stagnant and imprisoned atmosphere (for ventilation is too little regarded), it is highly worthy of experiment how far a small portion of nitrous acid gas, liberated cautiously by the action of sulphuric acid or nitre, might be serviceable in promoting a healthy vegetation, and restoring unhealthy vegetation to its proper tone. We may thus gain a powerful auxiliary and active agent, and the consequence would be a beauteous and luxuriant vegetation, "bearing its blushing honours thick upon it." By a careful inspection of what occurs around us, we occasionally glean valuable practical hints; and an inspection of the wonders of the thunder-storm may be rewarded by the fruits of a successful application of the produce of its power. — *John Murray.*

*An Onion planted near a Rose said to increase its Odour.* — This remark has already appeared in the Gardener's Magazine, and I think the experiment is one that promises success. I was led, some time ago, to submit the onion to chemical analysis, when I discovered that it contained much *ammonia*. Mons. Robiquet, of Paris, some years ago proved that ammonia possessed the peculiar property of restoring the lost aroma, as in musk, &c.; and I am also of opinion it is the efficient cause in the developement of the aroma in flowers; and that night-smelling plants, as the Geranium triste, Rosa odora, &c., are indebted for this very peculiar feature in their physiology to ammoniacal gas, liberated at this season of repose, and at no other period of the day. What effect the cautious administration of a solution of carbonate of ammonia to sweet-scented flowers, in the form of a gentle watering occasionally, may produce, experiments can alone determine. When rose leaves, &c. are preserved in perfume-jars, common salt is generally sprinkled over them. A little powdered carbonate of ammonia I find increases the aroma. — *Id.*

## PART II.

## MISCELLANEOUS INTELLIGENCE.

ART. I. *Foreign Notices.*

## FRANCE.

*The Central Agricultural Society of Paris* held a Meeting on December 17, at which a paper was read on cultivating resinous trees, and another on raising potatoes from seed, and a committee appointed to prepare notes for a new edition of Delamarre's work on the culture of the genus *Pinus*. Another Meeting of this Society was held on January 7., at which a paper was read by Sir John Byerley, on Artesian wells, *i. e.* the system of finding supplies of water for domestic purposes, by boring. Sir John and M. Degoussè have entered into copartnership for the purpose of forming these wells, and have already been employed in various places in the environs of Paris, and by the city of Chartres.

*The Horticultural Society of Paris* held a Meeting on the 17th, which was wholly devoted to discussions relative to printing the *Annales* of the Society, and the best mode of preparing a monthly calendar for their journal. Another Meeting, on January 7., was chiefly occupied with a proposition made by M. Boursault, for the union of the Société d'Agronomie Pratique (Vol. IV. p. 488.) with this Society, regarding which, the latter Society, as the elder, declared its willingness to receive propositions from its younger sister.

Our last notes from France (Vol. IV. p. 489.) left us at Strasburg, October 19., on the eve of setting out for Germany. We re-entered France, by crossing the Rhine between Rastadt and Hagenau, on December 2.

Our object in passing by Hagenau was to examine the pine forest, composed of a very superior variety of *Pinus sylvestris*. We inspected it, in company with M. Neunreutter, who supplies the seedsmen of France and Holland with Hagenau pine-seeds; and we brought away six pounds of seed, two pounds of which we have sent to the Caledonian Horticultural Society; one pound to Mr. Reid of Aberdeen, and two pounds we retain, to be given to such proprietors as will undertake to sow it very thin, and unmixed with other tree seeds, on sandy soil, and where it is finally to remain. It appears to us a more vigorous variety of Scotch pine than any we have in Britain; its growth is remarkably rapid, both at Hagenau and on the German side of the Rhine; and the timber is said, by M. Neunreutter and others, to be equal to that of Riga pine. It has been used both for masts and for ship-building. M. Vilmorin has sown, on his estate to the south of Paris, pieces of several acres of this and other varieties of Scotch pine, with a view to mark their comparative rapidity of growth, and the value of their timber; an experiment which, conducted by a man of so much science and accuracy as M. Vilmorin, cannot fail to be attended with important results.

After examining a very remarkable institution at Hagenau, which has suggested to us the idea of a description of working-convents, for single men and women, which we shall afterwards develope, we went to Saverne, where we examined the ruins of the very fine palace and gardens, which

were the ornament of that town before the Revolution; thence to Chateau-Salin, where we established two correspondents, one of them Mademoiselle Loritz, a great amateur, with the best collection in that part of the country.

At Metz we arrived on December 6., and remained till the 10th. In the Botanic Garden we found that the *Anona Cherimolia* had been fruited several years ago, by the common treatment of bark-bed woody plants. The pots are about a foot in diameter, and the plants were raised from seed about twenty-eight years ago; nine or ten fruits were produced six or eight years since, about the size, shape, and colour of oranges, and very palatable. Young plants have been raised from their seeds, which are now nearly 15 ft. high, the height of the parent plant. The director of the garden is M. Coutie, an excellent man, and an enthusiastic gardener, about eighty years of age, who worked in the gardens of Kew thirty years ago. The grounds of the Baron de Tschoudy, who invented the greffe herbacée, are in the neighbourhood of Metz; but of these, of the gardens of M. Durand (a reader of both our Magazines), of the Comte Dourche, of the nurseries of Messrs. Simon frères, of the vegetable gardens, and of the vegetable market and seed-shops, we have not time at present to enter into details.

We arrived at Paris on the 12th; and after visiting the farm of Trappe, the agricultural establishment at Grignon, the manufacture of potato-flour at Bondy and at two other places, and revisiting a number of the vegetable and flower-gardens of Paris, and the forcing-garden of Versailles, to observe their winter-management, we left that city on Jan. 9., and arrived at Bayswater on the 16th inst. Having thus given our readers an outline of our four months' tour, we intend filling it up in succeeding Numbers, under the division of Original Papers, Part I. — *Cond.*

*Vegetable Anatomy.* — Dr. Dutrochet has discovered that, if you submit any part of a plant to the action of hot nitric acid for a short space of time, all power of cohesion is lost by the vessels, which become transparent, and are easily separable from each other by gentle dissection. So complete is the effect of this agent, that even the most delicate cells of the cellular tissue become disengaged from each other, and may be examined singly, and with perfect ease. We rejoice in this discovery, as it will enable gardeners and others who cannot afford to purchase compound microscopes, and delicate dissecting instruments, to verify the anatomy of Mirbel, and many of the ingenious experiments of Knight, and other physiologists, and, probably, to make new discoveries themselves.

The manner in which Dutrochet performed his experiments was this: — “I placed,” he observes, “a fragment of the plant I was desirous of studying, in a little phial filled with nitric acid, and plunged it into boiling water. By this operation, the parts which compose the cellular tissue lost their power of cohesion, and became transparent, which rendered their examination much less difficult. At the same time, the tracheæ and the other vessels filled with an aëriiform fluid, which is also a great assistance in viewing them. Care, however, must be taken that this operation be not too far prolonged, because, if it be, the vegetable tissue will be destroyed: the observer must regulate the time which the plant is to remain in nitric acid according to its greater or less degree of delicacy. Generally, the time for suspending the experiment is indicated by the fragment having become transparent, and being capable of easy separation. To make the observation, I throw into water, in a watch-glass, the smallest possible morsels which can be procured by mere mechanical division, and I place them under the microscope.” This subject is farther illustrated in the *News of Literature and Fashion*, by an eminent botanist. (See No. 89., et seq.)

*Uva passa.* — This term was applied, by the Romans, to those sorts of grapes which were calculated for drying like our raisins (raisin sec, *Fr.*); and, hence, when the word *passé* is placed before the name of any fruit, it

signifies that it is well adapted for drying: as *Passe-Musquée*, *Passe-Colmar*, &c.

*Pinol*. — This name is applied to a variety of grape common in Burgundy (our Burgundy and Black Cluster); but whether it is the name of the cultivator who introduced it there from Auvergne, where it is called *Auvernal*, or from the conic or pine-like form of its berry, the French writers are not agreed. There is an Italian variety, called *Pignolus*, and another, *Pinoz*, both mentioned by *Crescentius*.

*Labourer*. — This word, as used by the ancients, and also, till lately, by the moderns, is to be considered as synonymous with agriculturist, as well as with farmer and cultivator. The division of labour, and the creation of capital, have given rise to the different kind of labourers, and their names. (*Notes to Olivier de Serres*.)

*To render Timber inflammable*. — Steep it in a solution of alkali or alum. (*Cadet-de-Vaux*.)

### GERMANY.

*Bavaria*. — In our last (Vol. IV. p. 491.), we continued our outline to the 50th of October, which left us at Munich. We afterwards examined all the royal gardens and parks, the Museum of the Agricultural Society, the Agricultural Institution at Schleisheim, the churchyard, not the least remarkable feature of Munich, and the estate of Baron Eichthal, who has introduced various improved practices from England, and let a considerable farm to an East Lothian farmer. Baron Eichthal is an enlightened and highly patriotic individual; and his example, and the precepts and advice of M. Hazzi, will soon spread the best agricultural practices over the whole country. From what Mr. Sawyers, the East Lothian farmer, stated to us, we found, as we expected, that the Bavarians are not at all prejudiced against new practices, merely because they are new; and that the use of swing-ploughs, turnips on raised drills, and, in short, the whole of the East Lothian and Berwickshire husbandry, will be much more easily introduced in Bavaria than they could be in the south of England. The reason is plain: the country-labourers of Bavaria are better educated than the country-labourers of England.

We left Munich on Nov. 8.; examined the Botanic Garden at Ratisbon on Nov. 10.; arrived at Nuremberg on the 11th, and examined a number of small gardens and nurseries there, including the garden of Madame Hepp, one of the principal amateurs in Germany as a private individual; the flower-garden and seed-grounds of M. Falcke, an extensive dealer in seeds, and of M. Campe, a celebrated bookseller. The soil in the neighbourhood of Nuremberg being dry and sandy, has, for many years, supplied various descriptions of garden-seeds for the rest of Germany, and other parts of Europe. Even tuberose roots are grown in that soil for the purposes of commerce, and also the bulbs of the common hyacinth, *Guernsey*, *Belladonna*, and *Jacobæa lily*. We were introduced here also to M. Reider, a gardening author, who has produced several esteemed compilations, and is the editor of a botanical magazine, which appears monthly, with coloured figures.

*Wurtemberg*. — We arrived at Stuttgart on Nov. 15., and were beyond measure gratified with the town, the people, and especially the surrounding country. We never before saw any country so rich with fruit trees, vineyards, and gardens, and at the same time so populous, so varied, and picturesque. In one of the happiest situations in the midst of this scenery, and on the high bank of the Neckar, is situated the king's country house or palace, *Rosenstein*, now completing, to which the whole seems the appropriate garden. We examined and brought away plans and views of several of the other palaces and gardens; and M. Salucci, the government architect, and M. Bosch, the director-general of gardens, have promised to prepare and send us those of *Rosenstein*. We examined the agricultural establishment at *Hochenheim*, till lately under the direction of M. Schwertz, all the public



nurseries and market-gardens, the churchyard, and the vegetable market. On the 23d we left for Heilbron, Heidelberg, Schweitzingen, and Carlsruhe.

*Baden.* — We arrived at Carlsruhe on Nov. 26., examined the Botanic Garden and Pleasure-Ground there, under the direction of M. Hartweg, author of *Hortus Carlsruhænus* (Vol. III. p. 204.), and various other gardens, grounds, and establishments, and especially the girls' school, under the direction of Professor Kärcher. We concluded the German part of our tour on Dec. 5., passing by Baden and Rastadt. At the latter town we saw M. Jacob Ainslie, mentioned by Dr. Ponqueville, under the name of Jaques (*Encyc. of Gard.*, § 508.), as having been gardener to the Grand Signor. M. Ainslie has seen a deal of the world, speaks five or six languages, and gave us some curious and useful information. Between Rastadt and the Rhine we passed through a forest of pines, which has the same reputation as that of Hagenau. The variety of *Pinus sylvéstris* has every appearance of being the same, as is the soil. Seeds are collected for the trade by M. Schöttell of Rastadt, from whom we brought away two pounds weight, for distribution. We also brought a few culinary seeds from the royal kitchen-gardens of Munich and Stuttgart, and the grand-ducal kitchen-garden of Carlsruhe. They are chiefly of German greens, Russian cabbages, savoy, kohlrabi, and knoll celery, but of finer growth than any we ever saw in England. We have divided them equally between the Horticultural Societies of London, Edinburgh, New York, and Philadelphia. There are also among these seeds a few of *Astragalus bœoticus*, the seeds of which, roasted and ground, make a very good coffee. We proved this at Munich, where M. Hazzi has introduced these seeds and their culture, as well as another plant called New Zealand Tea, the leaves of which are said to form a very good substitute for the Chinese tea. Of this last plant we know nothing. None of the culinary seeds above mentioned have the slightest pretensions to novelty; and it is possible as good varieties may be in England already, though we have not seen them. Should the contrary be the case, their introduction will be beneficial in proportion to the extension of the culture of these plants in every cottage-garden in every temperate climate.

Much as we were satisfied with the agriculture and gardening in these three states of Germany, we were incomparably more so with the state of general education, and its influence on the manners and happiness of the people. In this respect, Great Britain and France have much to learn from these countries. At Paris we commenced a letter on the subject, intended for the *Journal d'Éducation et d'Instruction* of M. Lasteurie; but finding it too long for that work, we had it printed there as a pamphlet\*; and we shall give the essence of it in our next Number.

#### ITALY.

*Grano marzuolo or marzolano.* — This is the variety of common wheat cultivated in Tuscany, on the sandy hills on both sides of the Valley of the Arno, for the purpose of being plaited and made into hats. It is sown in March, very thick, and pulled when the ear is fully shot, but before the grain is formed. It is then 18 in. high, if the crop is good; it is bleached as we do flax, and afterwards tied up in bundles in the same manner, and carried home, to have the part between the ear and the first fruit in the stalk selected, that being the only part used.

To obtain the whiteness so much prized, the straw is smoked with sulphur previously to being worked; the plait is also smoked; and, lastly, the

---

\* Des E'tablissemens pour l'Éducation Publique en Bavière, dans le Wittemberg et à Bade, avec Remarques sur les Améliorations à introduire dans ces E'tablissemens pour les faire adopter en France, en Angleterre, et autres Pays. Paris, Mesnier, 8vo, pp. 67.

hat. About Sienna the process is simply a little sulphur set on fire in the bottom of a large chest, bunches of the straw being placed on long hazel rods across, and the lid shut down. Elsewhere, the articles are described as being placed in a small close room, in which a chafing dish of sulphur is placed, and set fire to. Sometimes the operation requires to be done twice before it succeeds.

The straw for use is classed or stapled like our wool. Children or inferior hands work the coarse thick straw, while good hands work the fine only. Whether fine or coarse, it is only the part on which the spike grows that is made use of; and it is always the same plait, consisting of thirteen straws, which is worked. In the fine plait there is a very great waste of straw, as they reject all that is in the least too thick, and they cut off a considerable part of the straw where it comes near the flower-spike. Fine plait is not accounted good unless very much drawn together; for which end it is worked very wet. The bunches of straw are always put into a small jar, filled with cold water, which stands beside the worker. After being smoked and pressed, the plait is made up into hats by women, who do nothing else; it is not put together by edges, nor overlapped. On the operation of pressing a great deal depends: there are only two good machines for that purpose in the country.

Such is the practice for procuring the hat straw: what they sow for seed is in other ground: not one fourth of the seed is used, and the grain is allowed to come to maturity in the usual way. It is said to be a capital wheat for vermicelli, macaroni, &c., and also for making into bread.

It ought to be taken into view, that, for the use of the manufacture in Scotland, the straw should not exceed one eighteenth of an inch in diameter. When coarser, it does not answer the market; and much of the very finest straw is not required, because the bonnets made from it are too expensive. (*Prof. Jam. Phil. Jour.*, March, 1817, p. 384.)

## SPAIN.

*Elysium in Spain.*—In Spanish Estremadura, a person who has 100*l.* per annum may support a family of four or five in number with great comfort, and enjoy the luxury of a carriage. The finest bread is at little more than one halfpenny per lb., good wine at one penny per bottle; small lambs and kids about eighteen-pence each, and vegetables cheap, and in abundance. Labourers in husbandry are to be hired at less than 7*d.* per day, and a female servant for about 2*l.* sterling per annum, and occasionally a few cast-off articles of clothing. There is good pasture for cattle almost for nothing; and the sweet acorns, which make the pork so delicious in parts of Spain and Portugal, grow wild, and are to be had for the gathering. Such is Spanish Estremadura, and yet nobody thinks of emigrating thither. (*Newsp.*)

## DENMARK.

*Gurré* is a place of great note in the neighbourhood of Elsinore. An old king of Denmark, Valdemar Atterdag, was so partial to the situation, that he called it his heaven; declaring, at the same time, that God might keep heaven to himself, if he would only allow him to keep *Gurré*.

*The Gardens of Fredensborg* have been variously described by different travellers, ladies as well as gentlemen. Some find them very interesting, if not in the newest style; others grand and magnificent, although on the old plan; others, again, think them stiff, melancholy, and neglected, being environed by lofty pines, which exclude views on the adjacent lake, render breathing difficult, and expose the visitor to swarms of gnats, where he expected to sit in odorous groves, listening to melodious breezes. A most ingenious gentleman, the D<sup>r</sup>Israeli of Denmark, who seems in his writings

to display the humour of Swift and the pathos of Sterne, describes, with much feeling, the desolate condition of Fredensborg:—“ Even that beautiful spot, the Norwegian Valley, a circular spot, on which sixty-five figures of sandstone, representing the different costumes of Norway, are placed,” he says, “ has felt the effects of neglect, in regard to the stone figures placed there. Dancers with one leg, and fiddlers with one arm, may be seen. Weeds and grass shoot up unmolested round Wiedewelt’s masterpieces, and every thing appears to be left to itself.”

Although the gardens have not been laid out in the English style, there is something imposing about them, which surpasses all idea. From their vast extent, and stiff yet majestic avenues, the tops of the trees appearing to be lost in the clouds, they may be justly esteemed the principal gardens in Denmark. A person who has not been there before, may easily lose his way, unless he has a guide.

*Jægersborg Park* displays the magnificence and beauty of Danish forest scenery in the highest perfection. The red deer, here called down deer, are of a far superior species to those in Windsor Forest, or the Duke of Bedford’s park at Woburn Abbey. It is a truly majestic sight when you meet with a herd of thirty or forty old stags grazing in some of the solemn circular glades in *Jægersborg Park*, where, from the closeness of the wood, the light chiefly descends perpendicularly. The hinds with their fawns, on the other hand, seek an extensive plain, in which stands a hunting-seat, very improperly called the Hermitage, but now seldom used for its original purpose. The house, from its lofty situation, commands a fine view of the sea. But, as a building, it is scarcely worth inspecting, and is now rapidly falling into decay. It will not indeed be missed in a park, of which Mr. Coxe says, “ It is perhaps the finest spot for the natural beauty of the gentle waving grounds, and the richness of the wood; and sufficiently proves that the nobles may lay out their grounds equal to ours in England, if they would trust more to nature, and less to art.”

M. Hauch, a gentleman of rank and science, has lately set a good example in appreciating the beauties of this part of Zealand. He has introduced a style of rural architecture, which gives the proprietor all the benefits of a residence in the country without occasioning heavy and useless expense. Having cleared a considerable tract of land, which had formerly been forest, in the vicinity of *Esrom Lake* (*fig. 15.*), he allotted it

15

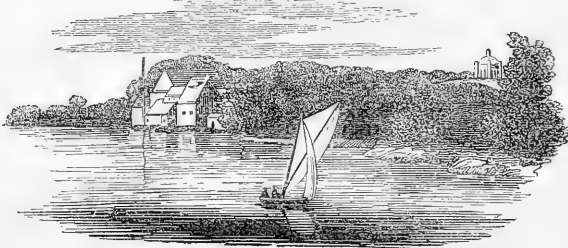

in small divisions, to a great number of cottagers. In an elevated part of the estate he has built a two-storied dwelling, in a neat, unassuming style. It possesses an extensive view of the country, and will itself form a most interesting object, when the adjacent cottages shall wear that general appearance of comfort and happiness, to which they are rapidly advancing under the auspices of this nobleman.

At a short distance from his seat he has laid out a farm on the most approved principles, where the neighbouring cottagers will derive the best

guidance, in the culture of their plots of ground, from what they see practised. M. Hauch's gardens and plantations will also be the means of turning the attention of the cottagers to an improved method of horticulture and fencing, in which the peasantry of Zealand are generally so much behind. The Rev. Mr. Junge, in his invaluable work on the character, customs, opinions, and language of the peasantry of North Zealand, mentions that hedging is diametrically opposite to the peasant's principles of agriculture. The learned author has himself seen quickset hedges ruined in the course of a night, long rows of young timber trees irrecoverably broken, and the tops of fruit trees cut off, just as the savages of Louisiana do, that they may pluck the fruit with greater ease. He proposes to remedy those evils by the enactment of an old law in Holstein, pursuant to which every young man was obliged to plant a dozen of trees before he could ask the minister to read the banns; and for every son with which God blessed him, he had, besides, to plant six or eight trees.

*Fredriksborg* is approached by one of the most beautiful roads in Denmark. The traveller who is anxious to carry pleasing recollections with him of this country, will pursue his way through the gardens of Fredensborg, down to the boat-house on Esrom Lake. (*fig. 16.*) Thence he should

16



cross the lake to a wood called Nöddeboe-holt. There he will enjoy an extensive view of this fine lake, which must be allowed to surpass even Loch Lomond in softer beauties. There is a luxuriance of grand forest scenery on Esrom Lake, of which Loch Lomond, with the exception of some scanty plantations, is altogether destitute.

From Nöddeboe-holt the traveller should proceed to a more elevated position, near the house of a forester named Bruhl, who has displayed great taste for the picturesque in his management of the king's forests. This spot commands an uninterrupted view of the lake. In the lower part its wooded banks project from both sides far into the lake, and form, as it were, lesser lakes and beautiful bays. On the left bank of the lake a fine forest extends as far as Esrom. In this direction the Swedish ridge of hills called Koll present a noble back-ground to the naked shores of the lake; which, however, soon resume their sylvan appearance on the right bank, in the vicinity of Fredensborg. (*Fieldborg's Germany.*)

#### RUSSIA.

*The Imperial Botanic Garden*, in the Apothecaries' Island, at St. Petersburg, it is reported in Paris, will probably be removed to the garden of the

Taurida Palace; a projected change which we were not at all surprised to hear, considering the great liability of the Apothecaries' Island to inundations of the Neva. Some account of this garden will be found in Vol. I. p. 84. We have tried in vain to obtain a relation of the losses it sustained by an inundation shortly after its completion; but we have not been so unsuccessful in procuring a ground plan, sections, and descriptions of the double quadrangle of hot-houses erected, or to be erected, and which we shall lay before our readers in an early Number. — *Cond.*

## ASIA.

The Cinnamon Department of the Island of Ceylon consists of from 25,000 to 26,000 people, who form a separate cast of their own, and who are altogether employed in the cultivation of the cinnamon tree (*Laurus Cinnamomum*) (fig. 17.), and in preparing the bark of that tree for the market.

The exportation of this article from Ceylon frequently amounts to 6000 bales, of 80 lbs. each bale. Although the cinnamon grows wild in the south and south-west part of the island, the Dutch and English governments have thought it advantageous to have it cultivated in four or five very large gardens; one of the largest of which, called the Marandan, is close to Colombo; and it is in this that the house and garden of Rajah Pakse (fig. 18.) is situated. From the bark of the cinnamon tree the cinnamon, which is used for culinary purposes, is prepared. It is from the same bark that the cinnamon water and the cinnamon oil are prepared; and also a very fine oil, like the oil of cloves, is prepared from the leaves, and the finest description of camphor from the roots.

Rajah Pakse (fig. 18. a), besides being a man of considerable wealth, has great influence amongst the natives of the country, from his official situation, and is one of the most enlightened and liberal-minded natives in the island of Ceylon. He was the man who was principally employed by Sir Alexander Johnston in carrying into effect the various measures which he, whilst president of His Majesty's council in Ceylon, introduced for raising the moral and political character, and improving the state of the natives of that island. Rajah Pakse was the first great proprietor of slaves, who, on Sir Alexander Johnston's suggestion, adopted the resolution, which was afterwards universally acquiesced in by the natives of all the different casts, for gradually emancipating the whole of their slaves, and thereby putting an end to the state of domestic slavery, which had subsisted for more than three hundred years. It was through his intelligence that Sir Alexander Johnston was enabled to succeed in establishing trial by jury, which was the first instance of that mode having been introduced amongst any natives of India. It was also through his activity that Sir Alexander Johnston, when he collected, for the use of the government, all the customary laws of the various religions and casts in Ceylon, procured the necessary information, to enable him to accomplish that object; and it was from Rajah Pakse's thorough knowledge of the Pali and Sanscrit languages, that Sir Alexander Johnston was enabled to get the translations, which are about to be published by Mr. Upham, of the three original native histories of the Buddhoo religions, and of its introduction into Ceylon, which were presented to him by the high priests of that religion on the island, who are looked upon by all those who profess that faith, as well in Ceylon as in the Burmese and Siamese territories, as



the persons who are best acquainted with its doctrines and tenets. The man (*fig. 18. b*) conversing with Rajah Pakse, is a Mahommedan physician, of whom Sir Alexander Johnston has given the following description in a note to a paper on the history of the Mahommedan inhabitants of Ceylon, presented by him to the Asiatic Society of Literature, and printed in the last number of the proceedings of that Society : —

18

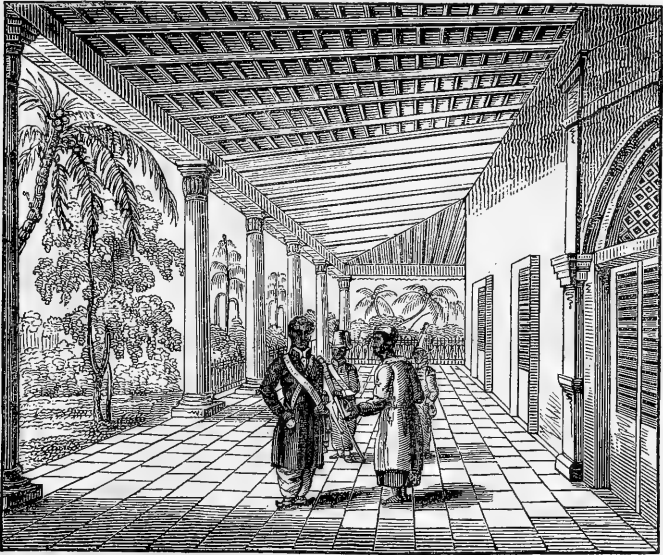

a b

“ I have a copy in my possession of a very curious and very ancient grant in copper, made by one of the Cingalese kings of Ceylon, about six or seven hundred years ago, to a great Mahommedan merchant, who was then residing at Barbareen, in the island of Ceylon, and to his descendants for ever, of certain privileges and immunities, in consequence of his having introduced, from the opposite coast of India, the first weavers of cloth who were ever established in Ceylon. By virtue of this grant, the lineal descendants of that merchant now enjoy, under the British government, a portion of the privileges which were granted to their ancestors by the ancient Cingalese government of the country, and which were successively confirmed to them by the Portuguese, Dutch, and English governments in Ceylon. The chief of this family was appointed by me, in 1806, native superintendent of the medical department, under the control of the Supreme Court. He was considered by the natives of the country as one of the best informed of the native physicians in the island, and possessed one of the best collections of native medical books, most of which had been in his family between seven and eight hundred years; during the whole of which period it had been customary for one member of his family at least to follow the medical profession. This same person made me a very detailed report of all the plants in Ceylon, which have been used from time immemorial for medical purposes by Mahommedan native physicians in that island. The cultivation and improvement of these plants, as well as of all other plants and vegetables in the island, which might be used either for food or commercial purposes, was one of the great objects for which His Majesty's government, at my suggestion, in 1810, established a royal botanical garden in Ceylon.”

The two persons who are in attendance upon Rajah Pakse are two men of the militia of the Cinnamon department, called Lascorcens. Each native chief has a right, according to his rank, to be attended by a certain number of these men, who carry in their hands, to shelter the chief from the sun, a leaf of the Talipot, or *Corypha umbraculifera*; the great use made of which palm in Ceylon may be known from the following account given of them in a description which has been lately published of that tree: —

The Talipot is the *Corypha umbraculifera*. (*fig. 19.*) All the books of importance in Pali and Cingalese, relative to the religion of Buddhoo in Ceylon, are written on lamina of these leaves. The Pali and Cingalese character is engraved upon them with either a brass or an iron style. There are some of these books in Sir Alexander Johnston's collections, which are supposed to be between 500 and 600 years old, and which are still very perfect.

Sir A. Johnston gave the Royal Asiatic Society, some time ago, a complete copy of the Pali book called the *Pansyapanas Jatakay*, written on 1172 laminæ of this sort of palm leaf. This book contains the whole moral and religious code of the Buddhist, and is so scarce, that it was for some time believed that there was no complete copy extant. Sir Alexander Johnston, when president of His Majesty's council in Ceylon, being, from the various benefits he had conferred on the

priests of Buddhoo and their followers, much in their confidence, was allowed by them to have this complete copy taken of all the different parts of it, which were dispersed amongst the most celebrated temples in Ceylon. Sir Alexander also gave the Asiatic Society a very fine specimen of a Burmese book on the Buddhoo religion, written upon laminæ of this leaf, which are beautifully lacquered and gilt over, which was sent to him by the King of Ava, along with some other books, as the finest specimens he could give him of the manner in which the books were written and bound in his library at Ava.

This leaf is used in the maritime provinces of Ceylon as a mark of distinction, each person being allowed to have a certain number of these leaves, folded up as fans, carried with him by his servants (*fig. 18.*); and also, in the Kandian country, in the shape of a round, flat umbrella, on a long stick, as is represented in a fine drawing, in the possession of Sir Alexander Johnston, of the late Adigar or Prime Minister of the King of Kandy, who was the cause of the massacre of the English at Kandy in the year 1803. It is, moreover, used in making tents. Sir Alexander Johnston gave a very fine specimen of a tent made of these leaves, large enough to hold a party of ten persons at table, to the late Sir Joseph Banks, in 1818.

These leaves are also used by the common people to shelter themselves from the rain, one leaf affording sufficient shelter for seven or eight persons. In the botanical garden which His Majesty's Ministers established in Ceylon, on Sir Alexander Johnston's suggestion, in 1811, it was intended



19

to make a complete collection of this, as well as of all other species of palms, in Ceylon.

The tall palm trees in Rajah

Pakse's garden are the *Cocos nucifera* (fig. 20.), the *Borassus flabelliformis*, and the *Caryota urens*. Of the first the following description is given by Sir Alexander Johnston in his note of the above-mentioned papers, delivered by him to the Asiatic Society:—

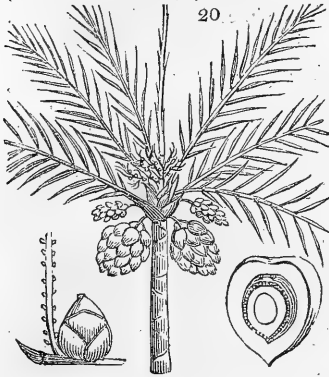

The coarse filament of the cocoa-nut husk, called *coir*, is used throughout India for rope. In Ceylon it is obtained from the cocoa-nut trees, which grow in great luxuriance along the south-west part of the coast, from the river Hymel to the river Wallaway, forming a belt one hundred and thirty miles in length, and one and a half in breadth. This belt was estimated, in the time when the Dutch governed Ceylon, to contain between ten and

eleven millions of cocoa-nut trees, and to produce, in addition to a great quantity of cocoa-nut oil, and six thousand leaguers of arrack, upwards of three millions of pounds weight of coir. A good tree in that belt was estimated to produce from fifty to eighty, and sometimes one hundred cocoa-nuts in a year; each cocoa-nut being equivalent, as food, to at least three ounces of rice. Of the latter the following description is given in a note to the same paper:—

The Palmyra of the province of Jaffna is the *Borassus flabelliformis* (fig. 21.) of Linnæus. This palm grows to great perfection in that province. The species of *Borassus* in Jaffna, which is so valuable, is that of which the wood is almost quite black. It is used all over India for rafters, and for the roofs of houses; and is peculiarly valuable, from its resisting all insects, and being extremely durable. The *Borassus*, independently of its supplying this valuable wood for exportation, is of the greatest importance to the inhabitants of Jaffna, from its fruit and roots being used by them for food; and from many other parts of it being used by them in manufactures, and as articles of trade. (Sir A. Johnston in *Trans. of the R.A.S.*, vol. i. p. 454.)

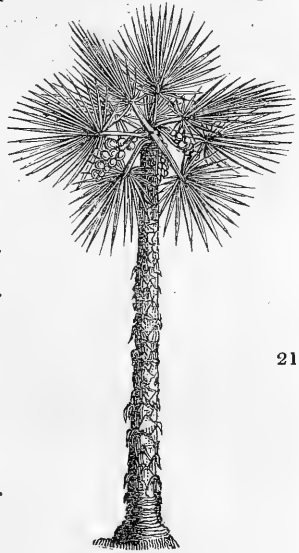

## NORTH AMERICA.

*Jamaica Society for the Encouragement of Arts and Agriculture.*—Sir, I take the liberty of sending you the following account of proceedings in the Jamaica Society for the Encouragement of the Arts and Agriculture, on Nov. 11., when premiums were awarded to Mr. Smith, for New Zealand hemp and various other new plants, 8 dollars; to Mr. John Wills, for cauliflowers, 3 dollars; to Mr. Alexander Robertson, for mead, 4 dollars;



to Mr. C. S. Cockbren, for *Clerodéndrum frágans*, 4 dollars; to Mr. Strupar, for flowers, 3 dollars; and to Alexander Maclarty, Denis Maclarty, and Jane Thompson, slaves of Clydesdale, for potatoes, each 1 dollar.

A letter from Mr. Atkinson was read, accompanied with specimens of Indian rubber produced in the island, and of the juice from which it is made.

Mr. R. Smith was elected a member of the Council in the room of the Rev. Mr. Mann. — *X. Y. Jan. 15. 1829.*

*The Mulberry Tree* grows indigenously throughout the United States, and it is thought silk can be raised with facility from the northern to the southern boundary of the Union. This article costs the country now 6 or 7,000,000 dollars. Very beautiful specimens of silk have been exhibited in Baltimore, which are the product of worms raised in that city, and spun by a machine, of which Mr. J. A. Blane is the maker. That gentleman, who is by birth a Piedmontese, was largely engaged in the manufacture of silk before he was compelled to leave his native land. He is of opinion that no climate is better adapted to the silk-worm than Baltimore. (*Newsp.*)

*Sugar.* — Letters from St. Augustin (Florida) mention that the culture of the sugar cane is thriving there beyond all original expectation, and that this produce promises to become in a few years a branch of that important trade. The *Journal du Commerce* of Saturday last gives a return for the year 1827 of the beet-root sugar produced in the northern departments of France, the whole quantity of which amounts to 1,218,000 kilogrammes, (2,650,000 lbs.) It is thereby shown that this new branch of industry has risen to an importance that calls for the future attention of the commercial department of the state. (*Scotsman*, April 2.)

---

## ART. II. Domestic Notices.

### ENGLAND.

*WEATHER Prognostics.* — When the clouds are red in the west, with a tint of purple, it portends fine weather, because the air when dry refracts more red or heat-making rays; and as dry air is not perfectly transparent, they are again reflected in the horizon. A coppery or yellow sunset generally foretells rain; but as an indication of wet weather approaching, nothing is more certain than a halo round the moon, which is produced by the precipitated water; and the larger the circle, the nearer the clouds; and consequently the more ready to fall. As to the rainbow, the old proverb is correct, —

“ A rainbow in the morning is the shepherd’s warning;  
A rainbow at night is the shepherd’s delight.”

It may be thus explained: — A rainbow can only occur when the clouds containing or depositing the rain are opposite to the sun, and in the evening the rainbow is in the east, and in the morning in the west; and as our heavy rains in this climate are usually brought by the westerly wind, a rainbow in the west indicates that the bad weather is on the road by the wind to us; whereas the rainbow in the east proves that the rain in these clouds is passing from us. When swallows fly high, fine weather is to be expected or continued; but when they fly low and close to the ground, rain is almost surely approaching, because swallows follow the flies and gnats, and flies and gnats usually delight in warm strata of air; and as warm air is lighter, and usually moister than cold air, when the warm strata of air are high,

there is less chance of moisture being thrown down from them by the mixture with cold air ; but when the warm and moist air is close to the surface, it is almost certain that, as the cold air flows down into it, a deposition of water will take place. The augury of the ancients was a good deal founded upon the observation of the instinct of birds, and there are many superstitions of the vulgar owing to the same source. For anglers in spring it is always unlucky to see single magpies, but two may be always regarded as a favourable omen ; and the reason is, that in cold and stormy weather one magpie alone leaves the nest in search of food, the other remaining sitting upon the eggs or the young ones ; but when two go out together, it is only when the weather is warm and mild, and favourable for fishing. (*Salmonia*, attributed to Sir Humphrey Davy.)

*Preserving Plants from the Caterpillar.* — An experiment has been tried for three years to preserve gooseberry plants from the ravages of the caterpillar, by brushing the stems with a soft brush dipped in common train or fish oil, about the time of their first appearance, or at any time when infested, which appears to destroy or greatly to annoy them. It also much improves the growth and productiveness of the tree the following year, and clears it of moss. This communication is made public, in the hope of exciting experiments to prove how far it may be useful for the preservation of other trees. (*New Monthly Magazine for August.*)

*An improved Mode of Paving* has been suggested, which may be shortly described, as placing the stones with the broadest surface undermost on a Macadamised foundation. This is nearly allied to the Roman practice of paving on a bed of masonry : indeed, the durability of all pavement depends on its being placed on a stratum of materials not liable to be changed by water, frost, or considerable pressure. An excellent pamphlet on the subject has been published by Col. Macirone. The plan first mentioned is by Mr. George Knight, and will be found accompanied by some very judicious observations on the adaptation of Macadamised roads for the chief thoroughfares of the metropolis in the *Journal of Science*, vol. 22. p. 264. About 1811 or 1812, we entered a caveat at the Patent Office, for a mode of paving on flag stones, or on cast-iron plates, combining a plan of laying the water and gas-pipes in drains

22

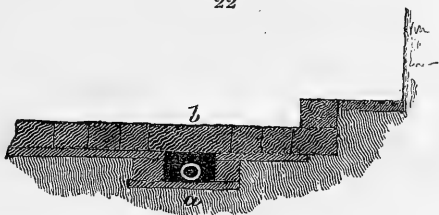

(*fig. 22. a*), covered with large stones, channelled on the surface *b*, to prevent horses from sliding. Access to the pipes might be had by simply lifting these stones, without disturbing any other part of the pavement. On mentioning our plan to some of the principal paviors, we found it would have to encounter such a host of interests and prejudices, that we paid no more attention to it. Being very much inclined to doubt the ultimate advantages of Macadamising the chief thoroughfares, we think the idea worth considering.

*Bettering the Condition of the labouring Poor.* — This subject, which has long engaged the best hearts, and some of the wisest heads in the kingdom, has been taken up with most benevolent ardour by Captain J. Pole, R. N. This gentleman has favoured us with a perusal of his very rational plan for reducing the poor rate, restoring the independence of the labourer, by placing him in a condition to maintain himself and family without parochial assistance, and consequently in comparative comfort.

This is by the often before recommended plan of letting every labourer who wishes it have a piece of land for the employment of his leisure

hours, to raise such vegetables as himself and family require; a plan which has been attended with the best effects in various places; and it is to be regretted that the practice is not more general. Captain Pole has entered into calculations the most obviously clear, that a labourer who costs the parish 11*l.* 14*s.* per annum, may be kept off it by paying for him, or giving him an opportunity of paying himself, a rent of 5*l.* for land. The principal difficulty in commencing such a system, is the unwillingness of old tenants to have their fields dismembered for the purpose. In new enclosures, or where landlords are disposed to throw some of their fields into allotments for the poor, the project is an easy, and doubtless a beneficial one for both the poor and the parish; and as the system is not intended to be compulsory, either on parishes or individuals, in accepting or rejecting it, the measure may be more palatable, as involving no change of laws or ancient usages. Captain Pole is supported in this scheme by several of the farmers, and many of the labourers of the parish of Barford, and, from what he knows of the place and peasantry, it seems a suitable station for such a trial.

In the statement before us, it is not contemplated that such allotments should pay either poor rates or tithes, nor is the fencing mentioned; and though such an arrangement may be allowed by local feelings and generosity, it is an advantage not to be expected everywhere. The scheme is one calculated only for the sober, industrious, well-disposed man: with the improvident and reckless character, no facilities of taking a piece of land, nor any injunctions as to the use he should make of the produce, will deter him from disposing of it as he pleases. Whatever may be the difficulties attending carrying such a plan of political economy and pure benevolence (so honourable to the projector) into effect, the object at which it aims, so highly important to the best interests of the kingdom, deserves the attention of every person of property in the land, and every friend to well-ordered society. — *J. M. for Cond.*

*Flesh-coloured Clover* (*Trifolium incarnatum* L.; *Farouche*, Fr.) (Vol. IV. p. 592.) — A valuable communication on this subject has been sent us, signed R. and D. The writer gives an extract from the *Annales Agricoles de Roville*, showing the high opinion M. de Dombasle has of this plant in poor, dry, sandy soils; and he also states the opinion of M. Schwertz, the late director of the agricultural establishment at Hochheim, near Stuttgart, where R. and D. saw the clover in the middle of April, 1828. We were at Roville in October last, and saw the clover in the form of hay, and the field where it grew; and M. Dombasle mentioned to us that he considered this species of clover better than any other leguminous hay plant for poor, dry, sandy soils. When we were at Hochheim in the November following, M. Schwertz had retired, and the new director having only arrived there from another part of the country within a few days; could give us very little information respecting the establishment. The flesh-coloured clover gives but one cut; but, upon the same soil, this one cut is equal to two of red clover. This one cut, also, comes earlier than either clover or lucerne; so that the same soil may be prepared for another crop the same year. A stock of seed has arrived in London, and may be had through any of the seedsmen; and we hope the plant will receive a fair trial in England. The communication signed R. and D. is sent to the *British Farmer's Magazine*; not that agricultural communications are altogether unsuitable for our work, for some have already been inserted; but, as a testimony of our regard for that periodical, and because we wish to be on the best footing with all our contemporaries. — *Cond.*

*The New Zealand Spinach* (*Tetragonia expansa*) is quite a weed with us; as, wherever it has once grown, plants rise spontaneously, even when the seeds have been wheeled out with the dung in the winter, and again

brought in as manure in the spring. I have now a full supply of it in my old pink-bed. *Coreópsis tinctoria* and *Cacàlia coccínea* are equally as hardy, and come up spontaneously in abundance. — *Mentor. Exmouth, Aug. 26. 1828.*

*Large Crop of Grapes and Peaches in the same House.* — Sir, In the peach-house at Buscat Park, the seat of Pryse Pryse, Esq. M.P., near Far-rington, Berkshire, is a vine trained up the rafters, which, last season, produced 584 good-sized bunches, with large berries, of Black Hamburg Grapes; the weight of the whole, 225 lb. The house is 60 ft. long, and, in the early part of the season, had produced a large crop of peaches. I am, Sir, &c. — *John Merrick, Gardener. Buscat Park, Nov. 10. 1828.*

*A Cucumber,* grown by Mr. Gummery, of Leech Street, Worcester, this year, when cut and fit for the table, weighed 6 lb. 5 oz., was 17 in. in length, and 20 in circumference. (*Worcester Herald.*)

*A Rhubarb Leaf* was plucked in a garden at Frampton, near Boston, in October last, which measured, across, 5 ft. 5 in. by 5 ft. (*Lincoln Merc.*)

*Leaf of a Hybrid Rhubarb Plant.* — Sir, In June last, I had occasion to pay a visit to W. Terry, Esq., of Sutton Coldfield, in whose garden, near that town, I observed some remarkably fine specimens of rhubarb; it was not the medicinal rhubarb (*Rhèum. palmàtum*), but of the kind now usually cultivated for culinary purposes, which, I have understood, is a hybrid plant. A lady of the party was so struck with the luxuriance of the plant, that she begged to take a leaf home with her. A leaf was accordingly gathered, together with its complete petiole, the weight and dimensions of which I had the curiosity to take the next day, and found to be as follows: — Weight of the whole leaf, 4 lb.; circumference, not including that of the petiole, 21 ft. 5 in.; diameter, 5 ft. 10 in.; length of the leaf, including the petiole, 5 ft. 2 in.; length of the petiole, 1 ft. 4 in. The leaf was not weighed till the day after it had been gathered; and, as the weather was hot, and the nerves had been cut through in several places, for the purpose of folding the leaf for more commodious carriage, it is probable it had lost something in weight by evaporation. — *W. T. Brce. Allesley Rectory, Nov. 17. 1828.*

*Rhubarb.* — I have seen in several gardens in Shropshire, a variety of *Rhèum*, I believe, quite different from any kind in general cultivation; it is called Buntingsdale Rhubarb.\* I was first attracted by the extraordinary size of the leaves. I have this day measured several leaves on one plant; four or five of them measured 2 ft. 8 in. by 2 ft. 4 in., exclusive of the petiole, or leaf-stalk; and some, I am told, grow to greater dimensions. — *J.M.*

*Agave americana, or American Aloe.* — There is now at Brislington, at the residence of Mrs. Susan March Phillipps, mother-in-law to the Bishop of Lichfield and Coventry (formerly the residence of the late Edward Rolle Clayfield, Esq.), a splendid *Agave americana*, which has thrown up a flower stem about 25 ft. high, having eighteen branches, which bear from 800 to 900 flower buds, and are expected to be in blossom in about ten or twelve days. The flower stem made its appearance about the 10th of June last, and has been increasing in height ever since. Mrs. Phillipps has a glass frame, 50 ft. high, erected over it, to facilitate its bloom, as likewise a staircase and platform, to approach near the height of the flowers, for the accommodation of visitors. This plant was brought to Brislington fifty-eight years since, by the late Abraham James, Esq., at whose death it became the property of the late Mr. Thomas Tipton; was a few years in the possession of the late Mr. Kinton; and thirty-eight years since it was made a present of to the late James

\* So called from the place where it was originally found; and I am informed that there are plants with leaves double the above size.

Ireland, Esq., in the possession of whose family it has remained ever since. (*Bath Chron.*, Sept.)

*Gigantic Hydrangea*. — There is at present in the garden of G. Sandes, Esq., at Dunowen, a hydrangea, which measures 45 ft. in circumference, is 7 ft. high, and had on its branches 176 flowers last season. (*Stockport Advertiser*.)

*An extraordinary Cowslip* has been picked in the garden of Mr. Sheriff Hornby, in Stockton Lane, near York. The stem, which has the appearance of six stalks grown into one, supports a head of flowers, comprising 114 pips. The stem itself was above 8 in. in length. Several other cowslips of unusual size were also growing from the same root. (*Newsp.*, Aug.)

*The Billardièra mutabilis* is hardy enough to endure a moderate winter like the last. — *Causidicus*. Nov. 24. 1828.

*A new Artificial Stone* has been invented by Mr. Ranger of Brighton, much harder than common stone or brick, being equal in durability to granite; and it has also the advantage of being considerably cheaper. It is capable of being modelled to any shape, and has, when put up, the appearance of Portland stone. Of course no cement is required in the construction of buildings in which it is employed. (*Scotsman*, Jan. 16.)

#### SCOTLAND.

*The Aberdeenshire Horticultural Society* held their last Competition Meeting on the 6th of November; on which occasion there were received 120 various packages for competition, viz. twenty-nine of apples, sixteen of pears, fourteen of onions, nine of beet, eleven of carrots, fourteen of celery, eight of one and six of two year-old forest trees, two of 'naturalised plants, and eleven various articles for the extra premium. The judges awarded the Society's silver medal to William Dawnie, gardener to Henry Lumsden, Esq., Invery, for onions, they being the articles possessing the greatest merit of any at the Show. They also awarded premiums for the best pears (the Crassane), to Alexander Crombie, Esq., of Phesdo. Best carrots, and second best celery, George Forbes, Esq., of Springhill. Also, apples (the Ribston Pippin): 1. Alexander Brown, at Heathcot; 2. Wm. Chalmers, at Lochhead. Second best pears (the Brown Auchan), John Davidson, at Dunnottar House. Second best onions, Alexander Diack, Mile End. Best red beet, William Barron, at Blackhall. Best celery, William Smith, at Grandholm Cottage. Second best carrots, from seeds saved by himself, Alexander Malcolm, Damside. Forest Trees: best one-year-old, Alexander Fraser, jun., Ferryhill nursery; best two-year-old, John Roy, jun., nurseryman and florist.

Nothing was awarded either for naturalisation, or to those articles offered for the extra-premium; but there were amongst them some beautiful specimens, particularly a handsome plant of the *Fuchsia coccinea*, raised in the open ground at Fetteresso Castle. An elegant plant of the *Datura arborea*, or Tree Stramonium, from Cornhill; a coxcomb, from Glenbervie House, measuring 4½ ft. high, the flower 8 by 10 in.; and five various gourds, of beautiful colours, and in the most perfect state, from the gardens at Arbuthnot House.

Two medals were awarded to the amateur subscribers who had kept their gardeners for the longest period, the one to Lady Burnet of Leys, for the gardener at Crathes, George Hardy, who had been twenty-eight years in the service of the family, without having had any charge of hot-houses. The other medal to R. W. Cuff, Esq., of Fetteresso, for William Wales, he having for the period of twenty-two years practised all the branches of the art, including hot-houses.

The London Horticultural Society's silver medal, voted last season to Mr. Alexander Diack, at Mile End, was presented to him on this occasion.

The following were admitted new members:— W. C. Hunter, Esq., of Tillery; Henry Lumsden of Tilwhilly; Thomas Wilson, Esq., Clinterty; and Messrs. George Knight and Isaac Machray, Aberdeen. (*Aberdeen Jour.*, Nov. 19.)

*Pine-apples and Melons.* — The Horticultural Society of Edinburgh have lately awarded a prize to Colonel Patterson's gardener at Cunnockhie, for some fine fruit of this description produced by means of steam. The pit in which they were raised is contrived in a very ingenious manner to obviate the inconvenience of too rapid changes of temperature, which are sometimes felt when steam is applied in hot-houses. In this case, the chamber in which the vapour is collected for supplying the bottom heat, instead of being empty, and on that account quickly heated and quickly cooled, is filled with small round stones, which absorb the heat as it is produced, giving it out gradually and retaining it long; producing, by application of the steam for an hour and a half in the evening, an equable heat through the whole of the night and next day. The steam is distributed through this chamber by means of a cast-metal tube, perforated at certain distances; and it may also be admitted at pleasure amongst the plants above, by means of tubes with movable caps communicating with the same receptacle. The idea is, we believe, due to Mr. John Hay, of Edinburgh; but Colonel Patterson is the first amateur who has carried it into practice. The beauty of the fruit, and the neatness of the whole apparatus (so different from the usual appearance of melon frames), seem to point it out as one of the most eligible modes yet discovered for securing to this country the productions of the tropics. (*Fife Herald.*)

*Crops on Moss Soil.* — As an instance of what crops can be produced from the moss grounds in the neighbourhood of Paisley, under proper management, we may mention that a field of  $1\frac{1}{2}$  acres, sold by the magistrates and town council to William Cochran, weaver, in 1780, for 45*s.*, and 8*s.*  $8\frac{1}{2}$ *d.* of yearly feu-duty, was reaped on the 19th of October, and yielded the following excellent crop of wheat, viz, fifty-four stooks, containing fourteen sheaves in each stook. The sheaves stand upwards of 6 ft. in height, and the heads are remarkably well filled and heavy. The field was in hay in 1827, it was summer fallowed and manured with 12 cwt. of salt, thirty carts of short dung, and 300 carts of earth. It is the property of Mr. Pattison, and it lies immediately to the north of Mr. Bell's cottage of Mossvale. (*Paisley Advertiser.*)

*A turnip*, on the glebe of Longformacus, of this year's growth, was lately taken up, which measured 5 ft. 2 in. in circumference, and weighed 20 lb. In the same field there were many of a very large size. (*Scotsman*, Nov. 29.)

*Huge Gourd.* — During the week, a huge gourd has been exhibited at the door of Messrs. Boyd and Bayne, fruiterers, Prince's Street, which has attracted considerable attention from the amateurs of large natural productions. It measures 6 ft. 5 in. in circumference, and weighs upwards of 112 lb. This is, no doubt, the largest gourd ever grown in Scotland, and a number of naval, military, and commercial gentlemen who have examined it, state that, even in the West Indies, the native place of the gourd, one so large is rarely seen. (*Scotsman*, Oct. 11.)

*Gigantic Sweet Myrtle.* — Fourteen years ago, Miss Gilmour, of Craigmillar, planted a myrtle at the garden wall, on a finely sheltered spot with a southern exposure. Mr. David Stewart, gardener, has continued since to pay considerable attention to this plant, and it has flourished far beyond his expectations. By an accurate measurement made on Wednesday afternoon, it was found to be 7 ft. 9 in. in height, and the side shoots extend 16 ft. 10 in. along the wall. Some horticulturists, well skilled in these matters, consider this by far the largest myrtle ever grown in Scotland in the open air. (*Scotsman*, June 28.)

*Produce of Bees at Brechin.* — From one swarm of bees, on the farm of

Leuchland, in this vicinity, no less than nine pints of honey have been taken this season, without destroying these industrious insects. After robbing them of their luscious nectar, it was found advisable to send them to the heather; and it seems they had some prescience of their destination; for, on examining the hive the other day, it was found to contain an ample supply for the ensuing winter. The honey was taken at three different times, by means of a top which can be separated from the main body of the skep; under this top a board is fixed horizontally upon the frustrum, with a perforation in the centre of about 3 in. diameter, through which the bees pass to the upper story. The first top which is taken off contains wax so subtle that it vanishes at the touch, and honey as transparent as amber. Bees never begin to breed until they have collected a certain quantity of honey; and the above method, of course obviates that procedure. (*Scotsman*, Sept. 17.)

*Phórmium ténax*. — I have two very fine plants of the *Phórmium ténax*, or New Zealand Flax, which succeed remarkably well with me; they require no shelter in winter, and have not even the protection of a wall. It is closely bordering on the sea, and I presume the marine atmosphere tempers the adjoining air incumbent over the land. — *J. M. Inverness-shire*.

#### IRELAND.

*Landscape-Gardening and Forest-Management*. — We are glad to learn, that our friend and correspondent Mr. James Fraser, now of North-east Street, Dublin, has publicly assumed the above professions. From what we know of his science and experience, and of his manner, we are almost sure he will be successful; and of this we shall be the more happy, because, since the death of our lamented pupil and friend, Mr. M<sup>r</sup>. Leish, such a man as Mr. Fraser will be of real public utility. Public tranquillity, personal residence, and the advice followed of a few such men as Mr. Fraser, would soon supply all that is wanted for Ireland, in forest-planting and landscape-gardening. In the midst of these occupations, we hope Mr. Fraser will never forget, where he can do it without giving offence (because, in such cases, advice would be useless), to urge the advantages that would result to proprietors from establishing infant schools on their estates, and, at the same time, parochial schools, so as to elevate the character of the rising generation. We request Mr. Fraser to consider what has appeared on this subject in the Reviews of Slaney, and in other articles in this Magazine; and in our notes from Germany, in No. V. of the *Magazine of Natural History*. Bavaria and Wurtemberg are entirely agricultural countries like Ireland; they are exceedingly poor, but they are almost totally without beggars and criminals, or civil prisoners; the lowest individual among them is enlightened; and the whole are, from all external appearances, happy. It appears to us that these countries are models for Ireland. — *Cond.*

*Schools*. — By an extract from the Report of the Hon. the Irish Society's Institution, under the patronage of the Corporation of London, May 5, 1827, which has been obligingly sent us, we are much gratified to learn that the number of schools and persons attending them are increasing.

In connection with these schools are also formed *school libraries*, which have proved eminently useful both to parents and children; the latter who can read, thus becoming the instructors of those who cannot read.

There are *girls' schools*, as in Germany, in which children are taught the usual branches of education, and also to work; and, what we particularly admire in the schools established by this Institution, "peculiar religious instruction" is altogether avoided. If the propriety and importance of this exclusion, in every school in every country, were once generally understood and acknowledged, it would be easy to spread instruction over the whole earth; to raise all mankind to a level, in point of general useful knowledge; to reduce all the living languages of the world to one or two; to bring into use every

where the same measures of number, quantity, time, &c.; and to maintain social order in every separate Government, in a great measure, by the force of opinion. — *Cond.*

ART. III. Covent Garden Market.

PRICES FOR THE FIRST AND SECOND WEEKS OF JANUARY.

	From		To			From		To		
	£	s. d.	£	s. d.		£	s. d.	£	s. d.	
<i>The Cabbage Tribe.</i>										
Cabbage, Red, per dozen	0	4	0	6	0	0	3	0	0	0
Cabbage Plants, or Cole-worts, per dozen	0	2	0	3	0	0	0	0	0	0
Savoy, per dozen	0	0	6	0	1	0	0	0	0	0
German Greens or Kale, per dozen	0	0	6	0	0	0	0	0	0	0
Broccoli, White, per bunch	0	1	0	2	6	0	2	0	0	8
Broccoli, Green, per bunch	0	1	0	1	6	0	1	0	1	3
Broccoli, Purple, per bunch	0	1	0	1	6	0	1	6	0	2
Broccoli, Cape, per bunch	0	1	0	0	1	6	0	0	0	1
<i>Tubers and Roots.</i>										
Potatoes, { per ton	3	0	0	4	10	0	0	0	0	10
{ per cwt.	0	3	6	0	5	0	0	0	0	10
{ per bush.	0	2	0	0	2	6	0	0	0	1
Potatoes, Kidney, per bush.	0	2	0	0	3	0	0	0	0	6
Scotch, per bushel	0	2	0	0	2	6	0	0	0	0
Turnips, White, per bunch	0	0	1	0	0	2	0	0	0	0
Carrots, Old, per bunch	0	0	4	0	0	6	0	0	0	6
Parsneps, per dozen	0	0	6	0	0	9	0	0	0	9
Red Beet, per dozen	0	0	6	0	1	0	0	0	0	0
Scorzoner, per bundle	0	2	0	0	2	6	0	0	0	6
Salsify, per bunch	0	2	0	0	2	6	0	0	0	6
Horseradish, per bundle	0	1	6	0	3	0	0	0	0	3
<i>The Spinach Tribe.</i>										
Spinach, { per sieve	0	0	9	0	1	3	0	0	0	9
{ per half sieve	0	0	6	0	0	9	0	0	0	9
Sorrel, per half sieve	0	1	0	0	1	6	0	0	0	1
<i>The Onion Tribe.</i>										
Onions, Old, per bushel	0	3	6	0	5	0	0	0	0	0
Leeks, per dozen bunches	0	0	8	0	1	0	0	0	0	8
Garlic, per pound	0	0	6	0	0	8	0	0	0	8
Shallots, per pound	0	0	6	0	0	8	0	0	0	8
<i>Asparagus Plants, Salads, &amp;c.</i>										
Asparagus, per hundred	0	8	0	0	12	0	0	10	0	14
Sea-kale, per punnet	0	2	0	0	5	0	0	0	9	0
Cardoons, per bunch (three)	0	4	0	0	4	6	0	6	0	14
Lettuce, Coss, per score	0	0	6	0	1	0	0	2	6	0
Endive, per score	0	1	6	0	2	0	0	2	6	0
Celery, per bundle (12 to 15)	0	0	8	0	1	3	0	16	0	1
<i>Small Salads, per punnet.</i>										
Watercress, per dozen, small bunches	0	0	0	0	0	0	0	0	0	0
<i>Pot and Sweet Herbs.</i>										
Parsley, per half sieve	0	2	0	0	3	0	0	2	0	0
Tarragon, in pots	0	0	6	0	0	8	0	0	0	8
Thyme, per dozen bunches	0	1	0	0	1	3	0	1	6	0
Sage, per dozen bunches	0	1	6	0	0	2	0	1	6	0
Dried Mint, per doz. bun.	0	0	0	0	0	1	0	0	0	0
Dried Marjoram, per dozen bunches	0	0	0	0	0	10	0	0	0	10
Dried Savory, per doz. bun.	0	0	0	0	0	10	0	0	0	10
Dried Basil, per doz. bun.	0	0	0	0	0	1	4	0	0	4
Rosemary, per doz. bunch.	0	0	0	0	6	0	0	0	6	0
<i>Stalks and Fruits for Tarts, Pickling, &amp;c.</i>										
Rhubarb Stalks, per bundle	0	0	0	0	1	6	0	0	0	1
<i>Edible Fungi and Fuci.</i>										
Mushrooms, per pottle	0	0	6	0	1	0	0	0	6	0
<i>Fruits.</i>										
Apples, Dessert, per bushel	0	16	0	1	10	0	0	16	0	1
Apples, Nonpareils, p. bush.	0	16	0	1	10	0	0	16	0	1
Apples, Reinette Grise, p. b.	0	14	0	0	18	0	0	14	0	0
Apples, Scar. Pearmain, p. b.	0	14	0	0	18	0	0	14	0	0
Apples, American, per bus.	1	0	0	1	10	0	0	1	0	0
Apples, French, per bushel	0	8	0	0	12	0	0	8	0	0
Pears, Bon Chrétien, per half sieve	0	0	0	0	1	0	0	0	0	0
Almonds, per peck (dry)	0	0	0	0	7	0	0	0	0	0
Cranberries, per gallon	0	0	0	0	4	0	0	0	0	0
Chestnuts, French, per peck	0	2	6	0	10	0	0	2	6	0
Pine-apples, per pound	0	5	0	0	12	0	0	5	0	0
Oranges, { per dozen	0	0	6	0	2	0	0	0	6	0
{ per hundred	0	3	6	0	16	0	0	3	6	0
Bitter Oranges, per hundred	0	10	0	0	14	0	0	10	0	0
Lemons, { per dozen	0	0	9	0	2	0	0	0	9	0
{ per hundred	0	6	0	0	14	0	0	6	0	0
Sweet Almonds, per pound	0	2	6	0	8	0	0	2	6	0
Brazil Nuts, per bushel	0	16	0	1	0	0	0	16	0	0

*Observations.* — The supply of vegetables has hitherto been very regular, and very little fluctuation in price has taken place. Our supply of English fruit has been unprecedentedly small, but from the very great importation of foreign fruits, the prices have remained steady and moderate. But few American apples have come to hand, and those in bad condition, consequently the prices may be considered nominal. Oranges, nuts, and chestnuts in their usual abundance. — *G. C. Jan. 17. 1829.*

ART. IV. Horticultural Society and Garden.

*OCTOBER 21. — Exhibited.* A head of Cape Broccoli, from Mr. William Boyce, gardener to Colonel Kingscote, of Kingscote, Gloucestershire. Jerusalem Sweetwater Grapes, from the Rev. Dr. Vansittart, of Maidenhead. Eight sorts of Flowers, and an Apple unnamed, from Robert Barclay, Esq. F.H.S. Four sorts of Pears and eight sorts of Apples, from Mr. John



George Fuller, F.H.S. Monstrous Pear, from John Robert Hall, Esq. F.H.S. Hambledon deux Ans Apple, from the Rev. Frederick Beadon, F.H.S. Golden Pippin, and Forman's Crew Apple, from Richard Forman, Esq. F.H.S.

*Also, from the Garden of the Society.* An Enville Pine-apple, four sorts of Pears, thirteen sorts of Apples, *Passiflora maliformis* (Sweet Calabash), and *quadrangularis* (Granadilla). Flowers of *Gilia capitata*, *Ænothera Lindlèyi* and *viminea*, *Lupinus ornatus* and *plumosus*, *Tagètes lucida*, *Clárkia pulchélla*, *Collòmia grandiflòra*, *Coreòpsis tinctòria*, *Verbèna Aublètia*, *Agératum mexicànum* and *odoratum*, *Hibiscus africanus*, Poppy Anemones, and French Marigolds.

*November 4. — Read.* On the mode of Planting Trees at equal distances from each other; by Sir George Steuart Mackenzie, Bart. F.H.S. An account of the Coul Perennial Kail, and of a valuable property of the Vanack Cabbage; by Sir George Steuart Mackenzie, Bart. F.H.S.

*Exhibited.* Two Spanish Onions, weighing 2 lb. 11 oz., by Mr. Thomas Shailer, of Chelsea. A plant in flower of *Cattlèya labiata*, from William Cattley, Esq. F.H.S. A plant in flower of *Hedýchium Gardnerianum*, from the Comte de Vandes. A Pine-apple, raised from seed of the Queen Pine, and a Seedling Grape raised between the Scotch Hamburg and Muscat, from Mr. Thomas Deuxberry, gardener to the Rev. S. A. Rhodes, of Horsforth Hall, near Leeds. Ten sorts of Apples and Duchesse d'Angouleme Pears, from Mr. Peter Langellier, C.M.H.S. Northwick Pippins, from Mr. Fulton, gardener to Lord Northwick. Reinette Blanche, from Daniel Edward Stephens, Esq. F.H.S. Four sorts of Apples, from Mr. William Malcolm, F.H.S. Two sorts of Pears, from Mr. John Rutherford, of Sherborne Castle, Dorsetshire. Uvedale's St. Germain Pear, from Alderman Smith, F.H.S.

*Also, from the Garden of the Society.* An Enville Pine-apple, *Passiflora quadrangularis*, twelve sorts of Apples, seven sorts of Pears, eight sorts of Beet. Flowers of *Collòmia grandiflòra*, *Gilia capitata*, Poppy Anemones, French Marigolds, and eight sorts of Chrysanthemums.

*Rejection of the Gardener's Magazine.* — The first letter which we received from our office at Bayswater, after our arrival in Paris, contained the following, from the journal kept there: — "August 29th. Received a letter from the Horticultural Society, together with the last Number of the Gardener's Magazine, the Council 'conceiving that they would be wanting in all due feeling towards the respected President, were they to accept as a present to the library of the Society, a publication in which such reflections on that gentleman and his writings, published in the *Transactions* of the Society, exist, as will be found at page 284. of the book in question." They have refused me the last Meeting." — "This day, Friday, August 5., I went into town to the Horticultural Society again, and after waiting a long time, I saw the Librarian, who refused to let me have the Meetings (as I said before), stating that Mr. Sabine had told him not to let me have them." A note from us, dated Paris, Sept. 9., addressed to the Secretary, requesting he would "permit our amanuensis to copy the account of the Meetings of the Horticultural Society from the extract suspended in the meeting-room; (conceiving that, as a Fellow of the Society, we were entitled to make this request under the circumstance of personal absence)," procured the extracts which we have printed in our two former Numbers.

We shall now state the offensive passage in the "book in question" at length, and add a copy of the Council's letter.

"June 5.—*Read.* Upon the management of Borders for fruit Trees; by Mr. James Housman. An account of an easy method of destroying Caterpillars; by Mr. Richard Williams, gardener to Thomas Andrew Knight, Esq. F.R.S. &c. President. [We are very happy to learn that Mr. Knight has thought it worth while to keep a gardener who can not only read, but

write. Mr. Knight, by showing the utility of general knowledge to gardeners, and advocating the cause of garden libraries as the means for acquiring this knowledge, might do more for the advancement of horticulture, than by all the practical papers that he has ever written, or ever will write. Among practical gardeners these papers go for nothing, and deservedly so; for what is the result of all that Mr. Knight has stated in regard to the culture of the pine-apple, the strawberry, or the mango? Are we one step advanced in consequence of these papers? It is in physiological experiments that Mr. Knight excels, and it gives us pleasure to state, that by these he has established his reputation far beyond the reach of our praise or blame.]

The following is the letter of the Council \*:—

“ *Horticultural Society, Regent Street, London, August 28. 1828.*

“ The Council of the Horticultural Society have directed that the last Number of the Gardener’s Magazine shall be returned to Mr. Loudon, conceiving that they would be wanting in all due feeling towards their respected President, were they to accept, as a present to the Library of the Society, a publication in which such reflections on that gentleman and his writings, published in the *Transactions* of the Society, exist, as will be found at page 284. of the book in question. The Council have further to observe, that these reflections are introduced into a statement officially communicated, by order of the Council, to Mr. Loudon, and they do unhesitatingly declare their opinion that the assertion of the inutility of Mr. Knight’s papers is decidedly unfounded and untrue.”

The offensive passage in the brackets we wrote in the margin of the proof, having in truth not read over the MS. account of the Meetings before it went to press. Had we seen a revise, it is possible we might have modified the expressions; and certainly we regret that we have not done so, for we have a very great personal regard for Mr. Knight. It is impossible to be in his company without feeling him to be a benevolent and most ingenious man, and in so far as we have hurt his feelings by the above passage we are sincerely sorry.

Speaking of Mr. Knight as a cultivator, however, and of his practical papers in the *Transactions of the Horticultural Society*, we cannot retract one word of what we have asserted. We stated nearly the same opinion in a sort of historical treatise on the culture of the pine-apple, published some years ago (*Encyc. of Gard.*, p. 1112., A. D. 1803, 10.); and every subsequent paper that Mr. Knight has written, and especially his latter papers on the pine-apple and mango, confirm us in our opinion. We leave our readers and time to decide between our unhesitating opinion, and the unhesitating opinion of the Council of the Horticultural Society, and we are not afraid of the decision. What tempted us to write the paragraph at all, was the

---

\* Thomas Andrew Knight, Esq. F.R.S. F.L.S., President.  
 Edward Barnard, Esq. F.L.S., Vice-Secretary.  
 Henry Moreton Dyer, Esq. Vice-President.  
 John Elliot, Esq. F.R.S. F.L.S., Vice-President.  
 Alexander Henderson, M.D., Vice-President.  
 Robert Henry Jenkinson, Esq. F.L.S., Vice-President and Treasurer.  
 Mr. John Lee, Nurseryman.  
 Mr. George Loddiges, F.L.S.  
 Mr. William Malcolm, F.L.S.  
 Roger Pettiward, Esq. F.R.S. F.L.S. &c.  
 Joseph Sabine, Esq. F.R.S. F.L.S., Secretary.  
 Marquess of Salisbury.  
 Sir Claude Scott, Bart. F.L.S.  
 Alexander Seton, Esq.  
 Alexandre Comte de Vandes.

recurrence to our mind that Mr. Knight, now employing a writing gardener, had formerly boasted (it may be called) of growing pine-apples in a far superior way to those generally grown by professional gardeners, by a man who "neither knew a letter nor a figure." Aware of the influence of Mr. Knight's opinion on every subject connected with gardening, and convinced that nothing can have a greater tendency to retard the progress of that art, or any other, than ignorance in operators, we directed some observations against the passage, in the Preface to the first edition of our *Encyclopædia of Gardening*, and have since maintained and supported an opposite theory. Our offence has proceeded from having felt rather too much delighted to have the evidence of Mr. Knight's present practice to prove that he was formerly wrong, and that we were and are right. So much with reference to Mr. Knight.

As to what is called the Council of the Horticultural Society, the majority of our readers, and, at any rate, all of them who participate in our ideas of the direction of the Horticultural Society, know very well that their opinion as to any thing we do or say, is to us a matter of the most perfect indifference. A sincere wish that the Society might do that good which its immense funds should enable it to do, once led us to hope that we might introduce a reformation in its management; but we soon found that we could not do this without rendering ourselves obnoxious to a by-law, which would immediately lead to our ejection from the Society. The first step which we should take in such a case would be, to obtain a list of the names of the members who *attended* at all the councils and committees that had been held since the commencement of the garden at Chiswick, or even for any one year since. We attempted this for only three meetings of Council in 1826, in consequence of some petty annoyances which we then experienced; and, after first requesting to be informed of the names of the members of the Council who attended on certain fixed days, and being refused, and next applying "for the liberty of inspecting the order-book, minute-book, &c., in conformity with chap. 21. § 7. of the By-Laws of the Society," we were informed, first, that our letter would be laid before the Council, and, in three weeks afterwards, we received the Council's answer, viz. "that the acts of the Council being the acts of the whole, it is quite unnecessary to furnish you with the names of individuals present at any particular meeting; and that there does not appear any reasonable ground for acceding to your request to inspect the proceedings, as the whole of the minutes of the Council, in reply to all your applications, have been already communicated to you." The evasion of this answer is easily seen; but even if we had attained the object required, or were now in possession of a list of the members of Council *who have attended at the different meetings* held in any one year, the next step which we should take would subject us to exclusion from the Society (so admirably are its laws constituted for the protection of abuses), in consequence of a certain law (chap. 6. § 1 & 3.) by which any person who writes or prints "any thing to the damage, detriment, or dishonour of the Society," shall be ejected, and "rendered incapable of belonging to it in future." As it would be inconvenient to us not to belong to the Society, on account of its library, however much we might desire its reformation we do not consider ourselves called upon to sacrifice our own interest for such a result, and therefore we leave *what is called* the Council and the Society to the effects of time.

We appeal to all our readers, whether the different papers which have appeared in this Magazine respecting the Horticultural Society, do not show that our object has been to rescue it, if possible, from a contracted illiberal system of management, and to render it more truly grand and useful.\* We

---

\* We are ready at any time to state a number of petty annoyances, which we have received from the Council and Secretary, respecting the library,

have blamed where we thought blame was due, and approved in like manner. The offensive passage itself will be found to be of this description; and we shall take care that nothing in the present article may be construed by the Council in such a way as to tend to the expulsion of the Conductor, in addition to the ejection of his Magazine, by submitting it to a legal adviser, along with a copy of the laws and by-laws of the Society.—*Cond.*

---

ART. V. *Provincial Horticultural Societies.*

NORTHUMBERLAND AND DURHAM.

A GENERAL Meeting of the Botanical and Horticultural Society of Durham, Northumberland, and Newcastle-upon-Tyne was held in Newcastle on November 14., when the following prizes were awarded:—The Society's silver medals, for the best dish of dessert apples, to Mr. John Moderill, gardener to Mr. Anderson, Point Pleasant; for the best dish of grapes, to Mr. Clarke, gardener to Mrs. Bewicke, of Close House; for the best dish of dessert pears, to Mr. Cook, gardener at Bradley Hall; for the best bouquet of flowers, to Mr. Scott, gardener to Edward Charlton, Esq., Sandhoe; and for the best twelve *Chrysanthemum indicum* flowers, to Mr. Lawson, gardener to Matthew Beli, Esq. M.P., Woolsington. The Society's bronze medals, for the best six roots of salsify, and six roots of scorzonera, to Mr. Chris. Robson, gardener to Dr. Headlam; for the best six roots of rampions, also for the twelve largest onions, and also for the best four heads of Brussel sprouts, to Mr. Robert Turnbull, gardener to the Rev. Mr. Ogle, Kirkley; and for the best six roots of Hamburg parsley, to Mr. Scott, of Sandhoe. A specimen of hemp, grown in the prison yard at Durham, and some rope manufactured therefrom by the prisoners, were exhibited by Mr. Frushard, the governor, and the hemp was considered to be of very fine quality. A beautiful plant of the *Cactus truncata*, in full flower, from the garden of J. G. Clarke, Esq., was universally admired; and the different bouquets of flowers, particularly the prize one, were most elegant, and in great splendour, notwithstanding the late severe weather. There was a dish of full-grown peas, from the garden of Mr. Joshua Watson, of Bensham, which were raised from seed that had been produced and sown again this year; and, as a proof of the mildness of the autumn, there were some blossoms and fruit (the second crop) of Jargonelle pears, from the garden of A. J. Cresswell Baker, Esq.; and a second crop of apples, of a good size, from the garden of Mr. Joseph Grey, at Bensham. Mr. Anderson, of Point Pleasant, sent twelve of the largest Portugal onions we have ever seen, which weighed 16 lb. A dish of seedling apples, raised by Mr. Boiston, of Heworth, and called the Heworth Pippin, were also very fine; and, indeed, upon the whole, we have seldom been so much pleased as we were with this exhibition; the number, variety, and excellent preservation of the apples and pears being really extraordinary. A very

---

the meetings, and the garden, since commencing the Gardener's Magazine, and to prove them by written documents; and were it not for occasioning unpleasant feelings to a gentleman in Paris, we could refer to one whose name is in the list of Council just given (p. 88.), who, besides generally prejudicing our character and that of the Magazine, prevented us from receiving the plan and description of one of the first gardens in Paris, after they had been prepared for us by the proprietor. We could add a word, too, as to Munich; but one word in that case would be too much. A liberal public body, having the same object in view as ourselves, would have acted towards us in a very different manner, even if we had not deserved it.—*Cond.*

numerous assemblage of ladies and gentlemen were present, who were highly gratified; and this being the last show for the year, we must bear testimony to the very great attention that has been shown by the committee in their judicious arrangements. The list prepared by them for the ensuing year promises to every lover of botany and horticulture a most exquisite treat. There were some new members elected; and we trust to see their numbers very much increased, as the good that has already been accomplished by this Society is incalculable, in the spirit of emulation that has been excited among the subscribers. (*Newcastle Courant*, Nov. 22.)

## LANCASHIRE.

*Manchester Botanical and Horticultural Society.* — We regret exceedingly that owing to our absence from London, we could not pay proper attention to a communication forwarded to us by the Honorary Secretary of this Society, nor is there now (Jan. 21.) time to do so before this Magazine goes to press; but we shall write to the Secretary at our earliest leisure moment. — *Cond.*

*Floral and Horticultural Society of Manchester.* — Sir, It has often been matter of surprise to me that the transactions of our Floral and Horticultural Society here have never been (if I am not mistaken) noticed in your Magazine. We have had five exhibitions during the present year, some of which I should have thought equal to those of neighbouring towns, and equally worthy of mention. I observe that the transactions of the Liverpool, Rochdale, and Bolton Societies are recorded, and why should not those of Manchester be so too? Yours, — *Coronilla. Manchester, November 3. 1828.*

We insert the transactions of all Provincial Societies that are sent to us, either in MS., or, which we prefer, in the local newspaper containing the accounts of such transactions. We shall be most happy to insert those referred to, if Coronilla, or any other person, will send them to us, for we cannot spare time to search for them in files of provincial newspapers ourselves. — *Cond.*

## WORCESTERSHIRE.

*Vale of Evesham Horticultural Society.* — At a Meeting of the Committee, held on Oct. 10., the London Horticultural Society's medal, presented to this Society, was awarded to Mr. George Fulton, gardener to the Right Hon. Lord Northwick, of Northwick Park, for his various exhibitions at the several Meetings of this Society during the present year, of fruits, plants, and culinary vegetables, of peculiar excellence and flavour; as well as for his communications, read to the Society, on keeping a Fine Bloom on Cucumbers, and on the Culture and Management of the Vine in the Pinery.\* The Committee took into consideration the exhibitions and

---

\* If such papers are not destined for the London Horticultural Society, or for being published in Worcestershire, we should be very happy to receive them. Of this we are quite certain, and a little reflection will bring every intelligent and candid reader to our opinion, that if the papers of all the Gardening Societies in the empire were published and left open to discussion in some such journal as ours, they would more effectually contribute to the advancement of science than they ever can do in separate transactions or memoirs. The Societies would also save money by such a practice, which might be applied to the support of their gardens or libraries. But the question is, whether the patriotism of such Societies has yet reached that point which is necessary for such a state of things, or rather, we should say, the patriotism of their leading members? We recommend the subject to the consideration of the Horticultural Societies which are formed, or which may be formed, in North America. The mass of books and periodicals that are happily accumulating so fast in both worlds on

communications from Mr. Jessop, of Cheltenham, and others, and returned their thanks for the same, and request their farther favours.

The Committee have reason to congratulate the members of the Society, on the success which has attended its progress, and they acknowledge the active support, zealous cooperation, and valuable communications of their learned president, Edward Rudge, Esq.; and also the assistance and special exertion of the officers, in promoting the general objects of the Society.

At a General Meeting of the Society, held the same day, the following gentlemen were elected for the year ensuing:—

President: Edward Rudge, Esq. F.R.S. A.S. and L.S. Abbey Manor House.—Committee: G. H. Anderson, Esq., Salford; Rev. Hugh Carletan, Arrow; Col. Davis, M.P.; Mr. Davis, Pershore; J. Eddy, jun., Taddington; Mr. Hunt, Pershore; Mr. Izod, Evesham; Hon. H. B. Lygon, M.P.; Thomas Marriott, Esq., Avon Bank; Mr. A. New, jun., Evesham; W. F. Preedy, Esq., Offenham; Edw. Protheroe, Esq. M.P.; Rev. D. J. Perkins, Broadway; Thos. Purton, Esq. F.L.S., Alcester; Rev. W. S. Rufford, Binton; J. Racster, Esq., Pershore; E. J. Rudge, Esq., Evesham; Rev. J. Shaw, Bengworth; Rev. G. Shute, Littleton; H. Strickland, Esq., Cracombe; Mr. Savage, Evesham; Sir Charles Throckmorton, Bart.; John Thorp, Esq., Evesham; and Mr. Valencourt, Pershore.—Treasurer: Mr. John Mayfield, Bengworth.—Honorary Secretaries: Mr. John Home, and Mr. John Bonaker.

It was ordered, that the List of Subscribers, and Rules, as amended for the year 1829, be printed, and delivered to the members of the Society. (*Worcester Herald*, Nov. 15. 1828. Received in MS.)\*

#### SUFFOLK.

*The Bury Horticultural Society* held their second Meeting on Nov. 18th, The show of fruits and vegetables was excellent, and the Chinese Chrysanthemums exhibited by Mr. Barret, gardener to the Rev. T. G. Cullum, of Hardwicke, some of them measuring nearly 8 in. in diameter, were the objects of especial admiration. The great room, in which the display was made, was crowded with company till the hour appointed for the judges to commence their examination. The judges were Mr. W. Adams and Mr. Wright, for the fruit; Mr. C. Adams and Mr. Woollard, for the flowers and vegetables; and their award of the prizes was as follows:—

*Fruit.* Grapes. White (Muscadine), Mr. C. Adams, Barton. ... Black (Black Prince), Mr. Marriott, Stowmarket. — Plums (Imperatrice), Mr. Barrett, gardener to the Rev. T. G. Cullum.—Table Pears (Colmar), Mr. Barrett.—Table Apples, Mr. Barrett.—Kitchen Apples (Doncaster Pearmain), John Buckle, cottager, of Rougham. — Best fruit grown by a cottager (Winter Apple), J. Buckle. — Seedling Apple, Mr. Jonathan Lock, Rushbrooke. —

almost every subject, would thus stand less chance of being merely repetitions. We should like to see a horticultural society of the whole world established, to hold meetings once a year, by deputations from all the subsocieties of the world; the meetings to be held, in rotation, in the capitals of all the leading governments of the world. We have suggested the idea in our *Magazine of Natural History* (vol. i. p. 476.), in our notes from Ratisbon, for a similar literary republic of the whole world; and, on our return to Paris from Germany, in December last, we were agreeably surprised to find that the same idea had been in contemplation there for some time, and is about to be made public. — *Cond.*

\* Henceforth we mean to make this distinction; because it may often happen, that in printing from such MS. the proper names will not be spelled in the same way as in the original newspaper. We greatly prefer having the newspaper itself sent to us. — *Cond.*

Winter Melon, Mr. Lines, gardener to N. L. Acton, Esq. — Filberts, gathered in 1826, Mr. Lines. — Baking Pears, Mr. Levett, Rougham. — *Culinary Vegetables*. Cauliflowers and Celery, Mr. Hammond, gardener to Sir H. Bunbury. — Endive, Mr. Wright, gardener to Lord Calthorpe. — Broccoli, Mr. William Barret. — Potato (Cambridge Kidney), eight weighing 12 lb., and a sack and half being grown on a rod, the Rev. Mr. Dewhirst. — *Flowers*. Chrysanthemum in a pot (Tasseled Yellow), and best six blooms, Mr. Barrett. — Bouquet of hardy Flowers, Mr. Lord, gardener to the Rev. James Cullum. — *Plant*. *Justicia speciosa*, R. Bevan, Esq.

Of these productions the winter melon appeared to excite great curiosity, and was considered a most valuable species, the flavour being very fine, and the fruit keeping as late as the month of February; the plant, moreover, being rather hardy than otherwise, and a free bearer. The form of the fruit is as near to the cucumber as to melons in general. The Seedling Apple of Lock, who is the parish clerk of Rushbrooke, was of excellent flavour, and its success in obtaining the prize was a matter of great satisfaction, as likely to encourage the industry and gardening skill of the cottagers in the neighbourhood. It was subsequently named Lock's Rushbrooke Pippin, and will, most likely, be extensively cultivated. There were some very fine grapes, presented by Mr. Steel of this town, and some extraordinary Uvedale St. Germain Pears from T. L. Rivett, Esq., of Wetheringsett, not subscribers; also a gourd grown by Mr. Buchanan, of Stowmarket, which weighed 84 lb.; specimens of the Red Mangold Wurzel, grown after potatoes, without manure, each weighing 12 lb. and upwards, and the Chou Rave, or German Turnip Cabbage, sent by Mr. Hodson; also yellow Maltese Turnips (an excellent garden sort), grown by Mr. H. Case, of Rougham; and a profusion of chrysanthemums, with a dozen specimens in pots, of the more rare sorts, presented to the botanic garden by the Horticultural Society of London. An excellent dinner was afterwards partaken of by the amateur and practical horticulturists, at which the chair was taken by T. Clay, Esq., as one of the vice-presidents, in the absence of the president, R. Bevan, Esq., and the day was spent with general gratification. — The Society now consists of upwards of 200 members. (*Bury Post*, Dec. 5.)

#### BERKSHIRE.

*The Windsor Horticultural and Florists' Society*. — Six cucumber-growers of this Society will show six leashes of cucumbers against any six leashes grown in England, in the month of February next, for any sum between 20*l.* and 100*l.* — *P. Burnard*. *Holloway*, Sept. 16. 1828. This challenge is too late for February, 1829; but we have inserted it to show the high spirit of the Society, and in the hopes that it may produce something for February, 1830. Those who wish to compete, will address Mr. Lovegrove, Fruiterer, Windsor.

#### GLAMORGAN AND MONMOUTHSHIRE.

*The Glamorgan and Monmouthshire Horticultural Society*, established 28th July, 1828. Patron, the Most Honourable the Marquess of Bute; Vice-Patron, Sir Charles Morgan, Bart. M.P.; President, the Honourable W. B. Grey, F.H.S. This Society comprises, within the *objects* its institution, all the different departments of vegetable life. The following are its rules: —

1. That four *General Meetings* be held at Cardiff in the year, viz. on the first Wednesdays in January, April, July, and October, when the routine business of the Society shall be transacted, selected communications read, periodical shows appointed, and lectures provided for, of which a fortnight's notice, at the least, shall be given.

2. That the *payment*, in advance, of ten shillings and sixpence per annum, constitute a member; or a payment of five guineas, a life-member; but that donations in money, books, plants, seeds, or other objects of utility to the Society, will be thankfully received.

3. That a *room* be procured and furnished for the exclusive use of the members, in which the papers, books, specimens, and other property of the Society shall be deposited, under the superintendence and regulation of the committee.

4. That the *vice-presidents, treasurer, committee, and secretary*, be elected annually, at the general meeting in July.

5. That persons wishing to become *members*, after the general meeting on the first Wednesday in January, shall be proposed and seconded at one general meeting, and balloted for at the next; a majority of members electing.

6. That there be *honorary and corresponding members* elected by vote of majority at any general meeting, who shall not be expected to contribute to the funds of the Society, nor be allowed to vote on any occasion whatever, but who may attend public meetings of the Society, and exhibit any productions at the shows; but, if successful competitors, not to be entitled to prizes.

7. That the *prizes* awarded at one show shall be distributed on the next show-day; and that a due proportion of prizes, consisting of money, gardening implements, or fruit trees, shall be allotted for the best cultivated cottager's garden.

8. That a *library* be formed, to consist of practical works, whether periodical or otherwise, relating to horticulture, botany, and planting, the expense thereof to be regulated by the funds of the Society; but that donations of such, or any other works on natural history, be gratefully received.

9. That notice of any *motion* be given at one general meeting to be discussed at the next, its fate then being to be determined by the majority present.

10. That the *proceedings* of the Society (including those of the committee) shall be entered by the secretary for the time being, in a book kept for that purpose; proceedings to be signed by the chairman of the meeting, and to be open to the inspection of members at the Society's room.

11. That the committee at the January meeting in every year, shall lay before the subscribers plans and arrangements for the different *shows*, and that the regulation of the same be vested in them, subject to Rules 6 and 7.

12. Any *seeds or plants* which may be put at the disposal of the Society, will be distributed amongst the members, in rotation, according to the seniority of date or subscription.

The Society already reckons upwards of a hundred members. At the first General Meeting, our correspondent, John H. Moggridge, Esq., one of the vice-presidents, delivered an introductory address, which was honoured with the highest applause, and of which, being voted to be published, we hope, in a future Number, to give some account of it to our readers.

---

#### ART. VI. Notices of Suburban Gardens.

*WICK HOUSE*; Dr. Jamieson (May 14).—The kitchen-garden here is well arranged, and especially the forcing-department, which is a walled enclosure by itself, and so laid out as to unite the utmost conveniency with neatness of appearance. The culture of pine-apples was relinquished when the late occupier gave up possession; but the crops of grapes and peaches are excellent. There is a small house exclusively devoted to the culture of the Muscat of Alexandria, which is the best plan for succeeding with that grape of exquisite flavour, and rather difficult management. One plant occupies the whole house, and is covered with the finest crop we ever saw. Two excellent gardeners have had the management of this garden in succession, the late Mr. Ross, and Mr. Edgar, now gardener to Mr. Ellis, at Snettisham,



near Lynn; they are at present let, *pro tempore*, to Mr. Jones; and the forcing department is managed by Thomas Muir, who has been some years under Mr. Edgar, and has proved himself an excellent gardener, and most deserving young man.

The above was written and put in type upwards of two years ago. Last spring we called on Dr. Jamieson, whom we found in possession of the kitchen-garden and pleasure-ground, as well as the house and fields. The Doctor has made various erections, among the latter scenery, for gymnastic exercises and recreative games for his pupils. He showed us the details of his school establishment, which is on so ample a scale, though for a very small number of pupils, as to call into use the whole of the mansion and offices of Wick. He also described to us the manner in which the studies were pursued. According to the best of our information and judgment, having had a relation educated by the Doctor, in a former establishment, there is not, and cannot be, a better school of the kind in the neighbourhood of London. Of course, it is only for the sons of such as are in easy circumstances.

*Whitton Park*, near Hounslow; — Calvert, Esq. — A large house, surrounded by what was part of the Duke of Argyle's park, formerly celebrated by botanists for its collection of American trees; ridiculed, on account of these trees, by Sir William Chambers, and described by Wheatley as one of the finest examples of modern gardening. A part of the artificial river, mentioned by the above writer, still remains; and some of the cedars, hickories, acacias, and other trees, which are now fine specimens. In the kitchen-garden was lately dug up the foundations of the house in which Dr. Dodd lived, and from which, it is said, he was taken to be tried. The gardener here, Mr. Lane, received a medal from the Horticultural Society, for forced strawberries.

*Whitton House*, near Hounslow; Sir Benjamin Hobhouse. — The house was that occupied by the Duke of Argyle; and its elevation, consisting of a centre and two wings, is familiar to every one who has paid any attention to the architectural plates of the *Encyclopædias*, and other architectural works of the latter part of the last century. The grounds are interesting, from the variety and size of their exotic trees.

---

## ART. VII. *Garden Libraries.*

*PROVINCIAL Horticultural Libraries.* — Sir, As the horticultural society established in this town, and other horticultural societies are forming libraries, if it would not be trespassing too much on your time, would you, in an early Number of your interesting Magazine, favour us with a list of books (on a very extensive scale), which you think best calculated for such a purpose, on horticulture, botany, and agriculture, in every department, including plans for laying out grounds, ornamental architectural buildings, grottos, &c.; also natural history, in all its branches, and chemistry, so far as connected with horticulture and agriculture; likewise all the leading periodicals in the above sciences.

And perhaps you would, at the same time, point out the great advantages that provincial horticultural societies would derive by establishing permanent libraries, instead of expending the whole of their funds in awarding prizes. To a library thus formed, in some cases, dried specimens, and drawings of plants, &c., indigenous to the neighbourhood or otherwise, and even specimens of natural history, might be presented. The books should, if possible, be first circulated, and members afterwards be allowed to borrow them for limited periods. Gentlemen belonging to the society might allow their gardeners the use of the books; and gardeners, and others who could not otherwise, may by this means see every thing worth seeing. And it cannot

be doubted but it would have the effect on a neighbourhood, which your valuable Magazine has had on gardening in general, — that of raising the whole science.

And, Sir, when we consider the rapid improvement of the present age, the information diffused by horticultural societies, magazines, and other periodicals, he must rank very low in the scale of gardening who sees and knows nothing of this various information, and who is thus standing still while the world goes round. Apologising for the liberty I have taken, I am, Sir, yours, &c. — *J. Clarke. Saffron Walden, Oct.*

We have not time at present to enforce the arguments of our intelligent correspondent in favour of garden libraries and the diffusion of knowledge; nor indeed is it necessary, for he has given the essence of all that we could advance. With respect to lists of books, we could give none which has not appeared in the *Encyc. of Gard.*, or in preceding Numbers, and all those of real worth are characterised as such. If Mr. Clarke will make out a list and send it to us, we will note on it what omissions we think might be made, and what additions would be advisable. Provincial societies, with libraries formed on the model which our correspondent contemplates, and which seems to be nearly the same as that of the Newcastle upon Tyne society, are in accordance with what we have stated in Vol. II. p. 375., under the head of Village Libraries. It will there be seen how important we think them for the progress of society. — *Cond.*

*A Village Library*, or reading club, has lately been established in the village of Carcolston, Nottinghamshire, by which, at the trifling expense of 3*d.* a month, the subscribers will be furnished with agricultural and general reading. Among the subscribers is the Protestant vicar of the parish, and the Catholic priest. (*Nottingham Review.*)

*East Lothian Itinerating Libraries.* — Sir, I am obliged by your notice of the East Lothian itinerating libraries in your Gardener's Magazine. I enclose you a copy of the Fifth Report lately published. Every year's experience convinces me that the itinerating library is the cheapest plan for diffusing knowledge, where there is a reading population, that has been adopted since the invention of printing. At Haddington, North Berwick, and some other stations, almost the whole books on general subjects have been in constant circulation, so that when persons did not apply on the evenings in which they were issued, they could hardly procure one. I am, Sir, &c. — *Samuel Brown. Haddington, June 16. 1828.*

We intend to notice the report in our next Number; in which, we shall have a good deal to say on village libraries, village museums for the use of infant schools, village infant and adult schools, with gardens, and, in short, the adoption of an improved modification of the Wurtemberg, Bavarian, and Baden system of general education; a system which, with the modifications and additions which we have proposed in a pamphlet which we had translated and published in Paris, would, if universally adopted, do more for the human race, than any thing that has yet been attempted; that is (in our opinion at least), it would render them all that they are capable of being. — *Cond.*

---

### ART. VIII. *Retrospective Criticism.*

*To condense and preserve Vegetables.* — One of your correspondents, in a former Number, has described the method of preserving cabbages, and other green vegetables, by salting them; allow me to refer you to a different process for attaining the same end. Boil, over a fierce wood fire, so as to preserve their colour when completely cooked; grind them into a complete pulp, by some such means as are used to crush apples for cider, &c.; then let them be subjected to the action of the press (being first put into hair bags, or treated as grapes are in wine countries), till all the fluid

matter is separated from them; the remainder of their substance being wonderfully condensed, and as hard as the marc from the wine-press. Then let it be rammed hard into carefully-glazed airtight jars (or tin cases, if preferred), and boiled as in the case of bottled gooseberries. If jars are used, they may be sufficiently secured by having two pieces of bladder tied successively over them; when the air within them is absorbed by heating the enclosed substance, their surface becomes concave by the pressure of the atmosphere; and, as long as it remains in this state, the matter within is safe. If it should be thought requisite to preserve the flavour of the vegetables entire, an extract should be made from the expressed liquid, and added to the marc. But spinach, cabbage, and many other vegetables, have abundance of flavour in them in their dry state, without this addition. The preparation of the vegetable matter for use is accomplished by adding a sufficient quantity of milk, water, gravy, lime-juice, &c., to the marc, and warming it up. Let the Government, and the dealers in ships' provisions, look to this; a sufficient quantity of this vegetable preparation would be the greatest luxury to a ship's crew, and render the scurvy utterly obsolete. It is worthy of remark, that the most irritable stomach is not offended by vegetables treated in this way. (*Quar. Jour.*, Oct. 1827.)

*Preserving Grapes.*—I do not like the method of preserving grapes recommended by several of your correspondents. Olivier de Serres says, gather them when fully ripe, and on a warm day when they are perfectly dry, and hang them in a dry, well-aired room; those which have long berries wide apart, are the best sorts for this purpose. They will shrink; but to lessen this, suspend them in osier baskets, and drop in among them, loosely, dry vine-leaves. Another mode is, to suspend bunches of grapes in a cask, so as they may not touch each other, and then pour in dry corn, or other small seeds. O. de Serres recommends millet, but clover-seed or turnip-seed would, doubtless, answer just as well. By this means, he says, the grapes are preserved cool, fresh, and entire, and may be used in the dessert, daily, till Easter, and later. The above was published in the first year of the 17th century; Deyeux, an annotator on it, in 1804, observes that it is perfectly correct, adding, that the basket ought to be examined from time to time, in order to remove any decaying berries: and, in order that the same thing may be effected where grapes are preserved in a barrel, or box of grain or seeds, a hole with a plug is made in the bottom; and the box being suspended, the plug is withdrawn occasionally, all the grain or seeds allowed to run out, the top of the box removed; the system of twigs on which the grapes are suspended is then taken out, and any decayed berries removed; they are afterwards replaced, and the grain or seeds, being dried, are again poured in to fill the interstices. With these precautions, M. Deyeux assures us, grapes may be preserved perfectly fresh for several months. I should recommend a trial to my brother-gardeners who have a cool dry cellar in which to place the box. I may add, that a similar system is employed for packing and preserving the grapes sent from Spain and Portugal to this country, and sold in the fruit-shops during the winter and spring.—*T. B. Bristol, Aug. 10.*

*Vines in the open Air.*—Mr. Salisbury's management, besides being found in *Hale's Statics*, is twice mentioned in *Weston's Tracts on Gardening*; and, ten years ago, I apprised him, through a relation of mine, that his was no new discovery, pointing out where he might find it mentioned; and moreover telling him, that I myself had followed it for years without ever observing the result attributed to it. My method of managing the grape vine on open walls is as follows: as soon as the fruit is gathered from a tree, or even a single branch, I immediately cut off the leaves, and, if necessary, prune it for the next year; as by careful attention in stopping the shoot at a proper length, it will need but little pruning, except only removing old or useless parts. This early pruning, in my opinion, assists to ripen the wood, without which no great crop can be expected;

but I never noticed that it causes the vine to shoot earlier in the following spring. I must be permitted to say, that grapes out of doors are not, in general, well understood. I have been a vine-dresser for these twenty years. From the Black Hamburgh I never missed having a crop of fine ripe grapes, from the beginning of the ripening season, till the Sunday before Christmas, save only once, that year (1814) in which the Emperor Alexander of Russia was in London. In that season my crop was only fit for wine, and very good it was, though made on the gooseberry-wine process. The only secret in ripening grapes in the open air, is timely summer pruning, and constantly keeping the fruit close to the wall. With attention to this material point, I had bunches weighing from a few ounces, up to two pounds; and have been offered 2s. 6d. per lb., though at one shilling they would have paid all the rates and taxes of my place! It is really a pity to see so many naked walls, especially about London; which, if covered with vines, would yield abundance for the table, besides wine enough to supply a bottle for every holiday in the year, at the moderate price of five pence! The Hamburgh ripens within a fortnight of the Black Cluster, and is a superior fruit for every purpose. I always use open black muslin bags for protectors, though I have seen a light woven fabric of horse hair, which I should think would be preferable. The strongest equally swelled bunches should be chosen, and freed from small and decayed berries before bagging. — *Superficial.*

*Errors of the Press in the Article on Ornamental Gardening, by an Amateur* (Vol. IV. p. 211.)—Page 213., 7 lines from the bottom, for *adjacent*, read *adjunct*. Again, at p. 214., 6 lines from the top, for *Bolton*, read *Belton*. Again, at p. 445., 12 lines from the top, for *four* read *sour*. — *An Amateur. Woodstock, October 10. 1828.*)

*Various Errors by the Conductor.*—Sir, You will oblige me by correcting some of my papers inserted in Vol. IV., p. 319. By contracting and abridging them as you have done, I consider you have left out the most essential part of them.

Respecting *the Disease on Celery*, you have blended the two diseases, named by me, together, by saying the former disease I have had but one year, which should have been confined to the disease with the maggot in the leaf. If you look to my paper, you will find I stated I had had the former disease two years; the words which would have conveyed to any person what it was like, you have left out. I stated it was like the disease the garden bean is subject to in autumn, thinking that probably it is not every person that might understand what is meant by stating that it is of a ferruginous nature. I have the disease on the celery this season, just come on: some persons say it proceeds from the beans; but the disease prevails where there is no bean near, and where none have been during the season.

Respecting *Forsyth's Composition*, you say I want to know what it is made of; which of course must appear to your readers as if I either bought or begged it, or I should have known what it was made of. I asked what was its power, if too caustic, if too porous, or too absorbent, imbibing the sap too freely. My own opinion of Forsyth's composition is, that it absorbs the sap from the scion and crown of the stock, so as to prohibit a union. I find it to be an excellent ingredient for wounds.

Respecting the *Mildew on Cucumbers*, you did not state that the watering should be done when there was likely to be a strong sun.

In a paper which I sent to you, *defending the head-gardener against the journeyman gardener* (Vol. IV. p. 210.), you have stated that there is no exception on the part of the head-gardener or master: I stated eight times out of ten it was the man's own fault if he did not improve his mind. I am, &c. — *John Damper Parks.*

*To flower Mignonette during Winter and Spring.*—Sir, Permit me to suggest to you the correction of an article in Vol. IV. p. 445., concerning

the management of mignonette in pots during the winter, and which is not correctly printed from my letter. It should stand thus : —

To flower in November, sow August the 10th. To flower in the end of January, and throughout February, sow August the 25th. To flower in March, April, and May, sow September the 5th.

Sow in 48-sized pots, with their bottoms safely drained in a compost of two fourths mellow loam, one fourth leaf mould, and one fourth clean sand. Plunge in frames within a foot of the glass, give the frame a good elevation, and thin the plants out to six or seven in a pot. Give all the air possible, when not frosty, but mat up well in severe weather. It is advisable to stop the middle shoot from the two latter sowings. At all times, except when flowering, give water with caution. — *Robert Errington. Oulton Park, Cheshire, Nov. 28. 1828.*

*Size of Mr. Howes's Cockscomb.* — Sir, In Vol. IV. p. 351., it is stated that the cockscomb raised by me was 22 in. high, whereas it was 22 in. long. The correct size of the flower was as follows : —

From the surface of the mould to the top of the blossom, 19 in. Length of the crest of the flower, 22 in. Breadth of the crest of the flower 10½ in.

My flower, therefore, was, I conceive, larger than the Appleton flower, described Vol. IV. p. 101., though the Appleton flower was higher; its dimensions being as follows : —

From the surface of the mould to the top of the blossom 3 ft. 6 in. Length of the crest of the flower, 23 in. Breadth of the crest of the flower 6 in. Consequently the contents of the upper surface of the crest of the Appleton flower was only 138 in., while that of mine was 251 in.

I hope you have seen the dwarf cockscomb plants, which I sent to the Horticultural Society's garden in September last. [We were then abroad.] I have grown one this year with the crest 24 in. long, 13½ in. broad, and 21 in. high from the surface of the mould to the top of the flower. I have one standing in a small orange-house which is 3 ft. 5½ in. high, the crest of the flower 24 in. long, and 11 in. broad; but that size is not so remarkable in the tall as in the dwarf sorts. I remain, Sir, &c. — *R. L. Howes. Middleton Gardens, near Lynn, Oct. 21. 1828.*

*Agronome and Mr. M. Murtrie.* — Sir, I observe in Vol. IV. p. 310., that you have allowed Agronome rather to exceed the bounds an anonymous writer should be confined to. With regard to his sneer at me, both as a gardener, and as to my sentiments concerning metallic hot-houses, I assure you I am not at all angry: but I think it is hardly fair to allow a shadow, as every anonymous writer must be considered, to cut and cavil at one who comes forward in his own proper character, to present to the public the results of his experience. So long as Agronome confines his observations to his own practice and experience, his papers will be read with interest, if they are worthy of it, but he cannot expect to be distinguished in any other way in your Magazine. If he is disposed to *criticise*, to give weight to his strictures, he must “do off his habit,” and appear in his own proper person; then the public will be better able to judge whether any credit is due to his judgment, and whether he is as able to perform well himself, as to find fault with others. But he must not be allowed the privilege of *attack* so long as he retains his disguise. Let him defend himself and welcome when he is assailed. Abstaining, therefore, for the above reason, from taking any further notice of Agronome's observations, I remain, Sir, your most obedient servant, — *W. M. Murtrie. Shugborough, Aug. 7. 1828.*

*Vines within the Tropics.* — Sir, There is nothing more conducive to the advancement of knowledge and the investigation of truth than the temperate discussion of facts, and I rejoice, therefore, that my observations upon your correspondent J. A. M.'s statement in Vol. IV. p. 314., that vines planted within the tropics *never* do well, have elicited some further facts

from that gentleman, which, without invalidating my assertion, are not without importance.

From the difference between an insular and a continental situation, it can be easily understood why the climate of continental India within the tropics is so infinitely hotter than that of the islands of the West Indies; hence it can be a matter of little surprise to your readers, to find productions flourishing in the one, which can hardly be brought to grow in the other. This simple fact will account for the *apparently* conflicting testimonies of your correspondent J. A. M. and myself respecting the grape vine. I employ the term *grape vine* to distinguish the *Vitis vinifera* from other climbing plants, to which the term *vine* is commonly applied, as a kind of generic name, throughout the British West India islands.

But even in India, it appears from your correspondent's statement, in his communication of the 28th of last October (Vol. IV. p. 535.), that there are situations within the tropics, even in India, where "grapes come to the greatest perfection," notwithstanding their want of the repose of winter, — the very fact which it was my object to establish. The fact appears to me to be, that it is not the want of *winter rest*, but the want of *some effectual check to an overluxuriant vegetation*, which renders the generality of extra-tropical fruit trees barren within the tropics; since in the cooler situations even of continental America, where the vigour of vegetation is considerably less than in the hotter and lower regions, the peach, the apple, and other European fruits, attain as high a perfection as with us. Even wheat can be cultivated, as I have the authority of Humboldt for stating, in some situations within the tropics, with infinitely more advantage than among us; it may even be cultivated at elevations favourable to the culture both of the cane and the coffee; and at "Venezuela and in the Island of Cuba, the *lower limit* of wheat descends in the most unexpected manner towards the burning plains of the coast." (*Humb. Pers. Narr.*, vol. vi. p. 505-6.) Wheat is even cultivated in several parts of equinoctial America in places not more than from 1727 to 1918 ft. above the level of the sea, "amidst the cultivation of coffee trees and sugar cane, and in places when the mean temperature of the year is at least 25" (77° Fahrenheit)." (p. 205.)

"An acre (about 1½ acre English) near Victoria generally yields from 5,000 to 5,200 lbs. weight of wheat. The average produce is consequently here, as at Buenos Ayres, three or four times as much as that of northern countries. Nearly sixteen times the quantity of the seed is reaped." (vol. iv. p. 106.) "Near San Mateo we find the last fields of wheat, and the last mills with horizontal hydraulic wheels. A harvest of twenty for one was expected; and, as if the produce were but moderate, I was asked whether corn produced more in Prussia and in Poland. It is an error that generally prevails under the tropics, to consider grain as plants which degenerate in advancing towards the equator; and to believe that the harvests are more abundant in the northern climates." (p. 109-10.) "The fine harvests of Egypt, and of the kingdom of Algiers, those of the valleys of Aragua, and the interior of the Island of Cuba, sufficiently prove that the augmentation of heat is not prejudicial to the harvest of wheat and other alimentary grain, *unless attended with an excess of drought or moisture*. To this circumstance no doubt we must attribute the *apparent anomalies* that are sometimes observed between the tropics, in the *inferior limit of corn*. We are astonished to see to the east of the Havannah, in the famous district of Quatro Villas, this limit descend *almost to the level of the ocean*; while to the west of the Havannah, on the slope of the mountains of Mexico and Xalapa, at 677 toises (4329 English ft.) of height, *the luxury of vegetation is such, that wheat does not form ears*." (p. 111.)

As your correspondent may retort upon me, that Wheat and the Cerealia, being annuals, have nothing to do with the question of plants which are perennial requiring the repose of winter to recruit their powers, I shall not

at present extend my quotations farther, but, acknowledging that my zeal for the improvement of West Indian agriculture, and the developement of all the rich and varied resources of those favoured regions, has led me, as the lawyers say, to travel out of the record, conclude this part of the subject with a citation from a Haytian writer on the affairs of St. Domingo, in support of my original position, that the grape vine is, *when judiciously treated* at least, productive within the tropics in our West India islands, and that there is no doubt of the manufacture of wine from its fruit admitting of being added to the other objects of colonial industry and prosperity.

The late Baron de Vastry, in his *Reflexions politiques, sur quelques Ouvrages et Journaux Français concernant Hayti*, published in 1817, speaking of the impolitic restrictions imposed upon the colonial industry of that island, says, at p. 109., " Dans le Regime Colonial il était pareillement défendu à St. Domingue, de cultiver le blé, et la vigne pour faire du vin, sous les peines les plus sévères " (Under the Colonial System, both the cultivation of corn, and of the vine, for the purpose of manufacturing wine from its fruit, were prohibited under the severest penalties); and he adds proof of this, in a note, as follows: — " M. Soleil, habitant des Gonaïves, ayant fait un vin potable, en fit goûter à M. de Bellecombe, alors Gouverneur, qui, pour prix de son zèle et de son industrie, le fit mettre en prison, et condamner à une forte amende " (Monsieur Soleil, a planter of Gonaïves, having made a drinkable wine, made Monsieur de Bellecombe, then governor, taste it, and was, as a reward for his zeal and industry, imprisoned by this gentleman, and condemned to pay a heavy fine). What the quality of the wine thus made as a matter of experiment, and possibly with an imperfect knowledge of the process, might have been, is immaterial to my purpose; the fact of its being possible, and, I doubt not, advantageous also, to make wine from the fruit of the grape vine in our West India islands, being the point I had at heart to establish. Wine of an excellent quality may also be advantageously manufactured from the succulent fruit of the Anacardium occidentale, or Cashew apple, and many other West Indian fruits, on which subject, I believe, I troubled you with a letter some time since, which will, I hope, yet appear in the Gardener's Magazine.

I have not time at present to enter into the discussion of the important fact of *lunar influence* on vegetation, within the tropics; a fact perfectly familiar to every West Indian planter. I shall merely observe that the circulation of the sap is materially influenced by the lunar phases, rising between the new and full, and falling between the full and new moons. An attention to this fact is of the utmost importance, especially in cutting timber; since even the most valuable timbers of the tropics, if cut at an improper time of the moon, will decay rapidly, while their duration, when cut at the proper season, is almost eternal. I have myself made experiments upon the growth of the *Convólulus disséctus*, or Noyeau, which proved the fact of this influence upon vegetation in the most clear and satisfactory manner. Hoping you will forgive the length of this letter, I remain, Sir, yours, &c. — *William Hamilton*. 15. *Oxford Place, Plymouth*, Dec. 14. 1828.

*Discussion relative to the Wages of Gardeners.* — Sir, Having accidentally, at the house of an acquaintance, met with your Magazine for Nov. 1828, I read with pleasure, under the head of Retrospective Criticism, the remarks of Z. and X. Y. Z. on the paper published in one of your early Numbers, on the subject of gardeners' wages, &c. I can only add, that I most perfectly agree with them, and was so fully convinced of the mischief likely to arise from placing such remarks in the hands of my gardener, that I immediately discontinued the book, it being on this account comparatively useless. I had afterwards an opportunity of knowing that I was not singular in my decision. I regretted the necessity of giving it up, as from your Encyclopædias, which I possess, I hoped to derive amusement and benefit from the publication. A gentleman with an income of 2000*l.* would, according to

the allowances you claim as a gardener's right, be obliged to go to market for his vegetables, as he could not possibly keep a head-gardener, much less assistants. An officer, who has lost his limbs and health in the service of his country, does not possess the same advantages. — *A. B. C.*

We are always glad to know the feelings of our readers, in order to shape our course accordingly; because, in order that the Gardener's Magazine may do good, it is necessary, in the first place, that it should *sell*. If *A. B. C.* should ever happen to look into any of our future Numbers, we hope he will find them more to his mind. — *Cond.*

*Conduct of Head-Gardeners towards Journeymen.* — Sir, In your Magazine (Vol. IV. p. 210.), I observe *J. D. P.* attempting to set your readers right concerning the remarks of *G. R. G.* in a former Number; and in endeavouring to do so, *J. D. P.* has omitted much information which he might very well have stated. He says, that in the several gradations through which he has passed, he has never seen instruction withheld from the assiduous workman, through the disregard, or unwillingness of the master.

In my experience, I have too often seen much partiality exhibited in the conduct of head-gardeners towards the men under their charge. In Scotland this practice prevails very much. In an extensive garden I have known the gardener have no less than four apprentices at a time, who have paid him five or six pounds each, as a premium, for two years, expecting to have an opportunity in that time of obtaining a practical knowledge of the different parts of their profession; but who, at the expiration of the two years, have found themselves very much deceived: and being obliged to make room for a fresh stock of apprentices (to fill the gardener's pocket), they obtain the name of journeymen, although they have their business still to learn; and on that account they generally fail to give satisfaction to their next employer, who will give the most particular part of the work to those whom he thinks most competent to do it. I know very well that there are some people (gardeners as well as others), who soon become too wise to be taught; but I can affirm that there are many tractable young men, who can with propriety lay the blame of their deficiency in knowledge to a want of care in their master, who generally has a foreman, to whom he commits the care of the principal parts of the various departments, the younger men being employed in the more laborious parts. Now, Sir, as you have already told us, that knowledge to the gardener is money as well as knowledge, and, as it is generally understood, that when a journeyman engages with a master, he expects to have an opportunity to improve himself, therefore he who withholds that opportunity from any young gardener, commits a crime equal to that of defrauding him of his wages.

There are several men, who, when they become masters, seem entirely to forget that they were once journeymen, and who keep up such a reserved distance between themselves and their men, that the latter have not the assurance to ask for the necessary information, requisite to enable them to execute their work in a proper manner. I would advise that a great part of such a barrier be broken down, so that a free and unembarrassed communication may always exist between masters and their men.

*J. D. P.* concludes with a very wholesome advice to those who wish to learn; but still his strain is too exculpatory with regard to the masters, as it is well known that there are many who are far deficient in their duty to their men. Should you deem these few remarks worth inserting in your very useful work, you will much oblige your humble servant, — *Neutral.*

*Neglect of Practical Gardeners by the Provincial Horticultural Societies.* — Sir, as the season is fast approaching, when you will have to record in your valuable miscellany, the progress of the Provincial and Horticultural Societies, you, who are always ready to assist in improving the welfare and conduct of gardeners, will permit me to observe that many of these societies have fallen into a very great mistake, by not inserting the names of gar-



deners when they make the reports of the prizes awarded. By this means the gardener is in a great measure deprived of his merit. It is well known that gardeners are, for the most part, the cultivators of the rare productions brought for inspection into the rooms of the society. If the gardeners have not a share of praise given to them at these times, I am afraid they will slacken their exertions in cultivation. If ever this take place, then a falling off of those societies will be the result. It also discourages the young gardener, and prevents him from exerting himself to obtain that praise that would be due to him. In the next place, should a gardener change his situation, his practical character is already known; it remains no longer within the hands of a few individuals, but becomes general, a circumstance which would remove many inconveniences attending gardeners out of situations. Much more might be done to make these few observations useful towards encouraging gardeners to become spirited members of these societies, but finding myself unable to enter into general argument, I humbly submit the above for your consideration, and remain yours, &c.  
—James Rollins. *Dingle Bank, Jan. 5. 1829.*

Our correspondent has hit upon the true value of Horticultural Societies to practical gardeners, which is, to make their professional merits publicly known, and thus to put it beyond the power of individuals of any description, whether verbally or by what are called written characters, to subtract from the precise degree of practical excellence which they may have attained; and thus, perhaps, prevent them from obtaining such places as they are capable of filling. A practical gardener, who has written some papers in any of the Transactions of the different Horticultural Societies of the country or in the Gardener's Magazine, and who has exhibited in competition at public meetings, fruits and vegetables, and received prizes for them, maybe said to have established for himself, before the gardening world, a professional character as unquestionable as the specific character of a known plant. The facts, that is the papers written and the fruits exhibited, being recorded in the Gardener's Magazine, this character becomes known to all the brethren, and especially to the nurserymen, who, if they thought it worth while, might easily keep a list of such gardeners, with short specific professional characters as under:—

**JAMES GREEN.** — *Prof. Char.* Author of papers on turnips, peaches, and ferns, in *Caledon. Trans.*, vol. i. and ii.; on pompions, in *Lond. Hort. Trans.*, vol. iv.; on celery, endive, laying out a garden, and the Carolina poplar, in *Gard. Mag.*, vols. ii., iii., and iv., in which also the essence of his other papers are given.

*Exhibited.* — At Dundee, broccoli and auriculas (*Gard. Mag.*, vol. iii.); at Perth, sugar-loaf cabbages, peaches, and a Hortus siccus (*Gard. Mag.*, vol. iii.); at Edinburgh, grapes, pines, and melons (*Gard. Mag.*, vol. iv.) In all, two medals, two books, one snuffbox, one knife, one foot-rule, and four times thanks recorded.

The moral character of a gardener is a different thing from his professional character; though it is quite impossible for any man to keep up a regular succession of crops of vegetables and fruits for a family without being of sober, attentive, and reflective habits. If to these, the ordinary duties of a gardener, the cares of forcing are added, and he is successful, such is the vigilance required for this part of the profession, that it is almost impossible that the operator should be otherwise than sober and attentive. However, in keeping what may be called the specific character of gardeners, nurserymen might add their moral and biographical character, thus:—

**JAMES GREEN.** — *Prof. Char.* As above.

*Moral and Biog. Char.* Born in Dundee, 5 ft. 10 in. high, healthy and vigorous, 45 years of age, 15 years married, three children; apprentice at Red Hill; two years in the Edinburgh Botanic Garden, head-gardener in

four places in different parts of the country, with a good character for sobriety, integrity, and industry from his last place.

If every gardener will write his own specific character in the above manner, he will see what he wants to render it complete; because the first step towards supplying a defect, is to know and feel that it exists. Gardeners also who know different masters, might make out their specific characters, and by these exercises learn to know others as well as themselves. — *Cond.*

*The Balm of Gilead Firs in Kinnell Park.* — Sir, A correspondent in Vol. IV. p. 565., says that in Kinnell Park, Denbighshire, are Balm of Gilead Firs, of 84 ft. in height, and 10 ft. in circumference at the base. If this is correct, they are the most rare and curious vegetable productions in this kingdom. Every Balm of Gilead Fir that I ever yet saw, or before heard of, planted in Britain, when it has attained a fifth or a fourth of that height, becomes stunted, and dies. Has not your correspondent mistaken the species? and are not the firs in question Silver Firs? These not infrequently attain the size and bulk mentioned by your correspondent, and even a much greater size.

The two species of firs being considerably alike in leaf, it is not uncommon to confuse them. An easy mark of distinction is this: the leading bud of the Silver Fir is covered with a coat of hard dry resin, which does not soil the fingers; the leading bud of the Balm of Gilead Fir is covered with a brilliantly clear liquid resin, which very difficultly dries, and adheres to the fingers when touched. There is also a difference in the smell, which it is easier to recognise than to describe. Probably some other of your correspondents may be able to determine this fact with accuracy. I am, Sir, &c. — *Causidicus.* Nov. 9. 1828.

*Origin of the Otaheite Pine.* — Sir, In No. viii. of the *Pomological Magazine*, the Anson, or Otaheite, Pine is stated to have been raised from seed at Shugborough, which is incorrect. It was not raised from seed in this country, but was introduced by the late — Birt, Esq., of Colton Hall, near Rugeley, from the Island of St. Croix, in the West Indies. Some plants soon found their way to Shugborough, and were probably fruited there in great perfection, whence arose the erroneous idea of its having been raised from seed there. I am yours, &c. — *C. F. W. Drayton*, Oct. 25. 1828.

*The Pomological Magazine.* — My housewife, finding that we had more gooseberries than we could consume, lately proposed to me to make some British wine with them, to which I assented; and she desired me to get her some book in which I should find a recipe for making it. Remembering to have seen advertised a *Pomological Magazine*, I immediately concluded that, in this work, the name of which (being compounded of *πομα* (*pōma*) drink, and *λογος* (*logos*), reason or method) does, according to all grammar and Greek, import to contain the science and theory of drinks, I should find information on the manufacture and ingredients of all wines and fermented liquors: but, to my disappointment, when I came to buy it, I found only figures of four or five fruits, and some description of them, but not a word of the means of making them into drink; and, worse, it appears as if the editor meant to go on publishing plates and descriptions of four or five varieties or species of fruits in every Number, for an almost interminable series; so that I and my housekeeper shall be dead before the name will become appropriate, and before the author will begin to treat of the method of brewing the wines from these fruits. It appears to me, that it would be much more useful if the editor, now that he has given a plate and description of one or more varieties of several species of fruit, as apples, pears, peaches, gooseberries, and strawberries, would next give us a few chapters on the manner of converting them into drink; and, when he has fully treated thereon, he may add the descriptions and plates of other varieties of fruits, and, if they require any difference in the brewing process, he may mention it as he goes on with the fruits. I

ought, however, to add, that my apothecary's apprentice insists that *pomum*, being Latin for an apple, the editor of this work meant by "pomology," the science of apple trees. Now, he might as well contend that it means a *log* of apple tree; it would not be more barbarous to tinker an English and a Latin word into one name, than it would be to try to solder Latin and Greek together; and, though there was one Knoop, a German, about the middle of the last century, who made a book about fruit trees, and called it *Pomology*, yet that affords no reason to believe that any Englishman, especially a scholar, would do the same; for it is well known, that

"The Germans in Greek  
Are greatly to seek:  
All? All but one Herman,  
And he is a 'German.'"

And, least of all, would any gentleman who has the command of such fine engravings, and fine colouring, and fine letter-press, and fine paper, as decorate the *Pomological Magazine*, have committed such a solecism. I am therefore confident that the apothecary's apprentice is wrong. While we were debating the matter, in came the apothecary himself, an old Scotsman, who, after having heard our dispute, rapped his mull, and having taken a pinch from it, shrugged his shoulders, and pronounced us both wrong; "for," says he, "the word denotes the science of nicely fitting these wooden "covers," showing us his mull: "the word is derived from *ποιμα* (*ῥῶμα*), operculum, a cover, and *λογος* (*logos*), the reason or method; and the treatise on the fruits is only illustrative of, and introductory to, a treatise on the woods of the same trees that are proper for making mulls. And ye will soon find, in the Magazine, a dissertation on the qualities of the timber of the different fruit trees for the turner's use; but not a word of the manner of making cider or wines." I am, therefore, completely at a loss what the title of the work means; but, as you live in London, perhaps you may know the editor, and, if you have an opportunity, may ask him whether any instructions for brewing from English fruits are soon to come out, or whether he really thinks that, because a hybrid *Amarýllis* is a beautiful object, a cross between a Greek and a Latin root will improve our language. Let him try a cross between a Swedish turnip and a rape, and see whether it is an improvement.

An old poet has given us a gardener's illustration in support of my doctrine:—

—————"Non est quod multa loquamur:  
Nil intra est oleam, nil extra est in nuce, duri."\*

I, am, Sir, your humble servant, — *Verjuice*.

*Derivation of the Word Monilifera.* — Sir, Mr. Fraser, or his commentator (Vol. IV. p. 217.), is inaccurate in supposing that *Pópusul monilifera* means "literally, one-bearing," although the "shoots" may be "twigless;" the word "monilifera" means necklace-bearing, or "bracelet-bearing;" so called from its beautiful, long, linear, crimson catkins, which appear suitable to form bracelets or necklaces. I believe the application was given by Linnæus, who was too correct a scholar, and had too good a taste, to botch up a word half Greek and half Latin, like a cauliflower bastardised by a savoy, as some gardeners and botanists nowadays do. But both the component parts of this name, *fero*, to bear, and *monile*, a bracelet or necklace, or similar ornament for the person (on the etymology

---

\* "No necessity for many words: 'There is nothing hard inside of an olive, nor outside of a nut.'" A proverb against those who deny what is manifestly true, or assert what is manifestly false.

of which word commentators are not agreed, but it was ancient Latin, and not derived from *μονος* (*monos*), one, nor imported from Greece), are of the same genuine stock. — *Verjuice*. October, 1828.

*Mr. Knight's Improvements in the Construction of Hot-beds.*—Sir, In vol. vii. part ii. art. 52. of the *Horticultural Transactions*, is a communication by the learned president of the Society, giving an account of the improvements in the construction of hot-beds. I have often observed that many inventions and discoveries are, in these days of knowledge, detailed as new and original, which have been long known and practised by scientific men in former times. In a book published two hundred years ago, in black letter, called *Alexis's Secrets*, is a clear and detailed account of the manner of increasing the mulberry tree, by cuttings of the great arms and limbs of the old tree, and planting them in rows, in beds, as we do asparagus. I could mention twenty instances of inventions and discoveries in horticulture and planting, which were known and adopted by our ancestors, and which have been republished in *Transactions and Magazines*, with all the freshness of a new discovery. But I have met with nothing so *original* as Mr. Knight's above-mentioned communication, and which trespasses so much on modern times, and on the fame of former philosophers. I beg to refer the reader to a paper of Dr. Stephen Hales, published in 1757, in vol. xxvii. of the *Gentleman's Magazine*, p. 165. He will there read "A rational and easy Method to purify Air, and regulate its Heat in Melon-Frames and hot Green-houses;" and he will wonder that Mr. Knight did not communicate the whole of the valuable paper, instead of an extract. I am, Sir, yours, &c.  
— F. R. S.

We have not the least doubt the omission was an inadvertence on the part of Mr. Knight, or the editor of the *Transactions*. Such inadvertencies are quite unavoidable, both in the *Transactions of Societies*, and in *Magazines and Journals*; but the great advantage the latter have over the former is, that corrections and discussions on all points are freely admitted. In this way, error and false doctrine, if promulgated in one Magazine, is corrected or counteracted in that which follows; and the reader will generally be found to have benefited by the discussion; but, in the *Transactions of a Society*, discussion is not permitted (See Dr. Thomson's paper, in our First Volume, p. 20., which was originally sent to the Hort. Soc., and rejected), and errors or mistaken views remain to lead astray, as long as such *Transactions* are read. The *Transactions of the Horticultural Society* have, however, one advantage in this respect, viz. that, from their high price, they are not likely to be read by practical men; and, therefore, if it were possible that such a thing as an error should creep into them, it would do little harm. — *Cond.*

*Plagiarism by the Author of the Article signed "A Blooming Bulb."*—In your Gardener's Magazine for October, you have given the cultivation of *Amaryllis* by "A Blooming Bulb." If you will look to my accounts of the treatment of them in the *Botanical Cultivator*, and the First Number of your Magazine, you will perceive the greater part to be taken from them. The mode of raising them, and shifting them, as they advance in growth, into larger pots, is fully described there, likewise their being kept on a gentle hot-bed; but with plunging them, if the bed be hot or moist, I entirely disagree, as it would be apt to melt or rot their fleshy roots. The use of horse-dung in the soil will certainly have the same effect, if fresh; but, if allowed to rot for two or three years, and then to be dried, it might do very well for lightening the soil, and would answer as a substitute for peat or other light mould. Your correspondent also mentions Mr. Colville as having raised three or four hundred hybrids of them. If he had said ten thousand, he would have been nearer the truth. I sowed the seeds and potted them off myself, and I have frequently seen several hundreds in flower at his nursery at once, some of them producing the most splendid flowers imagin-

able; but *A. vittata*, and the flowers from it, are longer in producing flowers from seed than any others. The most beautiful of all, I consider *A. vittata* fertilised by the pollen of *A. striatifolia*. Yours, truly, — *R. Sweet. Pomona Place, King's Road, near Fulham, Nov. 28. 1828.*

*Cobbett's Corn.* — Mr. Cobbett is by no means the first who has succeeded in raising the Indian corn in Great Britain. Several years ago, I witnessed, in the garden of Mr. William Stickny, of Ridgmont, in Holderness, plants of Indian corn reared from seeds of his own sowing, matured the preceding season in the open air. I remember to have been informed of a species of Indian corn sown as a successive crop in the Neapolitan territory, after the wheat had been reaped, called “*Mélica quarantina*,” or Forty Days’ Indian Corn, so termed in virtue of the extraordinary rapidity of its growth and maturation. Indian corn is there used, with extraordinary success, in the fattening of pigs, and has proved equally efficient in this country. The British farmer will scarce venture his capital on so fragile a basis as the cultivation of Indian corn. Now and then a favourable season may present itself; but, like “angel visits,” these periodic returns “will be few and far between.” It is vaunted that the leaves may be manufactured into paper, but what is there, nowadays, that has not been converted into what is called “paper.” The leaves and stems of the hollyhock and potato, straw, and sawdust, &c. — *J. Murray.*

*Indian Corn.* — I was the first who recommended the Indian corn for field culture in this country, which I did in a letter to G. Talbot, Esq., of Guiting, in this county, seven years ago. — *C. Hale Jessop. Cheltenham Nursery, October 50. 1828.*

*Verbena Melindris, by whom introduced.* — Sir, I observe in the *Botanical Register*, No. viii. vol. xiv. No. 1184., a drawing of a new *Verbena*, which was made from a plant, communicated, on the 20th of June last, by Mr. Harrison, gardener to the Earl of Egremont; and, as he has not stated in what way he came in possession of this plant, I conjecture it may be gratifying to the public to know by whom it was introduced. The seed of this *Verbena*, and various others, were collected in the neighbourhood of Buenos Ayres, by Mr. Poussette, and communicated, in 1826, from Rio Janeiro, to John Hawkins, Esq., Bignor Park, in whose garden it first grew, and flowered in May 1827, for the first time in this country. In the autumn of the same year, Mr. Harrison’s two sons called at Bignor Park, when I related the circumstance to them, and gave them a plant of the above-named *Verbena* with various others. Early this last summer, I was telling an acquaintance of my intention of getting it figured; he directly replied, “You are too late; for I saw it at Petworth garden the other day, and young Mr. Harrison told me it had been sent by them for that purpose. In a few days after this, I called on Mr. Harrison; and, when walking round the garden, with Mr. Harrison, jun., he showed me the plant in flower. I then told him I intended sending it to get it figured, but he was not candid enough to tell me what had been done respecting it either by himself or his father. I then determined to await the result of the information communicated by my acquaintance; and, finding his assertion true, I think I have an undoubted right to request of you to insert these few lines, to do justice to Mr. Poussette, and credit to myself. I beg the readers of this will not, for a moment, suppose I write it through any resentment against Mr. Harrison, as I certainly consider that he was at liberty to do as he thought proper with it; but I cannot but think it would have appeared better in the eyes of the public, had he been grateful enough to state in what way, and through whose goodness, he came in possession of it. I cannot say as yet whether this *Verbena* will stand our winters or not, without the help of a frame. I have one plant doing very well under a hand-glass, where it has flowered from May till the 10th of this month. Your constant reader, — *John Perry. Bignor Park, Petworth, Sussex, Nov. 24. 1828.*

*The Mildew curable.* — In Vol. IV. p. 281., there is an extract from Dr. Greville's *Flora Edinensis*, concerning mildew, of which it is stated that, "As its production is probably the result of a peculiar state of the atmosphere, there is little chance of any means being discovered for its prevention." This should not be allowed to pass unnoticed in the Gardener's Magazine, because it is well known to every one acquainted with practical gardening, that soap suds, applied in time, will prevent the attack, and, after the attack, will speedily banish the pest. — *M.*

*Price of Hot-water Pipes.* — This is not 1s. 6d. per foot, as you have stated (Vol. IV. p. 400.), but only 8d. — *Robert Reid. Monrath House, near Collumpton, Devonshire, Nov. 8. 1828.*

---

ART. IX. *Queries and Answers to Queries.*

*EVERLASTING Potato.* — An enquiry was made, in a former Number of the Gardener's Magazine (Vol. III. p. 379.), about this root. I received a few tubers, under this name, from Mr. Donaston, of West Felton. They seem to make no show of leafage above ground, and are of a small size, and thinly sprinkled under ground. They seem always ready to afford a supply of early potatoes, from one end of the year to the other; they are left undisturbed, except when a dish is wanted; they are not deeply embedded, but soon discovered on stirring the surface mould. (*July, 1828.*) Since I wrote you concerning what has been called the "everlasting potato," I have witnessed their being cultivated by a gentleman who is plentifully supplied with fine early potatoes about Christmas. The flower seems somewhat different from that of the common potato; those I witnessed in blossom on 28th last month (July), had been suffered to remain undisturbed from last year. I was informed that the potatoes were planted about the latter end of May; for, if planted sooner, they come in too early. Before frost sets in, the bed is covered with litter as a protection from its influence. They are taken up at Christmas, as fine new potatoes, and are either suffered to remain undisturbed, or perhaps, what is still better, the potatoes are completely forked up as they are wanted, and the smallest being separated are set apart for seed, under a heap, or hillock, to be replanted toward the close of the succeeding May. The smallest sprigs of this potato will grow. — *J. Murray. Inverness, August, 1828.*

*Diseases in Celery.* — Sir, In answer to the query of Mr. Parks (Vol. IV. p. 520.), I have to observe, that I have had considerable acquaintance with the disease in celery alluded to by him. An opportunity occurred last year, of sending some infected specimens to the Horticultural Society, to ascertain the name, and, if possible, the cause, as I had fancied it a fungus of some kind. Thence I was informed it was certainly a parasitical fungus, and called the *Puccinia Heraclèi*. In the autumn of 1826, I had my whole winter's crop totally destroyed it; it commenced its ravages at one corner of the piece, and principally in one row; and thence went progressively through the whole piece, until it had the appearance of having been scorched with the blaze of a fire. I cut off the infected parts, and buried them, but still the disease lurked among them. I then sprinkled the plants with water, and strewed, successively, lime and soot over them, but neither seemed to do any good. A border of fine endive, which stood near, was totally destroyed by the same disease. The next year I was entirely free from it; but one of my neighbours was in the same predicament that I had been the preceding season. I should rather imagine that it originated with something peculiar in the manure used for the trenches, which, in its decomposition, emitted some pernicious volatile property, that adhered to the leaves, and produced the fungus in question. — *Robert Errington. Oulton Park, Cheshire, September, 1828.*

*The Number of Men necessary to keep a Kitchen-Garden and Pleasure-Ground in good order.* — Sir, Your correspondent at Shipston (Vol. IV. p. 447.) wishes to know how many men he should regularly employ, to keep in good order a kitchen-garden, consisting of 2 acres, with 420 yards of walling covered with trees; also the same quantity of pleasure-ground; and whether his men have any right to work after their regular hours, without being paid for the same.

To query first, it is impossible to give a definite answer, as double the extent of a kitchen-garden may be kept in good order, where the soil is favourable, with the same number of hands, that can be done on some situations where it is difficult, nay almost impossible, to work the soil in very dry or wet weather. But a fair criterion is, a man to every acre, where the garden is walled, without forcing, and other troublesome appendages.

The number of hands for a flower-garden must be guided by local circumstances, viz. the manner in which the proprietor wishes it to be kept up, and the general characteristic feature which may prevail.

To his last enquiry, every one not completely devoid of rational sense and justice, will, without a moment's hesitation, give him an answer in the negative; and if I may venture an enquiry in return, I would ask, does your correspondent behave towards his gardeners with that kind feeling you have so often endeavoured to inculcate. If so, I have no hesitation in saying, those in his employ differ very widely from the generality of young men of the profession, if coercive measures are requisite to compel them to water plants, &c., in their own time. A generous and indulgent employer will always find young men more anxious to assist, when requisite, than to dispute the justice of an order or absolute command. — *A G. Oct. 4. 1828.*

*Number of Men necessary to keep a Kitchen-Garden in good order.* — Sir, A correspondent in the *Gardener's Magazine* (Vol. IV. p. 447.) wishes to know how many men he should regularly employ, to keep in good order a gentleman's kitchen-garden, consisting of 2 acres, with 420 yards of walling, covered with fruit trees; also, the same quantity of pleasure-ground, &c.; and whether his men have any right to work before or after their regular hours, of six in the morning and six in the evening, without being paid for the same.

Soil and situation varies so much, that, without some certain data were given, it is impossible to say what would be necessary to perform the above quantity of work. I have worked garden ground, in various parts of the country, of almost every kind of soil, from a light sandy loam to a tenacious clay loam; and the difference in quantity of work required, between the two extremes, I hold to be as one is to four, in respect to digging, trenching, and manuring, and nearly as much in planting and sowing. But many other circumstances should be taken into consideration. Is the garden new or old? are the trees in it healthy or unhealthy, or subject to be infested with insects, mildew, canker, &c.? If the garden is old, worn-out trees will require to be removed from time to time; also a great part of the exhausted soil of the border, and replaced with fresh soil previously to planting; and where trees are infested with canker, mildew, insects, &c., all these occasion a considerable extra-quantity of labour. Pruning, nailing, or tying the wall trees will be nearly the same in every case.

With respect to the pleasure-ground, if what is kept in grass be mown about once a fortnight throughout the season, the variation of soil will not make much difference in the quantity of labour. In that part kept under the culture of the spade and hoe, the proportional difference in labour will be as much as in the kitchen-garden.

Gravel ought also to be taken into consideration. The materials of which walks and gravel plots are made being so different, must occasion a considerable difference in the quantity of labour necessary to keep them in good order, although of similar extent.

With respect to garden men working over hours, I see no reason why they should, without being paid for it at the same rate as they are paid in the usual hours of working. It is customary for men to begin early in the morning to mow, but to give over when their hours are up. Also, garden men in some places are taken off to other employment at very unseasonable times: although it be but a day, or half a day, now and then, it is not unfrequently attended with great incōvenience to the proper conducting of garden work.

I am well aware of the difficulty of fixing upon the necessary quantity of men to be employed in every case, situation and local circumstances being so very different; but, doubtless, some approaches may be made towards fixing some certain data to refer to.

I have been induced to throw out these hints, on purpose to draw the attention of your correspondents to this subject, which I think of considerable importance, it frequently occasioning disputes between gardeners and their employers. — *An Old Gardener.*

*A humane Mouse-trap.*—A correspondent in a former Magazine (Vol. IV. p. 516.) complains of the cruelty of catching mice in a flower-pot, and leaving them to perish by a lingering death, and recommends the employment of some speedier method of destruction. I have found that sinking in the ground a common brown pickle jar even with the surface, with some hog's lard or kitchen fat, mixed with some oatmeal well browned before the fire, put in the inside under the neck or shoulder, and the jar half filled with water, the surface of which must be covered with oat-chaff to prevent their seeing it, is an effectual method; for, when the mice are feeding, they overreach themselves, and falling in, are drowned. If you think this answer worthy of notice, it is at your service. — *James Rollins. Dingle Bank, Jan. 3. 1829.*

*The Genus Phlox.* — Sir, In answer to the latter clause of your correspondent D. F.'s query in Vol. IV. p. 188., respecting the genus *Phlox*, I beg to state that the greatest number of species and varieties of this delightful and very ornamental genus, including *P. formosa P. MSS.*, *P. elegans P. MSS.*, *P. excelsa P. MSS.*, *P. Lyoni P. MSS.*, *P. cordata Elliott*, and *P. tardiflora Penny in Hort. Eps.*, may be obtained at Messrs. Young's nursery, Epsom. — *Alpha. Nov. 10. 1828.*

*Loudon's Hortus Britannicus.* — Sir, I have deferred purchasing a catalogue of plants these two years, in expectation of your *Hortus Britannicus* coming out: when will it be published? — *Ans.* It has been delayed a little by our absence on the Continent; but it will certainly appear in the course of two or three months.

Is the *Baltimore Pippin* in the London nurseries? — We are not sure that it is in the nurseries, but it may be had at Cobbett's garden at Kensington.

Why do you so frequently confound *Clapham* with *Clapton*? (See *Encyc. of Gard.*, first ed., p. 1284., and *Gard. Mag.*, Vol. I. p. 222., and Vol. II. p. 248., &c.) From you we expect more accuracy. — The numerous errors of this description in our *Encyclopædia of Gardening* are chiefly owing to the state of extreme ill health in which we were when we prepared the first and second editions of that work (the subsequent editions are merely stereotype impressions), and partly, as in the case of names of places and persons in the Statistics, Part IV., to the want of data. The errors in the Gardener's Magazine are inadvertencies, which we endeavour as much as possible to avoid; and we hope the longer we go on the more we shall improve in this respect.

Do you recommend keeping the *pathways of hot-houses*, where tropical plants and fruits are grown, flooded with water during winter? — This must depend on the temperature. We should think flooding could seldom



or never be necessary; watering, perhaps, occasionally. Experience must be the guide.

An answer to these enquiries will oblige your constant reader, &c. — *Joseph Winter. October 29. 1828.*

*Touching the Growth of Vines when trained down from the Rafters.* (p 237.) — I wish to know whether the vines are never, in such case, permitted to bear on the rafters, but are merely pillared, as it were, thus (fig. 23.), in the house. If the rafters are suffered to carry fruit, as well as

23

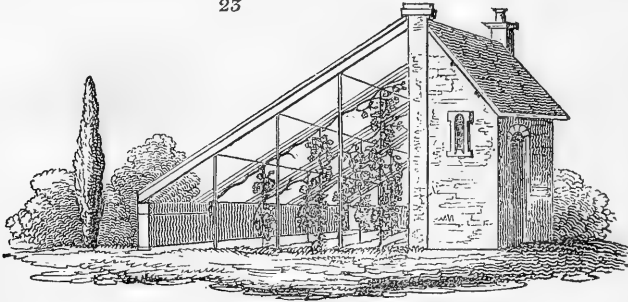

the descending branches, light sufficient could not be got, unless the rafters were sufficiently distant from one another, viz. 5 ft. perhaps, to admit of the sun in the intervals. Perhaps your correspondent could throw some farther light on the subject. — *C. M. Norfolk, Aug. 1828.*

*Stopping Cucumber and Melon Plants in early forcing.* — Sir, In looking over the extracts which you have given from the *Transactions of the Horticultural Society of London*, I find one of them, by Dr. Van Mons, on budding and grafting roses, which you have illustrated by excellent and accurate wood-cuts in a manner extremely creditable to your very useful Magazine; indeed, the operations are rendered thereby so plain, that the most unpractised amateur may perform them without difficulty. This has suggested to me an idea, that, by similar means, instructions might be very plainly and easily conveyed to amateur gardeners respecting the proper method of stopping cucumber and melon plants in early forcing; for although this process, as well as the method of inserting a bud or fixing a graft, is known to every professional gardener, yet many gentlemen, who take pleasure in attending personally to their framing, are wholly unacquainted with the true principle of stopping their plants. They are told, indeed, in gardening books, to pinch off the ends of the runners at a certain point, which they do: but, beyond this, they know nothing; and consequently their expectations frequently, and indeed generally, end in disappointment. If, therefore, some one of your numerous scientific correspondents would favour your less informed readers with a plain statement, accompanied by figures, upon the principle of those so judiciously added to Dr. Van Mons's paper, of the method of stopping cucumber and melon plants, particularly the latter, so as to insure a crop, with some general instructions as to the proper mode of managing them, so far as relates to heat, watering, &c., I am of opinion it would not only be very favourably received, but would confer considerable obligation on, and convey much useful information to, many of your subscribers, who at present stand greatly in need of such instructions; of the truth of which I have ocular and daily demonstration. I remain, Sir, yours, very truly, — *Mentor. June 21. 1827.*

*The Stock Gilliflower, Cheiranthus incanus.* — Sir, Can you, or any of your correspondents, inform me of the best method of cultivating the *Cheiranthus incanus*, the stock gilliflower, so as to procure double flowers,

as they are as great ornaments to the flower-garden, during the months of May and June, as any of the beautiful flowery tribe, and therefore deserve as much attention? I have heard many gardeners say that a sure way of obtaining many double flowers is to make choice of those single flowers which grow near many double ones; but I would ask if this is not a hypothesis, as the *Cheiránthus* is a genus of the class *Tetradynamia*, and the flowers hermaphrodite; therefore I cannot conceive how the double flowers can make any difference to the single ones, unless they are like the flocks of Laban which Jacob fed.

Furthermore, I would ask, *which are the most judicious steps to be taken by the young gardener to raise himself to the highest ranks of his profession, if there is no safety for him without it?* I am, Sir, &c. — *A Young Gardener. Farrington, Nov. 17. 1828.*

*Small Selection of Pears and Apples.* — Will some correspondent who has had considerable experience in the pomological department of gardening, be good enough to hand you a list, for insertion in your next, of the most superior apples known, which must be all good bearers, and of superior flavour. I should say three for early dessert, three for a middle season, and six for long keeping, and all table fruit; and name also as many for kitchen purposes; all to stand on paradise stocks: likewise, a list of twelve or so of the most superior pears we have, good bearers, and of superior flavour, to stand on quince stocks, for walls and espaliers, and divided into successive seasons, as with the apples. Such a list would be of considerable service to many who are compelled to be very careful in their selections, from want of land, as well as to your well-wisher — *Robert Errington. Oulton Park.*

*Apple Trees fit for an Orchard.* — Sir, Allow me to submit the following queries to any of your correspondents who may be disposed to favour me with a reply founded on experience: — In an orchard of 2 acres, about to be planted, what are the best sorts of apples and a few pears (standards), selecting such as are good bearers, and come quick into bearing, one of each sort? Does any of your correspondents know the Northern Greening, as it is called in the midland counties? That and the Wyken Pippin, so highly spoken of in your Second Volume, p. 486., are the chief table and kitchen apples respectively in Warwickshire and the adjoining counties. They are both excellent, but not generally known. I am, yours, &c. — *J. S. L. Jan. 14. 1829.*

*Chlidánthus frágans and Brunsvígia toxicària.* — If your able correspondent, “A Blooming Bulb,” or Mr. Sweet, or any one conversant with the beautiful tribe of *Amaryllidææ*, would describe the habits and culture of *Chlidánthus frágans* and *Brunsvígia toxicària* (*Boophànè toxicària* of the Hon. and Rev. W. Herbert), they would much oblige — *An Offset. Swansea, Oct. 6. 1828.*

*Brookshaw’s Pomòna Britànnica.* — I am desirous to know if there is letter-press to this work in existence; and if there is, where it could be got. — *W. H. Kew, Sept. 30. 1828.*

*Canker in an Orchard.* — The trees are of four years’ growth, and I am sadly troubled with the canker. I fear I must cut them down. What would any of your practical readers advise me to do? — *W. G. W. Lancashire, Sept. 8. 1828.*

*Cobbett’s Corn.* — Mr. Cobbett has written a most excellent and amusing book on Indian corn, and has explained at large all the uses to which it can be applied, except making beer and spirits of it. It is known that large quantities of the latter article are made from it in Adams County, Ohio, Cincinnati-Ohio, Nelson County, Kentucky, Cayuga County, New York, and doubtless in many other parts of the United States. Indian corn and rye are generally mixed about half and half. The produce from the Indian corn by itself is represented to be about two gallons from each bushel of the corn; but I do not find the mode of malting or the process of the distillation

at all described. Perhaps some of your correspondents could give information on these points. I would farther beg for any facts relating to the growth of Indian corn in any of the West Indian colonies. I am persuaded it might be most advantageously adopted as a main crop in very many of them, either for use as a grain, or for the manufacture of spirits. I, however, fear it has not been attempted in the large way. — X. Y. Jan. 15. 1829.

---

ART. X. *Obituary.*

DROPPED down dead at his own door, in the presence of his wife and child, on the evening of the 28th of August last, *Charles Davidson*, gardener to Laurence Jephtha Marshall, Esq., in the neighbourhood of Clapton. Mr. Davidson having been above a year in our employ at Bayswater, we can assert, of our own knowledge, that he was a very good gardener, and of orderly, regular, and respectable conduct. Never having been fortunate in the world, he died exceedingly poor, and we take it upon us to solicit from the humane and charitable some assistance for his widow and child. Whatever is sent may be addressed to Mr. Mackay, of the Clapton Nursery, who will see it properly applied.

Died, at Dublin, on the 15th of December last, after a long and severe illness, *Mr. Alexander McLeish*, landscape-gardener. Mr. McLeish came to England in 1809, and after laying out a small place in Oxfordshire under our directions, was sent by us to act as foreman to execute a plan in Norfolk. He remained there two years, and afterwards came to London, where he employed himself in studying drawing, geometry, and architecture, and in pursuing a course of reading on subjects connected with taste in rural improvements. About the end of 1814 he went to Ireland, and commenced business as a nurseryman and landscape-gardener. In the former he was unsuccessful, and incurred debts which he had only been able to pay off a few months before his death. He was a man of good taste and judgment in his profession, of great activity, and of inflexible integrity and honour; but, unfortunately, was very frequently laid up with bad health. He lost all his children, and has left a widow bereft of all the ordinary endearments of life, and so destitute of the means of support, that Mr. James T. Mackay, Curator of the Trinity College botanic garden, Dublin, and a few other friends there, have set on foot a subscription for her relief. In this subscription we most sincerely hope a number of our readers will join, and convey the amount they can spare to Mr. Mackay, or to us. The smallest mite will be acceptable, both in this case and in that of Mr. Charles Davidson. Direct to Mr. James T. Mackay, as above, or to us, through our publishers. The list of subscribers in both cases will be published on the cover of the Magazine.

Died, at Paris, in his house in the Jardin des Plantes, *M. Bosc*, Chevalier of the Legion of Honour, Royal Academician, Member of various Societies, and Professor of Cultivation in the Jardin des Plantes. Of this excellent character we shall give a biography in a future Number.

---

THE  
GARDENER'S MAGAZINE,  
APRIL, 1829.

---

PART I.  
ORIGINAL CORRESPONDENCE.

---

ART. I. *Notes and Reflections made during a Tour through Part of France and Germany, in the Autumn of the Year 1828.* By the CONDUCTOR.

(Continued from p. 9.)

*LONDON to Brighton, August 29. 1828.*—The roads of Britain are characteristic of the people and the government; their irregular natural-like direction, bold and free, and yet sometimes constrained and awkward, is a consequence of the independence of local legislation, and of the security and inviolability of individual property. Till lately some of the principal roads were crooked, of irregular widths, and circuitous in their direction, even in the neighbourhood of the metropolis; and the manner of forming and repairing roads differed in almost every district. The reason is, these roads have risen, like the English Constitution, by degrees, out of the wants of the people, in their progress from a rude state to that of regular civilisation; in districts where commerce created a demand for good roads, they have been improved by the magistrates of the county; in others which have remained in the agricultural stage, or where, from other causes, intercommunication was of less consequence, the horse tracks of past centuries have merely been widened to admit the passage of carts; in every district where small properties have stood in the way of improvements in the direction of roads, the value of these properties, or the arbitrary price set on them by their pro-

prietors, by preventing their purchase for the public benefit, has produced that circuitousness and those abrupt turnings, which we find in some places, and which, however inconvenient to the public, may be considered as so many tributes to the inviolability of individual property, as well as proofs of want of patriotism, of selfishness, or of obstinacy in individuals.

In France and Germany the roads proceed in direct lines from one town to another; they are everywhere of the same width, and every where, as far as practicable, formed in the same manner. The reason is, the roads in these countries have for centuries been under the direction of the central governments; probably more or less so since the time of the Romans. Why governments on the Continent, and not in England, took the direction of the roads, is accounted for by considering that roads on the Continent form almost the only means of communication between one government and another, while Britain communicates with other governments by the seas.

No small part of the beauty of English scenery results from the windings of her roads, and the ever-varying disposition of trees and hedge-rows which border them; and no small part of the formal grandeur and sameness of many parts of Continental scenery is the result of the interminable avenue of elms, poplars, or fruit trees, which accompanies the traveller.

The roads of Britain and the Continent may differ in picturesque effect, and yet equally answer their principal object, the most direct and easy access from one point to another. When the surface is level, the advantage of the straight line, in this respect, is obvious; but, unfortunately, where the system of straight lines prevails, the lines are carried indiscriminately over hills and through valleys, gaining nothing in point of distance, and losing much in point of ease and beauty. The fault of the irregular or curvilinear roads of England is that of changing the direction at every trifling obstacle, and thus rendering it circuitous, and sometimes dangerous, from abrupt turnings. The faults, however, both of the straight-lined and curved-lined roads are rapidly disappearing; those recently laid out, both in France and England, combine the good parts of each system, and have attained to a high degree of perfection. The Brighton road, though carried through a country presenting no difficulties, is still a very good example of an improved modern road, well directed or laid out, properly formed, and carefully kept, on Mr. M'Adam's principle. It is remarkable that a considerable part of a road so near the metropolis should pass through a country, the Wealds of Sussex, comparatively uncultivated and uninhabited: but this is accounted for partly from the

poverty of the soil, but chiefly because this road, in former times, led to no main object; Brighton, till lately, having been an insignificant village, without a port or harbour for shipping.

As one is always seeking something further than they have already attained, the question occurs, whether English roads would be improved by the adoption of the Continental avenues, either of fruit or forest trees. In a general point of view, we answer, without hesitation, they would not; but we certainly should desire to see fruit trees introduced more or less almost everywhere; not only in the hedges by the roadside, in margins of plantations, and in cottagers' gardens, but in the common field fences of the country. We would not introduce them regularly, nor in such numbers as to injure the roads, hedges, or crops, by their shade; but here and there with different kinds of forest trees intervening; and we would take care to make choice of varieties which assume pyramidal forms of growth, and whose fruits were small, and not liable to be blown down by the wind. The cherry and the pear are particularly eligible as hedge-row fruit trees, and would supply kirschwasser (Vol. IV. p. 179.), and perry; and entire hedges might be made of many sorts of plums and apples, for plum brandy (*Encyc. of Agr.*, § 616.), cider, preserves, and tarts. The common objection to planting fruit trees in hedges, is that depredations would be made on them by the poor; but it is to avoid such depredations on the fruit trees of the rich, and to assist in humanising and rendering better and happier the poor, that we are desirous of introducing fruit trees everywhere. If the poor in Britain and Ireland were rendered what the poor are in Wurtemberg and Baden, fruit trees here would be as safe as they are there. If apples and pears were as commonly grown as potatoes and turnips, depredations would not be more frequently committed on the one kind of crop than on the other.

Besides beautifying the public roads by a sprinkling of fruit trees here and there among other trees, we think something might be made of the milestones, with a view to the same object. In some places of Bavaria a semicircular area of turf, 15 or 20 ft. in diameter, is formed half round the milestone, open to the road, and the curve bounded by a close row of trees. Immediately within the row of trees is a bench of turf, as a seat for pedestrian travellers; and close behind the milestone are three turf steps, of 3, 4, or 5 ft. high, for the purpose of affording rest for persons carrying burdens on their backs or heads. In various parts both of Germany and France, and particularly in Wurtemberg and Alsace, stone benches are

placed along the roads, at different distances, near the large towns, as seats, with elevated benches adjoining them, of two different heights, for the purpose just mentioned, of allowing persons carrying heavy baskets to market on their back or head, to stop, set down their baskets, rest themselves, and take them up again without assistance. These stone benches, and the turf steps indicate a most humane attention to the laborious classes, and to the very poorest people, on the part of the government, and must greatly attach the inhabitants to their rulers; for in no country or condition of life is kindness lost on human nature; it is not even lost on the inferior animals, and is in fact the leading principle of domestication. These resting-benches are less required in England than on the Continent; because in this country the markets, instead of being supplied by very small proprietors, who send their produce to market, often (and perhaps it is less to be regretted than at first sight it would appear) on the backs or heads of their wives and daughters, are supplied by men of capital, who keep horses and carts: but, still, for the fruit-women in the neighbourhood of London and other large towns, they would be useful and humanising, and possibly they may one day become necessary.

The roads in populous Catholic countries are rendered very interesting from the crucifixes, statues of saints, stations, &c., erected along the approaches to many villages and towns. It does not belong to the progress of things to return to these subjects for rendering roads interesting: but the saints and heroes of philosophy and modern history might be substituted for these, who were in fact the philosophers and heroes of their age; and we would not object to the eminent warriors of modern times, though, we have little doubt, the glory which surrounds their names will be reckoned, by posterity, as vain as the present age reckons false the glory of the saints and martyrs of the dark ages of religion and chivalry. It is right, however, that those who have had the merit of their age should have the reward of their age; therefore we desire to see columns surmounted by statues of naval and military heroes, for the admiration and respect of their contemporaries, and to mark the progress of civilisation to posterity.

It has been suggested to us \* that milestones might be made larger, of the form of an obelisk or sarcophagus, on the model of an ancient classical or other building, or of other forms, and that there might be inscribed on them the names

\* By our correspondent *Variegata*, who once promised us a paper on the subject.

and dates of events which took place, or of great men who lived, in the neighbourhood; and that, in addition to these, there might be inscribed on each milestone, or structure serving the same end, maxims of conduct, or fundamental principles of science. Thus, on some roads the milestones might exhibit sculptured reliefs, representing a historical series, either of events in the history of that part of the country, of the life of some eminent character who had lived there \*, of the progress of discovery in some art or science of the human mind generally, or of general history. If all the proprietors on a line of road were agreed, a group of exotic trees and shrubs might be planted as a back ground to a small area, which might contain the milestone; and by limiting every group to one genus of timber tree, and one or two fruit trees, considerable variety would be produced, and the botanical interest of the road kept up for many miles. Small burial grounds round milestones would, we think, be unobjectionable, and indeed we do not think they could be better placed; and tombstones there or anywhere along the roadside would attain their end more effectually than in churchyards, and, at any rate, would be what is called classical, which is an excellence to be aimed at, and which is beneficial in a certain stage of progress, but too often, in architecture and sculpture, for example, an impediment to improvement, by being considered the highest degree of excellence. Some one (if we are not mistaken, Sir Richard Phillips) has proposed to build cottages as milestones, and to that plan and to various others, we have no objection, to a certain extent; the danger being the production of sameness, by adopting the same plan everywhere.

When we consider the immense number of milestones and guide-posts that are wanted for the main, secondary, and by-roads, and of name-posts for villages and hamlets, there is ample room for the exercise of architecture, sculpture, and arboriculture, and for patriotism and individual distinction in the rich who have no heirs, and who may have seen the little use in leaving money for what is called charitable purposes. With so many cathedrals, churches, country palaces, castles, and villas, parks, gardens, woods, forests, and waters already, and with the additions which the imagination may create from these rude hints; with the result of what we have formerly suggested on the subject of education (p. 8. 84. and 94.), and of the adoption of what our highly valued correspondent, Mr.

\* The life of the great Lord Erskine, for example, might form a series of relievos from London to Crawley. A series of statues of the priests of all nations, from London to Oxford; of philosophers, from London to Cambridge; of legislators, from London to Edinburgh, &c.



Spence, has just sent us (p. 125.) on the subject of general amusements, Great Britain might indeed, as he observes, become such a paradise as, at least, has not appeared on the earth since the deluge.

The road to Brighton being new, and through a new country, is the reason why it is bordered by so few distinguished country seats. Near Croydon is Beddington Park, celebrated for having been the first place in England in which orange trees were grown, though we cannot but think it very likely that they may have been long before introduced by the Italian monks, who in all ages have been attached to gardening, fond of fruits, and skilled in their culture. Near Crawley is Holm Bush Lodge, for a number of years the property and residence of the celebrated Lord Erskine, where he planted extensively, and where some fine large specimens of American shrubs remain to attest his success. This place has lately been purchased by the son of an eminent tradesman, who, in his time, was as celebrated as Lord Erskine.

This gentleman has built a handsome baronial castle in a commanding situation, and very properly; because in this country there is something higher for commercial men to aim at than wealth and abundance, that of ranking themselves with the aristocracy. To live in the style of a gentleman in a baronial castle, creates a resemblance to the desired rank even in a retired tradesman, and for the sons of his son the thing is done. The consolation for those who are not so fortunate in trade is, that in two generations the manners and intelligence of the different ranks of society will be nearly the same, at all events much more so than at present. Where there is less difference between the different ranks in point of knowledge and manners, there will be less of exclusive privilege and less in point of happiness, and, consequently, less ambition to rise from one rank into another. The means, in such a state of things, we may hope, will be less likely to be mistaken for the end; a tradesman born, educated, and living like a gentleman, of whom there are some even in our days of ignorance and ambition, would be very well content to die in the rank in which he had lived, and to leave his children in that rank.

*Brighton, August 30.* — Brighton is one of those towns that could be produced only in England. With reference to the ordinary causes which create a town, its situation is unnatural, without a harbour, and with less advantages in point of sea-bathing than many other situations on the coast. It is no doubt a boarding and landing place for travellers going to or coming from Dieppe; but that can have little effect on its increase, which, like that of Bath some years ago, was begun by

fashion and continued by the wants of society. Brighton, like Bath, is a town of enjoyment, and, in respect to its future prospects, may be classed with that city. As the people of England become more intellectual, they will feel the want of such towns, and another age will see cottages and farm-houses clustered together in villages for the sake of social enjoyments, as they were formerly for the sake of personal security; and the tradesmen of commercial and manufacturing towns retiring to watering places and towns of enjoyment, instead of secluding themselves in Wales, or the Highlands of Scotland, or attempting to establish large and extensive hereditary mansions and domains. It is this new and increasing want in the middling classes of society, which is the principal cause of the increase of London, and other large towns. Those of limited incomes find they can procure more enjoyment there, because enjoyment, like other articles, is cheapest where it is most in demand; in large towns, also, aristocratical influence, which, as intelligence increases among the middling classes, is felt to be an evil, and as the middling classes increase will naturally be diminished, is less apparent; talent and worth also have a better chance of finding their level there; and tastes of every kind of finding those which are congenial. Our increased intercourse with our more lively neighbours, has increased our taste for the pleasures and amusements of society, and, with other causes, has induced many individuals to join the middle ranks, who by birth and education should have belonged to the higher. The middle rank is also continually increasing in numbers, in consequence of the superior education now given to the sons and daughters of every description of commercial men. Though the first impulse to the prosperity and increase of Brighton, therefore, was given by the King establishing a casual residence there, yet the permanent support of so large an assemblage of dwellings will be owing to the great increase in numbers, in intelligence, and in good taste, of the middling classes of society.

*The Oriental Garden* was the first object we sought for, and we were not surprised to find that this establishment had been long since broken up. The ground, about an acre in extent, and the buildings, consisting of a conservatory and intended public room, have been purchased by Sir James Scott, who has added considerably to the buildings, and converted the whole into a commodious residence, but who has not yet had time to make the most of the garden. The conservatory is large, with a curvilinear roof, but not elegant or well ventilated; to make the most of it and of the garden, a better gardener will

have to be kept than is usually done in such places ; because, among other things, there is the sea air to contend with.

*An Architect's House.* — An architect near the Oriental Garden, whose name we do not mention (not that we do not know him to have too much good sense to take offence at our remarks, but simply because we intend the essential part of these remarks to apply generally, and in truth knowing very few exceptions), has built himself a fanciful house, bearing considerable resemblance to the King's Pavilion. It is a fact, that very few architects build for themselves such houses as a private gentleman would choose to live in : they are so completely engrossed with the means, that they forget the end ; so entirely occupied with their knowledge of their art, that they forget to be wise, i. e. moderate, in its application. Economy and convenience necessarily require much of the architect's consideration, and, unfortunately for the health of occupiers, these requisites lead to the practice of getting many parts into little room. In his own house the architect generally contrives to have something of every thing, because he is proud to show that he knows how every thing may be provided for ; and his desires, in consequence of an ill-regulated mind, from defective education and prejudiced taste, exceeding his means, he is of course compelled to have every thing in very little space. A gardener is likely to fall into the same error in laying out his own garden, and very probably there is no architect who would not make the same objection to our crowded little paradise, that we do to their miniature mansions or palaces. The apartments in the house we allude to are numerous and elegantly furnished, but so very small and low, that the cubic feet of air contained in all of them put together would not fill more than a good-sized sitting-room. We are persuaded that the importance to health of having an ample volume of air, and of having a stream of fresh air constantly entering into and passing from that volume, is not thoroughly understood among architects generally, otherwise they would never build such houses for themselves, nor consent to such low ceilings and small-sized rooms as we find even in the best houses. Rooms with low ceilings are often rendered still more unhealthy than they would be, by the windows being so placed as not to admit of complete ventilation. Wherever the windows of a room are not carried so high as the cornices, the stratum of air above their level may be considered as undergoing very little change, even when the windows are opened, and scarcely any change when they are shut. The unwholesomeness of servants' bedrooms in great houses, and of the upper bedrooms in many of the street houses in London and Brighton, in this respect,

calls loudly for reprobation. We conceive it to be the duty of architects, and of all professional men, to be ahead of their employers in point not only of scientific knowledge and taste in their art, but in the knowledge of what constitutes all the different comforts, conveniences, and luxuries of a dwelling-house; and we therefore think that they ought to refuse their consent to an employer who should propose to design or construct such unwholesome apartments as those to which we allude.

We had no time to look at the exterior architecture of Kemp Town, and other new buildings, in such a way as to receive lasting impressions from particular edifices. The general effect of *Brunswick Square*, and the terrace of that name fronting the sea, is grand, but would have been grander still if the terrace had been more distinctly broken into parts, by advancing, retiring, and high and low masses, without which no whole, however much it may strike at first, will ever be worth looking at for any length of time.

The area of the square is laid out by Mr. Stent, a gardener, in clumps so placed as to protect one another from the sea breeze. He mentioned that of the two species of *Tamarix*, the *T. gallica* throve the best. He also mentioned that the common elder grew luxuriantly, and that there was a new Dutch variety in the garden of the pavilion which was found to grow faster than the indigenous one. Mr. Stent has a small nursery, No. 48., on the London Road, containing some showy flowering plants, and in very good order; his son is a professional collector and preserver of objects of natural history, and has a good many butterflies, moths, and Coleóptera, for sale.

*Parsons' Flower-Garden*, 105. *Western Road*, contains a very good vinery, with a stage well stocked with showy sorts of geraniums. We found Mr. Parsons destroying insects on some of his pot plants, by placing them in an empty barrel set on end, putting on the lid quite close, and blowing in tobacco smoke by the bung-hole. After they remain an hour, they are taken out, and syringed with clean water.

*Rogers's Flower-Garden*, 25. *Regent Place*.—There is a good vinery, and it contained an ample crop of grapes nearly full-grown, but the berries of many of the bunches were shriveled up, owing to the mistaken practice of taking off the leaves in order to allow the sun to ripen the fruit. Taking off the leaves which proceed from or near the foot-stalks of any fruit, can only accelerate maturity by stopping the supply of nourishment; in consequence of which the fruit becomes shriveled, and, while its skin is coloured by the direct influence of the sun, its juices remain unchanged, or at least unsweetened and

without aroma. When fruit is full grown, and the ripening process has commenced, the removal of a few leaves where the fruit is completely shaded is advisable; but, even then, these leaves ought never to be those which are so close to the fruit as obviously to be the laboratories of its nourishment.

*Brighton to Dieppe.*—Suspension bridges and piers, and steam boats, have come rapidly into general use since they attracted attention not more than fifteen years ago. Few impressions combine the grand and the useful to such a degree, as that of a large steam vessel sailing out from a pier or quay, like a coach and horses starting from an inn-yard. What may be the effect of steam on naval warfare, we suppose, cannot be very well foreseen; but if, like the invention of gunpowder, it simplifies or shortens the work of destruction, it may be considered as a step gained in the progress from fighting by matter to fighting by mind.—In spite of a contrary wind we made the passage in twelve hours, arriving at Dieppe at midnight.

*Dieppe, August 31.*—No two towns so near each other can be more unlike than Brighton and Dieppe. The former is the sudden result of immense wealth guided by the desire of still more, and accompanied by a moderate degree of taste; the latter is the result of wealth acquired in former times, slowly, and to a moderate extent, guided also by a desire to profit, but accompanied by a greater proportion of taste, or, in other words, of care in the expenditure, which leads to the application of more thought to the design. That Brighton, in its architecture and domestic arrangements, is higher in the scale of civilisation and enjoyment than Dieppe, there cannot be a doubt; but that there is more mind, in proportion to the wealth displayed, in Dieppe is equally evident. The high ornamented gable ends, the cornices, the mouldings round the windows, and the pediments over the doors, of even the commonest street houses, show that a house in Dieppe is considered something worth enhancing in interest by ornament, and the credit of having built it worth appropriating by placing on it the arms or initials of the proprietor.

The same cause which produced careful design in the common street buildings of Dieppe, produced curious design in the holiday dresses and the carefully decorated persons of the inhabitants; and this cause also prevents both from being much changed by fashion. It is only in rich and commercial countries like England, or in countries of comparative equality of rank and riches like America, where the habit of changing the fashions of buildings and dress is general in society. In Dieppe, and in all the provincial towns of France that we have seen, there are a small number who, at a certain distance, follow

the fashions of Paris ; but the great mass are, and have been, clothed with the same forms and colours for centuries past. In France, the same holiday dresses often descend from the parents to their children, even in the lowest orders ; in England, a grandchild in this class is more likely never to have heard of his grandfather's existence ; for ignorance and the necessity of continual hard labour, both of parents and children, seldom allow the English mechanics to have more than two ideas, getting and expending. The great prosperity which is attending the cotton manufacture in France, will probably soon revolutionise the dresses of the country people, and give a reciprocal stimulus in industry to manufacturers and agriculturists ; but, we hope, education, and their natural vivacity and love of amusements, which is in fact the love of life, the love of being convinced that we exist and are capable of being made happy, will prevent them from falling into that dreadful state of degradation, which is, or was till lately, characteristic of the Lancashire operative manufacturer.

There are very few gardens in or about Dieppe, which must arise from the want of wealth among the inhabitants ; because the climate, unlike that of Brighton and other marine towns exposed to the easterly winds, is favourable to vegetation. We observed one or two very small spots curiously and carefully laid out, and a miniature orchard, containing, besides the ordinary fruit trees, specimens of the true service, medlar, quince, Spanish chestnut, and walnut. Each tree was planted in a circle of about a yard in diameter, edged with box : in the circles were various flowers, and the intervening spaces were covered with gravel. The object evidently was to produce as much fruit as could be grown on so limited a space ; every variety of walking backwards and forwards in the shade ; and the fragrance and beauty of such flowers as will grow under the drip of trees. We looked into another spot planted with pear trees, trained *en pyramide*, and very neatly kept.

There were not many pots of flowers in the windows of the street houses ; but such as we saw were characteristic of the present state of botanical taste in France, and of the state of the same taste in England about the middle of last century, viz. orange and pomegranate trees, the former with fruit and blossoms ; the *Cápsicum Amòmum Plínií* (*Solànum Pseùdo-cápsicum*, Vol. II. p. 378.), beautifully covered with fruit, and indeed it is a most ornamental plant ; one or two myrtles, and some stock gillyflowers and carnations.

*The Dieppe Nursery.* — The only nursery that we saw was that of M. Racine, fils. This tradesman belongs to a local

family, who have been gardeners for upwards of three centuries; his father is gardener to a country gentleman, about three leagues from Dieppe, who is very old, and has occupied himself incessantly with astronomy for upwards of thirty-five years. M. Racine, père, works two hours a day in the garden, and the remainder of the time is with his master in the observatory. M. Racine's nursery may contain five or six acres. The chief articles cultivated are standard roses, of which he has nearly 500 varieties; but he also grows fruit and forest trees, and possesses a collection of green-house plants, and some American shrubs, of better species than we should have expected from the situation and the demand; in short, like country tradesmen in general, he cultivates something of every thing, including, not only flowers, but some descriptions of vegetables and fruits; as cauliflowers, lettuces, strawberries, and Honfleur melons. Roses and georginas, however, are the present fashionable articles. Among the green-house plants are several species of magnolias, five or six varieties of camellias, ten or twelve sorts of oranges and lemons; *Laúrus*, two or three species; *Brugmánsia arbòrea*, *Clèthra arbòrea*, *Ficus elástica*, *Rhododéndron arbòreum*, six or eight species of heaths, ten or twelve sorts of geraniums, and three or four genera of New Holland plants. The collection of georginas amounts to forty or fifty varieties, yearly increasing; tulips, upwards of 100 varieties, and the collection of other bulbs and of carnations in proportion. M. Racine informed us that there were several noted tulip-fanciers in Dieppe: we were introduced to one gentleman, and another was named to us who was what is called ruined by the fancy. For such a sacrifice we ought at least to record his name, which is Sibel.

M. Racine grows his standard roses close together, in beds about 4 ft. broad, edged with the fraisier perpetuel, or alpine strawberry, of which there are several varieties, some of them greatly superior to others, and propagated by runners. Propagating this variety by seed, as is most commonly done in England, is considered by M. Racine a random method, which may produce good or bad sorts, and which does produce, most generally, many bad sorts, mixed with but few good ones. There is also a variety, valuable for edgings, which does not produce runners, and which is propagated by division.

But the most remarkable cultivation of this part of France is that of the Honfleur melon, which M. Racine also grows to a small extent. This melon is of an oval form, sweet, but not very high flavoured, and is eaten more as a legume than as a dessert fruit. It is extensively cultivated at Honfleur, near

Havre, for the Paris market and for Brighton: but it is also cultivated at Havre and at Dieppe; and by M. Racine, who showed us his melon-ground, and furnished us with an outline of the culture, as practised at Honfleur, which we shall give in our next Number.

(*To be continued.*)

---

ART. II. *Remarks on the Education and Amusements of the Lower Classes.* By WILLIAM SPENCE, Esq. F.L.S.

Sir,

As the general education of the lower classes, in which like yourself I take a deep interest, is closely connected with that of gardeners, and is, besides, a branch of that "domestic improvement" which the title of your valuable Magazine embraces, perhaps you will allow me to occupy one or two of its pages, in stating that all my observations, in my various tours in the south of Germany, fully confirm your opinion, expressed in recent Numbers of the Gardener's Magazine and Magazine of Natural History, as to the decided superiority of the German peasantry over the same class in England, in civility, information, morality, and, I may add, independence of character. Common labourers in Germany have repeatedly refused the money which I offered them, after asking questions respecting their occupation, or after they had rendered little services, such as putting to rights the traces of our carriage, &c. This never happened to me in England, and I am afraid, with Mr. Touchwood, would not now in Scotland, whatever might have been his experience there, on this point, forty years before his visit to Marchthorn and St. Ronan's Well. Every one, too, must agree with you, that this inferiority on our side (for a striking fact in proof of which, I refer your readers to a note I send you herewith, on the public garden at Frankfort for your Foreign Notices), so painfully mortifying to the English observer, is to be rectified only by the general and improved education of our lower classes; to which, if the one hundredth part of our money had been devoted, that has been wasted on objects of infinitely less importance, the British empire might have now been a perfect paradise. Much may yet be done; but it is clear that the education wanted is not the humdrum system of our ordinary village schools, which is a mere waste of time, but such a combination of the best parts of the plans of Bell and Lancaster, Pestalozzi and Fellenberg,



with the field and garden instruction of the Bavarian schools, as will teach things as well as words, and indelibly implant in the scholars a love of order, good manners, knowledge, and virtue.

To the general and improved education of the lower classes in England, should be added the promotion of rational and humanising *amusements* amongst them, in addition to their present ones of mere strength and address, by the money, countenance, and sympathy of the rich. Each school-room, whether in villages or towns, should be easily convertible into a ball or concert room; and itinerant teachers of music, singing, and dancing, all teaching on improved systems, should give lessons on very moderate terms to the youth of both sexes; while the gentry should promote politeness and good-breeding by their presence at these balls and concerts, as Montaigne tells (in his *Travels in Italy*, in 1581, now before me) he did, when at the baths (*bagni della villa*) near Lucca, where he invited all the peasants of the neighbourhood to a ball (his account of which, given with his usual delightful *naïveté*, fills eight pages), and distributed, with the aid of a committee of ladies, ribands and various other prizes to the best dancers.

At other times, short courses of lectures, *really popular*, should be delivered by itinerant lecturers in natural history, physics, gardening, and agriculture, in these school-rooms; which once a year might, for a week or two, be turned into theatres for the performance of dramas, such as the highly amusing ones of Miss Edgeworth, and others to be written like them (to the exclusion of mere farce or love plots), which might be made to have the happiest influence on the moral and domestic virtues, if the countenance of the higher classes were previously to elevate the profession of an itinerant actor into one of greater respectability and estimation than at present. All this will seem very frivolous to many of your readers, but not, I am persuaded, to such as, having travelled on the Continent, have seized every opportunity of observing the amusements of the poor, and have been convinced, by reflecting on what they have witnessed, that "These little things are great to little men." Next to the existing school societies, there is nothing I am more anxious to see, or would more gladly contribute to, than a *Society for promoting the Rational Amusements of the Lower Classes*, the first aim of which should be to instruct itinerant teachers of music, singing, and dancing, in improved modes of imparting their arts, and thus fairly set the plan a going, when it would soon work its own way, and might then be extended to higher objects. The taste for flowers among the Paisley weavers, for gooseberry-growing at Manchester, and for music

among the west of Yorkshire clothiers, originally sprang up from imitation of one or two amateurs of each pursuit; and there only needs a similar *first impulse*, which a society with a few thousands a year might give, to spread a general taste for music, singing, and dancing, and ultimately for other branches of the fine arts, as drawing and painting, as well as for natural history and the cultivation of flowers and fruits, &c.

The lower classes in England, thus improved in morals and manners by a better education and more humanising amusements, might be safely left to choose their time of contracting marriage, and would then no more make beasts of themselves by drinking fermented liquors, than do the lower classes in the city from which I write, where probably more beer (and that by no means weak) is drank than in any town of similar size in England, every street being crowded with *cabarets* (public-houses), and these in the evening almost always filled. But how filled? Not with rioters and noisy drunkards, but with parties at separate tables, often consisting of a man, his wife and children, all sipping their pot of beer poured into very small glasses to prolong the pleasure, and the gratification of drinking seeming less than that of the cheerful chit-chat, which is the main object of the whole assemblage. Deep-rooted national bad habits can be eradicated only by the spread of knowledge, which will ultimately teach our lower classes, as it has already done the bulk of the higher, that *moderation* is the condition of real enjoyments, and must be the motto even of the sensualist who aims at long-continued indulgence. I am Sir, yours, &c.

*Brussels, Feb. 26. 1829.*

WILLIAM SPENCE.

---

ART. III. *Outlines of Horticultural Chemistry.* By G. W. JOHNSON, Esq., Great Totham, Essex.

(Continued from p. 323.)

IF kept perfectly dry, seeds will never vegetate. They require, therefore, some kind of moisture, and that moisture must be supplied by *water*. I have kept beans and peas moistened by olive oil and alcohol only, but otherwise under circumstances favourable to vegetation, without their showing the least symptom of germinating. Water, then, is an essential; the most appropriate quantity varies with the species of plant. If in excess it is more prejudicial than a total deficiency, since in the first case it excites decay, in the latter event the seed

remains unaltered. That the first ever occurs in practice, arises from the faulty cultivation of the soil; for, if properly drained, however retentive it may be, no natural deposition of moisture is ever too abundant or continuous. Some seeds, as those of aquatics, succeed only when completely immersed in water; others, as those of the lemon, will often germinate with the unassisted moisture of their own pericarp.

All seeds require a certain degree of *heat*; none will germinate at a temperature so low as that of freezing water, yet the greatest degree of cold is not injurious to them, if germination has not commenced. Every seed appears to vary in the degree of heat which it requires before vegetation commences, though an increase above such temperature, if not excessive, always accelerates the progress. Adanson found that seeds which naturally do not germinate in a less space of time than twelve hours, may, by an increase of heat, be made to do so in three hours. Seeds ripened in high latitudes, or at great heights, and consequently in a climate whose average temperature is much lower than that of countries nearer the equator or of less elevation above the sea, germinate much more quickly when sown in these latter climates, than if re-sown where they were produced; a fact which defies explanation, if plants are devoid of sensation.

The experiments of Ingenhouse and Sennebier evince that *light* retards germination; and some which were tried under my own inspection afforded confirmatory results. This fact has long been practically acknowledged, by the cultivators of the soil burying their seed beneath its surface.

These facts hold out some beacons worthy of being attended to, as guides for the operation of sowing. They point out that every kind of seed has a particular depth below the surface, at which it germinates most vigorously, as securing to it the most appropriate degree of moisture, of oxygen gas, and of warmth. From a quarter of an inch to two inches beneath the surface, appears to be the limits for the seeds of plants usually the objects of cultivation; these, however, must vary for the same seeds in different grounds and countries. It must be the least in aluminous soils, and dry climates. Sowing should in general be performed in dry weather, especially on heavy soils, not only because of the greater saving of labour, but because it prevents the seed being enveloped with a coat of earth impermeable by the air, "which," says Sir H. Davy, "is one cause of the unproductiveness of cold, clayey soils." Perhaps the time at which any ground may be *raked* with the greatest facility, is as good a practical criterion as any, to judge when it is most fit for sowing. In general, if clay does not

predominate in its constitution, a soil rakes best just after it has been turned up with the spade. If clay does predominate, it usually rakes with most facility after it has been dug two or three days, and then immediately after a gentle rain. But it is certain that the sooner seed is sown after the soil is dug for its reception, the earlier it germinates. In the droughts of summer, water is often required to newly sown beds. Such application must not be very limited or transitory; for, if the soil is only moistened at the immediate time of sowing, it induces the projection of the radicle, which, in very parching weather, and in clayey caking soil, I have known wither away, and the crop be consequently lost from the want of a continued supply of moisture.

From the slight sketch contained in the foregoing papers, it will have been seen that plants derive their whole nourishment from the air and soil. It is of importance to know how the constituents of these may be ascertained, so as to enable us to judge beforehand whether they hold out a prospect of affording a plentiful increase to the cultivator.

Experiments on the constituents of atmospheric air, are never required by the tiller of the ground; for it has been demonstrated by the best chemists that its composition is invariably the same in all parts of the globe, and whether obtained from a level with the sea, or from the greatest height to which man has found means to ascend. Their researches afford one general result, which is, that the atmosphere is composed of 21 parts oxygen, and 79 parts nitrogen, with the admixture of about 1 part of carbonic acid gas in every 1000 of its parts.

This simplicity of composition is very far from existing in soils; of them, perhaps, no two specimens in the world are precisely alike.

Before I proceed to detail the mode of analysing a soil which I employ, and for which mode I was originally indebted to the *Elements of Experimental Chemistry* by Dr. Henry, I must pause to animadvert upon two common prejudices, each of them the offspring of ignorance.

The first prejudice is that which argues that chemistry is of no use to the cultivator of the soil. I slightly touched upon this in my opening paper, and the effect of Lavoisier's practice, directed as it was by science, is an incontrovertible argument against this prejudice, for facts are not to be overturned by obstinacy; but I am induced to argue the point more in detail, by having heard such an objection raised by a person whom I have been accustomed to consider possessed of a liberal mind.

We have seen that every plant has a particular temperature in which it thrives best; a particular modification of food, a particular degree of moisture, a particular intensity of light, and that these particularities vary again at different periods of their growth. It is equally certain that they are subject, like all other matter, to various influences (the application of some substances corrodes them); nor are these uniform. Acids are injurious to some plants, alkalies to others, &c.; the excess of some of their constituents, and the deficiency of others, insure disease to the plants in which such irregularities occur; disease is accompanied by decay, more or less extensive and rapid, and ultimately death ensuing, each plant is reduced into its proximate elements. Now, if it were possible for any science to teach the cultivator of plants, how to provide for them all the favourable contingencies, all the appropriate necessities above alluded to, and to protect them from all those which are noxious to them, the art of cultivation would be far advanced to perfection; yet such a science is chemistry.

I do not mean to advance that chemistry, as at present known, is capable of supplying all the desiderata I have alluded to, but it can many of them. Besides, chemistry has not reached its present state in a day; it has been the work of ages, and is daily improving; neither has it been the creation of one mind, but has been the gradual structure of many intellectual labourers, from the days of the Arab alchemists until now. Let it not then be supposed, that the cultivator of the soil should wait for others to make discoveries, and that he need only take advantage of them. Should the physician be ignorant of pharmacy, and, confining himself merely to detect diseases, leave to the pharmacist to point out appropriate remedies? As absurd would it be to assert that, though chemistry is one of the best aids of horticulture, the gardener should leave its application to others. I shall conclude my observations on this point with two extracts, one from the pen of Dr. Henry, the second from that of Mr. Kirwan. "Any knowledge," says Henry, "that can be acquired respecting soils and manures, without the aid of chemistry, must be vague and indistinct, and can neither enable its possessor to produce an intended effect with certainty, or to communicate it to others in language sufficiently intelligible. Thus we are told by Mr. Arthur Young, that, in some parts of England, any loose clay is called marl; in others marl is called chalk; and in others clay is called loam. From so confused an application of terms, all general benefits of experience in agriculture must be greatly limited. Chemistry may, to agriculturists,

become a universal language, in which the facts that are observed in their art, may be so clothed, as to be intelligible to all ages and nations."

If it were true, which it is not, that the cultivation of the soil has not improved during the last two thousand years, though some have argued for such an untenable opinion, yet, supposing it to be true, such an argument *ex ignorantia* would avail nothing against the possibility of improvement. Does not every cultivator of the soil know that some ground will grow luxuriant crops, such as a second piece of ground, though manured without limit, will never equal? All that he can say is, that "the *ground* does not *like* those crops;" but the chemist can teach what constituents are deficient, what noxious ones are present, which, in less incorrect language, causes the *crops* not to *like* the soil. I am perfectly willing to grant, and to lament that facts justify the admission, that chemistry has not been brought to the illustration of the agricultural arts so successfully as to many of the arts of manufacture; this is in a chief degree owing to the insensibility of cultivators in general, but not entirely so. It partly arises from the great difficulty and intricacy of vegetable chemistry; "if the exact connection of effects with their causes," says Kirwan, "has not been so fully and extensively traced in this as in other subjects, we must attribute it to the peculiar difficulty of the investigation. In other subjects, exposed to the joint operation of many causes, the effect of each, singly and exclusively taken, may be particularly examined, and the experimenter may work in his laboratory, with the object always in his view; but the secret processes of vegetation take place in the dark, exposed to the various and undeterminable influences of the atmosphere, and require, at least, half a year for their completion." But such difficulties are only so many powerful reasons for increasing the labourers in this field of science; and when these have gone on collecting observations and facts, some master mind will arise, in an age perhaps not very distant, and render the whole more luminous, by arranging them in the magic order of system.

The second prejudice to which I shall advert, is that which considers chemical experiments cannot be tried without expensive apparatus, a prejudice to the full as futile and baseless as the preceding. To demonstrate this, but one fact need be stated. The late Dr. Henry of Manchester, whose experiments were so numerous and so varied, so intricate yet so accurate, "was at no period of his life in possession of a well-furnished laboratory, or of nice and delicate instruments of analysis or research;" but his ingenuity "was especially dis-

played in the neatness and success with which he adapted to the purposes of experiment, the simple implements that chance threw in his way." (*Quarterly Journal of Science, &c.*, vol. viii. p. 17.) If to make experiments in nearly the whole range of chemistry required no paraphernalia of apparatus, much less does it require such for the analysis of soils, to which I shall in this place confine my directions for the attention of the horticulturist; not that such alone is desirable to be pursued by him, but because, in the present state of chemical knowledge among the cultivators of the soil generally, it is absurd to expect that he would pursue some of its most intricate researches. There is no field of science in which lie hid at present more brilliant objects for examination, none that will redound more to the fame of their discoverer, none that will be more generally beneficial to mankind, than that which embraces agricultural and horticultural chemistry. It is yet in its infancy, but the day will come when every cultivator will prepare his soil for each crop, in a more scientific way than at present manifested in one unvarying course of culture. The day will come when manures will be distributed in greater variety and with more discrimination, than stable manure and chalk are at present by the load; and when science confirming him in the judicious application of manures, and the necessity of a clean course of cultivation, will, at the same time, demonstrate that even dung and composts may be selected and compounded with beneficial discrimination; that economy is not misplaced in regulating abundance; and that, though chemistry can never supersede the use of the dunghill, the spade, the plough, and the hoe, yet it can be one of their best guides, can aid them in their objects, can be a pilot even to the best practitioner.

(*To be continued.*)

---

ART. IV. *Vegetable Physiology, with a View to Vegetable Culture.*  
By M. W. HERTZ, of Stuttgart, now in Kew Gardens.

Sir,

VEGETABLE physiology being one of my favourite sciences, I always took a great delight in reading any thing belonging to it; and as the germination of the seed particularly attracted my attention, I was very anxious to make myself in some degree acquainted with the phenomena and changes which take place during that process. I found in the *Horticultural Society's Transactions* (vol. i. p. 217.), a truly philosophical

description of the processes of the infant plant; and in your *Encyclopædia of Gardening*, in Willdenow's *Physiology*, and in Decandolle's and Sprengel's *Principles of Scientific Botany*, this subject is treated of more circumstantially.

However, in all those books I did not find that any particular experiments were made on the mutilation of the germinating plant; but all the authors agree that, if the cotyledons are cut off, the young plant decays and perishes, and that they are to be regarded as the mammæ of the animals.

Fabroni, however, asserts that one and even both cotyledons may be cut off, without materially damaging the growth of the young plant.

One of these so different opinions must necessarily be wrong; and, to ascertain the truth, I made several experiments, which I am going to communicate to you at length, and which, if you think them worthy a place in any one of your excellent Magazines, are very much at your service.

I think it not necessary to make an ample explanation of the construction of the seed, as every body may find it described in any of the books above alluded to, and in the *Encyclopædia Britannica*; but I will only confine myself to the account of my experiments, which will call forth, perhaps, a more physiological pen than mine.

I chose the common kidneybean (*Phaseolus vulgaris*) for the subject of my mutilations, because I considered it the best adapted for any purpose of that kind, and I sowed some of them in small pots.

As soon as the cotyledons made their appearance above ground, I cut off one of them, and found that the young plant continued to grow, though it evidently weakened it very much, and its growth was but slow, in comparison with another bean whose cotyledons I left untouched, and it wanted some time to recover itself from the sustained loss.

Another plant I deprived of both cotyledons, at the same time and under the same circumstances; and the plant ceased to grow, though it continued to be alive for nearly a week afterwards. I examined the plant, and found almost the whole radicle in a dry state, and the death of the individual was therefore unavoidable.

Similar experiments were made with the garden bean (*Vicia Faba*), and the same result followed.

I was now perfectly satisfied that the young plant cannot grow without the presence of one or both cotyledons, and that they prepare the first nourishment for the germinating seed.

My next experiment was to try if a young plant, when deprived of its roots, can continue to live. For that purpose, I



separated the radiculum of a *Vicia Faba* carefully from the cotyledons, and found, to my great surprise, that the young plant continued to grow, although it suffered apparently a great check, and a new set of roots began to make their appearance.

This experiment sufficiently showed me that the young plants have the power of renovating their roots, as long as the cotyledons are left untouched.

I was now desirous to know what effect it would have on the life of the individual, if the caudex ascendens were cut off. To gratify my desire, I deprived a *Vicia Faba* of its caudex, which was about 2 in. high, and two little caudices shot forth, out of the corners of the cotyledons, one of which took the lead, and grew fast, but rather weakly; and, on nearer examination of a bean, I perceived two buds, one in each corner of the cotyledons, which our wise Creator did certainly make for no other purpose but that, if the first grown caudex happen to be destroyed by birds or other animals, another should rise in its place, and supply the loss of the first. But, in the last case, the roots grew to an uncommon size, and filled the whole pot. After all this, I turned the cotyledons of a germinated kidney-bean downwards, and the roots upwards, and, in a short time, the roots inclined towards the soil, and showed an inclination to resume their former position; and I have no doubt, that if I had continued my observations on it, I should have found the roots to take hold of the ground again, and turn the cotyledons upwards: but my experiment was limited to the question whether the plant can continue to be alive when in this position, and I found the bean, after a lapse of a week, in the same state of health as when I first planted it; which shows clearly that the cotyledons are able to absorb moisture through their veins, for the nourishment of the plant, also when its growth is already advanced.

The determination whether this last phenomenon of the root's inclination towards the soil can be called instinct, or whether it is a mere process of gravitation, I must leave to you and to your readers, who are abler physiologists than myself.

Should these experiments be thought deserving a place in one of your publications, I shall be highly gratified.

I remain, Sir, &c.

*Kent, Sept. 30. 1828.*

W. HERTZ.

ART. V. *On the judicious Division and Employment of Time, especially addressed to Young Gardeners.* By JUVENIS OLITOR.

Sir,

AFTER glancing over the several propositions which, in the Gardener's Magazine, are suggested for the improvement of young gardeners (many of which merit considerable attention, and, no doubt, among the more spirited class, will not only draw forth a feeling of gratitude, but, it is trusted, will excite them to a diligence and assiduity equally praiseworthy on their part), I find extant in the desiderata one which may be considered of too great import not to be included in the list of those already brought under notice.

I mean the judicious formation of a chronometer, which is the only preventative I know for that fatal intruder, procrastination, which, in so many instances, is allowed a place in the society of the class above mentioned. I know nothing so well calculated to accelerate the studies of the young gardener, as a proper disposal of his leisure hours in something like a systematic way. It is in consequence of such an oversight that so many grovel in a degree of mediocrity, notwithstanding their several exertions. I do not mean to charge them with a total neglect of application (from such individuals I would preclude the name of gardener); but I am aware of a prevailing error, which ought to be extirpated with all possible speed. I trust a hint or two is all that is necessary to obviate the procedure I intend pointing out.

It cannot be denied that many young gardeners ardently pursue the various literary topics necessary for a competent knowledge of their profession, but in such an erratic manner, that their progress is not only retarded, but rendered in a great measure abortive. When any particular department is in pursuit, it is generally without restraint, until some novel attraction fall under their cognizance; when, all of a sudden, their old companion must be retrenched by the new intruder, long ere an adequate acquaintance has been formed. Thus time flies on, until something else presents itself necessary to be laid hold of, and also is grasped with the same unbounded limit; when it is necessary, in a certain degree, to suppress, or totally to lay aside, those formerly followed after. That such a system is practised, if a system it may be termed, many must confess, although none so able to judge of its demerits as those who have practically felt its bad effects. It is almost impossible here to establish a rule by which a reformation as above stated is to be effected: that must be a discretionary point with the young gardener himself, which must

depend upon the circumstances in which he is placed. I shall only aim at a suggestion or two, which may give a general idea.

In the first place, he ought to make an exact calculation of his spare time during a week or day, and then make a prudent choice of the several indispensable branches of learning in which he finds himself deficient, not too many at a time. Let his time be then divided in such proportions as are more advantageous to his success and situation; *ex. gr.* were six to be selected, say Latin, botany, chemistry, mathematics, writing, history or miscellany, then the first two occupy the morning, the two next the evening, the last two next morning, and the first two next evening, &c., allowing a given time for each; and in case any particular occurrence causes irregularity in the observance, the breakfast or dinner hour may stand as a reserve for time lost: but paying the most rigid attention that not any one intrude on the time of another, as it must inevitably confound such a system; but, if strictly attended to, it will not fail to reward such as observe it: in fact, I know not how any thing like a general knowledge can be obtained, unless some such system be adopted. I may further add, as the student finds himself arriving at a considerable proficiency in any topic, he may deduct a portion of the time devoted to it, and whatever is next useful may be substituted; for, as a learned Greek observes, "He who knows useful things, not he who knows many things, is wise." It may here be deemed unnecessary for me to add any further observations on the particular branches to be cultivated, as every ambitious young gardener must have learned, less or more, what is most essential for him, particularly as he can be copiously furnished with the necessary information in a preceding volume of your Magazine.

Consequently, I shall only now briefly advert to one; as considering it indispensable in that stock of knowledge, compatible with the necessary acquirements of every well-informed practitioner, *viz.* vegetable physiology, so far as chemically connected with the analysing of plants and soils; and a knowledge of the organic structure of the former, so far as illustrative of the radical and epidermic functions. The result of such information has not only a tendency to amusement and pleasure, but is highly conducive to that expansion of intellect which can account for many of the various phenomena presented to view, under our every-day practice. It also obviates many of those vague proceedings which afford scope for the censure of the connoisseur; besides exciting confusion, mingled with regret, in such individuals as witness a failure in produc-

tion, aware of the effect, but there must remain, as being unable to investigate the cause. It may be argued that many a good gardener flourishes at the present day, who has not only been successful in his labours, but afforded every satisfaction to his employer, who scarce comprehends the term "vegetable physiology." That such is the fact, cannot be denied; but may it not be asked, whence has this learning sprung? Is it not the result of previous philosophical experiments; a mere accumulation of approved facts, held out to the world by such as made the original investigation? But such a character never can enhance the treasures of science, and never will avail himself of any scientific research.

Perhaps the above observations, by some of your young readers, may be viewed as forming a part of the *præcognia* of the Gardener's Magazine; but, first principles can seldom be too often recurred to, and being conscious that such verities cannot be too forcibly impressed on the minds of such individuals, I submit the same to their perusal.

If you, therefore, deem this attempt worthy of insertion, by giving it a place you will much oblige,

Sir, yours, &c.

September, 1828.

JUVENIS OLITOR.

---

ART. VI. *On forming Artificial Seas in Ornamental Landscape, and on a New Sluice for regulating the Rise and Fall of the Tide in such Seas.* By Mr. W. AITKEN, Nurseryman, Castle Douglas, Author of *Navarino*, a Poem.

Sir,

A DESIRE to imitate nature, and to blend her magnificent yet simple grandeur with the works of art, has now, to a certain degree, found a share either in the imagination or operations of every artist in gardening or rural ornament.

I have often looked at the motion of the tide, and considered it the most grand and beautiful of nature's works, together with its sublime accompaniments, painted by her ever fertile hand, of varied shores, rocky steeps, shattered bays, and level sands, ornamented by her pencil with plants suited to their respective situations.

Artificial water-ponds and rivers have long ago been introduced into gardens and lands, and when judiciously led down are very ornamental: but I have gone one step further, I have introduced, or, I should rather say, wish to introduce, artificial seas. These can only be fresh-water ponds, but so constructed with capes, bays, islands, rocks, sands, &c.,

as to imitate a sea; with the waters of said pond rising or falling a certain perpendicular height every six, twelve, or more, hours; at one time filling the bays, surrounding the islands, covering the rocks and sands, and at another time ebbing from them, and so imitating the tide by an alternate flux and reflux, which can be effectually obtained by means of my newly invented self-acting sluice, provided the pond is constantly supplied with a regular run of water, corresponding to the dimensions of said pond.

The sluice is so constructed that it remains shut until the pond is full, or at high-water mark, when it opens of itself and allows the water to decrease, or ebb, to a given depth or level; at this point the sluice again shuts itself, and causes the water to increase or flow as before, when it again opens itself; and in this manner it continues to act alternately and regularly.

It would render the above ponds more ornamental and more curious, if, on the stream that feeds them, a reservoir-pond were constructed. This should be of equal dimensions with the under-pond, and at least on a higher level by 2 or 3 ft. It may be at any distance from the other, or at any height of level; a mile distant or 100 ft. of elevation are equally the same, and would give fine scope for cascades.

By means of a curious, but very simple, part of my invention, the sluice of the reservoir-pond would have a secret under-ground connection with the other sluice, which would cause them to work in concert. When the sluice of the ornamental pond opened to discharge, or ebb, the sluice of the reservoir-pond would shut; this would cause a quicker ebb, and also save water for a quicker flow: when the under sluice shut itself, then the sluice of the reservoir would open and pour its water over a fine cascade into the under-pond, if the situation in point of elevation admitted of such. The whole apparatus is uncommonly simple, and might be easily invented by any ordinary artist; but, as far as I understand, it has never before been suggested, although much has been done and written on the subject of ornamenting gardens, pleasure-grounds, and lawns, by water, therefore I am entitled to the merit of originality in so far as a tide-like motion is obtained.

Water-ponds so constructed, instead of being only stagnant pools, as at present, might be made to exhibit every species of pleasing variety, according to the nature of the situation and taste of the proprietor. Ponds of this description would be most excellent accompaniments to artificial rockwork; it would be on the banks of such, that the effects of rockworks would be more naturally grand, having their

bases washed with the flow tide; here would the rock and marine plants of various kinds appear as in their natural situations. On the peninsulas, islands, and along the banks of such ponds, might be laid down variously formed flower-plots; there, also, might be constructed bowers, rustic seats, and many other rural ornaments.

These sluices are very simple and easy of construction: for a small pond the cost will not be more than from three to four pounds sterling; but the expense will vary according to the dimensions, or nature of the materials. Whether of wood or iron, they are sure to act; and power can be communicated to lift a sluice of any dimensions, so that ponds on an extensive scale may have their water raised or lowered by these sluices. Should the supply of water run short, from a summer's drought or other cause, the pond may, during such deficiency, be kept at high-water mark by turning the key of a common brass cock, on which its action depends, or it may also be kept at low water by an equally simple operation. For the sake of durability the whole apparatus may be constructed of iron, and all concealed under ground if required.

Should any of the numerous readers of your Magazine wish for a plan of the sluice, or should they wish to construct one on the above-described principle, I shall be very happy to hear from them, and I trust they will find my terms moderate.

*Castle Douglas, Jan. 30. 1829.*

W. AITKEN.

---

ART. VII. *On the Scotch Pine.* By AGRONOME.

Sir,

By the time you see this, you will be returned, as I hope, safe and sound, from your Continental tour; and, no doubt, you have brought a rare budget of good things for your friends, "a feast of fat things full of marrow; of wines on the lees well refined." For my own part, I have had but little time for either treating or being treated lately in the way of writing or reading, having also made a tour through the north of England and south of Scotland. My route was through Staffordshire, Cheshire, Lancashire, &c., as far as Glasgow and Edinburgh; thence down the Gala water to Abbotsford, to Melross, Jedburgh, and over Chevy Chase to Otterburn, Elsdon, &c., to Newcastle upon Tyne; thence through the county of Durham, by Sunderland, Halifax, Leeds, Harrow-

gate, &c., to Manchester; whence I returned back to my own sweet, sweet home in the centre of England; "for there's no place like home! there's no place like home!" The object of my mission was to see the state of improvement in agriculture and horticulture, and particularly the management of young plantations, as theoretically described by Sir Henry Steuart, Mr. R. Montearth, and Sir Walter Scott, whose works I had just been reading.

I had not seen any of the country comprised in my tour for above nine years, much of it I had not seen for twenty or thirty years, and some parts I had never seen. I have collected materials sufficient for a great number of Magazines, but am such a poor hand at arranging or writing systematically, that, with want of time also, my letters, I fear, will hardly be worth reading. I shall, however, give you an account of some of the things which I have seen, or rather of what I have not seen, for I have seen but few things which really pleased me. I saw no such thing as two distinct species or varieties of the Scotch pine (*Pinus sylvestris*), either in Scotland or England. The rough-barked and smooth-barked are only occasioned by soil, situation, or age; the broad top is the effect of old age, premature old age, or disease. Every Scotch pine will have a rough bark, if it has been pruned and thinned out properly in its youth. I saw many ill effects of not early pruning the Scotch pine; as also many ill effects from pruning after the tree was nearly at its growth. I examined many boards sawn from such trees; they were full of knots, 2 or 3 in. in diameter. Such knots were the only good wood in them; indeed, they had every appearance of the best pitch pine of Russia; while the boards themselves were quite white and frothy. Sir Walter Scott was very wrong in saying that the common Scotch pine was only introduced from America about half a century ago, and much inferior to the Highland pine. There are, within a few miles of Abbotsford, large woods of Scotch pine, which have been the rendezvous of an immense heronry and rookery since long before he was born, namely, Torwood Lee and Bowland, Bowhill, &c. Secondly, I saw few or no pines on the lands where I wished to see them, viz. on the tops of the hills. The woods in Scotland are chiefly on the sides of the hills, or even on some of their best lying lands; while the bleak bare hills behind them give the whole country a barren and beggarly appearance. I am not so fond of hedge-row timber as some are, for I never saw a tree in a hedge fit to be seen, if the hedge were fit to be seen under it; but I should like to clothe every horizon with a belt, however narrow, of Scotch pine and larch fir. Such

belt should not be straight, but undulating and festooned, according to the form of the hills, and feathering down into the glens.

I do not approve of planting *merely* the tops of hills any more than Sir Walter, who, in his fine picturesque language, calls it a lady's cap stuck on the crown of her head, leaving all below naked; but Sir Walter has erred on the opposite extreme, in dressing the lady's bosom, certainly very tastefully, while her head appears above, as bald as "the Marquis of Granby's on a signpost!" But this is not what I wished to talk about. What I wished to say was in vindication of Sir Walter Scott's rather paradoxical observation respecting the pine, where he says, "it will grow as well on bad or uncultivated land as on good or well cultivated, after the first few years." Now this, though strange, is not only true, but the fact is, that it grows *the best timber* on the very worst land! The reason why the Scotch pine is useless in England is because the soil and climate are *too good* for it! I saw beautiful thriving plantations in Ayrshire and Lanarkshire, planted in what are called lazy beds; not that the soil was too wet, but because there was not soil sufficient to plant any thing in, without collecting it into heaps or ridges from among the rocks of which the hilly surface was composed. These trees reminded me of Sir Walter's beautiful song in the *Lady of the Lake*: —

" Ours is no sapling, chance sown by the fountain,  
 Blooming at Beltane, in winter to fade;  
 When the whirlwind has stripp'd every leaf on the mountain,  
 The more shall Clan Alpine rejoice in her shade,  
 Moor'd in the rifted rock,  
 Proof 'gainst the tempest's shock,  
 Firmer he roots him the fiercer it blows."

What encouragement is here for gentlemen to plant their wastes and barren hills in England! and what a pity it is to plant good pastures or tillage land with the "villanous Scotch pines." Howbeit, I know of no tree so useful for shelter and shade, either for fields or as a nurse for other or better trees. It is also very ornamental on mountain sides or tops of hills, feathering down among deciduous trees in exposed situations. The beauty of the pine is, that it will grow in almost any soil, or almost no soil. Its roots run on the surface almost like a peach tree against a wall, and are nourished by the shelter and shade of its own foliage; which dropping annually soon forms a strata of earth sufficient to cover its largest roots, and even to produce good pasturage for cattle. A double row of Scotch pines, planted in triangles, will become a formidable



fence against cattle, far sooner than thorn, quick, or any tree that I know of, planted 2 ft. apart, and not pruned till the lower branches die. Such fence is surely more ornamental than thorns in the winter, and a better shelter and shade all the year round.

Yours, &c.

AGRONOME.

ART. VIII. *On the Culture of the Double Yellow Rose.* By Mr. JOHN FRASER, Gardener to the Honourable William Fraser.

Sir,

As I have seen several methods of cultivating the Double Yellow Rose mentioned in your valuable Magazine, I am induced to send you an account of the manner in which I treated it in the north, in N. latitude  $57^{\circ} 37'$ , and W. long.  $3^{\circ} 7'$ .

It was planted about a foot from a south-east wall, and not trained to it, as is commonly done; the soil is a strong clayey loam. As the plant grew vigorously, I generally cut the shoots in to 8 or 12 in., and gave the roots a good dressing of leaf mould; and it never failed to produce a numerous show of perfectly blown roses, of a most splendid appearance, and uninjured by any insects.

I am, Sir, &c.

JOHN FRASER.

*The Cottage, Battersea, Feb. 12. 1828.*

ART. IX. *On the Cultivation of Dahlias (now Georginas).*  
By a FLORIST.

Sir,

A GOOD criterion for planting this root is about the time of planting early potatoes for a first crop, but no sooner. They grow well in a rich light soil of almost any kind. In dividing the root, it is advisable to leave, at least, two eyes to each plant, cutting through the neck or crown; the spring is the most preferable time for dividing them, although some do it on taking them up in the autumn. Those who possess a hot-house should put each part into a pot of 6 or 8 in. in diameter, with some good rich mould, so as the crown may just appear at the top of the pot; then place them in the green-house, where they will soon make good plants; and, when all danger from frost is over, they may be turned out into holes prepared for them.

In this manner, after being so long confined, they will grow most luxuriantly. A common cucumber frame may be successfully used in this way.

February 8. 1829.

I am, Sir, &c.

A FLORIST.

---

ART. X. *An effectual Mode of destroying Slugs among Cauliflowers and Cabbages.* By Mr. HENRY PIKE, Gardener at Winkfield Park, Berkshire.

Sir,

HAVING had all the young cauliflowers and cabbages in my garden devoured by the slugs, after I had repeatedly planted them, and having tried every expedient recommended in your valuable Magazine, such as salt, lime, and dibbling holes round the borders, and all having failed, I at last spread some well-cut chaff round the young plants under hand-glasses, and some round the outside of the glasses. The success has been complete. The slugs in their attempt to reach the plant, find themselves immediately enveloped in the chaff, which prevents their moving, so that when I go in the morning to elevate the glasses to give the plants air, I find hundreds of disabled slugs round the outside of the glasses, which I take away, and destroy. This mode of proceeding being so simple and so effectual; I have thought it would be doing a public service to let it be known through the channel of your Magazine, particularly as (from the mildness of the winter) the damage done by the slugs has been so universal.

I am Sir, &c.

Winkfield Park, Berks, Feb. 9.

HENRY PIKE.

---

ART. XI. *Abridged Communications.*

*TREATMENT of American Shrubs in the Goldworth Nursery, by Mr. Donald, F.H.S.* — For some years past, I have endeavoured to inure American shrubs to the common garden soil, by transplanting them once a year; and, every time, putting a less quantity of peat earth around their roots. The result is, that I have all the commoner sorts thriving in sandy loam. Of those kinds that flower on the crowns or points of the shoots, such as *Rhododendron*, *Azalea*, *Ledum*, &c., I cut down

half the shoots to two or three buds, in order to produce young wood and flower-buds for next year; and those which produce their flowers from the sides of their shoots, such as *Andróméda*, *Kálmia*, *I'tea*, *Clèthra*, &c., I deprive of all irregular shoots, and some shoots I cut down to a few eyes, in order to furnish the plants with young wood for the following year. About six or seven years ago, my plants of *Rhododéndron pónticum* made shoots from 3 ft. to 5 ft. high, when the idea occurred to me of making standards of them, which I have succeeded in doing, to the great ornament of some gardens in which they have been planted. Standard rose trees are ornamental in summer, but standard rhododendrons being evergreen, they are ornamental all the year.

*Improvement of a Fruit-border, &c.* — In August, 1824, a very fine south wall at this place had only a few blighted peach and nectarine trees upon it. I suspected the border was unsuitable, and soon found this to be the case. It was too wet. I therefore had it all dug out to the depth of nearly 6 ft., covered the bottom with middle-sized rubble-stones, 6 in. thick; and this, intended as a drain, I covered with stone plank (paving-slabs?) laid closely together, to prevent the roots from descending into the rubble. This bottom of stone I covered with reversed loamy sods of considerable thickness, and on these placed the roots of the young trees, filling up the border with fresh loam and sandy bog earth, well mixed together. The trees were duly watered, and, from time to time, watered and washed with soap-suds from the laundry; which I continue to do, as it frees the trees from insects, and greatly encourages their growth. They have already extended from 3 ft., when planted, to 14 ft. in extent; and are fruitful for their size. I cover with netting in the spring; train in the fan manner; and, in short, nothing can exceed the healthy beauty of the trees, and the great success of the improvement. — *W. B. Rose, Gardener to Francis Canning, Esq., Foxcoate. April 11. 1828.*

## PART II.

## REVIEWS.

ART. I. *Transactions of the Horticultural Society of London*  
Vol. VII. Part II.

(Continued from Vol. IV. p. 569.)

34. *A simplified Method of marking Numbers on Tallies.* By Sir George Steuart Mackenzie, Bart. F.H.S.

THIS is an extended modification of Mr. Seton's scheme (*Encyc. of Gard.*, § 1378.) of great simplicity and ingenuity. Sir George thinks it "more easily retained in the memory," and we have no doubt, that a person constantly occupied with marks of this sort would retain them and their significations with the greatest ease. But when the number of plants is considered that a gardener must retain the names of in his memory, we confess we would rather that numbers were always written or printed; and, for the benefit of every body, that, in as many cases as possible, the name itself was placed at the plant or other article. For instantaneous marking with a knife in the field or garden, the notching method, however, will always be valuable, and as far as 1000 we would recommend every gardener to make himself master of Sir George S. Mackenzie's method, which he may do in a few minutes, and which is as follows:

"Only four signs are used in combination, to denote numbers up to 1000, when one more sign carries us on to 1,000,000; beyond which, I scarcely suppose it will ever be necessary to number.

"On reference to the annexed sketch (*fig. 24.*), you will observe that, the first three signs, and that for 10, are all that I require. The number 4 is denoted by joining 3 and 1; 5, by joining 2 and 3; 6, by joining 5 and 1. To denote 7, instead of contriving an arbitrary figure, I use the sign of 3, *prefixed* to that of 10, to denote that 3 is *subtracted* from 10, and 7 remains. In like manner, 2 is subtracted from 10, for 8; and 1 is subtracted for 9.

"I now take the notch standing for 10; and, by placing the signs already made *after* it, it is denoted that they are to be *added* to 10. Then we have two notches for 20.

24

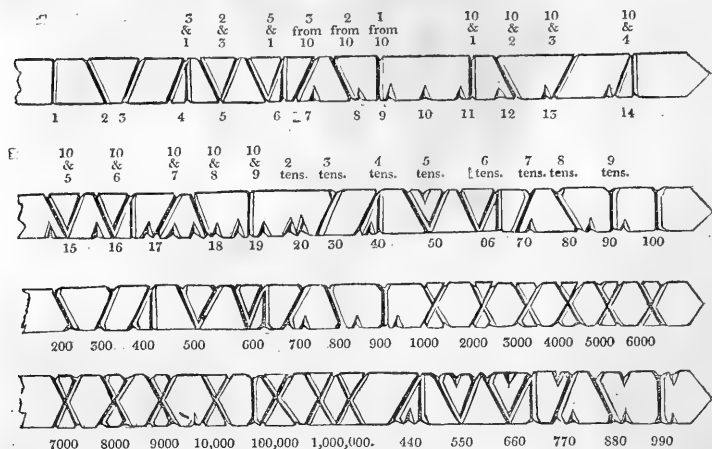

“To denote 30, I use the sign 3, with the 10 on the top, denoting 3 tens. For 40, 50, 60, 70, 80, and 90, I use the same method, but placing the 10 in the openings of the three first. 100 I denote by the sign of 1, having a notch on both ends; and, on the same principle, I proceed with hundreds, till I come to 1000, which requires a new sign, which, however, is formed of two already in use. For 2000, I make a notch at the bottom of the sign used for 2; and for 3000, at the bottom of 3. We now proceed arbitrarily, and a notch on both legs denotes 4000; on the left arm, 5000; on the right arm, 6000; on both arms, 7000; on both arms and one leg, 8000; on both arms and both legs, 9000. 10,000 is marked by the notch prefixed [in the figure]; 100,000, by the 100 mark prefixed; 200,000, by the 200 mark, and so on. To give a few examples of numbers, 440 is denoted by the sign 400, and a notch in the opening; also 550, 660, and 770, 880, and 990, by detached notches at the top. Thus, it appears, the system of knife-marks on wood is carried as far as it seems likely to be necessary, by means of the simple combinations of a very small number of signs, maintaining nearly throughout, a fixed relation to each other; and, probably, it will not be very easy to reduce it to greater simplicity.”

35. *Upon pruning and managing Dwarf Standard Apple and Pear Trees in a Garden.* By Mr. William Greenshields, F.H.S.

The object of Mr. Greenshields is to “make every branch, as it were, a long spur, with bearing buds from the base to

the extremity." To attain this object, he lets the trees take their natural form, whatever that may be, and only thins out and shortens the shoots. "Young trees are to be treated in the following manner:— If there are more than three shoots on the plant, reduce them to that number, and shorten each to three, four, or six eyes, according to their strength. The following season, reduce the number of leading shoots to six, and shorten them to three fourths of their length, and spur in the remaining shoots. The tree should be managed in every respect in this manner, until it has attained the required size, which, of course, depends on the convenience or fancy of the owner or conductor of the garden."

Old trees to be treated in this manner, must be "cut down short," and allowed to make new heads. The first trial of this plan was made on trees which had been planted for six or seven years. "In consequence, they required to be very much thinned out, so as to get the branches clear of each other. In thinning, I always bore in mind to cut the old wood off close to the stem or branch it was attached to; this prevented young wood springing afterwards. When the trees were thinned of the old shoots, as above stated, the young side shoots were what is generally termed spurred in; that is, they were so shortened, that only two or three buds were left on them, and the leading top-shoots were shortened to half their length. The following and every succeeding year, the trees were treated in the same manner as respects the young wood, till they had acquired the desired height, when the leading shoots were shortened, as the side shoots or spurs had been previously."

36. *A Plan for transplanting large Forest Trees in Parks.* By Sir Charles Miles Lambert Monck, Bart. F.H.S.

Tired and disappointed by the frequent failure of single trees which had been carefully transplanted, and secured by stakes and bandages, and having a quantity of refuse stone in large lumps, the writer used these stones as a mulching for trees about 8 ft. high. Each tree had two two-horse cart-loads, not "built up high, but packed close by each other, and set on edge, so as to make a tabular but very rugged surface around the foot of the tree, and extended to the distance of 4 ft.

"These trees succeeded well, and far beyond my expectation. On considering the cause of their success, it appeared to me that the stones served the three purposes of fencing, staking, and mulching; the first of which is always necessary, to defend them from the assaults of cattle; the second is

equally so, if the plants are tall, to save them from being displaced by winds after they shall have taken fresh root; and the third also is necessary, in case of a dry summer, the first after the transplantation of the trees, to protect the soil from over-drought whilst they are striking fresh root into it. The stones, placed as I have described, are a sufficient fence against horned cattle, which, having feet made for going upon soft ground, will not mount the rugged surface of the stones. Sheep and deer will scarcely annoy trees whose bark has acquired roughness; but they may be easily repelled by a few thorns bound round the lower part of the stems. Nor will common horses go upon the stones, or endeavour to touch the trees, and tear off the bark; but against high-bred horses, which are disposed to attack every thing of wood, the stones are not a sufficient fence, unless they are packed with a surface very rugged, and extended 6 ft. round the tree. Against displacement by winds, the stones are a better security than can be provided by any manner of staking or binding; for they are a power always in action by their weight, and the surface of the soil is shaded by them from the too great power of the sun, whilst the rains sink through and encourage the roots to sprout afresh, and extend themselves through the soil: thus they serve the purpose of mulching.

“The best trees to plant out are certainly those whose roots and heads have been properly thinned by pruning and cultivation in a nursery. Such may be planted out at greater ages and sizes than trees taken from plantations of a few years’ growth, and will both strike fresh roots more certainly and grow faster; but these last may be taken up when from 10 to 20 or 25 ft. high, and planted out with full success, provided the two following particulars are observed: first, to get up as much root as possible; next, to reduce the branches down to due proportion with the root which has been got up. A great part of the root is unavoidably lost in the taking up of the tree, and it is the most efficient part, being the extreme fibres. The root has thus lost its natural proportion to the head, and is now insufficient to supply it with moisture. Trees planted out in this state often, after having put forth their leaves, die suddenly; and others, which continue to live, will fall into a languid state, and die off gradually, or recover their vigour very slowly.”

*(End of Vol. VII. Part II., being all that is published.)*

ART. II. *Catalogue of Works on Gardening, Agriculture, Botany, Rural Architecture, &c., published since September last, with some Account of those considered the most interesting.*

BRITAIN.

*Curtis's Botanical Magazine, or Flower-Garden displayed; New Series.*  
 Edited by Dr. Hooker. In 8vo Numbers, monthly. 3s. 6d. col.; 3s. plain.

No. XXI. for September, contains

2848 to 2854. — *Alstrœmeria ovata*, *Ovate-leaved downy Alstrœmeria*; *Amaryllidææ*. This very interesting species allied to, but still abundantly distinct from, the *A. Salsilla*, is a herbaceous, simple, terete, twining, glabrous, and purplish-stemmed plant, from 7 to 8 ft. high, with pendent flowers, and alternate oblong leaves, so twisted that the under becomes the upper side of the leaf. Raised from seeds sent from Chile by Mr. Cruikshanks. It is also said to be a native of Peru. — *Begonia dipétala*; *Begoniæææ*. This is a large, handsome, dipetalous, pink-flowered plant, with an erect, tapering, greyish brown stem, and half heart-shaped acute leaves, green above spotted with white, and blood-coloured below. It flowered at the Edinburgh Royal Botanic Garden, in April 1828, and was raised two years ago from seed from Bombay by Dr. Johnstone. Stove. — *Conospermum ericifolium*; *Proteæææ*. A shrubby erect plant; with a rounded brown stem, subulato-filiform slightly twisted leaves, and flowers slightly tinged with pink when in the bud, but afterwards white and spreading. Distinguished by the shape of its foliage from other species. Flowered in 1827 and 1828 from seeds received from Mr. Fraser, of N. Holland. — *Cattleya intermèdia*; *Orchidææ*. (*fig. 25.*) A handsome, lilac-coloured, epiphytcal plant, with numerous jointed stems from 3 in. to 9 in. high, enlarging upwards. Received from Mr. Harris, of Rio Janeiro, in 1824, and flowered, for the first time, in spring, 1826. — *Polýgala paucifolia*; *Polygaleææ*. This is a beautiful little purplish-flowered plant, with slender, perennial, creeping roots, and green petioled, ovate, shining leaves. It was introduced from Canada by Mr. Blair, and blossomed abundantly in May, 1828. — *Búddlea connata*; *Vitices*. A handsome, green-house, dark orange-colour flowered shrub, suffrutescens, erect, branched, and about 4 or 5 ft. high. Seeds from Valparaiso, by A. Cruikshanks, Esq. Flowers about the beginning of May. — *Eriostèmon salicifolium*; *Rutæææ*. An erect, pale, lilac-coloured shrub, with a stem either more or less rounded, and scattered, roughish, linear-oblong leaves. Introduced to this country by Mr. Fraser. It flowers in April; but, though treated like the generality of N. Holland plants, it does not grow freely.

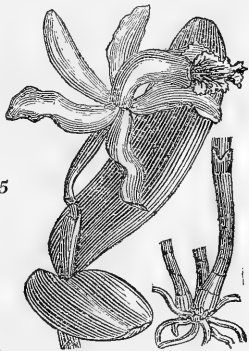

No. XXII. for October, contains

2855 to 2861. — *Saponaria glutinosa*; *Caryophýllææ*. "A very desirable annual plant for the garden," with small flowers of a vivid red colour; "and the purple calyces, and stems, and nerves to the leaves have a rich effect. . . . Apparently a biennial," and, when cultivated, is from 1 to 2 ft. in height, with a round erect stem. Discovered by Bieberstein on the Taurian mountains; flowers in June. — *Imatophýllum Aitoni*; *Amaryllidææ*. A perennial-rooted strap-shaped green-leaved plant, with a number of hand-



some drooping flowers, from S. Africa, by Mr. Bowie; the fruit is a large red three-celled berry. — *Sida sessiliflora*; *Malvaceæ*. This plant is more herbaceous than woody, from 2 to 3 ft. high, with a round branched stem soft with numerous short hairs, and cup-shaped yellow flowers. The seeds were sent by Dr. Gillies, from Mendoza, in South America, and the plants flowered in the stove in November, 1827. — *Sievèrsia triflora*; *Rosaceæ*. A perfectly hardy, perennial-rooted, graceful plant, with the same "subdued, but agreeable colour, as our *Gèum rivale*." From Upper Louisiana by Mr. Bradbury. — *Pultenæa pedunculata*; *Leguminosæ*. "A low-growing shrub, with slender flexuose branches, which are deflexed, especially the lower ones, pubescent; branchlets numerous," with small yellow flowers, in pairs, from the extremity of the young branches. The seeds were sent by Mr. Fraser, from New Holland. Flowers in the green-house in May. — *Dodonæa attenuata*; *Sapindaceæ*. A shrubby, erect, round-stemmed plant, with cracked brown-coloured bark, nodding yellow flowers, and spreading sessile leaves. The seeds were received from Mr. Fraser, of New South Wales, in 1824. Flowered in the green-house in February and March. — *Tris lutescens*; *Irîdeæ*. A pale yellow one-flowered plant, about 7 in. high with scimitar-shaped leaves. A native of hilly stony places in France and Germany.

No. XXIII. for November, contains

2862 to 2868. — *Cynara Cardunculus*; *Compositæ*. This plant, like the artichoke, has spineless leaves, but possesses the other characters of the cardoon family, "and is one with the beauty of which I was much struck in the garden of the Horticultural Society of Edinburgh, in the autumn of last year, 1827; and, indeed, I can scarcely conceive a more highly ornamental plant for any shrubbery or extensive garden." The stem is from 4 to 5 ft. high, the leaves very long, and the heads of flowers large and numerous, of a blue colour, with the heads of the calyx tipped with red. — *Sievèrsia Péckii*; *Rosaceæ*. "I have native specimens of this rare species of *Sievèrsia* from Dr. Nuttall and Dr. Boott, gathered by those gentlemen in the White Mountains of New Hampshire, and find them exactly to correspond with the subject here figured, and which was brought from the same country, and probably from the same mountains, to Mr. Cunningham near Edinburgh, in whose collection it flowered in June of this year, 1828." The root is perennial and woody, the stem 1 ft. or more high, leaves mostly radical, and the flowers terminal and solitary upon each ramification or peduncle, and yellow. — *Salvia pseudo-rocînea*; *Labiâtæ*. This is a "small, slender, shrubby plant, about 2 ft. high, with upright, hairy, tetragonal branches, and opposite downy leaves, which are petiolate, varying in shape, ovate, or oblong, in our plants more inclining to cordate, deeply varied, the margin crenulated, the apex more or less acute." A very beautiful and desirable stove plant, with richly coloured blossoms continuing long in perfection. It was first described by Jacquin and is a native of South America; Humboldt found it in New Andalusia. — *Blumenbâchia insignis*; *Loûsææ*. This plant "appears to have been introduced to our stoves by John Hunneman, Esq., probably from Germany; the German naturalists having received it both from Monte Video on the eastern, and from Chile on the western, side of South America." The stem is herbaceous, climbing, and much branched, the leaves opposite and remote, and the flowers white. It requires the same treatment as the rest of the *Loûsææ*. — *Oxalis carnosa*; *Oxalîdeæ*. This singular species of wood-sorrel was received from Valparaiso and well deserves cultivation, flowering during a great part of the summer. It succeeds well in a cool green-house. The root is a large subfusiform tuber, the leaflets ternate and obcordate, and the flowers of a pale yellow. It is readily increased by the roots, and will, without doubt, flourish in the warm season, when planted in light earth in a sheltered situ-

ation in the open air. — *Desmodium nutans*; Leguminosæ. "A low slender shrub, much branched, with scattered leaves and purple flowers," from the botanic garden of Calcutta, in 1823, by Dr. Macwhirter. — *Passiflora capsularis*; Passifloræ. A climbing triangular-stemmed plant, with alternate remote leaves divided from below the middle, and greenish flowers. It was received by Dr. Graham from the West Indies.

No. XXIV. for December, contains

2069 to 2075. — *Artocarpus incisa*; Urticæ. "A tree from 30 to 40 ft. high, with a diameter of trunk from 1 ft. to  $1\frac{1}{2}$  ft., bearing a large head of many, spreading, fragile branches, and abounding in every part with a viscid, milky juice." The leaves are from 1 to even 3 ft. in length, and often  $1\frac{1}{2}$  ft. broad. They are alternate, ovate, but cuneate, and entire at the base. It was seen abundantly in the Ladrone Islands by Dampier, who says that the fruit is as big as a penny loaf, when wheat is at 5s. the bushel. It is eaten by the natives of Guam, who gather it when fully grown, and while it is green and hard; they then bake it in an oven, and scrape off the outside black crust, when there remains a tender thin crust; the inside consists entirely of a fine substance, soft, tender, and white, resembling the crumb of a loaf. — *Salvia involucrata*; Labiata. This plant makes a brilliant appearance planted in a border, where it has attained a height of from 12 to 14 ft., and scents something like the common sage. The leaves are quite glabrous, large, and cordate-ovate; the flowers are pinkish, and form a rather handsome thyrus. — *Cenothera viminea*; Onagrariæ. A hardy, annual, erect-stemmed plant, with glaucous entire leaves, from 3 to 4 in. long; the flowers of a lilac colour, and sessile in the axils of the superior leaves. The plants will blossom throughout the summer, if the seeds be sown in the open border in spring. From the interior of Northern California, by Mr. David Douglas. — *Calceolaria arachnoidea*; Scrophularinæ. This plant has been hitherto kept in the green-house; it has a herbaceous, round, much branched stem, with spreading opposite branches, and lingulate opposite leaves, with purple flowers. The seeds were collected by Dr. Gillies in Chile. — *Didiscus cæruleus*; Umbellifera. An annual-rooted terete-stemmed plant from New Holland, with blue flowers; the fruit is between orbicular and reniform, quite flat, and granulated on the surface; the seeds are pendent and obovate.

No. XXV. for January, 1829, contains

2876 to 2883. — *Calceolaria connata*; Scrophularinæ. Seeds received in 1827 from M. Hogan, Esq.; consul of the United States at Valparaiso. Stems herbaceous, and the blossoms produced abundantly during the whole summer and autumn, on a cool shelf in a green-house. — *Brodiaea grandiflora*; Hemerocallidæ. (fig. 26.) This beautiful purplish-blue flowered plant was found by Mr. Menzies, in 1792, in New Georgia, and, subsequently, by Mr. Douglas and Dr. Sconler, throughout the dry plains west of the Rocky Mountains. The bulbs introduced to this country have flowered in the open border, in peat soil, in July. — *Brassavola tuberculata*; Orchidæ. This plant, which bears yellow flowers, resembles, in habit, *B. cucullata*, and is a native of the trunks of trees in rocky places, at the entrance of Bontafogo Bay. It produced flowers in July, 1828. — *Abronia mellifera*; Nyctaginæ. The white blossoms of this plant, which is a native of California, have a powerful honey-like smell in the evening. It flowers in sandy peat, and may soon form a valuable addition to our flower borders. — *Horkelia congesta*; Rosacæ. A hardy white



26

flowered perennial, allied to the genus *Sibbaldia*. — *Elichrysum incanum*; *Compositæ*. A herbaceous plant, bearing large terminal solitary flowers, from Van Dieman's Land, and flowering in May. — *Vesicaria arctica*; *Cruciferae*. A most desirable plant for rockwork, with bright vivid yellow flowers in August and September; it was first discovered at Omenak in Greenland, by Professor Gieseke. — *Gilia inconspicua*; *Polemoniaceae*. An annual branching plant, with solitary white flowers, in the early part of summer, when cultivated in sandy peat.

No. XXVI. for February, contains

2884 to 2890. — *Poinciana regia*; *Decan. Monog.* and *Leguminosae Cæsalpinea*. (fig. 27.) "A magnificent tree 50 or 40 ft. high, having an

erect trunk, three feet in diameter, for half its height unbranched, covered with a grey smooth bark; the wood white; above forming a vast cyme of alternate patent branches, the younger ones green spotted with white, and glabrous. . . . No less remarkable for its extreme beauty than for its rarity, having been found only in Madagascar. . . . Plants have been raised by Mr. Barclay, at

27

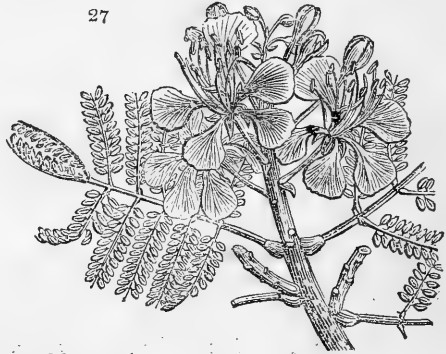

Bury Hill, from seeds sent by Mr. Telfair; and there is every reason to think they will be brought to great perfection in that well managed establishment." — *Portulaca grandiflora*. — *Iris tripétala*. — *Eschscholtzia californica*; *Polyán. Tetrag.*, and *Papaveraceae*. The following note, appended by Dr. Hooker to the description of this genus, shows the influence of accident in botanical matters, and may guard young botanists against confounding the names of two genera very much alike in sound. "Named by Chamisso in honour of Dr. Eschscholtz, an excellent botanist and entomologist, who accompanied him as a fellow-naturalist in the voyage round the world, under the command of Kotzebue. It is not, perhaps, generally known, that this gentleman is a descendant of the John Sigismund Elsholtz, a Prussian botanist, author of a *Flora Marchica*, and after whom Willdenow named the *Elsholtzia cristata*. The Russians, into whose service the present Elsholtz went, wrote his name Eschscholtz, by mistake. The genus is now so well established, that the alteration to another generic name might create unnecessary confusion." We have now, in consequence, *Elsholtzia* and *Eschscholtzia*. — *Pædonia albiflora* v. *rosea*. — *Ænothera decumbens*. An annual from dry soils and mountain valleys in South California, by Mr. David Douglas, in 1827, to the Horticultural Society. — *Escallonia rubra*; *Pentán. Monog.*, and *Escalloneae*. A shrub from Chile, with numerous twiggy, rounded, red branches, more or less pubescent, and sprinkled with pedicellated glands, and terminal peduncles of deep red flowers. Raised in the botanic garden of Liverpool, where it flowered in September last, and supposed to be hardy.

We are happy to find that Dr. Hooker has at last thought it worth while to follow Mr. Lindley, Mr. Sweet, and ourselves, in giving the derivation of the generic names; his next step is to give the accentuations; and a third step, which we hope the public will induce all our three friends to take, is the adoption of our mode of designating classical, aboriginal, and commemorative names by Italic letters. We had the pleasure of pointing out this improvement in September last, in Paris, to Professors Decandolle, Mirbel, Desfontaines, and others, and we have reason to believe

that it will soon be adopted by one or more of them in their botanical publications.

We are, indeed, at a loss to account for the indifference of Mr. Curtis, the conductor and proprietor of the *Botanical Magazine*, to these improvements. Does he or Professor Hooker think them of little consequence? If so, we can tell them, and some other editors of botanical works also, that the public think otherwise; and we can tell them also, that, if they persist, they will in time feel this to be the case. We wish every success both to the *Botanical Magazine* and the *Botanical Register*; but how is it possible that we can recommend the former, when, by neglecting the improvements of the day, it perversely persists in keeping itself inferior to the latter. Let the *Botanical Magazine* adopt the accentuations and the Italic designations, and it will then be in advance of even the *Botanical Register*. We have still other improvements to suggest, but we shall not do so till we see these adopted.

*Edwards's Botanical Register.* Continued by John Lindley, F.R.S. L.S. &c. Professor of Botany in the London University. In 8vo Numbers, monthly. 4s. coloured.

No. VII. for September, contains

1175 to 1180. *Streptocarpus Réxii*; *Bignoniaceæ* § *Didymocarpeæ*.

(fig. 28.) This beautiful stove perennial plant flowers every month in the year, in great profusion. It may be easily cultivated in light peat and loam, with a little sand, and increased by seeds. — *Collomia grandiflora*; *Polemoniaceæ*. A fine hardy annual about 2 ft. high, with flowers in hemispherical heads, stem erect, and leaves ovate-lanceolate. From the north-west of North America, by Mr. Douglas. It flowers abundantly in June and July. It should be cultivated in a poor shady border, among other plants. — *Liparis* (*liparos*; unctuous; soft surface of the leaves of some species) *elata*; *Orchidææ*.



A "tender, stove, herbaceous plant," discovered near Rio Janeiro by Sir Henry Chamberlain. It grows freely in decayed wood, and flowers in July and August. — *Berberis repens*; *Berberidææ*. This hardy, evergreen, yellow-flowered shrub is a native of the north-west part of North America, and flowers in April. Propagated with difficulty by its creeping roots. — *Daphne hybrida*. "Nothing is known of its origin." It is quite hardy, blossoms nearly all the year, and is desirable from its delicious fragrance. — *Tellima* (an anagram of *Mitella*, the genus from which this is divided by Mr. Brown) *grandiflora*; *Saxifragææ*. A hardy perennial found on the north-west coast of North America, by Mr. Menzies. It produces its flowers in April and May, but they are not strikingly beautiful. "It loves a shady peat border, in which it is protected from high winds." — *Lonicera involucrata*; *Caprifoliaceæ*. A curious, hardy, low, rather scrubby shrub, from Hudson's Bay, in 1824. It requires peat earth in a shady border. *Eutoca* (*cutokos*, fruitful; from the number of seeds which it bears) *multiflora*; *Hydrophylleæ*. A hardy annual of great beauty, from dry, exposed, sandy situations in the north-west of North America, by Mr. Douglas. It flowers from April to May, is well adapted to rockwork, but will not thrive in the ordinary highly manured soil of a garden.

## No. VIII. for October, contains

1181 to 1187. — *Bilbergia pyramidàlis*; Bromeliàcæ. A beautiful-flowered plant from South America, highly deserving cultivation. — *Clivia* (named in compliment to Her Grace the Duchess of Northumberland. "Such a compliment has long been due to the noble family of Clive, and we are proud in having the honour of being the first to pay it") *nóbilis*; Amaryllidææ. (fig. 29.) A fine green-house plant, much resembling a *Cyrtánthus*, of easy culture, and may be propagated either by seeds or



suckers. — *Brodiaea grandiflora*; Hemerocallidææ. A beautiful, hardy, bulbous plant, with purple flowers, from North-west America, by Mr. Douglas, to the Horticultural Society, in 1826, and grows freely in a peat border. — *Verbena* (from *ferfaen*, the Celtic name) *Meléndris* (the vernacular appellation in the province of Buenos Ayres); Verbenæcæ. A handsome perennial scarlet-flowered plant, with opposite leaves, and abundantly flowering from cuttings in June and September, but, probably, requiring a frame in winter. It is common on the plains of the Pampas of Buenos Ayres, and is found in the provinces of Cordova and San Luis. — *Sophora velutina*; Leguminosæ. "A fine green-house shrub," which, if naturalised, would be very desirable. It is a native of Nepal, and is raised from seed. — *Galardia aristata*. A handsome, hardy, nearly evergreen, perennial plant, with fibrous roots, and found by Mr. David Douglas in the north-west of North America. It is propagated from seeds, or divisions of the roots and flowers, from June to October. — *Cotoneaster* (*cotoneum*, the name of the quince, by Pliny, and *ad instar*, similitude; resemblance to quince) *microphylla*; Pomæcæ. A hardy evergreen shrub, of great beauty, flowering in April and May; the flowers frequently in twos or threes. It strikes readily from cuttings or layers, and grows from 2 to 3 ft. high.

## No. IX. for November, contains

1188 to 1194. — *Amaryllis acuminata* var. *longipedunculata*; Amaryllidææ. This fine variety of *A. acuminata* was found near San Pablo Quatro-Venados, in the state of Oaxaca, in Mexico, and differs from it in

being more robust in its growth, with narrower leaves, longer flower stalks, and a more spreading umbel. It may be easily cultivated in a cool green-house.—*Serapias* (the Egyptian divinity) *cordigera* var. *longipétala*; *Orchidææ*. (fig. 50.)

A "beautiful spring flower, common about Rome, in very dry soil." It is mentioned by Tenore as abounding at the foot of Mount Vesuvius, near Ottojano, Mauro, Mortelle, Portici, &c., invariably in very dry meadows.—*Adenotrichia* (*adên*, a gland, *thrix*, hair; intermixture of hairs and glands over the whole plant) *amplexicaulis*; *Compositææ*. A pretty green-house herbaceous plant, flowering in May. Brought from Chile, by Mr. James M'Rae, to the Horticultural Society, in 1826.—*Cytisus multiflorus*; *Leguminosææ*.

"A very beautiful hardy border shrub, remarkable for the profusion of bright yellow flowers with which its long slender branches are laden." It does not grow above 2 or 3 ft. high, and is easily propagated by layers. Its native country is unknown.—*Delphinium Menziesii*; *Ranunculæææ*. A beautiful hardy upright perennial, with deep purple flowers, from the north-west coast of North America, by Mr. Menzies, and recently by Mr. Douglas.—*Conanthera* (*kônos*, a cone, and *anthera*, an anther; conical arrangement) *campanulata*; *Asphodèleææ*.

A hardy bulbous-rooted green-house plant, remaining in flower for several weeks, and remarkable for the intense bright blue of its nodding blossoms. It is a native of the higher range of the Cordilleras, "appearing among the earliest of the vernal flowers with which the greensward is adorned on the first melting of the snow." It requires a light sandy loam, well watered when coming into flower, but after the blossoming is over to be kept dry.—*Calandrinia grandiflora*; *Portulacæææ*. A beautiful succulent from Chile, to the Horticultural Society, by Mr. James M'Rae, in 1826. It is a handsome bush, with large bright rosy purple flowers, and fair glaucous leaves. Great care is required in its cultivation; cuttings or seeds.



30



31

No. X. for December, contains

1195 to 1202.—*Hamèlia* (the celebrated Henry Louis Duhamel Dumonceau, "whose researches in vegetable physiology are the most perfect model of patient investigation, and accurate deduction, with which botanists are acquainted") *ventricosa*; *Rubiæææ*. "A handsome hot-house plant, growing vigorously, and flowering in abundance in nearly all the summer months." It becomes a large tree in its native country, Jamaica, yielding handsome variegated planks, called by the cabinet-makers Spanish elm or king wood.—*Pÿrus spÿria*; *Pomacæææ*. (fig. 31.) A handsome shrub, or small tree, but little known, and rarely seen in gardens. It has been supposed to be the hybrid offspring of the mountain ash, and the arbutus-leaved pear

of North America. It flowers in June and July, and is succeeded by a very small quantity of berries. Propagated by grafting or budding upon the stocks used for the appletree. — *Ophrys aranëifera* var. *limbata*; Orchideæ. A pretty hardy perennial spring plant, when wild loving to grow in chalky soil among short grass; and, if cultivated, must be in a pot in a well aired frame — *Lupinus littoralis*; Leguminosæ. "A hardy perennial, flowering from June to October, propagated by cuttings, division of the roots, and seed. . . . This species is abundant on the sea shore, from Cape Mendocino to Puget's Sound, where it binds together the loose sand with its tough branching roots. It is used by the natives of the river Colombia as winter food. For this purpose it is prepared by drawing the roots through the fire, until all their moisture is dissipated; when they are tied up in small bundles, and will keep for several months. For eating, the roots are roasted in the embers, when they become farinaceous. The vernacular name of the plant is *Somüüchtan*. It is the liquorice spoken of by Lewis and Clarke (p. 452.), and by the navigators who have visited the north-west coast of America." — *Canavalia bonariënsis*; Leguminosæ. A lovely, climbing, tender stove plant from Buenos Ayres, and flowering during most of the summer months. Cuttings. — *Lobelia longiflora*; *Lobeliaceæ*.

(fig. 52.) "One of the most venomous of all known plants. It is common in St. Domingo, Cuba, Jamaica, and Martinique, where it grows in damp places and by the sides of stream. In this country it is only cultivated in the stove, where it is a rarity. It is an annual, flowering in July and August, and seldom exceeds a foot in length. In its native country it is said to prove fatal to horses which eat it, swelling them until they burst; whence the Spaniards call it *Rebenta cavallos*. Taken internally, it acts as a violent cathartic, the effects of which no remedy can assuage, and which ends in death. The juice of the bruised leaves or stem, applied to the eyes or lips, excites a severe inflammation; as Jacquin tells us he found to his cost, having accidentally allowed some of the juice to remain on his hands. The natives of St. Domingo know the plant well under the name of *Quodec*." Figured from a specimen grown in the Syon gardens, by Mr. Forrest, F.L.S. — *Digitàlis (digitabulum)*, a thimble; form of flowers) laciniata; Scrophularinæ. A hardy perennial, with yellowish green flowers in June and July. Increased by division of the roots. From the nursery of Messrs. Young of Epsom. — *Gesneria macrostachya*. This is a handsome tender stove herbaceous plant from Rio Janeiro, in 1825, by Mr. Sellow, and flowering at all seasons of the year.

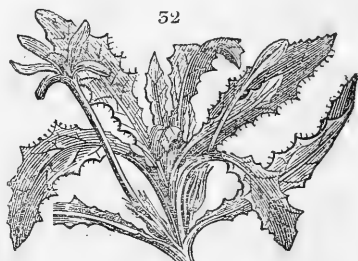

No. XI. for January, 1829, contains

1203 to 1209. — *Concéphalus naucleiflorus*; *Urticææ*. "A large scandent woody plant, common in the forests of Chittagong, &c., and the eastern frontier of Bengal, with beautiful and fragrant flowers appearing at various times throughout the year." From the hot-house of the Comte de Vandes at Bayswater, where it flowered some years ago, and again the last year.

"It is one of the multitude of curious and beautiful plants, for which our country is indebted to the splendid liberality of the Honourable Court of Directors of the East India Company; a liberality truly worthy of that princely body, which has been exercised in a manner absolutely unheard of in the annals of the most wealthy potentates, or of the most powerful governments; and which may be justly asserted to have conferred more real benefits upon science, than the united efforts of all the sovereign princes of

Europe. Under the patronage and protection of the East India Company, and by the indefatigable exertions of Dr. Wallich, the Flora of India has been explored to a degree which could never have been anticipated in the present generation; and the brilliant results of these researches have not been left to perish in a few private gardens, or to moulder in the garrets of inaccessible and unarranged museums. On the contrary, enormous contributions have been making for years; not only all England, but the hot-houses of the most remote gardens of Europe, have been supplied with the vegetable wealth of India; and the best part of the Flora of Nepal will soon be as well known in the flower-gardens of English cottagers, as to the Nepalese themselves. Of dried plants, unheard of multitudes are destined by the Company for distribution, under the direction of Dr. Wallich, among the public and private collections both of England and of Europe. In short, the obligations imposed upon us by these acts of truly Oriental munificence are of such a nature, that it has become the bounden duty of all men, who have the interests of science and of civilisation at heart, to take every opportunity of expressing the deep sense, which they cannot but feel, of measures which so redound to the honour and glory of the Company."

*Hósta cærùlea*; *Verbenàcæ*. A beautiful stove shrub with blue flowers, native of South America and the West Indies, from Syon gardens. — *Sálvia involucràta*; *Labiàtæ*. A very handsome plant from Mexico, a lovely border flower during the autumn months, and in the conservatory the greater part of the summer. Propagated by cuttings. From Tate's nursery in Sloane Street. — *Maxillària ciliàta*; *Orchídeæ*. § *Vándææ*. (*fig. 53.*) The most curious of the *Maxillària* tribe. "The bulbs (*fig. 53. a*), as they are improperly but commonly called, of this tribe of *Orchídeæ* are, in fact, stems in a particular state. Botanists have as yet given no definite name to them, wherefore we propose hereafter to distinguish them by the denomination of *pseudo-bulbi*." — *Pýrus angustifólia*. A handsome hardy sub-evergreen shrub, not often found in cultivation, and yet deserving to be known much more than many of greater note. Perfectly hardy, and propagated by grafting upon the common crab stock. — *Pæónia híbrida*; *Ranunculàcæ*. The most beautiful of the cut-leaved pæonies, from all which it differs strikingly in the deeper red of its flowers. The study of the pæonies, in the garden of the Horticultural Society, "has now made it evident that it is a genuine species. At least we have Mr. Sabine's authority to say that such is his opinion." — *Hedýchium cocéneum*; *Scitamínææ*. "Widely different from all the other species, by the deep red colour of its flowers, and perfectly spear-shaped leaves."

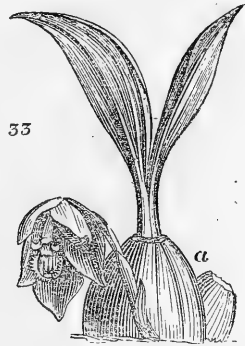

*No. XII. for February, contains*

1210 to 1216. — *Calathèa grandifólia*. — *Chelòne nemoròsa*. Intermediate between *Pentstèmon* and *Chelòne*. "A native of mountain woods, near springs and rivulets, in the north-west part of North America, where it was discovered by Mr. Douglas, flowering from July to September. It was raised from seeds in the garden of the Horticultural Society in 1827, and flowered in July and August, 1828." It prefers a rich vegetable mould, in a situation not too much exposed to the sun. — *Kæmpfèria Roscoeàna*. Dedicated by Dr. Wallich to his "highly revered friend William Roscoe, Esq., of Liverpool, whose splendid monograph of the beautiful,



but most difficult, tribe to which both those plants belong, reflects new lustre upon a name already immortalised in the annals of literature and philanthropy. . . . The leaves are extremely beautiful, being marked on their upper surface with dark green and purple belts or spots, not very unlike the leaves of *Maránta zebrína*." For the information given respecting this plant and the following one, Mr. Lindley expresses acknowledgment to Dr. Wallich, adding, that that information will serve "to convey some idea of the minute attention which has been given to every part of Indian botany by our distinguished friend, and of what may be expected from the splendid works, to the publication of which he is now devoting himself." The plant is a native of damp shady rocks, upon the mountain of Taong Dong, near Ava, 1000 ft. high, and with us requires the bark stove. — *Pholidóta* (*pholis* a scale, *óta* ears; scaly earlike bractæ of the spike) *imbricàta*; Gynán, Monog., and *Orchídeæ Malaxídeæ*. An epiphyte upon the mountains west of Ava. Dr. Wallich remarks, in a paper quoted by Mr. Lindley, that, "like most members of this lovely tribe, it is easily made to grow on the trunks of old trees, taking care to place some vegetable mould under its roots, and tying it so as to retain its situation. It requires constant humectation, which is easily effected by means of a small vessel suspended over it, with a perforated bottom, through which the water is let down upon the plant by means of a string, the upper end of which fills, though it does not quite shut up, the aperture of the vessel. It is propagated by separating its bulbous stems, which generally form dense tufts, ornamented with evergreen, dark-coloured, shining leaves, of a peculiarly firm and leathery texture." — *Calceolària floribúnda*. A fine hardy suffrutescent species, newly introduced from Chile. Best treated as an annual, turned into the open border in May, and left in the autumn to perish. — *Calceolària ascéndens*. Succeeds perfectly in the open border during summer. Raised from seeds collected by Mr. James M'Rae, upon clayey banks on the Cordilleras. — *Lupinus ornátus*. In mountain valleys near the river Colombia. Perennial, flowering from May till the end of November. "Mr. Douglas remarks it is one of the finest of the tribe."

This number completes vol. xiv. of a work which only requires the indications in Italic letters, and a rigid adherence to the literal translation of specific names, distinguishing the expletive additions by Italics, as in this Magazine and in *Hortícus Britannicus*, to be very much to our satisfaction.

*Botanical Cabinet.* By Messrs. Loddiges. In 4to and 8vo Parts, monthly. Large paper, 5s.; small paper, and partially coloured, 2s. 6d.

*Part CXXXVII. for September, contains*

1561 to 1570. — *Xylósteum campaniflorum*. A neat bushy shrub, quite hardy, about 2 ft. high; supposed to come from North America. Increased by layers in good garden soil. — *Márica martinicénsis*. From Martinique, and not a foot high; must be cultivated in a stove in loam and peat soil; flowers early in spring. — *Cratægus Oxyacántha punicea*. A beautiful variety of thorn, quite hardy, and free in growth, and deserves a place in any garden; may be increased by budding upon the whitethorn — *Passiflora Herbertiána*. From New Holland a few years ago. "It requires the protection of a green-house, and may be increased by cuttings." It flowers in the beginning of summer, and produces fruit. — *Erica bruniádes*. From the Cape of Good Hope in 1790, and requires a light airy green-house; by cuttings in sandy peat earth. — *Iris cristata*. A delicate and beautiful hardy species, from North America, increased by separating the roots; it likes a shady situation. — *Mirbèlia dilatata*. From the south-west coast of New Holland, by Mr. Brown. Its flowers are elegant; it requires the green-

house, and is increased by cuttings in a sandy peat soil, with a small part loam. — *Sempervivum caliciforme*. From Madeira, by Mr. C. Smith. It flowers in May, and requires a green-house in winter; may be increased by cuttings in sandy loam. — *Verónica caucásica*. From Caucasus in 1815. It is perennial, quite hardy, and flowering in May and June; increased by dividing the roots in spring in a light loamy soil. — *Trichonema cruciatum*. A minute pretty May and June flowering bulbous plant. From the Cape of Good Hope, and requiring a warm situation in a narrow border, in sandy peat.

*Part CXXXVIII. for October, contains*

1571 to 1580. — *Mirbèlia reticulata*. A pleasing green-house plant, from New Holland, flowering in the beginning of summer, and propagated by cuttings. — *Gaulthèria Shallon*. A pretty hardy plant, from the north-west coast of America, growing in the shade in peat earth; cuttings. — *Galium græcum*. A pretty hardy plant. — *Cotoneaster microphýlla*. A fine evergreen hardy shrub, from Nepal; cuttings. — *Erica coccinea*. — *Prostanthèra violacea*. A soft shrubby plant, from New Holland; cuttings, peat and loam. — *Boronia denticulata*. An ornamental green-house plant, from New Holland; cuttings, sandy peat. — *Viola debilis*. From North America. Cultivated without difficulty in light loam, by separating the roots in spring. — *Medicago arborea*. A bright, diffuse, and showy-flowered plant, from Greece and Italy; cuttings in light loam. — *Polygala Sénega*. A herbaceous plant, from Canada, about 6 in. high, and flowering in June in sandy loam and peat.

*Part CXXXIX. for November, contains*

1581 to 1590. — *Maurándia Barclaiùna*. A beautiful climbing plant, from Mexico. — *Azàlea nudiflora tricolor*. A fine variety, from North America. — *Anchusa itálica*. A moderately hardy herbaceous plant, from Italy. — *Gypsóphila glomerata*. A hardy perennial, from Tauria. — *Erica decora*. A very pretty kind, from the Cape of Good Hope. — *Rudbéckia hirta*. A beautiful hardy perennial, from North America. — *Teucrium pyrenæcum*. A pretty herbaceous plant, from the Pyrenees. — *Astrágalus breviflorus*. A hardy low shrubby plant, from Armenia. — *Periplóca græca*. From the south of Europe. — *Erigeron Villársii*. A moderately hardy perennial, from the south of Europe.

*Part CXL. for December, contains*

1591 to 1400. — *Trigonélla ruthénica*. A neat Siberian perennial. — *Cotylèdon ovata*. — *Erica lævis*. — *Azàlea calendulacea*. A hardy bushy shrub, from North America. — *Nitrària Schobèri*. A hardy low spreading shrub, from the salt and nitrous deserts to the north of the Caspian Sea. — *Monárda purpurea*. A hardy perennial, from the mountains of Virginia. — *Verónica incisa*. — *Sinningia velutina*. — *Gratiola aurea*. A hardy golden-yellow-flowered perennial, from North America, thriving in sandy peat earth. — *Dracocéphalum denticulatum*.

This part completes the fifteenth volume of this pretty and economical work, which we should like to see a little more scientific, and, at least, the natural orders, derivations, accentuations, indications, and short generic and specific characters in English, given.

*Part CXLI. for January, 1829, contains*

1401 to 1410. — *Hedýsarum elongatum*. A hardy perennial received from Dr. Fischer, of St. Petersburg, in 1826. — *Calceolària plantaginea*. From Chile. Herbaceous, and requiring the green-house in winter. — *Spiræa vacciniifolia*. A low shrub, from Nepal, with white flowers, and of easy propagation and culture. — *Roscóea purpurea* (*fig. 54.*); *Scita-*

míneæ. From Nepal. "Deservedly named by Sir J. E. Smith in honour of the excellent Mr. Roscoe, who has distinguished himself so much by his labours to illustrate this interesting order of plants." Stove, in sandy loam, and difficult to propagate. — *Onósmá taúrica*. A brilliant little herbaceous plant, from Tauria and Caucasus. Light loam, and not easily propagated, unless seeds are obtained. — *Campánula capillàris*. About 6 in. high. From New South Wales. — *Achillèa ròsea*. From Hungary in 1825. — *Calàdium zamiaefòlium*; *Aróideæ*. A singular and curious plant, from Brazil. Stove. — *Erica cinèrea atropurpùrea*. From the Highlands of Scotland, but grows well in a pot, and may be increased with facility by cuttings. — *Aconitum neubergènsè*. A hardy perennial, from Styria and Hungary, in 1825.

34

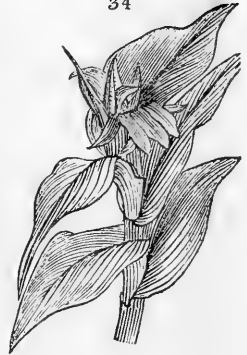

Part CXLII. for February, contains

1411 to 1420. — *Eccremocárcpus* (*ekkre-mès*, pendulous, *karpos*, fruit) scàber; *Didynàm*. Angios. and *Scrophularíneæ*. (fig. 35.) A beautiful



35

climbing plant, lately introduced from South America. "Its stems are half shrubby, in its native country running over the bushes, and flowering nearly throughout the year. With us it blooms in the latter part of summer, and is very ornamental, especially when planted in the full ground. It requires protection from frost, and will grow in any good garden soil, increasing either by cuttings or seeds, which ripen very well in this country."

— *Stàchys áspera*. — *Erica præcox*. — *Ceratochilus* (*kerate*, two horns, *cheilos*, lip; two horns of the lip); *Gynán*. Monog. and *Orchídeæ*. From Trinidad in 1824, with large, fragrant, but fleeting, flowers. Stove; in moss, sawdust, and sand, with a good supply of water. — *Fúchsia multiflòra*. Handsome, like

all the other species, and bears the winter pretty well in a warm sheltered situation. — *Anémia Phillítidis*; *Cryptog. Fílic*. An interesting fern, from the forests of St. Domingo, and from Trinidad. — *Liàtris sphæroídea*. — *Phlóx divaricàta*. — *Zephyránthes cándida*; *Hexán*. Monog. and *Liliàceæ*. — *Pentstèmon angustifòlium*. Pretty; from Mexico, by R. Barclay, Esq., of Bury Hill; cuttings, in good garden soil.

*The British Flower-Garden*. By Robert Sweet, F.L.S. &c. In svo Numbers, monthly. 3s.

No. LXVII. for September, contains

265 to 268. — *Eschschóltzia califórnica*; *Papaveràceæ*. Perennial, with a fleshy root and bipinnatifid glaucous leaves, and golden-yellow flowers. Discovered a great many years ago by Archibald Menzies, Esq. F.L.S., but living plants first raised from seeds sent by Mr. David Douglas. Flowers and ripens seeds freely. — *Polemòonium villòsum*. Pretty; hitherto scarce, but now plentiful in Russel's nursery at Battersea. — *Alstræmèria Símsii*; *Amaryllídeæ*. The roots long fleshy white tubers; the leaves 3 in. long, and 1 in. broad at the widest part, very much twisted, and glaucous; the flowers in terminal umbels of an orangy scarlet, open and a little reflexed,

striped with dark purple. Altogether a splendid plant, which will stand very well in a warm border, protecting it from the slugs, and from severe frost. Soil a light loam, mixed with a little peat or decayed leaves, and one half sand. — *Ænothëra roseo-álba*; *Onagràriæ*. An annual. “One of the most beautiful species of the genus, and thrives well in the open border.” Supposed to be a hybrid production, produced in the German gardens.

No. LXVIII. for October, contains

269 to 272. — *Rhëum* (from the river Rha, now the Volga, beyond which grows a root bearing its name, much renowned in medicine, according to Dioscorides; from *rheô*, to flow, in allusion to its medicinal qualities, according to Linnæus) australe; *Polygônææ*. The leaves are heart-shaped, large, their margin set with little red glands; the flowers are of a blood-red, as are the seed-vessels; and, from these circumstances, it is easily distinguished from every other species of the genus yet known. Dr. Wallich, of Calcutta, first transmitted seeds of this species to England; from which plants were raised by A. B. Lambert, Esq., of Boyton House, and flowered in June, 1828. Mr. Don and Mr. Sweet consider it “undoubtedly the handsomest species of the genus,” independently of “the interest attached to it as a medicinal plant.” The following description is by Mr. David Don:—

“The stem in the cultivated plant is from 7 to 10 ft. high; the leaves are numerous, ample, and of a grassy green; the flowers are smaller than in any other species of the genus, of a dark or blood-red colour, and disposed in many branched clusters; the seeds that afterwards appear are dark red, with a highly polished surface, resembling, at a distance, clusters of glittering beads. When bruised, they emit a powerful odour of rhubarb, are highly astringent, and dye the fingers red, from the quantity of colouring matter contained in the testa. It is perfectly hardy, and appears to ripen its seeds even more copiously than the other species; and, from some trials that have been made with the footstalks of the leaves, it seems disposed to vindicate its medicinal claims even in our own climate. The colour of the flowers would alone be sufficient to distinguish it among its congeners. The late period of flowering deserves also to be remarked. As all the species are endowed, in a greater or less degree, with similar properties, much difference of opinion has arisen, both among botanists and pharmacologists, respecting the one that yields the rhubarb of commerce. Linnæus considered it at first as the produce of his *R. Rhabárbarum* or *undulatum*, but he afterwards appears to have altered his opinion in favour of *R. palmatum*; which opinion has been almost universally adopted by pharmacological writers, although it is admitted that the qualities of the root of *R. palmatum* differ materially from the Turkey rhubarb of the shops: but this deterioration has been attributed to the difference of soil and climate. The *R. australe* appears to be peculiar to the great table lands of central Asia, between the latitudes of  $31^{\circ}$  and  $40^{\circ}$ , where it is found to flourish at an elevation of 11,000 ft. above the level of the sea. Large quantities of the roots are annually collected for exportation, in the Chinese provinces within the lofty range of the Himalaya. The best is that which comes by way of Russia, as greater care is taken in the selection; and on its arrival at Kiachta, within the Russian frontiers, the roots are carefully examined, and the damaged pieces removed.”

Mr. Sweet has been “informed that the stems of the leaves have the same effect as the root; only, of course, a greater portion of them will require to be used. They may be made up in a small tart, like the stems of the common rhubarb.” Culture as in the other species, covering the roots a little in very severe winters.

*Tropæolum tricolorum*. (*fig. 36.*) The root is tuberous, oblong, with a rough brown bark; the stem slender, climbing to the height of 10 or 12 ft.,

by the twisting of the footstalks of the leaves; the leaves are peltate, and so deeply divided, as at a distance to resemble those of the common lupine; the flowers are numerous, axillary, of a glossy scarlet orange colour, with a circle of dark purple, nearly black, round their margin. Altogether, it is one of the most beautiful and interesting climbers that have been introduced to this country for some time; and we have no doubt its tuberous roots, about the size of beans, will be as much in demand for planting close to bowers and verandas, as those of crocuses are for beds and borders. "Some roots of the present, and another species, were presented to Mr. Anderson by Miss Oriana Georgiana Reinagle, who received them from Miss White, daughter of the Vice-Consul at Valparaiso." We hope Mr. Sweet will take the first convenient opportunity of dedicating a genus to each of these young ladies. — *Salpiglossis atropurpurea*; *Solanææ*. Perennial, or perhaps biennial; the leaves elliptically oblong and sinuated; the flowers large, dark purple, sometimes nearly black, and orange-coloured in the throat; they vary considerably in size, according to the soil and situation. A light rich soil, a warm border, with a little protection in winter; propagation by cuttings under hand-glasses, or by seeds which ripen plentifully. — *Taxánthema (taxis, arrangement or order, anthemus, flowery; flowery arrangement of the spikes) incana*; *Plumbaginææ*. Perennial; lanceolate leaves, and small flowers, varying from dark red to nearly white. Very handsome, and of easy culture in rich loamy soil, rather sandy.

No. LXIX. for November, contains

275 to 276. — *Cyclobóthra barbata*; *Tulipæææ*. Bulbous-rooted, with very long leek-like leaves; stem slender, leafy, and about a foot high; and the flowers of a golden-yellow colour, and nodding. — *Iris tridentata*; *Iridææ*. A very handsome and singular species, from North America, with purple flowers; at present rather scarce, but thrives well in the open border of the garden; pretty readily increased by divisions of the root. — *Echevèria grandifolia*; *Crassulæææ*. This magnificent plant is a native of Mexico, suffrutescent and succulent, with thick, smooth, blue leaves; stalk upwards of 5 ft. high, and flowers variegated with orange, purple, and blue; the leaves, though they appear firm, come off easily. It flowers abundantly in a light sandy soil by the side of a wall in a southern aspect, and covered by a mat in frosty weather. — *Hunnemánia* ("We have named it in compliment to our friend, Mr. John Hunneman, who, through his numerous correspondents in various countries, has been the means of introducing a greater number of plants to our collections than almost any other individual; and we are somewhat surprised that a genus has never been named after him before.") We agree with Mr. Sweet in wondering that no one has before dedicated a genus to Mr. Hunneman; and the only way of accounting for it that we can think of is, that botanists have felt that the long and unremitting services rendered by him to science and scientific men, have been too serious to admit of the light and ordinary idea recurring to them, of rewarding these services by a compliment. There is not a botanist or reading gardener on the Continent or in this country to whom the name of Hunneman is not familiar; and by far the greater number of the former are under personal obligations to him, for transmitting them seeds, specimens, or books. We, of course, include ourselves among the number, and take this opportunity of acknowledging the services which we are continually receiving at his hands.) *fumarifolia*. An erect branching-stemmed plant, with linear leaflets, and large spreading flowers of a golden-yellow

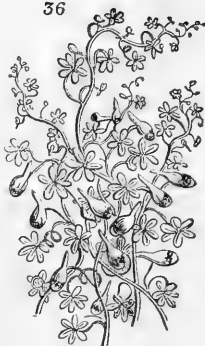

colour. It was raised in the collection of Robert Barclay, Esq., of Bury Hill, from seeds received from Mexico.

No. LXX. for December, contains

277 to 280. — *Hibiscus roseus*. A perennial from Italy, with large rose-coloured flowers, upon stems from 3 to 4 ft. high, but "requiring to be grown in some moist situation, otherwise it will not be likely to flower. — *Moricandia arvensis*; *Cruciferae*. Biennial, with glaucous obovate leaves, and elegant purple lilac flowers. From the south of Europe in 1739, but rarely to be met with in our gardens. From the Epsom nursery. — *Potentilla Russelliæna*. (fig. 37.) "The present splendid-flowering plant is of hybrid origin, being intermediate between *P. formosa* and *P. atropurpurea*, varying with leaves containing three, four, and five leaflets. It was raised from seed last year, by Mr. W. Russell, at his nursery at Battersea, who has employed a great deal of time with the plants of this genus, to try to obtain something handsome from them; and his labour has been so far crowned with success in obtaining the present handsome plant, which may be considered as one of the most splendid hardy perennial plants that need be cultivated in the open borders of the flower-garden, and is well deserving a place in every collection. Neither of its parents can come near it in brilliancy of colour, which is of a glossy scarlet. It is quite hardy, and thrives well in the open borders in the common garden soil, and may be increased by dividing at the root, but is not likely to ripen seeds, as the anthers are mostly all without pollen; so that it is not likely soon to become common. Mr. Russell has already increased it, and informs us that he is now selling the plants at one guinea each." — *Campanula dichotoma*. Annual, with nodding purplish blue flowers; very pretty, and quite a distinct species, lately introduced from Greece to Bury Hill.



No. LXXI. for January, contains

281 to 284. — *Heimia salicifolia*. (fig. 38.) A handsome little bushy evergreen shrub, with yellow flowers. It is a native of Mexico, and has



been cultivated several years in the botanic garden at Berlin. Warm border, and a little protection in winter. — *Georgina*\* (J. G. Georgi, a Russian botanist, author of various works, among others, *A Description of St. Petersburg*, 8vo, 1723) *crocata*; *Compositæ*. The *Dahlia fulgens* of gardeners. — *Lupinus canaliculatus*. Frutescent, handsome, and stately; raised at Bury Hill, but its native country at present unknown. — *Lobelia Tupa*. Perennial, somewhat frutescent, sessile woolly leaves, and scarlet flowers tinged with orange. From Mr. Lambert's garden at Boyton, where it grows 10 ft. high, and, though a native of Peru, is quite hardy. "The juice of the present plant is said to be very poisonous, which, we believe, is more or less the case with those of the whole genus."

\* This is Willdenow's name for the *Dahlia*, and Mr. Sweet very properly prefers it; because, unknown to Willdenow, a Cape genus had been named *Dahlia* by Thunberg. Thunberg's genus, therefore, had the right of priority; in consequence of which Decandolle, Kunth, and most of the Continental botanists, have adopted the name of *Georgina*. As this change is unques-

## No. LXXII. for February, contains

285 to 288. — *Podolepis* (*pous*, a foot, *lepis*, a scale; footstalks to the scales of the involucre) *gracilis*; *Compositæ Carduæcæ Astèriæ*. “A very pretty plant, from New South Wales, to the garden of Robert Barclay, Esq., of Bury Hill, quite as hardy and of as easy culture as the common annual Everlasting.” — *Hibiscus Moscheutos*; *Malvæcæ*. Beautiful; from the collection of A. B. Lambert, Esq., at Boyton House. “It is seldom that the present plant, or *H. palustris*, produces flowers in our gardens. The reason is, without doubt, through their being planted in too dry a situation, their native places of growth in America being in swamps and marshes. Pursh mentions the present species as growing in swamps and salt marshes, from New York to Carolina, and plentifully in the marshes round the Salt Lake, Onondago, New York; flowering from August to October.” It is most probably owing to the very wet summer that they flowered so freely this season, and by being planted in a moist situation; and there can be no doubt but they would flower as readily every season if planted near a pond, or in any wet swampy ground. They are quite hardy, and are readily increased by dividing at the root, or by seed. — *Gilia capitata*; *Polemoniæcæ*. One of the interesting discoveries “made by our indefatigable friend, Mr. David Douglas, in the north-west regions of America. It is quite hardy, and forms a valuable addition to the flower border, which it adorns during the summer months with its numerous tufts of pretty blue flowers.” It is annual; but, if sown at different seasons, between March and August, a succession of flowers may be kept up all the summer and autumn. — *Dianthus giganteus*; *Caryophyllæ Silenæcæ*. A gigantic species, from the nursery of Messrs. Young, of Epsom, and raised there from seeds received from Malaga.

*Geraniæcæ*. By Robert Sweet, F.L.S. &c. In 8vo Numbers, monthly. 3s.

Nos. I. to VIII. of Second Series, from July, 1828, to February, 1829,  
contain

1 to 31. — *Campylia laciniata*, *Pelargonium malachrafolium*, *P. abutiloides*, *P. megalanthum*, *P. megaleon*, *P. melanostictum*, *P. Victoriænum*, *P. megalostictum*, *P. calliston*, *P. magnifolium*. — *P. Obrienianum*. “In compliment to Miss O’Brien, authoress of several interesting papers in Loudon’s *Gardener’s Magazine*, and the *Magazine of Natural History*,” — *P. graphicum*. Very handsome. — *P. ænanthifolium*, *P. rhodopetalon*, *P. decorum*, *P. flagrans*. — *P. Loudonianum*. “Splendid and very distinct; raised by Mr. W. Smith, gardener to the Earl of Liverpool, at Coombe Wood, from a seed of *P. sanguineum*, fertilised by the pollen of *P. aurantiacum*, or some nearly related sort, so that it is intermediate between two very distinct tribes, partaking, in an equal degree, of both. We do not know when we have seen a more splendid flower, its colour being quite dazzling when in full bloom. We have named it in compliment to our respected friend, Mr. J. C. Loudon, &c. &c.” [For which we return our best thanks to Mr. Sweet; the more especially, for having selected so very distinct and handsome a variety.] — *P. hæmastictum*, *P. cratægifolium*, *P. nubilum*, *P. Debúrghæ*, *P. papyraceum*, *P. Lawranceanum*, *P. concretum*, *P. pentastictum*, *P. altum*, *P. vestiflum*, *P. latidentatum*, *P. eratinum*, *P. tinctum*, *P. heteromallum*, and *P. poculifolium*.

tionably just, we trust every young gardener will immediately adopt it; those who do not own to being young, may of course continue in their old nomenclature.

*Cistineæ.* By Robert Sweet, F.L.S. &c. In 8vo Numbers, every alternate Month. 3s.

*No. XX. for September, contains*

77 to 80. — *Heliánthemum vineàle.* Trailing, suffrutescens, very much branched, and covered with yellow flowers the greater part of the summer. — *Cistus acutifolius.* A free-growing but dwarf plant, quite hardy, with white flowers nearly all the summer. — *H. virgatum.* Numerous branches, linear leaves, and pink flowers, requiring some protection during winter. — *H. nummulàrium.* Procumbent, variable ovate hairy leaves, and yellow flowers. Quite hardy.

*No. XXI. for November, contains*

81 to 84. — *Heliánthemum scabròsum.* (*fig. 59.*) A handsome, small, bushy shrub, from the Bristol nursery, with yellow flowers, and requiring a little protection in winter. — *H. racemòsum.* An upright shrub, well adapted for ornamenting rockwork, from its glossy foliage, and flowering all the summer. Flowers white. — *H. glutinòsum.* Slender ascending hairy stems, small linear leaves, and small yellow flowers. Raised from seed received from Spain, in the garden of A. B. Lambert, Esq., of Boyton House. Requires a little protection during winter. — *Cistus ladaniferus var. albiflorus.* Very handsome. Requires a little protection during winter.



*No. XXII. for January, 1829, contains*

85 to 88. — *Heliánthemum celandicum.* A pretty little species, with small yellow flowers. — *H. roseum v. múltiplex.* A pretty double variety, with pale rose-coloured flowers, and thriving well in rockwork. — *Cistus asperifolius.* A handsome, strong, upright, evergreen shrub, with white flowers. — *H. polifolium.* This pretty species is quite hardy, and adapted for rockwork; the flowers are white, and the leaves are oblong and linear.

*The Botanic Garden.* By B. Maund, F.L.S. &c. In small 4to Numbers, monthly. Large paper, 1s. 6d.; small paper, 1s.

*No. XLIV. for August, 1828, to No. L. for February, 1829, contain*

172 to 200. — *Anchusa itálica.* "Desirable for the brilliant colour of its flowers. — *Onònis hircina,* *Tùlipa suavèolens,* *Scilla bifolia,* *Ròsa semperflòrens,* *Erythrònium americanum,* *Gentiàna vérna,* *Stèvia purpùrea,* *Erythrònium Déns cànis,* *Phlòx divaricàta,* *Fritillària meleàgris,* *Thýmus lanuginòsus,* *Ribes àureum,* *Phlòx nivàlis,* *Anemòne horténsis,* *Scilla sibírica,* *Eròdium hymenòdes,* *Hypéricum Kalmiànnum,* *Parnàssia palústris,* *Malcòmia marítima.* — *Ròsa Bánksia lùtea.* Accompanied by plain and concise directions for budding roses; illustrated by six very neat wood-cuts. — *Anemòne Pulsatilla,* *Clàrkia pulchélla.* — *Campánula lactiflòra.* Handsome and free-growing; and, according to Parkinson, the distilled water of the whole plant "cleanseth the skinne, and maketh the face very splendent and cleare."

*The Florist's Guide and Cultivator's Directory, &c.* By Robert Sweet, F.L.S. &c. In 8vo Numbers, monthly. 3s. coloured; 2s. plain.

*No. XV. for September, 1828, to No. XX. for February, 1829, contain*  
57 to 80. — *Penelope Tulip.* White, edged with a dark velvety purple. — *More's Navarino Auricula.* Very pretty. — *Erasmus Picotee.* Handsome. — *Le Vrai Noir Ranunculus.* Flowers very double, and black. — *Quillafila Ranunculus.* Very double. — *Lady of the Lake Tulip.*



A white, spreading, open flower, edged with a velvety purple. — Wild's Black and Clear Auricula. Pretty, and white-edged. — Cordon Bleu Carnation. A handsome, very large, and double variety. — The Morning Star Georgina (Dahlia). Very handsome deep crimson. — Sir George Duckett Tulip. Handsome, with bright yellow flowers variegated with scarlet and dark velvet. — Pucelle de Gand Carnation. Very handsome. — Julius Ranunculus. A curious and beautiful variety. — Redman's Metropolitan Auricula. — Hogg's Beauty of Middlesex Picotee. The flowers are double, not so large as some varieties, white slightly tinged with yellow, and edged with green. — Dennis's Imperial Georgina (Dahlia). Handsome, large, deep crimson flowers. — Bonaparte Tulip. A strong and tall-growing variety, with white flowers variegated with dark velvety purple. — Agricola Ranunculus. A handsome variety. — Gloria Alborum Tulip. A neat variety. — Strong's Duchess of Kent Tulip. Fine, and highly coloured. — Smith's Waterloo Auricula. Very handsome. — Platonia Tulip. Pretty; grown in the third row of the tulip bed, and sold at 30s. the root. — Xanthus Ranunculus. Handsome; from the collection of Mr. Groom at Walworth, who, by planting ranunculus roots at different seasons, contrives to have flowers all the year: a practice long in use among the German gardeners. — Lawrie's Glory of Cheshunt Auricula. One of the first-rate flowers, from the collection of L. Weltje, Esq., of Hammersmith; price, in Mr. Hogg's catalogue, 15s. to 20s. — Hird's Inimitable Picotee. Handsome. "From the select collection of Mr. T. Hogg, of Paddington Green, who, we believe, cultivates the largest collection of this tribe of flowers in this country." [We have brought Mr. Hogg a packet of carnation seed, from his friend and correspondent M. Bosch, Director-General of Royal Gardens to the King of Wurtemberg, which we hope will add something new to his collection.]

*Medical Botany, &c.* By John Stephenson, M.D., and James Morss Churchill, Esq., Surgeon. In 8vo Numbers, monthly. 3s. 6d.

*No. XXI. for September, contains*

80 to 87. — *Rhododéndron chrysanthum*; *Rhododéndra*. (*fig. 40.*) This is a beautiful shrub, the stem seldom exceeding, in alpine situations, 1 ft. in height, with few terminal ovate leaves attenuated to the footstalk, and large yellow flowers. It inhabits the mountains of Siberia, Kamtschatka, and Behring's Island, and was introduced, in 1796, to our gardens, by Mr. Joseph Bush. It exerts a stimulant and diaphoretic effect; and the Siberians use it in rheumatic and other affections of the muscles and joints. It sometimes flowers, in our gardens, in the middle of summer. — *Swietenia febrífuga*; *Mèliæ*. A native of the East Indies; and its bark is considered "a valuable astringent and tonic in intermittent fever." It is lofty, with a thick straight trunk; the leaves about 1 ft. long, alternate, and abruptly pinnate; the flowers are numerous, white, middle-sized, and inodorous; the wood is of a dull red colour, and very hard and heavy. "Its dose, in substance, is from one to four, five, and six drachms a day." — *Ranúnculus àcris*. A herbaceous indigenous plant of Britain, occurring everywhere in spring and summer, and blistering the mouths of cattle — *R. Flámmula*. This, in England, is usually called the Small or Lesser Spearwort, and grows plentifully in marshy places, all over Europe. It is very acrid, and inflames and blisters the skin when applied externally. — *Angélica archangélica*. This is either indigenous or completely



40

naturalised in this country, and flowers from June to September. Its root is large and fleshy, and brown externally, but white within; the stem is erect, and about 4 or 5 ft. high; the foliage and stalks are of a bright green; and the flowers are numerous, and of a greenish white colour. The Laplanders eat the stalks, roasted in hot ashes, for pectoral disorders; the leaves, seeds, and root are reckoned good aromatic tonics, taken in doses of three scruples to a dram, three or four times a day. — *Melaleuca Cajuputi*. A native of the Molucca Islands, and affords, from its leaves, the Cajeput oil of the shops. Its trunk is tolerably erect, and covered with an ash-coloured spongy bark; the branches are scattered and drooping; the leaves are alternate, not unlike those of the willow, and the flowers are small and white. The smell of the oil is supposed to preserve natural history collections from insects. — *Menyanthes trifoliata*, Buckbean or Bogbean. "One of the most beautiful of our indigenous plants," and is often found in large beds at the margins of ponds and brooks. The roots are long, creeping, and jointed, from which proceeds a smooth, erect, cylindrical stem, about a foot high, and destitute of leaves; the leaves are of a bright green, and obovate, and the flowers grow in a loose spike. It is an excellent and cheap tonic, and strengthens digestion, in doses of about 10 grains. — *Chelidonium majus*, Common Celandine. A perennial, growing wild in the hedges; rising from a spindle-shaped root, with a round, leafy, branched stem, and flowers of a golden-yellow colour. The juice is a violent acrid poison; it is used in medicine as a "stimulating aperient, diuretic, and sudorific." — *Helleborus orientalis*. The root of this plant is perennial, somewhat fleshy, and black externally, with a tall, round, leafy, purplish stem. The radical leaves are stalked, large, and pedate; those on the stem are "numerous, on roundish, smooth footstalks; channelled above, sheathing at the base, and slightly hairy below." The roots are acrid, and violently cathartic.

*No. XXII. for October, contains*

88 to 91. — *Tamarindus indica*; Leguminosæ. The tamarind tree is common in almost every part of India and the West Indies, and "grows most luxuriantly in all the Eastern islands. . . . The soil of Java is said to bring the fruit to very high perfection; and those of the dependent island of Madura are reported to be the best." It is considered dangerous by the natives of India to sleep under this tree, and its presence has a deteriorating effect on grass and herbs. Its thick and lofty stem is terminated by spreading branches, bearing tufts of alternate, smooth, bright green leaves, abruptly pinnate; the short lateral branches are terminated by flowers which are in simple clusters; the calyx is divided into four straw-coloured segments, and the petals are three, rather yellow, and beautifully variegated with red veins; the seeds are "roundish, somewhat angular, flattened, hard, polished, with a central circumscribed disk at each side, and lodged in a quantity of a soft pulp. . . . The fruit is cooling and laxative; but while it gratefully allays the thirst of ardent fever, it must be taken in large quantities to insure the latter effect, and is then apt to produce flatulence." The stones of the fruit are prescribed by the physicians in dysenteric complaints, and for menorrhagia. It is very much adulterated in commerce, and the deceit is very difficult to find out. — *Cicuta virida*; Umbelliferae. This plant, commonly called the Long-leaved Water Hemlock, is "by far the most active of the poisonous plants of Great Britain," but it is, fortunately, rather scarce. The root is perennial, the stem is very large, hollow, leafy, and branched; and the leaves are biternate, and of a bright green colour; the flowers are in large, many-rayed umbels, and are very small. It "is supposed by Haller and many others, to have yielded the celebrated Athenian poison." — *Guaiacum officinale*. "The tree rises to the height of 30 or 40 ft., and is near a foot in the diameter of its trunk, with numerous, divaricated, knotty branches, leafy at the ends. The bark is very smooth, variegated with green

and white; that of the branches being uniformly ash-coloured, striated, and marked with fissures. . . . The flowers are pale blue, on simple, axillary, clustered stalks, shorter than the leaves," which are smooth, dark green, opposite, and abruptly pinnate. The wood was first employed in medicine by the natives of St. Domingo. Guaiac may be said to be a stimulating medicine; proving diaphoretic in a dose of a scruple or half a drachm; and purgative, in large doses. — *Arbutus Uva úrsi*; *Ericæ*. A pretty evergreen shrub, both of the old and new continents. The root is perennial, long, and fibrous; the leaves not unlike those of the box; and the flowers are produced in June, and grow in small clusters at the extremities of the branches. It has been much used as a diuretic for calculous affections, particularly when attended by purulent discharges.

*No. XXIII. for November, contains*

92 to 95.—*Citrus Médica*, the Lemon Tree. Candied lemon peel is made by boiling lemon peel with clarified syrup, and then exposing it to the air till the sugar crystallises.—*Pýrola umbellàta*. Abundant in North America; the most beautiful of all the genus, and lately celebrated in this country as a tonic and diuretic.—*Coriàndrum sativum*. From the East, but naturalised in some parts of Essex. The bruised seeds smell like the bug, whence the name (*koris*, a bug); they are carminative and stomachic.—*Eugènia caryophyllàta*. (See *Caryophýllus aromáticus*, Vol. III. p. 66. fig. 27.)

*No. XXIV. for December, contains*

96 to 99.—*Zíngiber officinále*. From Asia, but now cultivated in the West India Islands, whence it is chiefly imported into Europe. Employed as an adjunct to other remedies. — *A'nthemis Pyrèthrum*, *Pellitory of Spain*. The root is a powerful stimulant, and, if applied in its recent state to the skin, it produces inflammation like *Mezèreon*. Used for the toothache and rheumatic affections. — *Pastinàca Opóponax*. A native of the Levant; affording, by incision of the root, the gum-resin called opoponax, an article of little medical value. — *Ròsa gállica*, the powder of the petals of which are used as an elegant colouring matter to other medicines.

*No. XXV. for January, 1829, contains*

99 to 105.—*Ròsa centifòlia*. A native of the south of Europe; the petals of which are considered to be slightly laxative; and the syrup is often mixed with a little almond oil, and given to children as a domestic medicine. — *Ròsa canina*. The most common ornament of our hedge-rows, and universally admired for its beauty. The pulpy part of the hips of the dog-rose, beat up with sugar, forms a confection, which sometimes enters into the composition of demulcent electuaries. — *Cròcus sativus*. This species produces the saffron of the shops. — *Myróxylon peruíferum*. This, the sweet-smelling balsam tree, yields the precious balsams of Peru and Tolu, and is a native of the warmest provinces of Mexico and Peru. It is an elegant branching tree, the branches extending almost horizontally, the leaves alternate, and the flowers white, and springing from the scars of the young branches. The Peruvian balsam has been prescribed as a remedy in paralysis, chronic rheumatism, and leucorrhœa; and, combined with calomel, has been efficacious for the tremors which arise from the noxious influence of lead. — *Polýgala Sénega*. A hardy perennial from North America, but of little beauty. The leaves are alternate, scattered, and lanceolate; the flowers are in loose, terminal spikes, generally white, and the stems are about a foot high; the root is sudorific and expectorant in small doses, and emetic and cathartic in larger ones. — *Polýgala rubélla*. From South America, with purple flowers in June and July, and scattered smooth leaves. It is a useful tonic in small doses; and, in large doses, operates as a cathartic, and excites diaphoresis.

*The Pomological Magazine.* In 8vo Numbers, monthly. 5s. coloured; 3s. 6d. plain.

*No. XI. for September, contains*

41. *The Long-stalked Blanquette Pear.* "A good early pear, a great bearer, very sweet, crisp, and juicy, and not rotting so quickly as most of the pears of the same season." The wood is strong, of a reddish brown colour, and a little silvery on the lower ends. The fruit is small, egg-shaped, and growing in clusters.

42. *The Belle de Choisy Cherry.* Raised at Choisy near Paris in 1760, and from its hardness, sweetness, and bearing well as a standard, well merits cultivation. The tree somewhat resembles the May Duke; the fruit is middle-sized, roundish, and depressed at the apex; the flesh is amber-coloured.

43. *The Black Naples Currant.* A very good variety, and "considered the best of the class;" the habit of the bush is rather upright, and, though the leaves and blossoms are produced early, the fruit ripens late.

44. *The Black Tartarian Cherry.* An excellent cherry, doing best on an east or west wall, where it is usually loaded with rich handsome fruit. The wood is vigorous, the branches spreading, and the fruit "large, heart-shaped, with uneven surface, and of a shining purplish-black colour." The flesh is purplish, rich, and juicy.

*No. XII. for October, contains*

45. *The Late Duke Cherry.* This cherry is evidently of English origin, though known to us only through the French gardeners. The fruit "is large, the size of a May Duke, bluntly heart-shaped, somewhat compressed, with a shallow depression on one side;" the skin is of a rich shining red colour, and the flesh of the same quality as a May Duke. The branches are more spreading than the May Duke's and the leaves larger; the flowers are like the May Duke's, but open later.

46. *The Early Red Margaret Apple.* An "excellent summer apple," and one of the oldest varieties; it is nearly the earliest of all the summer fruit, and "beyond comparison the best. The fruit is middle-sized, roundish oblong, rather angular, tapering to the eye," which is contracted and plaited. The stalk is short and thick, and the skin is of a greenish yellow colour, closely streaked with deep red; the flesh is "white, juicy, breaking, subacid, very rich and agreeable, without any perfume or spicy flavour." The leaves are rather large and thick, and the flowers are in large dense clusters, and of a cream colour slightly tinged with red; the wood is sprinkled with whitish spots at the lower end.

47. *The Old Pine, or Carolina Strawberry.* Of universally admitted merit and value. The leaves are of a very deep green, the footstalks long and upright, and the fruit is large, ovate-conical, of a rich bright scarlet colour, while the flesh is paler, rich, and juicy, with a grateful flavour.

48. *The Brunswick Fig.* "One of the most useful of the hardy figs," and ripens by the middle of August, trained against a south-eastern corner of a wall. The fruit is very large and fleshy, with peculiarly oblique apex. The skin is of a pale green, with a tinge of yellow; next the sun it is of a dull brownish red, with small pale brown specks. The flesh is of a pinkish hue in the interior inclining to white towards the skin, and very high flavoured; the stalk is short and thick, and the leaves are deeply five-lobed, the lobes are narrow and nearly of equal width.

*No. XIII. for November, contains*

49. *The Common Elruge Nectarine.* This is "one of the very best and most high flavoured of our nectarines; and one of those which are most generally cultivated;" it resembles the *Violette Hâtive*, and is distinguished from it by parting more freely from the stone, and by "the channel in its

side being deeper and less pitted with little excavations." The leaves are crenated, with reniform glands; the flowers very small and of a pale dull red colour; and the fruit large, roundish, and inclining to oval, the colour of the skin is a deep violet or blood colour, when exposed, with minute brownish specks, the flesh is whitish and melting, and the stone pale, middle-sized, and oval.

50. *The Summer Golden Pippin.* "One of the best of our early autumn apples, ripening in great abundance, especially on dwarf trees, upon Paradise stocks towards the end of August." It resembles externally the Old Golden Pippin, though not equal in flavour to that fruit; it is, however, a pleasant and useful variety.

51. *The Madeleine Pear.* This variety is excellent, bears freely on a standard, matures its fruit in the third week of July, and, if gathered before it is overripe, keeps for a few days. It much resembles the Citron de Sierenz, from which it chiefly differs in the wood and leaves. The wood is bright, clear, of a reddish brown colour, with a few scattered prominent pale spots; the leaves are cordate and ovate; the fruit is middle-sized, turbinate, and with a thickening on one side of the stalk which is about an inch long; the eye is slightly hollowed, and the skin of a yellowish green, with a little light bloom on it, and on specimens much exposed a slight tinge of red. The flesh is white, melting, sweet, and high flavoured.

52. *The Downton Strawberry.* A well established and excellent strawberry, an abundant bearer, and the berries possessing a highly aromatic flavour, "derived from the variety from the pollen of which it originated." It is rather late in coming into bearing, and should be fully ripened to be eaten in perfection.

This number completes the volume, to which an index is given. An advertisement states, that "it will be the duty and desire of those who have the management of the work, to make it worthy of the favourable reception it has hitherto received."

*No. XIV. (the first of Vol. II.) for December, contains*

53. *The Hoary Morning Apple.* Very handsome and useful; supposed to have originated in Somersetshire; it ripens towards the end of October, and is adapted for growing upon the Paradise stock. The fruit is rather large, round, depressed, angular, with a very close plaited eye.

54. *The President Peach.* A rich melting juicy fruit, and valuable on account of the late period of its maturity, being the end of September; it requires a south wall, and must be well ripened before being gathered. The fruit is large and approaching to oval, with a shallow suture.

55. *The Cosford Nut.* This variety is highly deserving of cultivation, bearing abundantly and having a remarkably thin shell. The nut is large and oblong; and the tree grows vigorously, and the branches upright.

56. *The Miller's Burgundy Grape.* One of the most ancient varieties, and commonly grown in France as a wine grape. It is very high flavoured, with short thick bunches, and black roundish berries, ripens at all seasons with certainty, and is the earliest of all the varieties known, except the Black July.

*No. XV. for January, 1829, contains*

57. *The Coe's Plum.* This together with the Washington are superior to any of the oldest varieties; it is a great bearer, and should be trained upon a west or east wall to insure a crop. The fruit is oval, large, and yellow; the leaves are oval and flat; and the wood is smooth and of a deep purplish brown.

58. *The Cornish Aromatic Apple.* This is a good bearer, but subject to cankers. The fruit is large and roundish, covered with a soft brownish russet on the shaded side, sprinkled with pale brown dots; the leaves are middle-sized and ovate; and the wood is of a chestnut brown colour.

59. *The Capiaumont Pear.* A most delicious fruit, ripening in the middle

of October, and bearing well as a standard: The fruit is middle-sized of a fine clear cinnamon colour, fading into yellow in the shade; the leaves are oblong and much folded; the wood is clear, of a reddish brown colour.

60. *The White Doyenné Pear*. A very old and excellent pear, with middle-sized fruit of a pale citron yellow colour, sprinkled with cinnamon; the leaves are lanceolate and folded together; and the wood is of a bright chestnut colour.

No. XVI. for February, contains

61. *The Chancellor Peach*. A capital sort. Leaves crenated with reniform glands; flowers small, reddish; fruit large, oval, with a very distinct channel on one side. The name originated in a nursery in the north of England.

62. *The Scarlet Pearmain Apple*. A valuable table fruit, ripening in September and keeping till January. Wood weak, light chestnut colour with small brown spots. Leaves taper-pointed, doubly serrated, with slender stalks, and small linear-lanceolate stipules. Fruit middle-sized, conical, of the true pearmain form (fig. 41.), known in some places as Bell's Scarlet.

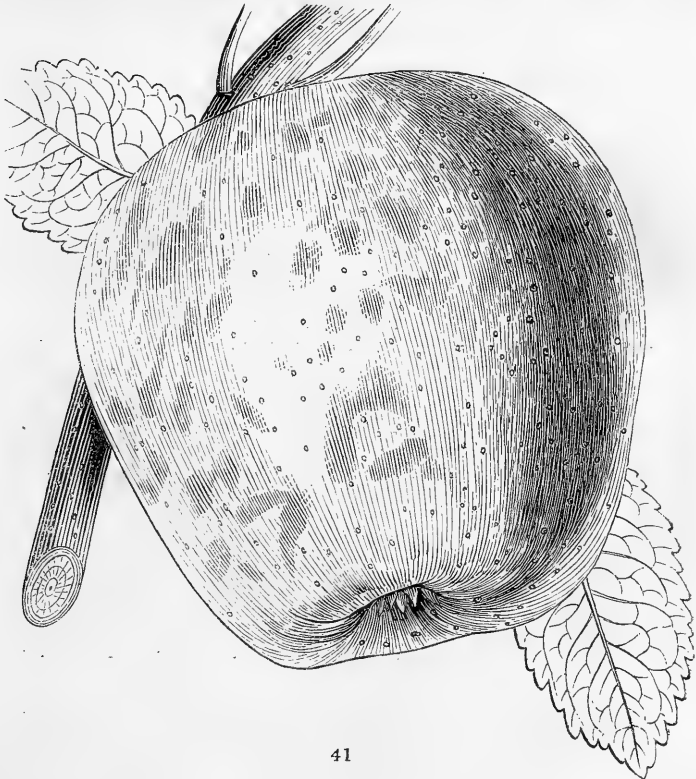

41

63. *Longville's Kernel Apple*. From Herefordshire, of considerable merit, though but little known. In perfection from the middle of August to the middle of September, and a great bearer either as a dwarf or standard. Wood slightly downy; leaves ovate-oblong; and fruit middle-sized, oval, with a firm flesh, yellow, perfumed with a rich pleasant sweet subacid juice.

64. *The Passe-Colmar Pear*. From its ripening late, bearing most abundantly either as a standard or against a wall, and possessing a peculiarly rich

and agreeable flavour, this pear has become a universal favourite, and deservedly. It was raised in Flanders by a M. Hardenpont, and passes in this country under different names, as Colmar épineux, Colmar gris, Dit Precel, Chapman's, &c. Wood fine clear yellow brown, seldom cankered; leaves small, oval, tapering to both ends; flowers middle-sized; fruit middle-sized, obconical, flattened next the eye; in season from December to February.

*Flora Médica*: containing Botanical Descriptions, Natural History, Chemical Properties and Analysis, Medical Properties and Uses, &c. &c. The number of the different Species of the Officinal Plants, comprised in the latest Editions of the London, Edinburgh, and Dublin Pharmacopœias. A List of the Indigenous Plants possessing Medicinal Properties, not included therein; a separate List of the Poisonous Plants; an Explanation of the Classes and Orders of the Sexual System of Linnæus illustrated with coloured Delineations; a copious List of Botanical Terms and Definitions; a Tabular Index, showing at one view, the Generic and Specific Name of each Plant, the Class and Order to which it belongs in the Sexual System of Linnæus, the Natural Order of Linnæus and Jussieu, its Medicinal Properties, and the Volume and Page in which the Description is given. Edited by a Member of the London College of Physicians, F.L.S., and assisted by several Members of a Botanical Society. London. 8vo. To be continued Monthly, and completed in twenty-eight Numbers. 2s. 6d. Nos. I. to XVII.

The seventeenth number of this work, now before us, contains *Rosa centifolia* and *gallica*, *Pimpinella Anisum*, *Cuminum Cyminum*, *Ulmus campestris*, and *Eugenia caryophyllata*. As we have regularly followed Stephenson and Churchill's *Medical Botany*, and selected from it all that we think interesting to gardeners and general readers, we have not thought it necessary to give detailed notices of the numbers of the present work as they have appeared. Of the merits of either, in a medical point of view, we do not profess ourselves competent to judge.

*Fleming's British Farmer's Magazine*, exclusively devoted to Agriculture and Rural Affairs. In 8vo Numbers, quarterly. 4s.

Nos. IX. and X. for November, 1828, and February, 1829.

We are happy to find this work improving, as evinced by the introduction of scientific papers, hitherto rare in works got up for the English farmer.

*On the Vegetable Economy of Agricultural Plants*. — Every practical agriculturist ought to possess a knowledge of the principles of botany, which furnish him with "a key to the simple, yet admirable, system of order, which nature has observed in all her works — instructs him in many truths which are important in the economy of a farm; and it is gratifying to learn that our intelligent farmers are beginning to perceive, and to appreciate, the real value of scientific acquirements, which will not only be a means of correcting their views of rural concerns, but will also enable them to overcome many prejudices concerning things with which they are but imperfectly acquainted."

*The Lincolnshire Agricultural Society* held a meeting on the 27th of August, and among other premiums awarded the following. "To William Jacklin (lived with J. S. Bennett, of Appleby, and his father-in-law, 23 years; had 24 children, and brought up 18): for the labourer in husbandry who shall have brought up the largest family without parochial relief, character being particularly attended to; 10 guineas. To William Sentence, of Barrowby (had 17 children, and 16 living): for the second labourer in husbandry who shall have brought up the largest family without parochial relief, character being particularly attended to; 5 guineas."

*The Derbyshire Agricultural Society*, at their meeting of October 6., gave the two following premiums: — "For the labouring husbandman, of good

moral character, who shall have creditably brought up the largest family, without parochial relief, 3 guineas, to William Wragg, aged 58, who has worked 35 years with the Rev. Joseph Ashbridge, of Heath, and brought up 10 children. Also, one guinea and a half to Christopher Marsden, aged 63, who has brought up 8 children, and worked 33 years with Mr. Wild, of Birchill."

*The Manchester and the Bedford Agricultural Societies* have, in our opinion, done better in awarding premiums for "The best cultivated farms."

*On Improving Cultivation*, by Thomas Myers, LL. D. — Dr. Myers is the Director of an institution at Dartford Hill, Blackheath, where the sons of gentlemen may pursue a regular course of studies in the subjects most essential to the landed interest. We should like to see in the *British Farmer's Magazine*, even if it should extend through several volumes, a series of papers by Dr. Myers, detailing his plan, and giving the whole course in an abridged form, or even without any abridgement. Such a series of papers would add much to the interest of the magazine, and would show the value to the sons of farmers, of scientific knowledge, and to the sons of country gentlemen, of such an institution as that of Dr. Myers.

*The Quarterly Journal of Agriculture; and the Prize Essays and Transactions of the Highland Society of Scotland.* Edinburgh. In 8vo Numbers, quarterly. 5s. 6d. Nos. I. II. III. and IV.

The farmers of Scotland, though unquestionably the first in the world, have hitherto been more remarkable for practical skill than for scientific knowledge. The papers in the *Farmer's Magazine*, which commenced with the current century, and terminated in 1825, with the 26th volume, attest the truth of this assertion. The principles of political economy were evidently much better understood by many of the writers in the magazine alluded to, than those of natural history, animal or vegetable physiology, or chemistry. The *Quarterly Journal of Agriculture* aims at a more scientific character, and will only succeed by maintaining this character; not only because the former magazine was felt to be rather unvaried in its subjects, but because a new class of readers has arisen, moulded in some degree by the progress of the age. The contents of the four numbers of this new agricultural journal, exhibit a judicious assortment of scientific papers on the sciences on which agriculture is founded, blended with others of a practical nature on various departments of rural improvement, and we shall now look them over, and give the essence of what we think of most value to gardeners.

The editor, Mr. Macvicar, has commenced a series of papers on *Natural Science as applied to Agriculture*, which sufficiently prove him to be a scientific man. The grown up market-going farmer, of 50 harvests, will pay little attention to these papers; but they will be read by his sons, and even by his daughters; and in both they will create and nourish a taste for observation, and for entering into the minutæ of nature's processes, on which all the more grand and obvious operations of agriculture depend. Agriculture, Mr. Macvicar observes, is no less a subject for theory than navigation or mechanics; astronomy supplies the principles of the former, and mathematics of the latter. "The science of agriculture, compared with that of most other arts, is still very far behind. But this is scarcely to be wondered at, when we reflect that the slowness of its processes renders observation more difficult; that chemistry, on which it partly depends, is not of many years' standing; and our knowledge of the vegetable, and even the animal, economy only in its infancy." He begins his series of papers with a general view of the vegetable economy, both "because of its primary importance, and because it presupposes a knowledge of the other branches of natural science less, perhaps, than any other which will fall afterwards to be discussed." The seed, the flower and fruit, the structure of a plant, the root, and the



stem and branches, are treated of and illustrated by wood engravings in the first three numbers; and No. IV. commences Agricultural Chemistry, with an essay

*On the Atmosphere.*—A very excellent paper. The heat of the air is chiefly, if not altogether, produced by the rays of the sun; and the temperature of a place depending on the quantity of sunbeams alighting upon it, the temperature of the earth at different places, must be very different, because it is not a flat surface facing the sun, but a globe. Other circumstances being the same, the heat produced is at a maximum, when the sun's rays fall perpendicularly on the surface to be heated. For this reason the equator is warmer than the poles, the face of a hill than its back, and a southern slope than a northern slope. But there are other causes which affect the temperature of a place; the denseness of the atmosphere over it, the condition of the surface, and the character of the neighbouring countries or seas. "If there be much marshy ground, wet land, or any condition of surface calculated to charge the air with damp, the air will be comparatively cold; because, much damp in the air lightens it, and light air is with difficulty heated. Water itself, too, whether in a liquid state or as a vapour, is extremely difficult to be heated; and therefore both circumstances combine to make wet lands cold lands. It is very interesting to observe how beautifully the laws of nature operate to keep down such a state of things, and how kindly they combine with the husbandman, rendering his labours to ameliorate the soil a means of ameliorating the climate also. That there shall not be much air cold and very damp at the same time, is provided for by the law, that the power of air to contain damp diminishes as its temperature falls. And that the climate shall be improved by improving the condition of the soil, and the improvement of the soil, once effected, be for ever kept up, is provided for by the same law. For, when the surface has been drained, and the water run off to the sea, or gathered together in deep pools, which present but a small surface compared with a field, and from which, of course, a comparatively small evaporation can take place, then the average temperature of the place rises, and its average power of taking up damp increases; so that though the same quantity of rain should fall in the course of the year as before improvement, still the air will take it all up, and keep the soil in good condition. Instead, then, of ascribing the foulness of our pastures—the lateness and poorness of our crops—the stiffness of our land—the miriness about the farm-yard—the wetness of the land—the coughs and consumptions of the family, to the quantity of rain that falls, let the ground be effectually drained, and the heart of the air will be warmed towards the farmer. Rain will be sent in due quantity to refresh the fields, but it will no longer be left in the furrows. The warm air will suck it up as soon as could be wished. Without draining off the superfluous water, it may be safely stated, that an elevation in the temperature of the air would be productive of the most fatal consequences."

*On Emigration*, by the Rev. Dr. Chalmers.—The author follows the line of argument given in our review of Slaney (Vols. I. and II.), clearly proving that the rate of population in any country will depend on the standard of enjoyment in the lowest class of society, and that the schemes for relieving the country, by transporting our surplus families to distant lands, is "one of singular impotency and inaptitude," because it has no relation whatever to the cause of the evil. "When the standard of enjoyment is low, as in Ireland, the tendency to increase in population must be great. When the standard is higher, as in Scotland, marriages are later, and the land is less overburdened with the weight of redundant families. . . . Malthus's wisest remarks are to be found in his chapter on the Checks to Population in Norway, where he alleges that the very want of many and distinct resources has given such energy to the moral preventive check, as to have blessed that country, in spite of its barrenness, with the most comfortable peasantry in

Europe." The only checks likely to be effectual in England are general education enforced by law, doing away the application of the poor rate to able-bodied labourers, and a positive prevention of marriage in both sexes of the lowest class till a certain age, or till the concurrence of certain circumstances.

*On Mixtures in the Air which occasion Disease and Death in Plants.*— M. Marcet proved by experiment that plants were poisoned by water holding oxide of arsenic in solution, and by a few grains of arsenic introduced in a cut. Opium, hemlock, foxglove, and oxalic acid, absorbed by plants, also killed them. D. Martin, Esq., found cast-iron tallies poisoned the soil about the roots of his pinks and carnations; and the trees and plants in the towns of Britain, where the atmosphere is more or less impregnated with coal smoke, are never so green and luxuriant as those in the country, or those in the towns on the Continent where wood is used as fuel. The sulphurous acid gas is exceedingly deleterious to vegetables, even when there is so small a quantity in the atmosphere, as to be hardly or not at all discoverable by the smell. "In opening up to the agriculturist these sources of death and disease to vegetation, do we not enable him to look upon his soils and his crops with an enlightened eye?"

*Remarks upon a supposed Law of Vegetable Life, limiting the Duration of Plants obtained by Cuttings to the Natural Term of Life of the Stock whence they were taken.* By the Rev. Dr. Fleming, of Flisk.— This is a most valuable paper. When Marshal, in his *Rural Economy of Gloucestershire*, remarked that "engrafted fruits are not permanent, they continue but for a time," he probably did not anticipate that he was announcing a conjecture destined to become an article of faith, under different forms, among intelligent agricultural and horticultural writers. Mr. Knight embraced the opinion of Marshal, and, in his *Treatise on the Culture of the Apple and Pear*, gave it as his opinion, that "the continuance of every variety appears to be confined to a certain period, during the early part of which only it can be propagated with advantage to the planter." Mr. Bucknall expresses himself more plainly on the subject, in the *Transactions of the Society for the Encouragement of Arts*. "When the first stock shall, by mere dint of old age, fall into actual decay, a nihility of vegetation, the descendants, however young, or in whatever situation they may be, will gradually decline; and from that time it would become imprudent, in point of profit, to attempt propagating that variety from any of them." There was now only wanting the authority of a botanist, to give sanction to the opinion, that plants obtained by cuttings did not possess an *individual vitality*, but were merely dependent extensions, sympathising with the frailties of the stock from which they were taken, and incapable of outliving its dissolution. Sir James Edward Smith, the late lamented President of the Linnean Society, considered it as established, that "propagation by seeds is the only true reproduction of plants." With such authorities, this supposed law of vegetable life was eagerly and generally acquiesced in, and considered as accounting for the decay of certain productions of the orchard, the garden, and the fields.

Dr. Fleming refuted the opinion in his *Philosophy of Zoology* (vol. i. p. 426.), published some years ago, and here adds a few additional facts. These are, that cuttings from the scarlet lychnis and wallflower may be prolonged, as plants, for an unlimited length of time; that the leaf of a potato may be made to outlive the stem; that oats and beans were kept alive by him for four years, by preventing them from producing flowering stems; that the osier, gooseberry, poplar, &c., have been propagated by extension for ages, and that the plants still perform their respective functions; in short, as we have already shown (Vol. II. p. 411.), that a bud, which ever way made to throw out leaves and roots, is essentially as good as a seed.

*Burning Lime.* — Mr. Wallace, of Wigton, has shown that when coals are scarce, lime may be burnt with wood or peat placed in layers in a conical form, covered with clay, and of 5 or 6 yards in diameter, with a funnel of dry furze and peat in the centre, of 2 ft. in diameter. The pile is set fire to by the top of this funnel, which will burn down to the bottom and set the whole into combustion.

*Nitre as Manure.* — Thomas Bruce, Esq., of Grangemuir, applied nitre to "wheat after a crop of potatoes, upon a strong loam; and to grass, intended for hay, upon a stiff clay. Upon both, the effect has been wonderful." The nitre was obtained from Messrs. Forman and Haddow, 51. Lime Street, London. William Hawkins, Esq., of Hitchin, Herts, gives the experience of twelve of his neighbours of this salt. They all agree that it should be sown in damp weather, that it improves chalky soils, and that its effects are particularly striking on the pasture grasses and on clover. It was first used in the neighbourhood of Hitchin, about fifteen years ago, at the suggestion of an ingenious gentleman, Mr. Bessanier. From 1 to 2 cwt. is sown per acre in March or April. One gentleman has used it fifteen, another twelve, another ten, another six years, &c. We hope some gardeners will try it with culinary crops.

*Of Plants cultivated for their Roots.* — This is a most complete detail of the ridgelet system of cultivating turnips, admirably illustrated by wood-cuts. The only thing which surprises us in it is how a writer, apparently so well acquainted with the subject, should state that the turnip "as is well known, was first cultivated in rows on the great scale in Norfolk, to which circumstance this celebrated county owes the distinguishing character of its agriculture." Every Scotchman who has been in Norfolk knows that turnips are not even now cultivated on the ridgelet, or even the drill, system there except at Mr. Coke's and a few other places. (See *Encyc. of Agr.*, p. 1118.)

*On a remarkable Law of Vegetable Life, and its Influence on several Operations in Horticulture and Agriculture.* By the Rev. Dr. Fleming, of Flisk. — In the animal kingdom abundance of nutriment accelerates the period of puberty; but in the vegetable kingdom it is, or appears to be, the reverse, and the scantier the supply of nourishment the sooner will the plant produce blossoms. Old and consequently more or less injured seeds produce plants, which, being scantily supplied with nourishment from the cotyledons, sooner produce flowers, than plants from fresh seeds, the cotyledons of which are in greater vigour. Hence the custom of carrying melon seeds in the breeches pocket, like most other customs that have stood the test of ages, is founded in utility. But while plants, the object of cultivating which is speedily to produce fruit, should mostly be raised from old seeds, those where the leaf or root are the object, should be raised from young seeds, *e. g.* turnips, carrots, cabbages. The same law will hold as to cuttings whether of herbaceous or ligneous shoots, tubers, or other roots. Grafting a rapid-growing tree or plant upon a slow-growing stock, transplanting them from a rich to a poor soil, from a wet to a dry soil, or, after keeping a plant for a long time very moist, suddenly keeping it very dry, will have the same effect. An error has crept into a part of this valuable paper, which we are rather surprised at. It is stated (p. 293.) that the ascent of the sap is indirectly diminished, by having portions of the bark removed by the knife, or wires twisted round the stem or the branches. The sap, it is well known, ascends by the wood, and descends by the bark, and the effect of twisting wires round the stem is to obstruct its descent, and if this be done in old trees at any time, or in young trees at or after midsummer, the tree not having strength, or time to employ the sap in forming leaf buds, employs it in turning the leaf buds already formed in embryo into flower blossoms. It may be said, therefore, that in such cases it is not the want of nourishment which throws a plant into a fruiting state, but the direction of the nourish-

ment to one part of the plant instead of to the whole; to the parts above ground to the exclusion of the parts under it. Hence it is that by ringing or wiring plants on rich soils, the same effects are produced as if they grew on poor ones. "Though plants differ from animals, in reference to this singular law, which we have here ventured to establish from an extensive induction of particulars, they agree, in other respects, in the influence which an abundant supply of nourishment exercises in the increase of the number and size of the progeny."

*On the Insect which attacks the Ear of Wheat.* — This is a beautiful paper, evidently by the editor. "Every one knows that there are beasts and birds of prey, which man, generally speaking, hates very much, because of his own innocent nature, and because he considers them as destructive. He calls them vermin,—a name which is meant to imply something mean or bad. But the truth is, that the reason why he destroys them, and calls them vermin, is just because he cannot eat them. If foxes were as good as turkeys, and ravens as delicate as lambs, the fox, with all his cunning, instead of being called vermin, would be called venison, and the croak of the raven would be no longer regarded as a funeral note which it learned at the time of the deluge. All our views of creation are tinged and distorted by our regarding it only in relation to our own artificial and often vitiated demands. No doubt ours is a very noble species, compared with others on the earth, but it is extremely insignificant considered in relation to the universe; and to suppose that all nature is conformed to our convenience alone is too much. We have a goodly share of the riches of the treasury of Providence, but we must not perplex ourselves by supposing that every arrangement in creation is made exclusively for ourselves. A material creation probably exists chiefly for the contemplation and accommodation which it affords to intelligent and sentient beings; but as to ourselves, especially when we consider our terrestrial circumstances, we ought to be very humble, and observe the glorious creation around us as it is, and not try to twist every thing into our own convenience, or stand perplexed as to the goodness of the Deity, when we discover some arrangement which does not appear to minister to our happiness." The means which Nature employs to restrain the diminutive wheat-ear fly within due bounds, are the very same as she employs to keep within bounds whales of 60 ft. long, viz. providing other species to prey upon them. The law of mutual destruction pervades the whole animal, and is found in the vegetable, creation. There are three other flies which seem to depend upon the wheat flies for their subsistence. One of these, the *Tripula*, or *Cecidomyia, tritici* (fig. 42. a), hovers around the ear in the evening; while another very minute fly, the *Ichneumon insèrens* (b), is found round the ear all the day. These last flies appear of great self-denial and curious fancy; for they only lay an egg beside an egg of the wheat fly, which is hatched along with it, devours it, and saves the wheat. The most abundant species of these ichneumons, or flies of prey, "positively lays its egg in the very body of the yellow maggot, while it is feeding busily. It has a long hollow rod, projected at pleasure from its tail, which it thrusts into the body of the worm, and down which it then sends one egg from its body, which egg is hatched within the body of the maggot, and consumes it."

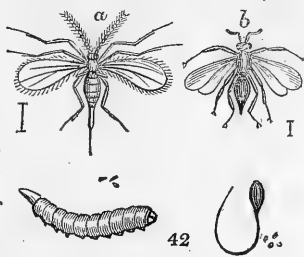

*Soil poisoned by Coal.* — A Northumberland farmer finds a soil which had been injured by coal, a seam being near the surface, and the land undermined for it, restored to its fertility by quicklime, at the rate of from 20 to 30 loads per acre.

*On the Value of Agricultural Societies.*—The writer says that “they have been the means of diffusing much knowledge, and of calling forth the practical application of much that existed. They have been instrumental in generating a kindlier and more confidential feeling between landlord and tenant. They have raised his general standard in the management of a farm, by bestowing due honour and commendation on the active, industrious, economical, and neat-handed farmer. They have been the means of introducing better stock, better seed, better implements of husbandry, and better modes of culture. And they have contributed not a little to rub off that rusticity which might leave us fit for a market or farm, or for bearing a prominently ridiculous place in the picture of ‘The Rent Day;’ but which completely unfitted us for general society.” Their decay he attributes to the depressed state of agriculture during the last thirteen years, and he calls on the editor to use his exertions to revive them, because “we are, of all men, most in danger of getting into a lifeless, unprofitable routine in the management of our work; and of adopting (unless we are affronted out of it by the example of our neighbours) Mrs. Macclarty’s excuse for all our slovenliness,—“It will just do well enough.”

*A few Hints on ornamenting with suitable Plants the Grounds about a Country Residence.* By Mr. Steuart Menteth, younger, of Closeburn.—Mr. Menteth humanely directs attention to the ornamenting of cottages by evergreens and creepers, and the planting not only of fruit trees, but of flowering shrubs in their gardens. “From such improvements in their gardens, it may reasonably be expected that the inmates of the cottages would gain not a little in point of taste and good feeling; order and cleanliness would supplant disorder and filthiness; and, above all, if the cottage child, during his hours of leisure and relaxation, were trained to look after, and take an interest in, a few flowers and evergreens, he would, from such salutary and healthful occupations, form a kind attachment to the vegetable kingdom, and, instead of wantonly impairing, cutting, or destroying the trees, of which we have so many disgraceful proofs, he would feel a disinclination to offer them any injury.

“The mutilating of statues, even in our churchyards; the destruction of the cope-stones of walls and bridges, and of the very milestones on our public highways, are instances of wanton mischief, which we believe to be more often seen in Scotland than elsewhere, and it is a disgrace to the most enlightened and virtuous peasantry in the world. Means ought to be employed to counteract this tendency, and that which we have suggested may not be altogether devoid of use in this respect.”

Mr. Menteth thinks with many people, and, we believe, with most of his countrymen, that the laborious classes of Scotland, are the “most enlightened and virtuous in the world,” and we thought so too, till we had been in Wurtemberg and Baden. He adds, “it is well known how much a regard for the lower animals is cherished in youth, by having some favourite to look after and fondle, and how indifferent to the brute creation, and how reckless of human life, those are who have never been accustomed to take an interest in it. On the same principle, those who have been brought up in heaths and districts bare of wood, are generally observed to do the most wanton mischief to trees. With a view to such objects, it might be advisable to attach to every parochial school, indeed to all schools, a small plot of garden-ground, ornamented with flowers, evergreens, and most of the plants used for domestic purposes. Such a garden, but upon a larger scale than would be adopted in ordinary schools, is to be seen at the Academy of Dollan, to which the youth have constant access. It should also be made a part of the master’s duty, to direct the attention of his scholars to the plants of the garden,—to teach them their history,—describe their uses, and point out their culture. All this might be easily done, as any master could soon learn all that is useful to know of such

plants, and take pleasure in communicating this knowledge to his youthful charge; and it might be so conducted as to cause little or no interruption to the other laborious exercises of the school. The instruction given as a recreation in the play hours, would not be the least valuable, as knowledge is always more readily acquired by the young, when it is possible to combine pleasure with mental exertion. As the parochial clergy are now so attentive to this taste for adorning their own dwellings, they would no doubt readily take an interest in such a plan, and encourage the love of it in the schoolmaster and his pupils. Such gardens, small in extent, might be laid out at little expense. They should be kept in order by the master, with the assistance of his scholars, who would soon take much interest and delight in such occupations. Any trifling expense the proprietor might be at in ornamenting these small gardens around the parochial schoolhouse, would be principally repaid in the security of his woods from the mischievous schoolboy's knife." We entirely concur with him, and it is singular that he should have hit upon what has been already done in Bavaria. We may add that for cherishing a regard for the lower animals, and humanising youth generally, few pursuits are more effectual than that of natural history, and with this view we hope to live to see much real good done to the rising generation by our Magazine of Natural History. At Rouen, Paris, Strasburg, Frankfort, Carlsruhe, Nuremberg, and other towns in France and Germany, the public squares, which, unlike those in Britain, are open to every body, and are unprotected by iron railings or fences of any kind, are stocked with the finest American trees and shrubs, magnolias, rhododendrons, azaleas, &c., and with the rarest flowers of the country, which bud, leaf, flower, and fruit untouched by the populace. Such is the humanised state of the laborious classes in these countries; very different indeed from what it is either in Scotland or England, but not from what it might and will be.

*On the Propagation of genuine Agricultural Seeds.* By Mr. Shirreff of Mungoswells, East Lothian. — A very important paper. The propagation of vegetables exceeds that of animals in importance, because the vegetable produce of the country surpasses that of animals, and because our most valuable domestic animals live on vegetables. Selection is the principle for procuring abundance of genuine seeds, and the process even with the different sorts of corn is not, as might be supposed, tedious. In 1823, Mr. Shirreff marked a vigorous wheat plant, near the centre of a field, which produced him 2473 grains. These were dibbled in the autumn of the same year, the produce sown broadcast the second and third years, and the fourth harvest produced 40 quarters of sound grain. A fine purple-topped Swedish turnip produced 100,296 grains, which was seed enough for five imperial acres; and thus, in three years, one turnip would produce seed enough for Great Britain for a year.

*On the Plough.* — A geometrical demonstration of its construction and action, and, as far as we can judge, the best essay that has appeared on the subject, since the time of Small.

*On the Agriculture of Ireland.* By Edward Johnston, Esq. M.R. I.A. &c. — Absenteeism, middlemen, "absence of tranquillity and of personal security" (an objection now, we trust, removed), want of capital, the great bulk of the tilled land in farms of from 15 to 50 acres, "indolence and slow, slovenly, dawdling habits of working," and general ignorance of agriculture, are the evils to be overcome.

*On Maize or Indian Corn,* which not ripening its seeds in the neighbourhood of London till the middle or end of November, can never come generally into culture in England; but that it may be worth culture, in favourable situations, for feeding poultry is probable.

*The Miscellaneous Notices* are various; one of the most valuable is the following from the *Bulletin des Sciences Agricoles*, which we extract, because

though we do not think it necessary that gardeners should possess the practical knowledge of farmers, we should wish them to be masters of the science of agriculture. "The male parent is the preserver and creator of a race. The first changes in crossing are always exhibited in those parts that possess the power of being reproduced, as the hair, horns, hooves, &c. The fleshy parts change slowly, in proportion as the mother has much of the blood of the original race. The first changes take place in the head, and are gradually developed towards the hinder quarters of the animal. To produce a new race, as many generations are necessary, as years are for perfecting their teeth."

In the body of the work an extract is given from the *Annales de l'Agriculture Française*, the object of which is to show that in breeding a greater number of one sex than of the other, may be obtained at the option of the breeder. The principle is, when most males are wanted, strengthen the power of the male parents relatively to the strength of the females; and when most females are wanted the contrary. The application to a flock of sheep is thus given. The farmer wishing a greater number of female lambs, is recommended to put very young rams to the ewes; and also, that during the season that the rams are with the ewes, the ewes should have more abundant pasture than the rams. When male lambs are chiefly to be obtained, strong and vigorous rams four or five years old are to be put to the ewes.

The Prize Essays and Transactions of the Highland Society of Scotland, form a separate part of each number, and we shall defer their examination for the present.

We have passed unnoticed several valuable essays, among the original communications, but have done enough to show that this is one of the first agricultural journals in Europe. Our opinion is, that it is the very first; being in fact what the present state of science and taste for reading among the more intellectual agriculturists, might have been expected to call forth. We would recommend it to Farmer John Bull, but it would be of no use, for he has already got his *Weekly Farmer's Journal*, which is to the *Quarterly Journal* what the agriculture of Hertfordshire or Essex, or any of the midland counties, is to that of East Lothian, Berwickshire, or Northumberland. We have recommended it, however, to several distinguished individuals and societies in France and Germany, and we hope, for the credit of the young and reading agriculturists of Britain, that they will profit according to the opportunity offered to them by this work.

One fault in the arrangement of the articles in this journal needs only to be pointed out to the editor. The articles are mixed, probably by chance, or possibly with the idea of giving variety. Mixture, however, is not variety. No two articles or objects of any kind, composing part of a whole series, ought to be placed together without a particular reason. A connected series or train of ideas, ought to be excited in the mind, even in looking over the contents of a book. In No. IV. for example, instead of the arrangement given, we should have placed the articles thus; I. II. XI. IV. V. X. VII. IX. XIII. III. XII. VI. VIII. and XIV. At present they put us in mind of Regent Street; a great many good parts, but not a good whole.

*M'Intosh, Charles, C.M.H.S.*, late Gardener to the Right Honourable the Earl of Breadalbane, and Sir Thomas Baring, Bart. M.P. &c. &c.: the Practical Gardener and Modern Horticulturist; containing the latest and most approved Methods for the Management of the Kitchen, Fruit, and Flower Garden, the Green-house, Hot-house, &c. &c., for every Month in the Year; each Department being distinctly and separately arranged; illustrated by numerous Designs of the most eligible Plans for the Formation of Kitchen and Pleasure Gardens, the Erection of Hot-houses, Hot-beds, Green-houses, Conservatories, Walls, Fences, &c. &c., including the new Method of heating Forcing-houses with Hot-water

only; forming a complete System of modern Practice, in the various Branches of Horticultural Science. Embellished with highly finished Engravings of some of the most choice and valuable Fruits and Flowers now cultivated in this Country. London. 8vo. Parts I. to VI. 2s. 6d. each. One col. pl. and one plain pl. to each Part.

Mr. Charles M'Intosh is well known among gardeners as a good practical botanist, a skilful cultivator, and of considerable taste in laying out grounds. He has had a good deal of experience in the different departments of his profession, as the additions to his name imply, both in England and Scotland, and therefore we may fairly expect from him a book suitable to the present state of horticultural science. We do not think his publishers have shown as much judgment in bringing out the work, as Mr. M'Intosh has shown in writing it. Coloured plates of well-known fruits and flowers, and an engraved titlepage, are of no sort of use to the practical gardener, and a work of the present description does not require ornament. The copperplate engravings of hot-houses, of which there is one to each number, would have been just as well in wood, as far as utility is concerned, and the work might have been afforded cheaper. So much for the book-making part of this publication; we shall now look over it and note any thing not to be found in this Magazine or in our *Encyclopædia*, or otherwise deserving of remark. The work seems to be divided into four parts, the culinary, fruit, forcing, and flower garden.

*The Culinary Garden.* — After a very well written introduction, Chap. I. treats of the formation of the kitchen-garden. Natural situations are better than artificial ones, and much more economical. Too low and too high situations are equally to be avoided. W. Atkinson, Esq., of Grove End, architect, builds garden walls hollow, and introduces, within a few inches of the bottom of the vacuity, hot-water pipes, supplied from boilers heated according to the method lately introduced or revived. "The distribution of heat by this mode is so equal, that the pipes will be found as warm 50 or 60 ft. from the boiler, as they are where they are connected with it. This is never the case with smoke flues, from which arise the many complaints, that hot walls are burnt up in one part, and little affected by the heat in others." Of sunk walls, like those of ha-ha's, it is observed, "we once had a sufficient proof of their superiority as far as regarded early crops." [We should say, build them hollow, in order to preserve the surface dry.] Flint walls are good; "the first wall-fruits brought to Winchester market are from trees planted on the ruins of the old city walls, which are chiefly composed of flints. . . . One of the most complete, as well as the most capacious, reservoirs of water for a kitchen-garden, has been lately formed by Mr. Forrest, at Syon House, the Duke of Northumberland's, and is constructed entirely of iron." Water may be procured by boring, in many instances, as at the Manor House in the New Forest, &c.

Chap. II. treats of the Nature and Management of Soils, Chap. III. of Manures, Chap. IV. of Draining, Chap. V. of the Systematic Alternation of Crops, on which last subject the following alternation is given:—

1. Broccoli, cabbage, cauliflower, and savoy.
2. Common beans, French beans, and peas.
3. Carrots, beets, and parsneps.
4. Turnips, early potatoes, onions, leeks, eschalots, &c.
5. Celery, endive, lettuce, &c. &c.

"It is found in practice, that celery constitutes an excellent preparation for asparagus, onions, and cauliflowers.

"Turnips or potatoes are a good preparation for cabbages or greens.

"Broccoli or cabbages are a good preparation for beans or peas.

"Cauliflowers prepare well for onions, leeks, or turnips.



" Old asparagus land affords a good preparation for potatoes or carrots.

" The strawberry, currant, gooseberry, and raspberry, for the same.

" Turnips give a suitable preparation for celery or endive ; and peas, when well manured, are a good preparation for spinach, &c." (p. 62.)

The remaining portion of the kitchen-garden consists of a calendar. The following ought to be impressed on the mind of every gardener : — In bad weather, cut, paint, and number labels of all sorts, and lay them up so as to be conveniently at hand when wanted. Where there are many drains in or about a garden, a plan of them should be kept in the gardener's office, and all alterations or additions carefully introduced, so as to admit of easy examination, repair, or renewal. " We would here recommend, as a rule adopted by ourselves during the whole course of our practice, to give an inventory of all seeds, tools, &c., connected with the culinary garden, into the hands of the kitchen-garden foreman, or under-gardener, and that he give to each of his men the proper tools for the particular employment allotted to him, and make every man responsible for them. Each gardener should have a full set of tools ; he should consider them his property while he is in the employment, and when one is broken or worn out, by reporting it to his foreman, he must be supplied with another. A tool-house is an appendage attached to almost every garden, from the nobleman's to the tradesman's villa ; but it is, generally speaking, a name only, and more often filled with useless lumber than implements of horticulture. Nothing shows the want of regularity and system, and consequently bad management, more than to see a spade lying in one place, a rake in another, and a wheelbarrow in a third. We would recommend that every operative be compelled, on quitting his work, to carry such of his tools as he may have been using into the tool-house, where they should be properly cleaned, and either placed upright, or hung upon nails, according to their respective kinds ; and this house should be regularly locked by the foreman, and opened by him in the morning. A system of regularity of this sort will prevent altercation, and in a short time will cease to be unpleasant to the men ; they will perform it as mechanically as they do most of their other duties. At this season the store-house should be examined ; all bulbs, onions, and roots carefully looked over, and those in a state of decay removed, to prevent contamination. Every attention should be paid to such things as are liable to be injured by frost, in order that they may be protected in time, for, if deferred too long, an irreparable loss may be the consequence. Where there is much wheeling to do, this is the proper season to perform it, as during frost the men will do more at this work than they can accomplish when the walks and ground are soft. Leaves should be collected in the woods for the purpose of undergoing fermentation, either for accelerating crops or fruits, or if not wanted for such purposes, they should be gathered in heaps to rot into vegetable mould, which will always be useful in the kitchen-garden, and in the other gardens it is actually indispensable." (p. 82.)

It is the sudden transition from cold to heat, or of sunshine after severe frosts, which destroys our early crops, and hence it is that lettuces planted on the north slope of an east and west ridge are often saved, when those on the south side are destroyed. Instead of ridges, cones may be tried, and the chances of safety will be materially increased.

*March.* Dandelion is an excellent salad, and a good stomachic. Where it abounds as a weed, cover it at this season with rotten tan, or decayed leaves, it will soon come up and be well blanched, and form a great addition to spring salad. It will also force well all the winter, on a slight hot-bed, or in a warm cellar.

*April.* Birds may be scared from seeds of the *Brássica* tribe by suspending a potato, stuck full of feathers of different colours, from an elastic hazel

rod, stuck in the ground at an angle of 45°. "It was first observed, by a friend of mine, in the gardens of the late A. Bacon, Esq., of Elcot, in Berkshire."

*June.* Where watering is necessary, let it be done from four to six in the morning, and let the men for this extra-labour be allowed extra-wages; or, if it be preferred, let them rest in the middle of the day. In large gardens use a small fire-engine, worked by three or four labourers, the dispersing pipe being directed by a gardener.

*July.* We have never found a more effectual method of destroying slugs than hand-picking very early in the morning. Powder of lime soon loses its alkaliescent properties when laid on the damp ground, and lime-water is attended with more trouble and less success than hand-picking.

*The Fruit-Garden.*—Mr. M'Intosh, it would appear, is a believer in the erroneous doctrine of Marshall and Knight, so ably exposed by Dr. Fleming (*supra*, p. 175.). "The necessity of renewing fruit trees by seed, for the purpose of either renewing the identical sort, or endeavouring to procure a new or a better one, is obvious; as the various methods of propagation by grafting are, in no instance, a renewal of the sort, or, in other words, making a new or young tree, for the case is wholly different. Every tree so propagated is no more than a prolongation of a part of the parent tree, by being amputated and made fast to another root by means of grafting. There is no such thing as a new or young tree, excepting those which are really raised from seed. Every Ribston Pippin in the kingdom, propagated by any other means than by seed, is no other than a part, a wing or a branch, of the original Ribston discovered at Ribston Hall, in Yorkshire; and such trees, it is supposed, do not only inherit the properties of the parent in size, shape, and flavour, but they also inherit all the train of diseases with which the original was affected. Mr. Knight and others have discovered this in the Herefordshire orchards."

*Hot walls.* The general prejudice against hot walls is, we hope, exploded; for, if they be heated by hot water, they will give an equable temperature, the want of which has hitherto been their greatest defect; the part of the wall opposite the furnace being overheated, while the most remote parts were not heated at all.

Shortening the roots is a much better mode of rendering luxuriant trees fruitful than ringing or wiring. "But when barrenness proceeds from an insufficiency of nutriment, which is also often the case, and which is easily seen by the trees getting into a stunted state, making little or no wood, and the little that is made small and sickly, then taking up and planting again, as advised above, is the only cure; and this system, while it induces fertility, produces first the principal cause of that fertility, by renewing the health of the tree, and supplying it with proper food."

"*The Duration of Strawberry-beds* depends on a variety of circumstances: sometimes they will last for ten, twelve, or more years, and often only for two or three crops; and some cultivators only allow them to remain on the ground one year. The Rev. Thomas Garnier, of Stoke, near Southampton, a successful cultivator of this fruit, destroys all his beds early in August, as soon as the gatherings are over, and then proceeds to form new ones, by trenching and manuring them. He selects his plants from the strongest runners of the old rejected plants. If the weather should be particularly hot, and the surface of the ground much parched, he defers the operation of preparing and planting his beds till the ground be moistened with rain. Such is the simple mode of treatment which he has adopted for several successive years; and such is his success, that he produces a greater quantity of excellent fruit on a given piece of ground than any other gardener in the country. Depth of soil, he observes, is absolutely necessary; and, in his opinion, it is needless to plant many of the better kinds of strawberries where it is not of a con-

siderable depth. In this we perfectly agree with Mr. Garnier, and must observe, that the finest and greatest crops of this fruit that we ever saw were in his garden. It is not generally known, but it is an ascertained fact, that most strawberries generate roots, and strike them into the ground nearly 2 ft. deep, in the course of the season. The pine, Grove End, and rose-berry succeed better than any other in stiff and shallow soils, and should be planted in an open situation, and not in one too much shaded.

“ Strawberries require a larger portion of water than almost any other of our cultivated fruits, to bring their crops to perfection.

“ *Strawberries may be secured from the attacks of Birds* by surrounding the compartment where they are grown with wattled hurdles, made close on purpose, or rendered so by drawing in a few branches in the places at which birds might penetrate; placing them upright like a fold, and then covering the whole top surface with netting, supported high enough to admit of getting conveniently to gather the fruit.

“ *The Fruit of Alpine Strawberries, and probably some of the prolific sorts, may be retarded* till late in the season, by going over the plants in May, or when they come into blossom, and carefully cutting off all the bloom with a pair of scissors, preserving the leaves as much from injury as possible. This is repeated until towards the middle of June, when more blossoms appear; and those are left to produce fruit, which they readily do until destroyed by the autumnal frosts.

“ *The Operation of watering before Sunrise, in counteracting the Frost,* seems to produce its effects in a manner similar to the application of cold water to a frozen joint or limb, which is injured by the sudden application of warmth. This plan has been long adopted by the London nurserymen, when their plants have been affected by frost during the night, and is attended with the most marked success. Vegetables of any sort may be recovered by this application, and it should be attended to by the gardener both in spring and autumn.”

*Keeping Fruit.* Mr. M'Intosh approves of sweating kitchen fruit, to get rid of a part of their moisture. The practice “ is probably no detriment to the fruit, and must certainly contribute to its keeping.” Table fruit “ we keep in strong boxes filled with dry sharp sand, in which the fruit is packed and secured in a dry room, and as much excluded from the air as possible. By this means, the better keeping apples and pears will keep till April and May, and some will keep till June. However, it is probable that fruits packed in charcoal, or very dry bog-mould, may keep much longer.”

*December.* “ This may be called the dead time of the year. However, neatness and regularity should ever be before the eyes of the gardener who wishes to excel. In this month, when the weather will permit, all spare ground in the fruit-garden which is not under crop should be trenched, where the roots of the trees will admit of it; and where not, it should be rough dug. Pruning of every tree should be forwarded with all diligence; and where grounds or borders are in want of renewing, preparatory to being new planted, that work should be gone on with. The clearing of fruit trees of moss and insects, as far as the latter can be effected, should occupy a share of his attention. In the compost-yard much is to be done in turning over compost heaps, and in bringing in fresh matter for forming others; indeed, this is one of the most useful employments of the gardener in winter, and one that is more neglected than any other. Wherever alterations are going on, on the manor, in the park, or by the sides of turnpike or other roads, the gardener is most likely to find materials which will be either in their natural state highly useful to him for his fruit-tree borders, or by preparations, by adding manure or other materials, to correct the lightness or stiffness of such matter to a proper texture, to be afterwards allowed to prepare for a year, and during that time frequently turned over and well incorporated. Such preparations are of all the most useful for producing fine fruit and healthy trees, and should be collected in quantities,

according to the size and circumstances of the place. In all places the gardener should be allowed a horse or two, for the sole use of the garden. By such regulation, much will be done that otherwise would be left undone; and no employment can be of so much consequence as the collection of materials for compounds; and this cannot be done if the means be not allowed him."

*The Forcing-Garden.* — "In long-continued ranges of houses, we have found it extremely inconvenient when they are closely connected, and therefore we prefer the mode exemplified by that eminent architect, W. Atkinson, Esq., in many first-rate gardens, by leaving a convenient space between each division or range."

Mr. M'Intosh is an advocate for timber rather than iron in hot-house building, and recommends the larch, when of a proper age, and properly seasoned. But even *deal* he is "much disposed to believe more durable for hot-house building, than metal of any of the sorts which have hitherto been used." After enumerating all the different arguments against the use of metal, he concludes, "that metallic houses, from a variety of causes, break more glass than wooden ones is evident. The light which supplies that herculean undertaking, the Colosseum, in the Regent's Park, is admitted by too immense skylights of metallic construction: during the few extremely hot days of the summer of 1827, some hundred squares of glass were daily broken by expansion. Of this fact the ingenious and able projector is perfectly sensible, and being convinced, not only of the prevailing fault, but also of the attendant expense and inutility, has used nothing but wood in the erection of a range of conservatories, green-houses, and stoves, upon a scale and plan entirely unprecedented in this country. The public will soon be satisfied that houses can be constructed as elegantly and lightly, and at a much less expense, of wood, than of any metallic matter whatever. There are few of the numerous visitors, who have seen them, that have not supposed them to be iron, until informed of the contrary.

"In one conservatory, Mr. Hornor has adopted an ingenious plan of combining strength and lightness in the rafters. The roof is of an elliptical form, and the sashes are fixed. The rafters are composed of one bar of wrought-iron, three quarters of an inch thick, and 3 in. broad; this bar of iron is covered with deal timber, half an inch thick, and secured to the iron bar with neat screw-bolts, so that they have the appearance of being wholly of wood, and their size is consequently only  $1\frac{3}{4}$  in. thick, and 4 in. deep, which has a very light and neat appearance, while it is sufficiently strong to carry the weight of the roof.

"If strength and lightness be really indispensable for hot-house rafters, this appears to be the principle by which it can be effected, as by being covered with wood, all the conducting powers of heat, cold, or electricity are corrected, and the effects of contraction or expansion lessened, so as to be attended with no bad consequence; and it is probable that rafters so constructed will be more durable than metallic ones, exposed to the action of the weather. However, the expense of such rafters is considerably more than wooden ones of equally proportionable strength.

"The rafters of the peach-house in the garden of the Horticultural Society are also strengthened, by having bars of iron introduced into them in a similar way, as are the rafters in the conservatory of Mr. Hope, at Deepden; both houses are designed by William Atkinson, Esq., and in both of them the rafters are neat, light, and of sufficient strength to support any weight ever likely to be applied to them.

"Metallic houses attract electricity, and to guard against this evil, it has been recommended to cover with thick coats of paint. Most painters consider that paint put on in thick bodies defeats the purpose for which it is intended, by not adhering so closely to the body on which it is placed, as thinner coats of the same material, and, instead of protecting the body of

the material, is constantly peeling off. Putty is also recommended to be spread over half the bar, to lessen the conducting principle; most glaziers agree that the smaller the quantity of putty used, the less liable it is to loosen or fall off; and this is accounted for upon nearly the same principle, that thin coats of paint are better than thick ones. There is certainly no instance within our knowledge of any material injury being produced by the effects of the electric fluid, but that is no reason why such should never be the case. Accidents of that nature so seldom happen, under ordinary circumstances, that it is by no means a matter of surprise that it has not happened in the case of metallic houses, when we consider the comparative few in number throughout the kingdom.

"Practical gardeners are, and have been, doubtful of the success of such houses. Abercrombie and Speechly in England, and Nichol in Scotland, excellent practical and experimental gardeners, were decidedly against them, and most others have avoided giving their opinion. Mr. Atkinson, who has designed and built more hot-houses than probably any other architect of the day, is also decidedly against them. Those who have adopted them are chiefly amateurs, or philosophical gardeners; some few practical men have had the management of them, and one or two have built from their own designs. The most extensive erections of this sort are now building under the direction of Mr. Forrest, at Sion House. The result of his success will probably tend to set the matter at rest."

We give this long quotation, because it contains the opinion of a "practical man," and also of one "who has designed and built more hot-houses than probably any other architect of the day." We differ in opinion from both, but may, in the long run, be found in the wrong. It is singular, that some hundreds of squares of glass should have been broken daily in the metallic skylight in the Regent's Park by expansion, and not one by the same cause, or by contraction, in the iron houses in the garden of the Horticultural Society, or in any other iron houses that we have heard of. But the truth is, and we are surprised it should not be known to Mr. M'Intosh, who was head-gardener at the Colosseum at the time, the breakage of the glass, and the general derangement of the skylight, of the whole of one side of the building, including a rent in the outer wall, were produced by the giving way of the foundation, in consequence of some excavations. This was and is perfectly well known to the glazier and to the stone mason employed by Mr. Hornor, who, happening to be the tradesmen we employ, mentioned it to us at the time. How Mr. M'Intosh came to be ignorant of this cause of breakage we cannot conceive.

It is evident the builders of iron hot-houses have no fear of expansion or contraction breaking the glass, for Messrs. Bailey, Bramah, Richards, Jones, and Cottam generally contract to keep their erections in repair for fourteen years, for nothing in some cases, and a very small per centage in others. With respect to price, we might quote certain iron hot-houses at Woburn, and certain wooden houses erected there at the same time, and under the direction of the same architect, Mr. Atkinson, in the same garden, in which the iron houses are the cheaper, even at first cost. (See England, p. 213.) We admit that the duration of iron houses depends very much on their being regularly painted, as does that of wooden houses: but, if the duration of iron houses were even less than that of wooden ones, we should still prefer the former, on account of the superior quantity of light which they admit, and which is of so much importance in the winter and spring months; at which season hot-houses, if they are worth any thing, should afford the greatest enjoyment. It is not a little to the credit of two of the greatest noblemen of this country, that, from their own reason and examination of the question, they have adopted iron houses on a more extensive scale than has hitherto been done, not only in opposition to a host of prejudices on the part of many gardeners, and some architects, but, if we are

not misinformed, and we believe we are not, contrary to an opinion given at his request, to one of these noblemen, by some official persons connected with the Horticultural Society. It is gratifying to think that there should be so much science, and such a power of conquering prejudice, in men so far removed from ordinary life. We cannot but highly respect them on this account; and whatever may be the result of their trials, they are certainly entitled to the thanks of the horticultural world for having made an experiment attended with so much expense, and the result of which will be of so much importance. The more that we can manufacture out of the bowels of the earth, the more we shall be able to make of its surface. The less timber that is necessary, the more corn and fruit trees may be grown.

*Curvilinear Houses.* In order that we may not become prejudiced, or perhaps we should say, in order to counteract the tendency which we, in common with every other human being, have to become prejudiced, we shall quote all that Mr. M'Intosh has to say against curvilinear houses. "Some few curvilinear houses have been erected in this country, but they have chiefly been for the cultivation of flowering plants. Whether it be that their expense in their first erection, their inconvenience, or the effect that they produce as a garden structure, have operated as a drawback, is not certain, but they are not rising much in repute. That their expense in the first erection is considerably more than that of houses built upon the more common principle, cannot be denied, inasmuch as a great part of the materials, if of wood, is cut to waste, and their formation more difficult for the tradesman to execute; and, above all, if the sashes be made movable, which should be the case with all houses, whether they be ventilated by the sashes, or by means of ventilators properly constructed, and placed both in the front parapet-wall and likewise near the top of the back one, they are, in that case, incapable of being made rain-proof. For houses entirely constructed for cultivating flowering plants, they may, with less impropriety, be made of fanciful shapes and curvilinear roofs; but for houses expressly built for utility, they are not to be recommended. As they are constructed upon the principle of admitting the greatest number of the rays of heat and light, they also admit of the greatest portion of cold, particularly in windy weather, by allowing it to pass more readily into the house between the laps of the glass. Our own experience, in respect to two curvilinear houses for cultivating tropical plants, justifies us in joining to the testimony of others, in stating them to be decidedly more difficult to keep to a proper temperature than houses with sloping roofs, glazed upon the same principle, and of the same dimensions; indeed, so difficult was it to keep the required temperature in the houses alluded to, notwithstanding there were two fires constantly kept up, and the dimensions of the houses only 40 ft. long, by 11 wide, and one of them only 10 ft. high, that we were under the necessity of covering them with double mats during a great part of the winter of 1827.

"The majority of practical gardeners prefer those with straight roofs, and are content with the light and heat that they afford; and if we may judge of their relative merits by the crops of fruit produced in both, we see little reason to think that they will ever become general. Economy, combined with utility, we have always considered as a most important consideration in hot-house building, provided that they be so contrived that the plants may derive the due advantages of light, air, heat, soil, and water, these being the principal agents of vegetable life. The merits, therefore, of hot-houses will be judged by the perfection with which those indispensable agents are supplied.

"In our opinion, curvilinear houses have no advantage over others for the production of good fruit; and, as a mere matter of taste, we see no elegance in them that is not to be met with in well-constructed houses with straight or sloping roofs, if judiciously arranged, either in ranges or detached. In ranges (against walls) curvilinear houses have the appearance of being

unconnected, even though they may be joined; and, if detached, they as much resemble huge bird-cages as houses for the cultivation of fruits. The most convenient and economical form of houses seems to be that of a straight front, resting upon a parapet of brick or stone, of a proper width, and presenting an angle to the horizon, suited to the purpose for which it is intended. If for late forcing, or pine-stoves, an elevation generally of  $55^{\circ}$  will answer; but if for early forcing, the elevation will require to be more upright, to admit of the rays of the sun acting sufficiently powerful in the early part of the season, when the sun is low in the horizon."

*Heating by Steam.* — "As a means of heating upon an extensive scale, we perfectly agree with the most strenuous advocates for steam, as being the most convenient carrier of heat, as well as of its equality of distribution. We are also confident, that nothing injurious to the most tender parts of vegetation ever proceeds from steam, and that fruits and plants may be grown or cultivated in houses heated by steam, as well as in those heated by any other means, provided the general management be equally good in every other respect.

"But, that steam is the most simple method of heating hot-houses, or that it is more economical, either in point of fuel or erection, we are far from being singular in discrediting; neither do we think that there is any saving in labour. If ashes and coals be distributed to ten or twelve different furnaces, they are generally placed in such places that the delicate eye seldom visits; few, we believe, excepting the operatives, visit the back sheds of their gardens, where such unsightly objects are to be met with; but we have seen such places kept as clean and neat as the interior of many hot-houses are. We think the necessary care and attention, on the part of the gardener, as much required in attending the boiler and steam apparatus, as in attending to any number of fires necessary to heat an equal space, provided the furnaces and flues be properly constructed. The chimney-tops objected to (although not always the case) often are and might easily be made ornamental, as vases, &c., rather than otherwise; and if any degree of taste be exercised in their formation and distribution, they become ornamental, taking off that uniformity and stiff unbroken line, which the top of a garden-wall always presents, unless purposely broken. Arranged in such a way, they will be less offensive to the eye than a vast shaft, towering above every other object, and disgorging a volume of smoke, not much in unison with garden-scenery. Steam-pipes certainly occupy much less space in the houses than smoke flues, which is always desirable; neither do they require any internal cleaning, which brick flues do; but they require the inspection of an engineer, or person of skill, to examine them once or twice a year; which is much more than the expense of a labourer or bricklayer cleaning the smoke-flues.

"That insects are effectually kept under in houses heated by steam is not the case; it is done by good management only. Many who have had them erected have actually pulled them down, and reintroduced the common flues and furnaces; and a strong proof that they are more expensive is evident, from such eminent gardeners as Lee and Colville, and many others, who have the most extensive ranges of houses round London, not having introduced steam. To such men as those, economy is an object, and to such practical men we are to look for precedent, and not to gentlemen, who, from motives of persuasion or scientific curiosity, adopt such projects. An eminent London nurseryman, who had his houses heated by steam, at a great expense, has pulled the whole down, and substituted flues upon the general principle, but improved by his own ingenuity. He calculates a saving both of fuel and labour, taking the loss of the expense of his steam apparatus into account. Another person, long eminent for the cultivation of fruits in the neighbourhood of London, has pulled his down

also, and reintroduced the original flues, being practically convinced that he has lost much by the experiment; and since the introduction of the hot-water system, heating by steam, in this country at least, may be said to be abandoned, as far as regards horticultural purposes.

“It does not appear that hot-houses will ever be built in this country upon so extensive a scale, as to render the heating by steam really necessary, from a motive of economy. Where expense is no consideration, steam may be introduced into large conservatories, and be converted to many other purposes connected with domestic economy, as such buildings are usually attached to, or near, the dwelling of the owner; but for hot-houses in gardens, where the extent is not infinitely greater than any that has yet appeared in this country, fire-flues, or the hot-water system, will be found much the cheapest, and will answer every purpose of heating the houses equally well.”

*Hot-water, as applied to heating Hot-Houses.* — “For the invention, and introduction into practice, of this really useful and ingenious mode of heating forcing-houses, we are indebted to the ingenuity and perseverance of William Atkinson, Esq., of Grove End, St. John's Wood, a gentleman, not only eminent in his profession as an architect, but also a zealous promoter of every thing connected with horticultural affairs.”

We have not a doubt that Mr. Atkinson invented the means of heating hot-houses by hot-water; but we are equally clear that the original inventor was M. Bonnemain, in Paris, before 1777, and that both dwelling-houses and hot-houses were heated by hot-water by Messrs. Bolton and Watt, and by the Comte Chabannes, in England, before Mr. Atkinson's invention, according to Mr. Barrow's statement (Vol. III. p. 425.), was exhibited in models. The facts from which we draw these conclusions are all before our readers, in preceding volumes of this Magazine. Whether Mr. Atkinson or Mr. Anthony Bacon was the first to invent this mode of heating is a point not quite clear, nor do we think it of the smallest consequence either to the memory of these gentlemen or to the public. The state of science had long been ripe for such an invention, and the circumstance of having thought of it, is more a matter of good fortune than of scientific merit. A great defect in Mr. M'Intosh's book is, that he does not give a variety of plans showing the application of the hot-water system to different hot-houses, pits, and hot-beds; such engravings would have been incomparably more useful than the coloured dahlia (now georgina), camellia, amaryllis, and other such common things, or even the plans of hot-houses and pits, which accompany these seven numbers. Perhaps we shall have such plans in the remaining ones.

*The Pine-Apple.* — Mr. M'Intosh and we entirely agree on this subject, and he quotes at length our opinion with regard to bottom heat, as given in *The Different Modes of Cultivating the Pine-Apple, &c.* “The pine will bear a much higher degree of heat, for almost any length of time, than most fruit-bearing plants in cultivation, and will also, without injury, bear a degree of cold that would be death to any other exotic fruit, while in a state of vegetation. . . . We find it producing its fruit under a greater variety of bad culture, than almost any other cultivated fruit.

“Mr. Knight, in several papers in the Horticultural Transactions, has endeavoured to establish the practice of growing pines upon stages, and otherwise, without bottom heat; but in this practice he has not equalled, far less excelled, the most indifferent pine-grower in the country. Example is better than precept; and until Mr. Knight has proved by example his mode of culture to be superior to that so long approved by practice, his converts must be few. However, this eminent horticulturist deserves well of his country for any experiments he may make; he has made many, and some highly useful, and, much to his credit, he has performed them at his own expense, so that if he fail in some, it is but a natural consequence which



falls to the lot of man. However, he has succeeded so far by his own confession, in one important object, namely, in initiating a novice, an ignorant, or, to use his own words, 'an extremely simple labourer, who does not know a letter or a figure, and who never saw a pine plant growing till he saw those of which he has the care,' to understand their culture as well as he does himself. Attempts to cultivate pines, without bottom heat, have been tried by several gardeners, both on the Continent and in this country, and have been abandoned without the least hope of success."

In as far as Mr. McIntosh is concerned we are perfectly satisfied with this publication: but on the part of the publisher, and with reference to the public, we think it a badly designed work, on account of the useless engravings given, and the useful ones omitted. To make it worth purchasing there ought to be at least a dozen complete plans of hot-houses heated by hot water introduced; otherwise what advantage can this work have over the *Practical Gardener* of Abercrombie, which is much cheaper?

*The Domestic Gardener's Manual*; being an Introduction to Gardening on Philosophical Principles. To which is added a concise Naturalist's Kalendar, and English Botanist's Companion, or Catalogue of British Plants, in the monthly order of their Flowering. By a Horticultural Chemist. London. 8vo. 1s. To be completed in 12 successive Numbers.

The author observes, that most works on gardening are expensive, or written exclusively for the affluent; but that his book is addressed "to those, who, without aiming to become professional gardeners, wish, nevertheless, to acquire so much of the art of gardening, as shall enable them to conduct its more common and essential operations with facility and precision.

"It is intended that the work shall consist of twelve periodical monthly numbers, each number to contain three sections. The first section of every number will be devoted to subjects connected with the science or philosophy of gardening; such as the nature and agency of earths and soils; of electricity, water, the atmosphere, light, heat, &c.; of the structure and vascular system of plants, the motion of the sap, and the elaboration of the proper juice.

"The second section will contain the natural history, generic and specific characters, and cultivation of one or more of the chief esculent vegetables; to which will succeed directions for the operations in the kitchen-garden during the current month.

"The third section will treat on the natural history, &c., of the most esteemed fruit trees; and will contain directions for the management of the fruiting department during the month; to this will be added miscellaneous observations on the treatment of flowering shrubs, evergreens, flower-borders, &c.

"As it is presumed that many readers are curious in searching for facts connected with natural philosophy, and that others are attached to botanical pursuits, I have added to each number a concise *Naturalist's Kalendar*, and also a *Botanical Catalogue* of British indigenous plants. In the latter the species are arranged, not only in their respective classes and orders of the Linnæan system, as enlarged and improved in the last edition of Sir J. E. Smith's *English Flora*, but in the monthly order in which they severally flower. Thus the English botanist will find each number a *vade mecum*, or pocket companion, calculated to assist him in his endeavours to identify every plant which he may find in flower at any period of the year.

"Such, then, is the general plan of the work; but to enable the reader to understand its particular objects, something farther remains to be said. It is my earnest desire to enlarge the circle of science, to disseminate it in quarters where, till lately, it has been comparatively unknown; and, above

all, to excite an enquiry after truth. Conceiving that I shall most readily attain my object, by enabling the reader to examine and compare the various opinions and hypotheses advanced by scientific men, I have given, in the first section of each number, concise selections and extracts from the works of some of the most eminent chemists and philosophers; to which I have occasionally added such remarks as the nature of the subjects, and the result of my own reflection and experience appeared to require and authorise. The work, therefore, may be considered as a compendium, or book of reference, from which the reader may draw his own conclusion on the present state of science, particularly that termed *electro-chemical*: and on its probable applicability to the practice of horticulture.

“At a time when knowledge is spreading in every direction, when our operatives and mechanics give promise of producing some of our most enlightened characters, and when many of the sciences, both physical and mechanical, are laid open to their research, can there exist any just cause why such men should not be instructed in the true principles of agriculture and gardening?”

“I am not aware that any *cheap* publication has hitherto appeared, which pretends to treat of gardening as a science of induction. Believing it to be such, and that to attain any perfection in the *practice*, it is indispensably necessary to acquire some knowledge of the philosophy of the art, I have felt it a duty to call the reader's attention to the operations of those natural agents by which all the phenomena of vegetation are induced. Peculiar stress has been laid upon the agency of electricity, with the view of exciting close investigation into that branch of the philosophy of nature, which appears to have been the most neglected; although there is little reason to doubt of its containing the germ or embryo of that true science, which, if it ever fully developes itself, will scarcely fail to make manifest causes and effects which have heretofore been involved in inextricable mystery.

“The late Professor Playfair once observed, ‘If we consider how many different laws seem to regulate the action of impulse, cohesion, elasticity, chemical affinity, crystallisation, heat, light, magnetism, electricity, galvanism, the existence of a principle more general than these, and connecting all of them with that of gravitation, appears highly probable. The discovery of this great principle may be an honour reserved for a future age; and science may again have to record names which are to stand on the same labels with those of Newton and Laplace.’ He added, ‘it were unwise to be sanguine, and unphilosophical to despair.’

“The conjecture of this great man has, to a certain extent, been verified; and it may not be presumptuous to conjecture, that ‘the great principle’ itself will ultimately be referred to one grand and only source.

“I believe that this source is already discovered and known, and that it only requires the philosophic mind to divest itself of prejudices, and to cease from pursuing shadows, since the substance itself stands revealed to the view of all. If I succeed in rendering this apparent, I shall enjoy the satisfaction of having done something for the cause of science, by simplifying the means of scientific research into the operations of that grand principle, which I cannot but view as the source of, and prime operative agent in, all the phenomena of the material world.”

From these quotations it will be evident to our readers, that this is a work of considerable pretension. We can hardly judge of its execution from the first number, which, besides the preface, contains only forty pages; but the book is so exceedingly cheap, and the object of the author so laudable, that we can hardly go wrong in recommending it to the class of readers to whom it is addressed. When the work is completed, we shall again recur to it, and extract every thing that is not to be found in Mr. Johnson's series of papers on Horticultural Chemistry.

*Major, Mr. Joshua, Landscape-Gardener: A Treatise on the Insects most prevalent on Fruit Trees, and Garden Produce, giving an Account of the States they pass through, the Depredations they commit, and Recipes for their Destruction, including the Recipes of various Authors, with Remarks on their Utility; also, a few Hints on the Causes and Treatment of Mildew and Canker on Fruit Trees, Cucumbers, &c. &c.* London and Leeds. 8vo. 10s. 6d.

Notwithstanding that so many have already written on this subject, Mr. Major feels himself justified in adding to the number, because "some branches are not yet fully understood. . . . He has for several years devoted himself carefully to the observation of the habits and history of those animals, and has tried a great number of experiments for their destruction, the result of which he now lays before the public. He has thought it necessary to give a description of the appearance and habits of the different insects to be destroyed, as well as a short history of their different changes and processes, that every one may be able to detect them, and may understand at what times the recipes can be applied with effect, and when, from the state of the insect, they and all other remedies will be quite useless—a point of great importance, but one which has been hitherto altogether neglected. If the recipes are found to be effectual, he will have effected all that he intended."

The subject is treated in a practical and popular manner, a section or article being devoted to each of the principal fruit trees and culinary vegetables, the insects which infest each enumerated, and the modes of prevention or destruction described by various authors given and remarked on. The author does not appear to be a scientific entomologist (*e.g.* Beetles, p. 218.), and the book is wanting in the interest which it might have had by giving the natural history of the insects and some of their related species, and that of the natural checks to them, whether insects or birds, or other animals. But though it is not what we think it might have been, it is still a most useful work, and being the only book devoted exclusively to garden insects, and written by a gardener, we hope it will find its way into every garden library.

The following on shreds for fastening wall trees is good. "It is preferable to use shreds of cloth to any other mode that is practised for training trees, as they form harbours for insects, through the winter, and afford a good opportunity for the insects and eggs of insects to be removed with the shreds, and destroyed with boiling water."

*Growth and Preparation of Tobacco.*—Sow in a hot-bed about the middle of March, transplant in small pots, and shift two or three times till the latter end of April. Transplant in a sheltered situation on light rich soil, at 2 ft. apart every way. In autumn, when the lowest leaves are beginning to assume a yellowish hue, take them off, tie them in bundles of half a dozen, and hang them up to dry; in a fortnight a second gathering will be ready: when all the gatherings are dried, pack them together straight and close "so as to produce perspiration, like what is necessary for new hay. . . . If a sufficient quantity cannot be got at one time to produce perspiration of itself, it may be greatly aided by packing it in a box, closing it up, and then covering overhead the whole box in a heap of weeds, grass, or manure that is in a gentle heat; after sweating a week or ten days, it may be kept in a moderately dry situation, so as to prevent its moulding."

*Tobacco Water.*—"It will require not less than a pound of the leaves to a gallon of water to make good tobacco water, and in order to obtain the whole of the virtue of the tobacco, it will be proper to let the water be poured over the leaves in a boiling state. The liquid may remain covered up a few hours, or till wanted for use. Before it is used the leaves must be taken out, taking care to have the whole water squeezed

from them. Any quantity that is necessary may be made at a time, as it will be no worse for keeping, especially if kept air-tight.

Sixteen recipes are given, one or other of which is capable of destroying all the insects enumerated. The two principal ingredients in these recipes are common soap and tobacco water; in two or three of them quicklime is the sole or principal ingredient, and in one or two alum or soot enters into the composition. We like them the better for being simple, and because the writer has used or seen used every one of them with success. The volume is cheap, and we wish it a favourable reception.

*Felton, S., Esq.,* Author of *Portraits of English Authors on Gardening, &c.* (Vol. IV. p. 261.), *Miscellanies on Ancient and Modern Gardening, &c. : Gleanings on Gardens, chiefly respecting those of the ancient style in England.* London, 8vo. 5s.

Our excellent friend has here collected a number of curious extracts respecting old English gardens, Scotch gardens, conventual gardens, garden burial, cottage gardens, the cultivation of the vine in Britain, Sherborne, formerly the seat of Sir W. Raleigh, and Pope's Villa at Twickenham.

*Burial of the Duke of Saxe-Gotha, in 1804.*—“He forbade in his will, all ceremony at his burial, except such as is usual for his lowest subjects. He desired to be buried in his English garden, at the feet of the coffins containing the bodies of two of his already deceased children. No speech nor sermon to be pronounced, and no monument to be erected over him; but he desires his second son, Prince Frederick, to place a tree upon his grave. To this prince he bequeaths his English garden, which is to be open, as formerly, to all visitors. The simple burial ceremony of this sovereign took place on the night of the 25th, according to the wish expressed in his will. The reigning duchess, with her child in her arms, had, the evening before, strewed flowers round the grave. The midnight hour struck, when the body entered the garden, carried by the servants of the late duke. The walk to the island was laid with black cloth, with the boat that carried it over. The ceremony was only interrupted by the sighs and tears of all present.”

45

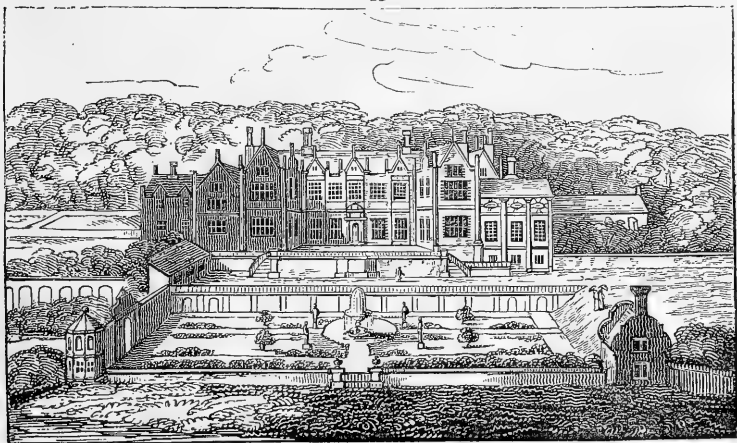

Speaking of engravings of gardens, he says, “to sum up all, let me again refer to the most beautiful plates ever given of old English gardens, namely, to that at Oxneed Hall (*fig. 45.*), in the second volume of Mr. Britton's

*Architectural Antiquities*, and to his exquisite copy of Kipps's view of the garden at Longleat (*fig.44.*), in the same splendid volume."

44

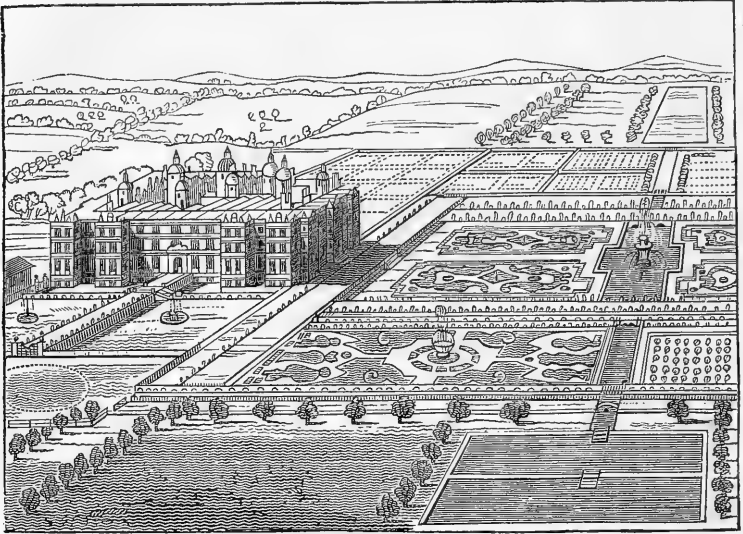

*Horne Tooke.*—"No one delighted more in horticulture, and rural affairs, than Horne Tooke. Cato of Utica could not have exceeded him in this attachment. The intention of Mr. Tooke certainly was to have been buried in his own garden, and he had prepared his vault, and tomb, in his richly cultivated garden at Wimbledon, where both Lord Camelford, and their joint friend, Lord Thurlow, with other men of rank, who admired his integrity, his overpowering talents, and his genius, were proud to partake of his society. Part of the inscription which he had prepared for that tomb was, that he died 'content and grateful:' satisfied at having lived so long, and gratefully feeling a high sense of the Divine goodness in permitting it; a frequent conversation of his being on the wisdom, goodness, and beneficence of the Deity. Mr. Tooke closed his long and stormy life, after having survived the scorpion stings of slander, with an extraordinary degree of calmness and intrepidity. On his decease, however, his friends thought it best to bury him in the grave of his sister, at Ealing, at the age of seventy-seven, where the words *content* and *grateful* now form part of the inscription on that stone which covers the remains of that acute scholar, that richly gifted and most disinterested of men, whose dauntless mind made it his boast that 'no allurements or threat, no power or oppression, nor life, nor death, thunder or lightning, shall ever force me to give way to corruption or influence, half the breadth of a single hair;' and who, when enforcing what he deemed beneficial to his country, thus addressed his jury: 'I protest, that if there stood a fire here, and I thought I could by that means affect your minds, and the minds of my countrymen, I would thrust my hand with pleasure into the fire, and burn it to ashes, whilst I was pleading before you.' And who, on another occasion, made this declaration, 'I have never committed a single action, nor written a syllable in public or in private, nor entertained a thought (of an important political nature, when taken with all its circumstances of time, place, and occasion),

I wish either recalled or concealed; I will die as I have lived, in the commission of the only crime with which I can be charged during my whole life, the crime of speaking *plainly* the *plain* truth.' In the early part of the life of this friendly and kind man, when he resided at Brentford, as a clergyman, no one was more beloved by his parishioners; he administered every possible comfort to the poor; his sermons zealously enforced the excellence of that faith in which he had been educated."

Our readers will see, from the last extract, that Mr. Felton has a just feeling for grand and generous sentiments, as well as a taste for gardens. The whole indeed of his excellent little work breathes the spirit of kindness and philanthropy. We should like to give him the use of Mr. Forsyth's library for two years, in order that he might find materials for two thick 8vo volumes instead of this fragment, the shortness of which every reader will regret. Wherever it is wished to create an enthusiasm for gardening pursuits, this little book should be thrown in the way.

*Moggridge, J. H.*, Esq., one of the Vice-Presidents of the Glamorgan and Monmouthshire Horticultural Society: An Introductory or Inaugural Address, delivered at the First Meeting of the Glamorgan and Monmouthshire Horticultural Society in the Town Hall, Cardiff, on Monday the 22d of September, 1828. Cardiff. Pamph. pp. 20, 2 pls.

The Address points out the enjoyments and advantages procured by the knowledge and practice of gardening, and states the objects of the institution. These are, "not only to disseminate more widely the improved principles of the art of ornamental and landscape gardening, as applicable to the park, the pleasure-ground, and the pleasure-garden; and to incite and encourage the better cultivation of the gardens of the labouring poor, as well as the better management of the kitchen-garden, the conservatory, and the hot-house of the rich; but such a share of its attention as may be called for will be bestowed upon the production and cultivation of forest and fruit trees, shrubs of all kinds, flowers, and herbaceous plants, even the different kinds of grasses which ought to form important portions of the improved herbage of our meadow and pasture lands. To effect these purposes, at once so useful and gratifying, written communications on any of these subjects will be welcomed by the Committee of the Institution, and selections made for reading at its periodical meetings. The proceedings of similar Societies will also enter largely into the consideration of this Society, and occasional lectures be obtained when practicable, both in the theory and practice of horticulture, in the most enlarged sense contemplated; and such shows be established, and premiums given, as will direct the public attention to the subject, stimulate to useful emulation, and excite that kind of competition, which, whilst its success benefits and gratifies the individual, must be useful to society. Of the utility of such pursuits, the country in which we live affords abundant proof. . . . In this country, and perhaps in the world, the Horticultural Society of London takes the lead in this career of general beneficence and universal good: it has agents ransacking distant regions for floral treasures; its garden to rear, cultivate, and protect them; its members to disseminate them; its corresponding societies to exchange with; its splendid *Transactions* to record and describe them; and its country and the world to benefit by them. . . . But greatly as the world, and this country in particular, is indebted, for the present advanced state of its knowledge and practice of horticulture in its different branches, to the patronage and exertions of useful societies and of distinguished individuals, it is to the attention which has in modern times been bestowed upon the first principles of the art, and the discoveries which have been made in the arrangement and classification of plants, and, above all, to the more intimate acquaintance with their structure, functions, and properties,

which we have of late acquired, that we owe by far the greatest portion of the excellence we have attained."

Mr. Moggridge pays a just tribute to Messrs. Loddiges and their establishment, "such as is not to be met with in the possession of any prince in Christendom." It is also highly gratifying to us to observe him duly appreciating the extraordinary genius of Dr. Darwin, whom, we believe, we are not singular in considering the greatest theoretical vegetable physiologist that has appeared in this country. Dr. Darwin was the first to argue that every bud of a plant is an individual vegetable being; a fact which seems to have been neglected till it was brought into notice by M. du Petit-Thouars some years ago; but now, when certain false doctrines (p. 175.) are giving way, will be received and acted on as it ought to be.

The processes of vegetable life are explained and illustrated by plates, representing the umbilical vessels spread on the cotyledons of the bean, the spiral vessels of the vine leaf, the longitudinal fibres in the bark of the willow, and the continuous masses of tubes and cells in vegetable bodies. "Whilst the eye of every person of taste or sensibility is gratified by the beauty internal, as well as external, which vegetable life presents to his inspection, and whilst the exquisite skill and most decided marks of design which it exhibits, proclaim to the heart and the understanding that its Author is great and good, and wise beyond our utmost conception, we must be convinced that the encouragement this Society will hold out to the industrious classes to look to their gardens, as a sure and certain source of never-failing amusement and profit, can be regarded only as an object of unmixed good. The comforts and benefits to be derived from a well cultivated garden, by a poor-man's family, are almost beyond calculation. What a resource for hours after work, or when trade is dull, and regular work scarce! What a contrast and counteraction is the healthy manly employment which a cottage garden affords, to the close, impure, unwholesome air, the beastliness and obscenity, the waste of time, the destruction of morals, the loss of character, money, and health, which are the inmates of too many common ale-houses! The experiments of Lord Cawdor, Mr. Estcourt, and others, on a larger scale, in a neighbouring county, afford abundant confirmation to the belief, that, whilst the cultivation of the garden of the cottager increases the means of the maintenance and comforts of his family in no ordinary degree, in investing him with a property peculiarly susceptible of injury from trespass, it teaches him to respect the property of others."

*George, John, Esq., Barrister at Law: The Cause of the Dry Rot discovered; with a Description of a Patent Invention for preserving decked Vessels from Dry Rot, and Goods on Board from Damage by Heat. London. 8vo, pp. 186, plates.*

The liability of timber used in the construction of ships and houses to be destroyed by what is called dry rot, has been long known as a misfortune, occasioning immense losses to private individuals, as well as to the nation in the premature decay of ships of war. No circumstance has more engaged the attention and pens of both practical and scientific men, than the discovery of a protection against this national evil. Many have been the causes assigned; and many expedients have been had recourse to, as means of prevention, but still without success. In general it has been attributed to imperfect seasoning; and, therefore, every effort has been made to prepare timber for use which should be free from liability to decay in this unaccountable manner, and though the cause has hitherto remained a secret, the effects are every day occurring to an alarming extent.

The present writer has assigned as its cause an incident never adverted to by any previous writer on the subject, and what, indeed, many would have considered as rather useful than otherwise, and even, perhaps, em-

played as a preventive, viz. the passing and repassing of currents of heat through the body of the timber.

He took up this idea from an instance observed on his own premises, namely, the destruction of an inner door in his wine-cellar. This was a new deal door in an oak frame, which he had put up in 1821. It was well painted on both sides, and completed in the best manner. In 1825 or 1826 this new door was found so decayed, that the pressure of a thumb indented it, the interior having entirely lost its hardness and consistency, nothing but the coats of paint keeping it in form. This accident attracted his particular attention, and induced him to commence a course of observations to ascertain the temperature of the air, both within and without the inner vault. The result was, his finding, as in all similar cases, that there was almost constantly going on, an interchange of temperature from the interior to the exterior, or vice versa, of the vault, and chiefly through the substance of the door.

As there is a never-ceasing ascent of vapour raised by heat from the earth, and especially from any subterranean cavity such as the vault described, he found that the heat only passed through the door, leaving the globules of water condensed on the inside, when the heat was escaping outwards, and on the outside, when the summer heat was pressing inwards to maintain an equilibrium of the general temperature. No moisture, however rarefied, could possibly pass through with the heat, the double coat of paint preventing. The heat, therefore, was the only agent to which the author could attribute the decomposition of the door, and it immediately occurred to him, that if timber can be protected from becoming a conductor of heat, or placed in equal temperature on both, or all sides, it will be free from any danger of dry rot.

On this hypothesis or fact Mr. George has founded his plan of prevention, and has invented a curious and effective apparatus for ventilating ships and cargoes liable to damage from heat, and for which he has obtained a patent.

The inductions which led to the conclusion are detailed with the utmost minuteness by the author. The spontaneous transmission of heat from place to place, and from one body to another, is accurately and naturally given; and though he conscientiously believes that the alternating transit of heat is the decomposing cause, he does not venture to explain how it acts to produce the effect. He offers a conjecture, however, which is to the following purport: "Heat is capable of entering into combination with other things, and of making with them new and distinct substances, each *sui generis*, and which substances may be either in a gaseous, or a liquid, or a concrete and solid form. I think the process of vegetation, in the growing of timber trees causes a quantity of heat to enter into chemical combination, and in a concrete form, with other substances, and with them compose timber. So that, I think, heat in a concrete form, and in that form, as a part of a visible material substance, visible to the eye, and having weight, like other substances, is one of the component parts of timber, and as well of other combustible substances." This combination, however, may be disrupted; and "my notion, then, as to how the current or stream of heat, in passing through timber, decays it, is, that when its motion is sufficiently quick, it, by degrees, disengages *its sister* heat in the timber from its chemical combination in a concrete form with other substances, and makes it assume its original form or shape of active heat, whereupon they both pass out together, leaving the timber deprived of one of its component parts, which consequently becomes decomposed and rotten." (pp. 44, 45.) "Should, however," he adds, "my notion on this matter be proved completely erroneous, it will be of no consequence, my undertaking having been not to show how heat, by working its way through timber, decays it, but only the fact that it does so."



Whether simple heat ever exists in a concrete, visible, and ponderous form is at least enigmatical. That it is a principal agent in the combination and dissolution of matter is obvious and well known; but that it should disengage any formerly combined portion of itself existing in a cellar door, or lower timbers of a ship, while the baker's peel, or mantle shelf over a fire-place, remains uninjured, is not so easily understood. Were it asserted that it dissolves and dissipates the resinous qualities which give adhesiveness and tenacity to the fibril tissue or structure of the timber, the explication would be at least plausible; but that there is such a thing as neutralised heat, and as such combined with resin, and which becomes fugitive in some cases (though not in all), on receiving an active current of itself, is not easily comprehended. Many would say, in the case of the door, that it was painted too soon, and before the deal of which it was made was thoroughly drained of its aqueous sap. This sap being confined by the impermeable coats of paint, would naturally be excited into a destructive fermentation by the current of heat, and in time cause rottenness. This is the way in which many would account for the destruction of the door; but this is presupposing a case which there is no ground for believing existed; and as the author does not consider an explanation of the manner of the destruction necessary, so we consider it altogether unnecessary to express any thing like scepticism as to the truth of his conclusions, or of the value of a discovery which promises such great and manifold advantages.

There is one omission, however, in the account of the cellar door, which, had it been added, would have been strongly corroborative of the validity of the author's discovery, viz. whether the upper or lower part of the door, first began to decay. According to this gentleman's observations (and they are naturally faithful), the greatest quantity of heat, both in degree and rapidity, passed and repassed the upper part of the door; in course, if heat be the destroyer, this must have been damaged some time before the lower part.

The author treats the notion of those who believe that the dry rot is caused by a fungus, as he says himself, "rather unceremoniously." (p. 46.) But here he betrays some want of knowledge as a naturalist. Can he be ignorant that the almost invisible roots, if such they may be called, of this occult tribe of vegetables, have the power of changing the colour and *constitution* of both mineral and vegetable bodies, without showing any external sign of their existence? While the filaceous structure of even the common mushroom, one of the most palpable of the tribe, is luxuriating in darkness, and dry heat, decomposing the consistence, and devouring the colour and qualities of the soil in which it is placed, not a vestige of its fructification is to be seen on the surface. This does not appear till long after the plant has full possession of the place; and no doubt many instances of unaccountable spontaneous decomposition, are caused by invisible funguses which have never yet been detected by the naturalist; so minute is their organisation; their existence being only suspected from a view of their effects.

The cure for this great and, by all accounts, increasing evil, the author proposes to accomplish by a new and ingenious mode of effective ventilation.

By the apparatus described, and the manner of working it by indications of thermometers, an equality of temperature may be maintained in the deepest recesses, as in all other parts, of a ship or house. An equal degree of heat on all sides will pervade the whole fabric, so that this subtle element will never be attracted by colder substances, nor any transmission of it from place to place kept up. For instance, if, as is usually the case, the water in which a ship floats is colder than the confined air of the hold, the cooled planking of the sides will naturally attract the interior heat which will pass through outwards leaving condensed, on the inner surface, the water which it holds in solution. In this case, the thermometer in the hold will indicate the disparity, and the engine man will immediately pump out the warmer air of the hold, to admit a volume of colder air to descend in its

place. Now, though this would take place without the aid of machinery, the extra-heat of the hold escaping at the scuttles and gangways, yet in closely decked vessels, the process is too slow for the requisite purpose of thorough ventilation.

By the machinery recommended, any decked ship may, at any time, be completely ventilated from stem to stern; and the consequences held forth by its adoption, are, durability of the timbers, safety to the cargo, and, what is not less material, highly conducive to the health of the crew.

In order to seize every advantage arising from this discovery, and to collect proofs of its efficiency, it may be worth while to enquire whether ships stationed in high latitudes are more liable to decay from dry rot, than those more frequently in lower. The affirmation must follow from Mr. George's doctrine, and especially as it regards the ships employed in the late Arctic expeditions; because it is impossible, consistently with the comfort of the crews, to maintain any thing like equality of temperature, within and without the ship. A vessel in such a region must be a nucleus of radiation of heat, and by consequence, her external timbers must be a constant channel to the current of its escape.

Respecting the liability of ships of war to dry rot, attention should be given to the *steam-bending process* of compass timbers; it being questionable, whether timber remains the same, as to structure and durability, after, as it is before, undergoing this unconstitutional flexure.

We have often, ourselves, when on board ship, conceived the idea of both pumping and ventilating the hold of a ship by machinery worked by the vessel's motion. Any contrivance, and especially the author's apparatus, would be far better than the *windsails* now in use.

Fully sensible of the great national importance of this new discovery, we sincerely hope to witness or hear of the complete success of the undertaking; and that Mr. George will receive the reward, as well as the credit, of giving to his country one of the most valuable of modern improvements.  
— J. M.

*Widowson, Henry, Esq.*, late Agent to the Van Dieman's Land Agricultural Establishment: Present state of Van Dieman's Land; comprising an Account of its Agricultural Capabilities, with Observations on the present State of Farming, &c., pursued in that Colony: and other important Matters connected with Emigration. Dedicated by Permission to the Right Honourable Lord Althorpe. London. 8vo, pp. 200, with a Map. 8s. 6d.

This writer agrees with those who have preceded him, in considering Australasia the most favourable country for Britons to emigrate to, and Van Dieman's Land as the preferable settlement there. A few years ago, he says, this settlement was literally a "den of thieves;" but the sort of talent called forth there in order to live, being of a peaceful kind, the reformation which has taken place in the moral character of the convicts, "is really astonishing." The truth is that nine tenths of the sinners against the laws of society, have become so from the difficulty of procuring the means of existence in the regular way, and it is only the few whose tastes have been vitiated by a long course of depravity, that will not or do not become honest, when from plenty they can afford to be so. Mr. Widowson contemplates the independence of New Holland, and Van Dieman's Land, at no very distant period; but, like a liberal and enlightened man, sees only in this the natural progress of things, and the increase of human happiness. The idea of one great power, having colonies and dominions all over the world, is only suitable for a certain state of the world; as all mankind become enlightened and free, nations and governments will settle themselves down into those magnitudes and forms, which are found to afford the greatest quantity of personal liberty and happiness at the least possible expense. No man will ever question the advantages to Great Britain and Ireland, of

the union of the two islands, which took place in 1801 : but, if knowledge were so universal as that nations were governed by opinion, by the press, in short, by the newspapers ; if standing armies were no more necessary for nations than coats of mail are for individuals ; if commerce were as free as it one day certainly will be ; if these things, and those which will inevitably be connected with them, were to take place, the independence of Ireland might become as advantageous for both countries in 2001, as their union was two centuries before. In the meantime the system of colonies and distant possessions must go on ; because Providence has fixed upon the necessity of transporting convicts, and providing for the sons of the British aristocracy, as the means of civilising the world, and of planting every where the most improved variety of the human species.

A chapter is devoted to the state of gardening in the colony, from which we do not find much to extract, that is not already given in our notice of the *Tasmanian Almanac*. (Vol. III. p. 462.) " Cucumbers, pumpkins, and melons, can be raised under glass in the spring, and in the open air, during summer, either by hotbeds, or by the assistance of dung, in the open grounds. . . . The vine has been cultivated in Tasmania with great success, and wine of a superior quality has been made from the grape. The apple and peach, where they have been attended to, grow plentifully throughout the island : I have seen fruit, of moderate size, grow on grafts that really were not fit to unbandage. The different kinds of apple common in England have been introduced into the island. The cherry appears well adapted for the climate, and thrives well. The raspberry and strawberry grow more abundantly than in any place I ever saw ; they appear to yield more fruit than they do in England, especially the former. Currants and gooseberries are grown by almost everybody who has a garden. Pears, plums, and damascenes, have not yet made much progress ; nevertheless, every tree that England can produce may be grown in the colony, and many species that cannot stand the winter in England, will flourish in the open air in Tasmania. The myrtle and geranium are constantly green, and wear a beautiful appearance throughout the winter."

*Daniell, W., Esq. R.A. :* View of the Palais Royal, as it will appear after the Completion of the Improvements.

These are two aqua-tinta prints of considerable size. The improvements are chiefly an immense hall covered with a curvilinear glass roof, and containing, along the sides of the hall, a row of shops with small rooms over. Each shop has a small fire-place, the chimney of which is a cast-iron tube, which forms the newel or spindle of a geometrical winding staircase. The chimney, which terminates this newel, is carried as high as the glass roof, and is of a handsome shape. The whole building is elegant, both externally and internally ; and the covered saloon, whether in the day lighted from the roof, or at night from gas, forms a commodious and highly interesting lounge. Viewed, however, with reference to the health of this part of Paris, we think it should not have been erected ; the Palais Royal was before a pent up enclosure, and is now two pent up enclosures.

*Kennedy, L. and Granger, T. B. :* The present State of the Tenancy of Land in Great Britain ; showing the principal Customs and Practices between incoming and outgoing Tenants, &c. London. 8vo.

" We have risen from the perusal of this work, with feelings of much satisfaction, and an accession of useful information, relative to the customs connected with the tenancy of land. We strongly recommend the volume to the attention of the farming interest, as embracing a compilation of the various systems of husbandry adopted in different counties, and developing many local particulars that cannot fail to be regarded as novel and interesting." (*Farm, Mag.*, Nov. 1828.)

*Strickland, G., Esq.*: A Discourse on the Poor Laws of England and Scotland, on the Poor of Ireland, and on Emigration. London. 8vo. 3s. 6d.

Contents:—Introduction. Importance of the Subject. Evidence. Plans for the Repeal of the Poor Laws of England. Origin of the Poor Laws. Causes of their present State. Forty-third of Elizabeth, chap. 1. Vagrancy. Effects of the Poor Laws in England. Delays in improving them. Bill brought into Parliament in June, 1827. Marriage of Paupers. Poor Laws of Scotland. Irish Labourers. Emigration. Poor of Ireland. Amount of the Poor Rates in England and Wales. Appeals. Poor Rates in the Northern Counties. General View of the Poor Laws. Conclusion.

*Tovey, Thomas, Esq.*: Author of "Cheltea, a Descriptive Poem," &c.: An earnest Address to all Ranks of People in the United Kingdom; wherein is shown, that a much larger Supply of Provision may be easily raised for its Inhabitants; Taxes much lessened, particularly the Tax for maintaining the Poor; Emigration become needless; and the Prosperity of the Nation greatly promoted. To which is added a Sketch of a Petition to Parliament on the Subject. Cheltenham. Pamph. 12mo, pp. 22.

Large farms the author considers the principal cause of the dearth of provisions, and of course he would create small farms, and with Lord Brownlow's father, "Rather build two cottages than suffer one to be annihilated."

*Phillips, Sir Richard*, Author of various Works, and especially of a Number of excellent School-Books: A Personal Tour through the United Kingdom, describing living Objects and contemporaneous Interests. No. I. Bedfordshire, Northamptonshire, Leicestershire. London. 8vo.

A very cheering picture is given of the state of education in these counties: the means of obtaining instruction are becoming more and more within the reach of those who may be willing to be instructed, of whatever class. Newspapers, public and circulating libraries, book societies, and schools of all kinds, are springing up in every direction. (*Westminster Rev.*, Jan. 1829.)

*Cline, the late Henry, Esq., Surgeon*: Observations on the Breeding and Form of Domestic Animals. 8vo. 1s. 6d.

*Trimmer, Joshua Kirby*: Practical Observations on the Improvement of British Fine Wool, and the National Advantages of the Arable System of Sheep Husbandry; with remarks on the Saxon and French Systems. Price 3s.

*Stanhope, the Earl*: A Letter to the Owners and Occupiers of Sheep Farms. With the Evidence before the Committee of the House of Lords on the Wool Trade. Price 4s.

*Harding's Farmer's Account Book*. New edition. Price 21s. for a year, or 10s. 6d. for a half-year, book.

This work, having been patronised by the nobility, gentry, and farmers in general, for many years, is recommended, with increased confidence, to the notice of all persons concerned in agricultural affairs.

*Wright's Catalogue of New and Second-hand Works on Agriculture, Gardening, Planting, Farriery, Sporting, and Rural Affairs in general*. Price 1s.

*Lindley, John, Esq. F.R.S. L.S. G.S. &c.* Professor of Botany in the London University: A Synopsis of the British Flora; arranged according to the Natural Orders; containing Vasculares or Flowering Plants. London. 12mo. 10s. 6d. boards.

*The Gooseberry-Grower's Register*; or, an account of the different Gooseberry Shows held in Lancashire, Cheshire, and other parts of the Kingdom, for the Year 1828. Salford. 16mo. 1s. 8d.

*Arcana of Science*, and Annual Register of the Useful Arts. Abridged from the Transactions of Public Societies, and from the Scientific Journals, British and Foreign, of the past Year. Illustrated with 52 Engravings. London. 12mo. 5s.

We refer to Vol. IV. p. 146. for our opinion of the first volume of this work, in which we are confirmed by the present volume. We do not know a book containing such a varied and useful mass of information, and sold so cheap; and we consider it particularly suitable as presents from masters to their gardeners, and to male servants of every description. We should like to see an attempt made to cultivate the intellects and improve the morals of coachmen and footmen, by putting books of this kind into their hands, and we do not know a better one to begin with.

#### FRANCE.

*Annales de la Société d' Horticulture de Paris, &c.* Paris. In 8vo Livraisons, monthly. 15 fr. in Paris, 18 fr. in London, for 12 Livraisons (one year).

*Liv. X. and XI. for June and July, 1828, contain*

*On the Walnut with variable changeable Leaves* (*Juglans regia heterophylla*). By M. Jacques. — Notwithstanding the very general culture of the walnut, but few varieties have been obtained, except in the size of the fruit. The most remarkable of those is called the St. John's, which deserves cultivation, especially in northern countries, because it is much later in flowering than the other varieties, and, consequently, escapes the late spring frosts; but, being a shy bearer, it should be propagated by grafts or layers. The various-leaved variety is met with near the little town of Saint Pourçain, department of Allier, 79 leagues from Paris. The habit of the tree is singular; the fruit is of a lengthened round shape, unlike the common, is large, and has a tender shell. A note to the foregoing description, by M. Vilmorin, states that this variety of walnut was first noticed by M. le Comte Montbron at Clervoux near Chatellerault in 1812, and was then described in the *Almanach du bon Jardinier*. Its picturesque appearance among forest trees constitutes its chief value; the branches being pendulous like those of the weeping ash. An additional note, on the same subject, by M. Loiseleur-Deslongchamps, informs us that this variety of walnut has been long known in France, and that it has been sometimes called *Juglans expansa*. The last writer mentions another variety deserving notice, viz. the *grape walnut*, from the manner of the fruit growing in bunches of 10, 15, or even 20 together, and, consequently, yielding great crops.

*The Culture of Roses.* By M. Vibert, nurseryman, formerly of Chenevieres, now of Saint Denis. — Watering the plants during summer is enjoined as essential to success. Even the stocks for budding on should be kept well watered, to insure strength of shoots. The month of June is the proper time for budding, provided the weather is not too dry; cloudy weather, and on mornings and evenings, are the most suitable times of the day for that operation. M. Vibert advises a summer regulation of the shoots, by disbudding, pinching off the tops of over-luxuriant shoots, of the stocks, as well as of the worked plants. Even the footstalks of the faded flowers, he says, should be cut off as a means of encouraging the general growth of the plant. Stopping the shoots, from which buds are intended to be taken, strengthens the bud, and is a good practice, especially with such sorts as the Provins. Frequent watering greatly assists the striking of layers. Shade the more delicate sorts, or keep them in north aspects.

*Observations on the Puceron lanigère (Aphis mali).* By M. de Noyelle. — This insect is oviparous; commits its greatest ravages about the middle of August, and from that time till the end of September; it then attains its full growth, and is fecundated; runs over all the tree, resting in the places where it finds the greatest supply of sap, on which it lives, and consequently exhausts the plant. The eggs are laid in the crevices of the bark, and in punctures made by the animal itself. Over these punctures little tumefactions are visible, caused by the extravasation of the sap. This insect is found on the willow (*Sàlix vitellina*), as well as on the apple; it prefers the sweetest-tasted apple trees, and such as grow on a dry soil, rather than those on a stronger damp soil. M. de Noyelle tried many different things to kill or banish these insects, viz. soap-suds, soda, potash, decoctions of walnut leaves, and white-wash of lime, without avail. At last he tried sulphate of lime, and his success was complete. Three years' experience confirms this discovery. He thus describes his practice: — "Towards the end of February I examine my trees, and wherever I see nodosities which contain the eggs, I cut them smoothly off with a knife. I move the earth from around the bottom of the tree, to see whether they have fixed themselves on the neck, or point of junction between the stem and the roots; if nodosities appear there also, they are pared off. I then, with a large brush made of bristles, and one of a smaller size to enter the crevices, wash my trees from head to foot. A good workman will go over a great many trees in a day; but, as it often happens that some of the crannies or retreats of the insects are not reached, it is necessary that the washing should be repeated the following year. The composition should be laid on before the buds swell; as its caustic quality would be detrimental. Lofty trees are washed by means of a hand pump or engine. The composition is thus prepared: — Boil in six or eight parts of water, two parts of quicklime, and one part flour of sulphur, for a quarter of an hour; then strain through a hair sieve; when it is ready for use. It should be always well shaken before it is used.

*A New Process proposed for destroying the Mole Cricket. (fig. 45.)* By M. Robert, Director of the Botanic Garden at Toulon. — Farmers and gardeners have long complained of the damage sustained in their crops of peas and beans, from the mole crickets; and without being acquainted with any efficient means of destroying them. "I capture them," says the writer, "by plac-

45

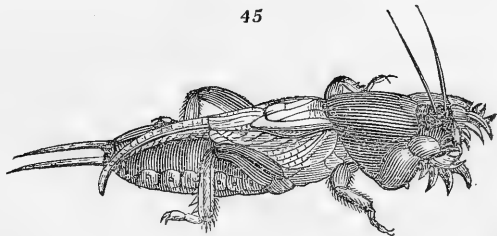

ing fresh sods or turves, on the beds or borders of the garden where any traces of the insects are seen. These turves, being well watered overnight, attract the insects to hide under them, where they may be easily caught in the morning. This scheme persisted in, will soon rid any place infested with them, especially during the months of April, May, and June."

The mole cricket is very common in the neighbourhood of Paris, but not very frequent in Britain. The only place where we happen to have seen it is in the pleasure-grounds at Syon, in the moist turf along the artificial river. The figure we now give is from a drawing made from nature, by a young lady, from an insect she found in the neighbourhood of Salisbury, and sent us in order to ascertain its name. The drawing, Mr. Sowerby observed, was beautifully done; and this notice of it will, we hope, be grati-

fying to our correspondent, and encourage her and others to take an interest in such things, and render us similar services.

*Liv. XII. for August, 1828.*

*The semicircular Kitchen-garden of M. de Rouvroy, of Lisle, with a plan, (fig. 46.)—*This garden is a parallelogram of between 500 and 600 ft. in

46

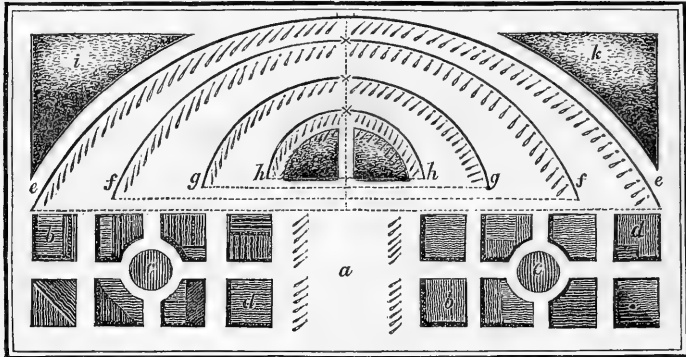

length, and about half that extent in width. It is divided longitudinally into two nearly equal parts. The one part is laid out in two divisions separated by a vacant space in the middle (*a*), and these again subdivided into regular compartments for the growth of vegetables (*bcd*). The other, and principal, part of the garden, is divided by brick walls 12 feet high, into irregular slips. These walls are not straight, but more or less curved, according to their respective positions (*efg*). The walls are all sections of ellipses, each having proper foci, except the inner one (*h*) which is a semicircle. There are four such walls; the outer one embracing all the others, and extending nearly the whole length of the garden. The peculiar curvature of these fruit walls, is said to combine all the advantages of the best aspects, and so to concentrate the sun's heat, that fruits ripen upon them, and vegetables perfect in the borders in front of them, much sooner than in right-lined walls or borders. The committee to which this plan was referred admit the truth of the inventor's allegations, as far as respects the concentration of heat, and therefore think that such walls would be suitable for such fruits as the fig, the pomegranate, &c., and the borders, for such vegetables as the pastick (*Cucurbita Citrillus*), the sweet potato (*Convólulus Batatas*), and the Lima bean (*Phaseolus lunatus*); but doubts are entertained whether, on light warm soils, the heat would not be too much for the generality of our espaliers. The two north angles of the parallelogram (*ik*) are filled up with fruit-tree nurseries. Curvilinear fruit walls were in vogue many years since in Britain. They were contrived for the purpose of obtaining a longer supply of wall fruit, by placing the same sorts of fruit trees on different aspects, and thereby hastening or retarding the ripening: but they had not the desired effect; and in windy weather it was found that they generated such sweeping gusts, that much damage occurred to the trees, and thus the plan fell into disrepute.

*Note on the common Caterpillar.* By M. Daudville. — This, from the description, appears to be the *Bómbyx dispar* of Linnæus. It breeds on and devours the leaves, flowers, and even the young shoots, of apple trees;

stripping them so as to give the orchards the appearance of winter. Every means to destroy them have been tried by the orchardists in the neighbourhood of Saint Quentin, but without success. The writer earnestly begs the assistance of the Society in this case, and hopes for advice from some of their readers. — *J. M.*

*Jacquin*, MM., frères, Seedsmen, Florists, and Nurserymen: *Essai sur la Culture, la Nomenclature, et la Classification des Dahlia*. [now *Georgina*.] Paris. Pamph., pp. 51.

Three hundred varieties of this genus are now on the lists, and the produce from seeds are every year increasing the number. The interests of trade, and gratification of the amateur, call for some kind of arrangement, in naming this extensive family. The Messrs. Jacquin, therefore, have divided their collection into eight principal groups, founded on their difference of colour, viz. white, rose, violet, crimson, flame, yellow, red, and streaked. These are again divided into sections, as ivory-white, lily-white, deep rose, &c., or other terms indicating arbitrary properties. Their catalogue contains 269 varieties. — *J. M.*

*Vallet*, M., ainé, Member of the Soc. of Agr. of the Department of the Lower Seine, and of the Soc. of Hort. of Paris, Nurseryman, Rouen, a very worthy man: *Catalogue des Roses*. Rouen. Pamph. 12mo, pp. 42.

M. Vallet comes annually to London with a stock of roses for sale; and, among other fine sorts, he has introduced the following: —

*In December*, 1826. — Rose Duc de Choiseuil maculé; rose double, grande (Provins). *Georgina* Mars; petite, très pleine, et très vive (Prov.). *Pheдре*; rouge, très pleine, forte (Prov.). *Syrius*; d'un cramois brillant, double, moyenne (Prov.).

*In February*, 1828. — *Mousseuse éclatante*; très vive, pas extrêmement double, moyenne. *De la Hogue*; carnée, très grande et très pleine, hybride de centfeuille, et de *Rôsa álba*. *Sophie de Bavière*; presque blanche, moyenne, très pleine (*R. álba*). *Bengal Darius*; écarlate, très pleine, moyenne. *Princesse de Nassau*; hybride de *Rose muscade* et de *R. Noisette*, blanche, double, moyenne.

*In February*, 1829. — Duc de la Rochefoucault Liancourt; rose très grande, très pleine (Prov.). *Guillaume le Conquérant*; cramois très foncé-velouté et maculé de feu et de blanc moyenne, très pleine (Prov.). *Ma Pupille*; hybride de *R. semperflorens*, couleur ardoise, extrêmement pleine, moyenne. *Jeanne Hachette*; pale rose *Damas*, très pleine, très grande. *Mousseuse Zoé*. *Mousseuse Partout*; sur le bois, sur les épines, sur et sous les feuilles: lorsque l'arbre est vigoureux, ses feuilles, qui ont une teinte pourpre pendant les mois de Mai et Juin, ressemblent à celles du *l'orme* à feuilles crispées. *Mousseuse rouge*; extrêmement double, son bois ressemble à celui du *Rosier Pimprenelle* (Scotch rose). *Admiral Nelson*; rose très grande, très double (Prov.). *Comte de Vandes*; rose très grande et très double. *Constance Zacarias*; rose très grande, et très double (Prov.). *La Normande*; rose, très double grande (Prov.). *Rose Verte de Rouen* (1827) (*R. álba*); très double, moyenne. *Noisette Charles X.*; rouge (Bengal). *Sempervirens* à fleurs pleines, blanches. *Eve*. *Magnifique Tassin*. *Beauté du Jour*. *Henriette* à fleurs pleines. *Le Lilas Charles X.*

*Tarade*, M. *Alfred de*, Member of the Hort. Soc. of Paris: *Culture des Rosiers écussonnés sur Eglantiers*. Paris. Pamph. pp. 51.

This tract has been translated, and the essence of it is given in Vol. IV. p. 381.



*Vibert, J. P.*, Member of the Hort. Soc. of Paris, and Cultivator of Roses at St. Denis, an intelligent, honest, and very excellent man :

1. *Essai sur les Roses. Première Livr.* Paris. 8vo, pp. 85. 1824.
2. *Essai sur les Roses. Deuxième Livr.* pp. 80. 1826.
3. *Observations sur la Nomenclature et Classement des Roses, suivies du Catalogue de celles cultivées par l'Auteur.* pp. 54. 1827.

*Monceau, Duhamel du* : *Traité des Arbres Fruitières.* Nouv. edit. par Poiteau et Turpin. Livr. 46. Paris. Felio. 1*l.* 10*s.*

*Rédouté* : *Choix des plus belles Fleurs, prises dans différentes familles du règne végétal, &c.* Livr. 9, 10. Paris. 4to. 12*s.* each.

*Loiseleur Deslongchamps, M.*, Member of various Societies :

1. *Flore Générale de la France.* Livr. 1, 2. Paris. 8vo, 6*s.* each ; 4to, 12*s.*
2. *Essai sur l'Histoire des Muriers et des Vers-à-Soie, et sur les Moyens de faire chaque année plusieurs récoltes.* Paris and London. 8vo. 5*s.*

*Risso, M. A.*, Ancien Professeur des Sciences Physiques et Naturelles au Lycée de Nice, Membre de plusieurs Académies et Sociétés savantes : *Histoire Naturelle des principales Productions de l'Europe Méridionale, et particulièrement de celles des Environs de Nice et des Alpes Maritimes.* Paris and London. 5 vols. 8vo, orné de 46 planches et de 2 cartes géologiques. En noire, 3*l.* 10*s.* ; col. 6*l.* 15*s.*

*Brard, C. P.* : *Minéralogie appliquée aux Arts, ou Histoire des Minéraux qui sont employés dans l'Agriculture, l'Economie domestique, la Médecine, la Fabrication des Sels, des Combustibles, et des Métaux, l'Architecture et la Décoration, la Peinture et le Dessin, les Arts Mécaniques, la Bijouterie et la Jouaillerie ; ouvrage destiné aux artistes, fabricans, et entrepreneurs.* Paris and London. 3 forts vols. 8vo, 15 pls. 1*l.* 1*s.*

*Parmentier, A.*, and *N. Deyeux* : *Précis d'Expériences et Observations sur les différentes Espèces de Lait, considérées dans leurs rapports avec la Chimie, la Médecine, et l'Economie Rurale.* Paris and London. 8vo. 4*s.*

*Anon.* : *Instruction sur les Paratonnerres, adoptée par l'Académie Royale des Sciences, et réimprimée avec autorisation de S. E. le Ministre de l'Intérieure.* Paris and London. 1 vol. 8vo, 2 pls. 2*s.*

*Richardot, Ch.* : *Système (nouveau) d'Appareils contre les Dangers de la Foudre et le Fléau de la Grêle.* Paris and London. 8vo. 1*s.* 6*d.*

*Remusat, Charles* : *Mme. Guizot, Conseils de Morale, ou Essais sur l'homme, les meurs, les caractères, les grands, les femmes, l'éducation, &c., avec une notice sur sa vie.* Paris. 2 vols. 8vo. 18*s.*

*Bidaut, J. N.*, Author of *Du Monopole qui s'établit dans les Arts Industriels et le Commerce* : *De la Mendicité, de ses Causes et des Moyens de la détruire en France.* Paris. Pamph. pp. 59.

The essential causes of mendicity the author considers to be the monopolies of territorial property, commercial capital in the form of machines, and the monopoly of knowledge. His remedies are, colonisation, cultivation of waste lands, the division of extensive properties in land, the abandonment of machinery and manufactures, the dissemination of useful knowledge among the people, so as to elevate their manners and sentiments, the suppression of missionaries (du clerge nomade) and of the Jesuits, and the modification of charitable institutions in such a way as that the indi-

viduals who took refuge in them should be obliged to work as hard as those who supported themselves by their labour; in short, he would turn what in England are called parish workhouses into manufactories. There are a good many benevolent and wise suggestions in this pamphlet, mixed with erroneous notions with respect to the influence of machinery, the accumulation of capital, and the interference of government.

### GERMANY.

*Verhandlungen des Vereins, &c.* Transactions of the Russian Gardening Society, &c. Vol. 5. part 1. Berlin. 4to, 1 pl. 2 dollars.

Two or three of the papers in this part are translations of articles from the *Transactions of the London Horticultural Society*. The plate is a coloured figure of *Gesneria latifolia Mart.*, brought from Brazil to the botanic garden at Berlin, in 1826, by M. Sellow.

*Reider, Jacob Ernst von*, Provincial Assessor in Bavaria, Member of various Societies, and Author of several Works; a citizen of Nuremberg, a very amiable and intelligent man, with a charming wife and family:

1. *Handbuch der Blumenzucht, &c.* Nuremberg and Leipsic. 1 vol. 8vo. 1828.
2. *Das Ganze der Rosen Kultur, &c.* Nuremberg. 12mo. 1829.

*Hazzi, M. von*, Knight, Counsellor of State to the King of Bavaria, Member of many Societies, and Author of various Works: *Neuester Katechismus des Feldbaues, &c.* Catechism of Agriculture and Gardening in use in the Country Schools of Bavaria. Munich. 12mo. 1828.

The nature and uses of this catechism we have already mentioned. (Vol. IV. p. 494.) There are a great many different editions; in some of which field, forest, fruit-tree, and culinary vegetable culture are in as many different volumes; in others two or more of them are combined.

*Wagner, J. Ph.:* *Ueber Merinos-Schafzucht.* Königsberg. Gr. 8vo, mit 7 steintafeln. 12s. 6d.

*Elsner, J. G.:* *Uebersicht der Europ. veredelten Schafzucht.* Prague. 2 theile, 8vo. 14s.

### ART. III. *Literary Notices.*

*A HISTORY of English Gardening*, chronological, biographical, and critical, is soon to appear from the pen of our correspondent, Mr. G. W. Johnson. "It will be the first separate history of the art, in all its branches, that has ever appeared."

*A Treatise on Smut in Grain*; giving an Account of its various Causes in *Wheat, Oats, Barley, &c.*, and the Manner in which *Smut* may be effectually prevented, both by natural and artificial means. The whole deduced from extensive practical experience, and illustrated by a variety of useful and highly interesting Engravings, rendering the Work of the greatest utility to the Practical Farmer, as well as interesting to the Public. By John Lawson.

*Plantæ Asiaticæ Rariores*; or, Descriptions and Figures of a Select Number of unpublished East Indian Plants, will be published by Subscription by Dr. Wallich, in Twelve Numbers, each containing Twenty-five Engravings, to appear every Three Months. Price 2l. 10s. each Number.

## PART III.

## MISCELLANEOUS INTELLIGENCE.

ART. I. *Foreign Notices.*

## FRANCE.

PARIS, Jan. 17. 1828. — You should not have left France without visiting, and recording the agricultural improvements of, my excellent friend, General La Fayette, at La Grange, who relied on your spending a few days with him.

Besides the admirable arrangement of his farm, and his fine flock of Merinos, you would have greatly approved the substitution of an orchard of 10,000 apple trees, for the vines of an old vineyard, on strong clayey soil. The General has found that, on such a soil, the cider of the apple, properly prepared, is superior to the wine of the grape. The towers of the General's chateau are now thickly clad with ivy, and the grounds around it are laid out à l'Anglais, according to a plan sketched out, and directions given, by Charles Fox, during his visit of a week at La Grangé. . . . Ever yours, — Chev. Masclet.

*Passage of Hot Air and Smoke through Flues.* — Numerous experiments have lately been made in France, for the purpose of ascertaining the laws regulating the rapidity with which hot air passes through flues, &c. The results appear to be: — 1. That flues oppose to the passage of hot air a resistance proportioned to the length of the pipe, the square of the rapidity, and in an inverse ratio to the diameter. 2. That the coefficient of friction is not the same with reference to different substances. 3d. That by narrowing the superior orifice of a flue, the rapidity of the passage of the air through that orifice, goes on increasing to a certain limit, which is the rapidity resulting from the pressure that takes place at the inferior end of the pipe. 4. That by narrowing the inferior orifice of a flue, the body of air passing through (la dépense) diminishes solely in proportion to the diameter of the orifice, and consequently that the rapidity in the orifice itself increases in an inverse ratio to its diameter. The two last results are capable of numerous applications to the useful arts. A strong draught is frequently indispensable. Hitherto only two elements have entered into the estimate of draught, — the height of the chimney, and the temperature of the hot air. To increase the height of a chimney is always attended with considerable expense, and it cannot be heightened indefinitely, and to increase the temperature of the hot air costs much fuel. It now appears that the diameter of a chimney is also a powerful element in draught, limited when the superior orifice is fixed; indefinite when it is not so, and this element costs very little expense. (*Lit. Gazette*, April 5, 1828, p. 218. Com. by A. G. near Barnsley.)

*Transplanting Shrubs in full Growth.* — Dig a narrow trench round the plant, leaving its roots in the middle in an isolated ball of earth; fill the trench with plaster of Paris, which will become hard in a few minutes, and

form a case to the ball and plant, which may be lifted and removed any where at pleasure. (*French Paper. Com. by L. R—r.*)

*Education of the Military.*—Schools upon the Lancasterian plan are establishing in the different regiments, in virtue of a decision of the Supreme Council of War. The Council has also decided that courses of lectures on literature, the sciences, &c., shall be established for the officers and sub-officers, and which all the privates are to be invited to attend. (*Paris Paper.*)

#### GERMANY.

*Public Garden at Frankfort.\**—Most towns of any size on the Continent—in this point, alas! so different from those of England—can boast of their promenades and public gardens, but not many can, in this respect, vie with Frankfort, which is wholly surrounded (except on one side where the Maine runs) with a *Jardin Anglais*, or pleasure-ground, at least two miles in length, and occupying the breadth of the former ditch and ramparts, laid out in the English style, and affording great variety of shady walks and picturesque scenery, with the grand advantage of being accessible from every part of the city in a few minutes. One peculiar feature of this pleasure ground is, that it is not confined to trees and shrubs, but contains a profusion of the choicest flowers, roses, dahlias, chrysanthemums, &c., together with most of the showy annuals, as balsams, China asters, &c., even geraniums and *Ferraria Tigridia*, planted in large masses of each, and intermixed with vast beds of mignonette, all in a high state of luxuriance and beauty. Nothing could be more brilliant than the display of this garden when I saw it in September last, when the dahlias, and the superb clumps of *Datura arborea*, *Salvia coccinea*, &c., were in flower; and, as a proof of the scale on which it is managed, and the attention paid to it, I may mention that the gardeners were then preparing a bed of irregular figure wholly for pinks, above 60 ft. long, and from 9 to 15 ft. broad, which they were trenching 2 ft. deep, after laying manure at the bottom of each trench, and carefully picking out the stones.

This garden affords a striking, and, to an Englishman, very mortifying proof of the great superiority of the manners of the German lower classes over those of the English. Though merely separated from a public high-road by a low hedge which may be stridden across, and at all times accessible (there being no doors or gates of any kind to the entrances) to every individual of a population of 50,000 souls, and constantly frequented by servants and children of all descriptions, not a flower, or even a leaf of any one of the plants, from the rarest and most showy to the humblest, seems ever touched. Even the beds of mignonette looked as untrodden and unplucked as if in an English private garden. It is needless to say how utterly impossible it would be to have, near any large English town, a similar garden, thus open to the public, and thus scrupulously kept from injury: and yet there are no persons (as far as I saw) to watch, and instead of threats of heavy penalties, a printed paper is affixed on a board at each entrance, expressing, in German, that the public authorities having originally formed, and annually keeping up, the garden, for the gratification of the citizens, its trees, shrubs, and flowers are committed to the safeguard of their individual protection. This simple appeal is here sufficient—of what use would a similar one be in England?—*W. S. Brussels, Feb. 26. 1829.*

---

\* These gardens were laid out, between 1809 and 1811, by M. Sebastian Rinz, nurseryman in Frankfort; and his son M. Jacob Rinz, a beautiful ichnographic and pictorial draughtsman, now in England, and about to make a tour in Scotland and Ireland, has furnished us with plans of them, which will be published in our promised work. (See Vol. IV. p. 537.)—*Cond.*

*Landscape-Gardening at Munich.* — Our southern excursion took in part of your route. We spent a week at Treves, a fortnight at Baden, a week at Carlsruhe, three days at Schwetzingen, &c. &c. In our proposed journey, next summer, more into the interior of Germany, we shall try, from what you say of it, to take in Munich, to see M. Sckell's application of the plan of planting in masses of one species. What I have hitherto seen done on this plan, on a small scale, I confess, has disappointed me, and seemed even more insipid than the old one, which gave some variety of outline; the masses of shrubs looking like clipped hedges, and the trees as pudding-like as any clumps that deform an English park; but this is probably from the system not being properly understood. — *W. S. Brussels, Jan. 22.*

*Pfaueninsel, Potsdam, Feb. 22. 1829.* — Our winter has been very severe; and during five days, which occurred between the 21st of December and the 7th of February, the sun did not shine. From the 7th of February to this day, we have had four days in which the sun never appeared. Notwithstanding these disadvantages our cherries are ripe, and some will be gathered this week. We calculate on cutting grapes by the 20th of March, and we have been gathering strawberries since the 1st of February. At Sans Souci the plums are an inch long. The finest plants at this season of the year, in the Berlin botanic garden, are the Ferns and *Aröideæ*: all the others look well, but these look the best. The Cape plants are now coming into flower. I beg of you to express my most sincere thanks to all those gardeners in Great Britain and Ireland that I had the happiness of seeing during my late tour in your country; they took the greatest pains to inform me of every thing, and showed me the utmost liberality and kindness. I am, Sir, &c. — *G. A. Fintelmann.*

*An Encyclopædic Dictionary of Plants*, by M. Kachler, has just made its appearance at Vienna; it is in two volumes, one of which has already appeared, and is intended more for the use of gardeners and amateur horticulturists than for botanists. (*For. Quart. Rev.*, Jan.)

#### NORTH AMERICA.

*Value of a good moral Character.* — We presume that you have been informed that we have procured a situation for Mr. Cameron, the worthy gardener you introduced to us. It was as well the honest man had friends here to attest to his good character, as an awkward circumstance befel him on his way to Boston, to enter on his situation a few miles beyond that city. On the passage to Boston, some villain broke open the trunk of the mate of the packet, and took thence 250 dollars. On arriving at Boston the passengers were all searched, and 250 dollars being found between the leaves of Cameron's bible (I believe), he was taken up on suspicion. The only circumstantial evidence in his favour was, that the notes lost by the mate were on the bank of Boston, while the notes found on Cameron were those of the bank of New York. There he was an entire stranger, with a large family, threatened with imprisonment, and which would have been carried into execution, had not his employer stood in the breach and become bail for his appearance at court. His employer immediately wrote us to clear up the business; and the justice, having no doubt of his innocence, wrote the cashier of the bank of New York to ascertain if Cameron had drawn any money from the bank, and at what date. Cameron also wrote to us stating the whole affair, and referring us to a banker in the city to whom he sold a bill for 60*l.* at a certain time. We called on the banker, and found all correct. The banker also wrote the justice the satisfactory particulars, which exonerated Cameron in the most honourable manner. How valuable is a good character, which thus insures a man friends wherever he goes!

Had Cameron been a stranger without any references, however innocent he might have been of the odious charge, it is probable the circumstantial evidence against him (as he just had 250 dollars and a 10 dollar note beside, the remainder having been necessarily laid out on stores, &c.) would have been the loss of his little all, and perhaps imprisonment; for the difference of the bank notes would not have cleared him in the eye of the law, because he might have exchanged them at an office in Boston for notes on the New York bank. But an overruling Providence brought him out of the trial, pure as gold from the crucible. — *G. Thorburn and Son. New York, Jan. 31. 1829.*

We are happy to learn that our introduction has been of use to Mr. Cameron. We always considered him a very worthy man, and it is but justice to him to state that at the commencement of the Gardener's Magazine, he contributed several papers which must have been written from the highest motives; because at that time, and for upwards of a year afterwards, we were personally unknown to each other. — *Cont.*

*Fruit trees received from Mr. Prince of the Linnean Botanic Garden near New York.* — The following were intended for the late John Braddick, Esq.; and have been sent by Mrs. Braddick to Mrs. Young of the Epsom nursery, who will propagate them for sale, and thus spread them through the country.

*Downer's late Red Cherry.*

*Remington White Heart Cherry.* The latest of all American cherries, flavour but middling, its late maturity being its principal merit.

*China Heart Cherry.* A seedling of the Carnation, raised by Mr. Prince. A very peculiar fruit, both in flavour and appearance.

*American White Heart Cherry.* The largest and finest of the White Hearts.

*Prince's Duke Cherry.* The largest of American cherries.

*Yellow Honey Cherry.* Comes the same from seed, and much planted along our roadsides.

*Bowne's Imperial Russet Apple.* The largest of all russetings and highly esteemed.

*Hubburdston Nonsuch Apple.* An apple of very fine quality, and held in great estimation, yet but partially disseminated.

*New England seek no further Apple.*

*Red Baldwin Apple.* Highly esteemed.

*Bowne's Imperial Russet Apple.* A great acquisition, and quite new here.

*Pope's Scarlet Major Pear.* Beautiful.

*Boston Epargne Pear.* This is claimed by some as a European fruit, which is a point undecided.

*Rushmore's Autumn Bon Chrétien Pear.* An excellent baking and tolerable table fruit; a great bearer, and the fruit ripening by degrees during five or six weeks.

*Bowne's Winter Rousselet Pear.* Esteemed.

*Red Raspberry.* The fine kind cultivated for the market, and excellent for raspberry brandy.

*Many's Italian Apricot.* A seedling from a stone received from Italy.

*Lemon Freestone Peach.*

*A Nectarine sent by mistake.* I believe it is the Early Scarlet, a European kind.

*Prince's early Purple Plum.* — (*Extracted from the duplicate list sent us by Mr. Prince.*)

*Indian Corn.* — Messrs. Thorburn of New York have sent us some beautiful spikes of six different varieties of Indian corn. Three of them are of a dark blood colour and beautifully formed; the others are yellow.

Of these one is 1 ft. long, has 8 rows, and weighs 10 oz. ; the other is 9 in. long,  $2\frac{1}{2}$  in. diameter, has 12 rows, and weighs  $9\frac{3}{4}$  oz.

*American Seeds.*—They have also sent us the following seeds : *Ipomœa novæ*, New *Ipomœa*, beautifully blue and white spotted ; *Ipomœa quamoclit* ; *Campánula americana* ; *Franklinia Attamàha* ; *Eupatòrium cœléste* ; *Centaurœa americana* ; *Cardiospérmum Halicácabum* ; *Euphórbia variegàta* ; *Momórdica Líffa* ; *Chamærops húmilis* ; beautiful orange gourd.

We have sent the seeds to the Horticultural Society ; and any person desirous of having a few grains of the Indian corn shall be welcome to them, for the trouble of sending to Bayswater. — *Cond. March 15. 1829.*

*The House of Assembly in Jamaica* offered the following premiums on Dec. 22. 1828 :—

To the best regulated and most extensive establishment in the island, for educating and giving employment to poor persons of free condition, 250*l.*

To the person who shall raise and manufacture the largest quantity of tobacco of good quality, not less than 5000 lbs. weight, 100*l.*

To the person who shall raise and manufacture a substitute for hemp, not less than one ton, equally cheap, strong, and durable, and applicable to all the purposes to which hemp is now used, 100*l.*

For producing within the island the greatest quantity of cochineal, not less than 50 lbs. weight, 100*l.*

For the best treatise on the management of the cochineal, and on the growth and manufacture of indigo, each 50*l.*

For the greatest quantity of good indigo produced within the island, not less than 500 lbs. weight, 100*l.*

For the manufacture, within the island, of the best piece of cotton shirting or check, not less than fifty yards long, and one yard wide, from cotton grown and spun in the island, 150*l.* ; next best, 100*l.*

For converting the silk cotton to some useful article of manufacture, 100*l.*

To whoever shall produce and ship to Great Britain in one year the largest quantity of good and marketable wool, not less than 500 lbs. weight, shorn from his own sheep in this country, 100*l.*

Samples and certificates to be produced to the House of Assembly during the session of 1829 and 1830. Yours, &c. — X. Y. *March 9. 1829.*

## ART. II. Domestic Notices.

### ENGLAND.

*HEATING Hot-houses with hot Water.*—During the autumn, I have been engaged in fitting up a small stove and green-house, which I have heated with *hot water*, the simplicity of which beautiful process cannot be better exemplified, than from my having been able to perfect the whole in the most satisfactory manner, by the common artisans of this place, who, I need not tell you, had never either seen or heard of such a process before. The regularity of temperature is delightful, while consumption of fuel (of no object here 'tis true) is a perfect bagatelle. Instead of tan I have heated the entire bed of the stove with branch pipes of a small diameter, and covered them with sand, and in order to obtain the *moist heat of bark*, I have constructed small laterals, pierced like the rose of a watering-pot, which, by means of stopcocks, I can, at pleasure, and if occasion requires, flood the bed, cause steam to arise, and, in short, realise all the advantages of *fermenting material* without its dirt and annoyance. I take credit to myself for this little addendum to the system, and I am gratified to say it works delightfully. — J. T. A. *Carmarthen, Dec. 24. 1828.*

*Heating Hot-beds by hot Water, in 1801.*— A scientific gentleman of my acquaintance [Mr. Williams of Pitmaston] grew fine melons by means of hot water in metal pipes, in the year 1801; and, seeing his success, I followed his example, and raised cucumbers and melons in the same way, for some years. He discontinued his plan on account of the facility which occurred to him in procuring tan. I discontinued my apparatus on changing my residence, when I attempted an improvement by the use of a great number of one-inch pipes, which failed after one season, partly from the difficulty of excluding air from them, but principally from sediment in the water supplied to them, without due regard to its purity. But fully satisfied of the excellence of this plan, in the year 1809, or earlier, I had drawings made of it by an architect, adapted to horticultural purposes, and lent them to many persons. — *T. N. Parker. Feb. 12. 1829.*

*Iron Hot-houses at Woburn Abbey.*— We had an opportunity, Feb. 20., of inspecting the hot-houses erecting here, and heated by hot water in a very superior manner, by Mr. Barrow, under the direction of Mr. Atkinson. (Vol. IV. p. 304.) Mr. Forbes informed us that in one of the coldest nights of January last, he determined on ascertaining what a pine stove would lose in heat, between 8 o'clock in the evening and 8 the next morning. January the 25th, at 8 o'clock in the evening, the thermometer in the open air stood at 13°, that in the pine stove after the fire was made up for the night at 65° and next morning at 55°. The temperature of the atmosphere in a wooden house, as compared with that of an iron house, in neither of which there was any artificial heat was ascertained, when that of the iron house was 3° higher than the other, owing, as Mr. Forbes conjectures, to the laps of the glass being puttied in the iron house. At any rate, this proves that the loss of heat, by the conducting qualities of iron is but a small matter. Not a single pane has yet been broken in these iron houses, either by contraction or expansion. — *Cond.*

*Lemons and Oranges.*— Mr. Skey, of Spring Grove, near Bewdley, Worcestershire, has sent us some very fine lemons of his own growing: one of them weighs 11 oz., and two others nearly as much; and the whole are well-formed fruit. Mr. Skey mentions that he gathered last year 65 dozen of lemons and 45 dozen of oranges. (*Extract from Mr. Skey's Letter of March 14. 1829.*)

*Bregazzi's Bark-bed Thermometer* has been greatly improved, by the addition of a thermometer for the atmosphere in the inside of the small door (Vol. III. p. 215. fig. 61. a), and by imbedding the bulb of the plunged thermometer in cork or in wood, to neutralise the conducting effects of the case of copper. It is now by far the best instrument of the kind.

*A Self-registering Thermometer* has also been produced by Mr. Bregazzi at the very low price of 5s. 6d.

*Mr. James Rollins, late of Dingle Bank*, who was among the earliest of our correspondents to establish a garden library, has, we have observed, commenced business on his own account in the neighbourhood of Liverpool. We have no doubt that in his new capacity he will support the reputation which he has already attained as a serving gardener, and as the author of various papers in this Magazine. The editor of that ably conducted newspaper, the *Liverpool Observer*, expresses (*Observer*, Feb. 19.) a similar opinion.

*Models of Estates.*— We have before noticed our own models, and those of Mr. Crowe (Vol. II. p. 252.), made, or to be made, with a view to show the effect of surface improvements. In the National Repository, Charing Cross, London, is a model of a tract of country in Wales, by R. C. Taylor, Esq., mineral engineer, which not only shows the state of the surface, but that of the substrata. It is an excellent example of that sort of picture which one would suppose every very extensive landed proprietor would



desire to possess of his land. It would be exceedingly interesting to see such a model of a parish, on such a scale as to show the form of every house, and the plan of every garden. The model of a county would be highly interesting; and, still more so, that of the whole of our island: but the most interesting model of all would be that of the whole of our earth, about the same scale as the model of Germany in this exhibition; or in the form of two semiglobes, as suggested in a former volume, each semiglobe containing several acres, and planted in correct imitation of the actual distribution of the vegetable kingdom; the whole of the tropics being of course under glass, and all the tropical lakes and rivers of water heated by steam-pipes, from the fires which would produce the imitations of Vesuvius, Ætna, &c. To preserve the necessary curvature in the surface of the imitations of the ocean, it would be necessary to compose all the extensive surfaces of water of a great number of separate vessels placed close together; or perhaps it would be better to have the imitation on a flat surface, by which the water, being on a level, would be perfectly natural. The most suitable part of the British Islands for such a garden would be the south of Ireland, because less glass would be required there than in England, and because 200 acres, which would be required to do justice to such a garden, might better be spared there than in the coal district of the south of England.

*A Metropolitan Sepulchre.*— One of the most extraordinary, and, if it were possible to say it without giving offence, we should add, absurd projects we ever heard of, is that for a metropolitan sepulchre, of which a section is exhibited in the National Repository, and a circular published, addressed to the Lord Mayor. The design is a pyramid, with a base, to occupy an area as large as Russell Square, and to be raised nearly four times the height of St. Paul's. It is to be laid out in 152 stages, which are to contain about 900,000 catacombs for ten millions of coffins, "which are to be closed up and sealed for ever when interment takes place, with stone tablets on the face, explanatory of name, age, place, &c." The prime cost will be about seven millions, and the profit upwards of sixteen millions sterling. After answering the principal objections that he supposes will be made to it, the projector says, in answer to the question, "From whence are the tenants to come?" "Not many centuries will pass away before it will not only be completely filled, but that another one will be required."

No public improvement is more wanted than the removal, in Britain, of burial places from the cities to the country. We would turn all the churchyards in London into flower-markets, and all those in the country towns into public gardens. For London we would establish two or three burial-grounds, of some hundreds of acres each, a few miles in the country, on the poorest soil, and planted as an arboretum, according to the natural system. But even this we do not think adequate to the wants of an increasing population. We would pass a law, rendering it legal, under certain regulations, for every man who had land, either in perpetuity or for a certain number of years, to be buried in his own grounds in any manner he chose. We would allow every cottager to make use of his own garden, and every farmer of his own farm, if they chose to do so; always, of course, smoothing the way for such an innovation by taking care of existing interests in the rites of burial. The idea of closing up dead bodies in sepulchres is to us disgusting, and crowded churchyards, which, have been used for centuries, little less. After death, the sooner we are resolved into our primitive elements the better. It is surely a purer and more noble idea, to contemplate the union of our bodies to the whole of nature, than their separated existence in a musty wooden box, or in a mass of putrid mould.

*Dammara orientalis* Lamb., the *A'gathis loranthifolia* of Salisb. — I have succeeded in striking cuttings of this plant, by keeping them in a gentle

bottom-heat and a moist atmosphere. *Pinus spectabilis* of Nepal, I have also rooted in the same manner. — *W. B. Dropmore, Aug. 29. 1828.*

*The Agapanthus umbellatus*, once considered a stove-plant, has stood the severity of the winter here for several years, with a slight protection during hard frosts; and, at this time (Aug. 28.), is in the highest perfection in the flower-garden. — *Alexander Gordon. Appley Castle, Wellington, Salop.*

*A Horticultural Impostor at Sheffield.* — A fellow has been cheating people here, by selling what he described as tree-tulips, growing the usual size of common tulips, but which produce many flowers on one stem, and some of them of different colours. This impostor called on me, in August, 1828. He said he received them from a brother residing in South America; that he was the under-gardener in Lord Fitzwilliam's botanic garden at Wentworth House, near Sheffield; he said they had bloomed them in great perfection at that place last year. Knowing the gardeners at that place to be truly respectable, I, along with many other gentlemen, purchased some of each kind. My gardener planted some of them in pots, and placed them in the forcing-house; others in a cold green-house; and some out of doors; some are about six inches in height. I have been looking for the side-branches, but in vain. One he calls the Eye of the Mountain; there is also the Pride of the Valley, but, he observed, the Rose of the Valley surpassed all, it had so fragrant a perfume.

He appeared about 6 ft. in height, about 45 or 50 years of age. I took him into my stove; he appeared to be well acquainted with the names of most of the plants, was dressed like an under-gardener, and talked much of their last new plants at Wentworth House. I fancy he reaped a plentiful harvest in this neighbourhood; was here on the first day of August, 1828, and, some days afterwards. As he mentioned to me correctly the name of the head-gardener there, as well as the name of the gardener in the botanic garden, under whom he said he worked, I, as well as my neighbours, had no doubt of the man's respectability. As people do not like to subject themselves to the laughter of their friends, for their gullibility, I shall subscribe myself only — *M. P. Sheffield, Feb. 26. 1829.*

## SCOTLAND.

*Caledonian Gardeners' Society.*—At the last Annual Meeting of this useful Institution, held on January 27., Mr. Daniel Sinclair, gardener, Broughton Hall, was elected President; Mr. John Notman, slater, Broughton, Treasurer; James Gardner and Henry Cribes, Key-keepers; Mr. John Hay, fruiterer, Prince's Street, Secretary; and E. D. Allison, M.D. Northumberland Street, Consulting Surgeon. Prizes were awarded to the successful competitors in articles of horticulture, produced in 1828, as follows:—Pinks (best six): 1. Mr. John Young, gardener to — Oliver, Esq., Newington; 2. Mr. John Reid, nurseryman, Easter Road. Peaches, Nectarines, and Apricots: Mr. Thomas Inglis, gardener to the Hon. Mrs. Ramsay of Barnton. Red Cabbage: 1. Mr. Thomas Leddle, gardener, Warriston; 2. Mr. David Stewart, gardener, Inch. Parsneps: 1. Mr. Daniel Sinclair, gardener, Broughton Hall; 2. Mr. Thomas Leddle, Warriston. Celery: 1. Mr. David Stewart, Inch; 2. Mr. Daniel Sinclair, Broughton Hall. Ribston Pippins, Golden Pippins, Balgone Pippins, and Nonpareils: 1. Mr. John Macqueen, gardener, Bonnington; 2. Mr. John Williamson, gardener, Canon Mills Cottage. (*Scotsman*, Jan. 28. 1829.)

*The Aberdeenshire Horticultural Society* held their Anniversary Meeting March 10. The articles exhibited are not enumerated in the account sent us, but the regular office-bearers were elected, and the conductor of the Gardener's Magazine nominated an honorary member, for which he returns his best thanks.

*Two new Strawberries*, raised from seed by Alexander Malcolm, gardener at Damside of Gilcolmston, near Aberdeen, and for which Mr. Malcolm received the silver medal from the Aberdeenshire Horticultural Society, are now on sale by the seedsmen in Aberdeen. (*Aberdeen Journal*, March 18.)

#### IRELAND.

*Mr. Drummond, of the Cork Botanic Garden*, has gone to the settlement on the Swan River, in Australasia. We hope he will frequently let us hear from him. — *Cond.*

*An Influx of British Capital and Skill* will, we have no doubt, soon take place to Ireland, and, in less than half a century, change the face of the country and the character of the people. There could not be a better time than the present for a capitalist to purchase land in Ireland, because he will have, almost immediately, a rise in its market-value; and, in a few years, from the introduction of improved agricultural practices, an addition to its real value; that is, to the useful articles which it is capable of producing. Various manufactories might, doubtless, be conducted in Ireland at less expense than in England, from the low rates of labour. The first and grand principle of permanent amelioration is, to introduce and spread every where, and apply to every male and female child, a thorough general education. If this be not done, an influx of British skill and capital will give employment and prosperity for a year or two, but will end in producing greater misery than ever.

*Growth of Tobacco.* — It was known to few (even commercial men) that tobacco is extensively planted in Ireland; but there is no doubt of a quantity having been grown and saved last year, on which the crown did not receive one farthing of duty, but which, if foreign and imported, would have yielded 140,000*l.* to the revenue. No duty is attachable to Irish-grown tobacco; but there are great doubts as to its legality of sale, and therefore, it is conveyed under covered permits. The growth is absolutely interdicted in England. Now, that the prohibitory laws are no longer necessary, it becomes of immense importance to institute enquiry, whether all the tobacco used in Great Britain may not be obtained in Ireland, without giving a preference to our rivals in the United States of America? We have before said, that the growth in Ireland, last year, was, as to revenue, to the value of 140,000*l.*; and we are informed, that so profitable is its cultivation, that, in a very short period, a quantity to the extent of 700,000*l.* revenue (or rather sacrifice of revenue) will be raised in one year. (*Liverpool Chronicle.*)

---

#### ART. III. *Horticultural Society and Garden.*

NOVEMBER 18. 1828.—*Exhibited.* Plants in flower of *Cactus truncata*, from the Comte. de Vandes, F.H.S. A white Spanish Onion weighing upwards of a pound, and specimens of the Orange Apple, from Mr. William Wilkins, F.H.S. Montserrat Pine-apple, from T. A. Knight, Esq. F.R.S. &c., President. Old black Jamaica Pine-apple, from Mr. Henry Burn, F.H.S. Kiss-king Apples, from Dr. Camell, of Bungay, in Suffolk. Passe Colmar Pear, from Lord Farnborough, F.H.S. Black Auchan Pear, from Mr. Alexander Stewart, F.H.S. Swan's Egg Pear, from Mr. John Maher, F.H.S. Pound Pear, from Joseph Cox Cox, Esq. F.H.S.

*From the Garden.* Twenty-six sorts of *Chrysanthemums* in pots, thirteen sorts of Apples, and seven sorts of Pears.

*December, 2. 1828. — Read.* Upon a mode of covering the naked branches of Fruit Trees with new wood; by S. S. Street, Esq., of Penryn, Cornwall.

*Exhibited.* Onions from Morocco, from Sadi Ombark Benbey. Fruit of Shoo Shoo, a Brazilian cucurbitaceous plant from Madeira, and five sorts of Apples, from Madeira, sent by Henry Veitch, Esq. C.M.H.S. Purple Cape Broccoli, and fifty sorts of Apples, from Mr. James Dann, gardener to the Earl Cornwallis, at Linton Place, Kent. Flowers of Chrysanthemums, from Mr. William Craggs, gardener to Sir Thomas Dyke Acland, Bart. Four sorts of Apples, from Mr. John Robertson, F.H.S. Summer Queening Apple, from Mr. George Fulton, of Northwick Park. Specimens of an Apple unnamed, from Mr. John Hislop, C.M.H.S.

*From the Garden.* Flowers of fifteen sorts of Chrysanthemums; fruit of *Passiflora quadrangulâris*; flowers of Poppy Anemones; twenty-three sorts of Apples; and Passe Colmar, Bezi d'Héri and Bezi de Montigny Pears.

*December 16. 1828. — Read.* Upon a mode of conveying bottom heat to Pine Beds; in a Letter to the Secretary, by Edward Gattey, Esq. F.H.S.

*Exhibited.* King Dates, from Morocco, from Sadi Ombark Benbey. Pine-apple unnamed, Winter Poplin Pear and Winter Pomeroy Apple, from John Rigden Neame, Esq. F.H.S. Royal Providence Pine-apple, from Mr. John Hislop, C.M.H.S. Uvedale's St. Germaine Pear, from William Bennet, Esq. F.H.S. Cumberen Apple, from Mr. Andrew Morton, of Walberton House.

*From the Garden.* Spanish Cardoons, Cardoon of Tours, Red Cardoon and Celeriac; flowers of *Chimonanthus frâgrans*, *Chimonanthus grandiflôrus*, Single Poppy Anemones, and four sorts of Chrysanthemums; Bequêne musqué, Pastoral, and Franc-Réal d'Hiver Pears; and twenty sorts of Apples.

*January 6. 1829. — Read.* An account and description of the species and most remarkable varieties of Spring Crocuses cultivated in the garden of the Horticultural Society; by Joseph Sabine, Esq. F.R.S. &c.

*Distributed.* Bishop's Early Dwarf Pea and Studley Carrot, from Mr. William Malcolm, F.H.S. Oignon pyriform, from M. Vilmorin, of Paris.

*Exhibited.* Yams from Fernando Po, from Captain William Owen, F.H.S. Lambert's large Nut preserved to be two years' old, from Aylmer B. Lambert, Esq. F.H.S. An Onion grown in Portugal, 25 inches in circumference and weighing 57 ounces, from Mr. Bell of Billiter Street. Gloux Morceaux and Passe Colmar Pears, from Andrew Arcedeckne, Esq. F.H.S. Specimens of five sorts of Seedling Apples, from Mr. Charles Harrison, F.H.S.

*From the Garden.* — Flowers of *Chimonanthus frâgrans*, Poppy Anemones; large White Potatoes forced in boxes; three sorts of Succory; Asparagus forced in beds in the open ground, and Asparagus forced in frames; Elford Rhubarb, Enville Pine-apple, King Pine-apple, four sorts of Pears, and thirty sorts of Apples.

*January 20. 1829. — Seeds distributed.* Persil très nain frisé, Céleri Turc and Pois ridé tardif, from M. Vilmorin, of Paris.

*Exhibited.* A flower of *Caméllia anemoneflôra álba*, from Messrs. Chandler and Sons.

*From the Garden.* Blotched-leaved Succory, Italian Succory, Common Succory, Variegated Kail, four sorts of Pears, seventeen sorts of Apples, and Chinese Quinces.

*Feb. 3. — Read.* Upon restoring Vines, by the application of cold water; by Mr. Andrew Mosman, gardener to P. S. Miles, Esq. An account of some varieties of the Apple, cultivated in the garden of the Horticultural Society; by Mr. Robert Thompson, under-gardener in the fruit department.

*Distributed.* Seeds of *Gilia capitata*, from the garden. Early May Sugar Pea, from Messrs. Schertzer. Brussels Sprouts, and Early Dwarf Savoy, from Messrs. Booth, of Hamburg.

*Exhibited.* Two sorts of Grapes, from John Wynn Griffiths, Esq. F.H.S. Cone of *Araucaria chilensis*, preserved in spirits, from Christopher Richard Nugent, Esq. C.M.H.S.

*Also, from the Garden of the Society.* Three sorts of Pears, three sorts of Succory, large White Potatoes forced in boxes, Elford Rhubarb, and twenty-five sorts of Apples.

*Feb. 17. — Read.* Upon training Fruit Trees; by Mr. John Mearns, F.H.S. General Hints on the formation of a Garden; by Mr. John Ashworth.

*Distributed.* Seeds of *Collomia grandiflora*, from the garden; Wellington Cabbage, from Mr. William Malcolm; and White Belvidere Broccoli, from Mr. William Wilkins. Cuttings of Gloux Morceaux Pear, Passe Colmar Pear, Golden Drop Plum, Black Tartarian Cherry, Belle de Choisy Cherry, and Golden Harvey Apple, from the garden of the Society.

*Exhibited.* Woollen Netting, from Messrs. Hadden and Sons, of No. 2. Bow Church Yard. New White and Old White *Primula sinensis*, from the Comte de Vandes. Pear unnamed, from Edmund Woods, Esq. F.H.S. Lemons, from the Rev. Charles Annesley, F.H.S.

*Also, from the Garden of the Society.* A plant in flower of *Azalea indica phœnicea*; a plant in flower of *Amaryllis hybrida*, between *Johnsoni* and *psittacina*; Elford Rhubarb, Asparagus forced in the open ground, three sorts of Succory, three sorts of Pears, and fifteen sorts of Apples.

*March 5. — Distributed.* Seeds of *Agératum mexicanum*, from the garden. Combretum of Russie et Pois ridé hâti, from M. Vilmorin. Cuttings of Dutch Mignonne Apple, Washington Plum, and Elton Cherry, from the garden.

*Exhibited.* A plant in flower of *Amaryllis Johnsoni*, from John Almitt, Esq. Specimens of a Seedling Apple, from Mr. Dawson of Tay Bank, near Perth.

*Also, from the Garden of the Society.* Blotched-leaved, Italian, and Common Succory, Ox Noble Potatoes forced in boxes, Elford Rhubarb, *Bellisime d'hiver*, and Belle fleur Pears, and twenty-one sorts of Apples.

*March 17. — Read.* An account of some Pears cultivated in Jersey; by Mr. Bernard Saunders, nurseryman, St. Heliers, Jersey. On the cultivation of Asparagus in the open ground; by Mr. Thomas Munday, of Kensington.

*Distributed.* Seeds of *Coreopsis tinctoria*, from the garden of the Society. Altringham Carrot, from Mr. William Malcolm; Laitue meterelle and Cardon d'Espagne, from M. Vilmorin; and *Platanus orientalis*, from John Hawkins, Esq. Cuttings of Winter Poplin Pear, from John Rigden Neame, Esq. Northwick Pippin, from Mr. George Fulton. Marie Louise Pear, Doyenné Blanc Pear, Court of Wick Apple, and Cornish July-flower Apple, from the garden of the Society.

*Exhibited.* Woollen Netting, 2 yards wide, at 1s. 6d. per yard, or 9d. the square yard, manufactured by Mr. William Hudson, of Yeadon, near Leeds, and sold at 58. Basinghall Street. Plants in flower of the White and Purple-fringed *Primula sinensis*, from the Rev. George Reading Leathe, F.H.S. Flowers of *Camellia reticulata*, and Captain Wellbank's Camellia, from Thomas Carey Palmer, Esq. F.H.S. Plants in flower of eight sorts of Camellias, from Messrs. Chandler and Son. Three plants in flower of the White-fringed *Primula sinensis*, from the Comte de Vandes, F.H.S. Hardenpont Pears, and Golden Harvey Apples, from Thomas Hunt, Esq. F.H.S. White Cockle Pippins, and an Apple unnamed, from Sir John Trevelyan, Bart. F.H.S.; and an Apple unnamed, from Mr. James Young, F.H.S.

*Also, from the Garden of the Society.* Nineteen sorts of Apples.

## ART. IV. Covent Garden Market.

## PRICES FOR THE FIRST AND SECOND WEEKS OF MARCH.

	From		To			From		To	
	£	s. d.	£	s. d.		£	s. d.	£	s. d.
<i>The Cabbage Tribe.</i>									
Cabbage, Red, per dozen	0	0	6	0	0	0	6	0	0
Cabbage Plants, or Cole-worts, per dozen	0	2	6	0	4	0	0	4	0
Savoy's, per dozen	0	1	0	0	2	0	0	2	0
Brussels Sprouts, per $\frac{1}{2}$ sieve	0	1	6	0	0	1	6	0	0
German Greens or Kale, per dozen	0	0	9	0	1	0	0	1	0
Broccoli, White, per bunch	0	1	0	0	3	0	0	1	0
Broccoli, Green, per bunch	0	1	0	0	1	6	0	0	1
Broccoli, Purple, per bunch	0	0	9	0	1	6	0	0	1
Broccoli, Cape, per bunch	0	0	9	0	2	0	0	0	2
Late Turnip tops, per bushel	0	1	0	0	1	3	0	0	1
<i>Legumes.</i>									
Kidneybeans (forced), p. hd.	0	3	0	0	4	0	0	4	0
<i>Tubers and Roots.</i>									
Potatoes, - } per ton	3	15	0	5	0	0	0	0	0
Potatoes, - } per cwt.	0	4	0	0	6	0	0	6	0
Potatoes, - } per bush.	0	2	0	0	3	0	0	3	0
Potatoes, Kidney, per bushel	0	2	6	0	3	6	0	2	6
Potatoes, Scotch, per bushel	0	2	0	0	2	6	0	2	6
Potatoes, New, per pound	0	3	0	0	5	0	0	3	0
Jerusalem Art. - } per $\frac{1}{2}$ sieve	0	1	6	0	2	0	0	1	6
tichokes - } per dozen	0	0	6	0	0	9	0	0	9
Turnips, White, per bunch	0	0	1	0	2	0	0	0	2
Carrots, Old, per bunch	0	0	2	0	5	0	0	0	2
Parsneps, per dozen	0	0	9	0	1	3	0	0	0
Red Beet, per dozen	0	1	0	0	2	0	0	1	0
Skirret, per bunch	0	1	3	0	2	0	0	1	3
Scorzoner, per bundle	0	1	0	0	1	6	0	1	0
Salsify, per bunch	0	1	0	0	1	6	0	1	0
Horseradish, per bundle	0	1	6	0	3	6	0	1	6
Radishes, Red, per half doz. hands (24 each)	0	1	9	0	2	3	0	1	9
<i>The Spinach Tribe.</i>									
Spinach, } per sieve	0	1	6	0	2	6	0	1	6
Spinach, } per half sieve	0	1	0	0	1	3	0	1	0
Sorrel, per half sieve	0	1	6	0	2	0	0	1	6
<i>The Onion Tribe.</i>									
Onions, Old, per bushel	0	4	6	0	6	0	0	4	6
Onions, Pickling, p. $\frac{1}{2}$ sieve	0	3	6	0	5	0	0	3	6
Onions, when green (Ciboules), per bunch	0	0	2	0	0	3	0	0	2
Leeks, per dozen bunches	0	0	9	0	1	3	0	0	9
Chives, per dozen roots	0	0	2	0	0	3	0	0	2
Garlic, per pound	0	0	8	0	0	10	0	0	8
Shallots, per pound	0	0	8	0	1	0	0	0	8
<i>Asparagus Plants, Salads, &amp;c.</i>									
Asparagus, per hundred	0	2	6	0	10	0	0	2	6
Sea-kale, per punnet	0	1	6	0	3	6	0	1	6
Lettuce, Coss (small), p. sc.	0	0	6	0	1	0	0	0	6
Lettuce, Cabbage, per score	0	0	4	0	0	6	0	0	4
Endive, per score	0	0	2	0	0	3	0	0	2
Celery, per bundle (12 to 15)	0	0	9	0	2	6	0	0	9
Small Salads, } per $\frac{1}{2}$ sieve	0	1	6	0	2	6	0	1	6
Small Salads, } per punnet	0	0	2	0	0	3	0	0	2
Watercress, per dozen, small bunches	0	0	6	0	0	8	0	0	6
<i>Pot and Sweet Herbs.</i>									
Parsley, per half sieve	0	7	6	0	9	0	0	7	6
Tarragon (forced), p. bunch	0	0	6	0	0	9	0	0	6
Purslain, per punnet	0	2	0	0	2	6	0	2	0
Fennel, per dozen bunches	0	4	0	0	6	0	0	4	0
Thyme, per dozen bunches	0	2	0	0	2	0	0	2	0
Sage, per dozen bunches	0	2	0	0	2	0	0	2	0
Dried Mint, per doz. bun.	0	1	0	0	1	0	0	1	0
Marjoram, per doz. bunches	0	0	10	0	1	3	0	0	10
Savory, per dozen bunches	0	0	10	0	1	0	0	0	10
Basil, per dozen bunches	0	1	4	0	1	6	0	1	4
Rosemary, per doz. bunches	0	3	0	0	3	0	0	3	0
Tansy, per dozen bunches	0	1	0	0	1	0	0	1	0
<i>Stalks and Fruits for Tarts, Pickling, &amp;c.</i>									
Rhubarb Stalks, per bundle	0	1	6	0	2	0	0	1	6
<i>Edible Fungi and Fuci.</i>									
Mushrooms, per pottle	0	1	0	0	1	6	0	1	0
Dried Morels, per score	0	14	0	0	16	0	0	14	0
Truffles, English, per pound	0	5	0	0	5	0	0	5	0
Dried Truffles, Foreign, per pound	0	16	0	1	0	0	0	16	0
<i>Fruits.</i>									
Apples, Dessert, per bushel	0	15	0	0	18	0	0	15	0
Reinette Grise	0	15	0	0	18	0	0	15	0
Nonpareils	0	18	0	1	10	0	0	18	0
Apples, Baking, per bushel	0	9	0	0	14	0	0	9	0
Apples, American, per bus.	0	18	0	1	10	0	0	18	0
Apples, French, per bushel	0	5	0	0	9	0	0	5	0
Royals	0	5	0	0	9	0	0	5	0
French Crabs	0	8	0	0	12	0	0	8	0
Pears, Dessert, per dozen	0	3	0	0	8	0	0	3	0
Bon Chrétien	0	3	0	0	8	0	0	3	0
Rougelette	0	4	0	0	4	0	0	4	0
Pears, Baking, per dozen	0	6	0	0	6	0	0	6	0
Cardillac	0	6	0	0	6	0	0	6	0
Cranberries, per gallon	0	2	6	0	4	0	0	2	6
Strawberries (forced), p. oz.	0	2	0	0	3	6	0	2	0
Walnuts, per bushel	0	14	0	0	18	0	0	14	0
Chestnuts, French, per peck	0	4	0	0	10	0	0	4	0
Nuts, Spanish, per peck	0	5	0	0	6	0	0	5	0
Nuts, Barcelona, per peck	0	5	0	0	6	0	0	5	0
Pine-apples, per pound	0	5	0	0	15	0	0	5	0
Hot-house Grapes, p. pound	0	2	0	0	2	0	0	2	0
Portugal Grapes, per pound	0	1	6	0	2	6	0	1	6
Cucumbers, Frame, p. brace	0	8	0	0	14	0	0	8	0
Oranges, } per dozen	0	6	0	0	2	6	0	6	0
Oranges, } per hundred	0	3	6	0	16	0	0	3	6
Bitter Oranges, per hundred	0	6	0	0	18	0	0	6	0
Lemons, } per dozen	0	6	0	0	2	0	0	6	0
Lemons, } per hundred	0	6	0	0	14	0	0	6	0
Olives, per dozen pint bottles	0	2	0	0	10	0	0	2	0
Sweet Almonds, per pound	0	2	6	0	3	0	0	2	6
Brazil Nuts, per bushel	0	6	0	1	0	0	0	6	0
Garden Snails, per quart	0	0	6	0	0	8	0	0	6

*Observations.* — The prevalence of severe frost in the latter part of February, rendered the supply of vegetables very precarious, and prices, consequently, fluctuating; but, since that time, the markets have been steady in supply and price. The continuance of cold winds and frosty nights will, of course, preclude the supply of spring vegetables, for some time, in any abundance, from which may be expected an increase of prices. The stock of English fruits is nearly exhausted, and the market is, necessarily, furnished with foreign, which continues to arrive in good condition, and tolerable abundance. — *C. March 14. 1829.*

ART. V. *The London Nurseries.*

I HAVE not yet been able to extend my walks beyond the limits of the London nurseries, which do not present any thing very striking or novel. The display of forced flowers at Colville's is extremely brilliant, embracing hyacinths, narcissuses, jonquils, and other bulbous roots; with an extensive assortment of *Amaryllideæ*, seedling varieties, exhibiting all the diversified shades of colours and habit to be found in the parent stocks from which they have been procured. At Mr. Knight's a most beautiful plant of *Rhododéndron arbóreum* is in fine flower; the three varieties of this interesting species now well known in this country, exhibit a sportiveness in nature which our hybridising cultivators are attempting to imitate, with what success time alone can determine. The ingenious theory of a worthy friend of ours, that nature is constantly producing new genera and species by the intermixture of those already existing, is in a great measure warranted by the productions of our gardens, which exhibit to the eye of the most experienced botanist, forms with which he has hitherto only been made acquainted by the introduction of plants from abroad, and which have been already distinguished as new species. How far the dogmas of certain learned persons, that these mules, like other mules in animal nature, will be incapable of reproduction except by closely allied affinities, are defeated by our present practice of increase, we can only judge by careful attention to the present state of our collections. In these we have rhododendrons, azaleas, kalmias, &c., so intimately blended in every possible shape and feature, that it is already difficult to distinguish seedling varieties from well-established species, and I may affirm the same thing of the hybrid productions from *Amaryllis*, *Nerine*, &c., obtained by the Hon. & Rev. W. Herbert, of Spofforth, and so ably illustrated by him in his work on the subject. At Dennis's, *Leucòjum vérum* is in fine bloom, with *Scilla præcox*, both of them now rather rare plants. *Scilla bifolia*, a common but interesting plant, is also in fine flower. Some fine plants of *Bérberis Aquifolium*, (*Mahonia* of De Candolle), which have hitherto been scarce in the country, have been recently imported from America; and I hope to see this fine plant, in a short time, with its congeners, an ornament to our suburban gardens. The new *cyripediums* from Dr. Fischer, sent to the valuable collection of R. Barclay, Esq., are likely to bloom, and add to the splendour of that fine botanical establishment, of the additions and improvements to which, under the care of its present able curator, Mr. Cameron, I hope from time to time to be able to furnish you with accounts. — C. *March* 14, 1829.

ART. VI. *Provincial Horticultural Societies.*

## YORKSHIRE.

*FLORAL and Horticultural Society of Hull.* — This Society held its Annual Meeting on Feb. 11. The Secretary read the report of the Committee for the last year, which was encouraging, and stated a considerable increase of members, and a balance of some pounds in the hands of the treasurer. A motion of thanks was passed to Messrs. Tindall, of Beverley, for transferring the money, awarded to them as prizes, to the funds of the Society; and another to the Committee of the Botanic Garden, for allowing the curator of that institution to furnish evergreens, &c., wherewith to ornament the show-room. The list of notices for motions, involving new regulations, was a very long one, and produced a protracted discussion; out of which it may fairly be presumed that several valuable suggestions for future

management arose. It was determined that apples should be shown for prizes, and also early potatoes grown in the open air. On the motion of Mr. Rees Davies, the annual subscription was raised to 7s. 6d., with the ulterior view of making the prizes more valuable, and increasing the stimulus to emulation in cultivation. The Society now consists of 150 members, having increased yearly in rapid progression; and favourable anticipations are entertained that the exhibitions this year will be of a superior character. The new Committee consists of the following gentlemen:—The Rev. G. Lee, President; Messrs. Woolley, Davies, Deighton, Smithson, Oglesby, Brown, Wharton, Bell, Norman, Beecroft, and Heward. (*Hull Advertiser*, Feb. 20. 1829.)

*Botanic Garden.*—Mr. Smith, the curator of this Institution, has received from T. W. Gleadow, Esq., fourteen species of seeds from Van Dieman's Land, which we undertsand to have been collected by that gentleman's brother. Dr. Blundell has also presented to the garden 114 species of exotic seeds, procured from his friends on the Continent, when on a tour last autumn. Many of the seeds are new to the garden, and are of a rare description. (*Hull Advertiser*, Feb. 20. 1829.)

#### NORTHUMBERLAND AND DURHAM.

The *Botanical and Horticultural Society* held a General Meeting on Feb. 20., when the following prizes were awarded:—The Society's silver medals; for the best dish of dessert apples, to Mr. Thomas Watson, gardener to R. L. Allgood, Esq., Nunwick; for the best seedling apple, to Mr. Robert Turnbull, gardener to the Rev. J. S. Ogle, Kirkley Hall (this apple was raised from the Old Nonpareil, and was named by Mr. Turnbull the Kirkley Pippin: Mr. Turnbull also gained two bronze medals, for the best dish of Brussels sprouts, and the best dish of sea-kale); for the best seedling baking apple, to Mr. Thomas Moore, gardener to James Losh, Esq., Jesmond, which he called Moore's Pippin; for the best twenty-five heads of asparagus, to Mr. Christopher Robson, gardener to T. E. Headlam, Esq., Jesmond Dean; for the best double hyacinth (Grande Monarque de France), and for the best single hyacinth (Prince de Galitzin), to Mr. Adam Hogg, at Messrs. Falla and Co.'s, Gateshead. For the best twelve roots of Black Spanish radishes, the bronze medal, and for the best bouquet of flowers, the silver medal, to Mr. James Scott, gardener to Edward Charlton, Esq., Sandoe. For the best exotic plant in flower, *Camellia japonica* var. *pæoniæ-flora*, the silver medal, to Mr. Johnson Trotter, gardener to David Cram, Esq., Newcastle. Several splendid specimens of *Amarýllis reginæ* and *Amarýllis Johnsoni* were exhibited, from the garden of James G. Clarke, Esq., Fenham. Five plants, in full blossom, of *Alstræmèria Ligtù* and *Lachenàlia tricolor*, from the garden of Matthew Bell, Esq., Woosington; and two fine specimens of *Corræa speciosa*, by Mr. Adam Hogg, at Messrs. Falla and Co.'s, Gateshead. Some White Rettiche roots, a gigantic and coarse variety of radish, of Russian origin, from the garden of T. E. Headlam, Esq., Jesmond Dean; and a fine root of celeriac, or turnip-rooted celery, from abroad, by Robinson R. Greenwell, Esq., who very liberally distributed some of the seeds to the members present. The quality of every thing exhibited was most excellent. (*Newcastle Courant*, Feb. 21. 1829.)

At a Meeting of the *Botanical and Horticultural Society of Hexham*, held for the exhibition of fruits and vegetables, the prizes were adjudged as follows:—For the best dish of dessert apples, and the best dish of dessert pears, to Mr. George Robson, gardener to N. Clayton, Esq., Chesters; for the best dish of baking apples, and the best four cauliflowers, to Mr. William Grey, gardener to Thomas James, Esq., Beaufront; for the best four Brussels sprouts, to Mr. James Scott, gardener to Edward Charlton, Esq., Sandoe; for the best four roots of red beet, to Mr. Robert Grey, gardener, Humshaugh. Mr. James Scott, of Sandoe, introduced a fine specimen of



Mr. Phillips's Vauxhall American apple, of an immense size: the trees were brought to the north by Robert Charlton, gardener, Wall. (*Newcastle Courant*, Nov. 22.)

---

ART. VII. *The Gardens of the Pantheon, or Colosseum, Regent's Park.*

IN a former Volume (I. p. 351.) we noticed the extraordinary exertions, in the way of transplanting large shrubs, then going on at this undertaking, and we would have continued our notices from time to time, if we could have done so without offending an amiable and most ingenious individual, and affecting his pecuniary interests and those of other parties concerned. As the whole is now in the hands of the public creditors, we do not feel the same delicacy in stating our opinion, the more especially because we think the facts of this case are calculated to convey a useful lesson to the public.

The radical cause of failure is easily traced to what may be called the besetting sin of English schemers, that of overdoing the means — studying the machinery more than the manufacture; and a second cause, to the ungovernable fancy and want of fixed plan in the director or direction. How any class of men could advance money to be thrown away in the manner it has been at this Colosseum during the last two years, in doing and undoing, can only be accounted for from the circumstance of the public having been carefully excluded, and thus opinions as to what was going on prevented from being disseminated by the press. Puffs at great length, evidently written by interested parties, were also from time to time sent to the newspapers, and published, which tended to keep up the delusion.

The idea of building a structure at the expense of say forty or fifty thousand pounds, for the purpose of exhibiting a painting which could be produced for say five or seven thousand pounds, could not be considered as originated with a view to profit, by any reflecting person; because it was open to the competition of a similar panoramic view which might be painted for a similar amount, and exhibited in a wooden building, in all respects but that of durability, as fitting for the purpose as the Colosseum, which might have been erected for say three thousand pounds. This application of the common principles of trade, to what, at most, can only be called a rather uncommon manufacture, would immediately have directed the prudent and profitable course. With respect to the value of a durable building for this and similar purposes, the great fluctuations of fashion in this rich commercial country show that value not to be great; it is at any rate never of much value in shops and manufactories.

The idea of forming gardens round the Colosseum may be good or bad; we shall not stop to enquire; but the design and taste of such a garden as has been erected there, we do not hesitate to say, have scarcely any thing to do with good sense; and the notion that such plants as have been planted could be maintained in health for more than two or three years, we will venture to say, never entered into the mind of a practical gardener. In this garden, of not more than an acre in extent, a part of the design was to shut out the surrounding houses, and another part was to assemble all the botanical rarities and remarkable plants, to be purchased in the neighbourhood of London. The first object, though attempted by planting trees in boxes, elevated on posts 20 and 30 ft. high, by artificial trees painted green, and by other contrivances more unsightly than the objects to be shut out, was found to be impracticable; the second object has been attempted at a cost at which no probable receipts will ever pay half the interest, not to mention

the annual expense of cultivation and management, and the certainty that the confined and smoky air of the situation will in a year or two destroy most of the species. We say nothing of the wild schemes of waterfalls, breakfasting-rooms, a library, and a Swiss cottage, excepting that we never before heard of or saw such a mad and ungovernable exercise of fancy, so much doing and undoing, and such an utter regardlessness of expense.

The lesson to be learned from the Colosseum is, that, in regard to all works of importance by public companies, these companies would be benefited by allowing the public a full and free opportunity of criticism. An opportunity should be afforded for criticising the design of every public work before it is commenced, by exhibiting the proposed plans and descriptions, and by inviting remarks on them. Indeed, before any great public work is commenced, a free competition should be allowed among artists for the plan, and then the plan made choice of should be submitted to public criticism. When the plan is decided on and the work commenced, the public should also be admitted to inspect and criticise it as it goes on. This mode of conducting public works would be much safer for the proprietors; and the public, and more especially the press, would soon acquire both a knowledge and taste, which would increase their usefulness in this description of criticism. There is, in short, no safety for public works, but in the public press; and, had this principle been acted on, we should not now have so many architectural productions unworthy of the present day, nor the garden of the Horticultural Society, those connected with Buckingham Palace, that at the bottom of Park Lane, nor that of the Colosseum. — *Cond.*

---

#### ART. VIII. *General Education.*

If any arguments were wanting, in addition to those we have from time to time advanced, to show the importance, and even the necessity, of meeting the wants of the times by a general diffusion of education, the most powerful that could be desired might be drawn from the late expressions of public opinion on the subject of Catholic emancipation. There is evidently an immense mass of utter ignorance and darkness among the lower classes of the people of the three kingdoms, and there is as evidently a disposition in a portion of the higher classes to render this mass subservient to their views, without much reference to public peace or prosperity. How are the evils, that might in this way be produced, to be prevented? Either by an immense standing army, to be made use of by Government to check the expression of party opinion, or by enlightening all classes, as near as practicable, to an equal degree, so as that public opinion might be all on one side. With respect to the influence of a standing army in suppressing public opinion, Ireland, and what has taken place there, may be referred to, both as a proof of its insufficiency, and of its great expense. The habits of a professional common soldier are by no means calculated to unite him in views and interest with the fixed domestic population; but, with the progress of things, even common professional soldiers become more and more men: they will only act at present up to a certain point, and the time will come when they will only act from opinion. The great object, then, of all who have the good of their country and of mankind at heart, ought to be to raise opinion to one high and enlightened level, by the universal diffusion of knowledge and education, and by its especial diffusion among the lower classes of Britain.

It is by a *regular education* and a systematic discipline, alone, that men can be taught to produce effects according to fixed principles, and not by

hazard, in committing every thing to fortune, and working in the dark. A defective and ill-arranged education is apt to generate the vices of irregularity, want of method, and indolence, instead of their opposite virtues: order springs from order, as certainly as each kind propagates its kind. (*Ed. Rev.*, Sept. 1828, p. 70.)

Very few gardeners have had a regular education to the extent which is here contemplated: it behoves them, therefore, to make up for the deficiency by a regular course of self-instruction at their leisure hours, beginning with the lesser things, and ascending to the greater (*Encyc. of Gard.*, part iv. book ii. chap. ii.); and, above all things, taking care that they are thoroughly educated in their profession, and in moral conduct and manners.

*The Mental Improvement of the great Body of the People*, by the Society for the Diffusion of Useful Knowledge. — However well meant the efforts of the Useful Knowledge Society may be, “it is said, they are producing a serious mischief, which will, in no long period of time, alter the face of society. We are far, say those objectors, from urging the old exploded argument; that the common people will cease to work, if you teach them to read or to think, and to take a delight in learning; and from pressing the still more chimerical apprehension, that learning will puff them up, which it assuredly never can do, when it is no distinction. But there are fears of a very different nature, they contend, and which deserve serious attention. The poor will work, and, as regards one another, they will not be elated, because they will rise *equally* in the progress of improvement; but they will fill a new situation as regards their superiors; they will no longer give rank and property their due respect; the distance will be removed, which made it easy to confront them; and the body of the people, being now better informed than the upper classes, as they are incalculably more numerous, the union of physical and moral power must shake the whole order of society, and may destroy its frame entirely. Hence, say these reasoners, although a certain share of knowledge may be both safe and wholesome to the people, it is unnecessary for their sakes, and will prove unsafe for the state, to give them a complete education in matters of science, and other liberal branches of knowledge.

“We admit the inference deduced, if the fact here assumed were correctly stated. The assumption is, that the people are to acquire a liberal education, or improve rapidly, while the upper classes must remain ignorant, and stand still. If this were the case, — if it were necessary that the line should be drawn to exclude the rich from the pale of knowledge, as it must needs be to exclude the mass of the people from that of wealth, — if, in a word, there were any thing to give the body of the people a monopoly of the power which resides in knowledge, as they already have, and must always have, that which resides in numbers, — it is manifest that there would be an end of the present state of society altogether. But this is not only unlike the truth; it is the reverse of the truth; and nothing but a degeneracy and self-abandonment, utterly inconceivable on the part of the upper classes, can ever make it approach to the truth. The easy circumstances in which they are happily placed, give them such an enviable command of their time, that they can always, with hardly any sacrifice, far outstrip, in mental improvement, their less fortunate neighbours. The daily labours of the working classes affix narrow limits to their studies; and although they may well, within these bounds, and without encroaching upon their hours of needful toil or repose, cultivate their faculties, store their minds with knowledge, and elevate their tastes above low pursuits, they can never hope to rise as high in these respects as persons whose time is almost entirely at their own command, and whose wealth gives them a thousand helps to learning.”

After noticing the thirty-four treatises published by the Society up to August, 1828, and comprising a mass of information, nearly equal to that

contained in four thousand octavo pages, for 17s., with numerous original and admirably executed figures, and giving some interesting quotations from the recent historical treatises, the reviewer thus concludes: "Upon these things we fondly dwell. They are worthy of the society. If to teach men the sciences which help them in their ordinary pursuits to better their condition, or afford them innocent recreation, or elevate and improve their minds, be to impart useful knowledge; assuredly it is conferring no less precious a blessing upon the species, *practically* to inculcate those principles, and to cherish those feelings, which, if they prevailed generally, in but a small degree of the intenseness wherewithal they glow in the bosoms of the wise and the good of all sects and all parties, would banish from the earth cruelty and oppression, but chiefly war—the worst enemy of human happiness, and, to every effectual improvement, the insurmountable obstacle." (*Edinburgh Review*, Sept. 1828.)

*The Master-Principle of Pestalozzi*, with respect to the application of knowledge, is, that the poor are our brethren. His great maxim is, that no man, be his station ever so humble, or his life ever so laborious, ought to be without knowledge, nay, without science; and that the pleasures of philosophy are both accessible to all classes, and reconcilable with the habits and hardships of the most hard-working men. (*Ed. Rev.*, Jan. 1828.) Pestalozzi's system of instruction is essentially the same as that of Bell and Lancaster; a system evidently produced by the demands of the age, since it appears to have been invented about the same time by three individuals in different parts of the world, and unknown to each other. Pestalozzi added, or attempted to add, the manual labour of the pupils, partly instead of recreative amusements, and partly with a view to pay the expense of instruction. It appears that his plan has been modified a little in America and found successful; and Dr. Duncan appears to have introduced it in the neighbourhood of London. It seems peculiarly adapted for the children in public asylums and charitable institutions.

*Infant Schools.*—The advantages which infants derive from example, from exercise, amusement, and occupation for the mind and feelings, in the society of each other, under the guidance of a kind teacher, and with something like the privileges and duties of a community, are so numerous and conspicuous, that we shall soon have the nurseries of Moray Place, Charles Square, and Great King Street, converted into infant schools; those who live in large apartments, and qualified governesses, *making interest* to have the children of their less wealthy or less fortunate friends or acquaintances sent to their houses for common instruction. The influence of the sympathy of numbers, in restraining the more dangerous, and strengthening all the better feelings, as well as in agreeably stimulating to the acquisition of knowledge, during infancy especially, is very great. (*Scotsman*, Jan. 17. 1829.)

*Reading, as a means of educating the Feelings*, or forming the taste, should never at any one time be pushed to an extent beyond what is agreeable to the feelings. Science must be dealt with in a different manner. It must be followed out as a task; and the difficulties to be overcome, the labour to be endured, have a salutary effect on the individual subjected to them, not oppressed by them. History should also be read steadily and upon system. (*Ibid.*, Feb. 18. 1829.)

*Paintings and Engravings, as Means of Instruction.*—Painting, were the use of it universal, would be a powerful means of instruction to children and the lower orders; and were all the fine surfaces, which are now plain, and absolutely wasted, enriched with the labours of the art, if they once began to appear, they would accumulate rapidly; and were the ornamented edifices open to all, as freely as they ought to be, a wide field of new and agreeable study would offer itself. A person, who thoroughly understood the well-chosen subjects, and was qualified to explain them to a stranger,

could not be devoid of knowledge, nor could his mind want food for constant contemplation. The sense of beauty has hitherto been little cultivated in Great Britain; but it certainly exists, and shows itself principally in laying out gardens and pleasure-grounds with unrivalled skill. (*Ed. Rev.*, Sept. 1828.)

---

#### ART. IX. *Garden Libraries.*

*THE East Lothian Itinerating Juvenile and Village Libraries.*—The fifth report of this Institution, for 1826 and 1827, affords a most gratifying instance of the good which it continues to do. The mass of society in England is not yet prepared for the establishment of such libraries, but we hope it soon will be; and we hope, also, that we shall soon hear of their establishment in other countries: to North America they appear particularly suitable. It appears, from this report, that similar libraries are already established there, as well as in different counties in Scotland. The following extracts will be read with interest:—

“The object of this institution is to furnish all the towns and villages of the county with libraries of useful books. The books are arranged into divisions of fifty volumes, which are stationed in one place for two years, where they are issued gratuitously to all persons above twelve years of age, who agree to take care of them: after this period they are removed, or exchanged with other divisions.

“The institution is supported by the subscriptions and donations of benevolent individuals, societies, and annual reading subscribers of 3s. and upwards.

“In order to induce the readers at the different stations to promote the reading of the books amongst their neighbours, the manager will in future move the library where there has been the fewest issues of books during the preceding two years, for at least one year.

“As it is always found that the books which have been in stationary libraries for eight or ten years are very little read, the manager of this institution [Mr. Samuel Brown, ironmonger, Haddington] is willing to send out or more divisions to the managers of such, on condition that they allow him to send an equal number of their books to another station; and if this arrangement does not give general satisfaction to their subscribers or readers, he will return their books at the general exchange, on receiving timely notice. The great advantage of such an arrangement will appear from an experiment made in 1821 with a library at North Berwick, consisting of about 185 volumes, where the issues had fallen off to about 20 per annum. Four divisions of the itinerating libraries were exchanged for them, and sent to North Berwick, Kingston, and Fenton; the annual issues from which are now 928. On an average of six years, the annual issues from them have been 863.

“As the county of East Lothian is an agricultural district, an agricultural branch, consisting chiefly of books on rural affairs and implements of husbandry, has been added to this institution; and the books will be kept in Haddington until they cease to be called for there, after which they will be gradually incorporated with the itinerating divisions.

“Annual subscribers of five shillings to this branch, shall be entitled to the use of the new books for the first two years, after which they shall be issued gratuitously to farm servants, grooms, foresters, and smiths and wrights engaged in the construction of implements of husbandry, and others interested in agriculture. Donations from agricultural societies and individuals to this branch shall be wholly employed in the purchase, binding,

and repairs of books on rural affairs, and the expenses incidental to them. And a statement of the intromissions of the manager on account of this branch, shall be regularly laid before the committee of the United Agricultural Society of East Lothian.

“The prison at Haddington, and two Sabbath schools in the neighbourhood, have been supplied, as in former years, from the Haddington divisions: — the sloops *Christian* and *Margaret*, the *Commerce*, the *Expedition*, and the *Countess of Haddington*, have been supplied twice; the *Nancy* four times, and the *Dispatch* five times, with books for the use of their crews when at sea, from the library at North Berwick.

“The issues of the books on agriculture and rural affairs have been considerable. At the general change, in October 1827, a part of this branch was combined with the itinerating divisions; this will bring them more into contact with those who are engaged in agricultural pursuits. The manager regrets, that, in consequence of the smallness of the funds which have been subscribed for this branch, by those more immediately interested in its success, he has not been able to add so many new volumes on these subjects as he could have wished. The *Glasgow Farmer's Register*, and the *London British Farmer's Magazine*, are regularly received and circulated amongst the subscribers; and the *Edinburgh Quarterly Journal of Agriculture*, which is to contain the Prize Essays and Transactions of the Highland Society, will be ordered as soon as published.

“As botany and gardening are intimately connected with agriculture, at the desire of a subscriber to that branch, *Loudon's Gardener's Magazine* has also been procured from its commencement, and will be continued. This publication, besides being circulated amongst the subscribers, will also be lent to the gardeners of any of the ladies and gentlemen who are donors to the institution.

“As a considerable part of the county is still unsupplied with libraries, and, as the issues at some of the present stations have not been so numerous as might have been expected, the manager, at every future exchange, will remove the division at least for one year, from the station where there have been fewest issues during the preceding two years. It is expected that this arrangement will induce the present readers, to endeavour to interest their neighbours in the perusal of the books brought within their reach, by this institution.

“There is no part of the success of the measures pursued in the management of these libraries which has afforded the manager more pleasure, than the great increase of subscribers since he adopted the plan of reserving to them, for some time, the use of the new books.

“The greatest number of annual subscribers before that arrangement was 8. The number of subscribers after that arrangement, in 1822, 64; 1823, 61; 1824, 54; 1825, 99; 1826, 110; 1827, 135.

“It has proved the possibility of rapidly supplying a county with gratuitous libraries at a very small expense to the subscribers; and at the same time giving them and their families access to a great variety of new publications, which appear, from the number of issues, to have been as gratifying to them as they will prove extensively useful to others. In consequence of there being a station for new books at North Berwick, as well as at Haddington, the manager has been enabled to furnish the subscribers with the use of a much greater number of recent publications, by mutual exchange, than could have been procured by any other arrangement.

“The success of the plan of keeping the new books for the use of subscribers, and of having different divisions of them in neighbouring towns, or in different parts of our larger cities, it is hoped, will induce other individuals and societies to adopt it; by such a measure they would promote the improvement of all classes of the community. The books belonging to the East Lothian libraries are read in the families of the first respectability in

the county, and by all classes down to the poorest and most distressed of its inhabitants.

“Every year’s experience convinces the manager of the East Lothian libraries of the necessity of combining gratuitous circulation with the plan of supplying the whole population with libraries, and that confining the use of the books wholly to subscribers, however small the sum required should be, will greatly impede the usefulness of such an institution. Many of the readers are young persons, whose tastes and habits are just forming, and who have no means of paying a subscription without applying to their parents, who may be either unable or unwilling to pay for them. It is, at the same time, to those young persons, and the younger branches of the families of subscribers, we are to look as the future and the best supporters of such institutions. Indeed, they have already proved to be so, to the East Lothian libraries. The Haddington Juvenile Society for the support of Missions, Schools, &c. have, from 1822 to 1827, given five donations, amounting to 19*l.* 12*s.*, and there is reason to hope they will continue to take the same deep interest in an institution which was originally formed for their benefit.

“The manager of the East Lothian libraries returns his warmest thanks to the ladies and gentlemen, and societies, that have supported him in carrying forward an experiment, which, it is not improbable, will ultimately have considerable influence on the state of the world. The principle has already been adopted by various Seamen’s Societies; it is a part of the plans of the Committee of the General Assembly of the Church of Scotland for improving the Highlands, and also of the Inverness Association for promoting Education in the Highlands. A Society was formed in 1826, in Edinburgh, for supplying Mid-Lothian with such libraries. It has been introduced into Ireland, British America, and the United States, and its supporters may reasonably hope that its economy and efficiency will recommend its adoption wherever it is known.” (*The Fifth Report, &c.*, p. 11.)

*Agricultural Libraries.* — You have said a great deal in favour of garden libraries, for which the gardener is more indebted to you than for any thing else that you have done. Could you not add a word in favour of similar establishments for the agricultural class? We have tried it in this neighbourhood, but unsuccessfully, because they were not allowed any share in the management of it, and paid nothing for it. — *A. G. Near Barnsley.*

---

#### ART. X. *Retrospective Criticism.*

*MR. SWEET and a Blooming Bulb.* — Sir, Although I am fully aware that every line of the Gardener’s Magazine is most valuable when treating on subjects of general interest, yet I trust you will allow the insertion of the following comments on Mr. Sweet’s remarks, in your last Number, on the article signed “a blooming bulb.” (Vol. IV. p. 541.) *Hippéastrum vittatum* feels this but an act of self-justification after Mr. Sweet’s ungracious tirade, and, therefore, speaks for himself as follows: —

“Mr. Sweet, it appears, has taxed a Blooming Bulb with pilfering from Mr. S., the manner in which he has arrived at perfection. He assures Mr. Sweet, however, that he had already filled the offices of parent and grandsire before the appearance of the Gardener’s Magazine, through which his patron first became acquainted with the *Botanical Cultivator*. He could call his compeers to witness, fellow-inhabitants of the frames, who, like himself, have been twisted and twisted from one pot to another, that this ordeal

has been one of long standing; a discipline, 'tis true, under which he groaned at the time, but, like a quondam riotous school-boy, now feels the full advantages of, in his maturity. He remonstrates also against the implication swallowing raw of horse-dung, or of revelling on a stew-hole in a reeking tan-pit. *Hippeastrum vittatum* is far too nice, and has much more spirit, he is proud to say, than to suffer such treatment, which he candidly says would soon put him to death; but surely Mr. Sweet will allow others to know thus much of his temper as well as himself. The Hon. and Rev. W. Herbert is the personage to whom he is most indebted in this country, who has placed him in his proper rank in society with a knight's star\* upon his breast. All his family and kindred owe every thing to that gentleman, of whom he has heard so much in his present domicile, that possibly, from gratitude alone, he may have seconded the efforts of his guardian, who, if a pilferer according to Mr. Sweet, has to answer for the penalty to Mr. Herbert alone."

You see, my dear sir, that *H. vittatum* is sorely wroth. I cannot but commend his honest zeal, while I am sorry to say that the tone of Mr. Sweet's observations appears altogether beneath him, who, being occupied so usefully for the botanical and floricultural world, might have treated more philosophically the efforts of others, even if they seemed to trench on his own peculiar province. I might appeal to any *Amaryllis* man of two years' standing, whether all that is expressed in Mr. Sweet's two articles on the subject would not, per force, have developed itself to his observation in that time; nay, a great deal more must have pressed upon him, as to the treatment and soil for many of the original bulbs, which perhaps is unavoidably omitted in these communications. My article was solely on *H. vittatum*; and designed to second the effort of M. Faldermann for the non-initiated in its culture.

As to the flippant notice with respect to the amount of the hybrids, Colville's *Catalogue* for 1827, which enumerates about 150, was the latest published when I addressed you on the subject. Mr. Sweet's 10,000, while they strengthen my own observations, only prove what a delightful treat is always in store for those who have an opportunity of viewing them; while the lovers of the genus who are further removed, have this additional corroboration in proof of what they can do for themselves. I remain, my dear Sir, your constant reader. — *T. S. Alcock. Mount Hill, near Carmarthen.*

*Verbena Melindris.* — Mr. Harrison, jun., in reply to the statement of Mr. Perry (Vol. IV. p. 106.), writes that early in March, 1828, he received seeds of this plant from Mr. Perry, but at no time plants or cuttings. He adds, "on my going up to the horticultural fete, in June following, I took a specimen of it in bloom to show some of my friends, and having the favour granted of exhibiting it to some members of the Council of the Horticultural Society, they very much admired it, and as it was presented to them, they had an undoubted right to dispose of it as they pleased, without asking either myself or any other person for leave to do so. This circumstance led to its introduction into the *Botanical Register*; shortly afterwards application was made to my father from the Horticultural Society, for information relative to his knowledge of the history of the *Verbena*, and how it was received into Petworth Gardens. The substance of his reply was, that it came into his possession the preceding spring, by a cutting presented by Mr. Perry, gardener to T. Hawkins, Esq., Bignor Park, Sussex; and that Mr. Perry had told me he had been successful in raising it from seeds sent from Buenos Ayres in 1826."

---

\* *Hippeastrum*. Knight's Star. In allusion to the supposed resemblance in the corolla to the star worn by knights. Hence originally *Amaryllis equéstris*.



*The Stone Pine, Pinus Pinea, and not Pinus Cembra* (as erroneously stated in an extract from the *Foreign Review*, and copied into the *Gardener's Magazine*). — Sir, In Vol. IV. p. 391., under the title of Switzerland, you speak of “the Stone Pine (*Pinus Cembra*).” I respectfully conceive that you use an inaccurate expression in calling the *Pinus Cembra* the “Stone Pine,” without more addition. The Stone Pine is the *Pinus Pinea*, a native of the south of Europe, and which also has an eatable fruit; but I doubt whether you will find that to be a native of the Alpine regions of Switzerland, at the elevation at which the *Pinus Cembra* flourishes, and I also much doubt whether you can lay claim to the like praises for the quality of its timber, as for that of the *Pinus Cembra*. The *Pinus Cembra* is the Apherousli Pine, or Siberian Cedar, and its timber is undoubtedly entitled to all the praises you give it. The finest of the Riga deals are produced from this tree: the timber is peculiarly tough, and can be separated by the plane into very tenacious and flexible ribands of the whole length of the plank, for filling up fire places in summer, or similar purposes. — *Causidicus. November 24, 1828.*

*The Stone Pine is Pinus Pinea and not the Pinus Cembra* (as erroneously stated in the *Gardener's Magazine*. — Sir, In the last Number of your instructive *Magazine* (Vol. IV. p. 391.), art. Switzerland, in an extract from the *Foreign Review and Continental Miscellany*, for January, 1828, you speak of the *Stone Pine* and *Pinus Cembra* as one and the same plant. An error of such magnitude is a reflection upon your so generally correct pages; and, as a contributor and well-wisher to your popular work, I hasten to correct it. Referring your readers to that article, I beg permission to inform such of them as have not made the genus *Pinus* their study, that the Stone Pine (*Pinus Pinea*) is *not* a native of the Alps, nor will it ripen its fruits or prosper in so cold a climate as Switzerland. It is called (I think erroneously, but that, however, in the present case, matters not) a native of Italy, where it is much cultivated in the gardens, not only for the sake of its fruit, which is considered a great delicacy, and which the natives eat both in a crude state, and mixed greatly with their dishes, puddings, for instance, &c.; but for the great beauty of its form and manner of growth, and the lovely green of its foliage in winter, so admirably described in Mad. de Stael's popular novel of *Corinne de l'Italie*.

The *Pinus Cembra*, or Cembran Pine, is a native of Switzerland, but rarely found now in a wild state. The inhabitants of that country have from time immemorial rooted up all they have been able to discover when young, for the purpose of planting them in their gardens, or near their houses, where they place them as emblems of good fortune, and regard them with the same sort of veneration that the Germans pay to the stork. The origin of their superstitious feeling for this tree I have never been able to discover.

The form and character of the two trees, are as much dissimilar as is possible for plants of the same genus. The *Pinus Pinea* throws up a lofty naked stem, and carries thereon a large and extended broomhead (*fig. 47.*), as

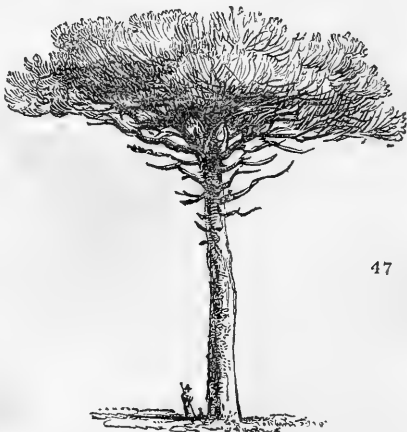

depicted in the paintings of Claude, &c.; the *Pinus Cembra* assumes a conical shape (*fig. 48.*) its boughs feathering towards the ground. Your informant might with equal truth and propriety have called the Scotch Pine and the Spruce Fir the same, for the one bears about as much resemblance to the other as the Stone Pine does to the Cembran Pine.

48



If your readers, and yourself also, good Mr. Conductor, will take the trouble to refer back to your own pages, you will find at p. 265, 266., of your Third Volume, under an account of the *Pinetum at Dropmore*. The *Pinus Pinea*, and *Pinus Cembra* there set down as distinct species of the same genus; one, the *Pinus Pinea*, comes under the class of *Pinus foliis geminatis*; the other, *Pinus Cembra*, under that of *Pinus foliis quinis*. Yours, &c. — *An Amateur*. Woodstock, October 10. 1828.

We are exceedingly obliged to An Amateur and Causidicus for the above correction and information. The truth is, we gave directions for copying these and other extracts from the *Foreign Quarterly Review* without observing the error, and being in France when No. XVI. was published, we only saw proofs of the first two sheets, and did not see a complete copy of the Number till our return to Paris in December last. No two pines are more easily distinguished than the *Pinea* and *Cembra*; and while there are abundance of large trees of the former in this country, those of the latter are for the most part young. The *Cembra* is figured in Harte's *Essays* under the name of *Asphernousli*. — *Cond.*

*The Anson, or Otaheite, Pine.* — Sir, C. F. W., in the last Number of your Magazine, page 105., asserts that the Anson, or Otaheite, Pine was introduced into this country by the late — Birt, Esq., of Colton Hall, and that some of the plants soon found their way from that to Shugborough, &c. This is not correct; on the contrary, the more probable circumstance is, that they found their way to Colton Hall from Shugborough, as there exists proof that the gardener I succeeded here sent a quantity of pine plants to Mr. Birt's, but none of having received any from his place. Mr. Nicol (who was gardener here from 1800 to 1810) likewise informed me, that the sort was in the stock when he came, under the name of the Anson Pine, but he could give no further information respecting it. Mr. Hodson (who was the gardener to Mr. Birt, now to the Marquess of Anglesey, Beaudesert) informed me how it came to be named the Otaheite Pine. He said, Mr. Birt was one day walking through the pine stoves, and observing one of the plants, asked him the name of it: Mr. Hodson said he did not know it, that there were not above two or three of the sort in the stock. Mr. Birt observed that it very much resembled a pine they had in the West Indies, under the name of the Otaheite. From that time he named it the Otaheite: I had, at the same time, a large stock of them, and not knowing the proper name, I adopted the one given it at Colton Hall, until Mr. Nicol called upon me two or three years after, and corrected me

by giving me the above information. The circumstance of having a large stock of the sort at Shugborough, whereas there were not more than two or three plants (as Mr. Hodson informed me) at Colton Hall, sufficiently proves that it was first cultivated at this place. I have traced it back as far as 50 years at Shugborough, and if C. F. W. or any other, has any thing to offer more convincing than his bare assertion in support of what he has advanced, all I can say is, that I shall be glad to see it; but I must observe, that, unless he puts his real signature to the communication, it will be unnoticed by me, as it ought to be by the public. I remain, dear Sir, &c.—*W. M. Murtrie. Shugborough, Feb. 7. 1829.*

*Woodwárdia radicans* should be substituted for *Adiántum pedátum*, in p. 52.—*James Housman. Toft, Cheshire, March, 1829.*

*Fences in the Southern States of N. America.*—You will oblige me by correcting an error in the abstract you made from my communication on the United States. (Vol. IV. p. 465.) In your version you make me to say, that the live fence I saw of the *Rosa multiflora*, in the State of Georgia, was the first live fence I had seen in America; whereas the sentence in the original MS. (now before me) runs thus: “The only live fence I saw in the *Southern States.*” As several of my acquaintances in the north are aware I could have no grounds for such an assertion, I beg you will, if possible, correct it in next Number.—*A. Gordon. Appley Castle, Wellington, Salop.*

*Erratum.*—Vol. IV. p. 486. line 11. from bottom, for *Seed* read *Sex*.

---

#### ART. XI. *Queries and Answers to Queries.*

*RULES for pronouncing Botanic Names* (in answer to X. Z.).—The true pronunciation of Greek and Latin words being lost, the natives of different countries treat them according to the rules of their respective languages; and however discordant those rules may be, still oral intercourse in that tongue is so unfrequent, that even were the learned disposed to reduce its sounds to a conventional standard, it would scarcely be worth the trouble. We mention this, in order that should any of our readers meet with a brother-gardener of another country, he may not consider his pronunciation of systematic names incorrect, nor be unable to assign a reason for the discrepancy. Thus, then, in England, we subject the vowels to the rules of our own tongue, without any attention to the Latin quantity, often producing results absurd enough in all conscience; but it is an absurdity shared in common with other nations, and, as we have said, not worth the trouble of altering. It might, perhaps, be sufficient to direct X. Z. to pronounce Latin vowels as he would English, placing the accent as he may find it marked, and to treat the consonants, with the exception of *ch*, in the same manner; but as many gardeners may not be masters of the correct pronunciation of their mother tongue, for their information, we shall go more into detail.

In classical words *there are as many syllables as there are vowels*; except when *u* with any other vowel follows *g*, *q*, or *s*, and when two vowels unite to form a diphthong. The diphthongs are *æ*, *æ*, *ai*, *ei*, *oi*, *ui*, *au*, *eu*, and *ou*. These seldom coalesce in final syllables, and when separated in initial or medial syllables, it will be indicated by a diæresis, as *ou̇*, except when the accent falls on the first vowel, as *ou̇*, in which case the accentual mark is sufficient. *oo*, *ee*, *ea*, and other combinations which never occur as diphthongs in classical words, follow, in commemorative names, the pronunciation of their primitives, as *Teédia*, *Woodisia*.

In this work *the sounds of the accented vowels* are sufficiently indicated by the mark placed over each, and therefore it may seem unnecessary to

give any directions regarding them : but, in addition to this primary accent, every word of more than three syllables contains a secondary accent, which is regulated by the same rules ; and with reference to it, and also to prevent our readers being misled by casual typographical errors, we shall notice those vowels in which mistakes might occur. The secondary accent must always be at least two syllables before the primary accent, as in *Chélidonium* ; for its place the ear is a sufficient guide, and even were it entirely omitted, still, however inharmonious, it would not be incorrect.

Every accented penultimate vowel is pronounced long, when followed by a vowel or a single consonant, as *Achillèa tomentosa* ; but it is shortened when followed by two consonants or a double one, as *Sórbus, Táxus* ; except when the first consonant is a mute and the second a liquid, as *A'brus*.

Every accented antepenultimate vowel, except *u*, is pronounced short, as *Helléborus, Húmulus* ; but when succeeded by a single consonant, followed by *e* or *i* and another vowel, they are lengthened, as *Stellària* ; except *i*, which is short, as *Tília*.

*A* unaccented, ending a word, is pronounced like the interjection *ah*, as *Stícta (ah)*.

*E* final, with or without a consonant preceding, always forms a distinct syllable, as *Silènè, A'loè* ; also when the vowel is followed by a final consonant as *Tri-chó-ma-nes*, not *Tri-cho-manes*.

*I* unaccented, if final, sounds as if written *eye*, as *Spìca vénti (eye)* ; but when it ends a syllable, not final, it has the sound of *e*, as *Méspilus (Mespelus)*, *Smíthü (Smíthè-eye)*.

*Y* is subject to the same rules as *i*.

The diphthongs *æ* and *æ* conform to the rules for *e* ; *ei* is generally pronounced like *eye* ; the other diphthongs have the common English sounds.

The following directions regarding consonants and their combinations, though unnecessary to those skilled in our own tongue, may not be without their use to some of our readers :—

*C* and *g* are hard before *a*, *o*, *u*, as *Córnus, Gàlium* ; short before *e*, *i*, and *y*, as *Cetrària, Citrus*.

*T*, *s*, and *c*, before *ia, ie, ii, io, iu*, and *eu*, preceded by the accent, change their sounds, *t* and *c*, into *sh*, as *Blètia, Vícia* ; and *s* into *zh*, as *Blàsia* : but, when the accent is on the first diphthongal vowel, the preceding consonant preserves its sound, as *aurantiacum*.

*Ch*, before a vowel, are pronounced like *k*, as *Chelidonium (kel)*, *Cólchicum (kolkekum)* ; but, in commemorative names, they follow their primitives, as *Richardsonia*, in which the *ch* is soft.

*Cm, cn, ct, gn, mn, tm, ps, pt*, and other uncombinable consonants, are pronounced with the first syllable mute, as *Ptèris (teris)*, *Cnìcus (nikus)*, *Gmelina (melina)*, *Gnídia (nidia)*, &c.

*Ph*, followed by a mute, are not sounded ; but, followed by a vowel or a liquid, sound like *f*, as *Phlèum (fleum)*.

*Sch* sounds like *sk*, as *Schœnus (skenus)* ; in *tm* and *zm* both letters are heard.

*S*, at the end of a word, has its pure hissing sound, as *Dáctylis* ; except when preceded by *e*, *r*, or *n*, when it sounds like *z*, as *Ribes (ez)*.

*X*, at the beginning of a word, sounds like *z*, as *Xánthium* ; in any other situation it retains its own sound, as *Táxus, Támarix*.

We have now given sufficient directions to enable any intelligent gardener to pronounce systematic names with correctness. To know where to place the accent would require a knowledge of Greek and Latin prosody, which we cannot expect every man to attain ; this, however, we shall continue to indicate by the use of accents. But while we do this for the advantage of the unlearned, we hope no gardener, who values his

future station in life, will neglect to acquire a competent knowledge of languages which are the keys to so many modern ones, and which will render terms of science vehicles of information instead of empty sounds.

*Plan for laying out Grounds.*— Sir, you would much oblige a constant reader of your useful Gardener's Magazine, if, through its medium, you

49



*References to the Plan (figs. 49, 50.) and the Profile (figs. 51, 52.).*

- ††, Situation of existing trees.  
*a*, Peach-house, vinery, and a hot-house between them.  
*b*, Entrance-gate.  
*c*, Mansion-house, in the Grecian style.  
*d*, American garden, with pond.  
*e*, Green-house.  
*f*, Veranda.  
*g*, Terrace-walk, with two flights of steps to lawn, in which is a fountain.

- h*, A ravine; to which a walk should lead from the grounds, as a cascade may be there formed.  
*i*, American ground, begun but not finished.  
*k*, From this point a peninsula, of a circular form and rising into a round-topped hill, stretches nearly half across the lake, consisting of about nine acres: it is partly fringed with wood, but bare opposite the house, and with a barren gravelly shore.

would submit to the consideration of landscape-gardeners a problem in their art, for the most approved demonstration of which I offer a premium of five sovereigns.

The plan enclosed (*figs. 49, 50.*), drawn by an unpractised hand, will give an idea of the extent of the property intended to be improved. As you, probably, cannot spare me much room in your Magazine, I will

50



- l*, Lake, two miles long and half a mile broad.
- m*, Boat-house.
- n*, Orchard.
- o*, Iron railing.
- p*, Highway.
- q*, Farm-house, barn, cottages, garden, and orchard.
- r*, Lawn and flower-garden.

- s*, Well, round which pleasure-ground may be formed
- t*, Present kitchen-garden, orchard, and slip.
- u*, Stables.
- v*, Site of intended kitchen-garden.
- w*, A round knoll.
- x*, Orchard.
- y*, Farmyard.
- z*, Plantation.

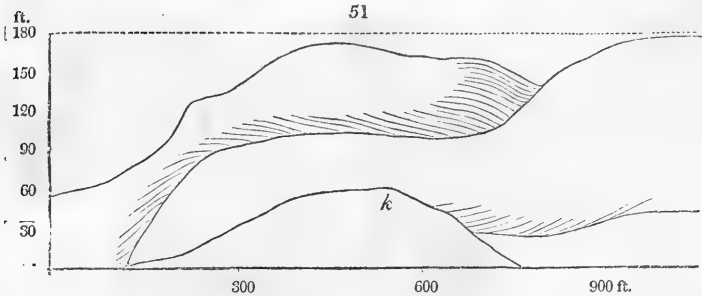

therefore contract my data and desiderata into as small a space as possible.

*Data.* Given, then, about fifty or sixty acres of land on the banks of a lake, of which about one half is a steep declivity, and the other sloping, with various round knolls and breaks, to the water's edge. The ground is almost undecorated, except by a villa in the Grecian style, consisting of dining and drawing rooms, each 22 ft. by 16 ft., looking upon the lake; behind them a breakfast-room 16 ft. square, a lobby, and library, 14 ft. by 15 ft., with a small bath-room adjoining: offices behind. The library and drawing-room communicate with a green-house, and the house itself stands upon a terrace 25 ft. broad, opposite the lake front, including 7 ft. the breadth of a veranda. From the terrace you descend 5 ft. to what is at present a common grass field. There is a highway about 500 ft. from the house, between it and the lake, which cannot be diverted. There is but one convenient and practicable situation for culinary forcing-houses (now building), and that is on a hillock in a field to the north of the house, behind which is the farm-yard: the stable-yard adjoins the offices of the mansion. But I must refer to the accompanying plan (*figs.* 49, 50.), and general view (*figs.* 51, 52.).

Required, a plan and detail of improvement, adapted to this situation. And here I must further inform my landscape-gardener, that this place is my constant residence; that I have but one gardener, occasionally assisted by the farm servants; that my fortune will not admit of the whole sixty acres being converted into park and pleasure-ground, but that I wish them to be laid out rather as an ornamental farm, attached to a gentleman's residence and pleasure-grounds, wherefore I must confine my improver to about six or seven acres of dressed ground, shrubberies, &c., including a kitchen-garden sufficiently large to supply a family of ten persons; that I am somewhat of a recluse, taking great delight in umbrageous groves, in murmuring streams, trees, shrubs, and flowers more especially.

——— “Ego laudo ruris amœni  
Rivos, et musco circumlita saxa, nemusque.”\*

I am a small farmer; in short, attached to rural affairs, *unattached* to a wife, and not *banned with bairns*; I say to my garden, as Hero says to her lover, in Ovid,

——— “Te, O mi sola voluptas,  
... amo.”†

\* “I prefer a delightful villa, with its streams, its moss-covered rocks, and groves.”

† “Thee, O my sole delight! I love.”

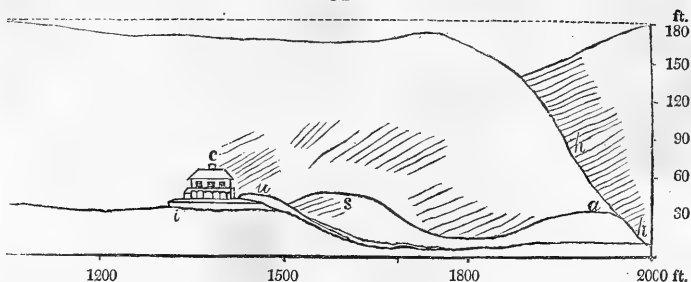

I hope I have now, as far as written communications will effect it, explained the state of my little affairs, so that some talented designer may be enabled to set me to work upon parterres, American grounds, bowers, fountains, aviaries, walks, shrubberies, &c., in which, I trust, your Magazines will be no small assistants to, Sir, your obedient servant — *Philagros. Jan. 31. 1829.*

*An Insect in Fruit Trees.* — I grow fruit trees rather extensively, but suffer so much every spring, particularly of late years, from the depredations of one particular insect, that it is become a matter of very serious consideration with me what I am to do to put a stop to the devastation it commits. These insects begin their handywork about the latter end of March, by attacking all my newly put on grafts of apples, plums, and cherries in particular. They let nothing escape. They first begin at the top of the scion, and strip it of all the bark, quite round; then as the eyes begin to swell they eat them almost every one out, and quite hollow, as if done with a small scoop. As soon as the buds inserted the previous year begin to grow, their shoots are served in the same way. They are also very severe on my fruit trees even of two or three years old, attacking them about the same time as they do the grafts (especially those that have been shortened in to produce young wood), by eating out a number of eyes, and divesting almost every young shoot of its bark, for perhaps an inch below the point of amputation.

Notwithstanding all this, most of my grafts grow at a second effort, after the insect appears to have given over its work of destruction, but they are so much retarded and weakened that they are by no means equal to those that escape.

I am no entomologist, but believe the animal to belong to the genus *Curculio*, and I have sent for your inspection a quantity of them in a small tin box, together with some shoots of the apple tree that they have operated upon. In the daytime they retire a short way under the surface of the earth, and, in dry weather (being of the same colour as the mould), it is scarcely possible to see them; but by examining the grafts, &c. at night, with a lighted candle, they are seen at full work in thousands. I do not observe it figured or described amongst other insects in your *Encyclopædia of Gardening*. Perhaps in the new *Magazine of Natural History* which you have now commenced, you may, in course of your progress, give us some account of it. I am, &c. — *John Hervey. Comber Nursery, May, 1828.*

We are extremely sorry for having so long neglected this communication; the circumstance arose from our having sent it, along with the box of insects, to Mr. Haworth, and forgotten that we did so. Mr. Haworth says it is a species of *Dermestes*, but does not know its specific name. We should think watering the ground with hot water the most likely mode of destroying them; but perhaps Mr. Major (p. 192.) will tell us what to do. — *Cond.*



*The real Double Cowslip*, in answer to the Rev. W. T. Bree of Allesley Rectory (Vol. IV. p. 446.)—J. B. Ward, Esq., of Mount Pleasant near Sheffield, states that he is in possession of the real double cowslip, not the cowslip with a twofold corolla, hose in hose as it is termed, but with a fine double blossom. "I do not believe any person in our neighbourhood is in the possession of this singularly beautiful plant, except myself. I have bloomed it for many years. I remain, Sir, &c. — *S. B. Ward. Feb. 23. 1829.*"

*Maggots in Celery.*—The maggots noticed by J. F., of Battersea (Vol. IV. p. 100), have again made their appearance in great numbers on, or rather in, the leaves of the celery. They first appeared on the 10th of September, and, in a short time, the celery bore the appearance of being sprinkled over with boiling water. There being slight frosts, with cutting easterly winds, about that time, many attributed it to that, little suspecting that each leaf contained an insect, and that each decayed leaf was the effect of its ravages. — *J. H. Dec. 12. 1828.*

*Destroying Woodlice* (in answer to Z., Vol. III. p. 581.).—Sir, Of all the insects that infest cucumber frames, I know none worse than woodlice. I tried several things, as sulphur, lime, and soot, for the purpose of destroying them; but none of these were available. At last I thought of a scheme which perfectly answered the purpose. I pressed the mould very tight and closely all round within the frame, making a kind of trough about six inches wide. This I covered with hay about two inches thick, which I expected would form a retreat for the insects. They soon collected there, and were destroyed by pouring boiling water over the hay. This I repeated till I got rid of all the insects. This plan of inviting the woodlice together and scalding them to death, is adopted when the cucumber plants are young; and it may be necessary to add, that this application of water does good rather than harm when there is a strong heat in the bed, but is not quite so suitable when the heat is on the decline. I am, Sir, yours, &c. — *J. N. a Gentleman's Gardener. Jan. 27. 1828.*

*Methley's Fire-places.* (Moser & Co.)—Have you seen any of Moser's fire-places, and are you aware that they not only throw out more heat than any elegant chamber-stove hitherto in use, but also, by means of certain small holes in the back and sides, burn great part of the smoke? Might not hot-house furnaces be constructed on a similar principle so as to burn the smoke, or a part of it, and thus procure more heat from the same quantity of fuel, and save the troublesome and disagreeable operation of sweeping the flues? — *S. B. Bristol, March 4. 1829.*

We are fully aware of the superior excellence of Methley's stoves (of the firm of Moser and Co. of Frith Street, furnishing ironmongers), for rooms, an eminent architect in this neighbourhood having them in every room of his house, and having ourselves one. We have little doubt the improvement might, to a certain extent, be added to hot-house furnaces, but we believe it has not yet been so applied. — *Cond.*

*Errors in the Encyclopædias of Gardening and Agriculture.*—Sir, Would it not be wise to request your correspondents that they would generally communicate to you any error, especially in the statistical details of your Encyclopædias, that may happen to have come under their notice. This would much improve them for a future edition, and would be generally a public good. — *J. S. L. Cl—n, December 9. 1828.*

We have done so in the prefaces to these works, on the covers of the earlier Numbers of this Magazine, and again do so. We are most anxious to receive every description of correction, and no correspondent can oblige us more than by pointing out errors in these works, in this, or in any other in which we are engaged. — *Cond.*

*Smoky Chimneys.*—I wish you to touch upon the subject of chimneys, a subject which I believe to be very well understood by a few, but by the

many quite neglected; for what so common as a smoky chimney, and what worse? and yet what more clear than the folly of building them in the usual manner, in the external walls and as rough inside as possible? Mr. Hiort's plan sounds well, but I should like to hear how it succeeds in practice, and if it succeeds, how we, who reside nearly 200 miles from London, may obtain its advantages on reasonable terms. — *A. G. Near Barnsley.*

*Gnaphalium Stæchas*, and other Plants for Rockwork. — I am not aware that it is generally known that this plant will stand the severity of our winters better on the wall or on rockwork, than in the common soil of the borders. The *Cerastium repens* is also a very ornamental plant for rockwork. Also the *Verbascum Blattaria* var. fl. lutea, *Sedum divaricatum*, and *Antirrhinum sparteum*. — *T. Hawkins. The Haw, near Gloucester, June, 18. 1828.*

*The Mezereon*, as a Conservatory Plant, was nearly in full blossom in the borders in December. Perhaps by being protected in the conservatory, it might generally blossom at that time; if so, its highly odoriferous flowers, by diffusing their fragrance throughout the house, might recommend a trial of a few of these plants scattered among others. — *Id.*

What is the *Magnolia sinuata*? Has it any synonyme? — *Causidicus. Feb. 4. 1829.*

*Hyacinths in moist Sand*. — I recollect hearing that hyacinths were grown in greater perfection in fine sea sand kept moist, than in water-glasses. I have tried the experiment this season. Has it been seen to succeed? — *W. M. Argyleshire, Nov. 6. 1828.*

*Strelitzia reginae*. — I have had this plant for three years, and with all my efforts, together with the assistance of my man Friday, have not been able to flower it. Two of my friends are in the same state. We give it plenty of heat in rich soil, but that will not do. Does it require much or little water, or soil of a particular earth; i. e. particular, speaking geologically? — *G. G. Birmingham, Feb. 7. 1829.*

*Ants on Peach Trees*. — Can you or any of your correspondents inform me of any remedy for ants on peach trees? I am troubled with them sadly; my soil is a sandy loam, in which they seem to harbour so securely, as to render extirpation impossible. Toads do not eat slugs; the opinion of Rusticus in Urbe is not correct in thinking that they do. I have kept a large toad in an early cucumber-frame, and encouraged him there to eat these reptiles, but without effect; woodlice are, however, rarely seen near his abode. — *G. M. Atherstone.*

*Training Vines downwards from the Rafters*. — I am much at a loss to know how this can be done; and should be much obliged to your correspondent Mr. Haycroft, if he would give us some details, accompanied by a sketch. — *Id.*

*Double Dahlias (now Georginas)*. — Is there any publication exclusively devoted to fine varieties of this flower? — *S. B. Ward. Sheffield, Feb. 55.*

Not that we know of; but some varieties are occasionally figured in *Sweet's Florist's Guide*. — *Cond.*

*Very Double Italian Tuberoses*, such as they have in Paris, are not to be purchased about London; What is the reason? — *Id.*

*Cultivation of the Oak*. — Sir, Will you inform me who has written on the cultivation of the oak, and which you consider the best and most useful work on this most interesting subject? Probably some of your correspondents would give their opinion as to the rearing, culture, and attention, the oak may require, to prepare it for timber. This would very greatly oblige a constant subscriber and a sincere lover of a fine oak tree. — *Q. Bristol, Aug. 9. 1828.*

*Heating by Hot Water.* — I think the steam challenge is a fair one, and hope it may be tried with care and attention. I am inclined to think that steam is the best mode of heating any large bulk of matter, although water or gravel may be the safest medium for applying it to plants. Could hot water be used in forcing melons with greater advantage than dung, or even with equal benefit? If so it will be of great advantage in situations where stable manure is not easily got. — *W. M. Argyleshire, Nov. 6. 1828.* (See *England*, p. 215., and Mr. Byers's article, p. 20.)

---

## ART. XII. Obituary.

DIED, Jan. 28., at the early age of forty years, *Thomas Tredgold, Esq.*, civil engineer, author of several valuable works on different branches of his profession. As a scientific engineer, Mr. Tredgold was at the very head of his profession, and to this distinguished eminence he raised himself entirely by his own studies at his leisure hours; having come to London, about twenty years ago, with nothing more than the common education of a country mechanic. The only advantages that he had were, being placed in circumstances which brought into his view certain points of scientific eminence; and having access to books, the points which he saw had been attained by others he set about attaining himself, one after another, till he mastered the whole. His last work, as a practical engineer, was the heating of the splendid botanic hot-houses at Syon House; the most complete work of the kind, and on the most extensive scale, that has hitherto been executed in this or any country.

On the 15th of February, aged seventy years, *Mr. James Grange*, fruiterer, Covent Garden Market and Piccadilly, and, some years ago, the occupier of a fruit and market garden at Kingsland, of sixty acres, on which he spared no expense, and executed the most spirited improvements. He furnished the prices of Covent Garden Market for the first three volumes of the *Gardener's Magazine*. He had a good practical knowledge of fruits, and was a devout Christian.

On the 15th of February, at Kingston upon Thames, *Mr. James Astin*, well known as a florist.

At his house in Kensington Gore, on the 28th of February, *Thomas Weare, Esq.*, nephew to the late Mr. Jeffrey, of the Brompton Park Nursery, and many years partner with Mr. Gray of that establishment. He retired from business some years ago, much respected in his profession, and among all his neighbours. — *W. M.*

On March 22d, at his house Beaufort Row, Chelsea, *William Stevenson, Esq.*, author of the *Agricultural Surveys of Surrey and of Dorsetshire*, and of various other works, and of several papers and reviews in this *Magazine*. He was a man of high and immovable moral principle, and of the soundest views on every subject of literature and science. The *Conductor* had the advantage of his friendship for upwards of twenty-five years, and, in common with all who knew him, deeply deplores his loss.

---

THE  
GARDENER'S MAGAZINE,  
JUNE, 1829.

---

PART I.  
ORIGINAL CORRESPONDENCE.

---

ART. I. *Notes and Reflections made during a Tour through Part of France and Germany, in the Autumn of the Year 1828.* By the CONDUCTOR.

(Continued from p. 125.)

*CULTURE of the Honfleur Melon.* — “Sow,” says M. Racine, “on a hotbed, about the end of March, paying no regard to the age of the moon, as they do at Honfleur, unless you choose;” the seed will come up in 48 hours; and the plants, being put separately into little pots and still kept in the hotbed, in fifteen days will be ready to plant out on the hills or ridges in which they are to produce their fruit. These hills are thus formed: — Having fixed on an open quarter of the garden, facing the sun, stick pins over it 4 ft. apart every way; dig a hole in the situation of each pin, sufficient to contain a barrow-load of well-fermented dung; cover this dung with a barrow-load of mould, formed of rotten dung or of rotten leaves, and place around the hill so composed the earth which came out of the hole. Then insert the plant, cover with a bell-glass, and treat as for ridged cucumbers till fruit is shown, when allow only three to each plant, and stop the runners two leaves beyond each fruit. The fruit will ripen in the last fortnight of August, and the first fortnight of September. Cantaloup melons may be treated in the same manner, but do not succeed so well.

The Honfleur melons so produced weigh from 10 to 40 lb.; those raised by M. Racine, this year, weighed, in general, about 24 lb. One or two were still to cut, and also some Cantaloups; but, owing to the wet season, the flavour of neither was as good as usual.

In the coal districts of England, melons might be raised in the same way at little expense, by passing pipes of hot water under a common garden-wall border of south exposure. The same fire-places might also heat the walls by another set of pipes, which would come into use when heat in the border was not wanted.

Even the pine-apple might be grown in the open air in France. In some of the market-gardens of Paris, pine-plants in pots, plunged in bark beds, are exposed to the open air during four months of summer and autumn, and they succeed very well. If ever it should become desirable or profitable to cultivate the pine-apple extensively on the Continent, that fruit might be grown by the acre in the coal fields which are ascertained to exist in Provence. A little shade would be necessary in summer, which might be given by vines; and in winter, the pines, being planted in beds, might be protected by straw mats drawn over the frames or trellises on which the vines were trained. As the pine-apple is, or ought to be, kept in a dormant state during a great part of the winter, the diminution of light in consequence of such a covering would not be an insuperable disadvantage; the more especially as on most days the covering might be removed for a few hours. It is true this mode of supplying heat from below, instead of from the sun, is not very natural; but nevertheless it has been found to answer in Britain, in the practice of cultivating the pine in bark beds and dung pits; and it may be safely affirmed that, if the water in the underground pipes were never allowed to exceed a temperature of 80° to 90° Fahrenheit, no danger would ensue.

We were pleased to find that M. Racine had a small garden library, and was a collector of insects. Among his books are, *Le Botaniste Cultivateur*, 5 vols. 8vo, *Rosier's Manuel du Jardinier*, *Le Bon Jardinier*, *Quintiné*, and various catalogues and minor works.

In passing through *the market-place* to the cathedral, on the Sunday morning, we observed but few vegetables, and those not of superior quality: coarse green cabbage, a narrow-podded variety of kidneybean, and three varieties of potatoes; some pears of different sorts, none of which were good; and some apples and plums. We were told that there was much better fruit grown in the gardens of the neighbourhood, but that it was not brought to market; and indeed we found afterwards, in the neighbourhood of the New Marine Baths, excellent peaches, pears, figs, Cantaloup and Honfleur melons, and some grapes.

The building called the *New Marine Baths* is little more than a screen to protect the portion of shore devoted to bath-

ing. It is about 200 ft. long, constructed of timber, but in a simple and elegant taste. It consists of a central, rectangular mass pierced by an archway as an entrance, joined to two larger pavilion wings, the one containing dressing-rooms and a saloon for the ladies, and the other dressing-rooms and a billiard-room for the gentlemen. The space between the wings and the central archway, is occupied by two verandas open on both sides, and forming an airy promenade during rain or hot sunshine. Some critics might object to this structure, because it is built of timber, and because the veranda is painted and otherwise finished in the style of a Turkish tent; but, we confess, with reference to its situation and uses, we think it in as good taste, both in its form and in its materials, as the Gothic cathedral which is built of sandstone, or the piers and quays which are of squared blocks of granite.

We entered *the Cathedral during religious service*, and found it completely filled, chiefly with elderly poor persons and children; perhaps about three fourths of the whole were women. The solemnity and devotion were equal to any thing we ever witnessed; less pantomimic than in the churches of Russia, and with more abandonment to the purpose of assemblage than in England. The high ascending lines of the architecture, and the consciousness of the antiquity of the Catholic religion, no doubt, added to the effect. One or two boxes for charitable contributions were carried round by official persons, in which many very poor old men and women dropped something; because, in all countries, those are the most charitable who have the nearest view of poverty. We observed little children putting in pieces so small that they must have been liards or cents; and could not help feeling that teaching them to do so was an excellent means of educating their affections.

On coming out of the Cathedral, the *roundabouts and swings*, which, on entering, we had seen stationary in the market-place, were in motion; and amusement seemed to be as heartily engaged in by the young men, as religion was a few minutes before by their grandsires. Four monkeys were climbing the fronts of the houses, and running up and down the water-spouts in different parts of the streets, to the no small gratification of the children; and we also were so much amused, that we incurred the censure of our host for tempting the monkey-keepers, four boys who said they were from Parma, to make them show off their professional antics on the front of his house.

*Sept. 1. Dieppe to Rouen.* — One sea-port town is so like another, all over the world, that an Englishman in Dieppe

may forget he is in France, till he ascends the heights over which passes the road to Rouen, and surveys that extensive prospect of unenclosed corn country which lies before him; so very different from any thing which he can have seen in England. The first object he passes is a suburban villa, with its square garden in front, its little avenue, clipped alleys, and berceaux; and this carries him back, in the history of rural improvement, at least a century. The novelty of the scene and of the thoughts to which it gives rise, the clear bracing atmosphere, the idea of being completely beyond the reach of routine cares and duties, and having nothing but enjoyment in perspective, elevate his spirits to a high degree. This feeling, we should think, must be much more intensely experienced in going to Paris from Dieppe, than in proceeding to that city over the dull flat country about Calais; for the mind is influenced by every material circumstance with which it is surrounded. Any man in any country will enjoy higher and better spirits in travelling along an elevated open road, than he will along a bottom confined by hedges; and the same will be the effect of living in a house in a high situation. Even a house the principal floor of which is ascended by a few steps is felt to be more dignified, and known to be drier and healthier, than one to which you descend by a few steps; and there can be little doubt that the mere circumstance of a man in London lodging on the parlour floor or on the first floor, will have an influence on his sentiments and character. In the endeavours of the wealthy of any country, therefore, to raise and ameliorate the lowest classes, the first thing should be to raise and ameliorate their dwellings; the next thing to place them above absolute want by a large garden; and the third thing to place near them good infant and Lancasterian schools.

Further on one or two other ancient gardens are passed, and the stranger cannot avoid being struck and pleased with them. The principal cause of this pleasure, as far as it respects an inhabitant of England at the present time, is undoubtedly novelty; and secondary and supporting causes may be referred to the antiquity of the style, its marked character, and perhaps to its being, or being called, French. This last cause may, perhaps, operate upon some people, because there is a sort of secret pleasure in loving those things which, according to common opinion, we ought to hate. It was perfectly natural, that the architectural or ancient style of planting and gardening should be admired in France and England, when those countries abounded with natural scenery, and when hedges and straight lines of trees were rarely to be seen in the general

landscape; but avenues are now common all over the Continent, and hedges are at least not very rare in the north of France. The prevalence of the ancient style, therefore, where it no longer possesses the beauties of contrast, may be attributed partly to a want of cultivated feeling for natural landscape, but chiefly to the want of examples in a better manner. Improvements in matters of taste have hitherto, in monarchies at least, commenced with the court, or with the very highest classes. The titled rich, who are supposed to know every thing, and to have every thing within their power, have the credit given them, by the newly enriched citizens, of choosing the best; and the latter, being limited in their means of knowledge as well as of choice, naturally think they cannot do better than follow what they consider a good example. Hence the great majority of people, in every country, are influenced much more by fashion than by reason; and hence, also, the importance, in all matters whatever, of the example shown by the higher or powerful classes to the lower. Much good, in point of example, has been effected by the aristocracy of England; but much is still wanting from them, in matters of political justice, no less than in matters of morality and taste. No person of any reading or experience will ever expect this improvement as a voluntary production; but necessity will gradually bring it about, and the elevation and amelioration of the lower and middling classes will force a wiser policy, more humanity, and a greater degree of self-respect, on those which are above them. The press and the school will lead to every thing, and that ebb and flow of taste called fashion will one day be under the influence of a more enlightened reason.

The soil, almost every where between Dieppe and Rouen, and, indeed, we may say, between Dieppe and Paris, or rather Dieppe and Strasburg, is a friable loam on a calcareous subsoil. The ploughs we saw here were better constructed than in some districts in England, with a well-curved iron mould-board, two wheels, and drawn by three horses abreast, without a driver; the harrows are not so good, and have wooden tines. In the carts may be traced the origin of the Scotch corn or harvest cart. The horses bear considerable resemblance to what is called the Suffolk punch. The radical defect of the agriculture here, as in all those parts of France through which we have passed, is that of not ploughing more than half the proper depth. An East Lothian or Berwickshire farmer on such a soil, we should think, would raise double the quantity of disposable produce; and, notwithstanding all the prejudices and difficulties which are to be taken



into account, still we cannot help wondering that so few British farmers have settled in the north of France. The single circumstance in which the French farmer, as a practitioner, has the advantage over the British one is in the frugal style in which he lives, not only himself and his family, but his servants and cattle: this is also the reason why his agricultural operations are so imperfectly performed; two of his horses, fed with good oats, would draw a deeper furrow than the three he uses, as now fed.

When France and England shall have become better known to each other, and when the facilities of travelling, and the more general diffusion of all kinds of knowledge, shall have diminished the force of early prejudices and local attachments, then, it is probable, great numbers of rent-paying farmers, of landed proprietors, and of retiring tradesmen and manufacturers, will settle in this part of the Continent; not only on account of the greater profits which capital at present produces there from its scarcity, which is but a temporary reason that perfect freedom of commerce will effectually do away, but from the very superior soil and climate of France for corn culture; because, a possessor of land in France can produce, in his own fields and garden, more of the things which constitute the comforts and enjoyments of life than he can in Britain; and because the inhabitants are naturally more amiable and more disposed for social enjoyment. Great part of England, and the whole of Ireland, are better calculated for, and, if commerce were free, would be more profitably employed in, the production of grass and potatoes than of corn. The beef and pork of the British isles will, on this account, it is probable, always maintain their superiority; and the time may come when very little corn will be grown there, and a great deal of animal food exported to other countries. As the world improves, the idea of rendering any one country independent of every other will probably cease to occupy the minds of political economists; the agricultural and manufacturing industry of every country will be almost entirely directed to the production of that which it naturally produces best, and the rest left to free commerce.

The only part of the culture by the road-side, which struck us in passing along as decidedly good, was that of timber trees. These were planted in rows, with a degree of regularity and exactness unknown in plantations in England, and each tree pruned and trained to one straight stem or trunk, with very few branches, except towards the head, and none any where of large size; the branches are all cut off when quite young, and, as the wound heals over quickly, the trunks and

timber are perfectly smooth and sound. Every body knows that this road is bordered by apple trees, chiefly of the russet kind; many of these were now heavily laden with fruit.

*Tôtes.* — We stopped an hour at this village to refresh the horses, which we had hired to Rouen. It happened to be the market-day; and, whether we take the houses of clay, red brick, and white limestone, the people, or the articles exposed for sale, the difference, as compared with a village about the same distance from the shore any where in England, was most striking. Though there were some good cottons and cloths, yet the greater part of the manufactures, especially of the earthenware, was of a coarser kind than is to be met with in Britain. The cheese was in soft rolls of half a pound each, and by no means inviting. The samples of wheat and oats were very inferior, and so mixed with the seeds of weeds, that they would not have sold as bread-corn in any part we know of either England or Scotland. Forty or fifty sacks, which were pitched in the market-place, had been brought there on horses' backs, by nearly as many farmers; the horses were turned loose in an adjoining grove, with their high clumsy saddles and bridles, of untanned leather. As characteristic of the great attention paid to economy in minutiae by the French of all ranks, and also of the kind feeling which subsists among them, we may state that there were several female beggars in the market-house, pursuing their avocation among the buyers and sellers; and a little child was sweeping up, and collecting in a cup, the few grains which fell from those who had taken samples in their hands.

The church, a low diminutive structure, is built of flints, with a wooden spire painted red. It has a small churchyard, with only two tombstones in it; one commemorating some former curé, and the other the lord of the manor, as he would be called in England, who was lately deceased.

The mansion of this lord stands hard by, and is now occupied by M. la Comtesse de Malartie, his widow. It is a stately modern building of red brick, faced with grey limestone. A fellow-traveller said it put him in mind of the mansion of Mr. Banks in Dorsetshire. The ground between it and the village was in a sad state of disorder, such as we scarcely recollect to have seen round any mansion out of Russia. The grounds on the other side contained some woods, walks, and alleys, in the ancient style, and a field with a walk serpentining along two sides of it, and some shrubs carelessly stuck in the grass. The former, the gardener told us, was called the *bosquet* (wood), the latter the *partie Anglaise*. There is a kitchen-garden of two or three acres, surrounded by a high, substan-

tial, ancient brick wall. Against the wall stood the cankered stumps of three pear trees, an old fig tree not nailed, a vine, a peach and two apricots ruined by age moss and gum, and, what we were rather surprised at, a young apple tree. There were also some young forest trees, self-sown willows, and birch trees, growing out of the coping of the wall. The walks were without edgings, and not gravelled. A few fruit trees, chiefly pears, *en quenouille*, without fruit, and with the bark covered with moss, stood in the quarters; and in the borders were some currants with stems 3 and 4 ft. high, and matted, which, the gardener said, preserved the fruit till Christmas; one or two gooseberries on tall stems, and a few raspberries and wood strawberries. The compartments were cropped with artichokes, field cabbage, celery scarcely if at all earthed up, kidneybeans, spinage lately sown for winter and spring use, red beet, leeks, sorrel in a considerable quantity, and scorzonera. In the borders were *Coreópsis tinctoria*, double perennial sunflowers, mallows, and a few other things. What is remarkable, there was a small pine-pit, the plants shaded with straw mats; and a small green-house with *Cactus speciosíssima*, *Crássula obliqua*, and other succulents, *Ficus índica*, *Cápsicum Amòmum Plínii*, *Brugmánsia arborea*, *Aloýsia citriodora*, one or two pomegranates, orange trees, and myrtles. The walks had lately been hoed and raked, and the gardener told us that the broad walks and carriage-roads, in both fronts of the house, were cleaned by harrows drawn by horses or oxen, and afterwards raked smooth by men. An immense quantity of linen was drying on lines in front of the house; and a very decent, good-looking, elderly woman told us that the family linen was washed only twice a year, and that this was one of the times.

(*To be continued.*)

---

ART. II. *On Parochial Museums and Public Gardens, and on Dancing and Music, as Means of educating the Feelings of the Laborious Classes.* By VARIEGATA.

Sir,

IN perusing the interesting communication from Mr. Spence, which appeared in the last Number of the Gardener's Magazine, it appears to me that, with all the good sense and benevolence which it breathes, he has omitted two things, which would, I am apt to believe, tend more to the improvement, as well as gratification, of the lower orders of society than any thing that

he has proposed. I allude to the formation of museums and public gardens. That every town, not to say city, in the kingdom should have its museum of curiosities, needs, I am convinced, little more than the cordial concurrence of the clergy, many of whom are men of the highest scientific research, as well as the most active benevolence. Under this view of the subject, I would propose that they should not only assist in the forming of museums in their separate districts, but I would also ask them to give, once or twice every week, a gratuitous lecture upon their contents. I would have these museums open to every one, without exception, and the popular as well as scientific name written in a fair hand over each object, as also some brief description intelligible to all. This, I am convinced, would not only excite a general spirit of enquiry upon subjects highly worthy of our attention, but also, when considered in reference to natural history, be highly calculated to render people both kind and benevolent in their dispositions: for what man will ever behave with cruelty or neglect to any of his mute dependants, when he is thoroughly informed as to the wonderful conformation of even the least animal, or as to how many striking resemblances there are between himself and the higher ones? When, also, his reflections are thus awakened, will he ever consent to abridge the happiness of creatures for the most part so useful to him, and who, unlike himself, can look to no hereafter in consolation for the miseries they may suffer here?

With reference to the formation of public gardens, you, Sir, are more *au fait* than I am, as to the way in which such a work should be commenced; all I contend for is their utility, in giving a taste for innocent and healthful pleasures, and, above all, in giving a taste for botany, the effect of which pursuit, if one may judge from the manners of gardeners, is more conducive to politeness and urbanity than either dancing or music, or even the study of the belles lettres, properly so called. Were I the clergyman of a parish, I would solicit even my poorest parishioner to contribute to the formation of such a garden. If he could not afford to give money, I would exhort him to give a plant or a seed, or a few hours' labour at stated periods from his *over-hours*; for which his name should be recorded in a book kept to preserve the names of the benefactors to the garden, and which should be read over every year on some great day, in the church after the service. The state of society produced by such improvements as those I have described would be such as, I am disposed to think, would supersede the necessity of itinerant teachers; indeed, I should imagine that, in such a state of things, no man would consent

to be an itinerant, as he could in all parts of his country find an agreeable home.

I certainly agree with Mr. Spence, that music, dancing, and the drama, have great weight in the scale of humanisation and moral education, but I differ from him as to the manner of their application. That the common people of England dance little at present, is not because they want tuition in that art or encouragement to practise it, or that they are simply poor\*, but is, I am persuaded, rather to be attributed to the depression incident to their present degraded condition. They have, I think, neither a dislike to dancing nor inability to practise it. For though country-dancing has given way to foreign elegancies of perhaps a higher order, in the shape of quadrilles, waltzes, &c., when I recollect the skill, as well as grace, which I have formerly seen displayed by the commonest people in these national dances, I cannot help thinking that neither encouragement nor tuition is necessary, in the common walks of life, for an art of which nature and content are the most efficient teachers we can have.

With respect to music, I cannot help thinking that the true remedy for the little felicity displayed by the common people of England in this charming art, would be found in an improvement of our national church music, and in the manner in which it is performed. For this purpose the clerk of every church should be a real singing-master, and a regularly bred musician, so as to be able to set the music in parts, according to the voices with which he has to do; and the children, or men and women who are to compose his choir, should be regularly taught by him, more especially those who might show any marked or particular talent. To the present drawling and bawling style pursued in even the greatest of our metropolitan churches, may, I am convinced, be attributed the style of the street singers, the itinerant musicians of our country; and even the bad taste displayed at these little singing clubs which are held in the parlours of public-houses, and which are often so annoying to us in the back rooms of our houses in the metropolis, is, I feel convinced, referable to the same cause.

I am, like Mr. Spence, a very great friend to the drama, but think that, for such an audience as he supposes, the representations should be for the most part composed of pastoral opera and caustic farce: the one ennobling, by the charms of poetry and song, a species of primitive and simple life, which, in some degree, must at all times be the lot of a great part of mankind; and the other, by ridicule, aimed, as one may say,

\* The Irish are very poor, and yet dancing is a favourite amusement amongst them.

at a species, most eminently calculated to cure individual errors. As an instance of the former I name the *Gentle Shepherd*, and of the latter the *Liar*, the *Weathercock*, &c.

With a system of education of universal application, and which I hope we may yet see every where established, with museums and gardens all over the country, with such a drama in our provinces, with such an amendment in our style of music, with a *revival* of dancing (which, by the by, implies with me an absence of national distress), Great Britain might indeed, as you, Sir, elsewhere observe, become such a paradise as at least has not appeared since the deluge.

I remain, Sir, yours, &c.

London, May 1. 1829.

VARIEGATA.

ART. III. *Some Account of the Public Orangeries, or Public Winter Gardens, of Berlin.* By M. G. A. FINTELMANN of Potsdam.

Sir,

WINTER gardens, as far as I know, exist no where else but in Prussia. In Potsdam we have only one, that of M. Voigt, very good and very highly kept; but at Berlin there are four, M. Teichmann's in the Thiergarten, Faust's and Georges's both within the town walls, and Moeve's on the Potsdam Road. The original of these gardens was established by M. Bouché soon after the time of the general peace, but his garden is now quite neglected, and the leading establishment ever since 1818 has been M. Teichmann's.

These gardens are simply large green-houses, or what would be called in England orangeries, with paved floors, a lofty ceiling plastered like that of a room, and upright windows in front. The air is heated by stoves, which are supplied with fuel from behind. On the floor are placed here and there large orange trees, myrtles, and various New Holland plants in boxes. The plants are mostly such as have a single stem of at least 3 or 4 ft. in height, and round the stem and over the boxes a table is formed by properly contrived boards, so that the tree appears to be growing out of the centre of the table. These tables, which are sometimes round, and sometimes square, are for the use of guests, either to take refreshments, or for pamphlets and newspapers. Sometimes on each table there is a circle of handsome odorous plants, such as hyacinths, narcissuses, mignonette, &c. in pots, round the stem of the plant; in other cases, there is no table, but the box is covered with handsome flowering

plants; and in some parts of the floor, one handsome tree in the middle is surrounded by several smaller trees and plants, so as to form a mass or clumps of verdure and flowers, such as we see in pleasure-grounds.

The flowers which are generally found in these winter gardens throughout the winter are hyacinths, narcissuses, ranunculuses, tulips, crocuses, roses, heaths, camellias, acacias, epacrises, correas, &c. There are also various climbers, curious or showy stove-plants, pine-apples in fruit, cactuses, &c., and sometimes even fruit trees, the latter both in flower and in fruit. The proprietors of the gardens have generally small forcing stoves, for the purpose of bringing forward and keeping up their supplies.

It is almost needless to say that in these gardens or orangeries there are plenty of seats, and small movable tables, and generally music, a reciter of poetry, a reader, a lecturer, or some other person or party to supply vocal or intellectual entertainment; short plays have even been acted in them on the Sundays. In the evening the whole is illuminated, and on certain days of the week the music and illuminations are on a grander scale. In some of these orangeries, also, there are separate saloons with billiards, for ladies who object to the smoke of tobacco, for card-playing, and for select parties.

If you enter these gardens in the morning part of the day during the winter season, you will find old gentlemen with spectacles reading the newspapers, taking chocolate, and talking politics; after three o'clock, you see ladies and gentlemen, and people of every description, sitting among the trees, talking or reading, and smoking, and with punch, grog, coffee, beer, and wine before them. In the saloon you will see those gentlemen and ladies who cannot bear tobacco; and I ought to mention that in some orangeries smoking tobacco is not allowed, and in others it is only permitted till a certain time in the day.

When the audience leaves the theatre in the evening, you will find in M. Faust's garden, a great number of well-dressed people of both sexes, who look in there before they go home, to see the beauty of vegetation when brilliantly illuminated by artificial light, and to talk of the play, and the players.

I saw no garden in England, Scotland, or Ireland, that I could compare to these winter gardens; they appear to me very suitable to a capital town, though I do not think they would be much frequented by the people of London, who have not the same taste, nor the same leisure, for these kinds of amusements that the Berlin people have.

In my next letter, I shall probably describe what we call town gardens, which answer to your Kensington Gardens, and to the Phoenix Park, in Dublin.

I am, Sir, &c.

*Pfaueninsel, Feb. 20. 1829.*

G. A. FINTELMANN.

---

ART. IV. *An Account of some Experiments in Physiological Botany, undertaken at Welbeck in 1823-24, and repeated in 1825, with a View to ascertain the probable Cause of Failure in Early Forced Grapes.* By Mr. JOSEPH THOMPSON, Gardener to His Grace the Duke of Portland.

Sir,

IN December, 1823, and January, 1824, I placed some vines in pots at the front of a low Calcutta pine-stove, and introduced the tops of the vines into the stove, through the 9-inch brick wall, one near the entrance of the fire-flue, and the other more distant from the fire, stopping the wall with moss, and protecting the roots from frost with stable litter in the usual way. I examined them every day, and on the 12th or 13th day (I made no notes that year) I found them begin to vegetate at the top buds; I then wounded them in different places daily, and found the sap descend in regular progress from the tops to near the front wall; when that near the fire-place began to wither, the first shoots became curled, downy, and quite stagnant, the other vine did the same in a day or two after. Those vines did not recover, nor were in health at the tops all summer; but some shoots came out near the surface of the pots in the first week of April, which were very healthy, and 5 or 6 ft. high before the autumn.

I then determined to change the usual practice, in the first operations of the early forcing the next season, and resume those and other experiments with greater precision by taking notes, &c.

In January, 1825, I selected two strong vines, and cut them down to 5 ft. 6 in. high, the wood was firm and good, they were re-potted into full-sized peck-pots, leaving the balls entire for daily inspection.

On the 24th of January, these vines were placed in the same places as those mentioned in the last year's experiments: that nearest the fire-place was only protected from frost in the usual way, without paying any regard to roof and rain-water; the other was protected from roof and rain-water by a larger quantity of manure in a state of fermentation. Both vines reached full 4 ft. within the stove, which contained



pine-apples in a forward state, some ripe and others nearly so, and the temperature was kept up from  $65^{\circ}$  to  $80^{\circ}$ . The weather in the last eight days of January was changeable; the medium of heat was  $43^{\circ}$ , of cold  $33\frac{3}{8}^{\circ}$ ; and the rain fallen in the same time was only  $\frac{1\frac{3}{8}}{100}$  of an inch.

I examined both vines daily within the stove, and at the roots. On the 2d of February the top buds of both were turgid; on the 3d, the top buds had shed off their envelope, and were ready to break into leaf, and the other buds were in successive progress. I then cut through the bark and alburnum into the wood, but not to the medulla, the two top joints bled freely, and the third was just moist, and at a foot from the top they were quite dry; the wounding and examination of the roots was continued daily, and often twice a day, and the sap descended in regular progress until it reached the cavity between the fire-flue and front wall, when a visible check appeared, which the vine nearest the fire-place never got over.

On the 20th of February, the protected and excited vine began to bleed outside the wall, it had taken four days more in passing the air-flue and wall, than in passing the same space in the more temperate air of its upper parts. On the 21st, this vine bled freely at the surface of the soil; on the 23d, it began to make fibrous roots in the soil that enveloped the whole ball, and put out fine, strong, new roots at the surface. During the above interval of thirty days of the experiments, and twenty-two days of vegetation, nearly all the buds on this vine had vegetated in regular succession; I never could perceive the least check or stagnation in its leaves or shoots; it had two small bunches of grapes on it, which were just coming into bloom, one of which was cut off. On the 28th of February, a change of texture in the foliage began to appear; the tender almost transparent green changed to a fixed, dark, substantial green, with clear indications of laterals at the first-made shoot joints, the sap at all the lower wounds had now dried up. The weather of this month was mild for the month of February, the greatest cold was  $22^{\circ}$ , the medium of heat was  $46^{\circ}$ , and of cold  $34\frac{3}{8}^{\circ}$ , with only  $\frac{2\frac{8}{10}}{100}$  of rain.

On the 20th of February, the vine which was neither protected from rain nor excited, began to droop and stagnate, the shoot ends became brown, downy, and sickly altogether; no sap ever exuded outside the wall; the roots never showed the least signs of vegetation; the three bunches of grapes shown upon it curled up and withered away.

On the 1st of March, I removed both vines into another pine stove; the excited vine continued healthy, and ripened the bunch of grapes left upon it.

On the 10th of March, the unprotected vine began a fresh vegetation at 6 in. from the soil; on the 12th, a fine, strong shoot came out at 4 in. from the soil; on the 15th, the roots began to send out fine, white, fresh fibres all around the ball as well as at the surface of the soil. The new shoot made rapid progress, but the top never recovered, nor made any fresh shoots all summer.

I had to destroy a largish grove of birch and other trees to make room for a plantation of evergreens, which gave me an opportunity to repeat the experiments on them. I examined them every day; and, on the 7th of April, I found the buds at the extremities of the shoots just beginning to open. On the 8th, I cut off the extremities of two branches to about half an inch in diameter, near the tops of two trees (which were about 25 ft. high), and put the remaining branch ends into two glass bottles, which I left suspended there; the branches bled freely into the bottles. At the same time I wounded several side shoots in various places, as well as the trunks from the tops to the ground, at 2, 3, or 4 ft. distance. I then cut some trees down to see if I could detect sap or air rising from the root-stumps, but I found them quite dry, they would not soil fine white paper which I applied to them. I then made two of them very smooth, and anointed one over the surface with fine size of wheat flour, which set fast and dried on. The other was covered over with fine, prepared, red clay paste. I opened the ground, and wounded some strong roots, and tracing the fine fibrous roots to the end found them brown and torpid. On the 9th, the bottles contained a good deal of sap, and the branches and tops of the trees oozed a little. On the 10th, the bottles were nearly as full as the oblique position they were of necessity placed in would allow; they were taken down and replaced by others. This sap was remarkably limpid, and seemingly contained a kind of fixed air by the crackling hissing noise it made, though no effervescence could be seen in a clear glass phial. By the appearance of the sized and clayed stumps (under a pocket microscope of 2-in. power), the medulla and alburnum rather absorbed than raised the applications.

On the 11th, the branch ends had stopped bleeding; the bottles contained a little sap, which was thick and muddy, and had no crackling nor hissing noise. The trees now exuded nearly half way down.

On the 12th, there was no alteration in the stumps or trees felled this day; the bleeding had descended 5 ft. 6 in. in twenty-four hours.

On the 13th, the progress of the sap was the same, and no alteration in the stumps or felled trees this day. On the

14th, there was no alteration in the stumps, the sap reached nearly to the ground, and the upper wounds were encrusted over with a nasty fetid mucilage. During the above eight days, the weather was fine with a good deal of sun. Medium of heat  $61^{\circ}$ , and of cold  $40^{\circ}$ .

In the night before the 15th, the weather changed to a sharp cutting wind, and the sap ceased to flow from any of the most recent wounds. No alteration in the stumps or trees till the evening of the 20th except a very slight exudation from the trunks of recently felled trees, which, when wiped off, appeared to come from all parts of the wood, medulla, and alburnum alike. Medium of heat those six days  $52^{\circ}$ , of cold  $41^{\circ}$ .

On the 21st and 22d, a little sap exuded from the most recent wounds and felled trees, which was quite thick and glutinous. Those two days were fine, with  $64^{\circ}$  and  $66^{\circ}$  of heat.

At this time, the strong roots would exude just sufficient to moisten dry earth dusted on a recent wound; and the extreme ends of the fibrous roots looked white, just as if they were beginning to grow.

On the 23d, heavy rain and cold set in, and continued to the 30th; during which time I could not find the least change in the young shoots, which stood at one, two, or three young leaf joints, and about as many inches long, or did the roots advance, no sap exuded from roots or branches. The medium of heat in the last ten days was  $50\frac{8}{10}^{\circ}$ , and of cold  $42\frac{3}{10}^{\circ}$ , and  $3\frac{3}{10}$  in. of rain had fallen.

The observations were continued to the 4th of May, on which day, all the standing trees, and stumps of the felled trees, clearly denoted an extension of young wood and roots, and a mucilaginous matter rested on the surface of all the stumps with minute globules of air in and under it. Whether the air was from the combined effects of rain, sap, and heat, or came from the root stumps I could not distinguish. In the last four days,  $\frac{4}{10}$  of an inch of rain had fallen in genial showers; and the medium of heat was  $62^{\circ}$ , and of cold  $46^{\circ}$ .

This terminated these experiments; but others had been made with exactly the same results as to the primary motion of the sap, and progress of vegetation: but, with regard to time, there was a material difference; viz. a vine in a pot put into a pine stove, on the 13th of March, completed the process in eight days, and a small birch tree in a pot, put in the same situation on the 5th of April, got through the same process in rather less than five days.

Yours, &c.

Welbeck, Feb. 1. 1826.

JOSEPH THOMPSON.

ART. V. *An Essay on Physiological Botany, in Continuation of the Experiments described in the preceding Paper.* By Mr. JOSEPH THOMPSON.

Sir,

AFTER four years more of extensive practice, and close attention to the ordinances of nature in this branch of my profession, I am satisfied that the present theoretical system of vegetable phenomena was founded in error by Malpighi and Grew. Had they commenced their experiments earlier in the season, and wounded the extremities of the branches, they would have obtained pure limpid sap many days before they got it in the cylindrical wimble holes, in which they never could discover from what part of the cylinder it was produced, the accumulation would only appear in the lower segment of the cylinder, which naturally led to the supposition that it was propelled upwards.

The late Sir James Edward Smith, in his *Introduction to Physiological and Systematic Botany*, has brought into view most of the experiments made on this subject, from the time of Malpighi down to those of Thomas Andrew Knight, Esq., whose experiments on the cuttings of fig trees are recorded in the *Transactions of the Philosophical Society* of 1801, 1803, and 1804.

The Rev. Mr. Keith has also collected all that has been written on this subject. The experiments conducted and related by those very scientific persons do not, however, appear to me satisfactorily to establish the conclusions that have been drawn from them, and I now proceed to add to my former observations on this subject a statement of facts which seem to impugn their solidity.

Sir J. E. Smith, in his book above quoted, says, "much contrariety of opinion exists on the vascular system of plants, propulsion of sap, &c." The excellent plates of Anthony Todd Thomson, in his *Lectures on Botany*, show that the anatomy of plants and the vascular system are correctly understood; but the propulsion of sap, its change to cambium and deposit in wood, the time occupied, and temperature most congenial to those operations in the vegetable system, are clouded in darkness.

The following quotations will show that some writers have accidentally hit upon the true system, in so far as regards the primary motion of the sap.

In Miller's *Gardener's Dictionary*, second edition, printed in 1741, under the article *Pérsicum* (Peach), he says: "It sometimes happens that the roots are buried too deeply; for the sap which is contained in the branches being put strongly in

motion by the warmth of the sun early in spring, its strength is lost before the sun can reach its roots to put them in equal motion, which causes the blossoms to drop off and the shoots to become stagnant."

The above quotation is susceptible of strong comments, but I proceed to notice Mr. G. Bliss's *Practical Treatise on the Cultivation of Fruit Trees* (1825). At page 60., on Grafting, he denies any influence of the stock on the scion engrafted thereon, and says, "the fund of vegetable matter above ground must be filtered through the roots," &c.; and that "the stock partakes of the nature of the scion; for there cannot be an existing doubt but that the roots, veins, fibres, or whatever they may be called, strike from the scion into the stock, and run downwards to the extremity where the sap flows." He then gives an instance of a variegated jasmine being budded on a common green one, and several of the buds below the one inserted became variegated.

Mitchel in his *Dendrologia*, published in 1827, denies the circulation of sap, and designates the branches, fronds, buds, and leaves, as caterers to the tree.

Van Helmont's experiments on the willow tree, which increased 119 pounds in five years, and only wasted 3 ounces of earth, show that the sap to sustain the tree, with its increase of 119 pounds, could not be derived from the earth, or else a greater waste must have taken place. Or must all that increase be attributed to the distilled water he gave it?

I now offer some instances of practical operations occurring yearly in the plashing of quickset hedges, which is done by the common labourer, who cuts out all such shoots as are not wanted for the layers; the latter he cuts nearly off, leaving no more than a bit of bark, and a small thin portion of wood on one side, the substance of which, in the case of a strong layer, is not more than a common leather strap; the thinner it is, the better for the layer. Here we see the epidermis, cortical body, liber, wood, corona, and pith, all severed, and, in some cases, part of the stump or stock cut off, leaving 4 to 8 in. space between the body of the stool and layer. Yet we see the layers in a full healthy state of vegetation, with an exudation of sap from the lower end, many days before the gaseous atmospheric influence acts upon the stock or stump. In this case I do not see that it is probable, and scarcely possible, that the ramifications of the layer, to the extent of 10 or 15 ft., could be fed and supported by the small, strap-like, connecting splice at the bottom.

The most superficial observer must have seen moderate-sized elm trees vegetate strongly the first, and weakly the se-

cond, year, after they are felled and laid by without either root, but, or top branches.

In the spring of 1826, I noted a knotty arm or branch of *Pseudacacia* (Cobbett's Locust Tree), about 12 ft. long and 10 in. in diameter, accidentally thrown across other pieces of wood, under the shade of a yew tree, and in a damp situation, but supported at least one foot from the earth. Most of the burry knots vegetated more or less; one shoot attained a length of 15 in.; in the following winter the upper end of this shoot perished, but, in the spring of 1827, the remainder vegetated, and produced the length of 9 in. more of young wood; and vegetation also took place on every knot, to within about 2 ft. of each extremity of the piece or arm.

I was informed by an intelligent and sensible woodman (the late Mr. Yates), that he saw a willow, or sallow, pole, pointed at both ends, and put into the middle mortices of two three-holed posts in the gap of a hedge, under the shade of some sallow trees, in a moist situation by the side of a rivulet, which vegetated two years.

All men who fell and peel oak timber will verify the fact, that the tree will peel earlier in the peeling season, and easier at top than bottom.

In the striking of hard-wooded heaths, and other choice botanical cuttings, as well as those of the gooseberry and all the tribe of *Sálices*, we are sure that nothing can be derived from the earth at the outset of the operation, the power of vegetation must be contained in the cutting, and that sufficiently to create its own roots and perfect the rooted shrub or tree. It is found in practice that a vine cutting, planted ever so much, say a foot, below the surface, will only make roots at that bud nearest the surface; and a single bud, cut off a shoot with a small portion of bark and wood, not larger than a horse bean, will produce as good a plant as a cutting a yard long.

I offer one more practical proof of the descent of the sap, which demonstrates that every bud of a tree contains the same latent vitality as that contained in the seed sperm. But the means of preserving the vegetating powers of the cuttings and buds is very limited. Oranges have been grafted in almost every month of the year, and pinks and carnations, and other herbs, may be propagated by cuttings in all the spring and summer months. The proof I offer is in the grafting of vines out of season. In the last two years I took cuttings for grafts off the latest vines; those I preserved in a temperate cellar, until the fruit of the earliest forced vines was all gathered, the leaves fallen off, and the vine wood as dry and torpid as an oak tree in January. I then inserted the scions by vertical

incisions, leaving the tops of the vines entire; the inserted grafts soon vegetated, and became lateral branches, and were the only parts of the vines which showed the least signs of life, for months after their insertion. If those grafts derived the vegetating power from the stock of the old vines, it is an unaccountable circumstance that no other part of the vines vegetated before the approach of the next forcing season.

This fact alone is quite sufficient to show that the present notions on this branch of the botanical system are incorrect and erroneous.

Yours. &c.

Welbeck, April, 1829.

JOSEPH THOMPSON.

ART. VI. *Further Improvements in the Mode of heating Hot-houses by hot Water.* By ROBERT BYERS, Esq.

Sir,

SINCE I had the pleasure of addressing you, on the hot-water system, many improvements have occurred to me, arising from various causes, the principal one, that of having my small houses and pits to remove to this place, and to re-erect; also, from the numerous communications which I have received in consequence of my letter to you. As space in your Magazine is valuable, I will not explain how, or why, these plans occurred to me, but at once attempt to detail them, first giving what I consider the proper powers of a hot-water apparatus, and, without these powers, it does not appear to me that it can fully answer the purposes of the horticulturist with certainty: 1. It should have the means of producing rather more heat than *may* be required; 2. of applying that heat at pleasure, and in a very short time; and 3. of retarding that heat when necessary. These properties are certainly to be obtained by the use of water, and, as a general guide, every apparatus should, when in full work, have the power of raising the temperature of the house, frame, or pit, from  $45^{\circ}$  to  $55^{\circ}$ , or even  $60^{\circ}$ ; granting it has this power, and the thermometer sinks to  $20^{\circ}$  out of doors, the temperature in your house will be  $65^{\circ}$  to  $80^{\circ}$ , which I conclude sufficient for all winter forcing.

For some time I have been anxious to determine the exact quantity of heat given out by each foot of pipe of a given size, at a certain temperature; or, in other words, how many cubic feet of air can be raised to a required temperature by a given quantity of water, say at  $120^{\circ}$  of heat. Perhaps some of your mathematical readers may be induced to make the experiment.

and calculations ; for, were this known, we should at once have a rule for erecting an apparatus for houses of any dimensions. Until this be established, the following “ rule of thumb ” plan, which I have just adopted, will answer. ( *Fig. 53. A B.* )

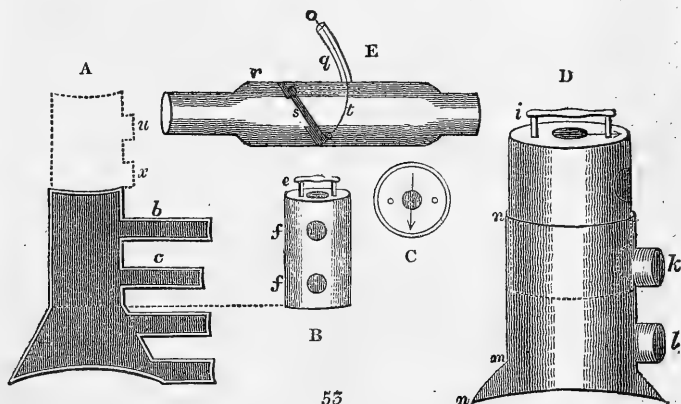

EXPLANATION OF REFERENCES.

A, Section of the boiler, showing the second range of pipes (*b c*). Suppose them all to be 4-inch pipes, the height of the boiler would be 32 in., allowing 4 in. between the pipes. It should be of copper.

B, The new valve, which should be of copper or brass, and made exactly to fit the boiler. For the above boiler, it should be 18 in. long, and have two circular holes (*f f*) cut in it of the diameter of the pipes, so that when it is pushed down into the boiler the holes may be opposite the pipes. This portion of the boiler, and the valve, should be nicely ground together, but not so tight, but that the latter may be turned round by the handle (*e*, and in *fig. D, i*) at the top. There is also an opening left at the top to allow the steam to escape, and not endanger the vessel by bursting.

C, The top of the valve (*D*). The arrow points directly over the holes, so that should it be turned for the purpose of closing the pipes, the exact proportion closed is visible ; and to entirely shut the communication, the head of the arrow should be the contrary way of the pipes.

D, The new boiler, with the valve half drawn up ; the bottom is larger and concave (say 18 in. diameter) to receive more heat, and the returning pipe (*l*) is 4 in. above the bottom. If the pipes are 4 in. diameter, the boiler from *m* should be 12 in. diameter, and 20 in. high from the top to the bottom, i. e. from *n* to *n*.

*k*, The delivering pipe.

*E*, The lateral pipe, with a part enlarged to admit the valve (which is of brass) to open to the diameter of the pipe.

*s*, The valve placed diagonally, so that its own weight may shut it. A collar of brass is soldered to the pipe, and ground to fit the valve, so as to be water-tight.

*r*, The hinge.

*t*, Wire attached at the bottom to open it ; this wire passes through a small tube (*q*), and may be fastened in any way most convenient.

The dotted lines represent the valve open. The small tube should be as high as the top of the boiler, otherwise the water would escape through it.

The proportions mentioned are only as general guides, and the drawings are not to any scale.



Concluding that my sketches are understood, I will detail their application. The apparatus being filled with water, you close the valve, and the *lower* pipes gradually become heated (thus far is the old apparatus); but should you require more heat, by turning quite round the valve, or only half turning it, as may be required, the hot water at the top of the boiler instantly forces the cold water out of the upper pipes, and you have a second range of *hot* pipes, and by the use of the valve you may regulate this heat at will. I would also have above the second range of pipes, a sufficient space to allow of a third range, should it be found requisite; and this can be done by having shoulders made in the boiler, as represented by dotted lines (*u x*), and these orifices closed with plates of tin or copper, which (should a third range be required) could easily be unsoldered, and the pipes adjusted without altering any portion of the original apparatus. Through the summer, the *second range*, probably, would not be required, and by having a cock in any part of the apparatus, the water may be entirely drawn off, so as to leave them empty, the boiler then having only the lower or *original* range to heat.

These hints (which I cannot but flatter myself are valuable), perhaps, best apply to such apparatus as have failed in producing, through this severe winter, the requisite temperature; but should we know what quantity of pipe (or properly water) will heat a house, the single range can be used; and then, for the purpose of regulating the heat, I would recommend the valve and boiler *D*, which, closing the pipes in part or altogether, must produce whatever temperature you require. I am speaking of an apparatus possessing the power alluded to in the former part of this communication.

Before the above occurred to me, I had a valve made (*s*), which I fitted into a glass 1-inch tube, and adjusted it to fit one of my lateral pipes (fig. 4. p. 20.); the glass tube was 3 ft. long, and was introduced in the place of the metal pipe, for the purpose of observing the motion of the water. This little apparatus answered very well, although it was not entirely cold, as it received heat at the end of the pipe *b* (fig. 4. p. 20.), but when the valve was open, its effect was almost instantly perceptible, not only by the motion of the water, but by the additional heat.

I cannot allow this letter to go to you without detailing my method of applying the hot water. Necessity is the mother of invention; and when I was about removing my plants, I could not take down my hot water apparatus until my plants were removed, and I could not remove the stove plants until I had a proper receptacle for them. Accordingly, I built a pit after

Mr. Stewart's plan (Vol. I. p. 71.), only so arranging my fire-place, that it would heat the boiler of my hot water apparatus in the pit adjoining. By this plan, I have an excellent and steady heat produced at no expense; for I must have had a perpendicular flue for my boiler, instead of which I have placed it horizontally, and applied the heat of the flue to the house. Finding how well Mr. Stewart's pit worked, I, *in part*, abandoned my lateral pipes, and have made (in my hot-house) floors over the pipes, on his plan, filled with sand, and find the whole to succeed in the most delightful manner imaginable; the temperature of the sand being from  $76^{\circ}$  to  $80^{\circ}$ . The advantage of the hot water over the fire flues is, that you cannot over-heat your sand, and the temperature is more uniform, and will continue several hours after the fire is out. I think I cannot be here out of place, in offering my best thanks to Mr. Stewart, for the hint which his communication has afforded me.

It may be satisfactory to some of your readers to know, that I have even made the water boil in the apparatus (*a*) whilst the valve was closed, so that only the lower pipes were at the boiling point, and of course the water, to the top of the boiler, but the upper range of pipes were almost cold; the pipe (*c*) was quite cold; the pipe (*b*) received a slight portion of heat close to the boiler, but I consider it to arise from absorption. Whilst the apparatus was in this boiling state, I turned the valve half round, and in six minutes both pipes were heated, as well as a small reservoir attached to them at 7 ft. distance. The hot water, therefore, displaced all the cold water in the reservoir, and in 14 ft. of pipe, in the space of six minutes.

I am, Sir, &c.

ROBERT BYERS.

*Mount Pleasant, near Swansea, April 23.*

---

ART. VII. *Notice of a durable Number Tally of Earthenware.*  
By Mr. WILLIAM ANDERSON, F.L.S. H.S. &c. Curator of the Chelsea Botanic Garden.

Sir,

A DURABLE numbering tally has long been a desideratum in the nurseries and botanic gardens. The late Mr. W. Curtis, author of the *Botanical Magazine*, procured a label of Wedgewood-ware; it was very clean and showy, but did not stand the frost. Within these two or three years, we have

seen iron tallies of various shapes, but their being so near the ground, and their exposure to wet and frost, proved very injurious to them. In the young-tree quarters of the nursery-grounds, spokes of old wheels are made use of for this purpose; but in hard winters, we have known of some hundreds of these sticks being carried off in a night for fire-wood. In the botanic garden here, as every where else, the numbering sticks are liable to the injuries of frost and rain, and although the wood may endure for ten or twelve years, the tallies require painting every four or five years.

To obviate these defects as far as possible, we consulted with our potter, Mr. James Marshall, of Norwood, in Surrey, who engaged to provide us with 5000 at  $1\frac{1}{2}d.$  each, in order to renew the sticks of our herbarium department. These tallies (*fig. 54.*) are made of the same clay as garden pots, and Mr. Marshall says he can make them at 8s. per hundred, having procured the moulds, &c. The top of the tally being bevelled off in the manner of a writing desk to receive the number, and having had four coats of good white lead paint, it will be washed by every shower; and should we find that the wet gets under the paint, we have only to continue the paint down 3 or 4 in. Respecting the strength of these tallies, 2600 came in the first cart load, and although they were laid upon one another without pack-  
age, there were only fifteen of them broken. They are from 11 to 12 in. in length, 2 in. in breadth,  $1\frac{1}{8}$  in. thick, and the size of the bevelled part is  $1\frac{1}{2}$  in.



I remain, Sir, yours, truly,

*Botanic Garden, Chelsea, Feb. 4. 1829.*

W. ANDERSON.

ART. VIII. *On Landscape-Gardening, as a Part of the Study and Business of Practical Gardeners.* By a LANDSCAPE-GARDENER.

(Concluded from p. 42.)

WITH respect to the distribution of such plants for the purpose of thickening the interior, or enriching the margins, of woods, they should be disposed in very irregular parts, to produce not only a general screen, but also an intricacy of outline of themselves; sometimes advancing beyond the exterior, or retiring back towards the middle, of the wood. Views into the wood may be marked or bounded by the

undergrowths; care being taken that the eye does not see through it, except for the sight of some suitable object.

Open groves may be greatly improved by a judicious disposition of such undergrowths. Insulated groups of trees should always have a base of holly, juniper, and whitethorn; the latter is an excellent protector of the honeysuckle roses, or any other climbing plant; even single trees are improved in character and appearance, when they give protection to an humble neighbour.

When the woods and groups of the park are thus planted, the naked baldness so often complained of will be remedied; the detached parts will be better connected; the hard profiles of clumps softened; and the whole will then partake of the semblance of the more dressy features of the pleasure-ground, an advantage of no small importance.

In forming new plantations of forest trees, the above directions (which are all plain practicable matters) are easily executed; it is only sowing the ground with the seeds of the undergrowth, after the principal trees are planted: the whole will then rise together, and yield many supernumeraries for other purposes. Old scenery may be improved by transplantation, or sowing the seeds of the kinds above mentioned; but this requires much more care and expense than when done at first.

Before concluding these observations, it may be necessary, perhaps, to advert to the different characters of trees as belonging to the different descriptions of scenery hereinbefore specified; a view of the trees themselves will give better ideas than the most lengthened description.

*Beautiful Trees.*— Among these the deciduous cypress (*Cuprèssus disticha*) is perhaps unrivalled; the mild tint and soft wavy tufts of its delicate foliage, the elegant ramification of its branches and spray, and the light feathery appearance of its general form, mark it as a tree of singular beauty. The bark, though dark brown and rather rough, contrasts agreeably with the gay verdure of the foliage, and it is altogether a plant deserving the most conspicuous place in the most dressed scene.

Partaking of the same characteristics, in a greater or less degree, the following are preferable, viz. the acacia (*Robínia Pseud-acàcia*); weeping willow (*Sàlix babilónica*), where the climate or situation is favourable; white hiccory (*Juglans álba*); ailanthus (*Ailántus glandulòsa*); storax (*Stýrax officinàle*); weeping birch; common lime; common beech; Weymouth pine; white cedar (*Cuprèssus thyòides*); red cedar (*Juníperus virginiana*); and the common ash, when young. Most of these associate

well with buildings; their soft outline and mellow colours harmonise so well with the lines and shadows of the architecture.

*Picturesque Trees* are all such as present a bold rugged outline; trunk stout, deformed, knotty; branches tortuous, and irregularly projecting; spray and foliage in dense and strongly marked masses. Such are the common oak, Spanish chestnut, cork tree, cedar of Lebanon, pinaster, the Scotch fir, common ash, and elm when old.

*Magnificent Trees* are such as, from the splendour of their flowers, extent of their branches, extraordinary size of their boles, history, or great age, claim admiration. The venerable remains of trees many centuries old are magnificent even in ruins; and, where they exist, should be religiously preserved.

The generality of forest trees, when placed in their natural situations, and allowed to show their natural forms, are all more or less ornamental; and though they take no decided character, individuals of any kind may occasionally be adventitiously characteristic. Almost all old pollard trees are picturesque; young oaks, firs, or elms may be beautiful; but none can be magnificent without great age or magnitude.

The plants of strongly marked character which I have before alluded to, as proper for the foreground of general scenery or for particular views, are such as follow:—The tree mallow (*Lavatera arborea*); palma-christi (*Rícinus commúnis*); Nepal rhubarb (*Rhèum austràlis*); hollyhock (*Althæa ròsea*); *Erýngium plànum*; *Acánthus lusitánicus*; *Heliánthus altíssimus*; some of the strongest-growing hardy firs; and any other large-leaved plants *which are in cultivation*.

These gigantic herbs must be out of the reach of cattle. Their strong lines and distinct forms are indispensable in the painted landscape, for reasons before mentioned. They are, however, less necessary in real scenery, because the spectator can ascertain distance by other means than by the mere diminution of objects.

Exotic scenery may be expressed or represented in gardening, where local or other circumstances are favourable. Italian may consist of suitable structures, trellises, &c., furnished with vines, portable orange, lemon, pomegranate, olive, and myrtle trees. A Chinese conservatory, filled and surrounded with Chinese plants, may be easily and very naturally executed. A glazed mosque, pyramid, or pagoda, containing palms, &c., within, and ornamented without with tropical plants, &c., might give a pretty good idea of the scenery of the torrid zone. To design such things, only requires a little knowledge of the botanist and the traveller.

While on this part of the landscape-gardener's business, it may be observed, that the increased and still increasing stock of new plants promises an extension of the means of the planter, as well for his arboretum as for his woods. New features in grouping may be given, and additional value acquired, by the naturalisation of useful trees. Add to this the great improvements made in every branch of mechanics; the facility with which lofty and elegant horticultural structures are raised and economically heated, for the protection and cultivation of new fruits; together with the rapid advancement of every branch of gardening. All this adds scope to the conceptions and field of action of the designer. His art must be progressive; and, so long as he can unite value and substantial territorial improvement with the lighter, though pleasing and more tasteful, part of his profession, so long will it be valued and encouraged in this as in every other civilised state.

To qualify himself for such a task, the young designer must not consider the arrangement of scenery as his only business. While he is embellishing a place, he must also add to its value. All the advantages of the soil and situation must be obtained and preserved. The indispensable produce of meadows, pastures, orchards, corn fields, and woodlands, must all be considered in his general plan. The whole, in short, must be profitable as well as delightful.

To be competent to all this, besides being acquainted with those objects in nature which, singly or combined, delight the eye or gratify the mind, he should possess a general knowledge of architecture, botany, horticulture, agriculture, and arboriculture. He should also have a requisite knowledge of geology, draining, and the management of water; as well as fencing, road and walk making, embanking, &c. &c. To be able to apportion the requisite particulars of a country-seat, he should know somewhat of domestic establishments, as suitable to the rank or fortune of his employer; and, finally, he should know as much of mathematics and drawing as will enable him to measure, sketch, map, or plan whatever alterations or improvements he suggests, or is called upon to execute, and give an estimate of the probable expense, if required.

I now conclude this hasty sketch of the subject proposed. Written at different times and places, I fear there is a want of connection. It is probably too brief for some readers, and a great deal too long for others. I have only to wish it may be any way useful to those for whom it is intended.

I am, Sir, yours, &c.

Nov. 20. 1828.

A. Z.

ART. IX. *Description of an ornamental Conservatory in the Grecian Style of Architecture, built by Mr. Robert Roberts, Plumber, Glazier, and Gas Proprietor, Oswestry, Salop. By Mr. ROBERTS, and J. P.*

THE design of the exterior (*fig. 55.*) is a chaste specimen of Grecian architecture, combining an appearance of strength with every facility for the admission of the light necessary for a

55

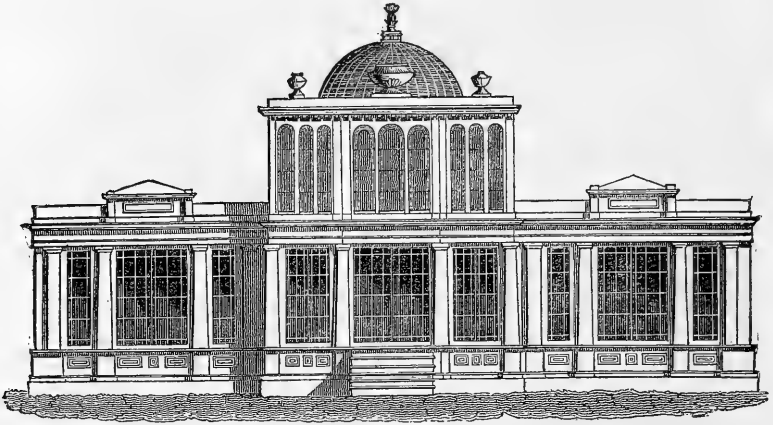

building of this description; the interior exhibits the most tasteful style of ornament, with the best arrangements for convenience. The whole of the timber used in its construction is of the best description, and well seasoned; framed together upon the most scientific and approved principles and in the most substantial manner, with wrought-iron bolts, bars, screws, plates, and the various descriptions of fastenings. The glazing is done with the best crown glass, and the lights varied and ornamented with side squares of ground glass. The centre is supported within by Doric columns; the several compartments of lights ornamented with pilasters, architraves, and suitable mouldings; and the fasciæ below the domes and cornices enriched with appropriate ornaments. A light and elegant gallery surrounds the interior, to which a handsome stair-case is attached, lighted by a window of stained glass in various tasteful devices. The roof is framed with wrought-iron rafters, fixed and bolted to the beams and wall plates; the dome and barrel lights in the roof (*fig. 56.*) are made of fine metal, and the utmost care has been taken in fitting the glass to unite durability with neatness. The whole

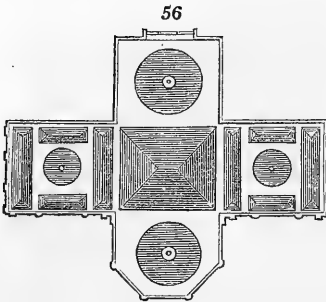

will be heated by hot water by troughs constructed under the floor, and there are also basins in the floor (*fig. 57.*) suitable for water and plants intended to be stationary.

This conservatory has been erected under the immediate superintendence of the proprietor (assisted by professional horticulturists of eminence), who has spared neither pains nor

expense to render it convenient, substantial, and ornamental; and it is so framed together as to render it removable to any distance that may be required, free from the hazard of any damage to any part of it.\*

In the hot water pipes shown in the ground plan, (*fig. 57.*) the arrows show the current and counter-current of the water. The boiler and principal apparatus is not shown; as the proprietor intends taking out a patent for his improvements in heating and regulating the temperature of hot-houses, pine houses, conservatories, and other buildings.

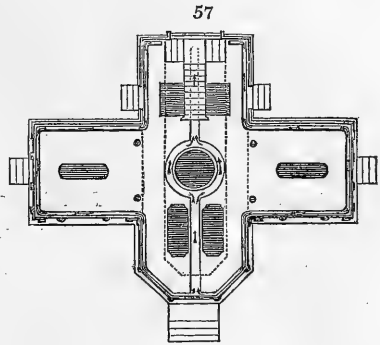

I am, Sir, &c.

Oswestry, Feb. 23. 1829.

ROBERT ROBERTS.

“THE arrangement of this conservatory seems to me to be excellent, as uniting a higher degree of classic purity with the profusion of glass required in such a building, than I have met with elsewhere. I speak of the *architectural* arrangements, in which light I have chiefly considered it. In this I remark the skilful manner in which the four internal columns have been disposed, and the way in which the ceilings, belonging to the two wings, have been lighted. The effect from the end of one wing, where these columns are seen in

\* This conservatory is to be disposed of, and would be an acquisition to any gentleman or lady, who may be in want of such an addition to their pleasure-grounds or mansion. It may be viewed at any time by applying to Mr. Robert Roberts, Gas Proprietor, Oswestry, Salop.



perspective, appears to me better than that of the larger central space, on account of them. Respecting the central part, I would suggest as an improvement, if it could be consistently managed, that a few columns of the same Doric as those that separate the wings from the centre should be

58

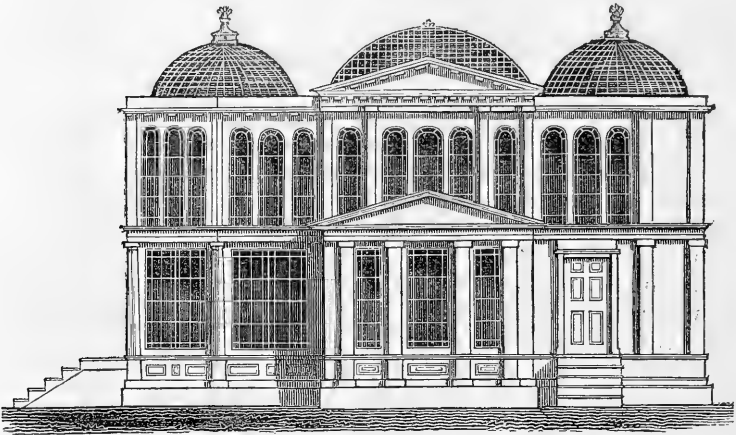
*End Elevation.*

placed under the gallery, which would be far better than slender ones of iron, unless these latter are made like tripods or candelabra. This practice was adopted in ancient art, and is the only method (in that style) of making the eye tolerate any support more slender than a regular column. Some instances of this kind were found in paintings at Pompeii. They should have rich, tripod pedestals, from which a fluted stem should rise, finishing at the top with a broad, ornamental, tripod bowl. Unless the general appearance of a candelabrum is preserved, the slender fluted shaft or stem appears quite unequal to support the weight above. But when properly done, it is the only form in which the eye recognises the support of metal.”

J. P.

*Feb. 18. 1829.*

---

ART. X. *Some Observations on the Rearing of Gorse Hedges (Ulex europæus).* By SPINOSA.

Sir,

IN the last Gardener's Magazine (p. 43.) there are some observations on the utility of the whin as a hedge plant. I

beg to state a few hints, for the information of those who have not seen it so used, although there is nothing new in the method I am now going to describe.

The best plan of producing a whin hedge is to throw up an embankment 3 ft. above the surface of the ground. Having fixed the line of the embankment, mark off a ditch outside of that line, 6 ft. wide at top, to be dug out 18 in. deep, and sloping, from the outside of the ditch, to 1 ft. wide at the bottom of the embankment. I ought to have observed, that the fence I am describing is used as a boundary to plantations. The line of the fence and the width of the ditch being marked off, begin to form the face of the embankment on the surface, either of sod or of stone, but sod is mostly used when the situation is on pasture land, and the top spit from the ditch comes in for that use. As the face of the embankment advances in height, keep it well backed up with soil from the ditch, until it be 3 ft. above ground, and the ditch 18 in. deep. Then finish off the top of the embankment 12 or 15 in. broad, and give the back of the fence a slope of 4 or 5 ft. At about the middle of the slope, and on the top of the embankment, a drill is drawn about 1 in. deep, in which the seeds are sown moderately thin, and then covered. The seeds are generally sown about the latter end of April or beginning of May. The trouble and expense further required are in keeping it clear from weeds the first two years, and well cut, in order to have it thick and close at the bottom.

This treatment being continued for four or five years, on a tolerable soil, an impenetrable fence will be reared, which will remain an effectual protection against cattle for many years. The whin is very hardy, and will grow in the most exposed situations, even on the sea-beach.

Instead of the whin being a plague in the wilds of Wales, I can assure your correspondent, T. H., that it is not considered as such by the farmers in most of the counties in North Wales. The young whin of two or three years' growth is cut by them, and chopped up on blocks and benches with cross-hatchets, made for the purpose; and many have been at the expense of erecting mills for grinding the shoots to pieces. In this state it is given to their horses throughout the winter months. It is sown in large quantities for this purpose; and, I believe, there are few who have been in the habit of feeding their horses with the whin, who would not estimate an acre of this plant of much more value than an acre of hay. In the days of Evelyn it seems to have been a favourite plant, not only for hedges, but for the fodder of cattle; indeed, in North

Wales, it constitutes the principal provender for the horses, from November to April.

I remain, Sir, &c.

March 2. 1829.

SPINOSA.

ART. XI. *An improved Mode of cultivating the Calceolària corymbòsa.* By Mr. JAMES ROLLINS.

Sir,

THE plan on which I cultivate *Calceolària corymbòsa* enables me to have it with from fourteen to eighteen stems, each bearing, on an average, thirty flowers. The cultivation of this plant is difficult, owing to its liability to damp off in the winter. To guard against this, as soon as my plants have done flowering, say about the end of June, I detach the side-shoots carefully, each with a joint, and immediately prick them into a pot prepared for their reception. The pot must be well drained by potsherds, and filled to within an inch of the top with finely sifted peat soil, over which is put one inch of finely sifted white sand. This is well watered, and allowed to settle before the cuttings are put in. The cuttings are dibbed into the sand with a pointed stick, closely, but not touching each other; they are then watered, and soon after covered with a bell-glass, which should be kept dry by being wiped every morning and evening, and by never watering till the sand becomes dry. In the course of a month, the cuttings will be fit to pot off into small pots, called, about Liverpool, 30s, in a soil composed of equal parts of rotten wood, earth, and light old hot-bed soil, well mixed. The plants are then set on a shady shelf in the green-house, where they have plenty of air, till about the end of October. At this time I remove them to the cool end of a stove, where, being kept moderately watered, they remain till the beginning of March, when they are again brought to their former situation in the green-house. As they increase in growth, the plants are repeatedly shifted into larger pots, till they are fixed in pots No. 12. The compost used in these shiftings is formed of three parts old hotbed soil, and one part rotten wood. Seedlings, raised from the seed sown as soon as it is ripe, are potted and treated in the same way as I do cuttings. Where there is no stove, the warmest end of a green-house will be found suitable for this plant, as it does not require a much higher temperature than about 50° of Fahr.

I am, Sir, &c. JAMES ROLLINS.

*Dingle Bank, near Liverpool, June 24.*

ART. XII. *On the Culture of the Hydrangea hortensis, as practised in the Potsdam Gardens.* By M. G. A. FINTELMANN.

Sir,

THE finest hydrangeas which I saw in my late tour in Britain and Ireland, were in the Moncrief Garden, Perthshire; but still they were not so fine as we grow them here.

The soil we prefer is what we call moor-erde, neither morass nor bog, but perhaps peat; because, in England, you apply the term peat to very different soils. This soil is found where rotted leaves and branches have lain for a century in a shady valley, and formed there a moist place with black earth, something like what you would call a bog, and on which the native plants, for the greater part, cannot grow for want of light. When this earth is collected, turned over, dried, and reduced to powder, the colour is of a bluish black, the consistence soft, spongy, and loose; rather wet, but not very much so. When we cannot get this soil, we take the mould formed by the rotted peat or turf used here as fuel.

Cuttings of the last year's shoots are put in the ground early in the season and shaded, and they very soon strike root. In the month of September we take them up, and pot them in small pots. The following spring we shift them into larger ones, and cut them down to two or three eyes. They flower in the following July, with a bunch or corymb for every bud that is left.

Every future spring, the preceding year's branches are shortened to two eyes; and when the plants become too large for pots, they are taken out and separated. It is almost unnecessary to observe that, in the growing season, the pots are kept moist, and in the shade; but it may be proper to state that the most experienced practitioners prefer the shade of trees to the shade of a wall, a hedge, or a building; from which, I think, we may conclude that the leaves of the hydrangea consume a good deal of carbonic acid.

To render the flowers of the hydrangea blue, we have no fixed plan; nor, after all that has been said on the subject, do I believe the cause of the change known. We now and then find a soil which, by accident, effects this; and this soil, I have always observed, contains a good deal of oxide of iron. We have here a large hydrangea growing in this soil, in the open ground, which is protected during winter with a wooden box. In 1823 it was 5 ft. high, and 28 ft. in circumference, and bore 453 flowers. It has since died.

The size to which we frequently find the corymbs of flowers in pots attain is 14 in. in diameter.

I am, Sir, &c.

G. A. FINTELMANN.

*Pfaueninsel, Potsdam, Feb. 22. 1829.*

ART. XIII. *Description of a Flower-Stand, designed and constructed for the Honourable Mrs. Fox of St. Anne's Hill. Communicated by Mr. H. TUCKER, Gardener to Mrs. Fox.*

Sir,

59

I SEND you here-  
with a sketch of a  
flower-stand (*fig.*  
59.), which I made a  
model of, and had  
executed by Mr. J.  
Faulkner, at Hors-  
ham, near Esher,  
Surrey.

I have not seen  
any one like it, in at  
least one particular,  
that the three stages  
turn round every way,  
and with the greatest  
ease. Its height from  
the floor is 5 ft. Dia-  
meter of the lowest  
stage, 16 in.; of the  
second stage, 13 in.;  
of the third, 10 in.;  
and of the fourth,  
8 in. The wire bor-  
der is 4 in. high. The  
bottoms of the stages  
are wood, and all the  
rest is iron.

If this is worth a  
place in your Maga-  
zine, I shall be happy  
in having sent it.

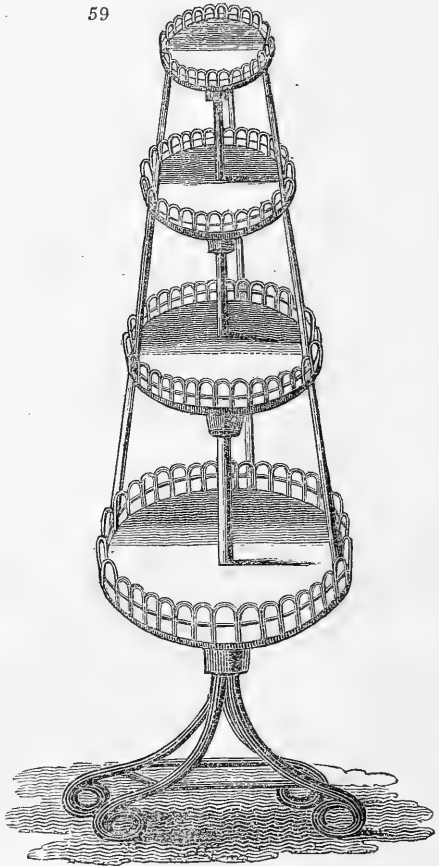

I am, Sir, &c.

H. TUCKER.

*St. Anne's Hill, Chertsey, Surrey,*  
*Dec. 12. 1828.*

ART. XIV. *On the Culture of the Sweet Potato (Convolvulus Batatas), as practised in the Neighbourhood of New York.* By B. W. STRONG, Esq. Communicated by Messrs. G. Thorburn and Son, Nurserymen, New York.

Sir,

WE subjoin a few remarks on the cultivation of this plant, as communicated to us by a friend on Long Island, B. W. Strong, Esq., a gentleman who is unwearied in his exertions to improve the quality of the vegetables cultivated for the New York market.

“ Good crops of sweet potatoes may be raised in the neighbourhood of New York, by a little attention to the nature of the plants. Sweet potatoes are produced from the joints of the vine, and not from the old potato. To make them fruitful these joints must be covered with earth, and the potato forms there. Towards the end of April, make a hotbed of horse manure, about 18 in. thick; on the manure put 3 in. of earth; on this earth plant the seed potatoes 3 in. apart, and cover them 4 in. deep with earth; when the sprouts they send up are 3 in. above the ground, draw them out with the hand, and transplant them (as you would cabbage plants) in soft, warm, rich ground, in rows 4 ft. apart, and put the plants about 1 ft. apart in the rows; keep them clear of weeds until the vines begin to cover the ground, after which their leafy nature will enable them to smother all weeds. If the hotbed be made early in April, the early sprouts will be ready for transplanting by the 10th of May; the bed will continue to throw up a second and third succession of sprouts, all of which will afford good potatoes, if planted out any time before the end of June. A hotbed 5 ft. square, with a half peck of seed potatoes, produced last season a succession of sprouts which yielded 15 bushels of sweet potatoes.”

The way the slips are preserved through the winter, and which are procured by planting late (as is done for small onions to set out for an early crop), is thus: — They are taken up in the autumn before severe frosts, and, as we have been told by some of our Carolina friends, placed in a pit dug in front of the kitchen hearth, and very carefully buried in sand made perfectly dry.

We cannot see why, with a little attention, the sweet potato should not be grown with success in the south of England. At all events, we think the experiment worth making, and should they not succeed to perfection, they would no doubt

gratify the eye with their luxuriant foliage, and beautiful flowers.

We remain, Sir, yours, &c.

G. THORBURN and SON.

*New York, April 16. 1828.*

THE sweet potato is cultivated in several gardens in the neighbourhood of Paris with perfect success, and the tubers sold in the market, and in the fruit-shops. The best crops we saw were in Admiral Tchitchigoff's garden at Sceaux. The tubers are planted in February, or earlier or later at pleasure, in the pine stove, or in a small hotbed; and the shoots they produce are taken off, and planted a foot apart every way, on dung beds, covered with 15 in. of earth, and protected by hoops and mats in the manner of ridged cucumbers. This may be done any time from April to June, and the shoots are not dibbled in, but laid down in drills about 3 in. deep, keeping 2 in. of the point of the shoot above the earth. In about two months after transplanting, some of the tubers will be fit to take off for use, and the plants will continue producing till they are destroyed by frost. To preserve the tubers through the winter, the greatest care is required. In the king's forcing-gardens at Versailles, they are kept in a growing state all the winter in the pine stoves. With the exception of this difficulty of preserving the tubers through the winter, the sweet potato is just as easily cultivated as the mealy potato. Though the shoots are naturally ascending and twining like those of *Tamus communis*, the plants are not sticked, and therefore the shoots cover the ground, and form over it a thick matting of dark green smooth foliage. In the early part of the season, the tubers are taken off as they attain the size of early kidney potatoes; later the whole crop is dug up. If the sweet potato were once fairly introduced into first-rate gardens, we have no doubt it would form an article of regular culture there.

Since writing the above, we observe, in the last edition of the *Bon Jardinier*, that the sweet potato is cultivated in the south of France, where the shoots and leaves are reckoned excellent forage for cows and horses, and that some people eat them as spinach. Directions are given for preserving the tubers through the winter in layers in a box of very dry sand, no one tuber touching another; the box closed and surrounded by a good thickness of straw, and the whole put in another box, and placed under a heap of straw, so as to prevent the tubers from undergoing any change of temperature. — *Cond.*

ART. XV. *On the Destruction of Wasps.* By THOS. N. PARKER, Esq., of Sweeney Hall, Shropshire.

SIR,

THE autumn of 1827 yielded a great produce of fruits, and it was also remarkable for correspondent quantities of wasps. Extraordinary exertions were, therefore, necessary for the destruction of the wasps, in order to save any fruit at all. I had long been trying various means for destroying them, and found that three-penny or four-penny squibs answered the purpose best. This plague of wasps was become so great a nuisance, that I resolved to take a leading part myself in the measures pursued against them; and in one night I took seventeen nests, in two other nights twenty-three more, and altogether about seven dozen, all within half a mile of my garden, but most of them a great deal nearer. I find that the best way of making the squibs is thus, and the plan should be *minutely* attended to, or the result may be very different. The more particular directions are therefore printed in italics, by way of distinction. Take strong cartridge paper, and cut one sheet into sixteen pieces, supposing the sheet to be about twenty-two inches by about seventeen inches and three quarters, and making each piece about eight inches and three quarters long by two inches and three quarters wide, roll and paste each piece round a smooth rod of brass, iron, or hard wood, of five-sixteenths of an inch in diameter, and tie up one end of the cartridge with a string, or double it up, and secure it with sealing-wax. The paper case having been prepared and dried, put in the "blast" or slightly exploding part made of one eighteenth part of an ounce of rock powder *pounded*, and shake or ram it well down; fill up the case with a quarter of an ounce of meal powder, which is to be made with eight ounces of rock powder *finely pounded*, two ounces of sulphur *finely pounded*, and three ounces of charcoal (or candle coal, called kenel coal) *finely pounded*: the ingredients of the meal powder should be *very well mixed, and made to pass through a sieve of fine brass, such as is used in a dairy.* The meal powder should be *well shaken or rammed down into the case.* The top of the case is to be furnished with good touch paper, one piece inserted loosely, and another piece wrapped round and fastened with *a little* sealing-wax. The touch paper should be made of one part of rock powder *pounded*, one part of saltpetre *pounded*, and four parts of water: in this mixture the touch paper (or blotting paper not sized) should be immersed and saturated, and when dry it is fit for use. The materials for the case and ingredients will cost about one



farthing for each squib, but 2*d.* or 3*d.* each may be fairly charged by any person who takes the trouble of making the squibs carefully. One of these squibs is generally sufficient for taking a nest, but sometimes more; for if the nest is in a contrary direction to the entrance, which often happens, the first squib may not reach the nest, which is usually found between one and two feet from the entrance. A stick of two or three feet in length should be furnished with a *piece of an old gun or pistol barrel*, five or six inches long in the clear, for receiving the squib and forcing it into the hole (or a slighter ferrule will answer for slight explosions), and the squib will burn from a quarter to half a minute: some little time, therefore, may be allowed for killing or maiming the wasps which are seen at the entrance and thereabout, and the squib should, on that account, be held about a foot distant, and opposite to the entrance, for some seconds of time, and then forced as far as it will go into the hole. A small clod or tuft of grass should be got ready to stop the hole, as soon as the squib is put in. The ingredients are calculated to smother the wasps more than to kill them by an explosion, so that rock powder is used in a greater proportion than would be necessary if fine gunpowder were adopted. Wasps' nests are usually of a spherical form, and sometimes larger than a foot in diameter. If the squib has a good effect, the nest may be taken out entire by the hands provided with strong gloves, and then broken and crushed with a spade and some water. The other accompaniments proper for taking wasps' nests are a lantern, two or more candles, spade, pick, short screw for drawing the cartridge paper left in the barrel, and at least three persons. The wasps will recover from their suffocation, but there is generally plenty of time to complete their destruction in the manner above mentioned without the least danger of getting stung.

Notwithstanding the destruction of about seven dozen nests the wasps were still so thick on the wall-fruit, that I was obliged to have recourse to another expedient. I suspect that wasps, when gorged with fruit, do not go to their nests at night, so I made a successful attack upon them on their chosen ground in the daytime, by means of some hyacinth glasses, with about two inches of water in each. These glasses being held partly under and partly in front of a plum or other fruit full of wasps, every one tumbled into the glass, and shaking them up with the water, you may make a few more casts, and lastly roll them out, water and all, on the ground, entangled together like a ball, and put your foot on them. In eight successive casts, I caught 128; the greatest number at one cast, from a bunch of plums, being 27. I can credit the statement

of 42 having been taken at one cast, but I did not see it. I have had some glasses made at Bedford's Glass Manufactory, New Street, Birmingham, in rather a better form than hyacinth glasses, as shown in the margin. (*fig. 60.*) \*

They are retailed at 1s. 6d. each, and a pattern is kept at the shop. I never saw a wasp feeding on fruit attack any person; in fact, you need not have any contest with them, they merely fall by their own weight into the glass and water-trap. It is supposed that the few large wasps which are seen in the spring are impregnated females, and form as many nests, except those which are killed by venturing out of their winter quarters too early. On the 22d of April 1820, I took three large wasps on the same window; and, on the 27th of the same month, I took three more on another window. In the autumn of 1828, there was but an indifferent crop of fruit, and few wasps' nests, and the wasps for the most part were smaller than usual: few, however, as the number of nests were, they could not have been placed in more annoying situations. Three of these were easily destroyed, being in a hedge-bank immediately opposite my lodge-gate within a few feet of each other. Another was under the slates at the door of a stable; several stable doors opened into a small courtyard forming three sides of a square, so that if this wasp's nest could not have been dislodged great mischief might have occurred. There are no lofts over the stables, and the lath and plaster follows the spars up to the side-raiser; the nest was luckily below the side-raiser stopping up a space of  $9\frac{1}{2}$  inches by  $3\frac{1}{2}$  inches between two spars. In the day time I made a hole in the lath and plaster with a pole, and no wasps appearing I made a second hole, and found that I had got near to them, when I left them till night: at night I used two squibs, although one would have been enough, and stopped the hole; then with my hand I soon found the nest, took it out entire, and it weighed 3lbs. Not a single wasp was on the wing, nor one to be seen but in a state of suffocation. The night happened to be dark, cool, and rainy, or the destruction of the nest might have been less complete.

Yours, &c. THOS. N. PARKER.

*Sreeney Hall, near Oswestry, Shropshire.*

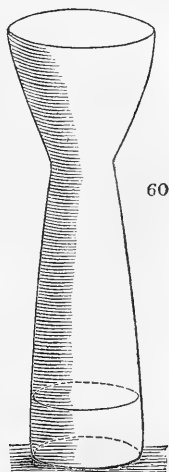

\* In London these glasses, and other garden novelties, may be had at Goode's China and Glass Warehouse, 15. Mill Street, Hanover Square. —  
Cond.

ART. XVI. *Catalogue of Fruits cultivated in the Government Botanic Garden at Sydney, in New South Wales.* By MR. CHARLES FRASER, C.M.H.S.

Sir,

AT the suggestion of my friend, Mr. M<sup>c</sup>Leay, I have sent you the accompanying list of fruits at present cultivated in the public garden, Sydney; and will feel great pleasure in communicating generally with you, upon any remarkable feature in the character of the botany or horticulture of the colonised portion of New Holland, from time to time. I have arranged a catalogue of the plants in our gardens, which has gone to press, and I will take an early opportunity of forwarding you a copy of it, and a general report of our garden; want of time prevents my doing so now.

The present season has been a very trying one; we have had no rain for upwards of eight months, until within the last few days. The consequence has been that we have lost a vast number of valuable plants, which will take me some time to replace; and it is somewhat remarkable, that our European trees stood the drought much better than those of warmer climates; while our oranges, limes, shaddocks, guavas, &c., were completely burnt up, our apples, pears, &c., stood the shock without any apparent injury. You have, no doubt, heard a great deal said of the capabilities of our climate; the following circumstance may be considered as not usual in other climates:—

In an exposed part of our garden may be seen growing luxuriantly, in a dense thicket formed by themselves, the following trees, viz. English ash and elm, *Erythrina Corallo-déndrum* in full flower, *Bómbax heptaphýllum*, *Guilandina Bónduc*, *Ficus elástica*, *Dalbérgia Síssoo*, *Téctona grándis*, *Pínus Pináster* and *halepénsis*, *Catálpa syringifolia*, English lime and sycamore, Mossy-capped and English oak, *Acácia tamariscina*, *Salisbúria adiantifolia*, and many others. With the tea I have been exceedingly fortunate, and the olives seem to outdo in luxuriance any plants I ever beheld.

In my next I will be more descriptive, and remain, in the mean time,

Yours, &c.

CHARLES FRASER.

*Botanic Garden, Sydney, New South Wales,*

*April 1. 1828.*

*List of Fruits cultivated in the Botanic Garden, Sydney, 1827.*

Systematic Name.	Vulgar Name.	Varieties.	State of Acclimatisation.	Bearing State.
POLYANDR. POLYGYN.				
Anonaceæ.				
<i>Anona hexapétala</i> <i>Cherimólia</i>	Custard apple Cherimoyer	- - - - - -	Delicate Perfect	not yet borne flowered this seas.
POLYADEL. POLYAND.				
Aurantiacæ.				
<i>Citrus Aurantium</i>	Sweet orange	Common Chinese Malta red Seedling, Brazil Selletta Navel, Bahia Pernambuco Maranham St. Jago's Tangareen, Brazil Small-leaved Chin. Nankin oval Chinese downy Long-leaved Chin. Long-leaved dwarf Chinese seedling	- -	abundant    not yet borne shy bearer not yet borne shy bearer not yet borne  shy bearer  not yet borne now in bearing  not yet borne bears freely.  not yet borne
<i>vulgàris</i> <i>nóbilis</i>	Seville orange Mandarin	Common Fang-Kau, Lioan Tuan-Kat Chu-Cha-Kud	- - - - - - - - - - - -	bears freely.  not yet borne
<i>Límétta</i> <i>margarita Sw.</i> <i>Limonum</i> <i>decunàna</i>	Common lime Sweet lemon Common lemon Shaddock	Persian Whaley's seedling Puncio of Java of Brazil Green-fruited Sa- mabaya	- - - - - - - - - - - -	bears freely not yet borne
<i>Médica</i>	Citron	Brazilian oval Dwarf large-fruit- ed Brazil	- - -	bears freely
OCTANDR. MONOGYN.				
Sapindacæ.				
<i>Dimocàrpus Litchi.</i> <i>Lóngan</i> Sp.	Li-tchi many-petaled Brazilian	- - -	- - -	not yet borne
PENTAND. MONOGYN.				
Ampelidæ.				
<i>Vitis vinifera</i>	Common grape	Sweetwater Black Hamburgh Black Chester Claret Miller's Burgundy Gouais Wh. Cham. Frontign. (Grogly) Constantia Grove End Sweet- water Calalea Tokay Black Frontignac Round-berr. Musc. Seedling from Blk. Prince Burgundy Tinta Seperaz Madeira seedling	- -	bears abundantly          not yet borne
MONGECIA POLYAND.				
Juglandæ.				
<i>Jàglans règia</i> Sp.	Common walnut From Valhæzo	- - - - - -	- - - - - -	shy bearer not yet borne

Systematic Name.	Vulgar Name.	Varieties.	State of Acclimat.	Bearing State.
PENTA'ND. MONOGY'N. <i>Cassivæ.</i>				
<i>Mangifera indica</i>	Common Mango	Mango Graale		
POLYGA'MIA DIGE'CIA. <i>Legumindæ.</i>				
<i>Ceratonia siliqua</i>	Carob, St. John's Bread			
DECA'NDR. MONOGY'N. <i>Legumindæ.</i>				
<i>Hymenæa Courbaril</i>	Locust tree			
MONADE'LPH. TRIA'ND. <i>Legumindæ.</i>				
<i>Tamarindus indica</i>	Tamarind Tree			
ICOSA'NDR. MONOGY'N. <i>Amygdalinæ.</i>				
<i>Amygdalus Pérsica</i>	Common Peach	Newington Royal George Flat Peach of Chin. Early Chin. Shell-stone Late or Win. Chin. Elruge Claremont Fairchild's Gov. Bligh's Seed. Paper-shelled Thick-shell. Sweet	- - -	bears freely
<i>Nectarina</i>	Nectarine			
<i>communis</i>	Common Almond		- - -	not yet borne shy bearer
<i>amara</i>	Common Bitter		- - -	bears freely
<i>Armeniaca vulgaris</i>	Common Apricot	Moor Park Breda French Seedling May Duke Black Heart Kentish Beggemear Green Gage Orleans	- -	not yet borne shy bearer abundant not yet borne shy bearer not yet borne
<i>Prunus Cérasus</i>	Common Cherry			
<i>doméstica</i>	Common Plum			
ICOSA'ND. PENTAGY'N. <i>Pomæcæ.</i>				
<i>Pyrus Mâlus</i>	Common Apple	English Codlin Parry's Pearmain French Reinette Winter Pippin Kentish Codlin Newtown Pippin Mole's Royal	- -	bears abundantly not yet borne abundant not yet borne
<i>baccata</i>	Small-fruited			
<i>communis</i>	Common Pear	Beurrée Crassane Berga. d'automne Crawford, or Lam. Brown Beurrée Chaumontel Large Baking Large Belle	- -	abundant not yet borne abundant
ICOSA'ND. DI-PENTAG. <i>Pomæcæ.</i>				
<i>Méspilus germánica</i>	Common Medlar			
ICOSA'ND. PENTAGY'N. <i>Pomæcæ.</i>				
<i>Eriobótريا japónica</i>	Loquat			
<i>Cydonia vulgaris</i>	Common Quince			
<i>japónica</i>	Solitary-flowered	- - -	- - -	not yet borne

Systematic Name.	Vulgar Name.	Varieties.	State of Acclimat.	Bearing State.
ICOSA'NDR. POLYGY'N. Rosaceæ.				
Rubus Idæ'us	Common Raspber.	Red Antwerp White Antwerp Red C. of G. Hope	- - - - - - - - -	shy bearer abundant bears freely
sp.	Bathurst Raspber.	- - -	- - -	
sp.	Moreton Bay	- - -	- - -	
sp.	Pt. Macquarie Yel.	- - -	- - -	
sp.	Melville Island.	- - -	- - -	not yet borne
Fragaria véscæ	Wood Strawberry	- - -	- - -	bears abundantly
collina	Alpine	- - -	- - -	shy bearer
virginiána	Scarlet	- - -	- - -	bears abundantly
		Seedl. from Keen's Seedling	- - -	not yet borne
PENTA'ND. MONOGY'N. Santalacææ.				
Leptoméria ácida	Native Currant	- - -	- - -	abundant
ENNEA'ND. MONOGY'N. Laurináæ.				
Pérsea gratíssima	Alligator Pear	- - -	- - -	not yet borne
ICOSA'NDR. MONOGY'N. Myrtacææ.				
Eugénia Jámbos	Rose Apple	- - -	- - -	bears abundantly
uniflora	Braz. Cher. Pedan.	- - -	- - -	not yet borne
sp.	Native Plum.	- - -	- - -	
Psidium pyriferum.	White Guava	- - -	- - -	bears freely
pomiferum	Red	- - -	- - -	not yet borne
repens	Creeping	- - -	- - -	bears freely
Púnica Granátum	Common Pomegr.	White-flowered Double-flowering	- - -	not yet borne
MONÆ'C. MONADE'LPH. Cucurbitacææ.				
Cucúrbita Citrútilus	Water Melon	White-seeded Black-seeded Large oval Green-heat	- - -	abundant
Cucumis Mélo	Garden Melon	oval Nutmeg Pine-apple Early Cantaloup Netted Cephalonian Chin. small of col. Early Georgia Valentia		
Sicyos angulàta	Chu-Chu-Vin			
ICOSA'N. MONOGY'N. Opuntiacææ.				
Opúntia vulgàris	Prickly Pear			
PENTA'N. MONOGY'NIA. Sapôtææ.				
A'chras austràlis	Austral. Zapotilla	- - -	- - -	not yet borne
PENTA'N. MONOGY'NIA. Rubiacææ.				
Vanguiera edúlis	Eatable Vanguiera			
PENTA'ND. TRIGY'NIA. Caprifoliacææ.				
Sambucus nigra	Black Elder	- - -	- - -	abundant
DIGÉCIA POLYA'NDRIA. Flacourtiacææ.				
Flacoúrtia sp.	Mauritius Plum	- - -	- - -	not yet borne

Systematic Name.	Vulgar Name.	Varieties.	State of Acclimat.	Bearing State.
POLYGA'MIA DICE'CIA. <i>Ebenàcea.</i>				
<i>Diospÿros Lôtus</i>	Europ. Date Plum			
DIA'NDR. MONOGY'NIA. <i>Oleàna.</i>				
<i>O'lea europæ'a</i>	European Olive	Long-leaved Iron-coloured Box-leaved Oblique-leaved Smooth-leaved		
<i>capensis</i>	Cape Olive	- - -	- - -	now in flower
<i>latifolia</i>	Broad-leaved	- - -	- - -	not yet borne
<i>angustifolia</i>	Narrow-leaved	- - -	- - -	now bearing
<i>undulata</i>	Waved-leaved	- - -	- - -	not yet borne
<i>oleæfolia</i>	Olive-leaved	- - -	- - -	bears freely
<i>buxifolia</i>	Boxwood-leaved	- - -	- - -	not yet borne
MONADE'L. PENTA'ND. <i>Passifloræa</i>				
<i>Passiflora grandiflora</i> <i>edulis</i>	Granadilla Eatable	- - -	- - -	shy bearer
POLYGA'MIA DICE'CIA. <i>Urticæa.</i>				
<i>Ficus Cárca</i>	Common Fig	Brown Ischia White Marseilles Turkey large white Green, red within Brazilian	- - - - - - - - - - - -	now bearing bears freely not yet borne
MONGE'CIA POLYA'NDR. <i>Amentæa.</i>				
<i>Corylus Avellána</i>	Common Hazel	- - -	Delicate	
<i>Castanea véscæ</i>	Spanish Chestnut	Red Filbert Cob	- - - Perfect	not yet borne bears freely
MONGE'CIA MONADE'LP. <i>Coniferæ.</i>				
<i>Pinus Pinea</i>	Stone Pine			
TETRA'ND. MONOGY'N. <i>Onagrària.</i>				
<i>Trapa bicórnis</i>	Chi. Wat. Caltrops			
POLYGA'M. MONGE'CIA. <i>Musàcæa</i>				
<i>Musa sapiéntum</i> <i>paradisíaca</i>	Banana Plantain			
HEXA'NDR. MONGY'NIA. <i>Bromeliæa.</i>				
<i>Bromelia Anáns</i>	Pine-apple	New Providence Jamaica Green Black Ripley Maranham Brazilian Scarlet Double Sugar-loaf smooth-leaved	Under glass in winter - - -	bears freely not yet borne
MONGE'CIA HEXA'NDR. <i>Pálmæa</i>				
<i>Cocos nucifera</i>	Cocoa Nut	- - -	Very delicate	
DICE'CIA HEXA'NDRIA <i>Pálmæa.</i>				
<i>Phœnix dactylifera</i> <i>farinifera</i>	Date Palm Small Date Palm	- - -	Hardy	

## PART II.

## REVIEWS.

ART. I. *Transactions of the Horticultural Society of London.*  
Vol. VII. Part III.

THIS part contains fourteen articles and three plates; two of the plates are of crocuses, and the third is a meteorological diagram.

37. *An Account of Scotch Pears.* By Mr. A. Gorrie, C.M.H.S.,  
Dated November, 1827.

The essence of this paper may be considered as given in Mr. Gorrie's communication (*Gard. Mag.*, vol. iv. p. 11.), dated December, 1827; but sixty-two sorts are here described, and the conclusion drawn that the varieties which come into use in November are too numerous, while those for winter and spring supply are far too limited. The same five sorts recommended by Mr. Gorrie, and figured from his drawings in *Gard. Mag.* supra, as ornamental trees, are here also recommended and figured.

38. *An Account of some Varieties of the Apple which have been found to succeed in a Garden in Ross-shire, Latitude 57° 34' 54" N.; with descriptions of Five New Seedling Apples.* By Sir George Steuart Mackenzie, Bart. F.H.S. Read March 20. 1827.

These varieties are as follow: 1. Herefordshire Pearmain; 2. Kirke's Golden Reinette; 3. Wormsley Pippin; 4. Kerry Pippin; 5. Devonshire Quarrenden; 6. Northern Greening; 7. Norfolk Coleman; 8. the Brown Apple; 9. Peach Apple; 10. Pomme de Neige; 11. Blenheim or Woodstock Pippin; 12. Hollandbury, also known as Kirke's Scarlet Admirable; 13. Scarlet Pearmain; 14. Court of Wick; 15. Alexander; 16. Loan's Pearmain. On the wall "I have the following, among others less uncommon in this country:" 1. Reinette de Canada; 2. Margil; 3. Beauty of Wilts; 4. Hughes's Golden Pippin. Sir George has also raised the following



sorts from seeds: 1. Kinellan Apple; 2. Contin Reinette; 3. the Coul Blush Apple; 4. the Sweet Topaz Apple.

39. *On the Cultivation of the Strawberry.* By Sir George Steuart Mackenzie, Bart., F.H.S. Read March 4. 1828.

Good sorts of strawberries will very probably be mixed with bad sorts, if you neglect to destroy the young plants that rise from seed from the decayed berries in established plantations. Consequently, treating the Alpine strawberry as an annual is inadvisable, in confirmation of which opinion, we may refer to the French practice. (p. 124.) The French, having had till lately almost no other strawberry than the Alpine, have carried its cultivation to a greater degree of perfection than we have done; the fruit is larger, and they have the plants in bearing from July till December, and under glass, in some places, all the winter.

40. *Journal of Meteorological Observations made in the Garden of the Horticultural Society at Chiswick, during the Year 1827.* By Mr. William Beattie Booth, A.L.S.

Twenty-nine pages of figures. See *Gard. Mag.* vol. iii. p. 176.

41. *An Account of the Manner of training the Vine upon open Walls, at Thomery, near Fontainebleau.* By Mr. John Robertson, F.H.S. Read March 4. 1828.

This paper, Mr. Robertson inform us, is collected from the best French authorities, and especially from Lelieur's *Pomone Françoise*, and the *Bon Jardinier* for 1827. In a note to it, "by order of the Council," it is stated that, though not original, the usual practice is departed from, from the useful nature of the communication. We shall, therefore, give its essence with due care.

The grapes of Fontainebleau are chiefly raised in the village of Thomery, on a poor, strong, clayey soil, and on the north side of a hill, sloping to the Seine.

*Walls and Treillage.* — The walls are 8 ft. high, built of clay, plastered or washed over with mortar of lime and sand, and covered by a coping of boards or straw, projecting 9 or 10 in. on each side. The treillage is formed of upright rails 18 or 20 in. apart, with horizontal rods 9 or 10 in. apart. The south, west, and eastern sides of the walls are employed. The chief peculiarities of the culture are, allowing only two branches to proceed from each vine, and planting the vines several feet from the wall. The spurring system of

pruning is employed, and it will be seen that the success depends principally on these three particulars.

The main branches of each particular vine plant assumes, above ground, the form of the letter T (*fig. 61.*), each arm being 4 ft. long, the spurs 6 in. apart, and the upright stem being shorter or longer accordingly as the two arms or horizontal branches are higher or lower on the wall. (*fig. 62.*)

The horizontal branches are placed 18 in. apart, the lowest being 6 in. from the ground, so that a wall 8 ft. high will contain five lines of mother branches. (*fig. 62.*) If the plants are all planted on one side, their stems

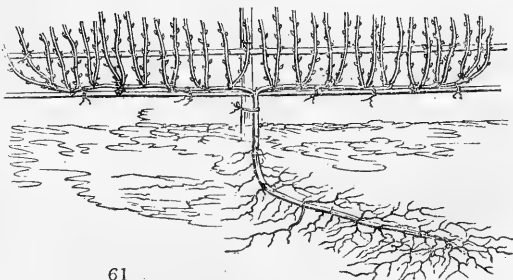

61

62

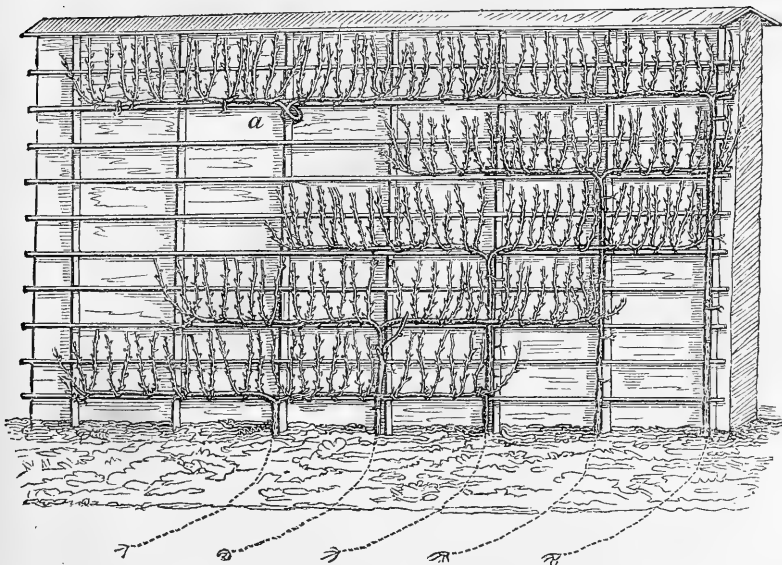

at the base of the wall will be 18 in. apart; but in very poor situations they are planted on both sides of north walls, and the stems of those on the north side brought through holes in the wall to the south side. (*fig. 62. a.*)

*Preparation of the Borders.* — The upper stratum of 18 in. is trenched, well manured, and such a slope given as will throw off heavy rains.

*Selection of Cuttings and Planting.* — Cuttings are preferred, because they can choose them from any plant, or even shoot, which has produced an improved variety of fruit. The cuttings, which are called *croisettes*, are about 2 ft. in length, generally with an inch of old wood attached. In the month of March, they are planted 1 ft. deep, in a row parallel with the wall, 4 ft. distant from it and leaning towards it, and 18 in. apart in the row; three eyes being left on the upper end of each cutting. The young shoots made from the cuttings are tied to stakes the first summer, and the second spring only the strongest shoot is left on each plant. This shoot is shortened to three eyes, and a trench being opened in a direction from the plant to the wall, 11 in. deep, the whole plant is buried in it, except the three buds on the young wood. This is the first step in the journey of the plant to the wall, and the operation, which is nearly the same as that called *provigner* in some districts, is repeated every spring, till the plant reaches the wall; which at Thomery it generally does in three years.

In some of the gardens at Montreuil, and in that of Decoufflé in Paris, the cuttings are planted at the bottom of the wall, where they remain two years, and the third spring they are taken up and planted 4 or 5 ft. distant from the wall, and their stems laid down at full length so as to reach the wall at once, much in the manner employed by Mr. Judd (*Encyc. of Gard.*, § 2961.), but without cutting, instead of which, stones or brickbats are laid here and there on the shoots, which stimulate them to throw out roots. It must be observed that in Mr. Judd's case, and also at Montreuil and other gardens at Paris, the soil is, or is supposed to be, much richer than at Thomery.

“At Thomery,” Mr. Robertson observes, “the vines being planted closer have a more limited range for food, and the numerous roots produced by the frequent laying in of the stems, occupy the border so fully as to prevent any redundancy of moisture or excess of nutriment; and instead of a rank luxuriant growth, they are furnished with short, well ripened shoots, closely set with bearing eyes, which, when the ground is well manured, seldom fail to afford abundant crops.”

The sort of grape most in repute at Thomery is the Fontainebleau or Royal Muscadine.

*Training and Winter pruning.* — This will be clearly understood by an inspection of the figure (*fig.* 62).

“ During the formation of the cordons, the spurs on their arms will successively come into bearing, and each when pruned down at the season to two or three eyes, will produce as many shoots with fruit. Of these, at the next winter’s pruning, only the lowest shoot is to be suffered to remain, and that at the same time is to be cut back to one, two, or three eyes, according to its strength. The eyes at the bottom of the spurs are very small and much crowded, there are at least six within the space of one sixth part of an inch; when the spurs are cut to the length of one or two inches, these small eyes are robbed by those above them; but when the spurs are cut short immediately above these eyes, they then break, develope themselves, and produce good bunches. Of this the vigneron of Thomery are well aware; they never leave their spurs more than one inch long, and sometimes less: by which means they always keep the bearing wood *at home*; and extraordinary as it may appear, spurs that have borne for twenty years are no more than one inch long. Should more than two shoots break from a spur, all above that number are suppressed, and not more than two bunches are left on each of these, for a moderate crop of good grapes proves of greater value than a more abundant crop of inferior quality. When the space of walling allotted to the five cordons is completely occupied, about 8 ft. square or 64 square feet are filled, and the produce calculated on is 320 bunches; for each arm being 4 ft. long, and furnished with spurs 6 inches apart, the two arms will carry 16 spurs of two eyes each; and allowing two bunches to every eye, each tier or cordon should bear 64 bunches, the number on five cordons will consequently amount to 320.

“ This precise length of 4 ft. to each arm has been determined by experience to be the fittest; the vigneron found that when the arms were left of a greater length, the spurs in the centre gradually declined, and good bunches were produced only at the extremities of the cordon; but when reduced to 4 ft., the spurs on the whole length were perfect, their eyes well filled, and the bunches of fruit fine and well swelled.

“ Training in cordons after this manner affords these additional advantages; every portion of the wall is equally furnished with bearing wood, and when once the cordons are completed, the pruning and training becomes so uniform and simple that it may be intrusted to any intelligent workman. But what renders this practice of still greater value in this country is, that *the fruit on these small spurs always ripens earlier than on the stronger wood.*

“ When vines are trained with more than one cordon, it is evident from what has already been said, that the lower tiers will eventually become enfeebled by the more powerful vegetation and shade of those above them; but when the vine is limited to one cordon, it maintains that one in vigour under any such circumstances of privation.

“ Might not training on these principles, if accommodated to their peculiar natures, be applied with advantage to our pear trees on walls, and apple trees on espaliers; it would probably counteract their tendency to run naked at the lower parts and centre, and bear only at the extremities.

“ When pruning their vines, the vigneron avoid cutting close to the eyes, lest they might be injured by the wood dying down to them; the wood of the vine, from its spongy nature and the peculiarity of its alburnum, not healing readily, and being liable to decay at a wound. To guard against this, they always cut midway between the eyes, sloping the cut to the opposite side of the shoot, so that the eye may not be damaged by its bleeding. They are also careful to inflict no wounds unnecessarily, and those they do make they finish off in the neatest manner.

“ The season they generally prefer for the winter pruning is from the beginning of February to the beginning of March, before the first movement of the sap takes place. The earliest pruned vines are found to break first.”

*Summer Pruning or Training.* — Cut out weak shoots, unless any should become necessary to replace failures in the spurs.

“ As premature summer pruning is productive of the same bad effects as follow late summer training, in occasioning wasteful bursts of sap, it is considered prudent, before the stronger shoots are cleared off, to wait until the wood has acquired some consistence, and until new channels are prepared for the expenditure of the sap by the expansion of the leaves.”

Stripping a plant of its leaves and shoots suddenly always gives a shock to its vegetation, and therefore should be very carefully and gradually performed, until the grapes are set.

*Pinching or Stopping the Young Wood.* — This accelerates the maturity of the shoots, and swells the buds of the spurs. At Thomery the young wood is pinched after the bud is set. “ Should it appear that the shoots of the extremities impoverish those of the centre, the former are pinched repeatedly until the equilibrium is restored.

“ When the vigneron of Thomery, before the adoption of the present system, during a period of thirty years, made a

practice of planting their vines far apart, their growth was so luxuriant that they were under the necessity of leaving a distance of 2 ft. between each cordon, and even that was found insufficient as they shot beyond it, and could only be kept within bounds by repeatedly cutting in the young wood, though in an advanced state; but since they have adopted the practice of close planting, and by a judicious selection have procured varieties which grow more kindly, pinching alone is found sufficient to keep the plants in order."

*Care of the Fruit.* — Cut off the extremities of long bunches, for they generally ripen late. Let only two remain on a shoot. Thin the berries of close bunches, and remove insects. When the bunch is three fourths ripe, take off a few leaves to admit the sun and air to colour the fruit. "In doing this, the leaf is torn off at the extremity of the foot-stalk, which is left behind to attract the sap" [?]. The bunches are frequently put in hair bags, to protect them from birds; but more commonly they are screened with cloths, matting of straw or bass, or with fern, which, late in the season, is removed during the middle of fine days, and which will preserve fruit on the trees till Christmas. [This we saw done in M. Decoufflé's garden in October last, and found some of the grapes still hanging on the end of his house in the first week of January, 1829, which he expected to keep there till February.]

"None but the driest weather is chosen for gathering in the crop, it would quickly spoil if stored moist. The bunches are handled with nicety, and only by the stalk, to preserve the bloom; those intended for keeping are cut before they are quite ripe. Some are spread on beds of fern, others are hung up on hair lines in reverse, with the shoulders down, as that position prevents the berries from lying so close as to rot."

*Tillage and Manuring.* — The ground is hoed twice a year, after the summer training, and at the fall of the leaf, but never dug. The surface is always kept free from weeds, and loose to admit the air and dews. Old, light, warm manure is hoed in, every three years.

The superiority of the Thomery culture is attributed to the following peculiarities of practice, to which we would add the spur method of pruning.

"1st. To the judicious choice of cuttings, the vigneron never making use of any but such as have borne the best and finest fruits.

"2d. By planting the vines at a distance from the wall, and by frequently laying the shoots until they reach the wall,

the vines acquire abundance of roots upon the surface. Also, by the close planting, from which all undue luxuriance is restrained; by this means the branches complete their growth within the bounds prescribed, and ripen their wood early.

“3d. By limiting each plant to only one cordon, with two arms, right and left, the entire extent of both not exceeding 8 ft. The energies of the roots, confined to so small a space, nourish the bearing wood more effectually and more equally, and bring the fruit to greater perfection.

“4th. To the projecting coping, which protects the vine and fruit from frosts and heavy rains, and intercepts and retains the heat radiating from the surface of the wall and of the soil.

“5th. The sloping disposition of the ground also contributes to their success, as it prevents any accumulation of moisture at the roots of the vines, and preserves them sound and healthy.”

Mr. Robertson judiciously concludes, “we too frequently err, in making our borders for vines or peaches deeper than the influence of the sun and air can reach. Their depth should always be regulated by the temperature of the climate. In such a climate as that of France, where the summer heat is powerful, and penetrates deeply, if 3 or 4 ft. be necessary, in Great Britain or Ireland, where it is comparatively feeble, one half the depth may be sufficient, and a greater would prove pernicious.”

We consider this paper as a very important one; indeed by far the best that has *yet appeared* in this volume of these *Transactions*. We would recommend the young gardener and the amateur to study it in connection with the method of vine culture, described in *Gard. Mag.*, vol. iii. p. 145., and of pear culture, in the current volume, p. 60. In nine cases out of ten the unfruitfulness of wall trees in this country is owing to the too great depth and richness of the borders, and the continual cropping and digging of their surfaces. Hitt showed this nearly a century ago, as our correspondent Hiver has done in a preceding Number, but still we find the borders cropped, and the trees wasting themselves in young shoots in even the best gardens. We wish the Council of the Horticultural Society would make a general tour of the country, and criticise every kitchen-garden severely, so as eventually to teach gardeners to read with more profit than, we are afraid, they are in the habit of doing. We repeat our request, that our young readers will study Judd, the above paper, F. N. B., and Hiver, and shape their practice accordingly when they become masters.

42. *Observations on the Cultivation of Stove Plants.* By Sir Edward Poore, Bart. F.H.S. Read July 17. 1828.

Disliking plants in pots, the writer formed a conservatory for stove plants, 32 ft. by 20 ft. and 13½ ft. high, with a span roof. In a pit the size of the house (except the space necessary for the flues and walk), 4 ft. deep, and filled with turfy loam, peat, and sand, with a stratum of leaves at the bottom, he turned out all his stove plants, which throve beyond his most sanguine expectations. The average heat was 75° in the shade, "falling at night sometimes as low as 50°; the atmosphere has been saturated with moisture by keeping the walks and flues flooded with water; steaming was employed as long as fires were used, and syringing at all times."

43. *On a Method of obtaining late Flowers of Ranunculuses.* By Mr. Henry Groom, F.H.S. Read September 16. 1828.

The beds are prepared in the usual manner, but the surface is kept as low as the path, in order to retain moisture; the roots are dibbled in about the usual depth, and the ground immediately afterwards well watered with lime-water, not only because the ranunculus delights in moisture, but to destroy the worms, which are otherwise apt to draw the roots from their places. Afterwards the bed is kept well watered with clear cow-dung water, until the foliage makes its appearance. The beds are then kept shaded, from nine in the morning till five or six in the evening, till the bloom is over. For a bloom in September or October, plant about the middle of July. For a bloom all the season commence in February, and plant every fortnight or three weeks; in September plant in a frame, and you will have a bloom about January or February. [In the Royal Gardens at Munich, a bloom of ranunculus and of other plants is kept up all the year, by the above and similar practices.] During last autumn, Mr. Groom exhibited his ranunculuses from time to time to the Horticultural Society; and, we believe, he has received a medal for them.

44. *On the proper Management of Plants, during their Voyage from China to England.* By Mr. John Damper Parks, F.H.S., Gardener to the Earl of Arran, F.H.S., at Bognor, Sussex.

The case used is that recommended by Mr. Lindley. (*Encyc. of Gard.*, § 1405.) The plants being planted, the soil is covered with moss to keep it moist and in its place; this moss is crossed with laths, which are nailed tightly down. Place them in the poop, or some other part of the ship, where



they will get plenty of sun and light; shade, if they appear to receive too much sun; open the glazed sides in the day-time, and cover them with tarpawling late in the evening. In a hot climate, open the boxes as early in the morning as possible. In transferring plants from a tropical to a colder latitude, water sparingly so as to stint their growth, luxuriancy being a great disadvantage with reference to such changes. Cuttings of such plants as *Azàlea índica* may be brought to England, planted under bell-glasses, so as to exclude the salt atmosphere.

45. *An Account of a Cherry Orchard at Hylands, near Chelmsford, the Seat of Peter Cæsar Labouchere, Esq. F.H.S.* By Mr. John Smith, the Gardener.

This cherry garden we described in *Gard. Mag.*, vol. iii. p. 396.

46. *An Account of an easy Method of destroying Caterpillars on Gooseberry Bushes.* By Mr. Richard Williams, Gardener to Thomas Andrew Knight, Esq. F.R.S. &c. President.

Quicklime, fresh from the kiln, was sprinkled on the bushes, "taking up the lime in my hands at first, and afterwards in a small wooden spoon, standing on the side from which the wind blew, and dashing it in among the leaves of each bush;" afterwards, "I placed, with my hands, round the bottom of the stem of every bush, about half a pint of lime, to prevent the caterpillars climbing up." Strong lime-water, we consider a much better mode, because it is hardly possible to throw in the lime in such a way as to touch every caterpillar, which, however, may be done with water. At all events, if powdered lime is to be used, it is well to syringe the bushes first, in order that the powder may adhere, as was done by Mr. Sweet of Bristol, and published in the *Hort. Trans.*, vol. v. p. 76. (See *Encyc. of Gard.*, § 4665.)

47. *On the Culture of the Potato.* By Thomas Andrew Knight, Esq. F.R.S. &c. President.

"I have been led to endeavour to ascertain, by a course of experiments, the mode of culture by which the largest and most regular produce of potatoes, and of the best quality, may be obtained from the least extent and value of ground; and having succeeded best by deviating rather widely from the ordinary rules of culture, I send the following account of the results of my experiments."

The soil was shallow on a rock, it was collected with a plough into high ridges 4 ft. wide, and whole potatoes were then planted 6 in. apart, in a deep furrow made along the

centre and highest part of each ridge: manure was introduced over the potatoes, and mould was added so as to cover rather deeply. As usual with Mr. Knight's experiments, at least as related in these *Transactions*, something occurred to render the result less complete than it otherwise would have been. "A colony of rabbits" did a good deal of damage, and "pheasants" had eaten many of the tubers which the rabbits had exposed to view; but the remaining produce per acre exceeded 539 bushels of 82 lb. each, 2 lb. being allowed in every bushel on account of a very small quantity of earth which adhered to them.

The mode of culture is nearly that which is practised on a large scale by the farmers in Scotland, only they do not generally require to raise the soil on account of its poverty or shallowness, but sometimes they do, on account of a wet bottom. When sets are put in every third furrow, the dung is frequently put over them; when in the furrows of ridgelets, most frequently under them, but sometimes also over them. Mr. Knight's experiment, therefore, has no claim to novelty; the produce, however, certainly appears extraordinary, but to us, at least, not so, when we remark the way in which it was ascertained. It does not appear that an acre of ground was planted, and the produce measured, but "having found my crops of potatoes to be in the last three years, during which I alone have accurately adopted the mode of culture above described, much greater than they had ever previously been, as well as of excellent quality, *I was led to ascertain the amount in weight which an acre of ground, such as I have described, the soil of which was naturally poor and shallow, would produce.*"

Every farmer knows that nothing can be more fallacious than to draw conclusions, with reference to acres, from results that have taken place on, perhaps, a few square yards. A good crop of the yam in East Lothian seldom exceeds 400 bushels per English acre. Mr. Knight is "much inclined to think that he has raised, and shall raise in the present year, 1828, nearly as large a produce per acre of the small, early, ash-leaved kidney." In a postscript, dated March, 1829, he states "somewhat contrary to my expectations, the produce of the small early potato exceeded very considerably that of the large one above mentioned; being per acre 665 bushels of 82 pounds." (See *Gard. Mag.*, vol. iv. p. 147.)

We shall be particularly obliged to Mr. Knight, if he will state, not merely the contents of the surface, but the length and breadth from which the above calculation, and that relating to the crop of 539 bushels, were made; also, to a cer-

tain friend near Haddington, to let us know the heaviest crop of potatoes he has ever heard of having been grown in Scotland; and Mr. Fraser would much oblige us by similar information with regard to Ireland.

48. *On the Cultivation of the Pine-Apple.* By Thomas Andrew Knight, Esq. F.R.S. &c. President. Read August 19. 1828.

That no part of this paper may be lost on our readers, we shall give it entire, which we are not sorry to do, confessing ourselves unable, either satisfactorily to abridge it, or to draw any conclusions from it that would not, we fear, be attributed to our prejudices. (See *Encyc. of Gard.*, p. 538—540., and the first article of Retrospective Criticism, in the present Number.)

“ I have now completed a long course of experiments upon the culture of the pine-apple in the dry stove, the object of which has been to ascertain the means by which that species of fruit might be most advantageously grown, and particularly at those periods of the year, when the scarcity of other fruits gives it an additional value. In these experiments I have endeavoured to ascertain the effects of excess of drought, and of moisture; and of very high, and of very low, temperature. I have, of course, sacrificed many plants in experiments, which I neither found, nor expected to find, successful; but from these I have derived information, which, I believe, will prove useful to the cultivators, and advantageous to the consumers, of that species of fruit.\*

“ The effects of a very dry atmosphere necessarily were an inspissated state of the sap of the plant, and this, as it does in all other similar cases, led to the formation of blossom buds and of fruit; and it thus operated upon some pine-apple plants to such an extent as to cause even the scions from their roots to rise from the soil with an embryo pine-apple upon the head of each, and every plant to show fruit, in a very short time, whatever were its state and age.

“ Very low temperature, under the influence of much light, by retarding and diminishing the expenditure of sap in the growth of the plants, comparatively with its creation, produced nearly similar effects, and caused an injuriously early appearance of fruit.

“ Very high temperature, if accompanied with a sufficiently humid state of the atmosphere, I found beneficial at all seasons of the year under a curvilinear iron-roofed house, for this admitted as much light even in the middle of winter, as the pine-apple plants appeared to require.

“ Many months previous to the publication of Mr. Daniel's very excellent communication in the *Transactions* of this Society [*Gard. Mag.*, vol. i.

“ \* I have, in a communication last year to the Horticultural Society [*Gard. Mag.*, vol. iv. p. 565.], shown that the mould in pots circumstanced as those which contain my pine-apple plants are, acquires a temperature very nearly equal to that of the aggregate temperature of the air in the house, but not subject to such extensive variations. Thus, if the highest temperature of the air within the house during the day be 90°, and the lowest during the night be 70°, the temperature of the mould in the pots will nearly approximate the arithmetical mean 80°: and surely the intelligent gardeners of the present day must be fully sensible that mould at eighty degrees is warm enough without the aid of the irregular and un governable heat of a bark bed, whatever their ignorant predecessors, who first introduced the bark bed into the pine stove, may have thought.

p. 287.], and without being, in any degree, acquainted with his opinions, I had placed unglazed shallow earthen pans upon the flues of my curvilinear-roofed stove, such as he has recommended, nearly in contact with each other; and I had increased the dampness of the air within the house by keeping the ground, which is not paved, constantly very wet. The effects of excess of humidity in the air of the house were, as might have been anticipated, diametrically opposite to those which had resulted from drought; and the plants grew so rapidly as to become soon too large for the spaces allotted to them without indicating, at any season of the year, a disposition to show fruit. By subjecting these plants to the influences of the drier atmosphere, their exuberance of growth was soon checked; and the production of fruit immediately followed in every season of the year, provided that a sufficiently high temperature was given.

“ I have never cultivated the White Providence pine-apple, because I never thought it worth culture; nor any of the large varieties, except a very few of the Enville; and I have scarcely ever had a plant which has not fruited within less than twenty months of the period at which the sucker was taken from the parent plant; and the suckers were invariably taken off at the same time with the fruit. The utmost horizontal space which I have ever allowed to any plant, has not exceeded 23 by 24 in. during the latter half of its life, and less than half that space during the preceding part of it, and I, in consequence, have never had a pine-apple which has weighed quite 4 lb.\* But I possess, at the present moment succession plants of the greatest excellence, and such as I could cause to bear fruit of very great weight, if I chose to give them age and space; for, comparatively with the age and spaces allotted to the plants in my fruiting-house, the fruit of my older plants is of very large size, and, in every respect, exceedingly perfect. I also obtain a regular succession of produce without having ever many pine-apples ripe at the same period of the year; and I can venture confidently to assert that I could, without difficulty, in properly constructed stoves, cause crops of pine-apples to ripen regularly, and without failure, at any appointed period of the year. Some varieties of the pine-apple appear to me to be capable of acquiring a very high state of perfection under a curvilinear iron roof, in the most unfavourable seasons of the year, and the most excellent fruit of the species, in my estimation, which I have ever seen, has been that of the St. Vincent's or Green Olive, in the middle of winter; and my guests have, in more than one instance, unanimously coincided with me in opinion.

“ I have raised as many succession plants as I have wanted, and I have used a very large number (comparatively with the extent of my stoves) by placing my suckers and young plants to take root and grow over the flues between the larger plants; but crowns and suckers never emit roots more freely, nor afford better plants, than they do when placed in a common hotbed.

“ I often plant suckers without detaching them from the roots and stems of the parent plants; and for the purpose of receiving such roots and long stems, I employ pots which vary in depth from 18 to 22 in., with a cylindrical diameter of 11 in. only. Much time is thus gained; for plants thus raised, if properly managed, will afford good fruit at a year old; and they are capable, whilst young, of being very closely packed together.

“ Under a curvilinear iron roof, it will be necessary to shade the pine-apple plants during the first bright days of the spring, or the healthful verdant colour of their leaves will be tarnished; and also to shade the plants

---

\* Since the above was written, I sent a Black Jamaica pine-apple to the Horticultural Society, the produce of a plant which was some months less than two years old, and which was confined to the space above mentioned, which exceeded 4½ lb. in weight; but I have had no other quite so heavy.

during the long and bright days of summer, from ten o'clock in the morning to three in the afternoon, or the fruit will ripen with injurious rapidity at that season. For this purpose I employ a net, of the kind I use to cover cherry trees, doubled.

“ The gardener who has never cultivated pine-apples in a dry stove should bear in mind that, in giving water, he should put as much at once into each pot as will moisten the mould to the bottom of it, and avoid watering very frequently.

“ There are, in different parts of England, enormous heaps of coal-dust lying at the tops of the pits, of no value whatever, and in situations where pine-apples might be conveyed within three days to London, by water-carriage; and I am perfectly confident that these may be raised by the mode of culture recommended in this and former communications, at less than half the expense now incurred; and I do not entertain the slightest doubt that as large, and even larger, pine-apples may be raised without than with a hotbed of any kind. Nothing can be more easy than the act of giving a more regular and uniform warmth to the roots than that which can be given by the ever-varying heat of a bark bed; and a sufficiently humid state in the atmosphere of the house may be regularly produced by many different means.\*

“ Some gardeners, however, have, as I have been informed, wholly failed in attempts to cultivate pine-apples without the aid of a bark bed; and one case of this kind has come within my own observation. In this (and probably in all others) the failure obviously arose from want of sufficient humidity in the atmosphere of the house; for the plants not only grow best, but the fruit acquires, I think, its highest state of perfection when ripened in damp air, provided that there be a sufficient change of it, and that too much water be not given to the roots of the plants. A very dry state of the air in the stove is noxious, I believe, to almost every species of plant, and particularly to the pine-apple.†

“ Whenever it is wished that pine-apples should be produced of very large size, it will obviously be necessary to restrain the plants from bearing fruit till they have acquired a greater age than mine have ever been permitted to acquire; and in such case it will be beneficial to remove the plants annually into larger pots. This, when the pots, as well as the plants, are large, will not very easily be done without danger of injury to the roots. It has been my custom to remove melon plants of large size; and, to preserve the roots from injury in transplanting, I have had baskets, of loose texture and coarse workmanship, and consequently of very low price, made to fit the pots from which the melon plants were to be removed; if such baskets were to be introduced into the pots in which the pine-apple plants were placed in the autumn of one year, they would remain sufficiently sound till the following autumn, to enable the gardener to remove plants of the largest size without any danger of injury to their roots. It will also be necessary, when fruit of the largest size is required, to place the plants, at all periods of their growth, at considerable distances from each other, because the leaves of the pine-apple plants act less efficiently in the generation of sap, in proportion as they are made to take a perpendicular direction; and this direction they are compelled to take when they are laterally much shaded;

---

“ \* Any person who may be disposed to profit by the foregoing suggestion is at full liberty to inspect my pine stoves, and shall receive any information which I can give; and I can, with perfect confidence, promise him success.

“ † Very dry air appears to me to be particularly injurious, when it is made to come into contact with the roots through the sides of a porous and unglazed earthen pot; I suspect, owing to causes pointed out by M. Dutrochet: see *L'Agent immédiat du Mouvement vital*; and *Nouvelles Recherches sur l'Endosmose et l'Exosmose*.

for the leaves of this plant, like the stems of potato plants, are subject to the conflicting influence of gravitation\* and of light, the one labouring to give a perpendicular, the other a horizontal direction to the leaves; and the comparative power of one agent increasing as that of the other decreases.

"I shall conclude the present communication with an account of a very simple and efficient method of destroying the different species of insect that infest the pine-apple plant, which I have practised during the last two years with perfect success. Pine-apple plants are not at all injured by having water at the temperature of 150° of Fahrenheit's scale thrown upon and into them with a syringe. The mealy bug does not appear to be injured by a single washing, or immersion for a short time, in water of the above mentioned temperature; but if the application be repeated three or four times, on as many successive days, it wholly disappears. My gardener has, I have reason to believe, used water of a higher temperature than 150°, without any injury to the plants; but as hot water, when applied in the way above mentioned, will operate according to the compound ratio of its quantity and temperature, I would recommend the gardener, when he first uses it, to apply it to a worthless plant, and not to use water of quite so high a temperature as 150°. [See *M. Phail's Remem.*, and *Enc. of Gard.*, § 2911.]

"Having some red spiders upon the leaves of a fig tree in the stove, I endeavoured to ascertain the effects of hot water upon these. The first application of it appeared only to render them more alert and active; a second appeared to have diminished their numbers very considerably, and, after a third application, I could not discern any. Whether they had died, or marched off only, I am ignorant; and the period at which I remove my fig trees into the open air having arrived, I had no further opportunity of trying the experiment. I applied the water to the mature and somewhat old leaves only of the fig trees.

"*Note by the Secretary.* — *March 30. 1829.* During the last season, several specimens of the fruit of the pine-apple, managed as above described, were sent to the Society by Mr. Knight. They were all, without exception, of the very best quality in point of flavour; they were universally destitute of fibre, and, in every respect, as perfectly grown as any I ever saw of the same size."

---

ART. II. *Catalogue of Works on Gardening, Agriculture, Botany, Rural Architecture, &c., published since March last, with some Account of those considered the most interesting.*

BRITAIN.

*Curtis's Botanical Magazine, or Flower-Garden displayed; New Series.*  
 Edited by Dr. Hooker. In 8vo Numbers, monthly. 5s. 6d. col.; 5s. plain.

*No. XXVII. for March, contains*

2891 to 2897. *Hibiscus liliiflorus*. A mule, derived from *H. liliiflorus*, and *H. Rôsa sinénsis*; a charming plant, sent from the Mauritius to Mr.

---

"\* The influence of gravitation upon the forms of plants is still greater than I have inferred in my paper in the *Philosophical Transactions* upon that subject. M. Dutrochet, having used very superior machinery to that employed by me, discovered that if a seed be made to revolve upon its own axis, and its axis of rotation made to dip only a degree and a half below the horizontal line, the roots will always take the descending, and the germs the ascending, line of that axis."

Barclay of Bury Hill, by Charles Telfair, Esq. In the Mauritius it grows almost to a tree, and is in blossom nearly all the year. At Bury Hill it thrives luxuriantly; the flowers are very large, and their shades of red brilliant and elegant. — *Bilbérigia* *crucnta*; *Bromeliàceæ*. From Rio Janeiro to the Edinburgh Botanic Garden in 1824. — *Collòmia* (*kolla*, glue; character of the seed) *lineàris*. From Colombia, by Mr. Douglas, Dr. Scouler, and others. — *C. grandiflòra*. A fine new annual species, from the same place, by the same excellent collectors. — *C. heterophýlla*. An annual, from Fort Vancouver, by the same collectors. Professor Hooker observes that the genus *Collòmia* seems too closely allied to *Gília*, and Mr. Douglas seems to be of the same opinion. — *Frankènia* *pauciflòra*; *Frankeniàceæ*. An under shrub, with short linear reflected leaves, and terminal pink flowers, from New Holland to the Kew Garden. — *Calceolària* *poliflòlia*. From the Cordilleras to the Horticultural Society, by Mr. Macrae.

No. XXVIII. for April, contains

2898 to 2904. — *Cárica* (resemblance to the common fig, *Ficus Cárica*) *Papàya* (name in East Indies; probably from Papaya in Peru, whence the plant was originally carried thither.) (*fig. 65.*) The Papaw Carica, or Papaw tree. *Diœ'cia* *Decán. Lin., Nat. Ord.*

*Incértæ* *sèdis*, probably allied to *Urticææ*; placed among the *Cucurbitàceæ* by Jussieu but not by Decandolle, among the *Passiflòræ* by Richard, and among the *Tricóceæ* by Linnæus. "An upright, rapidly growing, unbranched tree, with somewhat of the habit of a palm, the foliage being large, and confined to the top of the tree; every part yielding a slightly acrid and somewhat milky juice." The stem is occasionally found from 14 to 15 ft. high in our stoves, but in the tropics it grows to the height of 20 ft., and bears fruit in three years, as it will do in the magnificent stoves now erecting at Syon House. The male and female flowers are sometimes on different trees, sometimes on the same tree, and sometimes even hermaphrodite. A tree in the Glasgow Botanic Garden produced fruit, the seeds of which yielded young plants, though Dr. Hooker never saw any but male flowers; female or hermaphrodite flowers must have existed contemporaneously on that or on some other tree, and we confess we are rather disappointed that the Professor's observations on this part of the subject are not more definite. The tree alluded to flowers at almost all seasons of the year, and bears fruit in the autumn and early winter.

The flowers (*a*) are of a yellowish white, and when the corolla falls away, the germen in coming to maturity becomes pendent: while the tree, advancing in height, casts its lower leaves from beneath the flowers, and the fruit, constituting a large oblong berry or pepo (*b*), rests suspended upon the leafless part of the trunk, like the flowers of the *Cércis*, the spines of *Gledítschia*, or the bread fruit. The characters of the fructification are at variance with those of every hitherto established natural order, "and we must wait till new discoveries will enable us to connect it with other vege-

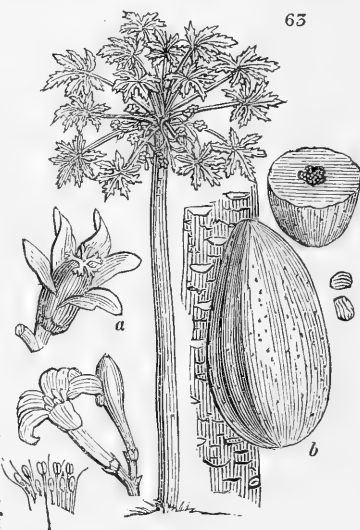

tables. Nevertheless, if it were absolutely desirable to give it a station in a linear series, it ought, perhaps, to be referred to the neighbourhood of the *Urticæ*."

Almost all the species of *Cárica* are natives of South America, but it has been doubted whether the present species be not indigenous in India. On this subject a passage is quoted from Mr. Brown's *Botany of the Congo*, which shows the value of the study of botanical geography. "Mr. Brown justly argues, that a careful investigation of the geographical distribution of genera, might often lead to a determination of the native country of plants now generally dispersed: for example, that in doubtful cases, where other arguments were equal, it would appear more probable that the plant in question should belong to that country in which all the other species of the same genus were found decidedly indigenous, than to that, where it was the only species of the genus known to exist. Hence that learned botanist and philosopher infers that the *Papaw tree* is a native of America, there being several other decidedly distinct species natives of that continent, while no species, except the cultivated *Papaw*, nor any plant nearly related to this singular genus, is known to exist either in Asia or in Africa."

The medicinal properties of the *Papaw tree* are various, and it is even eaten boiled and baked as turnips or apples. Dr. Hooker, having tasted that ripened in the Glasgow stove, "cannot recommend it as at all agreeable." The juice of the pulp is said to remove freckles, and to serve as a substitute for soap; it is also spoken of as a vermifuge. But the most remarkable property of this juice is, that when mixed with water it has the property of making meat tender which has been steeped in the mixture for eight or ten minutes. This property has been confirmed to Dr. Hooker, by gentlemen long resident in the West Indies. In a paper by Dr. Holder, in the *Trans. Wernerian Society*, vol. iii., it is said that the juice causes a separation of the muscular fibres; that the very vapour of the tree serves the same purpose, and that, accordingly, joints of recent butcher's meat and newly killed fowls are suspended among the leaves to render them tender. Even the flesh of hogs which feed upon the fruit will not keep by salting. The only peculiar property which chemists have found in the juice of the *Papaw* is fibrine or animal matter; but whether or not its power of hastening the decay of meat be attributable to this animal matter, does not appear to be determined.

*Begonia insignis*. A beautiful species from the Botanic Garden, Berlin, to the Edinburgh Botanic Garden; but Professor Graham cannot state its native country. — *Azalea ledifolia*. An erect much-branching, but rather stunted, shrub, 2 or 3 ft. high, with white odoriferous flowers. Introduced from China in 1819, by Mr. Brookes of the Ball's Pond Nursery. — *Euphorbia splendens*. From a drawing by Mrs. Telfair of the Mauritius. The plant was found by Professor Bojer, on the borders of fields in the province of Emirne, in Madagascar, and it is hoped will soon be introduced into our stoves. — *Pentstemon ovatus*. "Perhaps the most beautiful of all the numerous species of this genus lately detected in N. W. America by Mr. Douglas, and equally hardy with the rest." Flowers of a rich ultramarine colour. — *Podolepis gracilis*. From Mr. Fraser, of New South Wales. Pretty, and may be treated as a hardy annual.

*No. XXIX. for May, contains*

2905 to 2910. — *Dombeya angulata*; *Büttneriæ*. A shrub from the Mauritius, with somewhat of the habit of *Astrapæa*, raised in the stove of the Glasgow Botanic Garden. — *Dendrobium æmulum*; *Orchidææ*. — *Méntha verticillata*, *Crinum plicatum*, *Erythrolæna conspícua* (figured in *Gard. Mag.*, vol. ii. p. 298.), *Verbena bracteosa*. Two of these plants are on 4to plates, and the whole are engraved from beautiful drawings by Dr. Hooker himself.



*Edwards's Botanical Register.* Continued by John Lindley, F.R.S. L.S. &c. Professor of Botany in the London University. In 8vo Numbers, monthly. 4s. coloured.

*No. I. of Vol. XV. for March, contains*

1217 to 1223. — *Lupinus plumòsus*; *Leguminòsæ*. From Northern California, in 45° north, growing in gravelly soil, and flowering through June and July. — *Fris ténax*, Common in North California, in dry soils, or open parts of woods. The leaves are linear, rigid, tough, and ever-green; flowers of a dark purple, on stems about half the length of the leaves. “The native tribes about Aguilar river, in California, find this plant very serviceable for many purposes; from the veins of the leaves fine cord is made, which is converted into fishing nets; and from its buoyancy, great strength, and durability, it suits this purpose admirably. It is also made into snares for deer and bears; and a good idea may be formed of its strength, when a snare, not thicker than a 16-thread line, is sufficient to strangle *Cérvus A'lces*, the Great Stag of California, one of the most powerful animals of its tribe. The cordage is also manufactured into bags and other articles.

“From the foregoing account, and from what we have seen of the plant, we incline to think it might be profitably cultivated in waste land in this country for hemp. It is quite hardy, grows readily, and might soon be increased considerably; being a perennial, it would be cultivated at little expense, and there is no doubt that it would be far more advantageous to a British agriculturist than the celebrated New Zealand flax, of the success of which in this climate there is now, we presume, no probability.”

*Amarýllis coránica*, var. *pállida*. From J. H. Slater, Esq., of Newick Park. — *Ænothèra vimínea*. From the north of California, by Mr. Douglas. “A sort of woody annual, of great beauty, and perfectly hardy.” — *Æ. decúmbens*. From the same place, by the same gentleman; a hardy annual, of easy culture. — *Spiræa chamædrifòlia*. A hardy shrub, from Kamtchatka, “where the inhabitants use the leaves for tea. The strong shoots are manufactured into smoking tubes for tobacco pipes, and the plant itself makes excellent clipped hedges.” — *Tupistra* (dim. of *typis*, a mallet; flower) *nùtans*; *Aròideæ* § ?? *Túcceæ*. A singular plant from the East Indies, by Dr. Wallich.

*No. II. for April, contains*

1224 to 1231. — *Corræa pulchélla*; *Rutææ*. Introduced from New Holland, by Mr. Mackay of the Clapton Nursery, about 1824. A handsome under-shrub, of easy culture and preservation in a cold pit. — *Trachymène* (*trachys*, rough, *hymèn*, a membrane; coat of the fruit.) A beautiful blue-flowered New Holland annual, from Mr. Fraser of the Botanic Garden, Sydney, flowering in the open border in October and November; but must be protected by glass to perfect its seed. — *Stachys Sálviæ*. A handsome half-shrubby plant, from the neighbourhood of Valparaiso in 1825, by Mr. James Macrae, and more remarkable as a botanical curiosity than as an object of horticultural interest. — *Justícia pícta*, frequent in British collections, and one of the commonest of shrubs cultivated in India. Native country unknown. Dr. Wallich, in his extensive journeys in India, has never seen it but in gardens. — *Coreópsis aërea*. A hardy biennial, remarkable for the beauty of its handsome yellow flowers, supported by slender stalks 3 ft. high. — *Cotoneáster frígida*. From Nepal, by Dr. Wallich, and through the East India Company to England. A small, but very handsome, hardy deciduous tree, with snow-white blossoms during April and May, and bunches of crimson haws in September and October. — *Lupinus arbústus*. Perennial, in gravelly soils in North California, invariably under the shade of solitary pines and oaks. By Mr. Douglas, to the Horticultural Society. — *Cánna díscolor*.

## No. III. for May, contains

1232 to 1239. — *Caprifolium longiflorum*. A honeysuckle with the habit of *C. japonicum*, but wholly destitute of the hairs of that species, and its fruit is white, not black. From China to the Horticultural Society, by Mr. Reeves, in 1826. It may be considered a valuable addition to our hardy climbers. — *Scóttia* (Dr. Robert Scott, Profess. of Bot., Dublin) *dentata*; *Leguminosæ*. A green-house plant from New Holland, "exceedingly deserving of cultivation." — *Clématis chlorántha*; *Ranunculææ*. A stove climber, from Sierra Leone in 1823, by Mr. George Don. — *Spermadíctyon* (*sperma*, a seed, *diktyon*, a net; net-like arillus, with which the seeds are said to be covered) *azúreum*; *Rubiææ*. A shrub from Nepal, where it perfumes the air, by its delicious fragrance, from November until March. Presented by the East India Company to the Horticultural Society, where it flowered [in the stove, we presume] in January last. — *Reevèsia* (in honour of John Reeves, Esq., now resident at Canton, to whom we are indebted for our knowledge of this plant; and whose unwearied exertions in the cause of science have materially elucidated the botany of China, and bestowed on our gardens many of the fairest ornaments they contain) *thyrsóidea*; *Bytneriææ*. A handsome, green-house, evergreen shrub, with white flowers, and so remarkable in point of affinity, that it is stationed between *Pterospérmum* and *Sterculia*, "confirming the propriety of M. Kunth's combination of the *Sterculiææ* of Ventenat with the *Bytneriææ* of Mr. Brown; and, in fact, breaking down every barrier between them." — *Ribes setósum*. "By far the most ornamental of all the gooseberries yet in our gardens." The flowers are white, the branches and prickles of a brownish red, and the berries black, but of no merit as edible fruit. — *Ruéliá Sabiniana* (named by Dr. Wallich in compliment to Joseph Sabine, Esq., F.R.S. &c. &c., the indefatigable Secretary of the Horticultural Society); *Acanthææ*. An "extremely beautiful flower, which will probably become one of the choicest ornaments of our hot-houses. The leaves, when young, are of a deep purple on their lower side; the flowers are of a delicate, very transparent, violet blue; and the bractæ, which remain long after the flowers have fallen, being of a warm, lavender colour, and closely covered with transparent glands, give an air of beauty to the plant when the flowers themselves have fallen. It is a tender green-house plant, propagated by cuttings. A cold green-house would not be suitable, and a stove appears to be too hot for it." Native of the Pundica mountains. — *Dendrobium* (*dendron*, a tree, *biō*, to live; all the genuine species are found upon trees in the hot parts of the East Indies). A stove epiphyte, which grows more freely than some others.

*The Botanical Miscellany*: containing Figures and Descriptions of such Plants as recommend themselves by their Novelty, Rarity, or History, or by the Uses to which they are applied in the Arts, in Medicine, and in Domestic Economy; together with occasional Botanical Notices and Information. By William Jackson Hooker, LL.D., F.R.A. and L.S., and Regius Professor of Botany in the University of Glasgow. London. 8vo, in Parts quarterly. 15s. col.; 10s. 6d. plain.

A paragraph on the cover states that, "whilst the Continent boasts of her periodical works, destined to include descriptions of new plants and miscellaneous notices relative to botany exclusively, our own country has yet no work of the kind;" and that "it is with the view of supplying this desideratum, that the Editor has made the present work to include such miscellaneous notices as might give it the character of a Journal, besides the descriptions and figures of those plants in particular which are new or little known, or are useful in the arts, in domestic economy, or in medicine, and which have not yet been figured and described in any work to which the general reader may obtain access."

The descriptions and figures come first in order, and are as follows: —

1 to 45. — *Spíridens* (*spira*, a spire, *dens*, a tooth; spiral teeth of the peristome) Reinwárdtii; *Músci*. “The most noble of all mosses,” from the Molucca Islands. The essential characters of this genus bear considerable relation to those of *Hýpnum*. — *Bryum* Gillièsii. A curious little moss from the Andes. — *Astèlia alpina*; between *Asphodèleæ* and *Júnceæ*. A *Càrex*-looking plant, from Mount Wellington, in Van Diemen’s Isle, where it grows at an elevation of 4000 ft. above the level of the sea, forming densely matted patches. — *Mutisia ilicifolia* (*fig. 64.*); *Compósitæ*. A climbing plant from Chile, with varied and singular leaves terminating in tendrils, and showy red flowers. The *Mutisias* are recommended to the horticulturist, “as no plants can be more worthy of a place in our stoves.” — *Mutisia runcinata*, *infléxa*, *subspinósa*, *linearifolia*, and *linifolia*, all gathered by Dr. Gillies; and W. Cruickshanks, Esq., in Chile, are also figured. — *Jungermánnia serrulata*  $\beta$ ; *Hepáticæ*. A beautiful variety of a species found in Jamaica, and in the Isle of France. — *U'snea fasciata* and *sphacelata*; *Lichènes*. From the antarctic regions, and the latter found also upon Table Mountain in Van Diemen’s Island. — *Stícta macrophýlla*; *Lichènes*. From the Mauritius. — *Stícta Humbóldtii*. From New Granada. — *Adenocaúlon* (*adén*, a gland, *kaulos*, stalk; glands on the stalks) *bicolor*; *Compósitæ*. A curious herbaceous plant, brought by Dr. Scouler from Colombia. — *Swietènia Mahágoni*, the Mahogany Tree; *Meliàcææ*. Mr. Robert Brown suggested to Dr. Hooker that the Honduras mahogany tree may be a species different from the mahogany tree of Jamaica; Dr. Hooker laments that the botanical characters of the Honduras tree should not be known to botanists, though workmen consider the Jamaica mahogany as much the most valuable wood. From these observations it seems impossible to decide whether the Jamaica, or the Spanish mahogany (as it is called by the London cabinet-makers), was first introduced into notice in Europe. “The first discovery of the beauty of mahogany wood is attributed to the carpenter on board Sir Walter Raleigh’s ship, at the time that vessel lay in some harbour in the Island of Trinidad, in 1595. Dr. Gibbons brought it into notice in England. He was an eminent physician about the end of the seventeenth, or beginning of the eighteenth, century; and a box for holding candles, and then a bureau, made of a block of mahogany, were given to him by his brother, a West Indian captain.” At Honduras a tree is not considered fit for cutting till it has attained 200 years. “The season of cutting is August; gangs of from twenty to fifty men are employed, headed by what is called a huntsman; who searches the bush, or woods, for trees. He does this by climbing up the tallest tree he can find, and from thence surveying the surrounding country; the leaves of the mahogany at this season being of a yellow-reddish hue, he can discern proper subjects for cutting down at a great distance. The tree is commonly cut about 10 or 12 ft. from the ground; the trunk is considered the most valuable part; but the wood of the limbs is much closer in the grain, and the veins more rich and variegated. “A sufficient number of trees being now felled to occupy the gang during the season, they commence cutting the roads, which may fairly be estimated at two thirds of the labour and expense forming the



prime cost of the timber. Each mahogany work forms in itself a small village on the bank of a river; the choice of situation being always regulated by the proximity of such river to the mahogany intended as the object of future research." After the habitations are arranged, including the proprietor's residence, with store-houses, cattle-sheds, &c., a main road and branch roads are opened, by cutting down the underwood and other trees, a labour generally performed by the job, aided by fire when necessary. The roads are generally ready by the month of November, when cross-cutting commences. The size of the log is regulated so as to be drawn by the number of oxen in the "work" for that purpose. The largest log ever cut in Honduras was 17 ft. long, 57 in. broad, and 64 inches deep. This work is generally completed by the month of March, and the logs are drawn out during April and May, the only months fit for that purpose, as during all the rest of the year the ground is too soft to admit of a heavily laden truck to pass over it without sinking. Owing to the intense heat of the sun, the cattle are unable to work in the daytime, and consequently the operation is performed from about six o'clock in the evening till about eleven o'clock in the morning. "Nothing can present a more extraordinary spectacle than this process of trucking or drawing down the mahogany to the river. Six trucks will occupy an extent of road of a quarter of a mile, — the great number of oxen, the drivers half naked (clothes being inconvenient from the heat of the weather and clouds of dust), and each bearing a lighted torch; the wildness of the forest scenery, the rattling of chains, the sound of the whip echoing through the woods; then all this activity and exertion, so ill corresponding with the still hour of midnight, make it wear more the appearance of some theatrical exhibition than what it really is, — the pursuit of industry which has fallen to the lot of the Honduras woodcutter."

"About the end of May the periodical rains again commence. The torrents of water discharged from the clouds are so great as to render the roads impracticable in the course of a few hours, when all trucking ceases, the cattle are turned into the pasture, and the trucks, gear, and tools are housed."

In St. Vincent, where the mahogany does not appear to be indigenous, it seldom grows higher than 50 ft., with a diameter of 18 in. It flowers there in May and June; the bark is astringent and bitter, and may be used like the Peruvian bark,

*Scouleria aquatica*; *Músci*. From the north-west coast of America. — *Bryum Menziesii*. From Nootka Sound. — *B. giganteum*. — *Dicranum phascoides*; *Músci*. — *Ríccia natans*; *Hepática*. — *Parnássia fimbriata*; *Droseraceæ*. Discovered by Mr. Menzies on the north-west coast of America. "Mr. Menzies observed that the stamens, after having performed their office of fertilising the stigmas, which they do by approaching the pistil in succession, each remaining some time in contact with the stigmas, fall back in a horizontal position between the petals, giving an appearance of great regularity to the whole flower." — *Menyánthes crista-galli*; *Gentiàneæ*. Another "charming plant," discovered by Mr. Menzies in the north-west coast of America in marshy mountain pastures in Prince William's Sound. — *Pohória aphýlla* and *tenélla*; *Gentiàneæ*. From hilly, humid places in Martinique and St. Vincent. This completes the figures and scientific descriptions of twenty-five plants, on twenty-four plates.

The miscellaneous part of the work commences with a translation of Schultes's botanical visit to England, from the *Botanische Zeitung* for 1825. M. Schultes is profuse in his compliments to some individuals, but severe on the rector of the university of Cambridge for prohibiting Sir James E. Smith from delivering lectures on botany there, because he was a dissenter.

*The Botanic Garden at Cambridge* "does not present so pleasing an

appearance as the Dutch botanic gardens; but is, however, kept very neat, and is well arranged."

*The Botanical Garden at Oxford* was originally the burial place of the Jews, till they were banished by Edward I. in 1290. "It is the oldest botanic garden in England, being founded in 1622. It includes five acres; but is so liable to inundation from the Thames, that the water frequently stands knee-deep above the plants; and as the lower parts of the garden cannot be sufficiently raised without an immense expense, these portions are left quite uncultivated. The active gardener, who is a Scotchman named Baxter (Vol. I. p. 490.), devotes his attention chiefly to the Cryptogamia; partly from mortification at finding it impossible to make the garden such as he could wish. He is preparing a *Flora Cryptogamica* of the environs of Oxford; and he showed us the first number of this work, containing specimens very neatly laid out, to which we must invite the attention of our countrymen in Germany. Mr. Baxter also cultivates with zeal the English willows, having a living individual of almost every species, in a proper Salicetum. To the grasses, likewise, he gives much attention; and, from the experience of several years, he is enabled to decide that *Agróstis verticillata*, vulgaris, decumbens, fasciculata (Curt.), and stolonifera are distinct species; which, when subjected to the same culture for a great length of time, still continue to preserve their characteristic marks. This industrious man, with the assistance of three persons, each of whom receives 2s. per day, cultivates between 4 and 5000 species of plants in the wretched houses of this garden; though, in fact, there is only one stove, properly so called, and this is much too small. Those which grow in the open air are, like the plants of Cambridge, arranged agreeably to the Linnean method, and separated into the indigenous and foreign kinds; and both of these are again divided into annual, biennial, and perennial, by which the study of the allied species becomes difficult. They are partly cultivated in beds; partly in separate squares, without any view to the effect which this must naturally offer to the eye."

When Linnæus, then a very young man, presented himself at Oxford to Dillenius and Sherard, the former received him coolly, and said to Sherard, "This is the young fellow who is putting all botanists and botany into confusion." They were reconciled to the young reformer, however, before he left Oxford.

Much is said of the urbanity of Mr. Don, the librarian of the Linnean Society, and the curator of the herbarium of Mr. Lambert, and with great justice, as every one must allow who has had any thing like our opportunities of judging. (See Preface to *Encyc. of Plants*, and *Mag. Nat. Hist.*) He was delighted with Mr. Lambert's treasures; but Mr. Brown being at Naples, he could not see the Banksian Library. Mr. Lambert "is to England what Count Sternberg is to Bohemia, Count Hoffmannsegg to Saxony, and Baron de Lessert to France." This is the sort of compliment to which Mr. Lambert is justly entitled; and we think the translator would have shown a better taste, if he had omitted, in this and other instances, the trifling and very natural errors of a foreigner, in calling Mr. Lambert a Count, and Mr. Brown and Mr. Menzies, Sirs; unless it is meant that we are to judge of M. Schultes's general accuracy from his accuracy in these particulars; or, perhaps, it is intended to raise a smile at the expense of this good-natured foreigner. M. Schultes made several excursions with his old friend Señor Lagasca, and among others to

*Kew Gardens*. Here he was disappointed, "particularly in the plants which grow in the open air, which are not so accurately named as those in the Göttingen botanic garden, superintended by Schrader; sometimes the same species is marked with two different names. The garden at Kew consists of a fine park, and a large botanical garden of about twenty acres. What we usually term a park in Germany is like any thing rather than

what receives the same appellation in England; and which is neither more nor less than a wood, in which nature and art seem to dispute for the original formation and present possession. As in a wood, one may walk, ride, and drive about it, without risk of interruption. English parks are, in fact, beautiful woods, and nothing more; and it will ever remain one of the most difficult problems in the delightful science of laying out pleasure-grounds, so to place a charming wood, as that he who is in it shall not know whether he is in a grove or a house [!]. We have, on the Continent, many exquisitely formed gardens, under the name of English ones; but an English park I have only seen in England. The botanic garden at Kew is surrounded by high walls, and intersected into long squares. With regard either to its plan, or its nine or ten stoves, it will not bear a comparison with those of Malmaison or the Grand Duke of Weimar, of Prince Esterhazy at Eisenstadt, or even with the botanical division of the Imperial Garden at Schönbrunn."

"The *Garden of the Horticultural Society* at Turnham Green, scarcely half-an-hour's distance from Kew, is of far greater importance to the art of gardening, which is, indeed, the proper design of the study of botany. This establishment, which is described in the *Horticultural Transactions*, is likely to prove of incalculable advantage to Britain and to all Europe: every branch of horticulture, except the ornamental, being here pursued to the greatest extent, and according to the purest scientific principles; such as the cultivation of fruits and vegetables, both forced and in the open air; and of flowers, whether abroad or under glass. No less than 35 acres of land are destined to the accomplishment of the necessary experiments, surrounded by a lofty wall, and again walled off into partitions. By this plan, however, the Society appears to have intentionally sacrificed to the picturesque. About forty workmen are kept in this Vineyard of the Lord, who are under the superintendence of a very able gardener, Mr. Munro. At present there are five stoves, two of them built after the newest plan, with convex windows, which are found to be highly advantageous. A very large house is to be erected next year, and heated by steam. We, of Germany, must long want a great advantage which the English possess in their stoves; namely, the very slender iron frame-work in which the panes of glass are enclosed, thus uniting durability with the advantage of admitting the greatest quantity of light. The price of these iron frames in England, where every thing is six times as expensive as with us in Bavaria, amounts to no more than we should pay for a frame of wood that would not last above a year. The Horticultural stoves contain many valuable plants from China and Sierra Leone, brought by Mr. Don's brother, who had resided there for some time. So fine a collection of roses exists no where else; the celebrated Mr. Sabine, who is secretary to the Society, having been engaged in studying this tribe for almost thirty years. They are arranged in large squares; one might almost say, in small groves of roses, native and foreign, single and double. On comparing this garden with those of the ancient Universities of Cambridge and Oxford, one cannot, for a moment, hesitate in declaring the superior influence that this must have in benefiting the country; although it has only been formed within these few years by the joint exertions of a few private individuals. The friend of mankind contemplates with pleasure, how much more a well-directed society of spirited men can effect in ten or twelve years, with the small sum of about 60,000 florins raised among themselves, than has been performed by the two great learned bodies of the kingdom, with their millions. Whoever doubts the influence which the Horticultural Society has produced on the nation, or who thinks that our ideas of its value are over-rated, we would advise him to attend one of their sittings, and there to see what is done by the members of this institution; and then, like the *wisest*

of the apostles, Thomas, when he shall have weighed in his hand what is sent thither, when he shall have tasted of the fruit, and inhaled the rich perfume diffused by pines, peaches, and nectarines, he will, perhaps, satisfy himself that it is not all a phantasmagoria. We had the honour of being present at a Meeting of the Society in September, 1824; and we must confess that although conversant with the rearing of fruit for almost forty years, we had never beheld finer peaches, nectarines, plums, melons, grapes, and pine-apples, than we saw here. We had been much disappointed in the London fruit-markets, where we certainly saw uncommonly fine-looking fruit; but, on tasting, found them to be acid or insipid, compared with the produce of our southern hemisphere, in Tyrol, the south of France, and Lower Hungary; but after having enjoyed the flavour of the fruit here presented to us, it was easier for us to abandon our prejudices against this kind of English produce, than to conceive how so northern and foggy a climate could have brought to perfection such rich fruit; how Art has thus overcome the omnipotence of Nature."

*The Chelsea Botanic Garden* possesses "neither the great size nor beauty, and still less elegance; yet includes, among the 6000 plants there cultivated, many very rare officinal vegetables, some of which are to be found nowhere else. He who would here study botany has a rich field open to him; its value enhanced by Mr. Anderson's experienced remarks."

"*The Garden of the cheerful Haworth*, at the Queen's Elms, near Chelsea, who indefatigably and exclusively studies the succulent plants, and possesses many extremely rare ones," was visited, and the stranger cordially received and highly gratified. The herbarium of Mr. Menzies is one of the neatest he has ever seen.

"At *the British Museum* we had expected to find a treasure of natural history; but, except Sloane's collection of dried plants in thirty volumes, and a herbarium which belonged to a M. van Moll, with a small, but well preserved set of British birds, we found nothing that interested us at all."

"We have visited the celebrated *Flower-Market of London*; of which no German, who has not seen it, could form a proper idea. What chiefly struck us is, that the greatest rarities and the most trifling articles are here exposed for sale together, and that both are eagerly bought. Were such things to be carried to the *Marche aux Fleurs* at Paris, not a pennyworth of them would be sold. But by the two flower-markets of these two principal cities of Europe, an estimate of the different character of their inhabitants may be formed. The wealthy and respectable Englishman, who is a connoisseur, will purchase nothing that is common; for, if pretty, he has it already in his garden: and the poor Londoner, who cannot afford to buy what is beautiful, will still obtain, if possible, something green to decorate the window of his dark little attic, and give his last farthing for a bit of verdure. The opulent Frenchman, who values all objects only as they please the eye, without reference to their being common or scarce, is willing to pay a greater price for a lovely rose-bush, than for the rarest plant from New Holland or the Cape of Good Hope; and as to the poor artisan of the French capital, he only thinks of vegetable productions as they are fit for culinary uses; and whether they be blue or green to look at, is the same to him. Hence it arises that the Parisian flower-market offers a much more delightful vista than that of London, though it is much smaller and more poorly stocked, as the French capital itself cannot compare with London for extent or wealth."

*The public squares of the metropolis* astonished and delighted him, and still more so the public nurseries, especially

*The establishment of Messrs. Loddiges*, of which he declares, with great truth, "it would be hard to say whether its great extent and the beautiful productions with which it is stocked, or the judgment, taste, and liberality

with which it is conducted, are more worthy of admiration. With regard to the latter point, we will venture to say, that much as we have travelled and seen, we have met with no stoves, belonging to prince, king, or emperor, which can compare with those of Messrs. Loddiges, at Hackney, for the magnificence, convenience, and elegance of their plan, and the value of their contents." On asking one of the Messrs. Loddiges what might be the value of the plants in the whole collection, supposing that every one in the catalogue were sold according to its price as there marked; about 200,000*l.* was the reply.

Of Ireland he says, he was informed by very many Englishmen that "it is safer to travel among savages than in the west coast of Ireland, which is the reason why the botany of that country is as little known as that of Sardinia."

The next paper contains a notice of the Wurtemberg Botanical Society for collecting specimens, which we have before referred to, both in this Magazine, and in the *Magazine of Natural History* (p. 81.).

*Localities of some rare plants, found by W. Wilson, Esq. of Warrington, chiefly among the Breadalbane Mountains of Scotland, in the summer of 1827, occupy seven or eight pages.* Some account of the substance commonly known under the name of Rice Paper, succeeds. This appears to be *Æschynomene paludosa Rox.*, Papilionacæ; a perennial, of straggling low growth, abundant in the marshy plains of Bengal. The stems, which seldom exceed an inch in diameter, are brought to the markets of Calcutta in a green state in great quantities; the thickest are cut into laminæ, not by transverse sections, but by cutting vertically round the stem. The bark of the stem is so thin, that it may be scratched off with the thumb nail, so that the whole of the laminæ are formed of pith. From these laminæ, each of which may be 8 or 9 in. long, and 6 or 7 in. broad, the natives form artificial flowers, and various fancy ornaments to decorate their shrines at Hindoo festivals. The Indians make hats of rice paper, by cementing together as many laminæ as will produce the requisite thickness: in this way any kind of shape may be formed; and, when covered with silk or cloth, the hats are strong and inconceivably light. It is an article of great use to fishermen; it forms floats of the best description to their extensive nets. The slender stems of the plant are bundled into fascines about 5 ft. long; and with one of these under his arm does every fisherman go out to his daily occupation. With his net on his shoulders, he proceeds to work without a boat, and stretches it in the deepest and most extensive lakes, supported with this buoyant faggot.

A Flora of the British possessions in North America is announced by Dr. Hooker; and Sketch of a Journey to the Rocky Mountains, and to the Colombia River in North America, by Thomas Drummond, Assistant Naturalist to the second Land Arctic Expedition, is commenced in the last two pages (95 and 96.), and is to be continued in next part.

The plates are beautifully executed, and, considering this and their number, the work is certainly not dear: we wish we could express confidence in its success; but that, to such an extent as to pay, we can hardly think any of the parties concerned can expect. The present is neither the country nor the time for such a result.

*Botanical Cabinet.* By Messrs. Loddiges. In 4to and 8vo Parts, monthly, Large paper, 5*s.*; small paper, and partially coloured, 2*s.* 6*d.*

No. CXLIII. for March, contains

1421 to 1429. — *Trifolium fimbriatum.* From North America, by Mr. Douglas. Pretty, 6 in. high, and easily cultivated. — *Lysimachia longi-*



folia. (fig. 65.) From wet woods in Pennsylvania and Virginia. Hardy, a foot high, and very beautiful. — *Selago fasciculata*. — *Tigrídia pavonia*. — *Cœlogyne fimbriata*. An orchideous epiphyte from China, with a trailing bulb-bearing stem. — *Erica Petiverii*. — *Clèthra acuminata*. A mountain tree of Carolina, flowering in August.

66



*Iris moræoides*. — *Pentstemon atropurpurea*. (fig. 66.) Perennial, or half-shrubby, about 2 ft. high, with rich and beautiful flowers in autumn of a deep red colour. — *Alœe expansa*.



65

No. CXLIV. for April, contains

1431 to 1440. — *Solànum myrtifolium*. Beautiful, deep, glossy, green leaves, and blue flowers. — *Erica crinita*. The flowers very beautiful, and of long duration. — *Lýchnis coronata*, *Hedýsarum obscurum*, *Lobèlia fulgens*, *Leuco-*

*pogon polystachyus*, *Monárda punctata*, *Pentstemon pulchella*, *Begonia semperflorens*, and *Dichorisandra oxypétala*.

No. CXLV. for May, contains

1441 to 1450. — *Pittosporum tomentosum*, *Podalyria sericea*, *Erica vernix*, *Melaspheerula parviflora*, *Astrapæa Wallichii*, *Rhododendron dauricum*, *Calothamnus clavata*, *Ruèllia picta*, *Amaryllis rutila*. — *Hovea elliptica*, a New Holland shrub, with dark blue flowers in February and March. *Hovea Celsi* has also blue flowers at this season, and, being a free grower and abundant flowerer, ought to be in every collection.

*The British Flower-Garden*. By Robert Sweet, F.L.S. &c. In 8vo Numbers, monthly. 3s.

No. LXXIII. for March, contains

289 to 292. — *O'robos* (*orō*, to excite, *bous*, an ox; strong thriving food for oxen) *Fischèri*. Handsome, with purple flowers and linear leaves; presented to R. Barclay, Esq. by Dr. Fischer, and supposed to be a native of Siberia or Russia. — *Rhododendron sinense* var. *flavescens*. The *Azalea sinensis* of Loddiges' *Bot. Cab.*, and of Sweet's *Hort. Brit.* Mr. Sweet considers that *Rhododendron* and *Azalea* cannot be kept apart as distinct genera, and has therefore given the latter genus as a section of the former. The only difference between them being the number of stamens, and this does not hold good in *Azalea indica*. The two genera, or as they may now be considered, the two sections, "mule together so readily" that there can be no end to the varieties which they may produce. — *Digitalis lanata*. — *Gèum Quéllyon*. From the mountains in Chile, with scarlet flowers, of easy culture, and increased by division or by seeds. From Mr. Knight's Exotic Nursery in the King's Road.

No. LXXIV. for April, contains

293 to 296. — *Chelone Lyoni*. Large purple flowers, and of easy culture, in light rich soil. — *Oenothera taraxacifolia*, Dandelion-leaved *Oenothera*. Perennial; very handsome, with large white flowers from June to November. — *Verbena pulchella*. Pretty, with lilac flowers, and requiring a little protection in winter. — *Psoralea glandulosa*; *Leguminosæ*. A handsome shrub, with purplish blue flowers, from Chile, where the plant is considered efficacious as a vermifuge and stomachic.

## No. LXXV. for May, contains

297 to 300. — *A'cis* (a handsome Sicilian shepherd) *ròsea*; *Amaryllidææ*. An elegant little bulb, from the south of Europe, with pale, rose-coloured, nodding flowers in August. Fulham Nursery. — *Rhéxia ciliòsa*; *Melastomææ*. A perennial with ovate acute strongly 3-nerved leaves, and terminal flowers of bright red and purple, from North America to the collection of Robert Barclay, Esq., at Bury Hill. — *O'rchis sambùcina*. From Switzerland to Mr. Colville's nursery, where it thrives well in rich loamy soil, rather moist. *Spatalánthus* (*spatalos*, delicate, *anthos*, flower) *speciòsus*; *Irídeæ*. A splendid bulb-tuber, from the Cape of Good Hope, by Mr. Synnot, to Mr. Colville's nursery, where it grows in a mixture of light turfy loam, peat, and sand, either in a frame or in a warm border, covered with mats in frosty weather.

The present number completes the third volume; and is accompanied by a systematic index to the volume, in which the species are arranged according to their natural affinities; a similar index for all the three volumes; and alphabetical indexes to the present volume, and to the three volumes.

The *British Flower-Garden* is, therefore, a most desirable work for the amateur or botanical student, because he may not only study the plants from their descriptions and from figures drawn and coloured from nature; but all the plants being hardy, he may purchase and plant them, and study them in a living state.

*Geraniaceæ*. By Robert Sweet, F.L.S. &c. In 8vo Numbers, monthly. 5s.

Nos. IX., X., and XI. for March, April, and May, contain

33 to 40. — *Pelargòonium coilophýllum*, *P. picturatum*. *P. Cummíngiæ*, "named in compliment to Lady Gordon Cumming, a great admirer of this handsome family, and a lady much attached to the science of botany." *P. calamistratum*. *P. saturatum*, a very handsome dark-flowered hybrid, raised by Mr. W. Smith, at Coombe Wood, in 1827. *P. carbásinum* (*carbasinus*, made of fine linen; appearance of petals), *Linen-flowered* Stork's bill. *P. divérgens*, *P. acutidentatum*. *P. plectophýllum*, *Plicate-leaved* Stork's-bill, a dark and splendid flower, from the collection of R. H. Jenkinson, Esq. *P. zingibérinum*, *Ginger-scented* Stork's-bill. *P. tortuòsum*. *P. acetabulòsum*, a splendid hybrid, raised from seed at the nursery of Mr. Dennis.

*The Botanic Garden*. By B. Maund, F.L.S. &c. In small 4to Numbers, monthly. Large paper, 1s. 6d.; small paper, 1s.

Nos. LI. to LIII. for March, April, and May, contain

201 to 204. — *Ænothèra Lindleyàna*, *Gilia capitata*, *Prímula Aurícula*, *Tritoma mèdia*, *Verbèna Aublètia*, *Biscutèlla hispida*, *Nolana paradòxa*, and *Petùnia nyctaginiflòra*, all very handsome border flowers. — *Tróllius europæus*, *Aconitum Napéllus*, *Vaccínium amœnum*, *Astrántia màjor*, all beautifully coloured.

We should like to see a similar work, one equally well got up and equally cheap, on fruits — a *British Fruit-Garden*: and why might not our native insects be so depicted; even our native birds and our minerals?

*The Florist's Guide and Cultivator's Directory*, &c. By Robert Sweet, F.L.S. &c. In 8vo Numbers, monthly. 3s. coloured; 2s. plain.

Nos. XXI., XXII., and XXIII., for March, April, and May, contain

81 to 84. — Duke of Clarence *Ranunculus*, Lord Hill *Tulip*, Rose *Daphne Tulip*, Howe's *Venus Auricula*, Lord Collingwood *Tulip*, Cara *Ranunculus*, *Aglaiia Tulip*, Strong's *Princess of Denmark Carnation*, George IV. *Tulip*, Carlos *Ranunculus*, Booth's *Freedom Auricula*, and the Grand *Monarque Tulip*.

*Medical Botany, &c.* By John Stephenson, M.D., and James Morss Churchill, Esq., Surgeon. In 8vo Numbers, monthly. 5s. 6d.

*No. XXVI. for February, contains*

104 to 106. — *Myristica moschata*, Aromatic, or *True*, Nutmeg Tree. The tree is compared by Rumphius to a common pear tree, with respect to size and appearance. It has, of late years, been cultivated at Batavia, Sumatra, and Pennang. (See Vol. III. p. 212., and *Encyc. of Plants*, art. *Myristica*.) — *Solidago virgaurea*. Astringent and tonic in a slight degree. Gerarde says, when it was brought from beyond sea, and sold at 2s. 6d. an ounce, it was believed to have great virtues; but afterwards, being found wild in Hampstead Wood, it was thought good for nothing, and no man would give half a crown for a hundred weight of it. — *Solidago odora*. "Mr. Pursh states that the plant is dried, in some parts of the United States, as an agreeable substitute for tea, and that it has for some time been an article for exportation to China, where it fetches a high price." We shall be particularly obliged to such gardeners as possess this plant, if they will dry a few of the leaves, make tea of them at least six evenings in succession, and about the same strength as they usually drink the common tea, and send us their opinion of the substitute. — *Matònia* (in honour of Dr. Maton, the learned physician and naturalist) *Cardamomum*, the *Alpinia Cardamomum* of Roxb. (*Encyc. of Plants*, p. 4., and *Lin. Trans.*, vol. x. p. 230.)

*No. XXVII. for March, contains*

100 to 108. — *Amòmum grana paradisi*, the fruit of which is well known under the name of Grains of Paradise, or Mellegetta Pepper. It is a native of Guinea, about Sierra Leone, whence the seeds have been long brought to Europe. "These seeds are much less aromatic and grateful than the lesser cardamomum seeds; and the taste is extremely hot and acrid, approaching, in this respect, to pepper, with which they agree also in their medicinal properties." — *Curcùma Zedoària*; *Scitamíneæ Cánneæ*. A perennial common in Ceylon and Malabar, with a tuberous, oblong, aromatic root, which is brought over in oblong pieces, about the size of the little finger, and is used as an aromatic and stomachic. — *Curcùma lóngá*; *Scitamíneæ*. The root is creeping, perennial, fleshy, palmate, and covered with a pale saffron-coloured bark. It is used in the East Indies as a sternutatory, and sent to England for the purpose of dyeing a yellow colour, and for its slightly stimulant and tonic qualities in medicine. "In Eastern countries, besides its use in colouring food, it is considered as cordial and stomachic, and is accounted one of the most effectual remedies in mesenteric obstructions, uterine disorders, and affections of the kidneys and urinary passages, and it is a constant ingredient in curries. It tinges the urine of a deep yellow, after being taken for a short time." — *Fucus vesiculòsus*, Bladder Fucus, or Bladder Wrack; *Algæ*. From this and other species found on the sea-coast of Scotland kelp is manufactured. Kelp is a very impure carbonate of soda, containing sulphate and muriate of soda, and also sulphuret of soda, with a portion of charcoal. The wrack (varec, *Fr.*) is collected and dried in July and August. A kiln or basin is formed by digging a round hole in the sand, and surrounding it with a few loose stones. "In the morning a fire is kindled in the pit, generally by means of peat or turf. This fire is generally fed with sea-weed, in such a state of dryness that it will merely burn. In the course of eight or ten hours the furnace is found to be nearly full of melted matter. Iron rakes are then drawn rapidly backward and forward through the mass in the furnace, in order to compact it, or bring it into an equal state of fusion. It is then allowed to cool, when it is broken in pieces, and carried into a store-house to remain till shipped." Soda is obtained from kelp and used by the soap manufacturers; and also iodine, considered by most chemists to be a simple body, and lately

successfully employed in the treatment of scrofula. "There seems to be no reason for doubting that this new remedy exerts a very marked influence over scrofulous and adventitious deposits. We have, therefore, numerous and well attested cases of its successful employment in an immense number of diseases, such as white-swelling, deafness, paralysis, distortion of the spine, &c. Professor Maunoir states that a child laboured under a considerable white-swelling of the knee, and could not walk without crutches. The usual mode of treatment proving unavailing, the tumour was rubbed night and morning with iodine ointment, while the tincture was given internally in small doses. After a few weeks a perfect cure took place. If iodine be taken in doses too large, or be not properly watched as to its effects, it is apt to produce inflammation of the stomach, attended by nausea, incessant vomiting, and general emaciation; while the testes and mammæ diminish in a remarkable manner."

— *Fucus helminthochortos*. The fronds of this fucus form a matted tuft (fig. 67. a, natural size); each frond, when magnified (b), shows small hemispherical bodies, which botanists have called capsules; and, being farther enlarged (c), the joints appear cartilaginous and irregular. It grows on calcareous rocks in the Mediterranean Sea, on the coast of Corsica: and although almost unknown among British practitioners, has long been sold on the Continent as a vermifuge, under the name of the Corsican Worm-Moss, or Coral-line of Corsica.

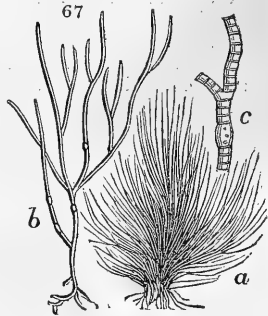

No. XXVIII. for April, contains

109 to 112. — *Aloe vulgaris*. Common in Jamaica and other West India islands, and the whole plant abounding in a clammy, bitter, yellowish, fetid juice like the *A. soccotrina*. Six different kinds of aloes are met with in commerce, supposed to be chiefly obtained from these two species. The real Soccotrine aloes are produced by the *A. soccotrina*, which grows in abundance in the Arabian island of Socotora. There "the inhabitants cut or chop the leaves, and make a slight pressure to obtain the juice, which is left to settle. It deposits a feculent matter, which is thrown away. The supernatant liquor, thus freed from its grosser parts, is left to spontaneous evaporation; and it is this difference in the two processes that accounts for the superiority of the real Socotrine aloes over that of the Cape: for there the Hottentots cut the end of the leaves, and catch the liquor which flows from them in proper vessels, the lower leaves of the plant generally serving for canals to conduct it into them. The juice thus obtained is at once reduced to a suitable consistence over the fire, and afterwards packed in boxes containing from one to 500 pounds." By analysis this matter is found to consist of resin 42, extractive 32, and the remainder albumen, or analogous matter. Medicinally, all the aloes are used as warm stimulating purgatives, particularly adapted for what is termed the melancholic temperament. The pills called Anderson's, Hooper's, Dixon's, Speediman's, James's, Lady Webster's, Fothergill's, Peter's, Radcliff's, the Dinner Pills, and the Beaume de Vie are composed chiefly of aloes. — *Allium sativum*, Cultivated Allium, or Garlic, which is considered diuretic, diaphoretic, and expectorant. It has also long been celebrated as a domestic remedy for worms. As antidotes to the flavour of garlic and other alliaceous vegetables, the leaves and seeds of the aromatic Umbelliferæ are recommended, and also baked beet-root. — *Styrax Benzoin*. A tree indigenous to Sumatra, in the northern parts of which it is extensively cultivated. Having attained the age of six or seven years, "incisions are made in the bark,

from which the balsam exudes in the form of a thick, whitish, resinous juice. By exposure to the air, this juice soon hardens; it is then pared from the bark with a knife or chisel. . . . The inferior sorts of benzoin are exported to Arabia, Persia, and some parts of India, where they are burned, to perfume, with their smoke, the temples and houses of the inhabitants; to expel troublesome insects, and obviate the pernicious effects of unwholesome air or noxious exhalations. . . . The greater part, which is brought to England, is re-exported to countries where the Roman Catholic and Mahometan religions prevail, to be there burned in the churches and temples." Benzoic acid is obtained by sublimation; that is, by putting a quantity of benzoin, coarsely powdered, into an earthen pot, covering the mouth of the pot with a cone of thick paper, and then applying a very moderate sand-heat. The particles of benzoin rise, or are sublimed, and are attached to the paper. In medicine this acid is little used, except for imparting a pleasant flavour. Court plaster consists of isinglass spread on thin black sarcenet, and brushed over with a weak solution of benzoin in spirits of wine to communicate an aromatic smell. Fumigating pastilles contain also more or less benzoin, as do the popular medicines, virgin's milk, friar's balsam, Wade's drops, jesuit's drops, pectoral balsam of honey, essence of coltsfoot, and Riga balsam.

*No. XXIX. for May, contains*

113. — *Triticum hybérnum*, Winter Wheat, supposed to have come originally from the hilly parts of Asia; under the equator it seldom forms an ear below the elevation of 4,500 feet, or ripens above that of 10,800, and will not vegetate beyond 62° north lat. Medicinally, bread is employed to form emollient poultices. — *Secàle cereàle*, Cereal, or cultivated, Rye. Apparently wild in North America. In France a disease, called the chronic or dry gangrene, has been produced by eating unsound rye, there called ergot. This disease has seldom been observed in England, but is endemic in some districts in France, in which rye forms the principal food of the inhabitants. It is also known in Switzerland, where it was observed that most animals refused to eat diseased rye, or rye affected with the cockspur, as it is called. The Royal Society of Medicine, at Paris, employed M. Tessier, a distinguished agricultural writer and man of science, to go into the countries where the dry gangrene prevailed, and collect a sufficient quantity of the ergot, or cockspur rye, for experiments. The result confirmed the opinion of those who attributed the disease to the cause assigned. "France afforded also a simple explanation of the fact, that persons might live for a considerable time upon rye affected with the cockspur, without suffering any sensible injury from its use; since, in all the animals upon which it was tried experimentally, a given quantity was required to produce the specific effect; and they suggested the only measure, that of separating the diseased from the sound rye, which could prevent so great a national calamity as that which has been so often produced by its use. The spurred rye occasionally occurs in this country, but there are no instances recorded of its producing any such effects as those enumerated above; but, in the *Philosophical Transactions*, Dr. Woolaston has narrated several cases in which dry gangrene was produced in one family, by partaking of damaged wheat, and nearly the same effects were produced in a family in Wiltshire, by the *Lòlium temuléntum* entering largely into the composition of bread. In an essay on the genus *Scleróticum*, by De Candolle, in the *Mémoires du Museum d'Histoire Naturelle*, the ergot is stated to be a parasitic production belonging to this genus; but however ingenious his investigations may be, their result is by no means satisfactory; and it is now generally concluded to be a diseased modification of the grain of the rye itself. Medicinally, it is used in uterine diseases.

*Hórdeum vulgàre*, Common Barley. Said to have been found wild in Sicily and Russia. Sweet wort was formerly used as an antiscorbutic. —

*Avèna sativa*, the Cultivated, or *Common*, Oat. Found by Anson growing wild upon the Island of Juan Fernandez. Medicinally, it forms gruel. — *Cochleària Armoràcea*. The scraped root is used as a warm pungent condiment to various kinds of animal food, and to give zest to winter salads. In the *materia medica* its effects resemble those of mustard seed; applied externally it inflames the skin and produces blisters, and an infusion of the root in milk is recommended by Dr. Withering as one of the safest and best cosmetics. — *Cochleària officinalis*; *Officinal*, or *Common*, Scurvy-Grass. This has long enjoyed the popular reputation of being one of the most powerful antiscorbutic plants. "Of equal virtue, however, with scurvy-grass is horseradish, mustard, the tops of turnips, watercress, lime-juice, oranges, and many other vegetables." — *Pyrus Cydonia*, the *Cydonian*, or *Common*, Quince, the seeds of which yield a transparent mucilage used in medicine. — *Tanacètum vulgàre*; *Common Tansy*. A tonic and stomachic, and a popular remedy against worms. The young leaves are sometimes shredded down to give flavour and colour to puddings, and Dr. Withering says, if dead animal matter be rubbed with them, the flesh-fly will not attack it.

*Flora Médica, &c.* In 8vo Numbers, monthly; to be completed in 28 Numbers. 2s. 6d.

*Nos. XVIII. and XIX. for April.*

Lest it should be thought that we are partial in noticing *Medical Botany*, and only occasionally mentioning *Flora Médica*, we think it right to introduce the following extract of a letter by Mr. Sweet, addressed to the Editor of the latter work, and printed by him as a testimonial of its botanical character:—

"I have inspected the drawings in the first three numbers of the *Flora Médica*; the delineations are beautiful specimens of the lithographic art, and *botanically correct*. As comprising perfect representations of the plants, the work must be highly valuable to the medical botanist, while its extreme low price renders it accessible to all."

*The Pomological Magazine.* In 8vo Numbers, monthly. 5s. coloured; 5s. 6d. plain.

*No. XVII. for March, contains*

65. *The Gilgil Pear.* A valuable winter fruit, though not of first-rate excellence.

66. *The Courtpendu Apple.* A capital variety, exceedingly like Fearn's Pippin, but nevertheless essentially distinct, being yellower in the flesh, higher-flavoured, and shrivelling like a nonpareil, a good bearer as an open standard, and the better fruit of the two. [The time it keeps not given.] "At a recent Meeting of the Horticultural Society, this formed the subject of part of a very interesting paper upon some late varieties of apples, by Mr. Robert Thompson, the under-gardener in the fruit-department of the Chiswick garden, — a young man of first-rate ability in his profession, to whose good sense and practical knowledge we are happy to take this opportunity of expressing our obligation, for assistance in the progress of the present work. Mr. Thompson spoke in high terms of the good qualities of the Courtpendu; and we are able completely to confirm his opinion."

67. *The Fearn's Pippin Apple.* An excellent variety, great bearer, remarkably handsome, keeps well till February or March, and less subject to be blown from the tree by high winds than most apples. Differs from the Courtpendu in having the deep red of its skin speckled with numerous yellowish dots, being more hardy, and in its flavour being less rich.

68. *The Violet Nectarine.* Excellent flavour and of great beauty; ripens from the end of August till the middle of September. Flowers small, bright red.

*No. XVIII. for April, contains*

69. *The Golden Reinette Apple.* Excellent, not to be confounded with the R. dorée of the French, nor with that of the Dutch, both of which are distinct, and equally deserving of cultivation. Bears unusually well in our climate, and its blossoms suffer less from spring frosts than those of many varieties. Ripens in the end of October, and keeps till the end of January.

70. *The Frizzled Filbert.* Of all the nut tribe the most deserving of cultivation; hardy, productive, beautiful when in the husk, and its flavour not materially different from that of the white filbert. Originated in a garden at Hoveton, near Norwich; named frizzled, from the appearance of the involucre or husk, and now common in the nurseries.

71. *The Princess of Orange Pear.* Raised by the Comte de Coloma, in 1802, of great beauty, good quality, and in perfection in October. It bears freely upon either a pear or a quince stock; and, blossoming late, is less exposed to spring frosts than many other kinds.

72. *The Seckle Pear.* "Found to exceed in excellence of flavour the very richest of our autumn pears, possessing a high vinous aroma, which can scarcely be compared with any thing in fruits, unless with a concentration of the taste peculiar to the Swan's Egg." Ripe from the end of August to the middle of October, but only keeps a few days. Sent by Dr. Hosack, of New York, to the Horticultural Society, in 1819.

*No. XIX. for May, contains*

73. *The Royal Peach.* Magnificent; ripening about the latter end of September, and by far the most valuable of our late varieties. There is no doubt whatever of the identity of the Royal, the Bourdine, the Téton de Venus, and the Late Admirable.

74. *The Grey Doyenné Pear.* Scarcely so good as the White Doyenné; but the grey will keep longer, and possessing also much excellence of flavour, may perhaps be considered the most useful. A great bearer, grafted on the quince, and very handsome.

75. *The Napoleon Pear.* Raised by Dr. van Mons, at Louvain, and thence sent to this country in 1816. Excellent, and universally admired. A profuse bearer upon an east or west wall, and succeeds also as a common standard. (Vol. I. p. 56.) Ripens in the middle of November, and remains in perfection several days.

76. *The Dutchess of Angoulême Pear.* Said to have been found wild in a hedge near Anvers: ripens in the end of November, and often attains a large size. "The very finest of the late autumn pears." An early and sure bearer, grafted on the quince, and trained against an east wall.

*Abercrombie's Every Man his own Gardener, &c. &c.* The Twenty-third Edition, with great Improvements, and the whole Art brought down to the Present State of Horticultural Knowledge. By James Main, A. L. S. London. 12mo. 7s. 6d.

Our correspondent and colaborer, Mr. Main, states, in an advertisement to this twenty-third edition, that his additions are "as much extended as the limited nature and approved plan of the work would admit," and that "every material improvement is introduced which is either useful or necessary in such a work." Mr. Main has introduced twenty-two methods of training trees, illustrated by figures; heating by hot water (p. 60.), an invention which, he says, was "first hinted at by Dr. James Anderson, in his *Agricultural Essays*;" some excellent observations on the culture of the pine-apple (p. 131 to 155.); on the sea-kale (p. 209.); on cauliflowers (p. 436.); on peas (p. 561.); and the catalogues at the end are remodelled, and the botanical names accented. In short, the book is made as complete as its nature, limits in size and price, and the present state of the art admit. If, on a more careful perusal, we find any thing not already given in

this Magazine, or in our *Encyclopædia*, we shall extract it for the benefit of our readers.

*Mean, James*, Head Gardener to Sir Abraham Hume, Bart. :

1. The Practical Gardener's Companion; or, Horticultural Calendar, containing the latest Improvements in Horticultural Practices. To which is annexed, on a Plan never before exhibited, the Garden Seed and Plant Estimate. Edited from an original MS. of J. Abercrombie, Author of the "Practical Gardener," and other works. London. 2s. 6d.
2. Abercrombie's Practical Gardener; or, Improved System of Modern Horticulture, adapted either to Large or Small Gardens; designed to assist those Gentlemen who manage their own Gardens. Third Edition, revised, with Additions and the latest Improvements. London. 12mo. 7s. 6d. boards.

*Stephens, George*, Drainer, Member of the Nerecian and Wermlandska Agricultural Societies in Sweden: The Practical Irrigator; being an Account of the Utility, Formation, and Management of Irrigated Meadows, with a particular Account of the Success of Irrigation in Scotland. To which is added, a Practical Treatise on straightening Water-courses, protecting River Banks, and embanking low Lands. Edinburgh. svo. 7s. 6d. boards.

The author here "lays before the reader the result of more than twenty years' experience in the practice of irrigation, &c., in England, Sweden, and Scotland," which he hopes "may prove the means of introducing" these practices more extensively into Scotland. He does not profess to have discovered any new principle, or any new application of principles already known; but "having been frequently applied to by those for whom he has had the honour of converting land into irrigated meadow, straightening water-courses, protecting river banks, and embanking low land, for a practical account of the different methods," &c. &c., "in compliance with these wishes he lays before the public the following practical essays."

We have looked over these essays, which are short, plain, and practical, and chiefly contain accounts of what has been done by the author in different parts of Scotland and in Sweden. It is gratifying to see confirmed the great utility of irrigation, in the mountainous districts of the Highlands of Scotland, and in the cold climate of Sweden. In fact it is clear, from the general experience on this subject, that wherever grass will grow, it may be made to grow more abundantly by a judicious irrigation, which, in the most unfavourable cases, at least adds heat in winter, and moisture in summer.

"In the year 1808 I was employed to survey, with regard to draining, a large tract of boggy land, belonging to Mrs. Grill, of Soderfors Iron Manufactory, in the province of Upland, in Sweden. After having taken a general view of upwards of 500 Scotch acres, I found about eighty lying nearest the large river Dal, coming from the province of Dalcarlia, well situated for irrigation; and although there was nothing of the kind in the country previously to that time, the proprietress, at the first suggestion, determined, whatever the expense might be, to have an irrigated meadow formed, complete in all its parts; for she was confident that draining in the first place, and afterwards irrigating for grass, would undoubtedly be one of the greatest improvements to a country where the summers are so generally very dry, and of course hay very scarce.

"The whole of this tract was reclaimed from the bed and overflowing of the above-mentioned river, by a very expensive embankment about sixty years before; but the drainage had been so badly executed, that what was not covered with water was a perfect bog, over which it was impossible for



a person to walk without sinking up to the knees; which made the whole crop on eighty acres only 1150 stone.

“Forty acres were formed into an irrigated meadow late in the spring of 1809, which injured the surface so much that the crop was the same as it had been previously to the formation.

“In 1810, the hay crop on forty acres was 4000 stone; within that year the other forty acres were formed into shape for water meadow, and in 1811, the hay crop on the whole was 11,250 stone; in 1812, the frost damaged the crop so much that the whole was only 4550; and in 1813, the crop was 11,250 stone; but had not the frost, on the 21st, 22d, and 23d of June, very much damaged the grass, the crop would have been one third more. The hay, since the commencement of the irrigation, is twice as good in quality, and I have not the least doubt, if the works are kept in proper repair, that the crops of hay and aftermath are double what they were at the time of the original publication of this account, in 1814, at Stockholm, in the *Annals of the Swedish Royal Academy of Agriculture*. The expense of forming this meadow, according to the value of our money, was 500*l.*, or nearly 4*l.* per acre.”

“About forty acres of the *Craigintinny lands, near Edinburgh*, were formed into catch-work water meadow before the year 1800; at which time they were let at from 20*l.* to 50*l.* per acre, per annum. In the spring of 1821, thirty acres of waste land, called the *Frigate Whins*, and ten acres of poor sandy soil were levelled and formed into irrigated meadow, at an expense of 1000*l.* The pasture of the *Frigate Whins* was let previously to this improvement for 40*l.* per annum, and the ten acres for 60*l.* They now bring from 15*l.* to 20*l.* per acre, per annum, but may be much improved by judiciously laying out 200*l.* more in better levelling that part next the sea, and carrying a larger supply of water to it, which might be easily done without prejudice to the other meadows. This, perhaps, is one of the most beneficial agricultural improvements ever undertaken; for the whole of the *Frigate Whins* is composed of nothing but sand, deposited from time to time by the action of the waves of the sea.”

*Hogg, James*, Author of the *Queen's Wake*, &c.: *The Shepherd's Calendar*. London. 2 vols. 12mo. Price 14*s.*

*Martin Doyle, M.*: Hints originally intended for the Small Farmers of the County of Wexford, but suited to the Circumstances of many Parts of Ireland. London. Pamphlet. 1*s.*

*Robinson, P. F.*, Architect, F.S.A.:

1. *Designs for Ornamental Villas*. London. 4to. 4*l.* 4*s.*
2. *Rural Architecture, consisting of Designs for Ornamental Cottages, Lodges, Dairies, &c.* 3*l.* 5*s.*
3. *Designs for Ornamental Farm-Buildings*. Parts I. to VI. 6*s.* each. To be completed in Twelve Parts.

The first two of these works have procured a very high reputation for the author as a picturesque designer. The object of the last is to improve the form of agricultural buildings, without affecting the convenience of the plan. “The designs already published [by others] enable the bailiff to erect the buildings in the most convenient form, and to place them exactly where they should be. Admitting this, it may seem strange that any thing more should be considered wanting; but it is the external form which I conceive may be improved upon, without affecting the plan; and it is the success which has attended my hints upon cottage architecture, which has induced me to turn my attention to this subject. With a strict regard to economy, therefore, and with a view simply to imagine forms which may be agreeable

to the eye, founded upon plans the usefulness of which has been already acknowledged, these designs are now offered to the public. They will be given in the old English style of architecture, in the Italian, the Swiss, and the Rustic, in order to make them generally useful; and as the chief merit, in compositions of this nature, arises from the simplicity of the shape, provided that shape be pleasing, all meretricious ornament will be carefully avoided. The work will commence with labourers' cottages of the humblest class, and the scale will gradually ascend. Each building attached to the farmyard will be given in its turn, with occasional designs for fences and rustic seats. The village school-house will find its place in the work, together with the alms-house, the turnpike-gate, the mill, and the parsonage."

Candour obliges us to state that the author has not been so successful in this work as in those which preceded it. The plans of his designs for labourers' cottages are liable to the same objections which we have made to those of Mr. Hunt (Vol. IV. p. 44.); and the elevations, in the greater number of instances, depend more on the picturesque effect given by the draughtsman and the engraver, than on architectural lines and forms. For instance, No. I. is a labourer's cottage, containing a kitchen, bedroom, wash-house, and porch, with no closets. The elevation shows a roof rendered picturesque by vegetation, not mere mosses and weather stains, but absolute bushes. No. II. is a labourer's cottage, also containing a kitchen, bedroom, and wash-house, without a closet, in which the two fire-places and the oven are in the outside walls; a bad plan, since it loses much of the heat that would otherwise be reserved in the masonry, and given out during the night. The object of placing the fire-places in the outside walls, is to make a more picturesque elevation; but we can hardly allow this to be legitimate. The architect ought to take a higher aim, and endeavour to combine the greatest degree of comfort and convenience to the poor cottager, with economy, both in the first erection of the building, and in its occupation afterwards, joined to a high degree of architectural character and picturesque effect.

No. III. is a labourer's cottage in the Italian style, with a kitchen, bedroom, and out-house, and with an oven. The elevation (fig. 68.), unaccompanied by the mountainous scenery given in the plate, we do not think

68

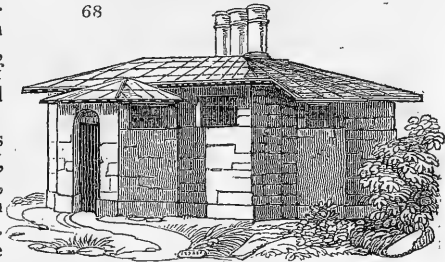

elegant; and certainly the windows are too small and too gloomy for the climate of England.

No. IV. is a cottage in the Swiss style, with the same accommodations, but with a far projecting roof (fig. 69.), which, in

69

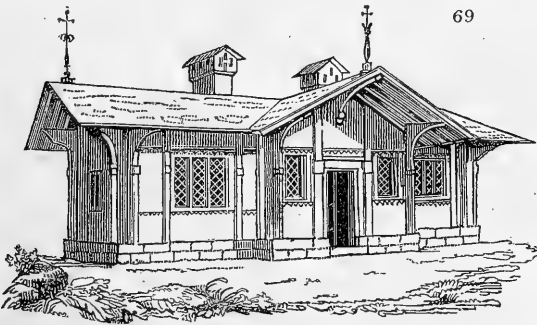

perspective. has a very excellent effect, and is quite characteristic.

No. V. is a barn in the Swiss style, the elevation of which, in perspective, is very handsome and very characteristic. (*fig. 70.*)

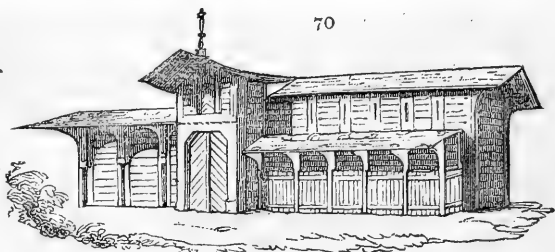

70

No. VI. is an English monastic barn, more like a drawing from a ruin than an elevation to work from; and not much can be said in favour of No. VII., a sort of Dutch barn with an Italian campanile at one end, the result of which is neither character nor effect.

No. VIII. a Swiss cow-house. Very poor.

No. IX. a circular granary; "the outline of which would remind the traveller of the temple of Venus in the kingdom of Naples, on the coast of Baia; the roof assuming the form of the temple of Vesta."

No. X. a rustic cow-house. Poor.

71

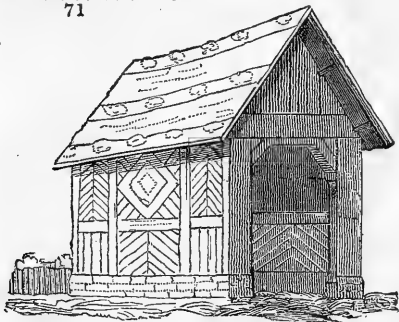

No. XI. Rustic cattle-shed (*fig. 71.*), we should think hardly worth publishing.

No. XII. a rustic seat.

No. XIII. The plan of a farmyard, such as is frequently to be met with in Northumberland and Berwickshire, but rarely in the south of England. The plan of the dwelling-house attached to it is objectionable from having the three fire-places of the ground-floor in the exterior walls. The barn, we think,

ought to have had a threshing machine; but the rest is good. Perspective elevations are given of the buildings in the old English, Swiss, and Italian styles, which are very picturesque as sketches; but we cannot recommend them as architectural designs.

No. XIV. Plan of a farm-house, without a pantry, dairy, or store-closet of any kind. Two elevations, however, in the old English style, are handsome and characteristic.

(*fig. 72.*) There is an elevation also in the Swiss style, and another in the Italian manner.

72

No. XXXIX. is a plate of fences; and No. XL. of rustic seats.

No. XVII. is a Swiss mill and bridge; in which we cannot but regret the bad taste which introduced a miserable line of six posts, leaning as many different ways, and joined by a crooked line of rails; as if it were the business of the architect to imitate vulgar and defective construction. This design is introduced by the following remarks:—"The mill has, at



all times, been a favourite subject with the landscape-painter, and, judiciously designed, may be made highly effective. Of this an admirable instance occurs at Guy's Cliff; and few visitors to that fascinating spot will forget the admirable taste of Mr. Greathead, who converted an old building of this description, at the head of the stream, into an object which, to all lovers of the picturesque, must be highly attractive. When beautiful effects are produced by the simplest means, the mind acknowledges the charm; and, at the spot alluded to, a mere gallery, roughly constructed, with an overhanging roof, has effected what the most laboured design would have failed to accomplish." If the mill at Guy's Cliff has such a fence in front of it as that exhibited in the engraving, we have no hesitation in saying it is disfigured by it, instead of being ornamented.

No. XVII. The old English mill. A very commonplace structure, and much more like a sketch from vulgar nature than an architectural design.

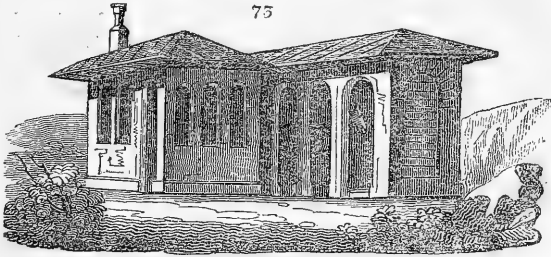

No. XVIII. The Italian smithy. (*fig. 73.*)

No. XVIII. [*bis*]. The old English smithy. Good.

No. XIX. The turnpike-gate house. (*fig. 74.*) Handsome, and quite a chateau. The plan has a porch living-room bed-room and kitchen, with a stair-case to an upper room. The end view (*fig. 75.*) is also very picturesque. A perspective view (*fig. 76.*) shows the turnpike-gate, in which much more attention has been paid to effect than to geometrical construction. What would Mr. Parker say, if an architect were to recommend to him such a design for a gate?

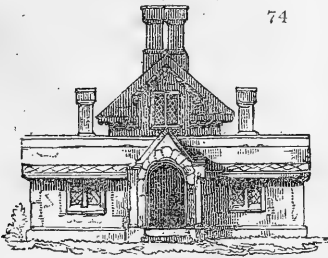

On the whole we regret the publication of this work, not only for the sake of its author, but because we know from experience that such designs have a tendency to create in the minds of country gentlemen and practical men an aversion from similar works; while we know also that it is only, or chiefly, by the more general diffusion of this class of publications, that the taste of country tradesmen and their employers is to be improved. As soon as we can find leisure, and if we can find, at the same time, that it is agreeable to our readers, we shall commence in this Magazine a series of designs for cottages for labourers, tradesmen, and small tenants of land, such as we think better calculated than

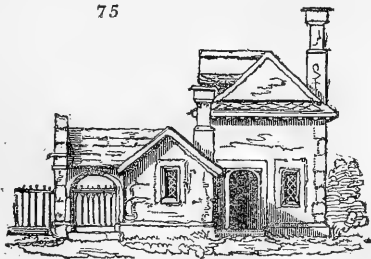

any we have yet seen, to promote the comfort of the occupiers, improve their habits, cultivate the taste of the architectural tradesmen of the country, and be ornaments to the general scenery. In

76

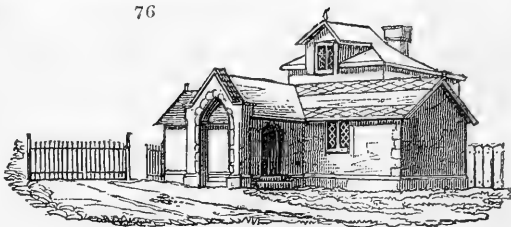

our next Number we shall give some account of a French work on cottage architecture, that of Morel Vindé, which affords one of the best examples we are acquainted with of that care in the composition of the plan, with reference to the wants of the inhabitants, in which we find our English architects so very deficient.

#### FRANCE.

*Soulange Bodin*, le Chevalier, Proprietor of Fromont, and an extensive Propagator of the more rare exotic Trees and Shrubs there, an active and enthusiastic Horticulturist, and a most amiable and agreeable man: *Annales de l'Institut Horticole de Fromont*. Paris. 8vo monthly. 1re Livr. April.

In the introduction the author informs us that he had hitherto limited himself to the collection and propagation of rare and beautiful plants; but that he now intends to combine at Fromont a practical school for the moral and professional education of gardeners. This school or institution, *L'Institut Horticole de Fromont*, will be opened on the 1st of May, 1829; and in the following spring the lectures to the students, *Candidats d'Horticulture*, will commence. These candidates, or pupils, will be examined from time to time, and receive prizes: and at the end of three years they will be dismissed, with a written character, both professional and moral. A short history, biography, and character of each candidate will also be published in the *Annales*, for future references either in favour of the individual, or to prove his degeneracy or improvement. The *Annales* will consist of three parts:—1. Professional studies; 2. News, foreign and domestic; and 3. Descriptions, culture, and uses of rare and new plants. The first article in the present number, after the introduction, is a description of the garden of Fromont, which we shall here pass over, as we intend to notice it from our own inspection in September last (Vol. II. p. 222.): the second is on the necessity of a statistical account of French horticulture, a labour which would certainly be of considerable use; since the first step to advancement is to know the precise position in which we stand. The Chevalier Masolet, we understand, has a similar project in view for the agriculture of France, and we heartily wish both of them, and the institution at Fromont, every success which their proprietors can desire.

*Péclet, E.*, ancien Elève de l'Ecole Normale, &c.: *Traité de la Chaleur, et de ses Applications aux Arts et aux Manufactures*. Paris. 2 vols. 8vo, avec atlas 4to.

“The first volume details, 1. the physical theory of heat; 2. the theory of combustion and combustibles; 3. the theory of the movements of heated air; 4. the theory of chimneys. The second volume contains the application of the above: 1. vaporisation; 2. distillation; 3. evaporation; 4. drying; 5. heating of elastic fluids; 6. heating of liquids; 7. heating of solid bodies; 8. cooling. The author has made very many and ingenious experiments, and, it is said, has discovered an error in the numerical values of certain algebraic terms hitherto employed by writers on heat.” (*For. Quar. Rev.*, April, 1829.)

## AMERICA.

*Legarre, J. D.*, Esq., Editor: The Southern Agriculturist, and Register of Rural Affairs; adapted to the Southern Section of the United States. Charleston. In 8vo Numbers, monthly. Vol. I., for 1828.

This work, which is on the general plan of similar journals, consists of a variety of original papers, reviews, and miscellaneous selections and notices. "Cotton, rice, Indian corn, and sweet potatoes have been for many years the chief objects of culture in the southern states; the first two as articles of commerce, the last two for food: yet it is very doubtful whether, among the planters generally, there has been much improvement in the method of cultivating any of these crops, if we except that of rice. The method pursued soon after their introduction has been followed but with little variation by each succeeding generation. This has been owing in part to the antipathy which farmers have against all (as they would term it) innovations, but more to the want of concert and union among them, and an ignorance of the discoveries which have been made by others interested in the same culture. The formation of agricultural societies will remedy the first, and a periodical journal will do much towards obviating the difficulties arising from the last."

A leading article through most of the numbers of the first volume is, An Essay on the Culture of the Grape Vine and the making of Wine, suited for the United States, and more particularly for the Southern States, by N. Herbermont, of Columbia, S. C., which we have no doubt will do much good. There are also several well written papers on the culture of cotton (the seeds of which, fermented and distilled, are said to form an excellent whisky), the olive, rice, and Indian corn. The Editor appears to have, as indeed he ought, access to all the standard European works and modern periodicals, and to make use of them with discriminating taste, and a judgment formed both on science and experience. In answer to his letter on this subject to us, we can only offer him our best wishes and thanks, and refer him, as to good agricultural books, to the catalogue department of this Magazine.

---

 ART. III. *Literary Notices.*

*LISTS of Flower Shows*, we are happy to be informed, will be published as heretofore by Mr. J. Winstanley, 25. Fountain Street, Manchester, who solicits the growers to send their lists to him as early as possible, and free of expense. — *March 1. 1829.*

*Flora Oxoniensis*; or, A Description of the Native Flowering Plants of Oxfordshire, according to the Linnean Classification, and the most approved Natural Orders: comprising an account of the economical uses of the plants described, their medicinal virtues, and peculiarities of structure, as bearing upon natural theology; with an Appendix, or Descriptive List of Additional Plants growing wild in the contiguous counties; preceded by an Introduction to Botany, illustrated by Plates, and serving as a Key to the Work, and to Botany in general. By the Rev. Richard Walker, B.D., Fellow of Magdalen College, Oxford, Fellow of the London Linnean, and Member of the Oxford Ashmolean Society.

The Work will be handsomely printed in one vol. 8vo. 12s.

## PART III.

## MISCELLANEOUS INTELLIGENCE.

ART. I. *General Notices.*

*INSECTS injurious in Horticulture.*—In the summer of 1826, when at Brussels, I observed that delicious vegetable of the cabbage tribe so largely cultivated there, under the name of *Jets de chour*, and which in England we call Brussels sprouts, to be materially injured in the later stages of its growth by the attacks of the turnip-flea, and other little beetles of the same genus (*Háltica*), which were so numerous and so universally prevalent, that I scarcely ever examined a full-grown plant from which a vast number might not have been collected. Some plants were almost black with them, the species most abundant being of a dark æneous tinge. They had not merely eroded the cuticle in various parts, so as to give the leaves a brown blistered appearance, but had also eaten them into large holes, at the margin of which I often saw them in the act of gnawing; and the stunted and unhealthy appearance of the plants, sufficiently indicated the injurious effect of this interruption of the proper office of the sap. What was particularly remarkable, considering the locomotive powers of these insects, was that the young turnips, sown in August after the wheat and rye, close to acres of Brussels sprouts (which all round Brussels are planted in the open fields among other crops) infested by myriads of these insects, were not more eaten by them than they usually are in England, and produced good average crops. It would seem, agreeably to the fact already mentioned (see *Introd. to Entomol.*, vol. i. 4th edit. p. 389.), that they prefer the taste of leaves to which they have been accustomed, to younger plants of the same natural family; and hence, perhaps, the previous sowing of a crop of cabbage plants in the corner of a field meant for turnips, might allure and keep there the great bulk of these insects present in the vicinity, until the turnips were out of danger. (*Kirby and Spence's Introd. to Entomology*, vol. i. p. 189. note c, 5th edit.)

*Hypogýmna dispar.*—These larvæ were so extremely numerous in 1826, on the limes of the Allée Verte at Brussels, that many of the trees of that noble avenue, though of great age, were nearly deprived of their leaves, and afforded little of the shade which the unusual heat of the summer so urgently required. The moths which in autumn proceeded from them, when in motion towards night, swarmed like bees, and subsequently on the trunk of every tree might be seen scores of females depositing their down-covered patch of eggs. In the park they were also very abundant; and it may be safely asserted that, if one half of the eggs deposited were to be hatched, in 1827 scarcely a leaf would remain in either of those favourite places of public resort. Happily, however, this calamity seems likely to be prevented. Of the vast number of patches of eggs which I saw on almost every tree in the park about the end of September, I could two months afterwards, to my no small surprise, discover scarcely one, though the singularity of the fact made me examine closely. For their disappearance, I have no doubt, the inhabitants of Brussels are indebted to the titmouse

(Pàrus), the tree-creeper (*Cérthia familiaris*), and other small birds known to derive part of their food from the eggs of insects, and which abound in the park, where they may be often seen running up and down the trunks of trees, at once providing their own food, and rendering a service to man, which all his powers would be inadequate completely to effect.

Reaumur (ii. 106.), in certain seasons, found these patches of eggs so numerous, that in the Bois de Boulogne there was scarcely an oak, the under side of the branches of which was not covered by them for an extent of 7 or 8 ft. He informs us that the eggs are not hatched till the following spring. (*Ibid.*, p. 208. note b.)

*Sugar from the Beet Root.* — In the *Farmer's Journal*, of March 30. is a letter on this subject from Mr. Phillip Taylor, an English gentleman at that time in Paris, and the inventor of a mode of boiling sugar by steam, for which he took out a patent in 1817. The fact that crystallised sugar could be obtained from the beet root was first noticed by Margraff in 1747, but excited little notice till 1790, when Achard, another German chemist, directed the men of science in France to that subject. A report by the Institute, about this time, states that raw sugar so produced costs about 8*d.* per English pound. In 1810, colonial sugar had become so dear, that the government directed their attention to the process, but, notwithstanding this, it was still so imperfect as to be given up, with the ruin of several manufacturers, when the peace of 1815 admitted the free entrance to France of colonial sugar. Important discoveries, among others that of Mr. Taylor for boiling sugar by steam, were made in the process, and the number of manufactories gradually increased, so that, at this time, 1829, there are at least one hundred, from which were produced last year 5000 tons of sugar, worth 60*l.* per ton, or 500,000*l.*, the profit of which Mr. Taylor estimates at 15*l.* an acre; but he adds, "I am convinced the process may be so far improved, that sugar will be made in France from the beet root at 36*l.* per ton, which will increase the profit to 24*l.* an acre." After showing that the beet root succeeds best in the northern departments of France, and that, of course, it can be grown as well in England as on the Continent, he concludes, that though the price of land and labour be much lower in France than in England, yet that the balance of skill in favour of the latter country places it on a par with France, in point of the profits to be obtained from making sugar from beet. He adds, "with respect to *prices of produce*, the advantage will probably be in favour of the English farmer; for although the price of sugar is about equal in both countries, yet it is not sugar alone that is produced from the beet root which is cultivated: the pulp of the root, after the juice is pressed out, is excellent food for both bullocks and sheep, and I have seen beasts which have been bought in at 5*l.* per head, fattened upon it and sent to market in three months, and sold for 11*l.* The value and importance of this part of the business will be duly estimated, when it is known that the pulp from each acre of beet root will fatten a bullock, and that the farmer will have as much manure for his other crops, as if he had grown turnips on the same land; and, of course, the same rotation of crops may be continued as is now found most beneficial. During the time of Bonaparte, the produce of sugar was about three per cent on the root; now, as much as five per cent is generally obtained; and as the beet root actually contains eight per cent, I think I have good ground for saying that the process admits of further improvement." A paper on the same subject, and to the same effect, will be found in the *Quarterly Journal of Agriculture* for May, in which the writer concludes "it is difficult to conceive that one half of the sugar consumed in Great Britain, or in all Europe, will not, in a few years, be home-made beet-root sugar."

Whether it may ultimately be worth while to cultivate the beet or other sugar plants on the Continent, or in the British isles, cannot at pre-



sent, we should suppose, be foreseen; but we consider it of very great consequence, with reference to the future happiness of nations, to see it proved beyond a doubt, that almost every country in the world could grow its own sugar if it were compelled by circumstances to do so. There could not be a better time than the present, for commencing the growth of the beet root and the manufacture of beet-root sugar in Ireland. The manufacture of potato flower as at Trappe, near Versailles, and other places near Paris, we should think, might be advantageously commenced there also. — *Cond.*

---

## ART. II. Foreign Notices.

### FRANCE.

*PARIS, April 21.* — The season has been quite as backward here as I remember it ever to have been in England; but the lime trees in the Thuilleries are getting green at last, and the *Alyssum saxatile* and the wallflower are in bloom in the borders. — *M—y. Place Vendôme.*

*The Process of boring for Water* has been practised with great effect in Paris. Two sheets of water have been ascertained to flow beneath the Paris basin; one between the chalk and the green sand, the other at a greater depth. From the last of these, the water is discharged at St. Ouen to the height of 10 or 12 ft., and the quantity 8656 gallons daily. The singular fact that wells are affected by the tide is confirmed by observation on those above mentioned. (*London Weekly Rev., April 4. 1829.*)

*Coal and Iron in France.* — All the coal-fields in the south of France are associated with iron-stone, or iron-stone is found close to them in abundance. France is, in fact, extremely rich in coal and iron. A little of British enterprise is alone wanting to render France most powerful in every thing relating to the production of coal and iron. There is one field alone that would be sufficient to supply all Europe with iron and all France with coal; it is at Creusot, near the eastern boundary. From this field, coal and iron can be transported by water to the shores of the Mediterranean and the German Ocean, and nearly through all France. (*Ibid. Feb. 25.*)

*Flax-breaking Machine.* — M. Ternaux, the celebrated French manufacturer, has obtained a patent for certain machinery for the purpose of depriving flax of its skin, without there being any necessity for resorting to the custom of previously soaking it. (*Le Globe.*)

*Six young Africans,* from the most distant parts of Ethiopia, are now receiving education in Paris. (*London Mag.*)

### GERMANY.

*Munich.* — The university here, in the third year of its existence, is extremely well attended. A degrading and injudicious constraint, with respect to the mode of study and subjects of discussion, had disgusted the youth of the present age with several of the ancient institutions for education in Germany; but from all such regulations, the present King of Bavaria, himself a literary man, has set the University of Munich entirely free. (*For. Rev., April, 1829.*)

*Education in Silesia.* — According to a statistical report of the schools in this district, published in the year 1827, there are 20 schools, 228 teachers, and 5694 pupils, all or chiefly of the lower classes. (*London Mag., April.*)

*Hungarian Gardeners' Song.* — "Oh, that I had a large garden, well stocked with fruit; a farm well stocked with cattle; and a young and beautiful wife!" (*Bucke's Beauties, of Nature.*)

## HOLLAND AND THE NETHERLANDS.

*Botanic Garden at Brussels.*—The new Botanic Garden at Brussels, which promises to be so great an ornament to that city, is advancing rapidly towards completion. The magnificent range of green and hot-houses is covered in and glazed, and in part occupied with plants, and the terraces into which the sloping site of the garden has been disposed, are already either partially planted or laid out for the reception of the trees and shrubs, &c., which are to ornament them. One striking feature of this botanic garden, and which few similar establishments can boast, is, that from the circumstance of its running parallel for upwards of one third of a mile with the new north boulevard, than which it is considerably lower, and separated from it throughout its whole length by a sunk wall, a complete view of the range of hot and green-houses (which occupy a commanding eminence), and of the whole garden (*fig. 77.*) is obtained

77

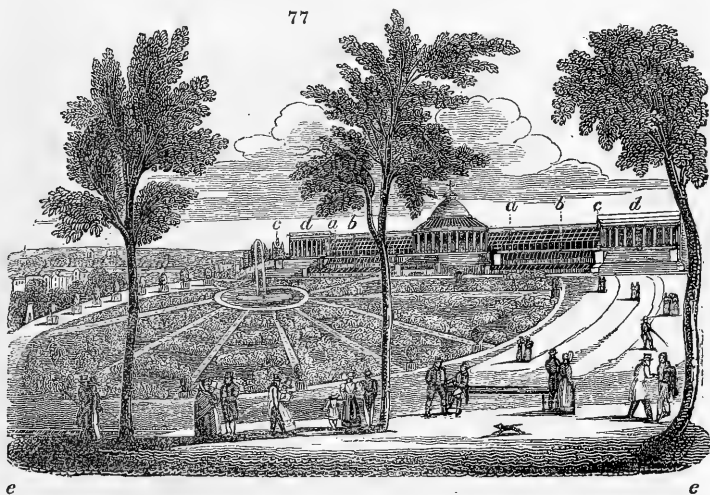

*a*, Low frames with curvilinear roofs.  
*b*, Low frames with straight sashes.  
*c*, Six fountains.

*d*, Flight of steps.  
*e e*, Boulevard.

without the trouble of entering it from, this boulevard, which forms part of a delightful promenade planted with four rows of trees, now nearly surrounding the whole city. (*Note of a Friend, April.*)

## AUSTRALIA.

*New Settlement on the Swan River*, on the north-west coast of New Holland.—Some account of this settlement will be found in all the newspapers for April, and in No. 78. of the *Quarterly Review*. Details, accompanied by criticisms, will be found in the *Farmer's Journal* for April 27. and May 4. and 11. A gardener, who has 200*l.* or upwards, and a healthy wife, would do well to consider the very favourable circumstances attending this settlement. A man acquainted with country matters, with 5000*l.*, by going out there with twenty paupers, and remaining seven or ten years, would, in all probability, increase his property twenty-fold, and might then return home with the consciousness of having done good to others as well as to himself, of having promoted civilisation and happiness generally.

Gardeners will recollect that Mr. Drummond, of Cork, our correspondent, and an active intelligent man, is gone before them. Mr. Drummond, in a year or two, will be made a justice of the peace; and, as things advance, will be promoted to other public offices. As for any thing that can be predicated of Australia, it may, in thirty years, with the consent of the parent country, become a cluster of states like the union of North America, Mr. Drummond, being young enough, may live to become a member of the Australian congress of 1860. — *Cond.*

---

ART. III. *Domestic Notices.*

ENGLAND.

*THE London University.* — On the 30th of April Professor Lindley delivered his introductory lecture on botany, in a clear, distinct, and audible voice, to a full class-room. After giving a short history of botany, and characterising the Linnean system as superficial, though well calculated for the times in which it appeared, and the Jussieuan system as profound and philosophical, and alone being worthy of being taught in the present state of science, he announced his intention of adopting that system as the foundation of his course of instructions. He had been told that he would not succeed in teaching botany by the Jussieuan system; but he asked how it happened that botany was so taught in Paris, and whether the French were not unquestionably the first botanists in Europe? In speaking of modern botanists, he assigned the highest place to Mr. Brown, and mentioned Mr. Knight as the first vegetable physiologist in Britain; and as an instance of the importance of physiology to horticulture, he referred (rather unfortunately in our opinion) to the success with which that gentleman had cultivated the pineapple. We cannot too much applaud Mr. Lindley for adopting the natural system, which we believe has already been done by Professor Henslow at Cambridge; it will mark an era in the history of botany in this country, and redound to the honour and advantage both of Mr. Lindley and of the London university. Even if the Linnean system cannot be done without, or, as most botanists think probable, will never be wholly dispensed with as an easy index for determining the names of individual species, still it is worthy of the ambition of a man of Mr. Lindley's learning, talents, and industry, to teach that system which is avowedly the most difficult; the Linnean being in truth so easy, that any one who has a book introductory to it, and leisure to walk in the fields, may learn it by himself. We have not a doubt of Mr. Lindley's complete success in every sense in which the word can be taken, and we desire it with all our hearts for his high spirit. Perhaps it may be considered fortunate for the university, that Dr. Hooker declined the professorship of botany, as we believe that gentleman still teaches by the old method at Glasgow, and of course would have adopted it in London. We are happy to observe the buildings of the university proceeding rapidly; to learn that most of the classes are well attended; and to hear that there is no want of subscribers for shares, and of donations to the library and museum. We have no doubt there will soon be two or more such universities in the metropolis, and at least one in Bristol, Liverpool, York, Hull, Birmingham, Manchester, Newcastle, and, in short, all the large towns in the kingdom; and the day, we trust, is not far distant when there will be a sort of minor university, a school in which all initiatory and general science and morals

will be taught, with a library, museum, and botanic garden attached, such as we have suggested in “*Des E'tablissemens pour l'E'ducation publique*” (p. 79.), in every parish in the empire. — *Cond.*

*Hyde Park.* — In consequence of the operations of Mr. Shedden on the surface of this park, with Finlayson's harrow (Vol. II. p. 250. fig. 66.) and with manure, to which we formerly alluded (Vol. III. p. 242.), it is now covered with a finer sward than it undoubtedly ever before exhibited either by nature or art. We regret that government does not think it worth while to introduce in this park, here and there among the existing trees, young specimens of the more hardy and noble North American sorts. Why should not five or six species of oak, and as many of birch, elm, lime, pine, &c., be introduced, as well as the *Plátanus*, which is a North American tree not a whit more hardy or more noble in appearance than fifty trees that might be named? We never look at this park and at Kensington Gardens without reverting in our mind to the little solicitude which the government of this country evinces respecting the public taste or the enjoyments of the mass of society. Permission, it seems, has been given to the proprietors of the very handsome large houses built on the Bishop of London's estate, lying along the Bayswater Road, and looking towards Hyde Park, to take down the park wall, and replace it by an open iron railing. This will prove a great enjoyment to these houses, and a great ornament to the public road; but a portion of the wall opposite certain smaller houses on ground belonging to the vestry of the parish of St. George's is left standing, thus at once insulting the poverty of the inhabitants of these houses, and disfiguring the road, which forms one of the finest entrances to London. Surely a government that can spare money for such a useless object as the bridge, and for such a deformity as the cascade in Hyde Park, and can spend nearly half a million on a palace, that in less than seven years will either be deserted or taken down from the insalubrity of its situation, independently of its architectural defects, might incur the expense of removing this wall for the sake of public ornament.

We regret to see the wall round Kensington Gardens undergoing repair, and cannot help repeating our opinion (Vol. I. p. 89. and p. 283.) that it would be much better, that is, it would be more ornamental to the metropolis, and leave Kensington Gardens equally secluded, to replace the wall by an iron railing, planting a border of evergreen shrubs within, which shrubs, for immediate effect, might, if it were thought desirable, be placed on a raised bank, such as may be seen executed in the garden belonging to the Adult Orphan Institution near the Coliseum, Regent's Park. If the Duke of Wellington will put these gardens under our management for ten years, and will allow us reasonable liberty and the same average sum that is at present expended on them, we will, without salary or pecuniary advantage of any kind, show what might be made of them even now. We have before shown what they might have been (Vol. I. p. 280.) by one grand and consistent plan. — *Cond.*

*Hyacinths in Pots.* — We have observed this season remarkably fine shows of hyacinths in the windows of some of the London seed-shops; among the finest, we think, were those of Noble and Co. (formerly Mason's), in Fleet Street. The roots are planted in autumn, and the pots, being plunged in the open air and covered 6 or 8 in. in depth with rotten tan, are taken out during spring as wanted, and placed under glass on a little heat. Those who have neither a garden, nor a hotbed, may effect the same object by setting the pots in any cellar or out-house, or in the corner of a yard, and there covering them with light soil or sand, and, as wanted, taking them out and setting them in a room as near as possible to the window. Messrs. Noble have had upwards of three hundred sorts in their windows at different times this season; at our request they furnished us with the following select list: —

## DOUBLE WHITE.

Aardshertoginne	-	-	-	Dark Red Eye.
Altesse Royale	-	-	-	Purple Eye.
Anna Maria	-	-	-	Purple Eye.
Cœur Noir	-	-	-	Black Eye.
Gloria Florum Suprema (excellent)	-	-	-	Large Red Eye.
Grande Monarque de France	-	-	-	Pink Eye.
Heroïne	-	-	-	Pure White.
La Mode E'puisée	-	-	-	Large, Dark Purple Eye.
Montesquieu	-	-	-	Red Eye.
Prince of Waterloo (excellent)	-	-	-	Large, pure White.
Reine de Prusse	-	-	-	Pink Eye.
Sphæra Mundi	-	-	-	Blue Eye.
Triumph Brandina	-	-	-	Blush White, Pink Eye.
Venus	-	-	-	Large, pure White.

## SINGLE WHITE.

Grand Vanqueur	-	-	-	Large, Single White.
La Candeur	-	-	-	Fine.
Prince de Galitzin	-	-	-	Fine, large.

## DOUBLE BLUE.

Bouquet Pourpre	-	-	-	Fine, rich-coloured, Dark Purple.
Commandant	-	-	-	Purple.
Comte de St. Priest	-	-	-	Porcelain Blue, Dark Eye.
Duc d'Angoulême	-	-	-	Porcelain Blue, Dark Eye.
Eendraght	-	-	-	Fine Azure Blue, Large Bell.
Globe Céleste	-	-	-	Fine Blue, very Dark Eye.
Kroon van Indian	-	-	-	Fine Dark Blue.
L'Abbe de Verac	-	-	-	Fine Porcelain Blue.
La Majesteuse	-	-	-	Fine Dark Blue.
Lord Wellington	-	-	-	Fine Blue, Dark Eye.
Monarque de France	-	-	-	Porcelain Blue, Dark Eye.
Mr. Pitt	-	-	-	Purple.
Noir Veritable	-	-	-	Very Dark.
Parel Boot	-	-	-	Porcelain Blue, Dark Eye.
Pasquin	-	-	-	Porcelain Blue, Dark Eye.
Sertorius	-	-	-	Fine Porcelain Blue, Green Eye.

## SINGLE BLUE.

Appius	-	-	-	Fine Dark Blue.
Crepuscelle	-	-	-	Fine Dark Blue.
Charles Fox	-	-	-	Fine Black.
Grand Vidette	-	-	-	Porcelain Blue, extra large.
La plus Noir	-	-	-	Fine Black.
L'Amie de Cœur	-	-	-	Fine Purple.
Lord Nelson	-	-	-	Fine Striped Blue.
Nimrod	-	-	-	Fine Dark Porcelain, large truss.
Vulcan	-	-	-	Dark Blue.
Quentin Durward	-	-	-	Black.

## DOUBLE RED.

Augustus Rex	-	-	-	Fine large Pink.
Comtesse de la Coste	-	-	-	Fine large Red, Dark Eye.
Duchesse de Parma	-	-	-	Large Deep Red Eye.
Flos Sanguineus	-	-	-	Fine Red.
Goud Beurs	-	-	-	Fine Blush, Purple Eye.
Groot Vorst	-	-	-	Fine Blush, Dark Eye.
Henri Quatre	-	-	-	Extra large Blush, Purple Eye.

L'Honneur d'Amsterdam	-	-	-	Extra large Blush.
Moore	-	-	-	Fine Red, Dark Eye.
Regina Rubrorum	-	-	-	Fine Pink.
Rouge Pourpre et Noir	-	-	-	Fine Red, Dark Eye.
Waterloo	-	-	-	Fine Red.
Velours Rouge	-	-	-	Fine Red, Striped Flower.

## SINGLE RED.

Cornelia	-	-	-	Fine large Striped Red.
Diana	-	-	-	Fine Pink.
Duke of Wellington	-	-	-	Fine large Pink.
Hirsitius	-	-	-	Extra fine Dark Red.
L'Eclair	-	-	-	Extra fine Blood Red.
Princess Elizabeth	-	-	-	Fine Dark Red.
Seedling	-	-	-	Fine Dark Red.
Victoire	-	-	-	Fine Dark Red.

*Acclimating Exotic Plants.* — I am one of those who have indulged in frequent attempts to acclimate exotic plants, encouraged by the prevailing mildness of the winters in this favoured corner of our island. From time to time the superfluous plants of the green-house have been introduced to the open ground; and, during several years, I have flattered myself that many of the choice plants of New Holland, South America, China, &c., which are justly classed among the chief ornaments of the conservatory, would prove hardy enough to endure our winters without protection. The intense frost of January and February last has greatly abridged these pleasing delusions. Allow me, nevertheless, to offer you a few remarks, the result of my own observation, on the effect of the severe weather on tender plants in the open ground.

*Acácia armata*, trained against a south wall, and also several standard plants, which have endured many winters, with slight protection, are all killed. The trained plant was in a high state of vigour when the frost commenced, and covered with myriads of embryo blossoms.

Two plants of another species of *Acácia*, which I have not been able to identify (the young plants having pinnate foliage, and afterwards entire leaves), which were planted in the open ground several years ago, and passed the previous winters without injury, are also killed.

*Laúrus Cámphora*, trained against a south wall, which has passed several winters with a slight protection of brush-wood, is killed. I felt so confident about this, that it remained uncovered, and apparently uninjured, till within a few days of the termination of the frost.

*Olea capénsis*, killed.

*Caméllia japónica* (the single red), protected by a basket, has suffered nothing.

*Aristotèlia Mácqui* has shed its leaves, but is now breaking strong, and is uninjured.

*Photinia glàbra*, several plants, partially protected, have suffered but little.

*Cratægus índica* is killed.

*Pittósporum coriáceum* is quite hardy.

*Magnólia grandiflora*, of which I have many plants of different growths and in various aspects, appears to be nearly as hardy as the common laurel.

*Metrosidèros speciósa*, a standard, unprotected, which during the autumnal months of last year was covered with its splendid flowers, is quite killed.

A large plant of *Agàve americàna*, covered with double matting, has passed the severe weather with little injury.

Several plants of African Aloes, though protected with great care, are killed.

The *Yuccas* are quite hardy; several of these, in exposed situations, have passed the winter without the slightest injury.

The *Myrtles* have suffered more than in any previous winter within my recollection. Many of the tender varieties are destroyed. — *N. Stoke, near Devonport, March 21. 1829.*

The *Achira* (which is undoubtedly different from *Cánna edulis*) flowered in Pontey's stove in November last, and perfected three seeds last month. The same plant is again about to flower, and the blossom will be expanded in about a week, when I shall have a drawing made of it. The general appearance of the plant does not differ (except in size, and its tuberous root, visible even above ground) from the *Cánna indica*. The *Cérbera Thevétia* flowered (for the first time, I believe, in England) in Pontey's stove last October. — *W. H. March 1. 1829.*

*Brunsvigia Josephinæ* has stood all the winter in an open border, without the least protection, at the nursery of Messrs. Whitley, Brames, and Milne, at Fulham, and not a leaf of it has been injured. It continued in full leaf all through the severe frost, although *Amarýllis Belladónna*, which was growing beside it, had all its leaves killed. — *Robert Sweet. May 2. 1829.*

The most effectual Method of destroying Wasps is to destroy their nests. When I see them attacking fruit, or entering the bee-hives, I mark the direction in which they fly away, and follow them out of the garden till I find their nest. I then mark it, return about ten o'clock at night with a spade and a pot of water, and work up the nest and its inhabitants into a puddle. — *T. C. Kensington, Sept. 12. 1828.* [See *T. N. Parker, p. 277.*]

Cast-iron Stakes for standard Roses have been employed by Mr. Campbell in the Comte de Vandés's garden at Bayswater. They are in the form of round tapering rods or poles, with the part which enters the ground of a larger diameter, 4-sided and pointed. The lengths are 4, 6, and 8 ft., and the average cost is 1s. 6d. each; they are painted of a blackish blue, and if they last six years will be as cheap as wooden props of young ash, which cost 4d. each and last only one year. But as the cast-iron will endure at least a dozen years, it is evidently much cheaper than the wood, and is certainly far handsomer. These poles are manufactured by Cottam and Hallen, Oxford-street, by the cwt. or ton.

*Alpine Plants and Seeds.* — *M. Schleicher*, the Swiss botanist and collector, is now in London with plants and seeds for sale or exchange. He laments in our gardens and nurseries, the neglect of scientific botanical collections, and the love of showy flowers, seminal varieties, and hybrids. Speaking of the botanic garden of Geneva he represents it as fallen to a very low state for want of funds; Professor Decandolle, he says, is so much occupied with municipal matters as to have little time to attend either to the garden or to authorship. *M. Schleicher* may be heard of at No. 9. Jermyn Street, or à Bex, canton de Vaud, en Suisse.

## SCOTLAND.

*Horticultural Report for April.* — In the different departments of horticulture the growth has advanced very little, from the ungenial state of the weather this month, and every thing is considered very late. As a criterion for the progress of vegetation during April, taken from a number of years' experience, asparagus was always cut in the open ground from the 7th to the 24th, but this season it was with some difficulty that a dish could be obtained on the 28th.

Notwithstanding the backwardness of the season, every variety of fruit has a favourable appearance, and not a single bud or flower seems to be hurt by the inclemency of the weather. Apricots have set well, and are a large crop. Peaches have hung very long in flower, but most of them are

now in the husk, and very promising. The finer sorts of pears on south aspects are in flower, and look well; as likewise early plums. The fruit trees on an inferior aspect, and standards, are still very backward; but the buds appear strong and healthy, and are free from insects and blights. Gooseberries and currants are in flower, and promise an abundant crop.

Culinary vegetables are now getting scarce, the winter stores being nearly exhausted. The spring supply is yet very scanty, and unless the weather take a very sudden and favourable turn, there will be a great deficiency for the kitchen before the end of May.

Little progress has been made this month in the forcing departments, from the long want of sunshine, accompanied by cold damps; this has been more particularly felt in the framing department adapted for pine-apples, melons, cucumbers, &c., where no fire heat could be applied. It has been truly teasing to the anxious horticulturist, who has laboured hard to little purpose; and these fruits are still hanging back, notwithstanding every exertion has been made to forward them. Pine-apples, grapes, peaches, &c., although less forward than might have been expected from their appearance last month, will swell to a good size and be a fair crop.

In the flower-garden the beds and borders exhibit a naked appearance, more like the beginning than the end of April; and it appears as if winter would linger in the lap of May. (*Caledonian Mercury*, May 4. 1829.)

We have to thank our unknown friend who sends occasionally the newspaper containing these reports, and he will much gratify a number of our readers if he will continue to do so regularly. We have sent a communication to the Editor, and a copy of our pamphlet on Education to the author of the maxims in the *Caledonian Mercury*, *Rochefoucault the younger*. These maxims have not been read without interest, and we hope they will be continued. — *Cond.*

*Vegetable Market.* — *April 17.* A number of booths are now tastefully decorated with a profusion of spring flowers. New potatoes are selling at from 2s. 6d. to 5s. a quart; an ordinary dish of sea-kale, 1s. 6d. Besides the common vegetables, there are rhubarb, cresses, cauliflowers, and broccoli. Some strawberries, completely ripe, were yesterday exposed in the shop of Boyd and Bayne, Prince's Street, for the first time this season. (*Scotsman*, April 18. 1829.)

*April 24.* Within these three weeks the prices of common kitchen vegetables have been fully doubled. There is, however, little alteration in the richer and rarer articles. Yesterday asparagus was offered at from 4s. to 5s. a hundred; sea-kale at 1s. 6d.; an ordinary dish of rhubarb, 2d.; radishes, 1½d. a bunch; and broccoli at 2d. to 4d. a head. (*Ibid.*, April 25. 1829.)

*May 2.* The effects of the unfavourable weather were this day very obvious. There were in all fifty-eight carts of vegetables, but instead of 8d. to 1s., a good number were "bulked" to the tacksman at 1d. each, and the remainder at from 3d. to 6d.; indeed, the whole supply could have been easily put into twenty carts. There was, of course, a material advance on the prices; not a single green blade of any description remained unpurchased at 8 o'clock, and a number of the retailers went away disappointed. The horticulturists were unanimous in their opinion that vegetation is at present three weeks later than usual.

*May 5.* The stock did not amount to one half of the limited supply of the 2d, and, though wet and stormy, the market was cleared before six o'clock in the morning. (*Ibid.*, May 6.)

*Caledonian Horticultural Society.* — In stating the proceedings of last Meeting of the Caledonian Horticultural Society (p. 215.), we had not room to take notice of the curious and interesting horticultural information contained in the minutes of meetings of committee and council held subsequently to the previous General Meeting of the Society, which, in the



ordinary course of business, were read to, and sanctioned by, the latter Meeting. We now supply that information.

At the Meeting of Committee, on the 15th of December last, specimens of a seedling apple were received from the Rev. H. Wastel of Newbrough, near Hexham, a plant of which had been sent to the Society's garden last year. The fruit was considered of excellent quality, and thanks voted to the reverend gentleman. Specimens of six different sorts of good apples, not generally known, sent by Mr. Archibald Reid, gardener at Balcarres in Fife, for competition on the 2d of December, but which arrived too late to compete, were found of good quality, and thanks voted to Mr. Reid.

The Secretary stated that although no competitor for the medal offered for "long service," had appeared on the day fixed by the schedule, yet one had since come forward. That person was Mr. John Cunningham, who had been forty-two years head-gardener at Riccarton, the fidelity and satisfactory nature of whose services were amply certified by Mr. Gibson Craig. The Committee recommended to the General Meeting to admit Mr Cunningham's claim to the medal for 1828; which was agreed to.

At the Meeting of Committee on the 8th of January, a collection of seeds from the Himalaya mountains was presented by John Govan, Esq. W.S. The seeds had been sent to that gentleman by his brother, Dr. Geo. Govan, botanist and geologist to the survey of those mountains. Thanks were voted to Mr. Govan, with a request that he would assure his brother, that the seeds had been received with gratitude, and would be carefully cultivated in the Society's garden. A card was read from John Robison, Esq., announcing a donation of arboreous and shrubby plants, twenty-five in number, several of which were rare, also fifteen varieties of grape vines, including the most esteemed *raisins de table*, by John Exshaw, Esq., of Bourdeaux. Thanks were voted to that gentleman for this handsome donation, and also to Mr. Robison for his uniform attention to the interests of the institution.

Upon the 8th of February, the arrival was announced of a rich collection of fruit trees and ornamental shrubs, and of seeds, from the Horticultural Society of London, for which handsome donation the cordial thanks of the Council were directed to be communicated to the London Society. — Some apples of crop 1827, in good preservation, although fifteen months off the tree, were exhibited by Mr. Geo. Watson, gardener at Tarvit, near Cupar, Fife. These apples were of the variety called the Kerry Pippin, and the mode of preserving them consisted in placing them apart from each other in flat-bottomed earthen jars, with air-tight covers, layers of fine dry sand being put between them, and the jars kept in a cool dry situation. — The Council examined Mr. R. Spittal's essay on the diseases of plants, with specimens of the diseased leaves and stems, and found it to be a communication evincing great research, and possessing much interest.

At the Meeting of the Council on the 8th of March, the Society's silver medal was recommended to be awarded to Mr. Alexander Smith, gardener at Cunnoquhie, for producing pine-apples and melons in pits, the bottom heat of which was derived from steam, introduced into a close chamber filled with pebbles, a mode of heating introduced by Mr. John Hay; and at the same Meeting the large medal, annually placed at the disposal of this Society by the Horticultural Society of London, was voted to Mr. John Hay, for his invention of this improved mode of heating.

The Society were put in possession, by Captain Smith of Dysart, of an interesting account of the effect of introducing buds of the Ganges apple into branches of the Russian transparent apple, by the ordinary process of inoculation; the Ganges apple produced from these buds having acquired the peculiar transparency which characterises the fruit of the stock; an effect, it will be observed, which goes to overturn the received opinion that the produce of the bud is in no respect affected by the qualities of the

stock. Thanks were voted to Captain Smith for this curious communication. (*Advertiser*, March.)

The *Ayrshire Green-house Lodge Society* held their competition for hyacinths, auriculas, &c., in the Turf-room Assembly-rooms, Kilmarnock, on the 18th of April, when the different competitors stood as under:—

*Flowers.* Double Red Hyacinth: 1. Bouquet Tendre, or Waterloo, Mr. John Brown, Kilmarnock; 2. Messrs. Dykes and Gentles, Kilmarnock; 3. Messrs. Fowlds and Lymburn, Kilmarnock. Double White Hyacinth: 1. Anna Maria, Mr. John Brown; 2. Messrs. Fowlds and Lymburn; 3. Messrs. Dykes and Gentles. Double Blue Hyacinth: 1. A-la-mode, Messrs. Dykes and Gentles; 2. Messrs. Fowlds and Lymburn; 3. Mr. John Brown. Yellow Hyacinths: 1. Ophir, Mr. John Brown; 2. Messrs. Fowlds and Lymburn; 3. Messrs. Dykes and Gentles. Single Red Hyacinths: 1. La Diana, Messrs. Fowlds and Lymburn; 2. Messrs. Dykes and Gentles; 3. Mr. John Brown. Single White Hyacinths: 1. Grand Vainquer, Mr. John Brown; 2. Messrs. Dykes and Gentles; 3. Messrs. Fowlds and Lymburn. Single Blue Hyacinths: 1. Vulcan (very fine), Mr. John Brown; 2. Messrs. Dykes and Gentles; 3. Messrs. Fowlds and Lymburn. Green-edged Auriculas: Stretch's Alexander, Harris's Blucher, &c., Mr. John Brown. White-edged Auriculas: Lee's Bright Venus, &c., Mr. John Morton, Kilmarnock. Grey-edged Auriculas: Butterworth's Lord Hood, &c., Mr. John Brown. Polyanthuses: 1. Mannin's Lady Anne Hamilton, Pearson's Alexander, and Cox's Prince Regent, Mr. John Brown; 2. Yorkshire Green, Grey Leadington, &c., Mr. Robert Purvis, Caprington. — *Fruit.* Best twelve preserved Apples, four sorts: Mr. Robert Purvis. — *Culinary Vegetables.* Parsneps: 1. Mr. Robert Rogers; 2. Mr. Robert Purvis. Sea-kale, Mr. Robert Purvis. — Of extra-articles, some very fine geraniums, carrots, leeks, radishes, &c., were presented by Mr. Robert Purvis, Caprington.

*Montrose Horticultural Society.* — The first Show for the season took place on April 29., William Mudie, Esq. Vice-President, in the chair. We had no conception that such a collection of flowers could have been got together at this season, particularly when the inclemency of the weather is taken into consideration. The auriculas were very fine, and of the very choicest sorts. The hyacinths were equally good, and plentiful. The polyanthuses were also very fine. The bouquets far exceeded those of last year; and the vegetables, though not very abundant, were excellent. The asparagus was considered particularly fine for the season. There was a profusion of uncommonly well-kept apples: those from Brotherton, though fewer in variety than what gained the premiums, were equally well kept. A few full-sized white currants, from Old Montrose, were exhibited as a curiosity. We were particularly struck with a plant of the *Nerium splendens*, from Mr. Walker's green-house, in full bloom: it is truly a splendid plant. The decorations attracted general attention. The office-bearers must have been very zealous in the cause before they could have produced such an effect. The judges awarded the prizes as follows:—

*Flowers.* Green-edged Auriculas: 1. Alexander Smith, Rosemount; 2. Mr. Beattie, Montrose. White-edged Auriculas: 1. Alexander Smith; 2. Mrs. Sim, Montrose. Grey-edged Auriculas: 1. Mr. Beattie; 2. Alexander Smith. Self Auricula, Mr. Beattie. Seedling Auricula, Alexander Smith. Polyanthuses: 1. Mr. Beattie; 2. A. Smith. Seedling Polyanthus, James Tough, Old Montrose. Double Hyacinths: 1. Mrs. Sim; 2. Mr. Sharp, Montrose. Single Hyacinths: 1. Mr. Sharp, Montrose; 2. Mr. Beattie. Double Wallflowers, James Tough. Dark-ground Pelargoniums: 1. and 2. James Tough. Light-ground Pelargoniums: 1. James Tough; 2. Mr. Sharp. Bouquet of Flowers from the green-house, Mr. Sharp. Bouquet of Flowers from the open border, Alexander Smith. — *Culinary Vegetables.* Broccoli: 1. James Tough; 2. John Begbie, Rossie. Sea-

kale: 1. Alexander Smith; 2. James Tough. Lettuce, Alexander Smith. Leeks, James Tough. Early Potatoes: 1. Alexander Smith; 2. Mr. Clark, Charleton. Early Cabbage: 1. J. Hardie, Brotherton; 2. James Tough. Asparagus: 1. James Tough; 2. Mr. Clark. Autumn-sown Carrots, Alexander Smith. Autumn-sown Onions, James Tough. Old Onions, Neil M'Donald, Newton Mill. — *Fruit*. Kept Apples: 1. James Tough; 2. Alexander Smith. Tart Rhubarb, from Old Montrose, was adjudged an extra-prize.

Judges: Messrs. Morson, Montrose; J. Dorward, Noranside; J. M'Donald, Dunningal; and A. Forbes, Ardovie. — We are glad to find that the Society is so decidedly meeting with the encouragement of the public. (*Montrose Review*, May 1. 1829.)

The *Aberdeenshire Horticultural Society* held a Meeting on the 10th of March for the election of office-bearers. Among the new members added was the Conductor of the Gardener's Magazine as a honorary member, for which he now returns his best thanks.

*Aberdeenshire Horticultural Society*. — A Spring Show of this Society took place on May 5th; and, notwithstanding the extreme backwardness of the season, it was remarked that the display of flowers, particularly the auriculas, polyanthuses, hyacinths, &c., had never been exceeded; in early vegetables the productions were numerous, and most of them in very high perfection. After carefully examining the different articles, the Judges awarded the premiums as under: —

*Flowers*. Stage Auriculas, David Gairns, gardener, Glenbervie House. Seedling Auriculas: 1. The large silver medal, David Gairns; 2. Joseph Riddoch, Banchory Lodge. Polyanthuses, Captain John Clyne, Gilcomston. Seedling Polyanthuses: 1. James Ferrar, gardener, Gilcomston; 2. Mr. J. I. Massie. Hyacinths, Captain John Anderson, Skene Square. — *Culinary Vegetables*. Mushrooms, William Gallow, gardener, Scotstown. Asparagus: 1. James Alexander, gardener, Murtle; 2. William Gallow, gardener, Scotstown. Broccoli: 1. David Taylor, gardener, Belmont; 2. William Lawson, gardener, Devanha. Sea-kale: 1. Peter Archibald, gardener, Park; 2. George Cardo, gardener, Woodhill. Cucumbers: John Davidson, gardener, Dunnottar. — *Fruit*. Apples: 1. William Chalmers, gardener, Lochhead; 2. Alexander Brown, gardener, Heathcot. To David Young, Esq., Cornhill, for the best Scotch champagne, made from unripe gooseberries, which the Judges declared to be the finest that had hitherto been produced before the Society, the silver medal. An extra-premium was also awarded to David Taylor, Belmont, for a basket of very fine rhubarb. Among the flowers exhibited to deck the tables there was a plant in full bloom of the *Blëtia Tankervillæ*, from the garden of D. Young, Esq., of Cornhill; and another of the *Alëtis capënsis*, from the garden of Mr. Roy, nurseryman; both of which were much admired. A number of articles were received too late to be admitted for competition, particularly some black currant wine, from Mrs. Crombie of Phesdo, and some from Mr. Thomas Burnett, advocate, the quality of which was ascertained to be peculiarly rich and high-flavoured. (*Aberdeen Chronicle*, May 9.)

*Raising the Scotch Pine and Larch from foreign Seeds*. — The Highland Society have offered handsome premiums for the following objects: —

To the nurseryman or other person in Scotland, who shall, between the 30th of October, 1826, and 30th of October, 1829, have raised on rather poor nursery-ground, and sold for planting, the greatest number of plants, not being fewer than three millions, of the *Pinus sylvéstris*, from seed imported from Norway, and taken off healthy trees in that country, or taken off healthy and free-growing trees of the natural-grown pine in the Highland districts of the counties of Aberdeen, Moray, and Inverness, — twenty sovereigns, or a piece of plate of that value.

To the nurseryman or other person in Scotland, who shall, between the 30th of October, 1826, and 30th of October, 1829, have raised, and sold for planting, the greatest number of plants, not being fewer than one million, of the *Pinus Larix*, or larch fir, from seeds imported from the Tyrol, or other regions of the Alps to which it is indigenous, and taken off healthy trees in that country, — thirty sovereigns, or a piece of plate of that value. (*Scotsman*, March 4. 1829.)

*Practical Schools of Agriculture.* — We observe, in the *Farmer's Journal* (May 4.), an advertisement from a farmer in Strathmore, for young gentlemen as apprentices in farming; and another from our much-valued friend and scientific correspondent, Mr. Shirreff of Mungos-wells, near Haddington, for a few young gentlemen as boarders, to whom he will impart the scientific principles, as well as practice, of East Lothian farming. Few English proprietors are aware of the good they might do their families by sending such of their sons as are destined to possess land to study the agriculture of the northern counties, and especially of East Lothian. It is difficult to give credit to the fact, that there is such a superiority in the practice of an art, every where followed, within such a short distance; but such is still the fact, notwithstanding all the endeavours by societies, premiums, books, and northern bailiffs, to diffuse a knowledge of Scottish agriculture in the centre and south of England. How wonderfully a proprietor in Normandy, and, still more, one in the neighbourhood of Saverne and Metz, where clover is scarcely known, and the soil as good as between Dunbar and Haddington, would profit by adopting the East Lothian husbandry! — *Contd.*

*Crinum amabile and Nepenthes distillatòria.* — Sir, There is at present in full flower, in the stove of Professor Dunbar of Rose Park, a beautiful plant of the *Crinum amabile*. The same plant has now flowered with the Professor either five or six times, last year three times. I am not sure whether it has flowered oftener than once or twice in England, and certainly never has it flowered so continually as now in Mr. Dunbar's stove. The flowers are of the most beautiful description, consisting of a number of florets, which succeed one another; so that when one dies, another comes out. These florets are supported on a long, thick, fleshy, round, smooth stem, which shoots up from the body of the plant with amazing rapidity.

Professor Dunbar had also very lately, in the same stove, the *Nepenthes distillatòria* in full blow, the flowers of which were female; and as it fortunately happened that there was in the botanic garden, at the same time, a similar plant in flower, whose flowers were male, impregnation was effected, and the result has been a large supply of seeds, which the Professor and Mr. Macnab have already sown. If I am not mistaken, this is the first time impregnation between these plants has been performed in this country. I am, Sir, &c. — *W. D. March 19. 1829.*

*Retarding Gooseberries.* — A gentleman who has a garden in a high and rather late part of this district, sowed a crop of a tall kind of pea immediately bordering on some gooseberry bushes. From deficiency in the length of the stakes, the peas, after they had attained a certain height, fell over and completely covered one gooseberry bush, which was thus buried and lost sight of at the time the fruit of the others was ripe. The haulm of the peas was not removed till the beginning of December, when the gooseberries were discovered hanging on the bush in the greatest perfection. Perhaps this is too inartificial a method to be recommended to be followed, but it may afford a hint for improvement in the mode of prolonging the season of this excellent and popular fruit. — *John Ferme, Haddington, Sept. 23. 1828.*

*The Gaelic Schools in the Highlands and Islands of Scotland* amount to eighty, and are attended by five thousand scholars. Many of the scholars are grown up persons, and not a few are advanced in life; but, notwithstanding this, many of them have acquired the art of reading with fluency in three months. When the Gaelic School Society commenced its labours, there were not fewer than 150,000 persons capable of instruction yet unable to read in any language whatever. (*Evan. Mag.*, March, 1829.)

*Venerable Orange Tree.*—Your extract from the *Journal of the Bristol Nursery Library Society*, under the above head, in *Gard. Mag.*, No. XIV., has been copied into it from the *Journal of the Tour of a Deputation of the Caledonian Horticultural Society through France, &c.*, where you will find a more full account of it, p.411.—*John Ferme. Haddington, Sept. 23. 1828.*

#### IRELAND.

*Counsellor West's Curvilinear Iron Sash-bar Hot-house*, lately erected in the neighbourhood of Dublin, is, perhaps, the most beautiful thing of the sort in the united kingdom. I am surprised that your correspondent Mr. Fraser has not sent you some account of it. The hot-water system of heating is making rapid progress in this country, and succeeds perfectly. Messrs. Bailey of London, who put up Mr. West's hot-house, I believe, were the first to introduce it in Ireland.—*J. H. Feb. 16.*

*Draining Bogs.*—A very interesting work of this kind is likely to be soon undertaken. There is a chain of three lakes in Galway, very near one another, Lough Corrib, Lough Mask, and Lough Corra. By cutting a gallery 3,000 feet ( $1\frac{3}{4}$  miles) long, through a limestone rock between the first and second of these lakes, an interior navigation of 30 miles can be opened up, and 16,500 acres of land, now all under water, will be drained. The costs of the gallery are estimated at 50,000*l.*, and the value of the land to be gained at 350,000*l.* (*Scotsman.*)

*Education.*—At the Anniversary Meeting of the London Hibernian Society, April 25., it appeared that, during the past year, "the schools have increased from 1,046 to 1,552; and the scholars now enrolled, to 76,444. These schools are distributed in the four provinces, but chiefly in Connaught. (*Times*, May 5.)

---

#### ART. IV. *The London Nurseries.*

*MR. KNIGHT'S Exotic Nursery, King's Road, April 21.*—Two varieties of *Rhododéndron arbóreum* have lately been in flower here in the large curvilinear conservatory, also several species of *Acácia*, and some new seedling camellias, raised by Mr. Knight. The jet of water in the large cast-iron vase (*fig. 78.*), placed in the middle of this conservatory, produces a very brilliant effect; and, by keeping the air moist, promotes the health of the plants, and the diffusion of their different perfumes. It is worthy of remark, that not a single pane of glass in this iron house has been broken since its erection four years ago (*Vol. I. p. 249.*), and that during the last winter, when

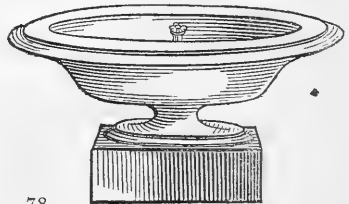

78

the thermometer in the open air was as low as 25°, no fires were made. The earth in the *Caméllia* pots was frozen, but no damage ensued. The sides of this structure being chiefly of masonry, and the glass roof being very lofty, account for the quantity of heat retained. Mr. Knight is building a new orangery, to be heated by hot-water on an improved plan, of which we hope soon to give some account.

*Colville's Nursery, King's Road, April 21.* — The show of forced flowers and shrubs here is most splendid. A number of varieties of Bengal roses and azaleas seem eligible shrubs for forcing. The brilliancy of the poppy anemones, in pots, shows what may be done even in cheap articles; and we cannot but regret that there is not a large public conservatory in London, in the way of market, for exposing such articles for sale, that every shop-keeper might place some of them in his windows, and every householder on his balconies or window sills. The air of London would thus be rendered like that of a flower-garden, which it sometimes is, even now, in the streets about the west end of the town, from the abundance of mignonette. We have suggested the idea of forming such conservatory markets for plants in pots, both in what are now the churchyards, and in Covent Garden market; but the time is not yet come for carrying all our ideas into effect. In Mr. Colville's conservatory are large specimens of *Hôtea Célsii*, covered with their fine blue pea-flowers; and *Wistaria Consequana* is going out of flower there, and coming into flower against the end of a green-house. Every one, therefore, that wishes to have the full enjoyment of this charming twining shrub, ought to have three sets of plants; one set for forcing, one for the green-house, and one for the open air. In the hot-house, *Calathèa veratrifolia* and other *Orchidéæ* are beautifully in flower; and an artificial tree, formed of the shells of cocoa nuts and moss, is covered with a great many specimens of this curious family, in vigorous growth, of which there is one species or another in flower every day in the year.

*The Fulham Nursery, May 11.* — *Thermopsis laburnifolia*, which at a distance looks like a laburnum on a large scale, is here both in flower and leaf in the open air; it is worthy of a place against every wall of half-hardy shrubs. A most complete collection of azaleas, planted a few years ago, are now in a vigorous state. *Lagerstrœmia indica*, *Acacia Julibrissin*, and similar trees, have stood the last severe winter, as they have done upwards of a dozen winters before; and we have elsewhere noticed, on the authority of Mr. Sweet, that *Brunsvigia Josephinæ* has stood the winter in the open border in front of the hot-house, without losing its leaves. There can be no doubt that many exotic plants, if treated the season before so as to produce the perfect ripening of their wood, buds, or bulbs, would stand the winter better than even indigenous articles that have been caught in a growing state by the frost. In this nursery there are some fine specimens of cork tree, nettle trees, purple beech, *Ailántus glandulosa*, and Fulham oak, *Quercus Cérris* var. *dentata* of Sweet's *Hortus Britannicus*. This last tree is of an immense size, and shows that forest trees may be grafted to advantage in cases where the seeds are with difficulty obtained.

*Malcolm's Nursery, Kensington, April 25.* — *Magnolia conspicua* is here nearly as finely in flower as when we described and figured it in April 1826. (Vol. I. p. 154. and Vol. II. p. 570.) Mr. Malcolm has imported a very complete collection of azaleas from the Netherlands, mules raised there from seed. *Gualthèria procumbens* is here profusely covered with purple red berries, which, it was observed by Mr. Malcolm, the birds do not eat even in the most severe seasons.

*The Mary-la-bonne Nursery, April 20.* — The botanic garden here, as we formerly noticed, is let for building on, and Mr. Jenkins has, in consequence, concentrated his energies. He has lately erected ranges of glass,

upwards of 500 ft. in length, and heated a great part of them with hot water, from his own plan, and with no other assistant than his own carpenter and smith. Having fallen into the common error of fixing an insufficient number of pipes for meeting the demands of very severe weather, to remedy the error (which he is not the only nurseryman who has committed) he has placed a small steam boiler by the side of his water boiler, and conducted steam pipes from it in the centre of his water pipes. These steam pipes are not quite an inch in diameter, but they are effectual in heating the water at a distance of nearly 200 ft. from the boiler, and we have little doubt they would effect the same object upwards of 500 ft. distant. The pipe, if we are not mistaken, returns to the boiler, into which the condensed water is pushed forwards by the steam. By this arrangement the smallest possible quantity of water and steam is lost; only care must be taken, by air or water valves, to provide against a vacuum. We do not, however, recommend this plan for imitation, as we consider it too intricate, but to show how errors may be corrected, or difficulties overcome, by an ingenious persevering man.

*Epsom Nursery, May 19.* — New or rare plants which have flowered during the months of March and April: —

*Ranunculus (C. Bauh.) frigidus Willd.*

*Magnolia (L.) Soulangeana Sweet's Brit. Fl. Gard. 260.*

*A'rabis (L.) rosea Dec., arenosa Scop.*

*Iberis (L.) Lagascana Dec.*

*Sterigma tomentosum Dec., B. F. G. 278.*

*Moricandia arvensis Dec.*

*Schizopetalum Walkeri Sims, Bot. Mag. 2379.*

*Viola (Tourn.) palmata L. v. bicolor variegata Fisch., pubescens Ait. Brit. Fl. G. 225.*

*Oxalis (L.) Déppii Link and Otto.*

*Hovea (R. Br.) purpurea Sweet's Fl. Aust. 15.*

*Kennedyia coccinea Vent. Swt's. Fl. Aust. 25.*

*Lupinus (Tourn.) canaliculatus Sweet's B. F. G. 285.*

*Claytonia (L.) grandiflora Sweet's B. F. G. 216. v. pallida, caroliniana Mich. B. F. G. 208.*

*Ribes (L.) sanguineum.*

*Panax trifolium L. Bot. Mag. 1334.*

*Borkhausia (Böhm.) purpurea Spreng.*

*Andromeda (L.) buxifolia Lam. Bot. Mag. 2660.*

*Rhododendron (L.) arboreum Sm. v. roseum, phœniceum, Smithianum, sinense Sweet.*

*Polemonium (L.) Richardsoni Graham, Bot. Mag. 2800.*

*Witheringia (Herit.) montana Dun.*

*Pedicularis canadensis L. B. F. G. 37.*

*Calceolaria (L.) thyrsoflora Graham, purpurea Graham., connata Hook. Bot. Mag. 2876.*

*Verbena (L.) Melindris Gillies, Bot. Reg. 1184., pulchella Sweet's B. F. G. 295.*

*Cyclamen (L.) repandum Sib. and Sm. B. F. G. 117.*

*Narcissus (L.) albus Haw. Bot. Mag. 1500., Macleanii Lindl. Bot. Mag. 2588., sexlobatus Haw., montanus Ker, Bot. Reg. 125., pulchellus Haw.*

*A'cis (Salisb. and Sweet) trichophylla Sweet in Obs. B. F. G. 297., grandiflora Sweet in Obs. B. F. G. 292.*

*Trillium sessile L. Bot. Mag. 40. cernuum L. Bot. Mag. 954.*

*Scilla (L.) pumila Brot. — Alpha.*

## ART. V. Covent Garden Market.

## PRICES FOR THE FIRST AND SECOND WEEKS OF MAY.

	From			To			From			To		
	£	s.	d.	£	s.	d.	£	s.	d.	£	s.	d.
<i>The Cabbage Tribe.</i>												
Cabbage, White, per dozen	0	0	9	0	1	3						
Cabbage Plants, or Coleworts, per dozen	0	1	6	0	2	0						
Cauliflowers, per dozen	0	6	0	0	9	0						
Broccoli, White, per bunch	0	1	6	0	2	6						
Broccoli, Purple, per bunch	0	1	0	0	2	0						
<i>Legumes.</i>												
Peas (forced), per pottle	0	9	0	0	10	0						
Kidneybeans (forced), p. hd.	0	2	6	0	4	0						
<i>Tubers and Roots.</i>												
Potatoes, -		6	0	0	8	0						
{ per ton		6	0	0	8	0						
{ per cwt.		0	6	0	0	8						
{ per bush.		0	3	0	0	4						
Potatoes, Kidney, per bush.		0	4	0	0	5						
Potatoes, Scotch, per bushel		0	3	0	0	4						
Potatoes, New, per pound		0	2	0	0	3						
Turnips, White, (new) per bunch		0	1	6	0	4						
Carrots, Old, per bunch		0	0	4	0	0						
Carrots, Horn, per bunch		0	1	6	0	2						
Red Beet, per dozen		0	1	0	0	1						
Horseradish, per bundle		0	2	0	0	4						
Radishes, Red, per dozen hands (24 to 30 each)		0	0	8	0	0						
Radishes, Red, per bunch		0	0	1	0	0						
White Turnip, per bunch		0	0	1	0	0						
<i>The Spinach Tribe.</i>												
Spinach, { per sieve		0	0	8	0	0						
{ per half sieve		0	0	4	0	0						
Sorrel, per half sieve		0	0	0	0	1						
<i>The Onion Tribe.</i>												
Onions, Old, per bushel		0	12	0	0	18						
Chives, per dozen roots		0	2	0	0	0						
Garlic, per pound		0	1	0	0	0						
Shallots, per pound		0	0	0	0	1						
<i>Asparaginous Plants, Salads, &amp;c.</i>												
Asparagus, per hundred		0	2	6	0	7						
Lettuce, Coss, per score		0	1	0	0	3						
Lettuce, Cabbage, per score		0	0	4	0	0						
Succory, per bunch		0	0	2	0	0						
Small Salads, per punnet		0	0	3	0	0						
Watercress, per dozen small bunches		0	0	6	0	0						
Burnet, per bunch,		0	0	2	0	0						
<i>Pot and Sweet Herbs.</i>												
Parsley, per half sieve	0	1	0	0	1	6						
Tarragon, p. doz. bunches	0	4	0	0	0	0						
Purslain, per punnet	0	0	6	0	0	9						
Fennel, per dozen bunches	0	1	6	0	2	0						
Thyme, per dozen bunches	0	2	0	0	0	0						
Sage, per dozen bunches	0	2	0	0	0	0						
Mint, per dozen bunches	0	2	0	0	0	0						
Marjoram (forced), per doz. bunches	0	8	0	0	10	0						
Savory, per dozen bunches	0	2	6	0	0	0						
Basil (forced), per doz. bun.	0	8	0	0	10	0						
Rosemary, per doz. bunches	0	3	0	0	0	0						
Tansy, per dozen bunches	0	2	0	0	0	0						
<i>Stalks and Fruits for Tarts, Pickling, &amp;c.</i>												
Rhubarb Stalks, per bundle	0	0	6	0	1	6						
<i>Edible Fungi and Fuci.</i>												
Mushrooms, per pottle	0	1	0	0	1	3						
Dried Morels, per punnet	0	3	0	0	0	0						
English Morels	0	0	0	0	14	0						
Dried Truffles, Foreign, per pound	0	14	0	0	0	0						
<i>Fruits.</i>												
Apples, Nonpareils, per bus.	2	0	0	2	10	0						
Reinette Grise	1	0	0	1	10	0						
White Rennets	0	12	0	0	16	0						
French Crabs	0	12	0	0	14	0						
Peaches, per dozen	0	0	0	3	0	0						
Apricots, Green, per pottle	0	2	6	0	4	0						
Cherries, per pound	1	0	0	1	5	0						
Gooseberries, per pottle	0	2	0	0	6	0						
Strawberries (forced), per oz.	0	0	6	0	1	3						
Old Scarlets, per ounce	0	1	3	0	2	3						
Walnuts, per bushel	0	16	0	0	0	0						
Pine-apples per pound	1	0	0	1	5	0						
Hot-house Grapes, p. pound	0	10	0	0	18	0						
Cucumbers, Frame, p. brace	0	1	6	0	5	0						
Oranges, { per dozen	0	1	0	0	3	0						
{ per hundred	0	8	0	1	4	0						
Lemons, { per dozen	0	0	9	0	2	0						
{ per hundred	0	6	0	14	0	0						
Brazil Nuts, per bushel	0	16	0	1	0	0						
Barcelona, per peck	0	6	0	0	0	0						
Spanish, per peck	0	4	0	0	0	0						
Turkey, per peck	0	5	0	0	0	0						
Eggs of Silkworms, per 100	0	0	6	0	0	0						
Garden Snails, per quart	0	0	6	0	0	0						

*Observations.*—The prevalence of cold and wet, throughout the month of April, retarded the growth of all vegetable productions very materially, notwithstanding which our supplies of common articles have been tolerably abundant. Forced asparagus was much in demand, and brought very high prices; but in consequence of the recent change of the weather, which has caused a supply from the open ground, the forced article is no longer wanted but for soups. A few forced peas in punnets appeared in April, for which it was reported a very extravagant price had been obtained; but this was most properly contradicted in one of the newspapers, by Mr. Cooke, the fruiterer, &c., in Covent Garden Market. From appearance, I concluded that the variety was Bishop's New Early. Since that time some early single-blossomed Frames have been produced of much better sample and quality, which will give that variety a decided advantage over the other, except in cases where a very few early peas are desirable. Rhubarb stalks have been in great abundance, and almost in equal demand. The use of this article in the kitchen within the last few years has increased to a very great extent, and has induced many gardeners in the neighbourhood of



London to turn their attention to its improvement, whence have resulted several new varieties, among which may be particularly noticed Wilmot's Early Red, Radford's Giant, Dutly's Goliath, and Myatt's Seedling. The first is an early variety for forcing; the others are large and well flavoured, and equally desirable and advantageous, giving a large supply of fine stalks at this season for the table. Rhubarb stalks were first used as a substitute for, or mixed with, gooseberries or apples in tarts; but they are now esteemed for their peculiar flavour, without reference either to gooseberries or apples, and generally considered wholesome and nutritive. The first peas from the open garden appeared on May 16. — *G. C. May*, 1829.

---

ART. VI. *Horticultural Society and Garden.*

*APRIL 7. 1829.—Read.* Notice respecting the Cariaco or Amapo of South America, or Maiz de dos Meses; by John Hancock, M.D

*Exhibited.* A plant in flower of *Enkiánthus reticulatus*, from Thomas Carey Palmer, Esq. F.H.S. Yellow Chinese Azalea, from William Wells, Esq. F.H.S. Nine sorts of Camellias, from Messrs. Chandler and Son. An Apple, unnamed, from Mr. James Young, F.H.S. Four sorts of Apples from Robert Holden, Esq.

*Also, from the Garden of the Society.* Bellissime d'Hiver pear, and sixteen sorts of apples.

*April 21.—Read.* Upon the cultivation of the *Bouvárdia triphýlla*; by Mr. John Mearns, F.H.S. Journal of Meteorological Observations, made in the Garden of the Horticultural Society at Chiswick, during the year 1828; by Mr. William Beattie Booth, A.L.S. An account of *Ribes sanguineum*; by Mr. David Douglas, F.L.S., &c.

*Exhibited.* Oranges from St. Michael's, from William Harding Read, Esq. C.M.H.S. Mushrooms, from Mr. William Dolby, gardener to John Josiah Guest, Esq. F.H.S. Flowers of *Magnòlia conspícua*, from Sir Abraham Hume, Bart. F.H.S. *Azàlea indica híbrida*, from Mr. James Young, F.H.S. A collection of *Polyanthuses* and *Aurículas*, from Mr. William Hogg, of Paddington. Four sorts of Camellias, from Messrs. Chandler and Son.

*Also, from the Garden of the Society.* Flower of Double Furze, Poppy Anemones, varieties of *Fritillària*, *Tùlìpa sylvéstris*, *Euphórbia rígida*, varieties of *Narcíssus* and *Ribes sanguineum*. Fruits of the Roseberry and Keen's Seedling Strawberry, forced in a curvilinear house.

*May 5.—Read.* Upon the Management of Bees; By Alexander Seton, Esq. F.H.S. Upon the supposed Changes of the Climate of England; by Thomas Andrew Knight, Esq. F.R.S. and President. Upon the Ventilation of Hotbeds; by Mr. R. L. Howes, gardener to Mrs. Everard, of Middleton, Norfolk. Upon an Improvement in the Construction of Hot-houses; by Mr. John Legge, C.M.H.S. History and Description of the Species of *Caméllia* and *Thèa*, cultivated in the Garden of the Horticultural Society; by Mr. William Beattie Booth, A.L.S.

*Exhibited.* Cucumbers, from Mr. R. L. Howes, gardener to Mrs. Everard of Middleton, Norfolk. Cucumbers, from Mr. John Legge, C.M.H.S. Specimens of nine sorts of Broccoli, from Mr. Hugh Ronalds, F.H.S. Camellias, cut from a plant which has been growing in the open ground for five years, at Killerton, from Sir Thomas Dyke Ackland, Bart. F.H.S. Flower of a new seedling Camellia, from John Allnut, Esq. F.H.S. Dutch Pippins, from Mr. William Beattie, F.H.S.; Sweeney Nonpareils, from Thomas Netherton Parker, Esq. F.H.S.; and three sorts of Apples, from Mr. John Mitchell, C.M.H.S.

Also, from the Garden of the Society. Knight's protecting Broccoli, flowers of Coloured Oxlips, Coloured Cowslips, Poppy Anemones, Early Tulips, varieties of *Fritillaria*, *Ribes sanguineum* and *aureum præcox*, Double Furze, *Amýgdalus pérsica flore pleno*, *Prúnus sinénsis*, varieties of *Narcíssi*.

May 19. — Read. On the Management of the Genus *Caméllia*; by Mr. Thomas Blake, F.H.S. gardener to Lord Rolle, F.H.S. Remarks on the Culture of the Vine; by H. Barry, Esq.

Exhibited. Candle from the wax of the *Rhús succedánea*, from F. D. Davis, Esq. Broccoli, from Mr. James Dann, Gardener to the Rev. Henry Symonds De Brett, F. H. S. Ten sorts of Flowers, from Robert Barclay, Esq. F.H.S. *Azàlea índica álba*, *Rhododéndron frágans*, and a seedling var. of *Rhododéndron catawbiénsis*, from Messrs. Chandler and Son. Remarkably fine Asparagus, from Mr. Grayson of Mortlake, Surrey.

Also, from the Garden of the Society. Nine sorts of apples and thirteen sorts of Rhubarb, flowers of *Wistària Consequàna*, Yellow *Ròsa Bánksiæ*, *Chelòne Scoulèri*, Common and Irish Poppy Anemones, *Narcíssus*, *Pæonies*, Double Tulips, Single Tulips, Parrot Tulips, Double-flowering Furze, *Cýtísis ruthénicus*, *Cýtísis elongátus*, *Spártium scórpius*, *Ribes aureum*, seedling Heart's-ease and Double *Prúnus Cérasús*.

The Anniversary Fête of the Society will take place at the garden at Chiswick, on Saturday, June 27.; for which tickets will be issued from the office in Regent Street under the following regulations:—

1. All Fellows of the Society will be furnished with tickets of admission for their own personal use at 21s. each.

2. All Fellows of the Society will be furnished with tickets for each and every member of their family at 21s. each, up to the 15th of June inclusive; after that day and up to the 20th of June inclusive, at 1l. 11s. 6d. each, and subsequently, at 2l. 2s. each.

3. Such tickets as may be required by Fellows beyond those for individuals of their own family, must be applied for, either personally or in writing, when vouchers will be issued by the Committee in favour of the applicants. These tickets will be 25s. each, up to the 15th of June inclusive; after that day and up to the 20th of June inclusive, they will be 1l. 11s. 6d. and subsequently 2l. 2s.

4. Tickets will not be transferable.

5. If tickets are exchanged, the difference must be paid between the value of the original ticket and the price which may be borne by tickets at the time of the exchange being effected.

The Chiswick Garden, May 20. — We have visited this garden two or three times since our return from the Continent, but found little to remark on. On the whole, it is kept in good order, and extra-attention seems to be paid to the hot-house plants, and especially to the orchideous epiphytes. *Wistària Consequàna* is now splendidly in bloom on the open wall; the number of blossoms exceeds 1500, each raceme from 12 to 18 in. long, each blossom like that of a scarlet runner, but much larger, and of a light purple. Such a plant, trained to a parasol or to a tree, in the open garden on a lawn, would produce an effect much more natural and imposing, because one beauty of all flowers and fruits that come in bunches is to hang freely down. No person having a house or garden, either in town or country, however small, ought to be without this extraordinary fine climber; when once established it grows with great rapidity. The plant in the Chiswick garden last year made shoots 50 ft. long; four plants, we should think, if done justice to at the roots, would cover the walls of St. Paul's Cathedral in ten years, and one plant, in a good churchyard, would cover any country church in less than that time. The price from being 40s. has fallen to 5s. and 7s. 6d. each.

It deserves to be noticed, that the artesian well here, which four years

ago gave six gallons a minute, does not now give one gallon, and water is accordingly supplied to the garden from one of the public water companies. The flow of most of the other artesian wells, that we have heard of, has diminished in a not less extraordinary proportion; the natural consequence of the great increase of the number of these wells, within a limited district, in diminishing the source of supply. The water-borers at Paris will, we trust, profit by this fact.

On a former occasion, we stated the advantages that would result to the visitors of this garden, from having all the hardy plants, species as well as varieties, conspicuously named. Our correspondent, Mr. Murray, has shown (Vol. III. p. 29.), that this may be done in the Glasgow garden, in a most superior style, at the rate of 25s. per hundred; say in the Chiswick garden at 30s. per hundred; or, for the 3000 articles that may require naming, 45l.; a trifle scarcely more than a fifth part of the amount of the receipts for produce sold last year. With respect to Mr. Murray's tally (fig. 16. Vol. III. p. 29.), we can state it from experience to be far<sup>ly</sup> preferable to painting the name on plates, either of iron or lead, however carefully these plates may have been prepared. We received a tally from Mr. Murray a little more than two years ago, and stuck it in the ground along with some others, with the names painted on cast-iron, the iron being previously boiled in oil, and afterwards three times painted. We also stuck in some on which the names were painted on plates of lead, the plates being prepared by three coats of paint. The letters, both on the iron and the lead, are beginning to fade, while Mr. Murray's letters on wood and under glass are as clear as when they were put in; the air being completely excluded from the letters. Possibly a card might be substituted for the slip of wood, and the name, class, native country, year of introduction, &c. handsomely printed at a printing-office. We throw out the idea for gardeners who have the naming of private collections, and hope soon to supply some other hints on the subject. — *Cond.*

#### ART. VII. *Arboretum in the Garden of the Horticultural Society.*

WE have delayed so long to lay the plan of this notable work before our readers, that we fear a number of them will have forgotten our promise to do so. The reason of the delay has been an utter aversion, on our part, from the duty of finding fault with a production which, were it any where else but in the garden of a public body, would be beneath criticism.

The first duty of the critic of any production is to endeavour to ascertain the object which the producer has had in view; and the only data that we have for this is in the name "*Arboretum*," the references to the plan, and the following passage from the *Report of the Garden Committee for 1826* :—

"The entire garden must be viewed as created for the illustration of all objects connected with gardening, and as intended to fulfil the purposes of all the original institution of the Society, pointed out in its charter, '*the improvement of horticulture in all its branches, ornamental as well as useful.*'"

The words in italics in the above extract are in italics in the report; from which, and from the plan of the water and the turf in the arboretum, we conclude that that department of the Chiswick garden is meant to exhibit a specimen of landscape-gardening as well as a collection of trees and shrubs. Every one who looks at the plan (fig. 79), and has seen the garden, will we think, allow that we are justified in forming this conclusion; and therefore we may fairly proceed to examine it, first as a landscape composition of wood, water, and turf; and secondly, as an assemblage of trees for botanical and pictorial study.

As a landscape composition, it must either be an imitation of natural scenery, or a composition with a view to create a character of art; any thing between the two would be too indefinite to have much beauty. No one, for a moment, can ever mistake either the water or the clumps for natural forms; and, therefore, we must conclude that an artificial character was intended. An artificial character may be highly beautiful without being natural. The French parterre is an artificial character, and is very perfect and very beautiful in its way. So may an artificial arboretum, for it might be arranged as a parterre on a large scale; and, therefore, we are bound to conclude that the artist who devised the plan of this arboretum had an artificial character in view. There can be no question that he was satisfied with the beauty of his composition, and it is equally certain that the garden committee consider it beautiful; for in the same *Report* which we have quoted, they state "that if the plan of the garden were again to be arranged, the present would probably be adopted by all who are acquainted with its details." We confess we can see neither beauty nor fitness in any part of the plan of this garden, as we have before stated (*Encyc. of Gard.*, § 7507.; *Gard. Mag.*, vol. ii. p. 359.), and least of all, in the plan of the arboretum. But, having shown that it has no natural beauty, we shall employ a few words to prove that it is equally deficient in artificial beauty.

As the first effect of natural beauty is the impression of a resemblance to nature, so the first effect of artificial beauty is the impression that the scene could only have been produced by art. Both characters are produced by art; but in the former case art is studiously concealed; in the latter, it is distinctly avowed. The grand defect of this arboretum is, that the forms, neither separately nor combined, are sufficiently geometrical; and the second defect is, that from no point, nor in any manner in which it can be viewed, does it form a whole. With the single exception of the two ovals (*a b* and *c d*), there is not a single clump that might not be moved either backwards or forwards, or taken away altogether, without in the slightest degree injuring the effect of the rest, or of the water or grass. The water might have been more or less bent in its direction, and broader or narrower at any one particular part, without the slightest derangement to the grass or the clumps. The only thing like what an artist would call a feature in this plan is the open glade (*e f*), in the direction of the committee room (*g*). This is the single redeeming point in the whole composition, which is otherwise so tame and lumpish as to leave no striking or agreeable impression. Whoever has Brewster's *Encyclopædia*, and will turn to the article Landscape-gardening and the plate of the grounds at Duddingston House near Edinburgh, will be struck with the similarity in the manner of laying out that place by a pupil of Brown between 1770 and 1780, and of laying out the arboretum of the Chiswick garden in 1825; and they may ascertain the opinion now entertained of the beauty of the grounds at Duddingston House, as well in the article alluded to as in Sir Walter Scott's review of the *Planter's Guide* in the *Quarterly Review* for October, 1827.

The next thing is to examine how far the disposition of the clumps is favourable to the purpose of examining different species or genera of trees individually, in connection with other species of the same genus, or genera of the same order, in the Jussieuan or Linnean system. Ready and comfortable access to each individual species at all seasons when plants are in flower or leaf, and such an obvious arrangement as that a botanist, knowing the position of any two genera, might tell where to find a third, it will we think, be allowed, are leading desiderata for this purpose.

Accordingly, almost all the arboretums in Europe have the trees planted along gravel walks that the botanist may examine them without damping his feet by moist earth or dewy grass; and the genera following each

other either alphabetically, or in the order of some botanical system, that he may know where every genus is to be found. At Messrs. Loddiges', the

79

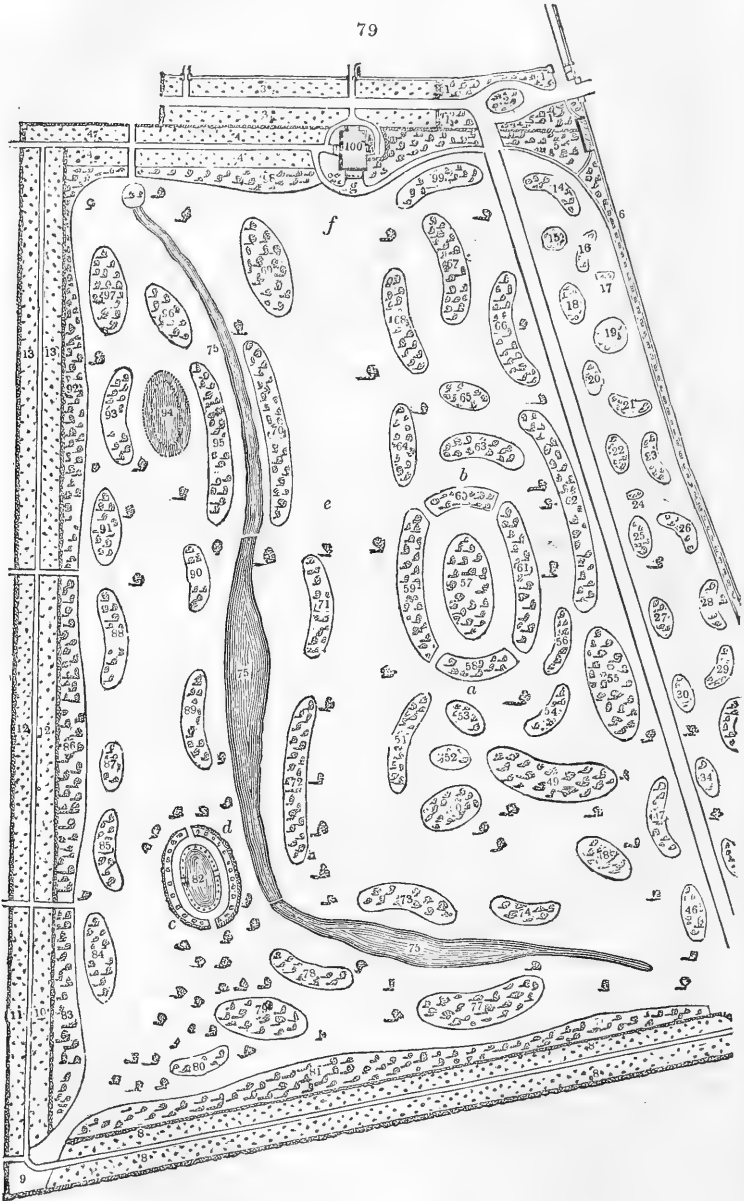

most complete arboretum in the world in point of species, the order is alphabetical; in the botanic garden at Munich the order is Jussieuan, and the trees are disposed in a natural-looking manner on a broad border of turf, so that each species is distinctly seen from the walk; and the whole forms a protecting belt to one side of the garden. Here science and picturesque beauty are combined, and we have before stated (Vol. II. p. 559.) that this might have been done in a marginal belt round the whole of the Chiswick garden. In the arboretum of the Chiswick garden, the dug clumps are surrounded by grass, which, of course, can only be walked on in fine weather, and the genera are distributed through them at random, as the references to the plan of the arboretum in the note below, will show.\* As a scientific arboretum therefore, this department of the

\* *References to the Plan of the Arboretum in Appendix I.*

- |   |   |
|---|---|
| 1. Miscellaneous Shrubs at the entrance.  | 24. Hydránga horténsis.   |
| 2. Miscellaneous Shrubs. Species and Varieties of <i>Vinca</i> .  | 25. <i>Nýssa</i> , <i>Halèsia</i> .   |
| 3. Dwarf Garden Roses in the Border. Trailing Roses against the Wall.                                   | 26. <i>Dáphne</i> , <i>Phlòmis</i> , <i>Aúcuba</i> .  |
| 4. Varieties of <i>Azàlea nudiflòra</i> and <i>viscòsa</i> .  | 27. <i>Genísta</i> .  |
| 5. Miscellaneous Shrubs.  | 28. Chinese Roses.  |
| 6. Trailing Shrubs and Chrysanthemums against the Wall. Bulbous and other similar plants in the Border. | 29. <i>Cístus</i> .   |
| 7. Hardy Heaths.  | 30. Dwarf Roses.  |
| 8. Various Garden Roses.  | 31. <i>Yúcca</i> .  |
| 9. Varieties of <i>Rhámnus Alatérnus</i> .  | 32. <i>Thùja</i> , <i>Labúrnum</i> , <i>Syrínga</i> .   |
| 10. Varieties of <i>Ròsa spinosíssima</i> .   | 33. <i>Yúcca</i> .  |
| 11. American Roses, and varieties of <i>Ròsa rubiginòsa</i> .   | 34. <i>Cýtissus</i> .   |
| 12. Miscellaneous Exotic Roses, Species and Varieties.  | 35. <i>Juníperus</i> , <i>Potèrium</i> , <i>Decumària</i> , <i>Stýrax</i> .   |
| 13. British Roses, Species and Varieties.   | 36. <i>Aristotèlia</i> , <i>Dorýcnium</i> , <i>Bupleùrum</i> , <i>Sideróxyton</i> , <i>Fúchsia</i> , <i>Bumèlia</i> , <i>Vélla</i> , <i>Cneòdron</i> , <i>Adèlia</i> , <i>Fontanèsia</i> , <i>Camphorósmà</i> , <i>Pistàcia</i> , <i>Notelæ'a</i> . |
| 14. <i>Spiræ'a</i> , <i>Vibúrnum</i> .  | 37. <i>Juníperus</i> , <i>Stýrax</i> .  |
| 15. <i>Spiræ'a</i> , <i>Vibúrnum</i> , <i>Myrica</i> , <i>Nitrària</i> .                                | 38. <i>Hydránga horténsis</i> .   |
| 16. <i>Fothergílla</i> , <i>Clèthra</i> .   | 39. <i>Hibíscus syriacus</i> .  |
| 17. Heliotropes, Geraniums, or similar tender plants placed in the open borders during summer.          | 40. <i>Caragàna</i> .   |
| 18. <i>Spiræ'a</i> , <i>Vibúrnum</i> , <i>Amýgdalus</i> .   | 41. Miscellaneous Tall Roses.   |
| 19. <i>Menzièsia</i> , Half-hardy Heaths, <i>E'mpetrum</i> .  | 42. <i>Caragàna</i> .   |
| 20. <i>Spiræ'a</i> , <i>Vibúrnum</i> , <i>Potentilla</i> , <i>Calycánthus</i> .                         | 43. <i>Pæònia Mòutan</i> .  |
| 21. <i>Bérberis</i> , <i>Prínos</i> .   | 44. <i>Ròsa bracteàta</i> .   |
| 22. <i>Bérberis</i> , <i>Spiræ'a</i> , <i>Vibúrnum</i> , <i>Onònis</i> .                                | 45. <i>Hypèricum</i> , <i>Rúscus</i> .  |
| 23. <i>Lèdum</i> , <i>Magnòlia</i> , <i>Gordònia</i> , <i>Rhodòra</i> .                                 | 46. } <i>Spartium</i> , <i>Philadèlphus</i> , <i>Eu-</i>  |
|   | 47. } <i>onymus</i> .   |
|   | 48. <i>Castànea</i> , <i>Edwàrdsia</i> .  |
|   | 49. } <i>Cratæ'gus</i> .  |
|   | 50. } <i>Cratæ'gus</i> .  |
|   | 51. <i>Æ'sculus</i> .   |
|   | 52. } <i>Cratæ'gus</i> .  |
|   | 53. } <i>Cratæ'gus</i> .  |
|   | 54. }   |
|   | 55. } <i>Prúnus</i> , <i>Amýgdalus</i> .  |
|   | 56. }   |
|   | 57. <i>Rhodéndron pónticum</i> and <i>Azàlea póntica</i> .  |
|   | 58. <i>Kálmia</i> , <i>Cephalánthus</i> , <i>Gaulthèria</i> .   |

garden is still more discreditable to the Society, than as a specimen either of natural or artificial landscape-gardening.

Altogether, when we reflect on this arboretum, we are astonished that such an absurdity could be produced in such an age and in such a country. We can only account for it by reflecting on the preponderating influence, in the council and committees of the Horticultural Society and Garden, of a gentleman, who, though he has not attended to this subject, certainly possesses great merit in point of zeal, activity, and perseverance, and is surpassed by none in describing pæonies, crocuses, and chrysanthemums. The evils to the Society which have attended the placing of so much power in the hands of this individual have been pointed out by one of our earliest correspondents (Vol. I. p. 146.), and they will only be removed by the remedy there suggested. Nobody, however, will take the necessary trouble. What ought to have been done, in order to insure a good plan of the arboretum, has been pointed out by our correspondent, A Nurseryman. (Vol. II. p. 469.) We have performed our duty in exposing the case for the benefit of other societies and secretaries.

- 
- |  |  |
|--|--|
| 59. <i>Andrómeda</i> , <i>Pincknèya</i> .                          | <i>póphæ</i> , <i>Shephérdia</i> , <i>Artemísia</i> ,                |
| 60. Dwarf <i>Rhodéndron</i> , <i>I'tea</i> , <i>Andrómeda</i> .    | <i>A'triplex</i> , <i>Bácccharis</i> , <i>Santolína</i> ,            |
| 61. <i>Vaccínium</i> .   | <i>Cinerària</i> , <i>I'va</i> .                                     |
| 62. <i>Pýrus</i> , <i>Cupréssus</i> .                              | 82. Morass for Aquatic Plants.                                       |
| 63. <i>Pýrus</i> , <i>Ribes</i> .                                  | 83. <i>Pínus</i> , <i>Tília</i> , <i>Rhámnus</i> , <i>Asímína</i> ,  |
| 64. <i>Laúrus</i> , <i>Chionánthus</i> , <i>Sophòra</i> ,          | <i>Diospýros</i> , <i>Anòna</i> , <i>Comptònia</i> .                 |
| <i>Anagýrus</i> , <i>Virgília</i> , <i>Salisbùria</i> .            | 84. <i>Pínus</i> , <i>Tília</i> , <i>Euphórbia</i> , <i>Arália</i> . |
| 65. <i>Pýrus</i> .   | 85. <i>Fráxinus</i> , <i>Ligústрум</i> .                             |
| 66. <i>Búxus</i> , <i>Ribes</i> , <i>Cotoneáster</i> , <i>Ame-</i> | 86. <i>Fráxinus</i> , <i>Pínus</i> , <i>Córnus</i> , <i>E'phe-</i>   |
| <i>lanchier</i> .  | <i>dra</i> , <i>Broussonètia</i> , <i>Hyssòpus</i> ,                 |
| 67. <i>Phillyrea</i> , <i>Támarix</i> , <i>Ribes</i> , <i>Acà-</i> | <i>Coriària</i> , <i>Ptèlea</i> ,                                    |
| <i>cia</i> , <i>Zizyphus</i> , <i>Bigelòvia</i> , <i>Li-</i>       | 87. <i>Fráxinus</i> , <i>Pínus</i> , <i>Staphylèa</i> ,              |
| <i>quidámbar</i> , <i>Sálvia</i> .                                 | <i>Vitex</i> .   |
| 68. <i>I'lex</i> , <i>Bignònia</i> , <i>Gymnocládu</i> ,           | 88. <i>Fráxinus</i> , <i>Pínus</i> , <i>Rhús</i> , <i>Psorà-</i>     |
| <i>Lavatèra</i> , <i>Schínus</i> , <i>Celástrus</i> ,              | <i>lea</i> .   |
| <i>Liriodéndron</i> .  | 89. <i>Sàlix</i> .   |
| 69. <i>Robínia</i> .   | 90. <i>Sàlix</i> , <i>Céltis</i> , <i>Salsòla</i> , <i>Polýgo-</i>   |
| 70. <i>Bétula</i> , <i>A'lnus</i> .                                | <i>num</i> , <i>Paliúrus</i> .                                       |
| 71. <i>Gledítschia</i> , <i>Ailántus</i> , <i>Amórpha</i> ,        | 91. <i>Pínus</i> , <i>Pópulus</i> , <i>Xanthóxylo</i> ,              |
| <i>Cércis</i> , <i>Kölreutèria</i> , <i>Ceanòthus</i> .            | <i>Xanthorhiza</i> .   |
| 72. <i>Júglans</i> , <i>Fágu</i> , <i>Cárpinus</i> , <i>As-</i>    | 92. <i>Pínus</i> , <i>Pópulus</i> , <i>Córylus</i> , <i>Rù-</i>      |
| <i>trágalus</i> .  | <i>bus</i> , <i>Hamamèlis</i> , <i>Solànum</i> ,                     |
| 73. <i>Júglans</i> , <i>O'strya</i> , <i>Menispérmum</i> ,         | <i>Rùta</i> .  |
| <i>Kérria</i> , <i>Lavándula</i> .                                 | 93. <i>Pínus</i> , <i>Pópulus</i> , <i>U'lex</i> , <i>Sam-</i>       |
| 74. <i>Dahlías</i> , or similar plants.                            | <i>bùcus</i> .   |
| 75. Canal.   | 94. Hardy British <i>Orchídeæ</i> .                                  |
| 75.* <i>Overflowing Well</i> .                                     | 95. <i>Bétula</i> , <i>A'lnus</i> .                                  |
| 76. <i>A'cer</i> .   | 96. <i>Sàlix</i> .   |
| 77. )  | 97. <i>Pópulus</i> , <i>Pínus</i> , <i>Mòrus</i> , <i>Xylós-</i>     |
| 78. ) <i>Quércus</i> , <i>U'lmus</i> .                             | <i>teum</i> , <i>Symphòria</i> , <i>Diervílla</i> .                  |
| 79. )  | 98. <i>Pínus</i> , <i>Plátanus</i> , <i>Táxus</i> , <i>Ros-</i>      |
| 80. )  | <i>marínus</i> , <i>Medicàgo</i> , <i>Callicárra</i> ,               |
| 81. <i>Quércus</i> , <i>U'lmus</i> , <i>Planèra</i> , <i>Là-</i>   | <i>and Miscellaneous Shrubs</i> .                                    |
| <i>rix</i> , <i>Elæágnus</i> , <i>Colùtea</i> , <i>Hip-</i>        | 99. Double Scotch <i>Roses</i> .                                     |

ART. VIII. *A Commercial Horticultural Society.*

SIR, I ought sooner to have sent you some account of the endeavours which I and some of my friends are making to establish a Horticultural Society at the city end of the town. It is not intended at all to be a rival of the great aristocratical Society at the west end; but merely to supply the wants of the lovers of horticulture in the east end. We propose it to be of a much more humble description, and more of a commercial nature than the parent Horticultural Society. It will combine some of the best features of the pleasure-garden, the flower-garden, the nursery, and even the tea-garden, and there will be added a literary mechanics institution. Ladies as well as gentlemen may be subscribers, and tickets will be transferable like shares, under certain regulations. Ten acres of garden ground are in view, in which nothing will be grown that does not properly belong to horticulture or floriculture, neither pure botanical plants, nor forest trees will be attended to. Every subscriber will have at least half the amount of his subscription returned to him, in the form of seeds, roots, or plants, at stated periods during each year. There will be a house in the garden for refreshments of all kinds, and for dinners, at which members may prove the quality of fruits and vegetables. In this house there will be a meeting-room, in which will be a collection of books for the use of the members and gardeners; and there will be voluntary lectures and instructions given there on every branch of science connected with gardening, as well for the attendance of subscribers and working gardeners, as for that of all gardeners and persons whatever who choose to pay a small fee. The Society will take in apprentices and send out gardeners to situations. They will have a large show conservatory, or bazaar, in town for the exhibition and sale of plants in pots, from their own or from any other garden or nursery; and, adjoining this flower bazaar, there will be a gardener's coffee-house, and a room for the monthly meetings of the Society. At these meetings lady-members may attend; and it is proposed that the discussions should be rather more in the nature of *conversazioni*, than in the meetings of the Regent Street Horticultural Society. The next thing which I mean to propose, I am sure you will approve of, and that is voluntary travelling missions in Britain and on the Continent, the individuals composing the mission to have only a part of their expenses allowed, both with a view of acquiring information, purchasing foreign plants, roots, and seeds, and of criticising gardens for the benefit of gardeners and their employers. Finally, and this you will, perhaps, not approve of, we intend publishing a weekly *Gardener's Newspaper*, in imitation of the *Farmer's Journal*.

We may not accomplish all these things at once, but we shall attempt them, unless something better can be suggested; and it is with a view to invite suggestions that I send you this letter; to which I have only to add, that I shall be happy to hear from, or to meet, any gentleman on the subject, and to introduce him to such of my friends as are assisting me in promoting these views. I am, Sir, yours, truly. — J. P. Burnard. *Formosa Cottage, Eden Grove, Holloway, May 16. 1829.*

---

ART. IX. *Provincial Horticultural Societies.*

HUNTINGDONSHIRE.

*HUNTINGDON Horticultural Society.* — The Annual Spring Show of the above Society was held in Huntingdon on April 22., when prizes were awarded as follows:—



*Flowers.* Green-edged Auricula: 1. Page's Champion, Mr. Dally; 2. Stretch's Alexander, Mr. Hyland. Grey-edged Auriculas: 1. Kenny's Ringleader, Mr. Hyland; 2. Ringleader, Mr. Woods. White-edged Auriculas: 1. Taylor's Glory, Mr. Woods; 2. Taylor's Glory, Mr. Hyland. Self Auriculas: 1. Whittaker's True Blue, Mr. Woods; 2. Gordon's Goldfinch, Mr. Dally. Seedling Auricula, being worthy of merit, Mr. Woods. Polyanthus: 1. Nicholson's Varg. Europe, Mr. Hyland; 2. Pierson's Competitor, Mr. Woods. Seedling Polyanthus, being worthy of merit: Beauty of Woodbury, Mr. Dally. Double blue Hyacinth: 1. Mr. Dell; 2. Pasquin, Mr. Ray. Double red or pink Hyacinth: 1. Mr. Dell; 2. Rose Inquisina, Mr. Howson. Double white Hyacinth: 1. Minerva, Mr. Howson; 2. Alamode, Mr. Lovel. Yellow Polyanthus Narcissus: Sol de l'Or, Mr. Howson. White Polyanthus Narcissus: Grand Citronier, Mr. Dell.—*Culinary Vegetables.* Brace of Cucumbers: 1. Hyland's Superb, Mr. Hyland; 2. Hyland's Superb, Mr. Dell. First dish of early Potatoes (not less than 1 lb.), Mr. Dally. First hundred of Asparagus, Mr. Dell.—*J. Holmes. April 24. 1829.*

## CAMBRIDGESHIRE.

*Cambridgeshire Horticultural Society.*—The first Show for this year was held on March 6. Considering the unfavourable weather for this season, the show was very excellent, and the company (which was numerous) expressed great satisfaction with it. Colonel Pemberton took the chair at two o'clock, when the following adjudication of prizes was announced:—

*Fruit.* Table Apples: 1. Old Golden Pippin, Nonpareil, Colonel Pemberton; 2. Golden Pippin and Nonpareil, Mr. Challis. Baking Apples: 1. Normont: Wonder Pearmain, Mr. Widnall; 2. Kentish Pippin Old Pearmain, Colonel Pemberton.—*Flowers.* Hyacinths: 1. La Blue Fonce, Nannette, Hugo Grotius, and 2. Waterloo, La Donne, Gratuite, Mr. Dall; 3. Madame Talleyrand, Mr. Searle. Polyanthus Narcissuses: 1. Soleil d'Or, Bazelman major, Mr. Searle; 2. Soleil d'Or, Grand Citronier, Mr. Dall.—*Plant* (in a pot), White Camellia, Mr. Searle.—*Culinary Vegetables.* Cucumbers: Medal, and a voluntary subscription of one guinea, Mr. Searle. Celery, Colonel Pemberton. Rhubarb (red-stalked), Chris. Pemberton, Esq. Sea-kale, Chris. Pemberton, Esq. Mushrooms, Mr. French, gardener to Rev. G. Jenyns. White Broccoli, Mr. Palmer of Ely.

*Extra-Prizes.* Asparagus, Mr. Dall. Potatoes: Ash-leaved Kidney, Mr. Challis. Apples: 1. Scotch Pippin, Mr. Hudson; 2. Aromatic Russett, Mr. French, gardener to Rev. G. Jenyns. Onions: White Spanish, Mr. Palmer of Ely. Daffodil, Mr. Searle.

The judges intimated that they were, in three instances, precluded from adjudging prizes where they should have felt bound to have awarded them; but the members had not conformed to the rules for exhibitors, annexed to the list of articles for the year.

We should have noticed that, previously to the announcement of the prizes, the Secretary read the report, from which it appears the Society is well patronised, and in a flourishing state. The report dwelt much upon the advantage of communications upon horticultural subjects, which would, doubtless, be a most efficient way of promoting the usefulness of the Society. We think it would be a great benefit to the practical gardeners, and those amongst amateurs who have the means of making experiments, if they would communicate the results of their various processes towards the improvement of the science. This observation we more particularly direct to the practical gardeners, for we are apprehensive that some of them entertain the idea, that if they were to be too liberal in their communications to the public, their craft would be in danger. We, however, on the contrary, think that the greater number of useful contributions a gardener could send to the Society, the more certainly he would be the very man

that would be sought out by employers as the most scientific and best informed in his trade.

Another point of considerable importance in the report had reference to cottagers' prizes. We strongly recommend this to the attention of those who feel an interest in the welfare of cottagers, and would suggest the propriety of making this useful fund more generally known amongst our poorer neighbours.

The next Show is to take place on Thursday the 16th of April, when cottagers' prizes will be given for the best wallflower grown in a pot, for the best fifty radishes, and for the best cabbage.

The above Society held their April Show yesterday (16th). Considering the backwardness of the season, it was a very good show. The company, however, was not numerous, owing to the heavy rain which continued the whole day. The following adjudication of prizes was announced:—

*Fruit.* Table Apples: Nonpareil, Mr. Challis. — *Flowers.* Auriculas: 1. Arden's Empress of Russia, Flora's Flag, Metcalfe's Lancashire Hero, Mather's Brilliant; 2. Lancashire Hero (miscalled Cockup's Eclipse), the Pillar of Beauty, Pott's Delegate; and 3. Stretch's Alexander, Mr. Haylock. Polyanthuses: Tantarara, Cox's Regent, Black's Stranger, Thompson's Invincible, Mr. John Sharp, gardener to Professor Turton. Polyanthus: No first prize; 2. Park's Nelson, Mr. John Sharp. Seedling Polyanthus, Mr. John Sharp. Wallflower, Mr. Widnall. Rose, Old Provence, Mr. Catling. — *Culinary Vegetables.* Cucumbers (best brace): 1. Mr. Dall; 2. would have been awarded to Mr. Bird, but the articles were not sent in time. Potatoes: 1. Dish weighing 2 lbs., 37 in number, Mr. Challis; 2. dish weighing 1 lb., 19 in number, Mr. Lestourgeon. Broccoli (best dish), Col. Pemberton. Broccoli (best head), Mr. Palmer of Ely. Cabbage, Mr. Widnall. Rhubarb: 1. Mr. Catling; 2. C. Pemberton, Esq. — *Cottager's Prize.* Cabbage, John French, of Cherryhinton.

*Extra-Prizes.* Cottager's Apples, Mr. Hayles of Ickleton. Mushrooms and French Beans, Mr. French, gardener to the Rev. G. Jenyns. Carrots, Mr. Challis. Geranium, Stanertia, or Tippoo Saib, Mr. Widnall. *Oncidium divaricatum* and *Azalea discolor*, Mr. Biggs. Bouquet, Mr. Biggs. Hyacinth, Mr. Gimson.

The judges intimated that the polyanthuses were not in show trim, and that it would be desirable in future to pass over all articles not properly exhibited. The next Show was announced for Friday the 22d of May. (*Cambridge Chronicle*, March 15. and April 17. 1829.)

We have received from W. G. Ashton, Esq., the Honorary Secretary, the first, second, and third Reports of this Society, which will be found noticed in Vol. IV. p. 172., and the fourth Report, for 1828. The letter is highly satisfactory. The Society have a considerable library, the books of which are lent out to the members under certain regulations, and are in constant circulation. — *Cond.*

#### SUFFOLK.

*Bury Horticultural Society.* — At the first Meeting of this Society for the present year, held April 21., the prizes were awarded as follows:—

*Fruit.* Table Apples: 1. Sweeny Nonpareil, and 2. Nonpareil, Mr. Barrett, Hardwicke. — *Flowers.* Best three Auriculas, and Seedling Auricula, Mr. Musk, Hengrave. Best four Polyanthuses, Mr. Barret, Hardwicke. Seedling Polyanthus, T. Clay, Esq., Bury. Tender Plant (*Camellia Sasánqua rosea*), Mr. Christ. Johnston, Bury. Double Wallflower, in a pot, Mr. Hammond, Barton. Best six Hyacinths, Mr. Barrett, Hardwicke, Tender Bouquet, Mr. Hammond, Barton. Hardy Bouquet, Mr. Barrett, Hardwicke. — *Culinary Vegetables.* Cucumbers, Mr. Lines, Livermere.

Best forced Potatoes: 1. Early Frame, Mr. Lines, Livermere; 2. Early Cockney, Mr. Nunn, Hardwicke. Broccoli, Mr. W. Barrett, Bury. Rhubarb, Rev. B. T. Norgate, Ashfield. Coss Lettuces, Mr. Camps, Boxted. Cottager's Vegetable (Red American Ranger Potato), Taylor. — *Bees*. Gates, Ingham, and Dyson, Dalham, having each eight stocks kept through the winter, 7s. each.

The show was excellent for this early period of the year. The prize camellia was a beautiful specimen, and among the other exotics were the *Azàlea índica*, *Urtica reticulata*, *Ardísia crenulata* (with its flowers and fruit), and a lovely wreath of the *Wistària Consequàna*, a beautiful climber of the papilionaceous tribe, which is now found to be a perfectly hardy plant. Besides the prize, there were beautiful hardy bouquets from the botanic garden and elsewhere. Some fine Roseberry strawberries were shown by Mr. Taylor, of this town; Queen Charlotte pears, in perfect preservation; the Normanton Wonder, a sauce apple, truly a wonder, by the Rev. B. Norgate; and some extraordinary fine early Cockney potatoes, the growth of last year, by Mr. Samuel Middleditch, which were not exhibited for prizes. The Cottagers' prizes gave particular satisfaction. (*Bury Post*, April 22.)

#### GLOUCESTERSHIRE.

*Gloucester Horticultural Society.*—At the first Show of this Society, which took place on May 1., the display of the varieties of auricula was extensive and highly pleasing. The stand of polyanthuses and hyacinths was also exceedingly well furnished, and eminently splendid, both for elaborateness of blossom and richness and diversity of tint. A great variety of other choice productions of Flora graced the room and gratified the eye; and Pomona likewise opened her ample stores, and made offerings of fruit as fresh and tempting as when first picked. Nor were the more useful denizens of the hotbed and kitchen-garden wanting on this occasion, many different edibles of great forwardness and singular merit being contributed. (*Hereford Journal*, May 6. 1829.)

#### WORCESTERSHIRE.

*Worcestershire Horticultural Society.*—The first Meeting of this Society for the present year was held May 1., and was attended by a numerous and highly respectable assemblage of subscribers and their friends. The exhibition gave universal satisfaction, far exceeding the expectation of the most sanguine, considering the cold and ungenial state of the weather for some time previous. The number of specimens ticketed and entered in the Society's books amounted to upwards of 400. A beautiful dish of lemons attracted universal admiration. The prizes were awarded as under:—

*Flowers.* Green-edged Auriculas: 1. Bearlis's Superb, Mr. Holmes; 2. Cockup's Eclipse, and 5. Duchess of Oldenburgh, J. Skey, Esq. Grey-edged Auriculas: 1. Ringleader, and 2. Ashworth's Rule-All, Mr. Holmes; 5. Hay's Lovely Ann, — Davis, Esq., Pershore. White-edged Auriculas: 1. Taylor's Glory, Mr. Hodges; 2. Popplewell's Conqueror, Mr. Harrison; 3. Dyson's Queen, Mr. Miller. Self Auriculas: 1. Metropolitan, — Davis, Esq.; 2. Grand Turk, and 5. Flora's Flap, Mr. Harrison. Alpine Auriculas: 1. George the Fourth, Mr. Holmes; 2. Seedling, Mr. Hodges; 3. Unknown, — Davis, Esq. Polyanthuses: 1. Pearson's Alexander, — Davis, Esq.; 2. Turner's Regent, Mr. Bradley. Double Red Hyacinths: 1. L'Honneur d'Amsterdam, Mr. Smith; 2. Groot Vorst, — Racster, Esq. Double Blue Hyacinths: 1. Duke of Wellington, and 2. Directeur van Flora, — Racster, Esq. Double Yellow Hyacinths: 1. Duc de Berri, and 2. Ophir, — Racster, Esq. Single Red Hyacinths: Princess Elizabeth, — Racster, Esq. Single White Hyacinths: Grand

Vanguard, — Racster, Esq. — *Plants*, Stove: 1. *Phyllánthus falcátus*, and 2. *Alpínia nitans*, Mr. Wood; 3. *Amarýllis reginæ*, Mr. Linton. Green-house: 1. *Glýcine bimaculàta*, Mr. Fuller: 2. *Cactus speciòsa*, Mr. Beach; 3. *Erica tubiflòra*, Captain Waldron; 4. *P. macránthon*, *P. majus superbum*, Mr. Hodges. Hardy: 1. Pansy, — Racster, Esq.; 2. Crimson Velvet Primrose, E. Isaac, Esq. — *Culinary Vegetables*. Rhubarb, Mr. Wood. Kidneybeans, Mr. Wood. Mushrooms, a fine dish, Mr. Fuller. Cucumbers, Mr. Beech. Sea-kale, Mr. Beech. White Broccoli: 1. Mr. Beech; 2. Invisible White, Mr. Wood. Cabbage, Mr. Hodges. — *Fruit*. Dessert Apples, Mr. Beech. Dessert Pears: Bergamot de Pasque, E. Isaac, Esq. Lemons, a beautiful dish, Mr. Hodges.

Nearly thirty new subscribers entered the Society, among whom, we learn, are Sir A. and Lady Lechmere, Sir E. Blount, Bart.; Rev. J. Fletcher, Bewdley; Rev. Dr. Grove, Strensham Rectory; Rev. T. W. Harward, Bromsgrove; F. Williams, Esq., &c. The next Meeting is looked forward to with much interest, as we understand considerable exertion is making to render the show unusually attractive. (*Worcester Herald*, May 2. 1829.)

*Worcester Horticultural Society.* — At the first Show of this Society for the present year, held on April 27., the prizes were awarded as follows: —

*Aurículas.* Green-edged: 1. Pearson's Badajos, Mr. Cox; 2. Cockup's Eclipse, Mr. Gummery; 3. Potts's Delegate, Mr. Miller; 4. Hofley's Lord Nelson, Mr. Cox. Grey-edged: 1. Lee's Bright Phæbus, Mr. Cox; 2. Hero, Mr. Brown; 3. Rider's Junius, Mr. Brown. White-edged: 1. Poplewell's Conqueror, Mr. Cox; 2. Hughes's Pillar of Beauty, Mr. Gummery; 3. Poplewell's Conqueror, Mr. Brown. Selfs: 1. Bishop of Lichfield, Mr. Cox; 2. Schoole's Ned Ludd, Mr. Cox; 3. Black Joke, Mr. Cox; 4. Dixon's Apollo, Mr. Miller. Alpines: 1. Madame Ducienne, Mr. Cox; 2. Unknown, Mr. Gummery. — *Polyanthuses.* Pearson's Emperor Alexander, Mr. Brown. (*Worcester Herald*, May 2.)

*Vale of Evesham Horticultural Society.* — The first Meeting of this Society for the present year was held on the 23d of April, and was numerous and respectably attended. Considering the unfavourable state of the weather and the backwardness of the spring, the show of flowers and vegetables was of the first order. Some of the aurículas and hyacinths were very superb, as also were the stove and green-house plants. A brace of queen pines, very well ripened, and a fine specimen of lemons, both grown by John Taylor, Esq., of Strensham, were generally admired: indeed, taking it on the whole, it was a splendid show for this season of the year, and must tend to advance the fame of this rising Society. We understand the next show is fixed for the 21st of May. Prizes were awarded as under: —

*Flowers.* Green-edged Aurículas: 1. Stretch's Alexander, 2. Beerless's Superb, and 3. Unknown, Mr. Holmes. Grey-edged Aurículas: 1. Kenyon's Ringleader, and 2. Hay's Lovely Anne, Mr. Mayfield; 3. Poplewell's Conqueror, Mr. Hunt. White-edged Aurículas: 1. Taylor's Glory, and 2. Hill's Lady Stamiord, Mr. Holmes. Self Aurículas: 1. Bury's Lord Primate, Mr. Holmes; 2. Whittaker's True Blue, and 3. Metropolitan, Mr. Valencourt. Alpine Aurículas: 1. George the Fourth, Mr. Holmes; 2. Seedling, Mr. Hunt; 3. Great Agitator, Mr. Davis. Dark Polyanthuses: 1. Pearson's Alexander, 2. Unknown, and 3. Seedling, Mr. Hunt. Red Polyanthuses: 1. Mant's Brilliant, Mr. Valencourt; 2. Seedling, Mr. Hunt; 3. Unknown, Mr. Valencourt. Double Red Hyacinths: 1. Waterloo, Mr. Davis; 2. Maria Louisa, and 3. Waterloo, Mr. Racster. Double Blue Hyacinths: 1. Directa van Flora, 2. Lord Wellington, and 3. Duc d'Angoulême, Mr. Racster. Double Yellow Hyacinths: 1. La Favourite, Mr. Racster. Double White Hyacinths: 1. Harmonia, Mr. Racster. — *Plants*. Stove and Green-house: 1. *Amarýllis vittata*, and 2. Manuel Geranium, Mr. Fulton; 3. Dragon arum, Mr. Hartland. Hardy: 1. Yellow Crown

Imperial, Mrs. Charles; 2. Double White Primrose, John Taylor, Esq. — *Culinary Vegetables.* Sea-kale, Mr. Fulton. Cucumbers, Mr. Tessop. Broccoli: 1. Mr. Hunt; 2. J. Taylor, Esq. Cabbage: 1. Early Dwarf and 2. Early Wellington, J. Taylor, Esq. — *Fruit.* Best Keeping Apple, Mr. Fleetwood. (*Worcester Herald*, May 2. 1829.)

## HEREFORDSHIRE.

*Herefordshire Horticultural Society.* — On *May-day* the fifteenth exhibition of this Society took place at our Shire Hall, and no previous meeting has afforded more general satisfaction: from the backwardness of the season, a very different result was anticipated; but all apprehensions instantly vanished on entering the room. The auriculas evinced the florist's care; we never remember to have witnessed at any place an exhibition at which the varieties of that elegant flower were in greater perfection. The seedling polyanthuses possessed great merit; and although there was a partial failure in the blue Hyacinths, the other classes were conspicuously splendid. It affords us much pleasure to witness the useful progress of this society: since its institution there has been a rapid and obvious improvement in the showy department of the florist, and in the more useful range of culinary vegetables. The present exhibition also showed the increased interest that is taken in its welfare, by the possessors of rare stove and green-house plants. The centre stage was never more elegant or select. The stage for vegetables exhibited fine specimens of kidneybeans, cucumbers, cabbages, asparagus, mushrooms, rhubarb, potatoes, sea-kale, lettuces, broccoli, and some blanched succory. There were also some plates of remarkably good dessert apples, as fresh in appearance as when first gathered from the trees. On the Society's table we saw a little publication of the Secretary's, Mr. Godsall, containing a brief account of the different meetings of the Society, entitled the Hereford Florist's Register. The following is a list of the prizes: —

*Plants.* Stove or Green-house: 1. *Cactus speciosa*, C. G. Cooke, Esq.; 2. *Hovea Celsi*, Mrs. Parkinson; 3. *Gnida sericea*, Sir J. G. Cotterell; 4. *Acacia armata*, Mrs. Gordon; 5. *Correa speciosa*, and 6. *Eutaxia myrtifolia*, Sir J. G. Cotterell. Hardy: 1. Yellow China Rose, and 2. Double Velvet Primrose, Sir J. G. Cotterell. — *Flowers.* White-edged Auriculas: 1. Hughes's Pillar of Beauty, Mrs. Parkinson; 2. Taylor's Glory, Mr. Godsall. Grey-edged Auriculas: 1. Popplewell's Conqueror, Mrs. Parkinson; 2. Grimmes's Privateer, and 3. Pendleton's Violet, Sir J. G. Cotterell. Green-edged Auriculas: 1. Grimmes's Prince of Wales, Mr. Godsall; 2. Gorton's Champion, Sir J. G. Cotterell; 3. Rider's Junius, Mrs. Parkinson. Self Auriculas: 1. Redman's Metropolitan, Mr. Godsall. Alpine Auriculas: 1. and 2. Seedlings, Mrs. Parkinson. Polyanthuses: 1, 2, and 3. Unknown, Mrs. W. Pateshall. Double Blue Hyacinths: 1. Lord Wellington, Sir J. G. Cotterell; 2. Porcelain, Mr. Nott. Double Red Hyacinths: 1. Groot Vorst, and 2. Unknown, R. J. Powell; 3. Aimable Rosette, Mrs. H. Morgan; 4. Constante, Mr. Godsall. Double White Hyacinths: 1. Minerva, and 2. Aimable Blanche, Mrs. H. Morgan; 3. Grand Magnificent, Sir J. G. Cotterell. — *Fruit.* Dessert Apples: 1. Unknown, Sir J. G. Cotterell; 2. Manchester Pippin, Mrs. J. Phillips. — *Culinary Vegetables.* French Beans, C. G. Cooke, Esq. Asparagus: 1. Sir J. G. Cotterell; 2. Mr. Godsall. Sea-kale, Sir J. G. Cotterell. Rhubarb, Sir J. G. Cotterell. White Broccoli, J. S. Gowland, Esq. Brown Purple Broccoli, J. S. Gowland, Esq. Cucumbers: 1. T. C. Bridges, Esq; 2. Sir J. G. Cotterell. Mushrooms, R. J. Powell, Esq. Potatoes, Sir J. G. Cotterell. Lettuce, J. S. Gowland, Esq. Cabbage, Sir J. G. Cotterell. (*Hereford Journal*, May 6. 1829.)

*Ross Horticultural Society.* — The twenty-first show of this flourishing institution took place on Wednesday the 29th ult., and notwithstanding the late unprecedented cold and boisterous weather, the exhibition proved

the elements had not prevailed against the known skill and active perseverance of the Ross florists. The morning was ushered in by cold winds with snow, which, however, did not prevent the accustomed attendance of a distinguished and fashionable company, who unanimously evinced astonishment at the extraordinary display of miscellaneous stove, green-house, and hardy plants on the grand stand, which produced a most cheering effect; and great attention was excited by an *Acácia armàta*, and a *Cactus speciòsa*, exhibited by the gardener of John Cooke, Esq. The stage of auriculas was not so well filled as usual; but the flowers were generally good and in prime bloom and truss, though some, from weakness in the stalks and want of colour, showed forcing. Upwards of 100 pots of this our favourite flower, we heard, were at home, just showing for bloom. The polyanthuses were not numerous, but were in good condition; and the hyacinths, we think, exceeded any previous show in number and quality. — The table was well covered with fine broccoli, sea-kale, and cabbages; the latter reminded us of July. There were many plates of apples in good preservation, and a plate of fine strawberries from Mrs. Westfaling's evinced the skill of her gardener, Mr. Bresse. Several florists proposed that the prizes next year should be extended to pansies, from the extraordinary specimens exhibited of this interesting flower, sixteen varieties being furnished by the Rev. W. H. Hill. The number of specimens ticketed and entered into the Society's books amounted to 425, and the evening sale of vegetables and fruits, not removed, amounted to 1*l.* 16*s.* 8*d.* The prizes were awarded as under : —

*Flowers.* Green-edged Auriculas: 1. Howarth's Nelson, 2. Pollitt's Highland Laddie, and 3. Moore's Jubilee, Mrs. Westfaling; 4. Thornicroft's Invincible, Rev. R. K. Holder; 5. Stretch's Alexander, Mrs. Westfaling. Grey-edged Auriculas: 1. Popplewell's Conqueror, Col. Money; 2. Rider's Waterloo, Mr. Reynolds; 3. Grimes's Privateer, 4. Hayes's Lovely Anne, and 5. Kenyon's Ringleader, Mrs. Westfaling. White-edged Auriculas: 1. Taylor's Glory, and 2. Scholes's Mrs. Clark, Mrs. Westfaling; 3. Hughes's Pillar of Beauty, Rev. R. K. Holder; 4. Taylor's Incomparable, and 5. Potts's Regulator, Mrs. Westfaling. Self Auriculas: 1. Bury's Lord Primate, Mr. Reynolds; 2. Flora's Flag, Mrs. Westfaling; 3. Grand Turk, Mr. Reynolds; 4. Carding's Forrester, Col. Money; 5. True Blue, Mrs. Westfaling. Alpine Auriculas: 1. Magnet, and 2. Breese's Velvet Cushion, Mrs. Westfaling; 3. Johnson's Lady Duncan, Col. Money; 4. Doctor Whiting, and 5. Rudhall Ranger, Mrs. Westfaling. Dark Polyanthuses: 1. Pearson's Alexander, Col. Money; 2. Pride of Archenfield, Mrs. Westfaling; 3. Fillingham's Tantarara, and 4. Turner's Emperor, Col. Money; 5. Unknown, Mrs. Platt. Red Polyanthuses: 1. The Man of Ross, and 2. Breese's Seedling, Mrs. Westfaling; 3. Oxford Foxhunter, 4. Stretch's Defender, and 5. Groom's Lord Dudley, Col. Money. Double Blue Hyacinths: 1. Lord Wellington, Mr. Reynolds; 2. Bailief de Amsterdam, Mrs. Westfaling; 3. Prins Henri, W. Gillman, Esq.; 4. Globe Celeste, Mrs. Westfaling; 5. L' de Mitre, W. Gillman, Esq. Double Red Hyacinths: 1. Honneur de Amsterdam, Mr. Reynolds; 2. Triumph Blondina, Mrs. Westfaling; 3. Groot Vorst, K. Evans, Esq.; 4. Waterloo, and 5. Temple d'Apollo, Mrs. Westfaling. Double White Hyacinths: 1. Prins Van Waterloo, Mr. Reynolds; 2. Minerva, Mrs. Westfaling; 3. Heroine, Mr. Reynolds; 4. Comte de Berri, Mrs. Westfaling; 5. Glòria Flòrum, W. Gillman, Esq. — *Plants.* Stove or Green-house: 1. *Acácia armàta*, and 2. *Cactus speciòsa*, J. Cooke, Esq.; 3. *Amarýllis vittàta*, Mrs. Westfaling; 4. *Elichrysùm*, J. Cooke, Esq.; 5. *Lachenàlia tricolor*, W. Gillman, Esq.; Hardy: 1. *Kálmia gláuca*, Mrs. Westfaling; 2. *Azàlea sinénsis*, J. Cooke, Esq.; 3. *Dáphne Cneòrum*, Mr. Reynolds; 4. *Linum flàvum*, Miss Trusted; 5. *Ulex flore plèno*, Mr. Reynolds. — *Fruit.* Dessert Apples: 1. Nonpareil, Col. Money; 2. Russet, Mr. Reynolds; 3. Loan's Pearmain, 4. Golden

Moile, and 5. Old Brandy, Col. Money. — *Culinary Vegetables.* Sea-kale: 1. Mr. Reynolds; 2. Col. Money; 5. C. B. M. Johnston, Esq.; 4. K. Evans, Esq.; 5. J. Cooke, Esq. White Broccoli: 1. and 2. Mrs. Westfaling; 5. C. Biss, Esq.; 4. Mrs. Westfaling; 5. R. Compton, Esq. Brown or Purple Broccoli: 1. and 2. Mrs. Platt. Cabbages: 1. Mr. T. E. Jones; 2. R. Compton, Esq.; 3. Mr. T. E. Jones; 4. J. Cooke, Esq.; 5. Mr. T. E. Jones. (*Hereford Journal*, May 6. 1829.)

## YORKSHIRE.

*Yorkshire Horticultural Society.* — The first Spring Meeting of this Society was held on May 6., at the Music Hall, Leeds, and was most numerously and fashionably attended. At two o'clock, the Rev. J. A. Rhodes, of Horsforth Hall, was called to the chair, who opened the business of the meeting with an appropriate address; and in distributing the following prizes, he addressed the prize-men with his usual felicity of language: —

*Fruit.* Pines: 1. Ralph Hopps, gardener to William Gott, Esq., of Leeds; 2. William Ashton, gardener to Benjamin Gaskell, Esq., of Thornes House. Black Grapes: 1. James Brown, gardener to John Hebblethwaite, Esq., of Leeds; 2. Ralph Hopps. White Grapes, Thomas Appleby, gardener to the Rev. J. A. Rhodes, of Horsforth Hall. Cherries, William Ashton. Strawberries and Peaches, William Appleby. Apples, William Ashton. — *Culinary Vegetables.* Lettuce, A. Whitelock, gardener to Colonel Arden, of Pepper Hall, near Northallerton. Cabbage, Samuel Currie, gardener to J. Ingham, Esq., Blake Hall, near Mirfield. Broccoli: 1. Joseph Marshall, of Rothwell Haigh; 2. Mr. Baines, gardener to Messrs. Backhouse, of York. Curled Cole, Joseph Marshall. Potatoes, Joseph Deuxberry, gardener to Abram Rhodes, Esq., of Roundhay. Mushrooms, William Campbell, gardener to Henry Teale, Esq., of Stourton Lodge. Sea-kale, George Trotter, gardener to C. J. Brandling, Esq., Middleton Lodge. Asparagus: 1. Samuel Currie; 2. David Smith, gardener to A. Peterson, Esq., of Wakefield. Kidneybeans: 1. William Campbell; 2. T. Appleby. Cucumbers: 1. James Brown; 2. William Ashton. Rhubarb: John Catton, gardener to Benjamin Sadler, Esq., of New Laiths. — *Plants.* Geraniums: 1. Thomas Haselgrave, of Wakefield; 2. Josh. Marshall; 5. Josh Moore, gardener to T. B. Pease, Esq., of Chapel Allerton. Exotic, *Strophanthus dichotomus*, James Brown. Exotic Bouquet, James Brown. Hardy Bouquet, William Clark. Exotic Heath, John Taylor. Hardy Heath, William Clark. — *Flowers.* Hyacinths, H. Baines, gardener to Messrs. Backhouse, of York. Green-edged Auriculas: 1. Colonel Taylor, Mr. James Spence; 2. Waterloo, Mr. E. Fletcher; 5. Prince Leopold, Mr. William Hudson. Grey-edged Auriculas: 1. Privateer, Mr. John Beeston; 2. Ringleader, and 5. Complete, Mr. Spence. China-edged Auriculas: 1. Venus, Mr. Robert Jackson; 2. Rule-all, Mr. Spence; 5. Conqueror, Mr. Wood. Self Auriculas: 1. Metropolitan, and 2. Flora's Flag, Mr. B. Eli; 5. Lord Lee, Mr. E. Fletcher. Alpine Auriculas: 1. Seedling, Mr. B. Eli; 2. Seedling, Mr. John Beeston; 5. Seedling, Mr. W. Riley. Polyanthus: 1. Pearson's Alexander, Mr. Clark; 2. Cox's Prince Regent, Mr. W. Wood; 5. Yorkshire Regent, Mr. B. Eli.

Premiums were also awarded to Mrs. Kennedy of North Hall, to Joseph Moore, to Joseph Marshall, to Thomas Appleby, and Mr. Haselgrave, for Plants, &c. for the decoration of the room. Among the decorations we noticed the two following trees: the *Acacia armata*, in full foliage and flower, and a fine orange tree in full bearing.

Mr. Leah, a nurseryman, at Warley, near Halifax, produced an improved hoe, by using of which one half the expense of the common hoe would be done away. [We shall be much obliged to Mr. Leah to send us some account of this hoe, and to state where it may be purchased.] The attention of the meeting was called to a beautiful *Pæony*, produced by Mr.

Haselgrave, of Wakefield. Mr. James Brown, gardener to John Hebblethwaite, Esq., was then called, and the Rev. Chairman, after a highly complimentary address, presented to him the London Horticultural Society's medal for 1827, he having obtained more prizes than any of his Yorkshire competitors. Thomas Deuxberry, gardener to Henry Preston, Esq., of Moorby, near York, was then called, and informed by the Chairman that the Council having ascertained that the prizes which he had obtained were so decidedly superior in number and quality to those of any other competitor, they deemed it their duty to assign to him the next medal of the London Horticultural Society. He also stated that the next to him, in point of number, was Mr. William Ashton.

The Chairman, after expressing the obligations of the Society to the gardeners, bade the ladies and gentlemen very heartily farewell.

The thanks of the meeting were voted to the Rev. J. A. Rhodes, for his able conduct in the chair.

Judges of Fruit: The Rev. Mr. Morris, of Wakefield; Mr. James Jamieson, gardener to Lady Beckett, of Gledhow; and Mr. George Tyson, gardener to Geo. Banks, Esq., of Leeds. Judges of Auriculas: Mr. Joseph Barstow, Mr. John Leadbeater, and Mr. W. Clark.

It was announced that the June Meeting will be held in the Music Saloon, Wakefield, on Wednesday, the 3d of June; the Summer Meeting in the Festival Concert Room, York, on Wednesday, the 1st of July. (*Yorkshire Gazette*, May 9.)

*Ancient York Florists' Society.*—This Society held their annual Show of auriculas, polyanthuses, and hyacinths in Petergate on May 4. The prizes were adjudged as follows:—

Green Auriculas: 1. Stretch's Alexander, Mr. William Hardman; 2. Pollitt's Highland Boy, Mr. Wilson; 3. Pollitt's Highland Boy, Mr. W. Hardman; 4. Howard's Nelson, Mr. Wilson; 5. Wood's Lord Lascelles, Mr. Summer. Grey Auriculas: 1. Grimes's Privateer, and 2. Warris's Union, Mr. Parker; 3. Kenyon's Ringleader, Mr. W. Hardman; 4. B. and S.'s Alexander, Mr. Wilson; 5. Grimes's Privateer, Mr. William Hardman. China Auriculas: 1. Taylor's Glory, Mr. Parker; 2. Popplewell's Conqueror, Mr. Summer; 3. Leigh's Venus, Mr. Parker; 4. Taylor's Glory, and 5. Taylor's Incomparable, Mr. W. Hardman. Self Auriculas: 1. Lister's Seedling, Mr. Summer; 2. Grand Turk, 3. Hey's Apollo, 4. Clark's Seedling, and 5. Clark's Seedling, Mr. Parker. Alpine Auriculas: 1. New Captain Frazer, Mr. Wilson; 2. Hardman's Seedling, Mr. Hardman; 3. Alpine King, Mr. Wilson; 4. Seedling, No. 17., and 5. Seedling, No. 11, Mr. W. Hardman. Polyanthuses: 1. Seedling, Mr. Summer; 2. Tantarara, Mr. Parker; 3. Cox's Regent, Mr. Summer; 4. and 5. Cox's Regent, Mr. Parker. Hyacinths: 1. Groot Voorst, Mr. Summer; 2. Pasquin, Mr. Parker; 3. Groot Voorst, Mr. Summer; 4. Groot Voorst, Mr. Wilson; 5. Groot Voorst, Mr. Rigg. (*Yorkshire Gazette*, May 9.)

#### NORTHUMBERLAND AND DURHAM.

*Botanical and Horticultural Society of Durham, Northumberland, and Newcastle upon Tyne.*—At a Meeting of this Society, held on the 10th of April, the following prizes were awarded:—For the best dish of dessert apples, of sorts named, the silver medal to Mr. N. Billaw, gardener to the Rev. Joseph Cook, Newton Hall, near Alnwick. For the best dish of baking apples, the silver medal, and for the best six heads of spring broccoli, the bronze medal, to Mr. Thomas Pearson, gardener to Isaac Cookson, jun., Esq., Park House. For the best quart of early potatoes (Egyptian kidneys), the silver medal to Mr. John Gledston, gardener to William Orde, Esq., Nunnikirk. For the best brace of cucumbers, the silver medal to Mr. Hugh Robson, gardener to Charles Bacon, Esq., Styford. For the best six early cabbages, the bronze medal to Mr. William Grey, gardener



to Thomas James, Esq., Beaufront. For the best six stalks of blanched rhubarb, the bronze medal to Mr. James Tindal, gardener to Sir C. M. Monck, Bart. For the best exotic plant (*Pultenæa stricta*), in flower, the silver medal to Mr. Adam Hogg, at Messrs. Falla and Co.'s, Gateshead. For the best bouquet of flowers, the silver medal to Mr. James Lawson, gardener to C. Blackett, Esq., Wylam. The exhibition was particularly fine, especially the apples, of which there were twenty-five dishes exhibited, in the highest state of preservation; and the bouquets of flowers were most beautiful, indeed surprisingly so, considering the very unfavourable weather we have had so long. (*Newcastle Courant.*)

At a *General Meeting of the same Society*, held on May 8., at Mr. Dodsworth's, the Queen's Head Inn, Newcastle, the following prizes were awarded: — For the best auricula (*Page's Champion*), the silver medal to Mr. James Scott, gardener to Edward Charlton, Esq., Sandoe. For the best seedling auricula (named Lord Eldon), the silver medal to Mr. John M'Queen, gardener to S. W. Parker, Esq., Scot's House. For the best double hyacinth named (*Groot Voorst*), the silver medal to Mr. John Moderill, gardener to J. C. Anderson, Esq., Point Pleasant. For the best single hyacinth (named *Lyra*), the silver medal to Mr. James Fenwick, gardener to John Anderson, Esq., Jesmond. For the best polyanthus (named *Barkas's Bonny Bess*), the bronze medal to Mr. Adam Hogg, at Messrs. Falla and Co.'s, Gateshead; who also gained the bronze medal for the best seedling polyanthus, which he named *May-Day*. For the best twenty-five heads of asparagus, the silver medal to Mr. Thomas Watson, gardener to James Kirsopp, Esq., Spital, near Hexham. For the best six lettuces, the bronze medal to Mr. Cook, gardener at Bradley Hall. For the best exotic plant in flower (*Erythrina Crista-Galli*), the silver medal to Mr. William Lawson, gardener to Matthew Bell, Esq., Woosington. For the best bouquet of flowers, the silver medal to Mr. James Lawson, gardener to C. Blackett, Esq., Wylam. Three extremely fine specimens of *Cactus speciosa* were exhibited from the gardens of Matthew Bell, Esq., D. Cram, Esq., and James Losh, Esq.; a magnificent specimen of *Epacris grandiflora*, from the garden of John Anderson, Esq., Jesmond; a beautiful dish of fine ripe Roseberry strawberries, from A. Donkin, Esq.; and two fine blossoms of Yellow Chinese roses, from H. Hewitson, Esq., Seaton Burn. The exhibition of flowers and plants was very attractive, especially the double hyacinths, which were extremely fine, and in great profusion. (*Newcastle Courant*, May 9. 1829.)

*The Vegetable and Florist Society of Howdon Dock* held their first Show on May 9., when the following flowers and vegetables were exhibited, and adjudged as follows, viz.: — *Flowers.* Auriculas: 1. Metcalf's Lancashire Hero, and 2. Mills's Lord Bridport, Mr. John Reay; 3. Charlton's Earl Percy, Mr. Wm. Hall; 4. Pennington's Violet, Mr. James Carr; 5. King Charles the Twelfth of Sweden, Mr. R. Hudson. Hyacinths: 1. Negro of Tyne, Mr. John Reay; 2. Groot Voorst, Mr. Robert Hudson; 3. Lord Eldon, Mr. James Carr; 4. Princess Sophia, Mr. A. R. Weldon; 5. Trafalgar, Mr. Thomas Hepple. Polyanthus: 1. Morris's Fancy, Mr. John Reay; Barkas's Bonny Bess, Mr. Thomas Heppell; 3. May Garland, Mr. Robert Hudson; 4. Barkas's Bonny Bess, Mr. William Hall; 5. Jack upon Horseback, Mr. James Carr. — *Vegetables.* Leeks: 1.  $9\frac{3}{4}$  in. in circumference, Mr. A. R. Weldon; 2. 9 in. in circumference, Mr. John Reay; 3.  $8\frac{1}{2}$  in. in circumference, Mr. William Hall; 4.  $8\frac{1}{4}$  in. in circumference, Mr. James Carr; 5. 7 in. in circumference, Mr. Robert Hudson. (*Newcastle Chronicle*, May 16.)

*The Davy Inn Florist Show* was held on May 9., and the prizes were adjudged as follows: — *Auriculas:* 1. Grimes's Privateer, 2. Pendleton's Violet, and 3. Whittaker's Rule-all, Mr. James Morris; 4. Gorton's Champion of England, Mr. Wm. Armstrong; 5. Charles's Earl Grey, Mr. John Morris.

*Polyanthuses*: 1. Barkas's Bonny Bess, 2. Alice Losh, and 3. Phillingham's Tantarara, Mr. James Morris; 4. Gold-edged Beauty, and 5. White-edged Incomparable (seedlings), Mr. William Armstrong. *Hyacinths* (Double): 1. Groot Vorst, 2. Pasquin, 3. Labien Amis, 4. Marquis de Vere, and 5. Agatha Catharine, Mr. James Morris. Single: 1. Lyra, Mr. William Armstrong; 2. L'amie de Vere, Mr. James Morris; 3. Bouquet Parfait, and 4. Brutus, Mr. William Armstrong; 5. Mrs. Hatherick, Mr. Tobias Holt. The hyacinths were very fine, and gave great pleasure to the numerous visitors who honoured the exhibition with their presence. (*Newcastle Chron.*, May 16.)

The *Morpeth Florist Society* held their annual Show of auriculas, polyanthuses, and hyacinths, on May 7., when the following prizes were awarded: — *Auriculas*: 1. Salter's Garland, Mr. R. Lewins; 2. Charlton's Earl Percy, 3. Riding's Junius, Mr. R. Lewins; 4. Metcalf's Lancashire Hero, Mr. E. Noble; 5. Wild's Lord Bridport, Mr. R. Lewins. *Polyanthuses*: 1. Barkas's Bonny Lass, Mr. R. Lewins; 2. Hall's Eliza, and 3. Mitford Castle, Mr. Mitchell; 4. Cox's Prince Regent, Mr. E. Noble; 5. Pearson's Alexander, Mr. John Dixon. *Hyacinths*: 1. Buonaparte, Mr. J. Hindhaugh; 2. Bouquet Tendre, and 3. Comte de St. Priest, Mr. Kingsley; 4. Lord Wellington, Mr. R. Lewins; 5. Prince of Waterloo, Mr. Kingsley. (*Ibid.*)

The *Bedlington Florist Society* held their first Meeting for the season on May 11., when the following prizes were adjudged: — *Auriculas*: 1. Gorton's Champion, Mr. John Graham; 2. Mallard's Charles Grey, Mr. Robt. Hay; 3. Schofield's Hebe, Mr. John Johnston; 4. Hughes' Pillar of Beauty, Mr. John Cotes. *Polyanthuses*: 1. Lee's Miss Ann, Mr. John Cotes; 2. Princess Charlotte, Mr. Robert Hoy; 3. Cotes's Black Prince (seedling), Mr. John Cotes; 4. The Pitman's Waistcoat, and 5. Hall's Eliza, Mr. Robt. Hoy. (*Ibid.*)

The *Union Florists of Bishopwearmouth and its Vicinity* held their annual Show of auriculas and hyacinths, at Mr. Sutton's, Hendon tavern, on Monday last, when the prizes were adjudged as follows: — *Auriculas*: 1. Crass's Lord Wellington, Mr. Thomas Davison; 2. Pendleton's Violet, Mr. Harrop; 3. Clough's Dolittle, Mr. Thomas Davison; 4. Riding's Violet, and 5. Moor's Jubilee, Mr. Harrop. *Hyacinths*: 1. Groot Voorst Grand Duc, Mr. Harrop; 2. Gloria Mundi, Mr. Davison; 3. Josephine, Mr. Potts; 4. Anna Marie Superb, Mr. Harrop; 5. Le Brilliant très-grand, Mr. Potts. (*Ibid.*)

The *King Street Florist Society* held their annual Show of auriculas on May 8., in Newcastle, when the prizes were adjudged as follows: — 1. Wilson's Duchess of Northumberland, Mr. Thomas Pearson; 2. Wilson's Rule-all, Mr. John Wilson; 3. Page's Champion, Mr. Thomas Pearson; 4. Warris's General Blucher, Mr. Matthew Bates; 5. Gorton's Champion of England, Mr. John Lister. (*Ibid.*)

#### LANCASHIRE.

*Liverpool Floral and Horticultural Society.* — The first Show of flowers, fruits, esculents, and green-house plants for the present year took place on April 30. Notwithstanding the backwardness and severity of the season, the influence of which was manifest in the appearance of many of the flowers and plants, the show was one of considerable excellence. Several of the auriculas were in very fine condition; a better show of hyacinths has seldom been witnessed; many of the stove and green-house plants, and some of the specimens of heaths, excited general admiration; finer dishes of sea-kale, celery, and mushrooms are rarely to be met with; and several of the pines were of a high degree of excellence; one in particular sent by Mr. Pole, of Harding, to which the third prize was awarded, was exceedingly fine, and it was a subject of regret with the Committee

that it should have been precluded from the first prize by the rules, not being furnished by an annual subscriber. Prizes were awarded as follows :—

First Premier Prize: Freedom Ringleader, S. Ogden, Manchester. Second Premier Prize: Privateer Ringleader, R. F. Buckley, Esq. — *Flowers.* Green-edged Auriculas: 1. Stretch's King, Samuel Ogden; 2. Freedom, Mr. Faulkner; 3. Waterloo, Samuel Ogden; 4. Colonel Taylor, Mr. Morris; 5. Blucher, Mrs. Rathbone; 6. Smith's Alexander, and 7. Pollet's Ruler, B. Bruce. White-edged Auriculas: 1. Venus, Mr. Morris; 2. Pillar, Mr. Horsfall; 3. Glory, Mr. Gandy; 4. Favourite, and 5. Wood's Delight, Mr. Morris; 6. Mrs. Clarke, Mrs. Rathbone; 7. Maid of the Mill, B. Bruce. Grey-edged Auriculas: 1. King Lear, and 2. Privateer, Samuel Ogden; 3. Davis, Prince of Wales, Mr. John Leigh; 4. Bang-up, 5. Revenge, 6. Seedling, and 7. Rule-all, Mr. Morris. Self-coloured Auriculas: 1. Apollo, Samuel Ogden; 2. Flora's Flag, Richard Newsham, Wigan; 3. True Blue, R. F. Buckley, Esq.; 4. Stadtholder, R. Newsham; 5. Lord Lee, R. F. Buckley; 6. Othello, Mr. Morris; 7. Goldfinch, Mrs. Rathbone. Shaded Self Auriculas: 1. Unknown, Mr. Powell; 2. Unknown, W. Smith, Esq., Fulwood; 3. Queen of May, Mr. Gandy; 4. Polycarp, Mr. Faulkner; 5. Primula, Mr. John Astley; 6. Unknown, Mr. Powell; 7. Seedling, W. Smith, Esq., Fulwood. Polyanthus: 1. Emperor, Mrs. Cropper; 2. Cox's Regent, John Leigh; 3. Stranger, Mr. Boardman; 4. Countess of Derby, William Large; 5. Defiance, Mr. Boardman; 6. Green Lass, B. Bruce; 7. Emperor, Mr. Faulkner; 8. Sir George Monkton, B. Bruce. Baskets of Cut Flowers: 1. Mr. Whalley; 2. T. F. Dyson, Esq. Baskets of Flowers: 1. W. Earle, Esq.; 2. Mr. W. Whalley; 3. T. F. Dyson, Esq. *Maiden Shows:* Seedling Auricula, Samuel Ogden; Green-edged Auricula, Waterloo, Mr. Horsfall; White-edged Auricula, Admiral, Mr. John Leigh; Grey-edged Auricula, Venus, Mr. Horsfall; Self-coloured Auricula, Ned Ludd, Mr. John Leigh. Double Red Hyacinths: 1. Mr. Whalley; 2. Mr. Skirving; 3. W. Earle, Esq.. Double Blue Hyacinths: 1. Mrs. Rathbone; 2. Mr. Christopherson; 3. Mr. Whalley. Double Yellow Hyacinths: 1. W. Earle, Esq.; 2. Mr. Whalley; 3. Mr. Faulkner. Double White Hyacinths: 1. W. Earle, Esq.; 2. Mr. Whalley; 3. Mr. Powell. Single Red Hyacinths: 1. and 2. Mr. Faulkner; 3. Mr. Tayleure. Single Blue Hyacinths: 1. Mr. Tayleure; 2. Mr. Christopherson; 3. Mr. Faulkner. Single Blue Hyacinths: 1. Mr. Whalley; 2. Mr. Faulkner; 3. Mr. Whalley. — *Plants.* Stove: 1. *Cyrtopodium Andersonii*, and 2. *Brassica maculata*, Richard Harrison; 3. *Cactus speciosissima*, Mrs. Colquitt; 4. *Cactus speciosa*, Mr. Smith, Knowsley; 5. *Ixora coccinea*, Mr. Davis; 6. *Cattleya Forbessæ*, Arnold Harrison; 7. *Erythrina crista galli*, Mr. Davis; 8. *Crinum giganteum*, Mr. Horsfall. Green-house: 1. *Azalea indica alba*, Mr. Davis; 2. *Acacia armata*, Samuel Woodhouse; 3. *Calceolaria corymbosa*, Arnold Harrison; 4. *Correa speciosa*, Mrs. Rathbone; 5. *Arbutus canariensis*, Samuel Woodhouse; 6. *Epacris grandiflora*, T. F. Dyson, Esq.; 7. *Metrosideros lanceolata*, Mr. Dobson; 8. *Grevillea rosmarinifolia*, Mr. Davis. Ericas: 1. Hartnell, Mr. Whalley; 2. Odorata, H. Wilson, Esq.; 3. Propendens, 4. Eximia, 5. *Echiflora superba*, and 6. *Primuloides*, Mr. Whalley; 7. *Vestita Rosea*, W. Earle, Esq.; 8. *Nigrita*, Mr. Whalley. Herbaceous: 1. *Lithospermum pulchrum*, Mr. Skirving; 2. *Arum Dracunculus*, Thomas Case, Esq.; 3. *A'rabis hesperidifolia*, W. Smith, Esq.; *Lithospermum dauricum*, Mr. Skirving; 5. *Primula cortusoides*, Mr. Powell; 6. Double White Primrose, Mr. Davis. — *Culinary Vegetables.* Cucumbers: 1. Mr. Smith, Knowsley; 2. Mr. William Barton; 3. Mr. Smith; 4. Mr. Roskell. Asparagus: 1. W. Smith, Esq., Fulwood; 2. Mr. Whalley; 3. Mrs. Rathbone; 4. Mr. Roskell. Lettuce: 1. Ashton Yates, Esq.; 2. and 3. Mr. Davis. Rhubarb: 1. Mr. Horsfall; 2. W. Earle, Esq.; 3. Mr. Horsfall; 4. O. Heyworth, Esq. Kidneybeans: 1. T. F. Dyson, Esq.; 2. and 3. Mr. Smith,

Knowsley; 4. T. Case, Esq. Potatoes: 1. Mrs. Earle, Spekeland; 2. Mr. Skirving; 3. and 4. Mr. W. Barton. Sea-kale: 1. W. Smith, Esq., Fulwood; 2. T. Case, Esq.; 3. Ashton Yates, Esq.; 4. Mr. Logan. Mushrooms: 1. Mr. W. Barton; 2. W. Earle, Esq. Broccoli: 1. Mrs. Cropper; 2. Ashton Yates, Esq.; 3. Mr. Manifold; 4. Mr. Whalley. Cabbage: 1. Mrs. Rathbone; 2. Mr. Whalley; 3. Mrs. Rathbone; 4. W. Smith, Esq., Fulwood.—*Fruit*. Apples: 1. Jubilee, Mrs. Earle, Spekeland; 2. Holland Pippin, Mr. Dobson; 3. Unknown, Mr. Irlam; 4. Warham Russet, Mr. Roskell. Pears: Spring Beure, Mr. Manifold. Black Grapes: 1. Hamburgh, Mr. Johnston; 2. Mr. Roskell; 3. Mr. Johnston, Prescott. Pines: 1. Enville, Mr. Smith, Knowsley; 2. Unknown, Mr. Powell; 3. Jamaica, Mr. Pole, Harding. Strawberries: 1. W. Smith, Esq., Fulwood; 2. Mr. Davis. Nuts: Mr. Whalley.—*Extra-Prizes*. *Musa coccinea*, Mr. Powell; *Solandra grandiflora*, C. Lawrence, Esq.; *Thunbergia alata*, Mr. Skirving; *Panocratium calathinum*, Richard Harrison; *Erica arborea*, Miss Waterhouse; Damsons, growth of 1827, Mrs. Grandy; Lemons, Robert Sherbourne, Esq.; Tantarara, Mr. Manifold; Pelargoniums, Thomas Walker; *Kalmia latifolia*, *Rhododendron ferrugineum*, *Kalmia glauca*, and *Azalea* copper-coloured, Mr. Skirving; Baskets of Plants, Mr. Powell, O. Heyworth, Esq., W. Earle, Esq., and Mr. Skirving; *Cineraria cruenta*, Mrs. Rathbone. (*Liverpool Chron.*, May 2, 1829.)

*Floral and Horticultural Society of Manchester*.—The first spring Show of this Society was held April 24. The display was more extensive and more excellent than any former first show. Prizes were awarded as follows:—

*Flowers*. A premier prize of silver plate, value 5*l.* 5*s.*, for the best pan of four Auriculas, Highland Laddy, Ringleader, Hey's Apollo, and Bright Venus, was awarded to Mr. Colonel Lee, a countryman from near Rochdale. Self-coloured Auriculas: 1. Metropolitan, T. H. Hadfield, Esq.; 2. Lord Lee, James Parry. White-edged Auriculas: 1. Chancellor, Mr. Colonel Lee; 2. Wood's Delight, Thomas Clegg. Grey-edged Auriculas: 1. Ringleader, James Parry; 2. Privateer, Mr. Colonel Lee. Green-edged Auriculas: 1. Booth's Freedom, Richard Potter, Esq.; 2. Colonel Taylor, William Bow, Esq. Dark-ground Polyanthuses: 1. Lord Crewe, and 2. Bang Europe, Harry Thomas. Red Polyanthuses: 1. New York, and 2. Turner's Princess, Harry Thomas. Double White Hyacinths: Unknown, Chris. Todd, Esq. Double Pink Hyacinth, and Double Blue Hyacinth, Mr. James Falkner. Double Red Hyacinth, Mr. J. Whitworth. Basket of Flowers: 1. and 2. R. Potter.—*Plants*. Two best Stove Plants: Premier Prize of a piece of plate, value 3*l.* 5*s.* (*Musa coccinea* and *Pavetta indica*), Richard Potter, Esq. Stove: 1. *Amaryllis Johnsoni*, Mrs. Hobson; 2. *Cactus speciosissima*, J. Gibson. An extra-premium was given for a coffee plant, sent by William Garnet, Esq., of Lark Hill. Green-house: 1. *Chorizema Henchmannii*, and 2. *Boronia serrulata*, Mrs. Hobson. *Ericæ*: 1. *Cristata Major*, and 2. *Echiflora*, N. Phillips, Esq. Geranium, Victory, R. Potter, Esq. Herbaceous: 1. *Trillium grandiflorum*, E. Leeds, Esq.; 2. W. Garnet, Esq. Hardy Shrubs: 1. *Pæonia arborea*, Rev. J. Clowes; 2. *Magnolia conspicua*, W. Garnett, Esq.—*Fruit*. Pine: 1. and 2. R. Potter, Esq. Grapes (best bunch), Peter Marsland, Esq.—*Culinary Vegetables*. Asparagus: 1. T. J. Trafford, Esq; 2. Charles Wood, Esq. Cucumber, C. Walker, Esq. Sea-kale, W. Garnett, Esq. Mushrooms, Earl of Wilton. New Potatoes, T. Marsland, Esq. French Beans, James Brierley, Esq. Rhubarb, William Thompson, Esq. Cabbage, F. Bailey, Esq.—Extra-premiums were given for strawberries to George Scholes, and for apples to Sam. Lees and James Falkner, Esqs. (*Manchester Gazette*, April 25, 1829.)

*Bolton Floral and Horticultural Society*.—The first Meeting for the season of this Society took place on April 29. Notwithstanding the

backwardness of the season, the exhibition of auriculas, polyanthuses, stove, green-house, and herbaceous plants, fruits, &c., was far superior to that of any former year, but more especially in green-house plants. The flowers and plants were arranged with great taste, and a Chinese orange-tree, bearing fruit, and a *Cycas revolùta*, furnished by Joseph Ridgway, Esq., of Ridgmont, were much admired. Prizes were awarded as follows : —

A silver cup, value 2*l.* 2*s.*, the gift of Mr. James Mosley, for the best pan of four Auriculas (as in each class), was shown for by subscribers residing within five miles of Bolton, and awarded to William Hulton, Esq., of Hulton. A silver cup, value 2*l.*, the gift of the Society, for the best pan of four Auriculas (as in each class), was shown for by the whole of the subscribers, and awarded to John Morris, Esq., of Manchester. — *Flowers.* The best Auricula (Premier Prize), Do little, William Eckersley. Green-edged Auriculas : 1. Booth's Freedom, 2. Highland Lad, and 3. Barlow's King, Samuel Ogden; 4. Colonel Taylor, Roger Holland, Esq.; 5. Howard's Nelson, Matthew Gaskell; 6. Jolly Tar, and 7. Alexander, William Lomas. White-edged Auriculas : 1. Venus, John Morris, Esq.; 2. Taylor's Glory, William Lomas; 3. Seedling, William Hulton, Esq.; 4. Lord Chancellor, 5. Seedling, and 6. Rule-all, Samuel Ogden; 7. Favourite, John Morris, Esq. Grey-edged Auriculas : 1. Ringleader, William Hulton, Esq.; 2. Privateer, Henry Glover; 3. Waterloo, Samuel Ogden; 4. Bang-up, and 5. Revenge, John Morris, Esq.; 6. Seedling, William Crompton; 7. Unknown, Peter Morris. Self Auriculas : 1. True Blue, William Eckersley; 2. Othello, John Morris, Esq.; 3. Metropolitan, William Lomas; 4. Primate, Samuel Ogden; 5. Ned Lud, William Hulton, Esq.; 6. Lord Leigh, William Lomas; 7. Stadtholder, Roger Holland, Esq. Dark Polyanthuses : 1. Bang Europe, 2. Princess Royal, and 3. Prince Regent, William Hulton, Esq.; 4. Alexander, Richard Greenhalgh; 5. Defiance, Edward Ashworth, Esq.; 6. Queen Anne, and 7. George the Fourth, William Hulton, Esq. Red Polyanthuses : 1. Prince Regent, Edward Ashworth, Esq.; 2. Princess, and 3. Gold Lace, William Eckersley; 4. Heir at Law, and 5. Buonaparte, William Hulton, Esq.; 6. Talavera, William Lomas; 7. Seedling, William Hulton, Esq. — *Plants.* Stove : 1. *Alpìnia nùtans*, 2. *Amarýllis Johnsoni*, and 3. *Xylophýlla falcàta*, Edward Silvester, Esq.; 4. *Cymbídium aloifòlium*, Jos. Ridgway, Esq.; 5. *Ardísia crenulàta*, Ed. Silvester, Esq.; 6. *Thunbèrgia alàta*, Roger Holland, Esq. Green-house : 1. *Camèllia fimbriàta*, Roger Holland, Esq.; 2. *Acàcia verticillàta*, and 3. *Mýrtus tomentòsa*, Ed. Silvester, Esq.; 4. *Pultenæa stricta*, Roger Holland, Esq.; 5. *Epàcris grandiflòra*, Ed. Silvester, Esq.; 6. *Corræa speciòsa*, Roger Holland, Esq. Herbaceous : 1. *Orobùs vérnus*, Roger Holland, Esq.; 2. *Anemòne coronària*, Ed. Ashworth, Esq.; 3. *Linària alpina*, and 4. *Viola grandiflòra álba*, Roger Holland, Esq.; 5. *Prímula decòra*, Michael Potts. Hardy Shrubs : 1. *Pædonia arbòrea*, Jos. Ridgway, Esq.; 2. *Kálmia glauca*, and 3. *Rhodòra canadénsis*, Ed. Ashworth, Esq.; 4. *Andrómeda speciòsa*, William Hulton, Esq.; 5. *Azàlea póntica*, Ed. Ashworth, Esq. Geraniums : 1. *Macránthum*, Robert Barlow, Esq.; 2. *Lady Neive*, Richard Greenhalgh; 3. *Scarlet*, William Crompton, Esq.; 4. *Moore's Victory*, Roger Holland, Esq.; 5. *Pavoníum*, Robert Barlow, Esq. *Ericæ* : 1. *Vèrnix*, 2. *Walkèrri*, 3. *Cerinthòides*, 4. *Blandfórdia*, and 5. *Propéndens*, Roger Holland, Esq. — Best basket of Flowers, Jos. Ridgway, Esq. — *Fruit.* Pine : 1. and 2. Jos. Ridgway, Esq. — *Culinary Vegetables.* Cucumbers (best brace) : 1. Ed. Ashworth, Esq.; 2. William Hulton, Esq. Asparagus, Jos. Ridgway, Esq. French Beans, New Potatoes, and Rhubarb, William Hulton, Esq. — *Extra-Prizes.* *Pýrus japónicus*, Roger Holland, Esq.; *Erica herbàcea*, William Hulton, Esq.; Northern Green Apples, Edward Silvester, Esq.; Strawberries, Edmund Ashworth, Esq.; New Scarlet Geranium, B. Rawson, jun., Esq.; Sea-kale, Early Cabbage, and Celery, William Hulton, Esq.; Florentine Tulip, Brace of Hyacinths, and Narcissus, Charles Cragie; *Cycas*

revolùta, and Chinese Orange Plant, Jos. Ridgway, Esq.; Double White and Seedling Camellias, Roger Holland, Esq.; Wilton Rose, Edward Silvester, Esq. (*Bolton Chron.*, May 2. 1829.)

## DEVONSHIRE.

*Devonport Horticultural Society.* — The Annual Show of Auriculas and Polyanthuses took place on April 25., when prizes were adjudged to Messrs. Barret, Quicke, Harris, Colley, Jeffery, and Bennet. Some of the auriculas and polyanthuses attracted particular attention for their splendour and beauty. Among the exotics which were exhibited, we noticed a fine specimen of the flower of the *Solandra grandiflora*, and of the *Hibiscus rosa sinensis* var. *simplex*, from the valuable collection of E. Churchill, Esq. of the Royal Marines; some fine plants from the green-house of Charles Horn, Esq. of Stoke; and no less than fifty from the collection of our friend Mr. Pontey, whose zeal for the improvement of horticulture we have so frequently had occasion to notice; among these we remarked a singularly fine plant of the *Azalea indica* var. *alba*, with one of the *Erica aristata* major. (*Plym. Jour.* April 30. 1829.)

## SOUTH WALES.

*Glamorganshire, Monmouthshire, and South Wales Horticultural Society.* — The General Meeting and first public Show of this Society, which took place at Cardiff on April 1., proved highly creditable to the institution, and interesting both to the members and the public, who were admitted by a special vote, gratis, to this first combined effort of the infant Society. Upwards of 300 grafts of different sorts of new and most superior fruits, most liberally granted for the benefit of the Society and the public by the Horticultural Society of London, on the personal application of Mr. Moggridge, were distributed. Premiums were awarded as follows:—

*Fruit.* Baking Apples, Sir C. Morgan, Bart. — *Flowers.* Polyanthus (extra-prize), and Double Wallflower, R. Hill, Esq. Double Primroses, E. P. Richards, Esq. — *Culinary Vegetables.* Rhubarb, the Rev. J. M. Treharne. Cucumbers: 1. Hon. W. B. Grey; 2. R. F. Jenner, Esq. White Broccoli, R. Hill, Esq. Asparagus, J. M. Richards, Esq. Early Potatoes, and Radishes, R. Hill, Esq. Kidneybeans (extra-prize), and Sea-kale, Sir C. Morgan, Bart. Rhubarb, grown on the hills, Mr. Perkins, jun. — *Plants.* Best and most curious, J. Moggridge, Esq.; best and most beautiful, R. Reece, Esq. (*The Cambrian*, April 4.)

## ART. X. Domestic Economy.

*APPLES preserved till late in the Year.* — Sir, From the difficulty of preserving apples till late in the year, I was induced to try two methods recommended in *Practical Economy*: both promise to answer so well, and are so simple, that I recommend them to those of your readers who have not proper fruit-rooms. From our apples having been frosted, the jars were opened sooner than I intended; but from the sound state they are in, I have no doubt they would have kept till June. I regret I have not a specimen of those preserved in sand to send; but I forward some of those kept in a vacuum for your inspection.

*Directions.* After the apples have been kept for a week, and the superabundant moisture cleared away, wipe them with a dry cloth, and pack them into glazed jars in layers of sand dried in an oven. Fit a piece of wood into the mouth of the jar, and tie a bladder over it. Let the jars stand on a shelf in a room not subject to much change of atmosphere.

Or lay a dry layer of pebbles in the hollow of a glazed jar; fill the jar with apples rubbed dry; fit a piece of wood into the mouth of the jar, cover it with mortar, and place it on a shelf in a dry room. — *A Subscriber to the Gardener's Magazine.*

The five apples, received March 26., were as plump and fresh as if newly gathered; they were of handsome shapes, with a good deal of colour, and very well flavoured. We are not quite certain of their names. — *Cond.*

*To dress the Roots of Celeriac or Celerie Rave.* — The following is considered a cheap and an elegant mode. Pare the roots, and cut them into slices somewhat less than a quarter of an inch in thickness; then boil them gently till they are tender in some broth, or in water well seasoned, and a slice of butter added. When dished pour over them some melted butter, or *bechamel* sauce, which is made by thickening some broth and adding a little cream. Celeriac is cultivated at greater ease and at less expense than the common celery, and it may be used in the kitchen for seven or eight months in succession. — *J. Elles. Longleat Gardens, April 25. 1829.*

*French Method of making superior gooseberry and currant Wines.*—*For currant wine:* Eight pounds of honey are dissolved in fifteen gallons of boiling-water, to which, when clarified, is added the juice of eight pounds of red or white currants. It is then fermented for twenty-four hours, and two pounds of sugar to every two gallons of water are added. The preparation is afterwards clarified with the whites of eggs and cream of Tartar.

*For gooseberry Wine.*—The fruit is gathered dry when about half ripe, and then pounded in a mortar. The juice, when properly strained through a canvass bag, is mixed with sugar, in the proportion of three pounds to every two gallons of juice. It is then left in a quiet state for fifteen days, at the expiration of which, it is carefully poured off, and left to ferment for three months when the quantity is under fifteen gallons, and for five months when double that quantity. It is then bottled, and soon becomes fit for drinking.—(*Bibli. Physico-Econom.*)

---

## ART. XI. Retrospective Criticism.

*ERRONEOUS Statements respecting Mr. Knight's Communications to the Horticultural Society.* — Sir, I address the following letter to you, in consequence of having read, in your Gardener's Magazine, some very erroneous statements respecting the contents of several of my communications to the Horticultural Society of London; and, as I never wrote and as that Society never published the contradictious nonsense attributed to me, I point out some of those erroneous statements to you; a correction of which, I think, you owe to me and to that Society, and, in some degree, to the public.

You have stated in your Magazine for February (Vol. II. p. 88.), relative to the culture of the pine-apple, that your offence against the Horticultural Society of London, and the consequent rejection of your Gardener's Magazine, when offered as a present, proceeded from your having "felt rather too much delighted to have the evidence of Mr. Knight's present practice to prove that he was formerly wrong, and that we were and are right." Now, I must beg leave to tell you that you have not, and that you never had, any such evidence, and that your statement that I have changed my method of cultivating the pine-apple [We made no such statement: see note a.] is wholly unfounded, whoever may have been your informant. My pine-apple plants are cultivated just as they formerly were, and as I have stated them to have been cultivated in the *Transactions of the Horticultural Society of London*; and my success has not only answered, but it

has exceeded, my hopes. I am quite confident that I have never seen as many fine plants, or as much fine fruit, afforded, within the same time and space, as I have obtained, and which I have good reason to believe I shall obtain, in the present year. [See note *b.*] I have found that, by placing unglazed earthen pans upon the flues of my stoves, I save my gardener the trouble of so frequently sprinkling the house with water, to give the air within the most beneficial state of dampness; and I have tried some different degrees of temperature; but my method of cultivating the pine-apple remains unchanged.

I stated in the *Horticultural Transactions* of (1828, p. 254.), that the temperature of the air of the stoves in which my pine-apple and other stove-plants grow (*without bark or other hotbed*), usually varied from 70° to 85° of Fahrenheit's scale; and that the mould in my pots, being surrounded by such air, acquired and retained, as it necessarily must, very nearly the same aggregate temperature, but subject to less extensive variation, the mould being usually a few degrees warmer in the morning than the air within the house, and a few degrees cooler than that in the hotter parts of the day. No bottom-heat is, or ever has been given; and I do not conceive that I could have placed the utter inutility of it, in the culture of the pine-apple, in a stronger light than I have there done. Yet, in your remarks upon that paper, you request your practical readers "to contrast this paper of Mr. Knight's in favour of bottom-heat, with those which he formerly published against it." If you mean to state that I ever objected to the roots of plants being placed in the same temperature with their stems and branches, I must take the liberty to contradict you.

I have stated, that such is the simplicity and facility of cultivating the pine-apple, when its roots and stems and leaves are subjected to the same proper temperature, that I could qualify an illiterate peasant, within a month, to manage my pine-stoves. Did this statement justify you in asserting that I recommended "ignorant gardeners?" [See note *c.*] I only pointed out, to the intelligent gardener of the present day, the difficulties in which he is involved by blindly following the irrational practice of an ignorant period, in which practice you are urging him (you must allow me to think ignorantly) to persist.

I described, in the *Transactions of the Horticultural Society of London* last year (p. 281.), a very simple method by which I had caused air to flow rapidly into a hotbed, at a temperature which, during fifteen days, varied only from 101° to 104° of Fahrenheit's scale; and I gave an *opinion, and an opinion only*, that such air being divided, as it was, into eighteen different currents, and emitted into every part of a bed of 20 ft. long and 6 ft. wide, would cause tender plants to be preserved in cold weather, without any covering being put upon the glass. You have reduced my machinery to one third, have omitted wholly to mention the high temperature at which the air entered, have left the length of the hotbed wholly undefined; and having given a description of machinery, which every gardener must know cannot possibly succeed, you inform the public that I *assert* that it will succeed. [See note *d.*]

A most absurd hypothesis was published some years ago respecting the cause of a disease of the potato called the curl, which was imagined by the author to arise from the over maturity of the plant, that is, to the over maturity in the open air, in England, of a plant which is a native of the torrid zone. [See note *e.*] I have written, in the *Horticultural Transactions*, upon the disease above mentioned; but the discovery of the over maturity of the plant certainly does not belong to me: though I am given the credit of it in the *Gardener's Magazine*, (Vol. IV. p. 254.) I do not, however, accuse or suspect the writer of any intentional mis-statement whatever [*f*].

I shall no longer trespass upon your time, or upon that of your readers, trusting that I have shown you that the members of the council of the



Horticultural Society of London had better reasons [See note g.] than you have assigned in your Magazine, for the rejection of that, when it was offered as a present: but I must add, that they acted entirely without my knowledge; and that I obtained the first information respecting the transaction from your statement in your Magazine. And respecting myself, I beg to add, that I never have been, and that I never shall be, offended by your differing from me in opinion: and if you think the mere practical gardener is the person best qualified to discover horticultural improvements, and that physiological science is useless, you have a perfect right to say so: all I ask is a fair and honest statement. I remain, yours, &c. — *Thos. And. Knight. Downton, April 13. 1829.*

(a) Our words are, "What tempted us to write the paragraph at all, was the recurrence to our mind that Mr. Knight, now employing a writing gardener, had formerly boasted (it may be called) of growing pine-apples in a far superior way to those generally grown by professional gardeners, by a man who 'neither knew a letter nor a figure.'" Aware of the influence of Mr. Knight's opinion on every subject connected with gardening, and convinced that nothing can have a greater tendency to retard the progress of that art, or of any other, than ignorance in operators, we directed some observations against the passage, in the Preface to the first edition of our *Encyclopædia of Gardening*, and have since maintained and supported an opposite theory. Our offence has proceeded from having felt rather too much delighted to have the evidence of Mr. Knight's present practice to prove that he was formerly wrong, and that we were and are right. So much with reference to Mr. Knight." (p. 88.)

If our readers have read the above passage with attention, they will see that Mr. Knight has mistaken our meaning; and that, in speaking of his "present practice," we allude to his employing a writing gardener, instead of his former practice of employing a man who neither knew "a letter nor a figure." The reference to the preface of the *Encyclopædia of Gardening* will set this matter at rest. We submit to the consideration of any candid reader, whether Mr. Knight's meaning can fairly be attributed to the passage. Certainly we had no such meaning, well knowing at the time, as we do at this moment, that Mr. Knight grows his pines, as far as respects what is called bottom-heat, much in the same way as he did when he first commenced their culture. — *Cond.*

(b) We have seen a London nurseryman who saw Mr. Knight's pines last autumn, and a country nurseryman who saw them some months before. Unfortunately, neither of these gentlemen will allow us to use their names, and we should not like to repeat what they said without giving an authority, though quite confirmatory of what we stated on this subject in *The different Modes of cultivating the Pine-apple, &c.*, 8vo, 1822. We shall voluntarily acknowledge our error when we are convinced that we are in any degree wrong; at present it is our duty to state, that we are of exactly the same opinion as we were in 1822. — *Cond.*

(c) We think it implied as much, and we know that such was the effect on the minds of a number of gentlemen who employ gardeners. We feel that we should have been perfectly justified, as the editor of a Gardener's Magazine, in saying a great deal more on this subject than we have done. The following is the passage alluded to: —

"I shall now offer a few remarks upon the facility of managing pines in the manner recommended, and upon the necessary amount of the expense. My gardener is an extremely simple labourer; he does not know a letter or a figure, and he never saw a pine plant growing till he saw those of which he has the care. If I were absent, he would not know at what period of maturity to cut the fruit; but, in every other respect, he knows how to manage the plants as well as I do; and I could teach any other moderately intelligent and attentive labourer, in one month, to manage them

just as well as he can. In short, I do not think the skill necessary to raise a pine-apple, according to the mode of culture I recommend, is as great as that requisite to raise a forced crop of potatoes." (*Hort. Trans.*, vol. iv. p. 77. Read March 7. 1820.)

Gardeners, as Nicol observes, and as every gardener and nurseryman knows to be true, being valued by the wealthy in proportion to their success in the cultivation of the pine-apple, what gentleman, reading the above passage by a horticulturist so celebrated as Mr. Knight, would not think either of changing his gardener, or of lowering his wages? To confirm such a gentleman in his intentions, or rather, perhaps, to set him at work in reforming the practice of his gardener, the following passage by Mr. Knight occurs in the same volume of the *Transactions*:—

"A very great number of gardeners have, within the last twelve months, visited my garden. Some of these were at once convinced of the advantages of the mode of [pine-apple] culture which they saw; others have paid a second or third visit, but every one has ultimately declared himself a zealous convert." (*Ibid.*, p. 545. Read Nov. 26. 1821.)

We should be very much obliged to any one of this "very great number of gardeners," all "zealous converts," if he would send us some account of what he saw either then, or during subsequent visits. Why will not our correspondent, Mr. Mearns of Shobden Court, not a very great way from Downton, and mentioned in the *Horticultural Transactions*, by Mr. Knight, as having seen his pines, send us his opinion? The truth we suspect to be, gardeners and nurserymen have, like ourselves, so great a personal respect for Mr. Knight, from his obvious goodness, and that peculiar sort of winning simplicity and ingenuity which pervades his character, that they will not incur the risk of hurting his feelings. Much and deeply do we regret that our duty as editor has compelled us to run this risk.—*Cond.*

(d) The review in question comprising notices of seven articles from Part II. Vol. VII. of *Hort. Trans.* was wholly by Mr. Main, with the exception of the last sentence of the second article. We do not mention this to excuse ourselves, being unquestionably responsible for every opinion expressed in reviews, to which no signature or mark is attached; but to admit of any friends of Mr. Knight calling on Mr. Main and ascertaining the truth of what we now assert, that the omission was entirely inadvertent. We regret it extremely on every account, and to atone for it as far as we can, shall here print the article entire, and, that it may not occupy too much room, in a small type.

"I submit an account of a small addition which I have made to the machinery of a common hotbed; from the use of which, I believe, that every gardener who has occasion to raise cucumbers and other plants in winter, or very early in the spring, will be able to derive very considerable advantages. At these periods of the year, it is not easy to give the plants a sufficiently high temperature, with proper change of air, however well the bed may have been constructed, and with whatever care the material which composes it may have been prepared; and the sudden changes of temperature, which often occur in the climate of England, will frequently subject the roots of the plants to be injured by excess of heat, and the mould, when lying upon horse-dung, to be what is called by the gardener *burned*; that is, I believe, so much impregnated with ammonia, that the roots of the plants cannot retain life in it. Another defect of the common hotbed is, that whilst its interior part is excessively hot, so little heat ascends through the mould, that a covering of glass alone does not afford sufficient protection to any tender plant, in very cold weather, during the night.

"By means of the machinery, which I shall proceed to describe and to recommend, abundant air may be given at all times, and so high a temperature preserved, that, with a hotbed of a very moderate degree of strength, the most tender plant will be perfectly protected without any other covering than that of an ordinary glass light during the severest frost of our climate, provided the spaces, where the panes of glass overlap each other, be perfectly closed.

"The annexed design will give a sufficiently accurate representation of the apparatus which I have above recommended:—  
*a, b, c, d,* is a hotbed, resting upon an inclined plane of earth. *e,* the frame. *f, g,* a pipe, made of a slender oak pole; and *h, i, k,* smaller pipes fixed into the larger one, through which the air, which enters the latter at *f,* ascends into the hotbed. The tube of the large pipe is one inch and a half, and that of the smaller three quarters of an inch diameter. The smaller tubes have near their upper ends two horizontal apertures, through which the heated air passes laterally into the frame. I consider three of the large pipes to be fully sufficient to give heated air to a bed twenty feet long; the heated air entering at all times very rapidly, and consequently always keeping all within the frame in motion. The larger pipes might, I conceive, be with advantage made of cast-iron.

"If the heat of the air be at any time excessive, it may be lessened by opening the end of the tube at *g*, where it is usually kept closed. The hotbed, in which I have placed the above-described kind of tubes, is composed almost wholly of leaves; but the mass of these is great, and

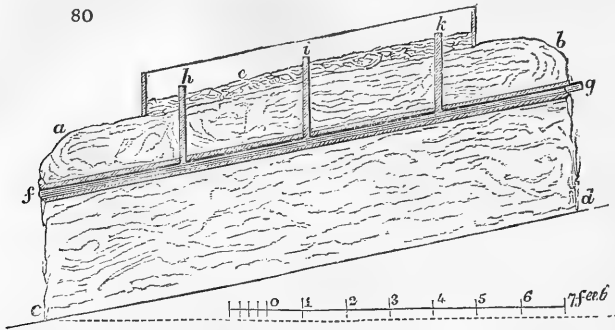

the temperature in consequence high. I immersed a deep pot into the leaves, and caused the heated air of the tube *k*, to ascend into it; having previously shortened the tube, and fitted it accurately to the aperture of the pot, placing a thermometer, with some eggs of the common domestic fowl within it, with the view of ascertaining whether these could be hatched by such means. I have not yet seen the result; but the temperature of the ascending current of air, which arises into the pot, and, of course, into the frame, appears never to have varied during fifteen days more than three degrees; the lowest temperature being  $101^{\circ}$ , and the highest  $104^{\circ}$ ; and it has, of course, been nicely adapted to both the purposes for which it was intended.

"I have formerly ascertained, that the power of a current of heated air, when made to enter a pit or chamber of any kind, was found greatly to exceed the calculation which I had previously made; and in the last winter, very contrary to my expectations, a very feeble current of air, the temperature of which was below  $50^{\circ}$ , proved sufficient to preserve geraniums, which were placed close to the glass, in the severest frost from receiving the slightest injury.

"The operation of a hotbed, into which a pipe is introduced in the manner above mentioned, has been observed by me only during the spring and part of the summer of the present year; but the results have been so satisfactory, that I can with the utmost confidence recommend the machinery which I have described; particularly when tender plants of any species are to be raised in cold seasons of the year."

(*e*) Without pledging ourselves to any opinion on the subject, we declare frankly that we see nothing absurd in the idea of the fruit or the tubers of a plant of the torrid zone being over-ripened in this country. We know that the peach and the apricot, natives of Persia, are frequently over-ripened, and also the melon; any fruit or other production that may be matured, may surely be over-matured. — *Cond.*

(*f*) The passage alluded to is in a "Note by Mr. Main," who can only state that such was the general impression on his mind; he is however glad to be corrected. — *Cond.*

(*g*) The first reason (note *a*), being, as every reader who will take the trouble to look at the passage will allow, an error of Mr. Knight, falls to the ground; the remaining three are mistakes which any editor may make, and which one would have supposed he might have atoned for, simply by correcting them when they were pointed out to him, as we have now and always done, and shall continue to do. — *Cond.*

*Errata.* — Page 233. line 12 from bottom, for *tm* read *tl*. Line 16. from bottom, for "syllable" read "letter."

THE  
GARDENER'S MAGAZINE,

AUGUST, 1829.

---

PART I.  
ORIGINAL CORRESPONDENCE.

---

ART. I. *Notes and Reflections made during a Tour through Part of France and Germany, in the Autumn of the Year 1828.* By the CONDUCTOR.

(Continued from p. 248.)

*TÔTES to Rouen, September 1.* — The greater part of the road passes through the picturesque valley of the Cambres, in which are the principal cotton manufactories of France; and, perhaps, there is no spot in this part of the Continent which bears so great a resemblance to England. Still the dissimilarity is too considerable to permit the slightest delusion; for instance, the sumptuous iron gateways to the cotton mills and bleach fields, enriched with gilding, fleurs de lis, and the royal arms. Two or three of the manufactories displayed some striking features of architectural design, such as open arcades immediately under the roof over several stories of common small windows, immense semicircular windows in gable ends, &c. The houses of the proprietors or managers had the appearance of comfort, and many of them were surrounded by gardens, in the English style, well kept, and displaying georginas, nasturtiums, and other showy annual flowers. The buildings of the working classes did not exhibit such a neat, clean, and orderly appearance as those in the manufacturing districts of England; but there were exceptions, and some of the gardens were well cultivated, and cropped with cabbage, leeks, potatoes, and twining kidney-beans. The prevailing appearance, however, at least according to the impressions made on us, was that of dirt and disorder, arising not so much from want of means as from want of taste.

What indeed could be expected from the common people, in a country where the residence of a nobleman displayed such a slovenly appearance as that of the Comte de Malartie at Tôtes? (p. 247.)

The approach to Rouen, through an avenue of elm trees, with the heights on which the town is built on the left, and on the right the windings of a noble river, is rich and grand. The sun was setting behind the spires and towers of the town and the cathedral, and the streets in the outskirts and the river exhibited all the bustle of a commercial city, with the repose of long shadows, smooth water, and yellow light. After passing through a number of narrow streets and lanes full of people and horses seemingly returning from the labours of the day, we were set down at the Hotel de Boulogne; and the first characteristic of a French country inn immediately occurred, that of our being shown to our room through two others occupied by a lady and her daughter; of course we concluded that this was the only passage. Dining shortly after in the coffee-room, at a time when most of the customers had supped, we had an opportunity of seeing the landlord, his wife and family, and part of the servants, sit down to supper together in one corner of the room; a custom which, though very different from any thing which takes place in England, we cannot help admiring for its patriarchal simplicity, and we should think the effect would be favourable to the morality and manners of servants. The same thing is practised in the Swiss inns in the principal towns of Italy, and may be considered as characterising a certain stage in the progress of civilisation. In a country of manufactories and of poor-rates such a custom could scarcely exist; because the love of independence, which the circumstances of such a country promise to gratify by the demand for labour, must necessarily weaken every other tie. The potatoes, brought to table *au naturelle*, were a small, long, red kind, with numerous deeply sunk eyes, dry and compact, but not very good; the Cos lettuce was large and excellent; and although the wine did not appear of the first quality, yet, after being accustomed to consider it as something to be able to sip gravely one or two small glasses of strong and dear port or sherry, we felt it pleasant to be able to luxuriate *à bon marché*, and with impunity as to the morrow, in bumpers. We were shown to our room, not as before, but by a small back staircase; and from various circumstances, among others that of the room being over the kitchen, discovered it to be one of the worst in the house. It is still worth mentioning, because, however disagreeable at the time, it is of interest in the remembrance; for otherwise we should probably have had nothing to say about it. This principle,

of present pain and labour, being productive of future enjoyment, will apply to the whole of life; for what are the recollections of a tour without incident, or what is the feeling of pleasure to those who have never felt pain?

*Rouen, Sept. 2.*—Mr. Calvert, the English nurseryman here, who crossed with us to Dieppe, kindly anticipating our wishes, sent his foreman Henderson to show us the gardens of the town. This Henderson is a young Scotsman who has been upwards of two years in Rouen, has acquired the language grammatically, and by teaching in Sunday schools, good conduct, and decent manners and dress, has, though only a journeyman gardener, rendered himself respected by every body. Professionally he is an excellent propagator of roses, oranges, and green-house plants, and is duly valued by his master.

*Berquier's Market-Garden* is at the head of its class, and was the first we looked into. Its proprietor is a middle-sized, toil-worn, though still a strong, man, eighty-seven years of age, with red sore eyes, a thing common in France among old men, and without teeth; he has a stout wife of thirty-five. Their clothing was very coarse, they had on sabots, and were both at work in the garden. M. Berquier told us that he had one garden, on a dry slope to the south-east, for early crops; and another on the flat ground close to the river, for main crops. The only vegetable which appeared to us grown to greater perfection in his gardens, and in others here, than we ever saw it in England, was the leek. After every enquiry we could find nothing peculiar in the mode of culture, and conclude the size and excellence of this vegetable at Rouen to arise chiefly from the climate. They are planted at different seasons to produce a succession of crops throughout the year, and their principal use is in soups. We were promised some seed by M. Berquier, but it was not sent, very probably from fear or suspicion; for he was continually wondering at, and trying to guess, the motives which could induce us to be so particular in our enquiries, and for that reason and the difficulty of comprehending his *patois*, we derived no great benefit from our visit. The crops on the ground were, cauliflowers, cabbages, turnips, carrots, parsneps, leeks, peas, running kidneybeans in different stages of progress, artichokes, asparagus; mammoth gourd in large quantities, for soups; celery in beds, not blanched, but intended to have a little earth put about it; endive, broad and curled, in large quantities tied up for blanching; Cos lettuce, a good deal of sorrel, a bad sort of parsley; melons, not in the Honfleur manner, but on ridges under bell glasses as in England, and the surface of the ridges

covered with rye straw ; and cucumbers in the open garden, without dung under them.

We are not aware, indeed, that there is any culinary vegetable in general culture about London that is not grown here, unless we except sea-kale and tart rhubarb. Tarts enter but little into French cookery, but sea-kale is a valuable adjunct to asparagus. We wrote home for some seeds of it, and also of an excellent variety of curled parsley, both given gratis by Mr. Malcolm, which we have since learned was duly received by Mr. Henderson, and distributed among the principal gardeners. Had we waited till our arrival in Paris this trouble would have been unnecessary, because we found abundance of sea-kale seed, and as fine a variety of parsley as any in the world at M. Vilmorin's.

Standard apples, pears, plums, and cherries, were for the most part planted in quarters by themselves ; vines and figs, chiefly against houses. There were very few currants and raspberries, still fewer gooseberries, and only the alpine strawberry. M. Berquier had scarcely any flowers, but we observed a few good Brompton stocks, double white rockets, and violets.

This garden had scarcely any thing that could be called a walk or a fruit wall ; it was, however, richly manured, well tilled, and the weeds, we think we may venture to state, were not suffered to grow beyond *the economic point*. By the economic point we mean when they are not suffered to become so numerous, or to attain so large a size, as that the injury they do the crop will exceed in value the expense of weeding. In the gardens of private individuals, or wherever neatness and order are primary considerations, no weeds should ever be allowed to appear ; but it must be obvious that to attain this degree of perfection, the ground must often be searched when the expense of doing so will exceed in value the amount of the injury done by the weeds. This we intend in future to call weeding under the economic point ; as weeding, when the weeds left in the ground do more harm than the expense of eradication, we intend to call weeding above it. In forming the estimate for this nomenclature, the future injury weeds may do by shedding their seeds, and the immediate good done by stirring the soil, must be taken into account.

*Renard's Market-Garden* was laid out with walks, and was in better order than any we saw in Rouen.

*The Nursery of Prevost fils* is the finest in Rouen. M. Prevost, whose father was proprietor of the same grounds, has had a regular college education, is a scientific botanist, member of various societies, and author of *Essai sur l'Éducation et la Culture des Arbres fruitiers pyramidaux, vulgairement appelés*

*Quenouilles* (*Gard. Mag.*, vol. ii. p. 78.), and of *Catalogue descriptif, méthodique, et raisonne, des Espèces Variétés, et Sous-Variétés du Genre Rosier*, just published. He is an exceedingly well-informed man, and ardent in his profession; we are not aware, that there is any nurseryman who, as a cultivated man, can be compared with him in England, with the exception of George Loddiges, and we only know of M. Vilmorin in France. He showed us every thing, and, considering the comparatively limited encouragement which he receives, we were astonished at the number of rare trees and shrubs which he had collected. He has also a library, *assez considerable*, as he informed us, *pour un planteur de choux*, a herbarium, and some specimens in other departments of natural history. He has paid considerable attention to landscape-gardening, and draws plans and lays out grounds *à l'Anglaise*. His culture embraces every out of door department, and excels all others at Rouen for rare articles; and, judging from his catalogue now before us in which 880 sorts are described, we should add, for roses. Among the magnolias we found all the species grown about London, except *Soulangeana*. Among the plants which have left an impression on our mind are *Serrátula noveboracensis*, 8 ft. high and very ornamental; *Linum marítimum* finely grown; *Córylus Avellána* var. *urticifolia*, handsome specimens; the Chinese quince; and peach of Ispahan, which ripens its fruit as a standard. *Tília americana*, *rúbra*, and *álba*, *Sórbus americana* and *doméstica* were noted, and we might have marked down a great many other things, but did not, from want of time. The nursery ground, perhaps about 10 or 12 acres on a sloping surface, was regularly laid out in parallelogram compartments, in the direction of the slope, with 2 ft. alleys between, and diagonal broader walks for ascending and descending with ease to and from the top of the slope. The whole was in excellent order; and the soil, which was a gravelly clay, was laid loosely and in rough clods, so as to benefit as much as possible from the sun and air.

*Fremont le Jeune's Nursery* contains a good collection of fruit trees and roses, and the common sorts of forest trees and ornamental shrubs; a part of his signboard announces *toutes espèces d'arbustes pour les jardins Anglaises*, but we saw very few. He transplants all his evergreens and fruit trees every three years, in order that they may rise with fibrous roots. Plums, it seems, cannot be successfully propagated about Rouen, for what reason we could not discover; they are purchased from the nurserymen at Orleans and Vitry. In speaking with M. Fremont respecting the training of fruit trees *en pyramide*, he observed that all trees whatever with high



stems should be trained in that way for a few years at first, otherwise the stem and roots could not acquire strength in due proportion to the head, the consequences of which were that the trees were frequently blown over or to one side, or became crooked. We certainly have seen this effect in some orchards in England, but nurserymen could not afford to lose a year in producing saleable trees, in order to avoid this evil, unless they were paid a higher price by the purchaser than they are at present. For clay and loamy soils, trees to be trained in the pyramidal form should be grafted on dwarfing stocks; for sandy and poor soils, on free stocks. M. Fremont does not consider this mode of training fruit trees favourable for producing fruit, except when they are on dwarfing stocks, and for a few years while they are young. We were rather surprised to hear this opinion, having formed a contrary one from the row of trees in the Horticultural Society's garden (Vol. IV. p. 168.); but what we saw and heard subsequently, both in France and Germany, has convinced us that, however favourable this mode of training standard pear trees may be for the crop of vegetables grown below or around them, and for producing straight timber, it is a very bad method, if not the very worst, for the production of fruit. Let any one who doubts this observe such trees in the gardens about Paris, and in the Royal Gardens at Stuttgart, Carlsruhe, and at other places in Germany. No mode of training a standard tree is worth any thing, that requires the continual use of the knife. Leaving the tree to take its natural form is the only means of insuring abundance of blossom; all that art has to do, care being previously taken that the roots cannot get down into bad soil, is to thin out crossing shoots. The fruitfulness of orchards, and indeed of wall trees and garden dwarfs, climate being equal, depends much more on the nature of the soil than on the mode of pruning. In budding here and in other gardens about Rouen, worsted threads are used instead of ribands of bass, and the advantage, we were told, is, that the worsted expands as the bud swells.

M. Fremont has about the same quantity of ground as M. Prevost, but, being in three separate places, it is not so well laid out, and does not produce the same effect: it was, however, in very good order. He has a promising young son, whose education, we fear, will not be what the present day requires, unless he be sent to Paris or London.

*The Trianon Nursery*, Mr. Calvert from London, is limited to the culture of roses, georginas, and green-house plants. It contains about 10 acres, and includes the mansion and part of the grounds of an ancient domain forfeited to the state at the

period of the revolution, and destined for the residence of one of the 100 senators during the consulate. Since the restoration it was sold to Mr. Calvert, who has built in the walled garden a range of sloping glass green-houses after the manner of English nurseries. Mr. Calvert has raised a great many roses from seed, especially varieties of the Noisette and of *semperflòrens* and *sanguinea*; these he propagates by cuttings of the young wood taken off at two or three times between June and September. The plants are sold as dwarfs for flower borders, of which they are very great ornaments in June and July, and from October till they are destroyed by frost. In the opinion of some these varieties are much handsomer in this dwarf state on their own roots, than when budded standard high; and it is certain they are much more durable, for there are not above twenty or thirty sorts of roses that will live ten years, budded as standards. It is good, however, to have both standards and dwarfs; and ten years is a long enough life for a rose. We were surprised to find that *Ròsa semperflòrens*, and one or two other varieties, raised from seeds sown in January and February, flower in the August and September of the same year; the continual succession of new sorts, therefore, need not be wondered at, though it is perhaps to be regretted as puzzling to purchasers. In a bed of seedlings we found the shoots from 2 to 4 ft. in length, and most of the plants with one flower or more near their extremities. These flowers are much less double in the first and second years than they are in the third and fourth. Mr. Calvert has suffered extensively from the ravages of the *ver blanc* or cockchaffer (Vol. III. p. 295.), and therefore no longer stirs the soil in the months of May, June, and July, among his roses, but pulls out the weeds by hand, leaving the surface as hard as a gravel walk, in order to prevent the insect from depositing its eggs there. This mode is found successful, as is that of covering the surface with wheat-straw at Vibert's rose garden at St. Denis, and other places where the soil is too loose to become hard. The circumstance of either of these modes having been resorted to, shows the great benefit which cultivators must derive from a knowledge of the natural history of insects, birds, and other animals with which they come in contact.

Mr. Calvert is very successful in the propagation of orange trees. The seeds are sown broadcast on a hot-bed early in spring; they make strong plants by August, are then taken up and potted, set on heat, by the middle of September grafted, and by the middle of November they have ripened a shoot of from 6 inches to a foot. This rapid progress is attained by the use of moist or dung heat, and judicious

shading. By sowing broadcast also, the progress of the seedlings is much more rapid; and it deserves to be better known by English nurserymen, that when French gardeners wish to forward the growth of camellia stocks or cuttings, or young plants of any of the more strong-growing green-house shrubs, they do not put them at once into little pots as we do, but plant them in beds of earth in their pits or frames for a month or two, and afterwards, when they are well rooted and have made a good shoot, they transplant them into pots. This mode is, perhaps, more necessary for their dry atmosphere than for ours; but we have no doubt it might be advantageously adopted in this country, on the principle of saving labour and hastening maturity. Mr. Calvert has the merit of having endeavoured to increase the commerce of heaths, camellias, pelargoniums, and Australian plants in this part of France, and that of roses and orange trees in England; his efforts, we believe, have not been without a certain degree of success. He is, however, engaged in various other pursuits, and is much from home, which may be one reason why his nursery was not in such good order as we could wish to see a specimen of an English nursery in a foreign country. The mode of getting the work done is worthy of notice; only two or three gardeners are regularly kept, and every now and then, when the weeds get beyond the economic point, and other labours accumulate, a quantity of military are hired for a day or two to get through it. Mr. Calvert arrived at Rouen the day before we did, after an absence of several weeks, and we were told that in three days after we visited him, he put thirty soldiers to work, and removed every weed from his premises. We must not forget to notice his practice of shortening the young shoots of the rose acacia in July, by which means they make second shoots in August, and are kept flowering all the autumn till stopped by the frost.

*Détennemaire's Nursery*, and a few others that we glanced at, offer nothing for particular remark. The great leading articles in all of them are standard roses, and the fashionable flower the georgina.

*Vallet's Nursery* is almost limited to the culture of orange trees and roses. Of the latter M. Vallet has introduced various new sorts into England. (p. 205.) The stocks are planted very thick, perhaps two in a square foot, in beds 4 ft. wide with alleys 1 ft. 6 in. wide, so that they are most conveniently pruned and budded from the alleys, and the effect when they are in blossom is remarkably good. This gentleman is rather a keeper of orange trees, than a cultivator of them. He has a hundred trees, several centuries old, in large

boxes 4 ft. square, and 200 trees, upwards of a century old, in smaller boxes, besides a great number of young plants, pomegranates, neriums, amomum Plinius, brugmansias, and other house ornaments of the last century. M. Vallet's late father invented the most improved machine, commonly called *diable*, for moving large orange trees, or other trees in large boxes, from place to place; and a person was sent from Versailles, in the time of Louis XIV., to take a copy of it for use in the orangery there. The most improved form of this machine is given in Thouin's *Cours de Culture*, and it may be useful to exhibit it here. (*fig. 81.*) There being no axletree

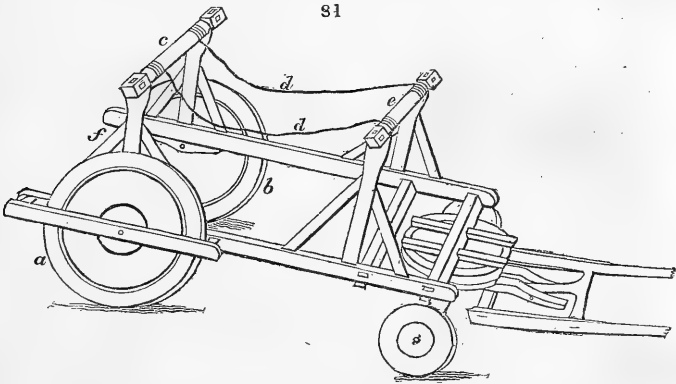

reaching across from the one hind wheel (*a*) to the other (*b*), when the roller (*c*) and the bar (*f*) are removed, the machine can be set back, so as to include a box or tub in the central space between the four wheels; the roller (*c*) being replaced, the ropes (*dd*) are put under the hooks of, or by other means fastened to, the tub or box, which, by four handspikes, worked in the rollers (*cc*) by four or more men, is raised 6 or 8 in. from the ground, or as high as the axle if necessary, and then carted to where it is to be set down. The bar behind (*f*) is movable, and is replaced and fastened by two iron pins after the carriage is charged. Were such a machine executed in England, the wheels might be of cast-iron, or of a better construction in wood and iron, and for ropes chains might be substituted. M. Vallet is ready to sell all these large orange trees; but, in the mean time, as they are kept in an orangery admitting very little light, and requiring proportionably little firing in winter, the price received for the sale of the blossoms pays the expenses incurred and a little more.

These blossoms are sold for distilling orange water, an article much used in French cookery and confectionary; and, in coffee-houses, for that very generally used beverage *eau sucré*. This part of the business is managed by Madame Vallet, who is *au fait* at every thing connected with the nursery business.

*Savoureux's Nursery and Flower-Garden.* — Here are some very good orange trees, and one was pointed out to us which was produced from an old trunk nearly 6 in. in diameter, and about 4 ft. long, with the collar, but no ramosé part of the root, which had lain three years in a cellar as a bearer to a wine cask. The vital principle, it would appear, had retained its force, notwithstanding the want of excitement by leaves during that period. M. Savoureux was employed in writing, but we were shown round the garden by Madame Savoureux, a very handsome neatly dressed woman of twenty-five, perfectly acquainted with the nursery business, and competent, as she informed us, to tell the name and price of every plant, and complete any transaction respecting them, without reference to her husband. The greatest part of the garden is occupied by standard roses, most of which she buds herself; and she explained the difference between budding *à l'œil poussant*, which is budding in June and July, and three weeks afterwards shortening the stock to within an inch or two of the bud, which causes it to push; and budding *à l'œil dormant*, which is done with roses in August and September, and with fruit trees also at these seasons, and the stock not being shortened till the following spring, the bud does not push till that season. This lady, having children, passes the greater part of her time in the garden, and chiefly among the rose trees. She told us that she was not fond of housework, that the baking day and the cleaning day were not very agreeable to her, and that when she sat down to sew she got tired of it, and fell asleep. It would appear from this and similar cases that we have met with in France, that the arts of domestic economy and comfort are less cultivated and prized there than in England; because, otherwise, the wives of respectable nurserymen (M. Savoureux we should consider about the rank of Mr. Allen in the King's Road) would find it necessary to occupy themselves almost constantly in the house, as they do in the latter country.

Having now got through the commercial gardens of Rouen, in our next we shall notice the public gardens, and such of the private gardens and parks of the neighbourhood as we visited.

(*To be continued.*)

ART. II. *Remarks on various Gardens about London, and in other Parts of England, visited in April and May, 1829.* By Mr. JACOB RINZ, Jun., Nurseryman, Frankfort on the Main.

Sir,

AGREEABLY to your request, and with the greatest pleasure, I send you some remarks which I made during my stay in England; but I must beg of you to take into consideration, that I have seen comparatively few of the gardens of my own country, although I stopped a considerable time in France and Holland. I should like to give you an account of many excellent things in all the places which I have seen; but the greater part of them have been noticed already in your Magazine, and in the *Encyclopædia of Gardening*, I shall therefore confine myself to a few remarks on English gardeners and gardening.

*The Garden of Messrs. Loddiges.* — Like almost every foreign gardener who visits England, I arrived in London full of expectation and curiosity. The first garden I visited was that of Messrs. Loddiges, and never shall I forget the sensation produced in me by this establishment. I cannot describe the raptures I experienced on seeing that immense palm house. All that I had before seen of the kind appeared nothing to me compared with this. I fancied myself in the Brazils; and especially at that moment when Mr. Loddiges had the kindness to produce, in my presence, a shower of artificial rain. Under such natural and perfect management, the palms, ferns, and most other plants, appeared just as might be expected. I was surprised at the vast ranges of green-houses and hot-houses; particularly at the beautiful curvilinear camellia house, in which the plants produced the most beautiful effect. The whole collection seemed perfectly well kept, except the ericas, which, as Messrs. Loddiges observed, had suffered last summer from some very hot days.

*The Clapton Nursery.* — The next garden I visited was the nursery of Mr. Mackay at Clapton. Here I was struck with the neat construction of the houses, the beautiful and rich collection of Cape and New Holland plants, and their excellent management: but I was particularly pleased with the propagating house, and I am fully convinced that cuttings will strike no where else better than under such management. (See Vol. II. p. 25.) All that I saw in this nursery exhibited superior taste and knowledge, and consequently all the plants were in a very luxuriant state.

*Other Nurseries.* — It would be, perhaps, tedious to enumerate all the beauties observable in the nurseries of Messrs.

Gray, Malcolm, Lee, Colville, Knight, Whitley, Milne, &c. The exotic collection of Mr. Lee seemed to me almost as extensive as that of Messrs. Loddiges, if I except the palms; and Mr. Knight's camellias appeared superior to those of any other nursery. The flower-forcing at Colville's is very rich, though I think we force flowers on a much larger scale in Germany than you do in England. For instance, in Frankfort, every winter, when the balls are in season, it is not a very uncommon practice to decorate the whole house, the entrance hall, and all the rooms, stairs, and passages, with flowering plants and forced flowers; sometimes with flowering orange trees, large specimens of acacias, &c.; thus transforming the house into a garden, and affording a beautiful sight. This we practise in Frankfort, not only on the above-mentioned occasions, but, on great festivals, in the cathedral and other churches. Perhaps the custom exists in England, but not to my knowledge. I much felt the want of a splendid flower-market in London, where one might admire every day a beautiful exhibition; and it would certainly encourage the trade, delight amateurs, and contribute to the interest and ornament of the metropolis.

But with respect to the London nurseries, I must confess that I was every day more astonished at them. I saw the fine collection of Cape and other plants by Messrs. Rollison, the forcing-houses of Jenkins, the collections of Messrs. Bassington, Brooks, Smith, Henderson, Chandler, Cormack, Young, &c., and also the Kensington forcing-gardens, with all of which I was very much delighted. There are no where else in the world so many large and well kept collections assembled together. To be able merely for once to look at those places would be a sufficient inducement to the Continental gardener to visit England.

*The Garden of the Horticultural Society* at Chiswick seems to be pretty well kept; all the plants stand perfectly well, and some fine new ones were in flower. I was very much pleased with some arrangements, and, amongst others, with the various modes of training in the fruit department; but, in my humble opinion, the flower and American plant departments might have been much better laid out than they are. The space is sufficiently extensive to admit of producing a fine effect, which would have greatly contributed to the beauty of the garden. The round groups of shrubs are in part too small and uniform. The second time I visited the garden I saw *Alstroemèria pulchèlla*, *Maurándya Barclayàna*, and the wonderful *Glycine sinènsis* [*Wistària Consequàna*] in full flower.

*Kew Gardens.* — In the middle of last month (April) I made a tour in the country, and the first place I stopped at was Kew

Gardens. I had been told that these gardens contained the largest collection of any; but I would give the preference to those of Messrs. Loddiges and Mr. Lee, and every practical gardener will be of the same opinion. The collection is, however, pretty large, and I saw many beautiful and new plants there; amongst others, the *Araucaria imbricata* in the open air attracted my attention. What a picturesque and majestic tree it must be in its native country! I saw the *Hovea lanceolata* against the wall of a green-house, but it did not seem to thrive in the open air; however the plants are yet small, and will perhaps do better in future. The hot-house plants looked well, with the exception of some New Holland ones. The pine-plants and forcing-departments are pretty well managed.

With respect to the pleasure-ground, I have no high opinion of it. The trees are in a miserable state, and badly distributed. I met with a little piece of water, which I think would have been better omitted. What good effect can be produced by a mass which is composed of a whole collection of trees? Besides that, there is a temple on an elevation, surrounded with trees all of round forms; every landscape-gardener will admit that the effect would be much better, if one or two sorts of pointed-headed trees were mixed with them. I do not apply this remark to a temple confined amidst a mass, but only when it stands free, with a view from the garden. It is true, however, that in Kew pleasure-grounds many trees cannot be employed on account of their not growing well; but many American trees and shrubs will do very well, and produce a good effect,

*English Parks.* — I was not much pleased with most of the English parks which I saw. I think the taste in landscape-gardening, now prevalent in Germany, superior to that of England.

*Hampton Court.* — From Kew I went to Hampton Court. The most remarkable objects here are the forcing-houses, the orangery, the large vine, and the fig-house. The forcing of peaches, nectarines, cherries, vines, figs, cucumbers, and strawberries, is carried on with much spirit, and the houses were all in a very good state, as was also the culinary garden.

*Claremont.* — In Claremont, the seat of Prince Leopold, I was very much delighted with all the arrangements. The culinary garden, and the forcing and other houses, were in such a good state as to equal any thing I ever saw. The pine-plants and hot-house plants looked pretty well, and the whole shows the superior taste of Mr. M'Intosh.

*Walton* (Lord Tankerville's). — This is a very remarkable place. The houses are somewhat old, and too small for some



large and fine palms; but the whole is pretty well kept. Some large and beautiful American plants are standing in the open air, and also a fine specimen of *Illicium floridanum*, some *Thea viridis*, and a *Baptisia nepalensis* (*Thermopsis*), without any protection. This garden or pleasure-ground has some fine parts along the banks of the Thames.

*St. Anne's Hill* (the Hon. Mrs. Fox). — Here are some good parts; there is a beautiful and splendid grotto, and some fine American plants, which are kept in good order.

*The Goldworth Nursery*. — In Mr. Donald's nursery at Woking, I saw a very large and pretty well kept collection of fruit and forest trees, and also of American plants. The trees are in excellent health, and the immense quantities of some kinds of forest trees cultivated here is surprising.

*Waterer's Nursery, Knap Hill*. — About two miles from Mr. Donald's nursery is that of Messrs. Waterer, which contains the largest and finest collection of American plants I ever saw. Much as I was delighted with Messrs. Loddiges' palm-house, I was equally so here in the midst of the finest rhododendrons and azaleas, which grow in abundance from self-sown seeds. As a proof of their perfection, I may mention that I observed an *Azalea aurantia*, which is generally a slow grower, with some branches of last year, each of which was at least 5 ft. long. I much regret not to have seen them in flower; it must be such a delightful show, and one perhaps no where else to be met with in Europe. Every amateur should visit this place in the months of May and June.

*In Bagshot Park* I was much pleased. In particular I was struck with the extraordinary neatness and cleanliness in which it is kept. The American plants are in a beautiful state, and many rhododendrons are very well distributed in the masses of large trees. The pleasure-ground is embellished with some well executed seats; and the whole laying out would show a perfect good taste, had the flower masses been united with the shrubbery, as in the little plan I send you of the Johannisberg pleasure-ground.\* Mr. Toward is an enthusiastic gardener and naturalist, and has a fine herbarium.

*The Grange*. — I was curious to see the famous conservatory at the Grange, and it completely fulfilled my expectations. I do not think that any conservatory is executed with more splendour, and it is a striking proof of the great wealth of the English. Although the house is of a considerable height, the plants had filled the whole space so thickly that Mr. M<sup>r</sup> Arthur was

\* This plan will appear in a future Number.

obliged to cut them down, and to remove some New Holland plants, several of which had stems of from 4 to 5 in. in diameter. Some very good plants are to be found here, but some fine and new ones are wanting, such as correas, hoveas, azaleas, &c., which will never grow too high, and will afford a finer show. The forcing-houses and kitchen-garden are very extensive, and in good condition.

*White Knights.* — What a pity it is that this place is neglected! How it must grieve a gardener to look at the ruins of so much splendour! Many green-houses, hot-houses, and aquariums, &c., are standing empty; and some remaining plants show the rich collection which has been here in former times. The pleasure-ground, with its immense quantity of American plants, is the only part yet in any order; but still this place is well worth the greatest attention. There are some fine spots in the park.

*Dropmore.* — Of all the parks which I saw in England that of Dropmore pleased me the most. Some very good ideas are displayed in its laying out, which are also very well executed. The flower-garden is not, as I like it, united with the shrubbery; but still it is laid out with good taste, and wherever one might think it necessary to divide the flower-garden from the shrubbery, it should be done in that style. There is a pretty large collection of pines, and some araucarias are standing in the open air with protection. Mr. Bailey has a great quantity of *Lobelia fulgens* and *cardinalis*, which will be planted in masses, and will produce a good effect. The houses looked beautiful, and were embellished with a great many forced flowers. The orangery is large and well kept, and will be still further enlarged this season. Should this place remain for a time under the present style of management, it will soon become one of the most interesting gardens in Britain.

*In Frogmore* are some well kept forcing-houses and green-houses, but the pleasure-ground is planted too thickly.

*The Liverpool Botanic Garden.* — The collection in this garden is not quite so large as that of Kew, but it is much better kept. The plants looked as well and fresh as it is possible they can do, and, considering that the Scotch system begins here [?], I was sorry that I could not see Scotland; but I have still hopes of seeing it.

*In Eaton Hall* I was admiring the splendid mansion when it grew dark, and I was obliged to leave for Chester.

I am sorry to be obliged to leave England at present without visiting Scotland; but I have to make a long tour in different parts of the Continent before I return to Frankfort, where I shall

be happy to see you and all my English friends, and to return the kindnesses I have experienced while in England.

I am, Sir, &c.

JACOB RINZ.

*Ball's Pond, London, May 14. 1829.*

ART. III. *Historical Notices of the Rise and Progress of Gardening in Bavaria; with a Description of the Royal Nurseries at Munich and Weyhenstephan.* By WILLIAM HINKERT, Royal Bavarian Court-Gardener, and Director of the Royal Central Fruit Tree Nursery at Weyhenstephan, Member of the Agricultural Society of Bavaria and of the Deputation for the Culture of the Silkworm there.

Sir,

AGREEABLY to your desire, I send you a short account of the Royal Nursery at Munich, and also of the great Royal Central Fruit Tree Nursery at Weyhenstephan, near Freysing.

You will, however, allow me to prefix to my account, a short historical sketch of the culture of fruit trees in Bavaria, as you, in your *Encyclopædia of Gardening*, make little mention of this province.

Culinary vegetables were known in Bavaria in the earliest times; and beans, peas, lentils, and turnips were cultivated chiefly in enclosed places (*hortis*), which were denominated *fabària*, *pisària*, *lenticulària*, and *napina*, according to the things cultivated. Whoever committed theft in these places, or in any other garden, was punished with a fine of 15 *schillings*, which was, however, diminished to 3 under Charles the Great. Garlic, the cucumber, and the chick pea were also known.

The rearing of fruit trees was no less encouraged, and laws enacted against damaging trees. Whoever is so malicious, says the Bavarian law, as to injure another person's garden, is fined the sum of 40 *schillings*, 20 of which go to the possessor of the garden, the other 20 are taken as a public forfeiture to the violated law; the offender shall, moreover, replant there the same number of trees, of the same varieties, and shall every year pay down a *schilling* for each tree, until they bear fruit. (T. xx.)

Of fruit trees there were the apple, the pear, and the cherry (*chirsiboum*, *Cérasus*); these were improved by grafting, and whoever maliciously broke off a scion was fined the sum of 3 *schillings*, which, if the tree stood in a garden, was increased to 15 *schillings*. The preparation of cider seems also not to

have been unknown at that time, for Tacian says, c. 2. "*inti wwin noh cidiri trinkit.*"

That Bavaria was indebted to the Romans for the cherry, plum, and pear, may be considered probable, from the circumstance of these trees bearing the Roman names. The apple, on the contrary, is from our native woods.

Charlemagne [anno 800] considerably advanced gardening and the rearing of fruit trees.

In every century of the history of the country are found notices respecting horticulture and the cultivation of fruit. Two sorts of leeks (*poree*) were known in the beginning of the fourteenth century, *Pórrus pórritus* and *Pórrus màjor*. Sage, rue, *yffen*, penny-royal, *kaps*, *cappus*, the poppy, and the horseradish, were called *óleres*, as distinguished from the legumes.

In 1209, culinary plants and tree fruits were not subject to tithing; and in Augsburg thieving in gardens was severely punished.

From this time forward the whole practice of gardening was raised from its degraded state, and so much so, that not a village or parish could be found that did not possess fruit trees, sometimes even of the rarest kind. Wurtzburg, Bamberg, and Nurnberg were long since famous for the high degree of cultivation they presented. Munich and Nymphenburg possess good forcing establishments, and excellent fruit and leguminous plants.

In the advancement of gardening, and the rearing of fruit trees, considerable merit is due to Maximilian III., and his successor, Charles Theodore. King Maximilian I. was the founder of a new and splendid epoch in theoretical horticulture and landscape-gardening. Lewis I., who afterwards succeeded to the crown, carefully supports the works of his father, and anxiously endeavours to turn his kingdom into one blooming and prosperous fruit-garden. We are thus at present in the expectation of a favourable issue, and we feel a conviction that his persevering zeal will accomplish this great desideratum, to which the two royal nurseries at Munich and Weyhenstephan not only powerfully contribute by their ample supplies of trees, but also by producing well-instructed gardeners to introduce into the country the science of pomology, at present but too little understood.

*The Royal Nursery at Munich* is divided into two equal portions, and extends from the south-west to the north-east, in length 2835 yards of Bavarian measure, towards the village of Schwabing; it contains a surface of 11 Bavarian acres or day's

works; is bounded on the west by a stream, and enclosed on the east by a fence of planks and stakes.

The soil is of a clayey kind, mixed with sand and light turf earth, in which all the trees and shrubs thrive vigorously.

Some years ago, before this nursery had attained its present size, the object was merely to raise native forest trees and shrubs for planting in the royal gardens. During the last seven years, however, it has arrived at the greatest perfection as to regularity and order. Many beautiful kinds of trees have been raised from North American seeds, and other rare trees and shrubs have been planted. But the cultivation of the different varieties of fruit trees has, in a particular manner, increased. We have thus at present 900 sorts of apples, 400 sorts of pears, 80 sorts of plums, 200 sorts of cherries, 90 sorts of vines, and 60 sorts of peaches and apricots, exclusive of other sorts of fruits cultivated here.

The apples, pears, and plums are chiefly from Dr. Diel on the Lahn; the cherries from M. Truchsess of Bettenburg, who has been a collector of cherries for forty years, and has published an excellent work on them; the vines mostly from France, England, and Italy; and peaches and apricots from Austria and Alsatia.

There is also a collection of fruit trees in pots here, of more than 1500 different sorts, which was formed at the same time as the rest of the collection, and is yearly increasing; it facilitates the study of the sorts, and has the advantage of taking up little room.

This nursery being completely filled, a new one was established by the command of the king, of which I shall now give a short account.

*The Royal Central Fruit Tree Nursery at Weyhenstephan, near Freysing*, of which I am the director, has a north-east aspect. The soil is of lime and marl, mixed with sand, and the trees reared there are so hardened by the operation of the raw air and cold weather, that they are enabled to bear any other climate with greater ease.

Since the foundation of this nursery, in the year 1827, there have been about 250,000 fruit trees planted there, a great part of which were given away from the nursery at Munich. In the autumn of the same year, also, a seed nursery of 70,000 yards was laid down and sown.

There are at present about 80,000 young stocks of fruit trees, of the most approved kinds, which, by their vigorous growth, fully recompense the planter. This nursery will, in a few years, cover a space of from 40 to 50 acres. Apples,

pears, plums, and cherries, grow in great luxuriance in this place.

I am, Sir, &c.

WM. HINKERT.

*Royal Nursery, Munich, May 3. 1829.*

---

ART. IV. *On Practical Cooperative Societies, as a means of ameliorating the Condition of the Laborious Classes, with some Account of the Brighton Cooperative Society.* By PHILANTHROPIST.

Sir,

IN the spirit of doing good, which pervades your pages, allow me to introduce to your notice a subject you have never yet handled, and are perhaps entirely ignorant of, but which is also calculated, like the measures you recommend, to promote independence, virtue, and happiness. The ground it stands upon is entirely practical, and all its merits consist in its having been reduced to practice in Brighton: I mean, "Practical Cooperation." A society of workmen was formed in Brighton about July 1827, for the purpose of acquiring a knowledge of the principles of Cooperation, and of reducing them to practice. The principles are simply two: first, to form a common capital, by a weekly subscription, like a benefit society; secondly, to employ that capital, in trade, and in giving work to their own members.

Consistently with these principles, the Society laid out their subscriptions in articles of daily consumption, which were retailed to the members and the public, giving the profits to the Society. The business was first done by a member, gratis. When it increased, so as to take up a person's whole time, one member was appointed agent, with a weekly salary of one pound, which, since the Society has been found to prosper, has been increased to twenty-five shillings. When the common capital became larger than the shop required, they hired about twenty-eight acres of land, about ten miles from Brighton, which is chiefly cultivated as a garden. Here they now employ five of their members and one lad, the son of a member, as an apprentice. As the capital increases, they will employ more, and they will employ them in other trades, as well as that of gardening, accordingly as they appear to be most profitable; the ultimate object being to employ all the members upon their own capital, so as to receive themselves the whole produce of their labour.

Here then if they choose to increase that labour, they will increase the capital in the same proportion.

They are now arrived at that state, when they would be glad to be joined by a first-rate gardener, who would act upon their principles, as the Brighton market would afford a return for the best skill and talents in that line. If such a man would join them with a capital of twenty pounds, they would admit him a member, find him constant employment, and take his 20% as a loan, allowing him interest upon it. An arrangement equally advantageous to both parties. An entrance fee of five pounds would be required, as being the present value of one share of the common capital.

As they have proceeded, they have found the great advantage and even necessity of knowledge; they have therefore a small library, and an evening school, both of which are superintended by a member, who is paid a small salary for his trouble.

A society upon the same principles is established in London, at No. 2. Jerusalem Passage, St. John's Square, Clerkenwell, where every information may be obtained, and various publications, among which may be particularly mentioned *The Associate* and *The Cooperator*: the former published in London, the latter in Brighton, monthly, at one penny each. They are also to be had of Cowie and Strange, Paternoster Row. The Brighton Society, 37. West Street, was the first established: since which there have been upwards of seventy formed in different places.

I would not have troubled you upon this subject, had I not been firmly convinced, by seeing this Society in operation, that the principle is calculated, and even destined, to raise the working classes, out of a state of degradation and want, into one of comfort and independence.

Yours, &c.

May 27. 1829.

PHILANTHROPIST.

OUR readers, we are sure, will join with us in thanking our benevolent correspondent for his very interesting communication. We have procured the *Associate* and the *Cooperator*, and have perused them; and, viewing the associations as common partnerships in trade, we do not see why they should not succeed as well as partnerships generally do. If they do succeed, the labourer is, at any rate, laying out his money and his labour to a greater advantage than he could do by any existing mode of investment. At all events, let it be fairly and extensively tried and persevered in, till a result is obtained, satisfactory

both in fact and on general principles. We should wish to see the plan carried into execution in all towns and villages, or wherever people of different trades and pursuits are associated together in numbers of three or four hundred. It seems to have at once the advantage of encouraging industry, frugality, and the desire and love of property. The interest and importance thus excited and produced, in the minds of the poorest and humblest labourers, must be most salutary. A man belonging to one of these societies will feel that he is something, because he has acquired some property, however small; and as this property may be increased by skill and labour, as well as by chance, he, having a greater stake in society, will play a more careful game himself, and will see that the game is fairly played by others. No man in any class of society is much to be depended on who has not some property; who is not connected with his countrymen and his country by some other tie than that of merely belonging to the same species. The natural desire of having something we can call our own, is one reason why the poorest men marry soonest; to have a wife and family, they feel, at once renders them of some importance, because they have something belonging to them and depending on them. They can no longer be esteemed an isolated point, or an unconnected fragment, but a perfect whole; and, as soon as children are produced, a whole complete in all its parts. Where a young man takes a saving turn in early life, he does not marry so soon, partly because his savings are something to set his heart on, and partly because every day he feels more and more the importance attached to property. Marriage he looks forward to at a future day, and he also looks to marrying some one, who, like himself, has saved a little property. The operation of this principle in young men is thus a cause of saving in the other sex, and, should a couple of young persons, who have been saving, produce children, they are likely to educate them, and instill into them the same principles. With a view, therefore, to keeping population within due limits, these Cooperative Societies will not be without their use, and more especially when they are connected, like the Brighton Society, with the education of the rising generation; for any plan for the amelioration of the laborious classes, in which this is not included or supposed, can only be considered of temporary use. We reserve a good deal more which we have to say on this subject, till we review in a succeeding Number the two publications alluded to; in the mean time, we should be glad of further information, and of the opinions of different readers.— *Cond.*



ART. V. *On the Introduction of Botany into the System of Education in Village Schools.* By Y.

Sir,

NUMEROUS plans have of late been proposed for the amelioration of the laborious classes, but some from their generalisation affording nothing definite left the subject where they found it, and others will never be effected except in a state of society widely different from the present. It was, perhaps, to be expected, that in the search after perfection many intermediate improvements would be overlooked; yet, still, the instruction of the husbandman in the nature of the objects of his future occupation is one of such obvious utility, and so easy of application, that the wonder is that it has not been adopted long ago.

Botany is a science peculiarly adapted to the countryman; its objects are continually before his eyes; they have been the delight of his childhood, and, if he be made acquainted with their properties, may become the solace of his age. There is no good reason why the system of Linnæus should not be taught in every village school in the kingdom. If it should be asked, where shall we find masters? I would answer, make botanical knowledge essential, and men duly qualified will soon offer themselves; while the present masters will quickly acquire a system, which only needs perseverance and the share of intelligence usually bestowed on mankind. As to books, short catechisms could easily be framed to teach the classes and orders; and the meanings of the technical terms might be taught, as those of other words, by means of spelling-books, and with as much facility. Cheap magnifiers might be awarded to the more advanced; and, on completing their study, a *Galpine's Compendium*, or some such work, which would serve them for a dictionary of plants all their days. Only set the system a going, and books good and cheap will soon be found.

We are told that the Arcadians were the most savage of all the Greeks, till Pan taught them music. We admire the fable, let us profit by the moral. I would not counsel the erection of schools of music over the country, though these may one day be thought as necessary as grammar-schools are now; but I would have music indirectly encouraged, by rewarding the school exertions of the children with musical instruments, the boys with flutes, the girls with flageolets. All have not a musical ear, but many have possessed it, and died in ignorance of the rich gift which nature had bestowed upon

them: and how much time would have been rescued from the alehouse, and how much money saved, if they had known the pleasure which even indifferent music can give to a lonely hour!

Here, then, is a plan which might be put in practice tomorrow, with equal gratification to the scholar and the utilitarian, and yet nobody thinks of it. It is not an improvement affecting separate bodies of artisans, but a whole population; it does not influence the workmanship of our furniture, or the texture of our apparel, but the manners, the morals, the happiness of a whole people. The mind is dazzled with the prospect of its probable effects. Before half a century should pass away, the moral face of the country might be totally changed; alehouses forsaken, gaming and quarrelling fled for ever, and happiness and peace come to make their everlasting abode amongst us. And who are the men to carry this into effect? The men of all others best qualified to appreciate it, the clergyman and the landlord; the very men who will gather most pleasure from it, the former in contemplating improved morals, the latter in beholding an improving tenantry. People talk of pastoral innocence and pastoral delight, "Sicilian groves and vales of Arcady," and yet never raise a finger to make their own vales echo with melody, or to adorn their groves with rustic elegance. Surely our groves are not to be lightly esteemed, and we have vales as sweet as Theocritus ever sang. But we choose to dream of by-gone days, and lament their loss, forgetting that it is in our own power to recall them. Do let us stir a little, let us try to effect something for lovely England; to form a population fitted for its beauty, and subjects for future idyls whose freshness and truth may leave the Doric reed far behind.

I am, Sir, yours, &c.

June 24. 1829.

Y.

ART. VI. *Hints with regard to the Drying of Botanical Specimens.*

By W. D.

Sir,

CIRCUMSTANCES over which I had no control have prevented me from sending, for the last Number of your Magazine, "a few hints with regard to the drying of plants," &c. In my former paper (p. 15.) I took occasion to notice that all gardeners should be well acquainted with the manner of drying plants, with what parts of a plant should in preference to others be selected, and what was the proper season for gather-

ing specimens; let me now proceed to give a few hints on each of these points. The first injunction I would give is this, that we should uniformly collect our plants in dry sunny weather; because, in this case, having much less juice, they preserve their colour and natural appearance much better. If, on the contrary, we gather our specimens in wet or damp weather, they almost always become black, and are much longer in drying. If the plant is small, we should take the whole of it, root, stem, and flowers, because in many small plants the root forms the specific character. If, again, the plant is large, we should take portions of it to illustrate all its forms. We should observe if it has male and female flowers, and, if so, we should select specimens of both. Some parts of plants are fertile, others barren, both should be brought away. The leaves of the root, stem, and branches sometimes differ, we should then select specimens of all. Sometimes in order to render plants portable we must cut them into pieces; these should, immediately on our return home, be accurately glued together. We often have occasion to observe that the corolla of some plants shuts immediately on the plant being pulled; in that case we should put the plant into our portfolio, as soon as it is pulled, between two sheets of paper. Most of our specimens we put into a common tin case, with which every gardener is well acquainted; when it is filled, we can transfer our plants into a large portfolio. Or, if we wish to bring home many specimens, we should have two flat pieces of wood about two feet square, to be lashed together with belts and buckles, our specimens being separated by intermediate layers of paper.

Supposing, now, that we have procured as many plants as we can conveniently carry, let us consider how they are to be dried: and here the grand consideration is, never to be sparing of paper; for, by being liberal at first, we shall both save much trouble, and in the long run some little expense, as I can from experience testify. If the plant is in any degree succulent, and we are sparing of our paper, it always gets wet, and the plant is spoiled by continually changing the paper. The best kind of paper is that called blotting paper, as it most readily absorbs the moisture; but, as it is expensive, almost any kind of paper, except the very coarsest description, will answer our purpose, such as old newspapers, &c. With regard to pressing, the best mode is to have a linen bag loosely filled with sand placed over our specimens. Above this we put one of the boards already mentioned, and then above it our weights of whatever kind they may be. The great advantage of this linen bag is, that it presses all parts of the

plants alike, and gets down into all the inequalities. We should then dry rapidly, the sooner perhaps the better; because thus our specimens are best preserved, and the smaller the heap is the sooner will the drying be accomplished. We should change our paper occasionally. The time which plants take in drying varies. Thin dry plants take no long time; succulent ones much longer. By taking off the pressure occasionally, and exposing our specimens to the air for a little, we perhaps accelerate the drying; although here we must be very careful, some plants immediately shrivelling and withering. Some plants we find so brittle as to bear no pressure; by leaving these exposed till they begin to wither, we find they bear pressure well. Some parts of a plant again will dry well, others are so brittle that they must be left exposed for some space. Some plants we find so retentive of life that weeks, nay, months, will not suffice to destroy their vital powers; some of these will then rot away, while others, strange to say, will take root in the paper. Such refractory plants must be immersed in hot water, which instantly kills them, then they will dry easily. Some, however, will not bear this treatment; these must be rubbed over with a hot iron, while others must even be boiled before they can be dried. Almost all of the family of Orchideæ, and many other plants, become quite black by drying, while others dry very variously. Sea-weeds, it must be observed, being often encrusted with the muriate of soda, which is deliquescent, become moist in our herbariums, and are thus often spoiled. These should be well washed in fresh water before we attempt to dry them. Some plants with articulated leaves will cast off their leaves in drying, these must be glued on again. It is uniformly found, however, that plants, even when perfectly prepared in this way, will, in the course of years, lose their character and appearance very much, although care and attention will long preserve them. Insects are very destructive to our herbariums, especially the *Ptînus Fûr*, a little beetle which lays its eggs in the receptacles of the flowers. This, as well as other insects, is expelled or killed by the solution of the muriate of mercury, which I have however found, notwithstanding the assertion of Sir J. E. Smith to the contrary, hurtful to several plants.

Our specimens may be arranged under any system we choose. That of Linnæus is perhaps the best for a beginner, and is the one which I always follow. Hoping that these few hints may be acceptable to many of your readers,

I remain, Sir, &c.

Edinburgh, May 21. 1829.

W. D.

ART. VII. *On the Necessity and Advantage of enquiring scientifically into the Practices and Results of Horticulture.* By JOSEPH HAYWARD, Esq., Author of *The Science of Horticulture*, and other Works.

Sir,

THE grand object of your Magazine, of course, is to diffuse and extend the knowledge of horticulture, and there can be little doubt that, as it affords an excellent channel for the communication of new discoveries and improvements, it must, if properly supported, be a more efficient means than any independent publication. But, as to what is the proper mode of supporting it, perhaps, a difference of opinion may exist. We know, among gardeners, as among all other artists, a high value is placed on what is called practical knowledge, and that theory is held in contempt; if, however, in the selection of your subjects you are so partially inclined towards your practical friends, as to exclude theory, it is easy to show that this is far from being the best mode of diffusing knowledge.

It is an axiom, that every operation of art is grounded on, and its effects determined by, some established principles or laws of nature; and if these are not understood, it cannot be undertaken with any certainty of success. It must follow, then, that the only effectual mode of instructing one person to perform any operation of art, with a view to produce the same effect that has been produced by others, is to convey a knowledge of the principles or laws of nature upon which such operation is grounded, and by which the effect is produced and determined; in other words, to explain the science of the art. That these truths are as applicable to the subject before us, as they are undeniable, is shown by the very general opinion which has always prevailed, that a knowledge of gardening cannot be obtained by books; for what can be assigned as the grounds of such an opinion, but the ignorance and neglect of science? And proofs enough may be adduced to show, that so little has science been understood, or attended to, in the common practice of gardening, that many of the most important operations exhibit the absurdity of an artist endeavouring to produce an effect by removing the cause, and of preventing an effect by establishing the cause. The length of time required to prove the stability of any theory; or that any observations and ideas of the results of the combination of the elements, or of the effect of any control exerted over the action of the laws and principles established by nature, for the continuation and support of the vegetable world, are true and just by practical demonstration (and which is ne-

cessary to establish the science of horticulture), is so great, and demands so much patience and attention, particularly when a repetition of experiments is necessary, that it is, perhaps, not to be wondered at, that so few persons have been induced to undertake it: and as some of even those few have given way to impatience, and published their anticipations of results, instead of awaiting those of positive demonstration; it is not surprising that the increase of books should increase, rather than diminish, the prejudice against them. But I hope there are many others, as well as myself, so attached to the art of gardening, as not to be deterred from endeavouring to raise it to its utmost state of perfection, and to establish it on the true principles of science, by any required patience or laborious attention.

It is well known, that in the pursuit of objects of difficult mental attainment, as well as corporeal, those which appeared to require more than Newtonian powers, to insure success to the efforts of any one person, have, by the united exertions of a number, been attained with comparative ease; and that it is by such means, and the liberal communications of the students and artists, that some of the most important sciences have been established. I, therefore, as an advocate of science, and an ardent admirer of the garden, take leave to propose to you, to invite your subscribers to turn their attention to the discovery and understanding of the causes of the different effects produced by the practice of gardening, by putting certain operations and applications under a regular course of demonstrative experiments, and communicating their observations and ideas through your Magazine, for the examination and discussion of your readers, as the best means to establish a system of practice on the principles of science; and I most willingly offer you my best services to support such a plan. I presume I am not unknown to you as the author of a work published with a view to establish the art of gardening on the principles of science; and, although I know that my doctrines have not been very kindly received by the generality of gardeners, I also know, that they have been thought worthy of the admiration of some of the most eminent patrons of horticulture; and I have good reason to believe that the opposition and neglect they have met with, have arisen more from their not being understood, and from prejudice and self-interest, than from any proofs having been adduced of their insufficiency. But, whatever may have been the cause of my book having failed to become popular, or of my plans not having been more generally adopted, it can scarcely be expected that any will deny the importance of my object. As, however, it is well known that gardeners in general have a

great aversion to theorists; and as it may be feared that, from want of attention, many of them are apt to confound science with theory, it may not be amiss, before we proceed farther, to offer a brief explanation or definition of the terms, art, theory, and science, and of their relation to each other; and by thus clearing the avenues, and exhibiting the object of pursuit in a clear point of view, we may possibly prevent any obstructions in our progress being raised by arrogance and self-interest.

It is an axiom, that "Every production of nature and of art is the effect of some cause;" that is to say, that all such objects are produced by a combination of certain elementary substances, brought together and upheld, or separated and kept apart, by certain established principles or laws of nature; and, consequently, those elementary substances and the principles or laws of nature are the cause, and the result of the combination or separation, the effect. It is evident, then, that before any effect can be produced, the cause must be established; and before any effect can be prevented, or made to cease, the cause must be removed; and that before we can undertake to establish or remove a cause, we must comprehend it. A discovery of the cause must be the work of the mental faculties; and a notion of the cause, as it exists in the mind only, constitutes theory. But when a theory has been submitted to practical demonstration, and thus established as just and true, it constitutes science. The act of selecting and combining or separating the elementary principles, and of directing and controlling the action and application of the principles or laws of nature, or the making of the practical demonstration, constitutes art.

To establish science then, the united powers of the theorist and the artist are required; and, therefore, instead of being kept at variance, it is obvious, that, for the extension of knowledge, the theorist and the artist should be brought to act in friendly unison. The mind of man is ever ready to suggest theories, but its conceptions are not always correct, and, therefore, the artist who suffers himself to be led into a too ready adoption of all must, undoubtedly, often be misled, and mortified and disappointed: but, on the other hand, the artist who attains his art, merely by imitating the actions of another, must always work in uncertainty and darkness. Whatever reasons artists may have for despising theorists, those who not only suggest the theory, but bestow the necessary trouble and labour to make the practical demonstrations, and communicate the results to the public, must surely be considered as entitled to their respectful attention. To establish truth, it must be necessary to attack and expose errors, where-

ever they are found to exist; for, as it has been justly said, there never was an imperfection removed by portraying perfection. All persons, therefore, who undertake such a task, must often appear invidious, and be exposed to the effect of vindictive feelings; and much of this I have encountered: but, conscious of the purity of my motives, and trusting it will be admitted, that the importance of the object is sufficiently great to supersede personal feelings, I do not hesitate to invite your subscribers to join me in my endeavours; and if they will do me the favour to give my observations their attention, I promise, that whatever observations they may be inclined to make on my conclusions, shall be met with all due candour and courtesy, and replied to with readiness. Those who are acquainted with my former writings must admit, that, if I am right, the general practice of gardening must have been, and now is, most egregiously wrong; however, leaving this to any future discussion that may be called for, I shall make my first essay on the nature of the food of plants, and the best method of preparing it; and, notwithstanding all that has been said on the subject, I hope my observations will prove to be sufficiently original and important to be thought worthy of the attention of your readers.

Although many of our most eminent chemists have been long since engaged in discovering the cause of fertility, and the means of producing and restoring it to the earth when exhausted, I am not aware that they have succeeded in establishing any improved system of practice. In these observations, however, I trust it will not be supposed that I mean in the least to depreciate their labours; I am ready to allow, that without the application and exertion of the superior abilities of the chemists of the present day, and the discoveries they have been enabled to make, the science of horticulture must ever have remained, as it appears to me ever to have been, very indistinct and obscure. The extraordinary powers of decomposition and analysis acquired by Sir H. Davy and his contemporaries, have enabled them to make such demonstrations, as, at one view, clearly show that it must have been impossible for their predecessors ever to have acquired a correct knowledge of the elementary substances combined in the formation of the different productions of nature; and, consequently, that it must have been alike impossible for them to have established the art of horticulture, or, indeed, of chemistry, on the principles of science. But, notwithstanding what has been done, it is the expressed opinion of one of its most eminent professors, that the science of chemistry is far from being complete; and, whatever improvements may have been made of late,



it cannot be doubted that much remains to be done, to make the science of horticulture complete. It is not a recent discovery, that the results of the decomposition of animal and vegetable matters impart fertility to the earth; nor that the same operations and applications of manure, being made and performed on different lands, would produce different effects; and it must always have been desirable to ascertain the cause of this difference. But as the earth, water, and air, as well as animal and vegetable matters, are all combined to produce the different effects, the cause could not have been discovered by any other means, than by ascertaining what elementary substances enter into the composition of vegetables, and also what elements are contained in the other compound substances; and then, by comparison, we may discover what part of these elements could be furnished by each, or either, of the compound substances, and thus be enabled to judge how far one could make good the deficiencies of the other; and as this could only be done by a decomposition and analysis of all the different substances concerned in vegetation, it could not have been effected by our ancestors.

These important operations, however, have been performed by the chemists of the present day; and the following results appear to be generally admitted to be just: — The earth is a compound of various metallic oxides, but as it is not found to exist in, or to affect, vegetables, in any other state than as argil or clay, silex or flint, and limestone and magnesia, it has not been thought necessary to push the analysis further. Water is formed by a combination of oxygen and hydrogen; air is a compound of nitrogen and oxygen. All vegetable substances are proved to be formed by a combination of hydrogen, oxygen, carbon, and earth; and animal substances are a compound of oxygen, nitrogen, hydrogen, carbon, and earth. By a comparison of the elements forming these compound substances, it appears that the earth and water contain, and are capable of supplying, all that is required for the composition of vegetables, except carbon; and that by the decomposition of animal and vegetable substances, in and on the earth, carbon is furnished. It must be concluded then, that carbon is the nutritive principle, or the element whose absence or presence determines the fertility of the soil; and which cannot be supplied by earth and water only.

The next object to be considered must be, what carbon is, and how, and in what state, it is to be obtained and made available to plants; and herein we find the chemists at fault: for all we learn from them is, that carbon takes its name from coal, of which it appears to be the basis, but from its affinity for other

substances, and particularly for the oxygen and hydrogen gases, it cannot be obtained in a pure and separate state, and that it cannot be exhibited, or its existence proved, by any other manner than by its effects. Before any judgment could be formed as to the best mode of obtaining and applying carbon as food for plants, it must have been necessary to ascertain what capacities are possessed by plants for feeding, or supplying themselves with nutriment; and to do this, plants have been submitted to anatomical examination, aided by the solar microscope, and it appears that they are furnished with no other organs of supply than the roots, and those, being covered by a fine sponge-like substance, cannot take into their bodies, or consume, any thing that is not in a perfect state of solution, and blended with water; and this conclusion has been confirmed by many direct experiments. Hence it must be obvious, that, to furnish the earth with the nutritive principle, it is not sufficient to supply carbon, or any substance containing carbon in a crude and insoluble state; it must be reduced to a state of solution in water, or to a state capable of being dissolved by water, before it can be appropriated by plants; and here, again, the chemists are at a stand. The only solution of carbon which they exhibit is that of carbonic acid gas, or carburetted hydrogen gas, and this has been, by some, considered to be the food of plants; but it is found by experiment, that carbon in this state cannot be made available to plants.

Although, then, the chemists have made us acquainted with the elements of all those compound substances, which are required to be brought together in the cultivation of vegetables, and thus have enabled us to determine that carbon is the grand fertilising principle, our powers are not much increased by such discoveries; as, after all, we are left to do that which gardeners have ever done, — that is, to supply the earth with animal and vegetable matter, and leave it to nature to prepare and reduce the carbon to a proper state for the sustenance of plants. And, notwithstanding it is proved that carbon is the fertilising principle, and that it can only be furnished by the decomposition of animal and vegetable substances, it is well known that the result of such decompositions, when produced under certain circumstances, will not impart fertility; which is found to be the case with the residuum of animal and vegetable matters, decomposed deep under the earth, or in stagnant water. It is evident, then, that some other principle must be combined with carbon, to render it available to plants; and, therefore, the discovery of this principle must be an object of equal value to that which has been discovered in carbon. And here, again, it may be observed, the chemists have not suc-

ceeded in clearly explaining such principle. But, although the chemists have not made us acquainted with any better means of supplying the necessary quantity of carbon, than that of collecting and accumulating animal and vegetable matters, and leaving them to be reduced by the processes of nature; nor of the principle required to make carbon available as food for plants; they have taught us, that, by availing ourselves of the knowledge of the affinity of one substance for another, we may so control and direct the decomposition, as not only to hasten it, and prevent the loss of carbon by its combination with the gases, but, by observing the effect of certain combinations, we may exert such an influence as will convert decomposed vegetable and animal matters, from an inert, into an active and available state; and thus, perhaps, lead to the discovery of the principle or element required to be combined with carbon to render it effective.

It is known, that when animal and vegetable substances are deprived of life, and left to nature, a spontaneous decomposition takes place, by what is called fermentation; and it appears, that, during the process of the putrefactive fermentation, carbon is liberated in the greatest quantity, and reduced to a state that is best appropriated as food for plants; and that, at the same time, a part of the carbon, which is liberated by this process, unites to oxygen, and forms carbonic acid gas; and a part also unites with hydrogen, and forms carburetted hydrogen gas; and, when in this state, the carbon is dissipated and lost to the plants. To prevent this loss, and, as they say, at the same time to facilitate putrefaction, the chemists recommend the addition of quicklime to the fermenting mass; but in this, I conceive, they are under a mistake; for, the formation of carburetted hydrogen gas being an inevitable consequence of putrefaction, any substance that will prevent such formation must be considered as obstructing the putrefactive fermentation. Quicklime, added to a fermenting substance, will no doubt hasten its dissolution, and at the same time prevent the formation of carbonic acid gas, but such a decomposition cannot be synonymous with putrefaction. And further, although quicklime will hasten the decomposition of animal and vegetable matter and retain the carbon, it will, at the same time, form other compounds, which are not soluble in water, and, therefore, although it prevents one loss, it will occasion another, and a greater. But, if lime be slaked before it be added to the fermenting matters, it will equally facilitate its decomposition, and form other compositions that will be perfectly soluble. Yet, however powerful, as an agent in vegetation, lime may be; and there can be no doubt, that when properly

applied, and under certain circumstances, it is capable of producing the most beneficial effects; I believe it will be found that it is not the most efficient that is produced by fire; nor that which acts with the greatest facility, in imparting to inert carbonaceous matter the active principles of fertility.

With a view to discover this, and thereby the means of preparing a substance that may be dissolved in water, and thus be capable of supplying plants with the requisite nourishment, without awaiting the result of the usual process of natural decomposition by the putrefactive fermentation, or of being under the necessity of stirring up the earth, or, when in pots, of changing the soil, and thus disturbing the roots, I made a great number of experiments; and the substance which I found to be the most efficient in every respect, in imparting those principles to the soil, which is requisite to sustain plants in health and vigour, was the serum, or watery part of blood, which separates from the clotted part, or crassamentum, after it has been a few days taken from an animal. This substance, diluted with five or six times its quantity of water, and applied, by pouring a sufficient quantity on the surface of the soil, to saturate the earth to the depth of the roots, enabled plants of every description that we are in the habit of cultivating, when planted in a soil perfectly destitute of carbonaceous matter, to attain the utmost size to which I had ever seen them grow in the most luxuriant soil; and such plants were thus brought to fructify at a much earlier period, and with greater vigour, than by any other means, or supply of food. The solid, or clotted part of the blood could not be made available, until reduced by decomposition; and as the putrefactive fermentation was unavoidably attended with obnoxious effluvia, I at first reduced it by lime, but although thus rendered soluble, and productive of fertility, it was not so much so as the serum. Desirous of ascertaining what peculiar principle was contained in the serum that was not in the crassamentum, and what created the difference in those substances, I prevailed on an eminent chemist to analyse the blood of an ox, and the result was as follows:—

The serum contained		The crassamentum contained	
Water	- 8784 parts	Water	- 5620 parts
Albumen	- 980	Albumen	- 1400
Alkaline salts	236	Fibrine	- 2400
	<hr/>	Colouring matter	580
in every	10,000		<hr/>
	<hr/>	in every	10,000
			<hr/>

The difference, then, in these two substances appears to be that the crassamentum contains no alkaline salts, and the serum

no fibrine. Hence, concluding that the alkaline salts must be the medium of solution, I added potash, in the proportion of alkaline salt and water contained in the serum, to the crassamentum, and stirring it occasionally for eight or ten days, I found the greater part dissolved, and then drawing off the liquid part, and applying it in the same manner as I had the serum, it proved to be equally efficient. And as the potassa did not appear so capable of effecting a complete solution of the clot, I added some slaked lime, which answered the purpose, and reduced the whole to a state of solution. Having by a variety of experiments with alkaline salts, been led to conclude, that as they imparted no fertility to soils that were destitute of carbonaceous matter, and that this requisite principle in the food of plants, and contained in the serum, must be furnished by the albumen, I referred to the analysis of this substance, to ascertain the elements of its composition, which are as follows:—

Albumen contains			Fibrine contains,		
Carbon	-	53 parts	Carbon	-	55½ parts
Oxygen	-	24	Oxygen	-	19½
Hydrogen	-	7½	Hydrogen	-	7
Nitrogen	-	15½	Nitrogen	-	20
		<hr/>			<hr/>
		in every 100			in every 100
		<hr/>			<hr/>

Here we not only have a proof that carbon is the variable substance, and that its absence or presence determines the degree of fertility of the soil; but we also discover the most efficient principle or agent for rendering it available to plants, and such as appears prepared for the purpose by nature, which is alkaline salt. The alkaline salts have, no doubt, been occasionally noticed as being productive of fertility, but as their principles of action were either not understood, or not properly defined, their utility has never been established. I have never seen alkaline salts described as necessary, or valuable, ingredients in the food of plants, in any chemical work. We know that alkaline salts are the production of vegetables, but, as has been observed, the result of actual experiment proves that alkaline salts do not impart fertility to the soils that are destitute of carbonaceous matter; and by the recent experiments of Sir Humphry Davy, it appears that alkaline salts are not, as they were previously considered to be, elementary substances, but compounds, formed of a metallic substance and oxygen; and that such metallic substance has such an affinity for oxygen, that it cannot exist in a separate state in contact with water. Any idea, then, that alkaline salts are reduced to their elements, and thus taken up by plants, must not be entertained.

It may be difficult to account for the existence of alkaline

salts in vegetables, or for their influence on vegetation, when blended with carbon; but in this, as in many other cases, although we find it impossible to divulge all the secret movements of nature, we may be amply rewarded for our study of, and attention to, her laws and principles; as we are not only thereby enabled to account for the effect of many important operations which have been hitherto conducted in uncertainty, but we may find the means of increasing our powers of fertilising the earth, in a twofold degree. By the reducing vegetables to ashes by fire, alkaline salts are produced; hence, then, may be traced the effect of the operation of fire in fertilising land, which is found to be different in different situations; for, it is evident, that according to the nature and quantity of the vegetable and inert carbonaceous matter, contained in the soil submitted to the influence of fire, must be its fertilising effects. Stable litter is found, in the usual process of cultivation, to afford a more efficient compost than any other combination of vegetable and animal matters, and this may be traced to the urine of the horse, which is blended with the straw. The superior fermentative qualities of stable litter, over all other matters usually collected for generating heat, may also be traced to the urine of the horse; and is accounted for by the urine being found to contain more alkaline salts than that of bullocks. Thus, according to Sir Humphry Davy, the

Urine of the horse contains	Urine of the cow contains
Carbonate of lime - 11 parts.	Phosphate of lime - 3 parts.
Alkaline salts - 42	Alkaline salts - 24
Mica - - 7	Mica - - 4
Water and mucilage 940	Water and mucilage 969
—————	—————
in every 1000	in every 1000
—————	—————

Hence it may be seen why the urine of the horse is more fertilising than that of the cow, and why a compost made of the dung and urine of those animals combined should be more fertilising than either, when applied to the land in a separate state, and which is always found to be the case. The facts being as stated, it must readily occur to every person, that an immense saving may be made, and a great accumulation of the fertilising principle, by collecting and appropriating the urine of animals, and blending it with their dung and other vegetable matters, instead of permitting it to drain off to waste, as it commonly is, from stables and cattle yards. It must be obvious, that if the refuse vegetable products of the garden and house be collected and placed in a shallow pit or reservoir, and the slop-bucket emptied on it, or, when decomposed, some alkaline salts or slaked lime be added, a much

more efficient mass of manure may be obtained, than by the usual method of disposing of it; or by digging it into the soil in a green or undecomposed state. Notwithstanding what has been said about excluding the air and rain from fermenting composts, it will be found, that when the means are provided for preventing the running off of the liquid, and that no other water be added than such rain as may fall on the surface of the dung-heap, it will have lost nothing of its value by excess of moisture.

From what is here explained as to the application of blood to plants, it must be seen, that the barely supplying a plant with nutritious matter, is not enough to insure a healthy, vigorous, and prolific growth; as such effects depend upon the proportion of matter, and the time, or season, and manner of applying it. This, therefore, requires to be duly understood, and shall form the subject of a future paper from,

Sir, yours, &c.

JOSEPH HAYWARD.

ART. VIII. *Outlines of Horticultural Chemistry: — Analysis of Soils.* By G. W. JOHNSON, Esq., Great Totham, Essex.

(Continued from p. 152.)

Two hundred grains are as eligible a quantity of any soil to analyse as can be selected. Previously to analysis, a proportion should have been kept, slightly covered, in the dry atmosphere of a room for several days, to allow it to part with all the moisture that can be obtained from it by mere atmospheric exposure. Two hundred grains of the soil thus dried, should then be placed on a small plate, and held, by means of a pair of pincers, over the flame of a candle or lamp, with a small shaving of deal upon it, until this shaving begins to scorch. The process is then to cease, and the loss of weight, sustained by the soil being thus dried, ascertained. We will suppose it amounts to  $30\frac{1}{2}$  grains. The residue must then be gently triturated in a mortar, which properly should be of agate, and sifted through a piece of fine muslin; what remains in the muslin will consist of stones and vegetable fibres; the weight of these must be ascertained, and this we will suppose amounts to  $15\frac{1}{2}$  and 5 grains respectively. The stones must be examined by dropping some sulphuric acid (oil of vitriol) upon them; if they effervesce, they contain chalk; if not, they are silicious and will be sufficiently hard to scratch glass, and will feel gritty; or they are clay stones, will feel soft, and be with little difficulty cut with a knife. That part which

passed through the muslin must now be boiled in a small tea-cup full of clean water, for about five minutes; being allowed to cool, and a piece of clean blotting paper, previously dried before the fire and its weight ascertained, employed to strain the liquor through, care must be taken to get every particle of the soil into the strainer from the vessel in which it was boiled, by repeated washings with clean water. When the liquor is all strained away, place the blotting paper on a plate over the candle, with a shaving of deal on the plate, and dry it until the shaving begins to scorch. When perfectly dry, weigh the whole; and then, the weight of the paper being subtracted, the weight of the residue, and, consequently, the quantity of matter dissolved by the water, will be afforded; this, which consists of salts and vegetable extract, we will suppose, amounts to  $4\frac{1}{2}$  grains. The watery solution must be carefully set on one side, and the analysis of the solid parts proceeded with. Half an ounce, by measure, of muriatic acid (spirit of salt) must be poured upon this in a saucer, and allowed to remain for full an hour, being occasionally stirred with a piece of glass or porcelain; this must now be strained by means of a piece of blotting paper as before, the matter left upon it being frequently washed with clean water, and the washings allowed to pass through the paper to mingle with the other acid liquor; the matter left upon the paper being perfectly dried and weighed, and the loss ascertained, we will suppose this to be 20 grains. Into the liquor must be dropped, gradually, a solution of prussiate of iron. The blue precipitate which this will occasion, being collected by filtering through paper, and washed as before, heated red-hot by means of an iron spoon in the fire, and then weighed, we will suppose it to weigh  $2\frac{1}{2}$  grains; this is oxide of iron. This deducted from the 20 previously ascertained to be in the solution, leaves  $17\frac{1}{2}$  grains, which may be considered as carbonate of lime (chalk), though probably with the admixture of a little carbonate of magnesia. The solid matter must now be heated to redness in a spoon, until upon cooling it does not appear at all black; this must then be weighed, and the loss noted; that loss consisted of animal and vegetable matters, we will suppose it amounted to 7 grains. The remainder must be boiled for about two hours with 2 drachms, by measure, of sulphuric acid, mixed with 8 drachms of water, and, when cooled, strained through blotting paper as before and washed; when dried at a red heat in the iron spoon, the loss sustained will be alumina (clay); what remains will be silica (flint). We will suppose the first to weigh 15 grains, and the latter  $102\frac{1}{2}$  grains.



The analysis will then stand thus:—

Water	-	-	-	-	50·5
Stones and coarse Sand	-	-	-	-	15·5
Vegetable Fibres	-	-	-	-	5·
Saline Matters	-	-	-	-	4·5
Oxide of Iron	-	-	-	-	2·5
Carbonate of Lime	-	-	-	-	17·5
Decomposing Matter, destructible by Heat	-	-	-	-	7·
Alumina	-	-	-	-	15·
Silica	-	-	-	-	102·5
					<hr/>
					200·
					<hr/>

The first watery lixiviation, employed to obtain the saline matter, may now be evaporated to dryness; if of a brown colour, it is chiefly vegetable extract; if of a whitish colour, it is principally saline, and probably consists of chloride of sodium (common salt), with the admixture of a little sulphate of lime (gypsum).

The above mode of analysis I have made as simple as possible, and it requires no other apparatus than a set of grain scales and weights, a little sulphuric and muriatic acids, and some prussiate of potash, the whole of which, sufficient for examining every soil upon a large estate, may be obtained for thirty shillings.

In the above are no processes requiring adroitness in the manipulation, extreme nicety in the operation, or the practised eye of science and experience to conduct. All is simple, requiring nothing but the employment of the ordinary carefulness, and the common sense, of the experimenter.

The portion of soil which it is proposed to analyse, should be taken at about three inches from the surface. Neither should the surface soil only be examined, but the substratum also. For it often will occur that the subsoil is of a better staple than that which reposes on it; or is of a quality that is capable of correcting some deficiency in it. Thus a light silicious soil will often lie upon a stratum abounding in alumina, which, by digging or trenching, may be brought to the surface and mingled with it.

The foregoing plan of analysis, it must be observed, is not one so particular as a practised chemist would pursue; but it is one easy, and capable of affording all the facts usually required to be known by a cultivator: viz. the moisture-retaining power of a soil; the quantity of soluble and decomposable matter it contains; and the proportions of its earthy constituents.

It has been urged by some that a great deal of information may be compendiously obtained, by ascertaining the specific

gravity of a soil, but of this I could never feel conviction. That a peat soil, that is, one containing a great excess of vegetable matter, is much lighter in weight than such as contain more of earthy constituents, is certain; but such do not require their specific gravity to be taken to detect them. If a soil is but rather above or under the average specific gravity, I do not see how the knowledge of that can determine whether the excess of weight arises from silica or carbonate of lime; or the deficiency of weight, from vegetable matters, alumina, or other light constituent. The specific gravity of silica is 2.66; of carbonate of lime 2.7; of alumina only 2. The unproductiveness of a soil usually arises from the excess of some one of the usual constituents which are enumerated in the foregoing imaginary analysis, rather than from the admixture of any foreign substance prejudicial to vegetation. In a previous communication (Vol. III. p. 270.), I have given the constituents of a fertile soil in detail, and to what I have stated there I have little to add. I have also stated, in another place, that a soil too retentive of moisture is seldom met with, that cannot be rectified by the mechanical remedy of underdraining. If it is purposed to ameliorate a soil which contains too much alumina, by a surface application, much judgment is necessary. The most obvious application is sand, either from the sea-shore or drift, road scrapings, coal ashes, &c.: but if these are not applied largely, the soil is rendered even worse and more difficult of cultivation; for I have seen such soils, which have had a slight dressing of silicious matters as above enumerated, rendered thereby so approaching in constitution to brick earth, that in dry weather they have become so hard as to defy any power but that of a volcano to break them up. A soil is not rendered sterile by an excess of alumina, unless it contains nearly 50 per cent of it; and, to such, nothing short of 40 tons of sand per acre would be of unalloyed benefit.

If a soil is unproductive, from containing too much silica, the obvious application to improve its staple is clay and chalk. Four hundred parts of soil of Bagshot Heath contain 380 parts of silicious sand. It is completely barren. Yet Sir Humphry Davy, who made this analysis, found that a good turnip soil in Norfolk contained 8 parts out of 9, silicious sand. Such light soils, however, are more manageable, for they are always capable of tillage; and the cultivator can render them more absorbent and retentive of moisture, by means of vegetable manures, chalk, &c. Such soils are termed hungry, for the yard manure applied to them is soon exhausted, and for this reason, that its mucilaginous and

unctuous constituents will not combine, with even a slight degree of affinity, with silica, which they will with alumina and chalk. At the same time, light soils admit rain into their texture, and to carry away their fertile constituents in the drainage waters; and the same openness of texture likewise permits the free access of air to hasten the putrefaction of the vegetable matters they contain, as well as the easy escape of the gases which are evolved, and all which, we have before shown, are equally beneficial to plants. Silica may abound to a much greater extent in a soil than any other of its usual constituents, without being unfavourable to vegetation. Chalk should never be present in a soil to a greater extent than 6 or 8 per cent; decomposable animal and vegetable matter to no more than 10 per cent; nor can the saline constituents soluble in water, oxide of iron, &c., amount to more than 6 per cent, without injury proportionate to the excess.

Foreign impregnations, causing a soil to be sterile or impairing its productiveness, are rare.

Acids have been ranked among the causes of sterility; but a soil containing any in a free state never came under my notice, or under that of any other practical chemist of whom I have ever read, or with whom I have ever conversed. Some soils, or certain portions of a field not generally so affected, will be found to produce sorrel and other plants abounding in acids: and, as when chalk or any other neutraliser of acids is applied to such spots they cease to produce sour plants; it has been deemed a legitimate conclusion that those plants obtained their acids from the soil, which being removed or neutralised by the chalk, consequently destroyed the plants by depriving them of one of their chief constituents. To say the least of it, such an opinion betrays a very great ignorance of physiology and vegetable chemistry. In the first place, the food obtained by all plants from the soil is perfectly insipid when absorbed, and whilst rising through the vessels in the woods; and no secretion, acid, or otherwise marked, is ever found in it until it has been elaborated in the leaves. It is only to be detected in them, and more manifestly in the bark. The fact seems to be, that plants abounding in acids generally frequent a wet soil, and such soil is rendered less retentive of moisture by chalk: again the contact of chalk with plants containing acids causes decomposition in them, ulcers, and if perpetually presented, death. Lastly, such sour soils, as they are termed, are usually as effectually cleared of acid plants by mixing them with other substances that will render them porous, and by underdraining them thoroughly, as they are by mixing chalk

with them. I never heard of more than one soil containing an uncombined acid, and that is in the Island of Java, near Batavia. There is a small stream there which contains free sulphuric acid (oil of vitriol); its banks being impregnated by it are, of course, barren. This stream flows into another, which, passing rapidly through a tenacious soil, is turbid from the mixture of aluminous particles with its waters. No sooner does the acidulated stream mingle with them than they become clear, for the acid combining the clayey particles forms sulphate of alumina, which is a perfectly soluble salt.

(*To be continued.*)

---

ART. IX. *On the Climate of the Eastern and Middle States of North America, with Reference to Horticulture.* By Mr. WILLIAM WILSON of New York.

Sir,

THE increase of correct knowledge on subjects in which men feel interested is at least gratifying to them, and frequently attended with benefit to others. Whether the result of the present subject will be attended with either of these effects in your country, I know not; in this, I think, it may be productive of both.

America (I allude to the eastern and middle states) is a country whose horticultural character can scarcely yet be considered as formed, in an artificial point of view; but there are abundant evidences that it possesses a naturally far more congenial climate for horticultural productions than most other countries. The want of those external, artificial, horticultural refinements, so conspicuous in European countries, and particularly in England, has been the ground of a very erroneous and detrimental impression of the actual inferiority of its climate to that of those countries. This impression has long been augmented by the vast superiority which emigrants from England very naturally, some of them very pertinaciously, ascribe to the climate of their native land, being either unable or unwilling to discriminate between the results of natural and artificial effects. With a view to benefit my fellow-citizens, by removing this impression, and to encourage them to avail themselves of the favourableness of the climate, I have endeavoured to demonstrate, by actual facts, its superiority to that of England; I have contrasted, I think upon a fair scale, the horticultural effects of the natural powers of this climate and that of England. If the grounds I have proceeded on are just, the preference in favour of this climate, at least for

the articles I have particularised, will, I think, be found undeniable.

To compare the horticultural products cultivated by artificial means in one country, with those of any other where no such artificial means were necessary to bring the same kinds of products to perfection, would be like comparing the natural climate of Iceland with that of Jamaica; because, in the former, orange trees might be as well cultivated in the greenhouse, as they are in the open air in the latter. Yet there can be no more justice in denying the superiority of this climate to that of England, for every article it is capable of bringing to perfection more than that of England, than there would be in asserting that, because the orange tree could be grown as well in Iceland as in Jamaica, that therefore the climate of the latter was not superior to that of the former. With the admission of one of these species of reasoning, the whole fraternity of horticulturists might as well be transmogrified into a race of funguses altogether. Several communications published in the *New York Farmer and Horticultural Repository*, on this subject, display a mode of reasoning more like the effusions of some kind of vegetable than animal production; and, were it not for the lively strain of irritation (not common to vegetables) kept up through the whole discussion, it might be considered more an affair of pumpkins and squashes than the actual bickerings of highly excited horticulturists. The subject, however, of the superiority of the American climate to that of England, for horticulture, is an interesting one; and being perfectly within the cognizance of the horticulturists of the present day, nothing can be easier than to obtain correct information of the difference between them, by obtaining a list of all those products which, in the natural climate of each, can be raised and grown to perfection, as well as a list of those that require artificial aid to bring them to perfection in the one country, but which, from the superior congeniality of climate in the other, require no such assistance. In the twelfth number of the *New York Farmer and Horticultural Repository* I have published a list of thirteen kinds of fruit and vegetables, which are all grown to perfection in the open garden or the field in this climate; the correctness of which statement can be corroborated by every experienced horticulturist in this country. I have proposed Mr. Buel of Albany as an umpire, if necessary, on the subject; and to your decision I have submitted the determination whether they can be so cultivated in the natural climate of England:—

*List.* — Grape, Peach, Nectarine, Cucumber, Melon, Water Melon, Pumpkin var. Vegetable Marrow, Squash, Indian Corn, Lima Beans, Pepper, Tomatoes, Okra.

I am aware that the practicability of cultivating the cauliflower, broccoli, and gooseberry used to be denied to this country; but for this there is no just foundation, the difficulties that have existed in the cultivation of these articles being solely attributable to the want of proper management on the part of the cultivators. In the gardens of Martin Hoffman, William Ogden, Henry A. Coster, John Hone, Esqrs., and others in this vicinity, the cultivation of the cauliflower and gooseberry was as well understood nearly thirty years ago, and their produce as certain, as those of other crops. Within these few years past, the most complete success has been attained in the culture of broccoli; and, in the depths of winter (that magnified bugbear), there is not the least difficulty in retaining a most abundant supply of the very best kinds of vegetables.

For some further information on this subject, I would beg leave to refer you to the first volume of the *New York Farmer and Horticultural Repository*, particularly the twelfth number, as in it is expressed a wish for some information from you on the subject of cottagers' gardens. Should there be any service that I can render you in the horticultural affairs of this country, nothing would give me greater pleasure than to perform it to the best of my abilities. Being born and brought up as the son of an humble gardener in Kinross-shire, and having spent the chief part of all my days at the spade and hoe, I am but a very awkward hand at the management of a goosequill; yet should you think the above contains any thing that might be useful or entertaining to the readers of your Magazine, it is most cheerfully submitted by,

Sir, yours, truly,

New York, Jan. 1829.

WILLIAM WILSON.

IN a review of the *New York Farmer and Horticultural Repository*, which, if not inserted in the present, will be found in our succeeding Number, we have given our opinion on this subject, which is simply this: that though in America, as in the south of France and Germany, fruits will ripen in the open air, which will not ripen in the open air in England; yet, from the severity and long duration of the winters in the former countries, the common culinary vegetables and many exotic trees and shrubs which live in the open air in England during winter, are obliged to be protected, or are killed, and therefore we consider England the preferable country for horticulture, taking that word in its most extensive sense, or equivalent to the meaning that we apply to the word gardening. But taking the word horticulture in its strict sense, and

considering it as the art of cultivating culinary fruits and vegetables, we consider Germany and America preferable to England, because more may be done in the open air in those countries, than in England, and as much by protection, by forcing, and by artificial climates. — *Cond.*

---

ART. X. *Some Account of the Botanic Garden at Lisbon.* By  
W. CHURCHILL, Esq., Royal Marines.

PORTUGAL, adapted by nature for easy culture of the vegetable productions of the torrid and temperate zones, the first coloniser of India, till within a few years mistress of Brazil, and still retaining extensive African possessions, has never stood forward as the patroness of botany. Unlike Spain, who under every disadvantage has laboured hard for the science, she can boast of but few individuals, who, incited either by a laudable curiosity or more enlightened views, have availed themselves of her natural advantages, to introduce those botanic treasures to which for nearly three centuries there has been access; though, like her, the ignorance, inappetence, and poverty of her legislation, have for years been formidable impediments to the advance of science.

The Royal Botanic Garden at Lisbon is situated on the side of a hill (*fig. 82.*), sloping with a considerable declivity

82

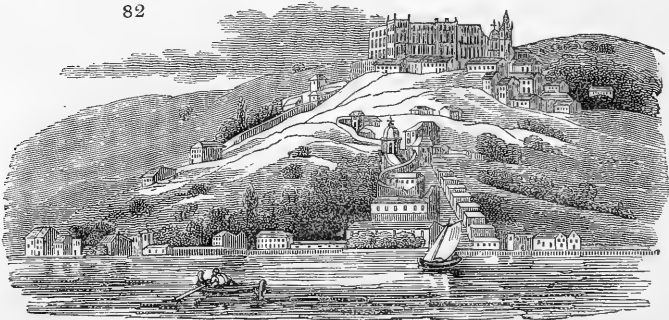

to the Tagus, a little below the Palace of Ajuda, and enjoys a full exposure to the south. It covers a space of about two acres, surrounded by a high wall, round which on the inside and up the centre is a shady walk of *Laúrus nóbilis*, *Cércis Siliquástrum*, *Ceratonia síliqua*, and *Júglans règia*. The south wall has in front a wide terrace, on which the botanic houses are built; descending from these by steps you arrive at the pleasure-garden, as it is termed, which, together with the terrace,

occupies about one half the space enclosed, the remainder is devoted to walks, orange, lemon, and citron quarters.

Art being the avowed object in Portuguese gardening, the eye is offended by the mechanical rigidity of the parterres, the clipped, rectangular, box alleys, and the grotesque embellishments, characteristic of the gardening of the south of Europe, which disfigure the pleasure-garden; but the number of acclimated exotics to be seen there, vigorous and unsheltered, makes it an object of the greatest interest.

The plants are grown without reference to their natural orders or to any system, and have been casually planted from superfluity that has arisen among those classed, or from their having become too unwieldy for culture in pots or boxes. Of the genera thus cultivated in the open air, I enumerate all those that were named, or that I could recognise; few of them had a specific attached, and when such a thing did occur it was rarely intelligible, being most frequently in the Portuguese language, and sufficiently vague and unsatisfactory. Ex. gr. *Amaryllis reginæ* was marked *Amaryllis vermelha com duas flores do Brasil* (a red two-flowered *Amaryllis* from Brazil). Many genera too there were named in honour of their donors, or that had chanced to flower on some saint's day and bore his or her holy name; the generic appellations also being from Tournefort (many of which have long since merged into specific), in some instances, increased the difficulty.

The natural orders *Cánneæ*, *Scitamíneæ*, *Bromeliæ*, *Amaryllidææ*, *Lauríneæ*, *Leguminósæ*, and *Cácti* were very rich, and contain most probably many genera entirely new, particularly *Scitamíneæ*, *Amaryllidææ*, and *Cácti*.

It may be necessary here to mention that the thermometer, at Lisbon, frequently falls as low as 29° and 27° of Fahr. I have seen the fountains in the Royal Garden covered with a thin coat of ice in the morning, when the year was as far advanced as April, without the plants appearing to suffer injury, with exception of *Cárica Papàya*, killed in the winter of 1825 by frost supervening on rain; growing in an arenaceous soil, they seemed to be more retarded in growth by the want of moisture in summer, than by the humidity and cold of winter. *Erythrìna cárnea*, *E. fúsca*, *E. pícta*, *E. crísta gállì*, flower well; the latter in autumn, winter, and spring, *E. pícta* ripens seed on a tree more than 15 ft. in height. *Psídium pyríferum*, *P. pomíferum*, both set their fruit, but they do not attain maturity; were the shrubs grown against a south wall instead of an exposed situation, there is little doubt the fruit would be perfected. *Coffèa occidentális* fruits freely; the plants flower in October, and the berries ripen in May and June following.



*Laúrus Pérsa*, *Bùtea frondòsa*, *Bùtea supérba*, *Laúrus Cássia*, *Anacárdium occidentàle*, *Arèca Câtechu*, *Borássus flabellifórmis*, *Convólulus Ipecacuanha*, *Quisquàlis índica*, *Pitcaírnia bromeliæfòlia*, *Agàve Karátto*, *Furcræ a gigantèa*, *F. tuberòsa*, *Agàve lùrida*, *Alpínia nùtans*, *Cóstus speciòsus*, *Tácca pinna-tífida*, *Calypránthes Jambolàna*, *Maránta zebrína*, *M. arun-dinàcea*, *Zinziber officinàle*, *Cánna pàtens*, *Jasmìnum Sámbac fl. plèno*, *J. hirsùtum*, *Eránthemum pulchèllum*, *Stachytárfheta mutábilis*, *Píper nigrum P. lóngum*, *Comoclàdia integrifòlia*, *Márica palmifòlia*, *Calàdium bicolor*, *Euryàle fèrox*, *Nelúmbium speciòsum*, *Nymphæa stellàta*, *Commelina bengalénsis*, *Sác-charum officinàrum*, *Ixòra coccínea*, *Dorstènia Contrayérra*, *Convólulus grandiflòra*, *Morínda umbellàta*, *Cérbera Ahoúai*, *Nèrium odòrum fl. plèno*, *Mùsa paradisiaca*, *Hæmánthus coccínea*, *H. carinátus*, *Crìnum americanum*, *C. erubéscens*, *C. undulátum*, *C. amábile*, *C. cruéntum*, *Cyrtánthus oblìquus*, *Brunsvígia falcàta*, *Amarýllis vittàta*, *A. reginæ*, *A. aúlica*, *A. reticulàta*, *A. pulverulénta*, *A. acuminàta*, *Pancràtium littoràle*, *P. undulátum*, *P. Amáncaes*, *P. verecúndum*, *P. calathìnum*, *Yucca aloefòlia*, *Aloe fèrox*, *A. foliòsa*, *A. verrucòsa*, *Acàcia pernambucàna*, *Mimòsa sensitíva*, *M. pudíca*, *M. rubi-caúlis*, *M. odoratíssima*, *Stercùlia Balánghas*, *S. platanifòlia*, *Játropha Mánihot*, *Caméllia víridis*, *Sida arbòrea*, *Cáctus hexagòna*, *C. heptagòna*, *C. tetragòna*, *C. Fìcus indica*, *C. elátior*, *C. cochinnifera*, *C. spinosíssima*, all flower freely ; but do not, except the Cacti, perfect seed. The plants that had not flowered \* when I last saw the garden, in 1826, were *Diospýros sylvática* and *ebènum*, *Fìcus índica*, *Unòna odoràta*, *Mimòsa Ceratònia*, *Smilax zeylánica*, *Phcènix farinífera*, *P. dactylífera*, *Cròton Tiglium*, *Caryòta ùrens*, *Rhàpis flabelli-fórmis*, *Zàmia integrifòlia*, *Córypha umbraculífera*, *Licuàla spinòsa*, *Dracæna fràgrans*, *Pitcaírnia bracteàta*, *Blètia Tankervíllia*, *Mangífera índica*, *Achras Sapòta*, *Ardísia littoràlis*, *Ipomœa brasiliénsis*.

(To be continued.)

---

ART. XI. *On Straw or Reed Mats, as a Covering for Hot-houses and Hot-beds.* By PETER LINDEGAARD, Esq. C.M.H.S., Court-Gardener to the King of Denmark.

Sir,

I OBSERVE, in a late Number (Vol. III. p. 167.), a paper on the construction and use of straw mats in gardening, by Mr.

\* To be understood as referring to those named or known.

Shennan, of which I very much approve. Mr. Shennan is certainly right in saying that they produce a great saving of fuel, and afford a great security from accidents of different kinds; and I wish to add, that they afford also a very superior degree of temperature over common *bass* mats, and also allow the steam of moist hot-beds to pass easier off. When, as often happens in this country, a heavy fall of snow takes place during the night, the *bass* mats are not so easy to get cleaned and dried the next morning as the straw mats, because they retain the moisture, and get frozen and stiff by the frost penetrating through them; and the next evening they cannot be put on again, without great risk of breaking the glass. Straw or reed mats are also a great deal cheaper than Russia mats. Were I to use Russia mats in my forcing department, I should require more than 1000 mats for about 400 lights, which I now cover with 400 straw mats. It is evident, therefore, that the use of straw mats well deserves the attention of market-gardeners.

These mats may be made of rye or wheat straw, or of reeds. All I use are made by my workmen in the winter time, when the weather is too bad for working out of doors. I enclose a rough sketch (*fig. 83.*) to show how they are made.

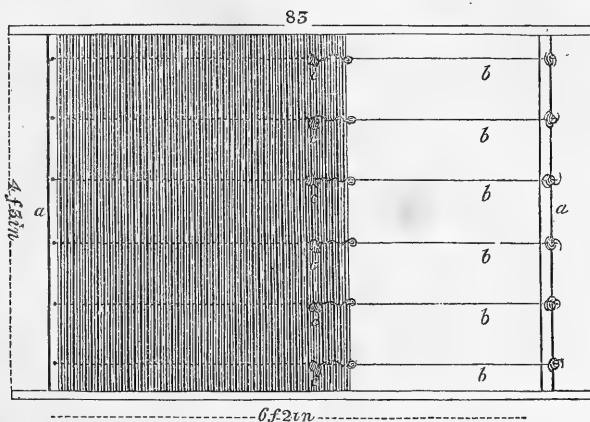

An oblong square is formed of four laths along the two ends of which (*a a*) are driven as many nails as you wish to have binding cords (*b b b b b b*), of which I never use fewer than six, as the strength of the mat depends chiefly on the number of these cords. The cords I use are of tarred rope-yarn; on these I lay the straw or reeds in handfulls, and bind

it to each longitudinal cord by other cords, which for greater convenience are made up in little balls (*c c c c c c*). These cords are also of tarred rope-yarn. I understand from Mr. Shennan, that he leaves his laths in the mats, which I should think would not be very convenient for rolling up. When a mat is finished, the cords are tied together at the top or finishing end; the mat is then detached from the straw, and its sides chopped straight with an axe. These mats are more conveniently made by two men than by one man; and by placing the frame upon a raised bank or bench, than by placing it on the ground, and obliging the men to stoop. When straw is used, that of rye is the best, and will last, even with us, three years; reeds last longer.

During our most severe frosts, I cover with straw mats rolled lengthways, i. e. from top to bottom, over the lights, and with reed mats over these crossways. By this mode the reeds lie in the direction of thatch on a house, so that the water runs off them, and keeps the straw mats below and the lights perfectly dry. Further particulars are rendered unnecessary by Mr. Shennan's very distinct directions, and I have only to add, that, if you choose, I will send you a reed mat and a straw mat, as specimens.

I remain, Sir, &c.

Copenhagen, March 28. 1828.

P. LINDEGAARD.

WE shall gladly receive specimen mats, which we shall deposit at Weir's Agricultural Implement Manufactory, Oxford Street, for the inspection of gardeners and others, who may wish to profit from M. Lindegaard's paper and that of Mr. Shennan. In the mean time, straw mats may be seen in use in Henderson's Nursery, Edgeware Road, and in the Clapton Nursery. — *Cond.*

---

ART. XII. *Remarks on Metallic Hot-houses.*

By Mr. GEORGE M'LEISH.

Sir,

You have repeatedly invited your readers to offer practical remarks on any subject connected with gardening, and particularly on new inventions or practices which have been noticed or recommended in the Magazine. This, you have also repeatedly said, is the only way of arriving at truth, and the nearest road to fix the principles, and establish the general rules, of our art. Under this guarantee I now beg to send

you a few observations on the defects of curvilinear iron roofs, which have occurred to myself in the management of a house of this description, in the county of Dorset.

This house was divided by a glass partition: both divisions were paved with tiles, and, when I took charge of them, served as green-houses, with vines trained on a trellis under the roof. One of the divisions was afterwards converted into a pinery; but, however occupied, I always found it impossible to keep the temperature of the houses to the required degree. The circular roof concentrated the sun's rays so immoderately, that the tops of the vines were actually scorched, even when the doors and ventilators at the back were all open. This was always the case in summer; and in winter, it was with the greatest difficulty, and only with the assistance of mats, that we could keep out the frost; the thermometer frequently indicating only 40°, when strong fires were burning.

I annex a section of the house (*fig. 84.*) merely to show the outline of its construction, which I have found so defective. In the first place, the highly rarefied air under the roof could not readily escape by the ventilators behind; and the heat reflected from the paved floor increasing this unnecessary temperature, the vines suffered: and in the next place, during winter, the heat rising from the flues was dissipated upwards, and the whole volume of the air within became cooled below the necessary degree.

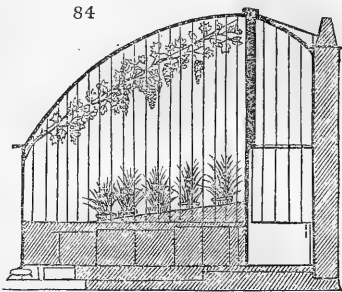

It is true, this house may have been badly contrived, and imperfectly finished; still, I am of opinion, that all houses having iron roofs will be liable to the same objections, if proper means be not taken to command the admission of air in one season, and to keep up the proper degree of heat in the other. I take the liberty of adding this remark, as a warning to those who may, for the sake of neatness and durability, resolve to have such houses erected.

I am, Sir, yours, &c.

*Atherstone Gardens, May 15. 1828.*

GEO. M'LEISH.

ART. XIII. *Description of a Hot-house, combining a Pinery, Vinery, Succession Pit, and Winter Green-house, all heated by one Fire.* By ABRAHAM CALDICOTT, Esq. F.H.S.

Sir,

I ENCLOSE you the plan of a combined pinery, vinery, and succession pit, which I have tried for several years, and found to answer remarkably well: and when it is considered that

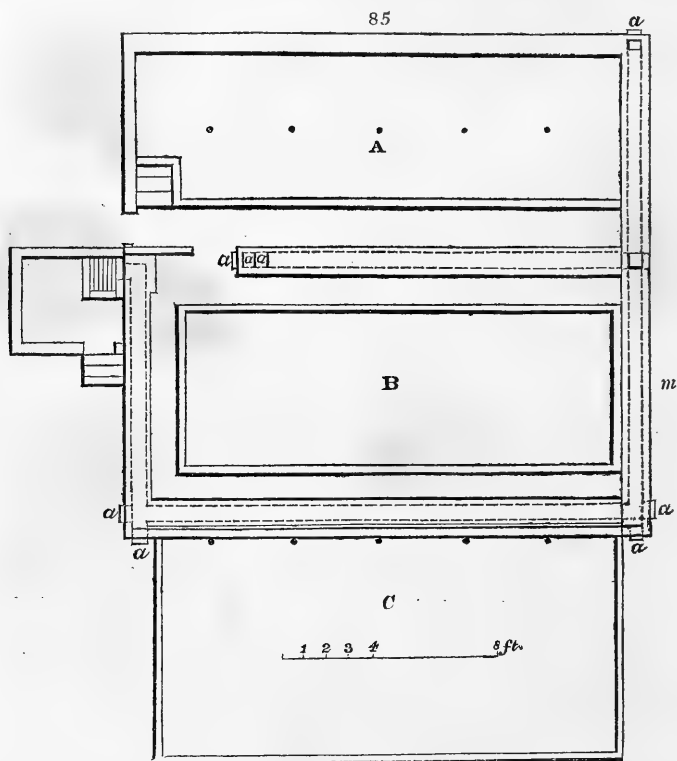

the vinery (*fig. 85. A*) serves also as a winter green-house, and that one fire suffices for the whole, I will venture to say that by no other plan can the same quantity of fruit be obtained, and the same number of objects effected, by one single fire, and, consequently, at so little expense.

The pinery (*B*) is ventilated in the early part of the year by the air from the vinery (*A*), in order that the rawness of the air may be qualified in the vinery before it reaches the pines; consequently, a freer circulation may be admitted, than

could be allowed, were the external air to have a direct access to the plants.

The vinery requires no flues, being supplied with heat from the pinery, thereby saving considerable expense; and, by training the vines on pendent trellises, a greater supply of fruit is obtained than by any other way, besides the pleasant appearance it gives to the house. The vine border (c) is raised, in order to keep the roots of the vines sufficiently dry.

I am, Sir, &c.

AB. CALDICOTT.

Rugby Lodge, Warwickshire, Feb. 19.

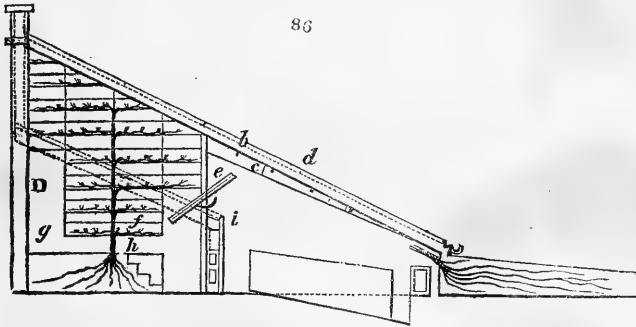

*Pinery (figs. 85. and 86.).*— *a a* (*fig. 85. B*) are stone stoppers, by which the flues may be cleaned without being broken into. Iron rods 20 in. in length are screwed across each rafter (*fig. 86. b*), with holes 4 in. from the rafter and at the ends, for copper wires to pass through. These four wires, with two others close to the side of the rafter, and resting upon the rods, will support two vine stems with their lateral bearing branches. The projecting irons (*c*) are in the form of an inverted T, having a hole at each extremity of the cross-bar, which is 6 in. long, for wire to pass through for the support of the two shoots intended for the bearing wood of the ensuing year, after which they will be raised to the upper wires. The lights (*d*), instead of sliding over each other, lie quite flat, exhibiting an even surface; and this is effected by a plate of copper laid under the glass of the upper light, and extending about 2 in. over the top rail of the lower light, which is bevelled off for its reception. None of the lights need be made to open, in consequence of the windows between the houses, and one at each end of the pinery, which latter is never opened except in the hottest weather. In the vinery all the uppermost lights are made to pull up over the back wall about half way, being prevented from going farther by an iron stop placed at their sides; strips of wood about 4 in. broad may be screwed

in the rafters to keep the wet from the joints, and prevent the lights from being blown away. The windows (*e*) are kept open by a fastening in the shape of a quadrant, which, being screwed on the side of the window, passes through a narrow plate fastened in the uprights, and furnished with a screw to fix the window at any desired height.

*Vinery* (*fig. 85. A* and *fig. 86. D*). — The pendent trellis (*fig. 86. f*) is fixed to each of the rafters, the perpendiculars of which are made of narrow hoop-iron, and the horizontals of copper wire, except the lowermost six, which, to keep the perpendiculars at their proper distance, are made of thin iron rods. The vines are trained on the back wall, as well as on the trellises; and the upper branches are pruned by resting a plank on a ladder at each end of the house. Planks (*g*) are laid on bricks to walk upon, instead of pressing down the border. On this border (*h*) the green-house plants are set in winter.

*Succession Pits* (*figs. 87. and 88.*). — The succession pit (*fig. 87.*) is built at one end of the pinery. (*figs. 85. and 87. m*) Its flue (*k*) opens into the pinery flue at this end only; so that,

87

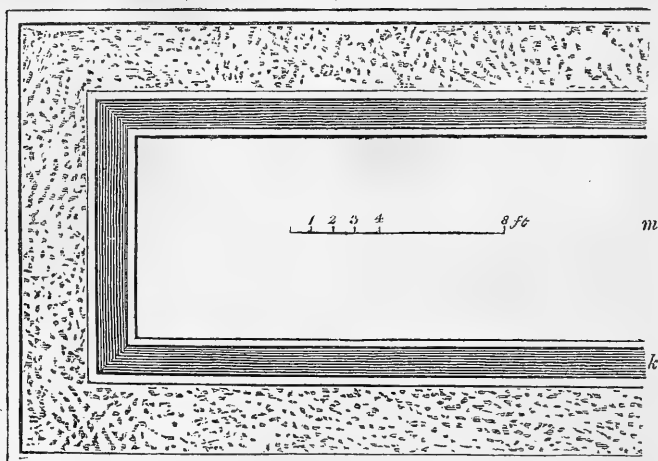

though the air of the pinery flue enters it, it has no current through. *Fig. 88.* is a section of the pit. It has a steam flue (*l*) which is closed at both ends, but the external wall of it is open brickwork; so that the steam from the dung passes into the flue, and thereby warms the air of the pit. For the same purpose, a thick tarpawling made to roll up and down on a pole, so as to cover the glasses in cold weather, may be used. The space outside the pit is filled with tan up to the level of the bed inside once a year, generally in November; and above that is put dung, which is renewed as often as the heat declines. In-

stead of the partition (figs. 85. m and 88.) between the pit and

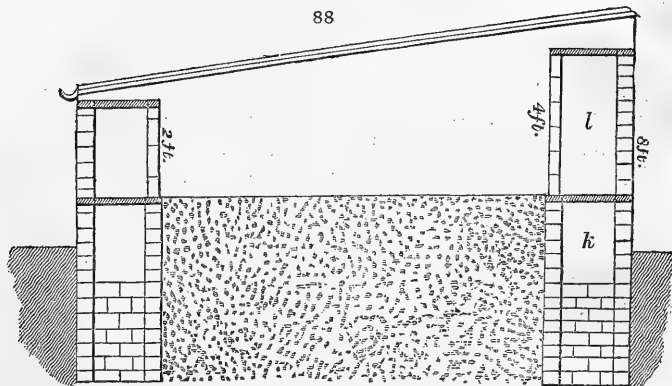

the pinery being brickwork, the upper part of it, viz. that above the tan, consists of a long door hung horizontally on hinges, and made to fall back on the flue in the pinery, for the sake of admitting the heated air of the pinery into the pit, whenever the severity of the weather renders it necessary.

The *Green-house* is formed by using the vinery, in the winter time, for the purpose of preserving green-house plants.

---

ART. XIV. *On the Natural Succession of Forest Trees in North America.* By J. M. of Philadelphia.

Sir,

IN Vol. III. p. 351. an extract is given from Evelyn's letter to Sir John Aubrey, stating that beech trees grew in place of oaks which had been cut down by his grandfather, and that birch succeeded beech which his brother had extirpated. In the United States the spontaneous succession of timber, of a different kind from that cut down, is well known. In the *Memoirs of the Philadelphia Society for promoting Agriculture*, vol. i., there are several papers on this subject, by the president, the late Richard Peters; by Dr. Mease; by Mr. John Adlum, who had long been a surveyor in the new settlements in Pennsylvania; by Dr. Caldwell, in reference to the fact in North Carolina, in Massachusetts, and in New Jersey; and a confirmation of it in the last-mentioned state, by Mr. Thomas F. Leaming. In the third volume, Mr. Isaac Wayre, son of the American general the late A. Wayre, also gives some interesting details respecting the appearance of timber trees, of a kind different from those which formerly covered the ground in his vicinity, and which had been cut down by



the American army, when encamped there in the autumn and winter of the year 1777, and spring of the following year. One of the above writers refers to the relation of Mr. Hearne (*Journey to the Northern Ocean*, p. 452.), for the fact of strawberries growing up wild near Churchill river, and in the interior parts of the country, particularly in such places as have been formerly set on fire; and for that of hips and raspberry bushes shooting up in great numbers, in burnt places, where nothing of the kind had ever been seen before. Cartwright is also quoted, in proof of the point. He observes, "that if through carelessness the old spruce woods are burnt, or by lightning, Indian tea first comes up, currants follow, and after them birch." (*Journal of Trans. at Labrador*, vol. iii. p. 225.) Nine years after the publication of this last work, M'Kenzie stated, that "land covered with spruce-pine, and white birch, when laid waste by fire, produced nothing but poplars:"\* and yet the Edinburgh reviewer of his work very indelicately declared his disbelief of the relation. Recently, we have additional testimony on this subject. In the manual on the culture of silk, prepared in consequence of a resolution of the House of Representatives of the American Congress, and published in the session of 1828, it is stated (p. 38.) that "in Tennessee, when a native forest is cut down, if the land be enclosed, a growth of red mulberry trees soon takes place." All these statements do not admit a doubt to be entertained of the natural succession of forest timber; the fact is moreover familiar to every man who has lived in the country, and to almost every intelligent person in North America. I regret that the enterprising voyager did not live to shame the northern critic for his rudeness, and to enjoy the satisfaction of seeing his own testimony of a curious and interesting fact in natural history confirmed by others.

J. M.

*Philadelphia, May 1. 1829.*

---

ART. XV. *Notice of a Machine for transplanting large Trees, in Use in Thoresby Park, Nottinghamshire.* In a Letter to Mr. Mackay, of the Clapton Nursery, by Mr. BENNET, C. M. H. S., Gardener at Thoresby. Communicated by Mr. MACKAY, F.L.S. H.S., &c.

Dear Sir,

I SEND you a sketch of a machine (*fig. 89.*) for removing trees from 10 to 15 feet high or more, and which I think

\* Voyage from Montreal to the Frozen and Pacific Oceans. London. 1801.

one of the best that has hitherto been in use. It was invented by the late planter of Ld. Manners, about fifteen or sixteen years ago, and used with the greatest success by him, and, since his death, by myself, on whom his department has devolved.

I am so highly satisfied with this machine, that I feel convinced whoever tries it will never attempt to plant a large tree without it; at least, if rapidity, economy, and masterly workmanship are the objects desired.

It may be made by any country carpenter, of any sort of timber, and of any size. I am going to have a smaller one, than that represented by the sketch, for the transplanting of evergreen

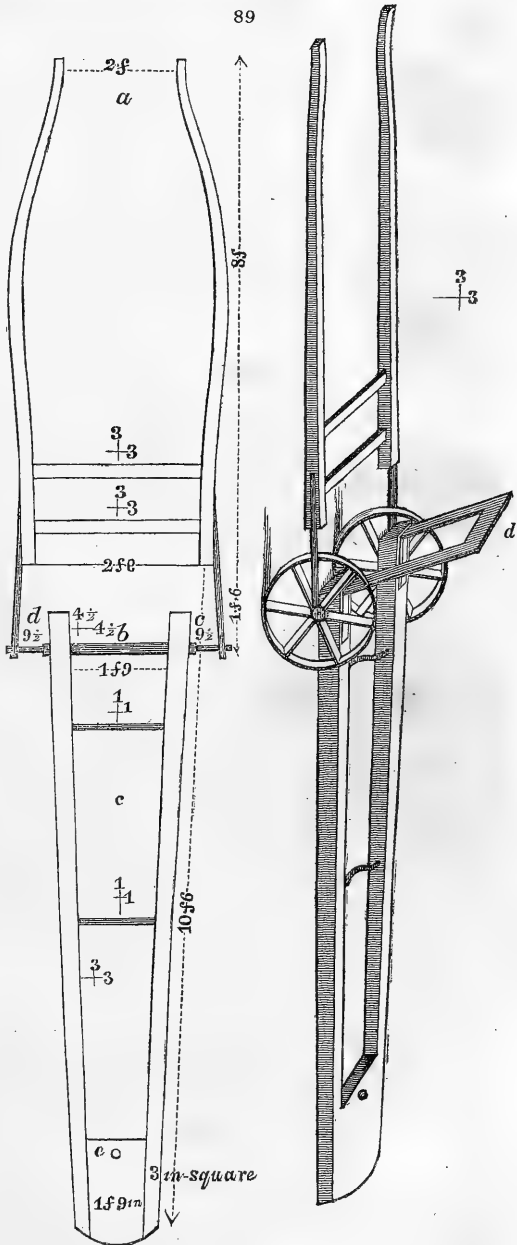

shrubs with balls, which will be very useful in the pleasure-ground.

I am, Sir, &c.

S. BENNET.

*Thoresby Park, near Ollerton, Nottinghamshire,*

*Dec. 15. 1828.*

In using this machine, the shafts (*a*) are first taken off by withdrawing an iron bolt (*b*); the body of the machine (*c*) is then made fast to the tree by a rope, which passes through the hole (*e*). The tree and the machine with the wheels are now upright; and the part of the machine over the axle (*d*) being placed against the lower part of the trunk above the ball, previously dug round, the tree and machine are pulled down to the horizontal position, the shafts re-attached, and the horse yoked ready to draw the tree to the hole prepared for it.

ART. XVI. *Method of cultivating the Mulberry in the Government Mulberry Plantation at Nymphenburg, with a List of the different Species and Varieties grown there.* By M. BISCHOF, Nursery-Gardener to the King of Bavaria.

THE ground selected for sowing must be well trenched, and freed from large stones. Heavy clayey earth is unfit for receiving the seeds, but light garden soil or black sandy mould should, if possible, be selected. The ground being parted off into beds, trenches of an inch deep are made at intervals of 6 in., in a longitudinal direction. The time for sowing is about the middle of May. As soon as I get my seeds I put them into a dish full of water, in which they remain for 24 hours, when the good seeds settle at the bottom, and the bad are found swimming on the surface, and may be removed from the rest. The good seeds are then mixed with fine sand, in order that they may be sown more equally; they are thinly scattered in the trenches, and slightly covered with fine light earth. Being watered twice a day, the young plants will appear in three or four weeks. During the summer they must be kept free from weeds, the earth between them frequently loosened and watered, and be protected against excessive heat by a light shade. The mole cricket (*Grýllus gryllotalpa*) is my greatest enemy, and the best method I know of destroying it is by sinking oblong vessels, about 6 in. deep, and half-filled with water, in which they are caught during their nightly excursions. On

the approach of winter, the seedlings must be covered with dry leaves, to the depth of 6 in., to protect their roots from the cold. In March, when the ground is thawed, the young plants are taken up, cut down to one eye, shortened a little at the roots, and then planted into a piece of rotten ground, in rows, at distances of from 2 ft. to 2½ ft. apart, and about the same distance in the row; they require no farther attention during summer than being watered and weeded. I must observe, that, in cases where two or three eyes have been accidentally left on the plant, they must be afterwards cut out when they begin to push, leaving only that which makes the strongest shoot. During winter they are again covered over; and in the ensuing spring cut down, for the last time, to one eye, without being transplanted; after this they become strong enough to withstand the winter, and are allowed to form a crown.

In our severe climate the following mode of grafting, called *Pfeifeln* (flute-grafting, *greffe en flute*, Thouin), is found to be preferable for the mulberry. (*fig. 90.*) The twigs which are

cut off for grafting are kept in a cellar. As soon as the sap rises in the wildings, a grafting twig is selected of the same thickness as the wilding, or even thicker; on this twig a circular incision is made, half an inch above, and another half an inch below, the eye, and the bark between the incisions, together with the eye, peeled off. The same operation is performed on one of the branches of the wilding, close to the stem, in the crown. The bark of the wilding is then exchanged for that of the grafting twig, and the wound bound up with matting or tape, covered with grafting wax, to keep out the external air. If the bark of the grafting twig is too long, it may be reduced to fit the wood exactly. The advantage of this method is, that the grafted part cannot be distinguished from the rest, and the tree, in case the graft fails, loses nothing of its strength, as is the case in the usual mode. In the fourth year all the trees are re-transplanted, with a view of improving their roots, and giving them more space. At the same time, the branches are shortened to where the crown is to begin, and, the roots being trimmed a little, the trees are planted from 3 to 4 ft. apart. There are now about 10,000 trees of this size in the plantation.



List of the Species and Varieties of *Mòrus* growing in the Government Plantation at Nymphenburg: —

Large White Mulberry.	<i>Mòrus hispànica</i> .
Small White, with small leaves.	<i>M. nigra</i> .
Foglia doppia, or double leaf.	<i>M. rùbra</i> .
Foglia zazola, or indented leaf.	<i>M. rùbra</i> , from New York.
Superexcellent (vorgzüglichste).	<i>M. constantinopolitana</i> .

I have, moreover, received forty-two plants from Dr. Sacco of Milan, which he calls "particular kinds." All these species, with the exception of the *Mòrus rùbra* from New York, I received through the Agricultural Society, from Italy.

I am, Sir, &c.

M. BISCHOF.

*Royal Nursery, Nymphenburg, Nov. 1828.*

ART. XVII. *On the Cultivation of the Hyacinth.* By THOMAS FLEETWOOD, Gardener, of Donnington. Read at the Meeting of the Vale of Evesham Horticultural Society, September 24. 1828.

To improve the culture of hyacinths and preserve the bulbs in good health, and to enable them to produce the finest blossoms, plant them in the third week of September in the following manner: — Take off the surface of the earth from the bed where they are to be planted, 12 in. deep; after loosening the soil for the next 6 or 7 in. by digging and making it level, add 4 in. of good well-rotted dung all over the bed; this done, take light, rich, vegetable soil that has been sifted and kept dry for three weeks previous to the time of planting, cover the dung with the soil so prepared 2 in. thick; then place the bulbs on the dry soil 10 in. asunder each way, and cover them 1 in. overhead with the above sort of dried soil, raising the beds to a level with the natural earth. On the approach of frost I cover the beds with dry litter, to prevent the frost from raising the bulbs out of the earth. When the severity of the frost is gone, remove the litter, and clean the bed as necessity may require, until the first bells begin to open; then carefully support them with a small stick, raising it 10 in. out of the earth, carefully placing between every row a layer of clean cake moss, to prevent their being spotted with dirt by heavy rain. I attend to the same method in planting them round circles or ovals, in all cases carefully mixing their varieties. To cover the bulbs with rotten dung is as injurious as to plant them in damp soil. In preparing pots for hyacinths, select those about 6 in. in depth

and width, and put in them 2 in. of good rotten dung. Then fill them well within, the thickness of the bulb, with rich light soil, placing in each pot three bulbs of different varieties; partially cover them with the same sort of soil, leaving a third part of the bulbs visible. Place them in a dry situation, and give them but very little water the first five weeks, increasing it with the growth of the roots until they have done flowering. Add no water after the leaves begin to decay; cover the pots with litter to preserve them from bursting by the frost, and place them in an open shed till the blossoms begin to open. Take them out of the earth as the leaves begin to decay, carefully cleaning them; but never remove the offsets until the leaves are withered away. When the bulbs are partially dry, take off all the decayed parts, separate and number each variety, placing them in the day where plenty of air can be admitted until the time of planting.

I never saw a double hyacinth produce seed; but by impregnating the blossoms of the single hyacinth with the farina of a double variety, I have succeeded in raising a fine double flower.

---

ART. XVIII. *On the Culture of the Pine-apple without Pots, in the Royal Kitchen-Gardens at Nymphenburg.* By MR. JOSEPH LANG, Kitchen-Gardener to the King of Bavaria.

Sir,

THE satisfaction you expressed on visiting our kitchen-garden and fruit forcery, and particularly with my culture of the pine-apple, induces me to submit to you the following account of the latter process.

About the middle or latter end of March, a pit, like that shown in the drawing (*figs.* 91. and 92.), is filled 2 ft. deep with horse-dung, and 2 ft. with mould. The mould having reached a certain temperature, I put such plants in it from the pine stove as already show fruit and are in vigorous growth.

Holes being made in the mould, which consists of two parts of rich black soil, and one part of turfy loam, with a little sheep's dung, the plants are turned out of the pots without the ball being disturbed, placed in the holes, and the soil made firm about them. When a row is planted (twenty-four plants are contained under one sash, forming six rows in the width of the pit), I place on the top of the soil, round the roots, some cow-dung, several years old, and therefore thoroughly rotten, and not too wet. The coldness of our climate renders it neces-



is loosened (an operation which is rather difficult), and fresh cow or sheep dung put round the plants. During the summer months they are watered and treated as before. If I find in autumn that the plants, after having done bearing, do not look so promising as might be wished, I transfer them carefully, with the ball, to a new bed, made like the former, except that it is advisable to put some sand round the necks of the plants; and here I treat them as before. During the winter a heat is kept up of from  $8^{\circ}$  to  $10^{\circ}$  Reaum.,  $46^{\circ}$  to  $50^{\circ}$  Fahr. There is no fear of their suffering, even though the coverings cannot be opened for several days, for the plants do not begin to grow till the month of February. The fruit-bearing plants may remain for three years in the same place; and I have seen them, in several instances, producing from three to six fruit during every year of that period, of from 1 to 2 lb. weight each. I call this the wild mode of pine culture, because one sees on the same plant fruits large and small, ripe, half ripe, green, and in blossom.

The other pine plants which I keep through the winter in the stove are grown during the summer in pits, and those of the queen kind generally bear fruit in fourteen months. They are repeatedly transplanted, and always kept through the summer with bottom heat, shaded, watered, and sprinkled. In the month of March, those plants which show no fruit are transplanted, with balls, into larger pots. The bottom of the pot is always covered with cow-dung thoroughly rotten, and the neck of the root surrounded with sand and sheep's dung; the plants propped up with sticks, and plunged in the tan; the hot dung being, by this mode of culture, covered with tan instead of mould. If the bed is too hot, I have the pots but half plunged, often only one third, in order not to burn the mould; and they are not completely plunged till the temperature is what it should be. In October I have the potted plants which, from the month of May, have been kept plunged in beds, removed to the stove. In winter, when the days are fine, I repeatedly water the larger plants, but those which have or promise fruit more frequently, with the view of not checking their growth, as the constant heat of the stove dries them considerably. In the house where the larger plants stand, which bring fruit in spring, a heat of  $16^{\circ}$  Reaum.,  $68^{\circ}$  Fahr., is kept up, in pursuance of the above-described method. In the succession house, where the younger plants are kept, the heat is  $10^{\circ}$  Reaum.,  $54^{\circ}$  Fahr. The plant taken from the mother stem brings me fruit in the second year, frequently in the first; and it is necessary here to keep always a great many of such plants, in order to obviate a deficiency of fruit.



My present mode of treatment teaches me that bottom heat is not indispensable to the growth of the pine-apple, as I have kept some of them for three or four years in the same bed, where, towards the last, the heat of the dung and tan was not greater than that of the atmosphere or the natural soil, without preventing my plants being adorned with the most beautiful fruit. It has also shown me that ripe fruit may be obtained by growing without pots in pits, as first described, throughout the whole year, as I can prove by regular tables kept for the last five years, showing that I furnished ripe fruit from these pits every month in the year during that period.

By the above communication, I hope to have fulfilled your desire, and have the honour to be, Sir, &c.

JOSEPH LANG.

*Nymphenburg, Nov. 4. 1828.*

---

ART. XIX. *On the Destruction of the Mealy Bug and Scale on Pine Plants.* By Mr. JAMES DALL.

Sir,

As none of your correspondents has taken notice of the insects that are so destructive to pine-apple plants, I beg leave to send you a statement of the method adopted by me for their destruction; which effectually killed every mealy bug and scale that was on my pines.

When I came to this place in 1808, I found the pines covered with the mealy bug and white scale, and I had immediate recourse to a recipe of an old acquaintance of mine, Mr. W. Nicol, with this difference, that I used 4 lb. soap, where he recommends only 2 lb. In that case my mixture consisted of 4 lb. soft soap, 2 lb. flower of sulphur, 1 lb. leaf tobacco, and 2 oz. nux vomica boiled in 8 gallons of rain water. After shaking the plants out of the pots, and trimming their roots, I washed them well with this mixture. I also had the wood-work and glass, inside of the houses and pits, washed with the same mixture, and the walls and flues washed with a mixture of lime and sulphur.

The tan in the bark beds I had sifted, and fresh tan added to make good the dust taken away; the whole, old and new, being well mixed together, the plants were repotted and replunged, and attended to as usual.

From that time I was no more troubled with the mealy bug, but the scale was not entirely destroyed: for, towards the end

of the following summer, I found several of the plants had a few insects on them; and from that time I had recourse to many experiments, by which I was able to keep the insects from becoming very numerous, but could not completely destroy them.

The first week in January 1817, I made a strong hot-bed of leaves, on which I had placed a three-light melon frame. I then selected as many of my small plants as would fill this frame, consisting of those plants that were most infested with the scale. I turned them out of the pots, shook the mould from them, washed them with a glutinous lotion, made with 2 lb. of soft soap and 3 gallons of rain water. After washing them well with this mixture, I dusted them all over with flower of sulphur, particularly in the hearts and bottom angles of the leaves: I then repotted them, and placed them in the above-mentioned hot-bed. By the end of the following month, I had the satisfaction to see the plants growing freely, and not the least appearance of the scale on them. I then determined to dress the whole stock, but with this slight difference, that as I did not like the yellow appearance of the sulphur, I mixed equal parts of flower of sulphur and sulphur vivum, this mixture being nearer the colour of the leaves. I then proceeded with my next smallest plants, by shaking them from the mould, washing and dusting them with the mixed sulphurs in the same way as the first parcel was done in January. My larger plants had some of the mould taken from the tops of the pots; the plants were then well washed and dusted, as before stated, and the pots filled up with fresh mould.

During the operation of washing and sulphuring the plants of each separate pit or house, I had the bark beds sifted and fresh tan added to replace the dust, the sifted and new tan well mixed, and the plants in their pots replunged. From that time, which is now twelve years, I have not seen a single scale on my pines. I have since had pines sent to me from Brazil and other parts, which were literally covered with scale. I dressed them, as above stated, placed them amongst my clean plants, and have never afterwards seen one living insect on them. There is no time in the year that the operation may not be performed; though it may be said the month of March is the best, as the plants will from that time the soonest grow away from any unsightly appearance of sulphur. There is no danger to be apprehended to the plants from a lavish application of the mixture, nor any caution to be observed after the dressing, more than the usual management of the plants.

When I applied the above dressing to my pines, I did not even take the precaution to wash the wood-work or walls of

the pits, or to throw any tan away, except the dust that was sifted out. I have had testimonials sent me from those whom I recommended to adopt the above method, all stating that it had the desired effect. I am, Sir, &c.

*Wimpole Gardens, Arrington,  
Cambridgeshire.*

JAMES DALL.

PS. — The above communication, respecting the destruction of the above-mentioned pine insects, was written previously to my receiving the Eighteenth Number of the Gardener's Magazine, and with a view of being transmitted to you. The 18th Art. of that Number (Vol. V. p. 57.) gives a statement, by Mr. M'Murtrie, dated Jan. 1. 1829, of a cure adopted by him, eight or nine years ago, nearly the same as mine. When I observed the statement of Mr. M'Murtrie, as above, I hesitated, and thought that my statement, if then sent, would be considered by you undeserving of notice.

However, after maturely considering all the circumstances that have attended my professional labours in the growth of pine-apples, &c., I conceived, if I did not lay my statement before you, I should be shrinking from a duty I owed to myself and to the younger branches of my family. If Mr. M'Murtrie is correct in his dates, I can prove that I applied to my pines my effectual cure three years before he applied his cure to his pines. In proof of this my assertion, were it required, I could refer to a very worthy man, with whom I have been intimately acquainted for the last twenty-two years, Mr. Joseph Knight, Exotic Nursery, King's Road, Chelsea. Many others I could refer to, besides the very men who executed the work under my inspection; and last, although not the least in my estimation, to my noble and generous employers, the Earl and Countess of Hardwicke.

The caution which Mr. M'Murtrie says should be observed in the use of camphor, and his observation, that unless the plants are very much infested, camphor may be omitted altogether, will, I fear, lead young gardeners wrong, and deter older people from adopting his method. The contents of my communication have not been altered, amended, or curtailed since my writing it in the last month of 1828. My practice of pine culture (Vol. III. p. 183.) can only vary with the seasons, and that variation only a few days from the time stated by me for the several shiftings, &c. You, no doubt, are aware that my system of growing pines differs from many. I have no means of giving heat, except by tan at bottom and lining of leaves round the pits. With such means only, and at my own suggestion, I have been able to send to table, or to where they

may have been ordered, about two hundred and fifty well-grown and well-flavoured pines yearly, for the last fifteen years ; and were my system more generally adopted, where leaves are plenty, even if coals were cheap in the neighbourhood, it would do away with frequent quarrels between the bailiff, or farming steward, and the gardener. If any further communication relative to what I have said be required, I will attend to it; or should any thing occur to me, I will, with your leave, send it, but I will not enter into any paper war, such as Mr. M<sup>c</sup>Murtrie's with my friend Agronome, in p. 98.

I am, Sir, &c.

Wimpole Gardens, Jan. 4. 1829.

JAMES DALL.

WE request our readers will turn to Vol. III. p. 183., and mark the great simplicity and cheapness of Mr. Dall's method of pine culture, and that this method is without any other heat than bottom heat: consequently, the most opposite possible to that of Mr. Knight. Not that we deny that pines may be grown without bottom heat, or even without being plunged or planted in a bed, and, with great care, perhaps well grown; but we have always denied, and still deny, that they can be so grown, either with the same ease and economy, as in a bed of fermenting material, or to such a large size. Our words, written in the year 1822, as given in the *Encyclopædia of Gardening*, § 2933-5. are as follows: —

“ To draw any conclusions in the present stage of Knight's experiments would be premature, and it might excite prejudice to anticipate the final result. That the pine plant will grow and thrive, without what is technically called bottom heat, is an obvious truth, since no plant in a state of nature is found growing in a soil warmer than that of the superincumbent atmosphere. But, to imitate nature, is not always the best mode of culture; for the more correct the imitation, the less valuable would be the greater part of her products, at least as far as horticulture is concerned. What would our celery, cabbage, and apples be, if their culture were copied from nature? Though the pine-apple will grow well without bottom heat, it may grow with bottom heat still better; and though the heat of the earth, in its native country, may never exceed that of the surrounding atmosphere, it does not follow that earth heated to a greater degree may not be of service to it in a state of artificial culture. But, admitting, for the sake of argument, that the pine plant could be grown equally well with, as without, bottom heat, still it appears to us that the mass of material which furnishes this heat, will always be a most desirable thing to have in a pine-stove, as being a perpetual fund of heat for supplying the atmosphere of the house in case of accident to the flues or steam-apparatus. Besides, it appears from nature, as well as from observing what takes place in culture, that the want of a steady temperature and degree of moisture at the roots of plants is more immediately and powerfully injurious to them than atmospheric changes. Earth, especially if rendered porous and spongelike by culture, receives and gives out air and heat slowly; and while the temperature of the air of a country, or a hot-house, may vary twenty or thirty degrees in the course of twenty-four hours, the soil at the depth of two inches

would hardly be found to have varied one degree. With respect to moisture, every cultivator knows, that, in a properly constituted and regularly pulverised soil, whatever quantity of rain may fall on the surface, the soil is never saturated with water, nor, in times of greatest drought, burnt up with heat. The porous texture of the soil and sub-soil being at once favourable to the escape of superfluous water, and adverse to its evaporation, by never becoming so much heated on the surface, or conducting the heat so far downwards, as a close compact soil. These properties of the soil, relatively to plants, can never be completely attained by growing plants in pots, and least of all by growing them in pots surrounded by air. In this state, whatever be the care of the gardener, a continual succession of changes of temperature will take place in the outside of the pot; and, the compact material of which it is composed being a much more rapid conductor of heat than porous earth, it will soon be communicated to the web of roots within. With respect to water, a plant in a pot surrounded by air is equally liable to injury. If the soil be properly constituted, and the pot properly drained, the water passes through the mass as soon as poured on it, and the soil at that moment may be said to be left in a state favourable for vegetation: but as the evaporation from the surface and sides of the pot and the transpiration of the plant go on, it becomes gradually less and less so, and, if not soon resupplied, would become dry, and shrivelled, and either die from that cause, or be materially injured by the sudden and copious application of water. Thus, the roots of a plant, in a pot surrounded by air, are liable to be alternately chilled and scorched by cold and heat, and deluged or dried up by superabundance or deficiency of water, and nothing but the perpetual care and attention of the gardener, to lessen the tendencies to these extremes, could at all preserve the plant from destruction. To lessen the attention of the gardener, therefore, to render the plant less dependent on his services, and, above all, to put a plant in a pot as far as possible on a footing with a plant in the unconfined soil, plunging the pot in a mass of earth, sand, dung, tan, or any such material, appears to us a most judicious part of culture, and one that never can be relinquished in fruit-bearing plants with impunity. Even if no heat were to be afforded by the mass in which the pots were plunged, still the preservation of a steady temperature which would always equal the average temperature of the air of the house, and the retention, by the same means, of the steady degree of moisture, would, in our opinion, be a sufficient argument for plunging pots of vigorous-growing, many-leaved, or fruit-bearing plants. Had Knight's plan been brought forward by a less eminent horticulturist, it would have claimed but little attention, as the plan of growing pines without bottom heat is generally considered to have been tried and to have failed."

Mr. Knight, of the Exotic Nursery, King's Road, has seen the pines in the garden of Mr. Knight, as well as those of Mr. Dall; and though we have no authority to refer to him, yet he may be asked what he thinks of both systems, and what relation the plants at Downton and Wimpole bear to those of the first pine-growers about London; say, for example, those in the Royal Gardens at Kensington, or in Syon Gardens. — *Cond.*

ART. XX. *On introducing heated Air into Cucumber Frames and Pits.* By Mr. F. MOULD.

Sir,

OBSERVING in the Gardener's Magazine (Vol. IV. p. 368.) an account of Mr. Knight's method of introducing heated air into cucumber frames, I send you a description of the manner in which I force early cucumbers, with the greatest success, both on beds and in pits.

Being provided with two M<sup>c</sup>Phail pits, built above ground without cross flues, I simply place a pipe (*fig. 93.*) through

the hollow wall under the middle light in front, which runs through the top of the flue. The horizontal part, which is heated by the lining,

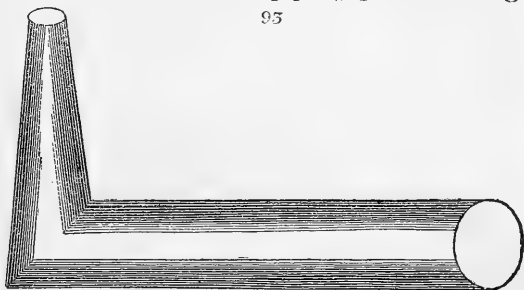

is 6 in. in diameter and extends 3 ft. from the front; the end rests on a stake driven into the ground for that purpose, and the upright or inner part, tapering to 2 in., is carefully fixed with mortar to prevent the ingress of rank steam which circulates in the flue. The ventilation speedily decreases the heat, and prevents the necessity of giving air by the lights in cold weather.

It is also necessary to add that the pits are prepared in the following manner: just within the front flue a wattle is placed, to form a cavity for the heat to ascend both from the leaves or dung contained in the pit and from the brickwork in front. I find a strong lining sufficient to keep the thermometer at 75° and 80°, without disturbing the back and ends after they are once made. My plants, the seeds of which were sown on the 20th of October, are now (Dec. 18.) remarkably strong and in full bloom, with quantities of fruit showing in succession. The plants on beds do equally well; the frames being well backed with leaves, there is no need of a powerful lining, except in front for heating the pipe.

Yours, &c.

*Avington, Dec. 18. 1828.*

F. MOULD.

ART. XXI. *Upon the Influence of Rocks on the Prosperity of Vine Plants, and upon the Quality of their Produce.* By M. METZGER, Curator of the Botanic Garden and Public Arboretum at Heidelberg, Author of *Europäische Cerealeen* and *Der Rheinische Weinbau*, and other Works (Vol. III. p. 343.) Communicated by J. RENNIE, Esq. M.A.

THIS author, in the work which he has just published *On the Cultivation of the Vine upon the Banks of the Rhine*, has examined the influence of the nature of rocks upon the qualities of the soil and vines cultivated in that country, celebrated for the goodness of its wines. The variety of rocks in that country facilitated this comparison, which would be difficult to be established in other parts, and which, at least, will serve as the basis for other researches; the results at which he has arrived, are the following: —

*Granite*, by the decomposition of mica and felspar, furnishes a very fertile and clayey ground. *Quartz* has a light and porous soil; it easily admits air, moisture, and heat; and large bodies retain heat; there the vine will afford good wine, if all things are equally favourable.

*Sienite* produces at least a similar effect.

*Felspar Porphyry*, like the granite, furnishes an excellent soil, on which the vine succeeds very well.

*Clay Slate*, by its decomposition, supplies a very fertile soil; if the quartz, which often runs in veins in this rock mix with the soil, it makes it lighter, and renders it more fit for retaining heat. The deep colour peculiar to this kind of soil increases also its temperature. This soil is most favourable for the vine.

*Basalt* forms, also, by its decomposing qualities, a very productive and suitable soil for the vine, and becomes one of the best, where marl and pebbles of basalt are found mixed together. Its deep colour increases heat, and is one of the principal causes of its fertility for the vine. The best sorts of vines grow on this soil.

*Dolérite* produces the same effect as the basalt; the most valuable wines are supplied from this soil.

*Variegated Sandstone*, in consequence of its decomposition, affords a light soil, more or less productive; where it is not mixed, it is barren, and the vine suffers on it in dry seasons. This is not the case where it is mixed with marl, clay, and other earths; but in general it produces no remarkable wine.

The clay soil, which is formed from the decomposition of *Shell Marl*, is difficult to cultivate. If the calcareous properties prevail, it becomes dry and poor, and requires much manure:

but when the *calcareous* parts are mixed with a clay soil, it may produce vines which are of a very fair sort. In general, however, mountains of this description are of a height too inconsiderable, and their summits too flat for such cultivation.

The *Coarse Limestone*, being very unsuitable (*très désagréable*), furnishes a deep and fertile soil, when it is well tilled; and good vines may be reared upon it.

*Gypsum* when it composes the sediment of the soil, should produce, according to the author, good vines; but he appears to have seen no instances of it.

*Kiffer*, which is easily decomposed, furnishes a light soil, on which vegetation is similar to that on the variegated sandstone. The wine which it produces is weak.

The *Schistous Marl* of the *Lias* is easily decomposed by the air, and yields a fertile soil, favourable to the vine. Its black colour is beneficial to the maturity of the grape; however, it is not distinguished by the production of any remarkable wine. This soil, when it is interspersed with round pebbles mixed with clay and sand, is very fit for the vine.

Vegetation commences only by the mixture of clay in the sand, arising from the decomposition of different rocks. Such land can only produce wild vines, and vegetation is often completely impeded during dry seasons.

The mud of gained land is generally little favourable to the vine. Wet seasons are especially injurious to it, and it only produces a bad wine.

---

ART. XXII. *A Plan for a Strawberry Wall.*

By ROBERT BYERS, Esq.

Sir,

As it has been proved, beyond a doubt, that the finest strawberries have been produced from one year old plants, and as their culture deserves our greatest attention, the fruit being, perhaps, one of the most wholesome in the world, the following plan for their culture may be valuable to your readers as possessing more advantages than the ordinary methods.

Suppose a bed 20 ft. long by 3 ft. 6 in. wide, place round this bed, stones or bricks about 6 in. high, and as nearly level as you can with convenience, fill the within space, and about an inch above it, with compost in which there is a fourth gravel or small stones. Around the whole bed place your plants 6 in.



apart (it will require about 94 plants for the first tier). Again, place another course of stones of the same size, beveling inwards on all sides at angle of  $45^\circ$  (*fig. 94.*); this fill with

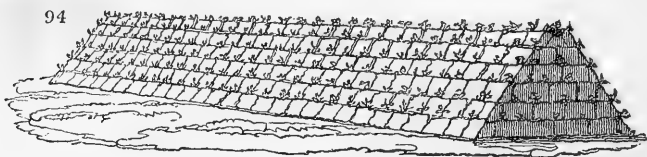

the same compost, and plant as for the first row of plants. Proceed thus, stratum super stratum, until you have raised your bed about 3 ft. high, which will give you six rows of plants around your bed and one row at the top. The advantages of this bed are as follows:— A much larger quantity of plants is grown on a given quantity of ground. You obtain a succession crop, by placing your bed north and south. You can water them with facility from the top, in which a trench should be left for that purpose. The fruit can be gathered with more ease and convenience, and the last and most important advantage which I shall name, is, that your fruit is free from sand and earth; should heavy rains occur during the period of its ripening.

I am, Sir, &c.

*Mount Pleasant, near Swansea,*  
*July, 1829.*

R. W. BYERS.

PS.—To renew the bed:—In August, remove all the stones but the lower row, and gently fork up the earth adding a little rotten dung, and replant and replace as directed above.  
R. B.

---

ART. XXIII. *On the Destruction of Wasps.* By Mr. JAMES DALL.

Sir,

HAVING read in your Magazine (p. 277.) a statement of a method practised by Thomas N. Parker, Esq., and also one by T. C. of Kensington (p. 332.), for the destruction of wasps, I beg leave to send you an account of the method practised by me for many years, which, I am convinced, is as simple and effectual as any that can be adopted.

I give a small reward to my men for every wasp they bring to me from the beginning of March, up to the second week of June; from June I give a reward as above for every nest

brought to me, and I continue taking the nests late in the season, although the fruit may have been all gathered; this I in order that fewer female wasps may be left to breed in the next spring.

The means used by me for destroying the nests are simply these:—I take common gunpowder and water sufficient to make a stiff dough or paste; a piece of this dough about the size of a large walnut rolled in the form of a cone, is sufficient to stifle the wasps in any one nest. The nests being looked for by the men in their over hours, when found they are marked, so as to be more readily found again when it is dark.

When all things are ready, the men divide their number in parties of three or four; each party being provided with a lantern, candles, spade, pick, as many glass bottles as there are nests to be taken on that night, and a water-pot with some clean water.

When arrived at one of the nests, fire is set to the smallest end of one of the conical balls of prepared gunpowder, which is held with the hand close into the mouth of the entrance till one third is burned; the remaining part of the ball is then dropped into the hole, and a piece of turf placed over it to prevent the escape of the smoke. In the space of half a minute after the ball is dropped into the hole, the nest is dug out, and in its stead a glass bottle one third part filled with water is placed upright with the mouth open, and rather below the surface level of the earth, which is carefully made smooth all round the mouth of the bottle. Into these bottles the wasps that happen to be out when the nests are taken enter, and get drowned in the water. In some large nests I have had to empty the bottles and replace them more than once. If bottles are not placed as above, the wasps that happen to be from home at the time the nest is taken (and crushed or worked up in a puddle as directed by your correspondents), on their return home finding the nest destroyed, they fly back to the fruit and continue devouring as long as they have life. I do not pay for any nests unless bottles are placed as here stated, and left two days after the nests are taken, and the nests brought home to me, that I may see them crushed.

I have counted two thousand three hundred wasps, belonging to one nest, drowned in bottles placed as above after the nest was taken; I therefore am quite certain that taking wasps' nests, without placing bottles as here recommended, is doing only half what ought to be done.

I am, Sir, &c.

JAMES DALL.

*Wimpole Gardens, Arrington, Cambridgeshire,*

*June, 1829.*

ART. XXIV. *On destroying Slugs by Lime Water, in preference to chopped Straw.* By Mr. W. P. VAUGHAN.

Sir,

IN your Magazine (Vol. V. p. 143.) I find cut straw recommended as an effectual mode of destroying slugs; which plan has been since copied in several newspapers. The idea of having our flower-beds and gardens strewed over with cut straw, as nothing can look more unsightly, has induced me to lay down the following efficacious method. Immediately after sunset, particularly on damp evenings, slugs are in motion towards their feeding place, and by nine o'clock they are all on the plants, or on the face of the ground near them. In the afternoon previous to my applying my remedy (lime), I have a tub containing 40 gallons of clean water, and half an hour before commencing I put 1 peck of fresh-slaked lime into it, and as soon as it is clear it is fit for use. I then take a watering-pot, with a rose on it, and sprinkle the beds of seedlings and borders of flowers all over, where I have seen any trace of them. If there is light enough for distinguishing the borders and rows of plants, it is all I want. A watering-pot containing 4 gallons will water a bed of 4 ft. by 30 ft., or rows of cauliflowers, cabbages, &c., of double the length. All worms that are out share the same fate, without leaving a vestige behind, except the dead bodies of the sufferers, which, I will answer for it, will be more the first time, than a man could behead with a straw knife in a month. The remedy is perfectly harmless to vegetation; in fact, I fancy my beds of pinks to produce a finer green and more healthy appearance.

I am, Sir, &c. W. P. VAUGHAN.

*Archdeaconry, Brecon, April 22. 1829.*

ART. XXV. *On the Culture of the Cow Cabbage, or Cesarean Cole.* By Mr. BERNARD SAUNDERS, Nurseryman, Island of Jersey.

Sir,

OBSERVING an article at p. 64. on cow cabbage, or Cesarean cole, communicated by Mr. J. Murray, permit me, through the medium of your miscellany, to offer a few remarks on the subject. Having resided in this island about twenty years, I have had an opportunity of appreciating the great advantage this variety of *Brássica* is to the small farmer as well as to the large one, and will, with your permission, give your readers a brief account of its culture and uses. The seed is sown, from

about the 20th of August to the 1st of September, in a good soil, and planted out, from November to January and February, in succession, at from 20 to 30 in. distance, in a good, substantial, well-manured soil; as no plant is more exhausting or requires a better soil, but, perhaps, no one plant produces so large a quantity of nutriment during its period of vegetation. About the month of April they begin (from the first crop) to strip the under leaves, cut them in small pieces, mix them with sour milk, bran, and other farinaceous substances, and give them as food to ducks, geese, hogs, &c. During the whole summer they continue stripping the plant as above stated, until it attains the height of from 6 to 12 ft.; and, if a scarcity of herbage prevails, the green leaves form excellent feed for cows and oxen, with alternate feeds of hay and straw. The tops and side shoots are excellent at table during winter and spring.

The longest of the stalks are frequently used to support scarlet runners and other French beans, and as cross rafters for farm buildings under thatch, and have been known to last more than half a century, when kept dry, for the latter purpose.

I am, Sir, &c.

Nursery, Island of Jersey,  
April 14. 1829.

BERNARD SAUNDERS.

SEEDS may be had from Mr. Saunders, or from Mr. Charlwood, seedsman, Great Russel Street, Covent Garden.—*Cond.*

---

ART. XXVI. *On the Day Lily (Hemerocallis fulva), as a Forage Plant.* By Mr. J. ELLES.

Sir,

As I shall not have an opportunity of witnessing the result of an experiment, which I have now in progress here, to cultivate the copper-coloured day lily (*Hemerocallis fulva*) for the use of cattle; a notice of it in your Magazine might induce others to make further trials, and perhaps prove it ultimately to be a plant of no ordinary utility.

In the years 1826-7, I observed, accidentally, how extremely fond cattle were of this plant, even eating it down to the roots when an opportunity occurred; and as I knew, from long experience, that it would, even in dry ground, produce herbage in the middle and latter end of April, equal in quality to any water meadow, the extreme facility with which it may be propagated and grown in almost any soil and situation, and also its apparently nutritious nature, I was induced to give it a trial in a plot of ground of about 20 rods, attached to the cottage in which I live. Accord-

ingly, in January 1828, I planted the whole piece in rows 2 ft. apart; between these a full crop of mangold wurzel was planted towards the end of April, which, of course, completely shaded the day lily for upwards of two months before it was gathered in and housed. This circumstance does not, however, seem to have had the least effect on it; for early in April, this year, the plants were 1 ft. high, and at the end of the month, upwards of 2 ft. I did not cut them down, intending to pick out the flower stalks only, to encourage the growth at the bottom of the plants; for, you must understand, the whole were single plants when first planted, now each has sent up two or three plants.

This season, I have again planted mangold wurzel between the rows, and have in addition planted some of Cobbett's corn; for as both mangold wurzel and the day lily grow as well, or perhaps better, by being a little shaded, I thought a row of corn, in the alternate rows of day lilies, would be an improvement; and should these three, or any two of them, succeed together, and I see no reason why they should not, it would be difficult to form an idea of the immense produce highly manured and well tilled ground might yield. The day lily, being a permanent crop, will annually produce a supply of green food in April and towards the middle of May, when there is little or no pasture grass; and, if cut at this season, it will continue to grow during the summer. Still, I apprehend, its chief value will be in the first crop; for, by immediately digging between the rows, a crop of mangold wurzel, Cobbett's Indian corn, or both, may be planted, this being the proper season for planting both, both requiring the same culture, and both being ready to be gathered in at nearly the same time, which may be done without materially injuring the plant for the spring. Either of these late crops will, of course, be of much more value than any crop obtained by allowing the day lily to occupy the ground alone.

It should be observed, that I never could detect any unpleasant flavour in the milk or butter, from the use of the day lily, and I have occasionally given it in considerable quantities: but, on the contrary, I have invariably found both the milk and butter as sweet as if the cow had been grazed on pasture land or mangold wurzel; a quality, which, if the plant should prove useful, will greatly enhance its value.

I am, Sir, &c.

Longleat, May 19.

J. ELLES.

THE *Symphytum asperrimum* has also been strongly recommended as a forage plant, by Mr. D. Grant of Lewisham, of which a notice will be found in our next Number. — *Cond.*

## PART II.

## REVIEWS.

ART. I. *Memoirs of the Caledonian Horticultural Society.*  
Vol. IV. Part II. 8vo, 10 plates. 10s. 6d.

THIS half volume contains no fewer than 54 different communications, "written either by distinguished amateur horticulturists, or by practical gardeners of great experience." Materials for another half volume are ready to be sent to press, provided the sale of that now published "will indemnify the expense of paper, printing, and engraving." "All members are, therefore, earnestly requested to promote this object, by procuring their own copies without delay." In order not to interfere with the sale of the work, we shall defer giving the essence of it for two or three Numbers. Its essence, however, we shall not omit to give in due time, as we give that of every new gardening publication, for the sake of poor gardeners; but the rich in the profession, if there are any, and amateurs may very well afford to purchase the volume, which is so remarkably cheap, that it is difficult to conceive how it can pay. There is an excellent paper by that veteran horticulturist and eminent man, Mr. John Hay, planner of gardens, Edinburgh, which is absolutely worth the money. It is an account of a mode of producing a steady and uniform bottom heat in pineapple or melon pits, or in stoves for exotic plants, by means of steam introduced into a close chamber filled with water-worn stones. Pine-plants in pots are placed in a bed of sand or ashes over the chamber; or the chamber is filled with proper soil, and the plants planted in it as in the open ground, as practised by Mr. Lang at Nymphenburg. (p. 424.)

19. *On the raising of Mushrooms, and on the forcing of Rhubarb Stalks in the open Air.* By Mr. James Stuart, Gardener to Sir John Hope, Baronet, at Pinkie House, Musselburgh.

*Mushrooms.* — Against the back wall of a shed form the base of the bed 3 ft. wide of rubbish, to keep it dry; cover it with dung from a cattle shed, 5 in. thick next the wall, sloping to one inch in front; in a week or ten days, cover with 4 in.

of horse droppings; and, when settled, bore holes 4 in. in diameter, and 12 in. apart, through to the rubbish; when all danger from burning is over, fill these holes with fresh horse droppings a little dried; then spawn the bed, and cover the whole with earth 3 in. deep. Mulch with hay of a soft nature, or with straw, and water lightly as occasion requires, with water at 60°, or not exceeding 75°, which ought to be the maximum heat of the bed.

*Rhubarb.* — Cover in the open ground with boxes or pots, and around these lay leaves or hot dung, as in forcing sea-kale.

20. *On the ripening of Fruit by artificial Heat, after being taken from the Tree.* By James Howison, Esq., of Crossburn House.

Pears gathered some weeks before they were ripe, “owing to the danger of their being stolen from the trees,” were placed in the drawers of a book-case in a room where a fire was constantly kept, and the temperature from 58° to 68°. After 10 or 12 days the jargonelle, and after a month the moorfowl egg, were found ripe, and better flavoured than if matured in the open air. Melons gathered in the end of October and supposed useless were, after lying in the same room till the end of December, “found nearly as high-flavoured and juicy as those ripened in the frames. In 1816, when wall-fruit in the upper ward of Lanarkshire did not even arrive at its usual size, fire heat had the effect of rendering such fruit more eatable than any which Mr. Howison tasted,” ripened on the tree in one of the warmest situations of Scotland. “From the foregoing it would appear, that the organic elaborations of the constituent parts of fruit are all finished in the early stage of their growth, *or when arrived at their full size*, and that their ripening is a process of chemical changes similar to fermentation, which, with a sufficient and regular application of heat, goes on, in some degree, independent of the living principle.”

Hawthorndean apples, gathered in the end of October, 1816, were, on the 27th of May, 1817, as fresh and plump as when taken from the tree, which Mr. Howison conjectures to be owing to the great quantity of unconverted acid contained in the unripe fruit.

(To be continued in Vol. VI.)

ART. II. *Catalogue of Works on Gardening, Agriculture, Botany, Rural Architecture, &c., published since June last, with some Account of those considered the most interesting.*

BRITAIN.

*Curtis's Botanical Magazine, or Flower-Garden displayed; New Series.*  
 Edited by Dr. Hooker. In 8vo Numbers, monthly. 3s. 6d. col.; 3s. plain.

No. XXX. for June, contains

2911 to 2917. — *Annona reticulata*; *Annonaceæ*. A shrub, or small tree, with spreading tuberculated branches, and numerous oblong-lanceolate leaves, and small greenish yellow flowers, succeeded by a pulpy berry as large as a good-sized orange, of a reddish brown colour, and said to taste like a custard. Native of the West Indies, and grown in our stoves. In St. Domingo the fruit is esteemed more as a quick and certain remedy against diarrhœa and dysentery than for the table. — *Lötus pinnatus*; *Leguminosæ*. "Another of the many interesting novelties discovered by Mr. Douglas, and thus introduced to the gardens of the Horticultural Society, where it flowered in June, 1828, in the open border, and in common soil." Perennial, and the only species of the genus with the leaves pinnate. — *Justicia nodosa*; *Acanthaceæ*. A low shrub, glabrous throughout the stems and leaves, and worthy of a place in every stove, on account of the large size and rich pale crimson colour of the flowers. — *Calceolaria thyrsoïdæ*; *Scrophularinæ*. An erect shrub, raised in the Edinburgh botanic garden, from seeds received from Dr. Gillies of Mendoza; "but it flowered first in the collection of P. Neill, Esq., of Cannon Mills." The plant is much used in Chile for dyeing woollen cloths a crimson colour. The blossoms have a light fragrance, not unlike the flowers of the laburnum. — *Dischidia* (*dis*, twice, *schizō*, to split; dividing of the segments of the corolla) *bengalensis*; *Asclepiadææ*. A stove epiphyte, of straggling growth; succulent, glaucous, and of no beauty. — *Plumbago rhomboidæa*. A stove annual, with small purple flowers.

We are glad to see one step taken in the road of improvement in this Number, viz. the derivations of the botanic names given. The others will follow in due time, or perhaps (but we hope not) out of time.

*Edwards's Botanical Register.* Continued by John Lindley, F.R.S. L.S. &c.  
 Professor of Botany in the London University. In 8vo Numbers, monthly. 4s. coloured.

No. IV. for June, contains

1240 to 1246. — *Rhododendron arboreum* var. *roseum*; *Ericææ*. From "the summit of the highest mountain among those which confine the great valley of Nepal on the north, and at an elevation of not less than 10,000 ft., where it grows intermixed with the white variety, which is, however, the less common of the two. In this mountainous region they both attain, along with the scarlet sort, the size of large forest trees. The latter, however, although it is found growing among them, is more naturally the inhabitant of a zone 5000 ft. lower. It is also found all over the mountains of Nepal and Kumoon, and Sirmore; and this may, as Dr. Wallich remarks, account for its being less hardy than the red sort, because the collectors are more apt to gather their seed from the trees low down on the mountains, than from those at a greater elevation." — *Clintonia* (Governor De Witt Clinton, an amiable excellent man, and a distinguished patron of



American investigation) *élegans*; *Lobeliææ*. A procumbent hardy annual, which, "Mr. Douglas informs us, is very common in low, grassy, over-flowed grounds on the plains of the Colombia, near Wallawallah river, and near the head springs of the Multnomah, flowering from June till August. With us it forms one of the most beautiful annuals with which we are acquainted. Notwithstanding the want of spreading foliage to give its flowers effect, the latter are of so brilliant a colour, that the plants, when grown in broad patches, resemble a carpet of silver and blue." — *Lupinus áridus*. A tufted biennial or perennial, from 6 to 10 in. high. "Mr. Douglas informs us that this beautiful species is an inhabitant only of woodless scorched grounds, where, from its compact habit, it forms thick carpets of purplish blue, giving a relief to the eye from the micaceous sand in which it delights to grow. The spontaneous plant in Colombia is white, with long hairs, and is a true perennial; but the garden plant, which is much less hairy, can scarcely be considered more than biennial. From the profusion of the flowers, the plant soon becomes exhausted; and this, together with its impatience of moisture and the humidity of our climate, is apt to destroy it." — *Prúnus dasycárpa*. A middle-sized hardy tree, with smooth branches, almost like those of an apricot, and commonly known in the nurseries as the Black Apricot. The fruit is about as large as a common plum, dark purple, with a tawny austere flesh. — *Chasmònia (chasmaò, to gape wide; calyx) incisa, Labiàtæ*. A hardy annual, introduced from Sicily so long ago as 1596, but now become rare. Epsom Nursery. — *Pentstèmon triphýllum; Scrophularinæ*. A perennial, common on decomposed dry granite, or schist rocks, on the Blue Mountains of North-west America. — Introduced to the Horticultural Society, by Mr. Douglas, in 1827. — *Erythrina poiánthes; Leguminòsæ*. A stove shrub, from the botanic garden of Ajuda, in Portugal, flowering in January, February, and March, without producing its leaves. Native country unknown, but supposed to be from Asia.

*Botanical Cabinet.* By Messrs. Loddiges. In 4to and 8vo Parts, monthly. Large paper, 5s.; small paper, and partially coloured, 2s. 6d.

*Part CXLVI. for June, contains*

1451 to 1460. — *Leucopògon interrúptus*. A New Holland shrub; neat, smooth, and 3 ft. high; of the usual culture. — *Erica cárnea* and *dís-color*. — *Cròcus pusillus*. A native of Italy, introduced in 1824 by Professor Tenore; somewhat delicate, but very beautiful; flowers white. — *Caméllia japonica var. Ròsa sinénsis*. A bold-flowering variety, very distinct; raised from seeds by Mr. Chandler. — *Alonsòa intermèdia*. Supposed to be a mule, between *A. incisifolia* and *lineàris*. Beautiful deep crimson flowers, perpetually flowering; cuttings, and the easiest culture in light loam. — *Hòvea purpùrea*. An elegant shrub, from New South Wales; of easy culture. — *Scóttia dentàta*. A neat-looking New Holland shrub, with flowers of a singular yellowish brown colour, which appear at various seasons. — *Arabis álbida*. A very pleasing early-flowering perennial, from Tauria in 1798; hardy, and fit for pots and rockwork. — *Acàcia gravèolens*. The flowers of this species are fragrant, but the smell of the leaves powerful and unpleasant.

*The British Flower-Garden.* By Robert Sweet, F.L.S. &c. In 8vo Numbers, monthly. 3s.

*No. I. of Vol. II. for June, contains*

1 to 4. — *Cypripèdium ventricòsum*. A rare and handsome plant, from Siberia; first flowered in the conservatory of Sir G. T. Staunton, at Leigh Park, Hants, where it was treated as follows, by Mr. George Hall, gardener there: — "It is a herbaceous perennial, dwarf and erect in its growth, fibrous rooting, and has, in its dormant state, all the characteristics of the

Lily of the Valley; indeed, the resemblance is so great, that it is difficult to distinguish between them before the foliage has made its appearance.

“It was potted in peat and loam, and placed in a frame, and treated as other half-hardy plants. About Christmas it was taken into the greenhouse, and placed on a shelf near the glass: there the flower had first made its appearance; but as it grew rather delicate and slender there, it was removed to the conservatory, where it arrived to full perfection.

“It is apparently quite hardy, and might do well out of doors in a south border, care being taken as to soil, and protection in very severe weather.”

“We agree with Mr. Hall in believing it to be quite hardy, as it is a native of the eastern part of Siberia; but we would recommend its being planted in a north rather than a south border, as it would not be so liable to be hurt by cold; in growing too soon in spring. The plants of this genus are also fond of a shady situation, generally growing in woods under the shade of trees; and their roots running amongst the decayed leaves that have been accumulating for years, and form a bed of light soil. This should be imitated as much as possible in their cultivation.”

*Caméllia japonica* var. *Colvillii*. The petals are striped like those of the carnation, and it is “certainly the finest and most beautiful variety that we have ever yet seen. . . . As the greater part of the different double caméllias bear perfect stigmas, they will therefore produce perfect seeds, if care be taken to procure pollen from a different variety. In doing this, particular care and attention is necessary to procure the stamens from the most double flowers that bear them, and also to consider what two colours would produce the most distinct and beautiful colour, intermediate between the two. Several of the sorts that are generally very double occasionally bear a few perfect anthers: these are the best for fertilising the others with, as the seeds from them will produce much finer flowers than from those that have been set with the more single sorts; and as the varieties from seed are now become so numerous, if they are not very fine and distinct, they will certainly not be worth cultivating, except as stocks to work the finer sorts on.

“The *Caméllia* is not generally so much cultivated as it deserves, though it is very hardy, standing our severest winters, when planted out against a wall or in any sheltered situation, without protection; but being such an early-flowering plant, the buds are often much injured, and sometimes destroyed, if not covered a little in severe frosty weather. We believe a northern aspect would suit it better than a southern, as it would not be so liable to frequent and sudden thaws in the day and frost at night, which injure plants that are somewhat tender more than they are injured by not being thawed while the frost lasts. We proved this by several species of *Cistus* the last winter, those in a south border being all killed; when the same sorts in a north border, which we expected to have been all destroyed, were scarcely injured in the least, and are now thriving well, and coming full in flower.

“The *Caméllia* is also one of the most proper plants for growing in the window of a light room, as it is much more hardy than the *Geranium* tribe, and requires nothing in winter but to be watered when dry. We have seen plants treated this way flower finer, and continue in flower much longer, than those cultivated in the greenhouse. The best soil to grow them in is a mixture of loam, peat, and sand, the greatest proportion of the former, and the pots to be well drained, that the wet may pass off readily.”

*Satýrium coriifolium*; *Orchidéæ*. From the Cape to the nursery of Mr. Tate, in Sloane Street, who plants it in “large pots, in a stiff loamy soil, which, he observes, is very similar to the soil that was about the roots when they arrived from the Cape, and which they thrive in remarkably well: others, that he planted in lighter soil, did not succeed so well. *S. cucullatum* we also observed in flower at Mr. Tate’s at the same time; and Mr.

Tate has lately introduced numerous other orchideous plants from the same quarter: these will all thrive well, planted in a warm border in a southern aspect, and covered up with mats or straw, or any other light covering, in severe frosty weather, but always exposed to the air when the weather is mild; or if a brick pit, with lights, be allowed for them, they will answer exceedingly well; the lights to be kept on in very wet or frosty weather, and to be covered over in severe frost; and if some moss were placed between them, we have no doubt but numerous young plants would come up from seeds; the seeds of *Orchideæ* requiring something to feed on and shade them, as they are all more or less inclined to be parasitical, particularly the seedling plants. A mat can also be spread on the lights of a hot day, when the plants are in flower, to keep the sun from scorching them. We should like to see a collection of those beautiful orchideous plants, natives of the Cape, New Holland, Mexico, Chile, and Peru, cultivated in this manner; and we know no place where it could be done better than at the nursery of Messrs. Young, at Epsom, whose manager, Mr. Penny, is a successful cultivator of *Orchideæ*, and flowers the British species to double their natural size."

*Zephyranthes carinata*; *Amaryllideæ*. Keelèd-leaved Swamp Lily. A small oval bulb, with linear dark-green leaves and pink flowers; from Mexico, by Mr. Bullock, to Mr. Tate of Sloane Street. "The present beautiful species is quite hardy, as are most of the other species of this pretty genus. The plants from which our drawing was made were in full flower in the open border, in August last, in the garden of Mrs. Marryatt, at Wimbledon House, Surrey, in whose interesting and extensive collection we observed many other curious and rare plants; amongst them a very singular hybrid species of *Anagallis*, intermediate between *A. fruticosa* and *A. Monelli*; the flowers of a coppery brown colour. It may be named *A. Marryattæ*, in compliment to the lady in whose collection it was raised; and we agree with M. Decandolle, that such names are the best for hybrid plants."

*Geraniaceæ*. By Robert Sweet, F.L.S. &c. In 8vo Numbers, monthly. 5s.

*Nos. XII. and XIII. for June and July, contain*

41 to 48. — *Pelargonium glabrescens Peytoniæ*. A hybrid of unknown parents, named in compliment to Lady Peyton, "a lady much attached to this tribe of plants." — *P. suffusum*, flabellifolium, cordiforme, urbanum, *Hilliænum* (raised from seed by Messrs. Colley and Hill of Hammersmith), and *speculum*. The last "curious-flowering" variety is of hybrid origin and was raised from seed at the nursery of Mrs. More of the King's Road, Chelsea. "We are sorry," Mr. Sweet observes, "to see that Mrs. More has sustained a very severe loss by the fire, from the manufactory adjoining, which was lately consumed; many of her fine new seedlings, that had not yet flowered, were destroyed, besides numerous other plants in the open ground, which were scorched up and spoiled, as well as the whole of her frames and what they contained; we hope the public will be liberal enough to subscribe towards repairing her loss." We hope this kind hint of Mr. Sweet will not be lost, either on ladies who have not yet become wives, or on wives who know the value of a husband; every widow, we are certain, will feel for Mrs. More, and many, we hope, will show it by becoming her customers.

*Cisticeæ*. By Robert Sweet, F.L.S. &c. In 8vo Numbers, every alternate Month. 5s.

*No. XXIII. for March, contains*

89 to 92. — *Heliánthemum Andersòni*. Suffruticose, procumbent, soon forming a large, spreading, dense tuft; leaves narrow, hairy, and of a bluish green; flowers of a straw colour. Of hybrid origin, and both pretty and

curious. "We have named it in compliment to our respected friend, Mr. William Anderson, to whom we are obliged for the opportunity of making drawings of many rare species, which we have not seen in any other collection." — *Cistus cymosus*, a very handsome, small, bushy shrub, with broadly ovate leaves and middle-sized lively red flowers. From the Levant, and to be kept in a frame. — *Heliánthemum confusum*. Suffrutescent and procumbent, short narrow leaves, delicate white flowers, and of the easiest culture. — *H. lyssofolium* var. *crocatum*. Suffrutescent and much branched, short oblong leaves, and rather large saffron yellow flowers. A very handsome variety, and a delightful plant for ornamenting rockwork. From the border of *Cistineæ* in the Clapton nursery. "We have this winter tried a great many species of *Cistus* in various situations in the open ground, and have found them succeed best, and suffer the least from frost, in a border with a north-west aspect. Scarcely any of them were injured in the least, though several were of the tenderer sorts, and they had not the least covering or protection. We attribute this to their being in a more dormant state, and their wood, therefore, more hardened to withstand the frost; as those in a southern aspect, though partially covered, were hurt much worse, which we account for by their being more in a growing state.

No. XXIV. for May, contains

93 to 96. — *H. stramineum*. Suffrutescent, procumbent, and very much branched; leaves oblongly lanceolate, and the flowers of a bright straw colour. — *H. stramineum* var. *multiplex*. The foregoing plant double, from the nursery of Mr. Lee. — *H. diversifolium*. Suffruticose, rough, and rugged; branches ascending; leaves narrow; and the flowers of a dark flesh colour, very handsome and showy. — *H. microphyllum*. Suffruticose, elongated, weak, with numerous, small, canescent, downy leaves, and large bright yellow flowers. Handsome, requiring a little protection in winter.

*The Botanic Garden*. By B. Maund, F.L.S. &c. In small 4to Numbers, monthly. Large paper, 1s. 6d.; small paper, 1s.

Nos. LIV. and LV. for June and July, contain

*Astrántia máxima*, *Phlóx refléxa*, *Tagètes lúcida*, *Tiarélla cordifólia*, *Érica strícta*, *Isótoma axilláris*, *Lopèzia coronàta*.

*The Florist's Guide and Cultivator's Directory*, &c. By Robert Sweet, F.L.S. &c. In 8vo Numbers, monthly. 5s. coloured; 2s. plain.

Nos. XXIV. and XXV. for June and July, contain

93 to 100. — Davey's Bolivar Pink. — Lawrie's Hertfordshire Hero Auricula. — Bartlett's Thunderbolt Tulip. — Lyra Grandis Hyacinth. — Burnard's Formosa Polyanthus. Handsome, lately raised from seed by [our correspondent] J. P. Burnard, Esq., of Formosa Cottage, Holloway. — Hogg's Lady Ackland Picotee. — Pourpre Fonce Hyacinth. A magnificent and first-rate variety, imported from Holland last autumn, and flowered by Messrs. Flanagan, Chubb, and Nutting, seedsmen and florists, 9. Mansion House Street, London, where numerous other fine and scarce varieties were in bloom at the same time. — Lampson Tulip. — The present number completes the first volume, and contains a systematical and an alphabetical index. The work is almost unique, and may safely be recommended to all florists.

*The Pomological Magazine*. In 8vo Numbers, monthly. 5s. coloured; 3s. 6d. plain.

No. XX. for June, contains

77. *The Canadian Reinette Apple*. Better known in France than in England. "A hardy tree, a great bearer, especially on Paradise Stocks; an excellent desert fruit, and a good keeper. In many respects it resembles

the Ribston Pippin, which possibly sprang from its seeds." Ripens in December, and keeps well till March or April.

78. *The Easter Beurrée Pear.* "Of all the very late keeping pears this is decidedly the best." A most profuse bearer, grafted upon the quince; perfectly hardy, and will suit a wall of an east aspect.

79. *The Martin Nonpareil Apple.* Useful and excellent; a great bearer as a standard tree, and in perfection at a period of the year when good apples fetch a high price. Ripens in December, and will keep till April, or, with good management, to Midsummer.

80. *The Wormsley Pippin Apple.* — An excellent autumn fruit, bearing well, and having a firm high-flavoured flesh, resembling in quality that of the Newtown Pippin.

*Ellis, Daniel, Esq. V. P. of the Caledonian Horticultural Society; a Discourse on Subjects relating to Horticulture, with a few Remarks on the present State and Prospects of that Science. Read to the General Meeting of the Caledonian Horticultural Society. Edinburgh. Pamph. pp. 50.*

The late venerable Dr. Duncan, who may be called the father of the Caledonian Horticultural Society, was Vice-President till his death: and he is now succeeded by Mr. Ellis. After a well-merited eulogium on his predecessor, who "not only planted the seed from which our Institution sprang, but nursed it with the tenderest care," a general view is given of the present state and future prospects of the Society, including the various matters relating to horticulture which have engaged its attention, or are to be found in its published *Memoirs*. Among the subjects noticed, that of heating pine-pits by steam diffused through a bed of stones holds a conspicuous place. We request particular attention to the following extract: —

"The steam apparatus consists of a boiler and supply-cistern; from the former goes out a large pipe, which communicates with a tube that lies lengthwise on the floor of the pit. This tube is perforated with holes, at distances of about 2 ft., and diffuses the vapour among the stones through all parts of the pit.

"The pots, with the pines, are placed on a bed of cinders, 4 in. deep, which lies on the Arbroath pavement; they are then plunged as high as their edges in good tan bark, and are never moved, except for repotting.

"The temperature of the atmosphere of the pit varies at different periods, according to the stage of growth in the plants. In all cases, when artificial heat is necessary, fire is applied to the boiler about six in the evening, and steam is procured in less than an hour. In winter, when the temperature is kept at 50° or 55°, it is sufficient to apply the steam only about an hour and a half in the twenty-four. In May, when the flowering is over, and the temperature is kept up to 75° or 80°, the steam is applied, in very warm weather, only about once or twice a week; and in autumn, during the ripening period, when the temperature is kept nearly at 65° or 70°, the steam is applied only once in forty-eight hours. The quantity of fuel used has not been particularly attended to, having been generally the refuse left from other purposes; but, in the construction of the furnace, every practicable means of economising the heat was adopted.

"Specimens of the pine-apples and melons raised in this pit were exhibited to the Committee of the Society, and much admired.

"At the request of Mr. Neill, Mr. Hay has since communicated to the Society a more detailed description of this method of heating pits, accompanied with very accurate plans and sections, illustrative of the mode of construction in all its details.

"The advantages of any system of artificial heating would seem to consist, in the first place, in the facility and certainty with which the requisite heat is obtained; in the steadiness, uniformity, and permanency of the

temperature it affords, and in the ready means of increasing or diminishing that temperature, according to the varying progress of vegetation and the fluctuating conditions of the external air. In the second place, security against partial, irregular, and insufficient heating, freedom from offensive and noxious emanations, and easy means of preserving the atmosphere, as nearly as may be in its natural state of purity and moisture, are desirable. And if, in the third place, economy in the construction of the building, and of labour and fuel in conducting the heating process, can be combined with the other more essential conditions above mentioned, the system which unites these advantages in the greatest perfection will doubtless be entitled to a preference.

“No one, we think, who compares the method of heating by steam, as detailed in the foregoing pages, with that by smoke flues, as ordinarily practised, or with that derived from the putrefactive fermentation of vegetable matters, can hesitate to admit, that, in almost all the requisites above mentioned, it is greatly entitled to a preference; while it is subject to few or none of the inconveniences and disadvantages to which the latter methods are exposed. In regard to trouble in attendance, and diminution of expense in labour and fuel, the plan of Mr. Hay seems to have accomplished almost all that can be desired. It may still, however, receive improvement in some of its details; for, on comparing, as he says, the pits at Cunnoquhie with those at Castle Semple, it will be seen, from the statement of Mr. Smith, that, at the former place, a pit 30 ft. long requires as many hours of steam, *in every twenty-four hours*, to raise the temperature to the height required, as another 60 ft. long, and nearly a foot broader, does, at the latter place, *in every forty-eight hours*. ‘The reason of this difference is,’ says Mr. Hay, ‘that the pit at Cunnoquhie has only *two feet* depth of stones, while that at Castle Semple has *three feet*’—a fact which illustrates in a very striking manner the power of the stones to receive, retain, and slowly impart heat.”

It certainly would appear that this mode of heating a bed of stones is far preferable to the mode of heating by hot water, at least for pine culture; unless an immense cistern of water were substituted for the bed of stones; but such a cistern we consider objectionable on many accounts; and even if it were not objectionable, we question its power of retaining a sufficient degree of heat for an equal period with a bed of stones, which, though they give out heat faster, yet have more. We request the practical gardener to mark the important fact above quoted, that steam only requires to be applied to the pit about one hour and a half in twenty-four during winter, and only once or twice a week in spring and autumn. No system of heating by hot water, that we have heard of, has ever equalled this, in diminishing the labour of attendance and the risk of a failure of heat.

We participate in the satisfaction which Mr. Hay must enjoy, after a long life assiduously spent in horticultural pursuits, in being the author of such a useful invention. It appears that Mr. Hay applied steam to forcing-houses at Preston in Midlothian, in 1794; and he may now be considered as having perfected this mode of heating. The Caledonian Horticultural Society unanimously awarded him the London medal for 1828; which is something, though the consciousness of the impression which he has made on the horticulture of his time, and of being the most eminent horticultural architect that Scotland has ever produced, must be his greatest and best reward.

The mode of heating by hot water is next described, and notice taken of a house, 60 ft. long, in the Society's experimental garden, and of the houses at Woburn Abbey, so heated. After shortly reviewing the modes of heating by smoke flues, by steam, and by the circulation of hot water, and bearing testimony to the great merits of the latter mode, Mr. Ellis concludes:—“It seems doubtful, however, whether, in economy of fuel, espe-

cially in duration of temperature, it [hot water] can ever be brought to equal the steam chamber filled with stones, as practised by Mr. Hay."

The saving of heat effected by coverings of straw mats or boards, is pointed out and explained on scientific principles, as are the advantages of hollow walls. The importance of the study of vegetable physiology to practical gardeners is insisted on, and of the use of societies in stimulating both to local and general improvement. The magistrates of Edinburgh are said "not to have been slow to acknowledge the very great improvement in every description of produce exhibited in the vegetable market" since the institution of the Society. Of ornamental horticulture it is observed, that "nowhere, in proportion to the accommodation provided, can finer specimens of beautiful exotics be seen, than in the new conservatories of the Edinburgh botanic garden, under the care of Mr. Macnab. Lastly it is concluded that, "Whether we look to the examples of the great and wealthy at home; to the spirit of enquiry and emulation that pervades almost all other countries as well as our own, and circulates, as it were, every where freely amongst them; or whether we call to mind the great skill and enterprise possessed by our practical gardeners, prompting them continually not only to make new observations and try new experiments in the practice of their art, but to avail themselves of all the new lights which the sciences connected with it can bestow; we cannot, I think, but admit, that, great as may have been the recent progress of horticulture, it is yet destined to move on with accelerated speed, and contribute at once to the elegant gratification and solid comforts of the public, to an extent not easily to be judged of by what we already know.

"It will not be denied, that, in proportion to its means, this Society may claim its full share, both in regard to precept and example, in bringing about this favourable state of things; and, had it been patronised by the great and wealthy in this part of the island, in a degree corresponding to the support which our elder sister of the British metropolis has received, it would, we think, have exhibited proportionally higher claims to public encouragement. But, looking onward to the future rather than backward to the past, we would cherish the hope, now that its merits have been publicly recognised, that it is destined to take a sort of new life; and that, having passed through the trying periods of seed-time and early growth, it will, ere long, approach maturity, and yield as rich a harvest of fruits as its most sanguine friends can desire. In circumstances like these, it will not, we trust, be objected to this part of the empire, which has so long been distinguished in horticulture as to be considered as a sort of nursery for gardeners, that it is now backward in encouraging the art which it has hitherto so successfully cultivated; and that, too, at a moment when it is exciting such unusual interest in almost every civilised state, is advancing with rapid pace, both in practical skill and scientific developement, and is almost daily receiving the most novel and important acquisitions, and holding out prospects of increasing honour and reward to those who may professionally devote themselves to its culture."

*Loudon, J. C.*, Editor, with the assistance of Professor Lindley, Mr. Sowerby, and others: *The Encyclopædia of Plants*; comprising all those in Britain, either indigenous or cultivated, flowering or without Flowers; with Figures illustrating one Species or more of every Genus, all the Classes and Orders, and many of the Botanical Terms. London. 1 vol. 8vo, pp. 1159. 4*l.* 14*s.* 6*d.*

This work, the labour of nearly ten years, is intended to be in botany, what a Johnson's Dictionary and English Grammar are in the English language; and its editor can recommend it for the objects stated with the more confidence, since by far the greater part of the volume is the labour of Professor Lindley and Mr. Sowerby.

*Fowler Thos.*: A Description of the Patent Thermosiphon (*thermos*, hot, and *siphon*, a tube); with some modes of applying it to Horticultural and other useful and important Purposes. London. Pamph. 8vo, 4 pls. 3s. 6d.

Mr. Fowler has had the good fortune to hit on the idea that water may be heated and made to circulate through a siphon, as well as through horizontal pipes, or by force through pipes in any direction; provided always, that the height of the siphon be not greater than to be counter-balanced by the pressure of the atmosphere; say not greater than 30ft. Any person might have discovered the same thing by reflection, or in answer to the question asked; but we are not aware that the idea has occurred, either to the original inventor of the hot-water system, Bonne-main; to its first introducers into England, Bolton and Watt; to its subsequent introducer, Chabbannes; to Count Rumford; to its reinventors, or English inventors, Atkinson and Bacon; or to any of the numerous engineers now occupied in applying this mode of heating. Mr. Fowler's discovery is not likely to be of very important use in gardening, though it may occasionally be resorted to for the purpose of overcoming difficulties; but it will be of most advantageous application in private houses for heating baths, apartments, water for washing, &c. He has illustrated his principle and its application by four copper-plates containing thirty-six figures, and we are sorry he has not had these figures cut in wood and placed along with the text, because, placed as they are, and referred to by numerous letters, they are troublesome to the reader, though of themselves well calculated to show the varied and extensive application of the principle.

"The variety of forms in which this invention may be applied, for the purpose of communicating and transmitting heat, are innumerable; but the general principle of the apparatus is always the same; viz.—it elevates and circulates the hot fluid from an open boiler, or vessel containing the fluid, without the external application of any mechanical force or pressure whatsoever except the common pressure of the atmosphere. My invention also consists in employing the power of the descending fluid in the Thermosiphon, for the purpose of causing hot fluids to flow from boiler to boiler, through connecting tubes of various lengths and forms, for the purpose of heating the lower parts or ground-floors of hot-houses, conservatories, green-houses, and other buildings, and also for other purposes requiring heat on the ground or in low situations."

Any gardener may prove that hot water will circulate in a siphon, by taking a piece of lead pipe, say of half an inch bore, and 4 or 5 ft. long, bending it like a siphon, but with one leg a good deal more bent than the other, in order to give the descending water time and space for giving out its heat; and then filling this tube with warm water, and placing one hand on each end to retain it full, immerse the extremities in a pot

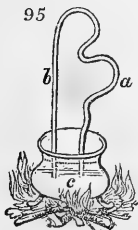

of water over a fire: (*fig. 95.*) Supposing the water of a uniform temperature in both legs of the siphon, no circulation would take place; but supposing it to cool sooner in the long leg (*a*) than in the short leg (*b*), then the equilibrium would be destroyed and the water in the long leg (*a*) would descend and draw up hot water through the short leg (*b*), and this circulation would continue as long as the water in the pot (*c*) was maintained at a temperature above that of the surrounding atmosphere. It is easy to conceive that in this way a gardener might conduct a tube of hot water, from his horizontal pipes in the floor of a stove, up

to a shelf suspended from the roof or against the back wall; or he might carry the circulation over a door instead of under it, as is now commonly done, both by flues, steam, and hot water. But it can seldom be necessary



to disfigure a house by carrying the heating tubes over the door, and never necessary to lead them to the roof or to the top of the back wall, because, as every body knows, heat ascends there sufficiently fast through the atmosphere. It is for heating baths, dwelling-houses, and perhaps the water in certain descriptions of manufactories, or the rooms of manufactories, that we consider this mode of heating best adapted, and we shall presently show its application in that way.

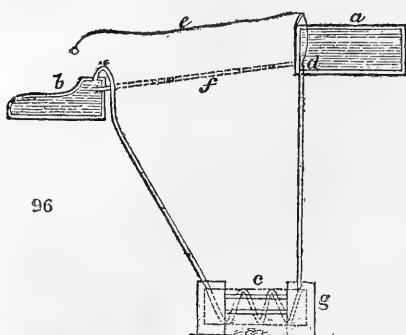

96

A very good mode of heating a bath in a private house consists in having a cistern of water (*fig. 96. a*) situated any where without or within the house, provided it be above the level of the bath (*b*); from the cistern let a lead pipe of half an inch in diameter, or less, descend to a cistern at the back (*c*), or to the small hot-water cistern in the side, of the kitchen-range (*g*); in this cistern, or in both, let it make several coils, and thence ascend to the bath (*b*). It is evident that the cold water of the cistern will be heated in passing through the coil of pipe in the hot water of the kitchen-range, and by a cock it may be let into the bath at pleasure without troubling servants, or indeed without their knowing any thing of what is going on. To prevent the water in the cistern (*a*) from being heated when the bath is not in use, a cock may be fixed any where between the range and the cistern; or a valve over the orifice of the pipe (*d*) may be opened by means of a string (*e*) connected with the bath room, with which room may also be connected a cold water pipe (*f*):

To heat a bath similarly situated by the Thermosiphon, insert the two open ends of the siphon in the side boiler of the kitchen-range (*fig. 97. a*), lead them up to the bath (*b*), and let the descending leg of the siphon (*c*) make a coil of turns under the false bottom of the bath (*d*). The only trouble in this case is setting the siphon to work, which is done by closing the cocks (*ee*), opening that under the funnel (*f*), and pouring in water there till the siphon is filled from (*ee*) upwards; then opening the cocks (*ee*) and pouring in as much more as fills it completely, when closing the cock (*f*), the circulation will commence. In the figure the two ends of the siphon will be observed turned up a little (*g*), the object of which is to prevent dirt or air bubbles from entering; air or steam in the siphon greatly impeding the circulation, and requiring in some cases to be removed by what Mr. Fowler calls air plugs. From this application of the Thermosiphon, any person of the slightest ingenuity will comprehend how it may be applied in a hundred other cases, and tradesmen interested will, no doubt, purchase the pamphlet, the plates of which show a variety of ingenious applications.

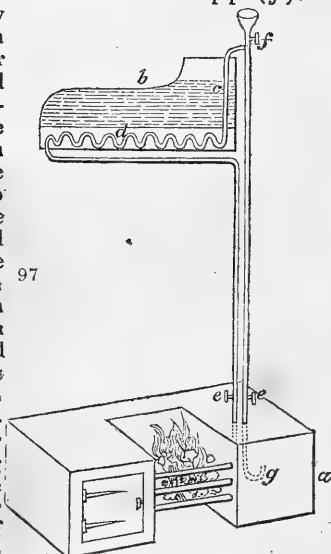

97

## FRANCE.

*Prevost, Fils*, Nurseryman at Rouen, Member of various Societies, Author of *Essai sur l'Éducation et la Culture des Arbres Fruitiers Pyramidaux: Catalogue Descriptif, Méthodique, et Raisonné, des Espèces, Variétés, et Sous-Variétés du Genre Rosier, cultivées chez Prevost Fils, Pépiniériste à Rouen.* Rouen. 8vo.

We have elsewhere (p. 372.) mentioned M. Prevost as one of the most scientific nurserymen in France. In this Descriptive Catalogue, which occupies 247 pages, and describes 880 sorts, the species are disposed after the method adopted by Mr. Lindley in his *Rosarum Monographia*, but without grouping them in tribes; because M. Prevost does not believe it possible to give sufficiently distinct characters to these tribes. An attentive examination of his descriptions, he says, will prove that the greater number of tribes present anomalies which tend to confound the one tribe with the other. The work will be of great value to any nurseryman who intends classing his roses, or to any one intending to form a complete collection; since they may order the whole 880 sorts, or a selection from them, according to the descriptions from M. Prevost. We sincerely wish that he may be rewarded in this way, as well as by the botanical fame which the work may procure him; for the labour he must have had in comparing and describing so many things, so much alike, so changeable, and so fugacious, must have been very considerable.

ART. III. *Literary Notices.*

*CAUSAL Botany*; or, an Elementary Treatise descriptive of the Changes of Plants; by D. Bishop. 1 vol. 8vo, 7s. to subscribers. This work will contain a succinct account of the various affections or distinctions that characterise plants at different times and in different places; of such as are produced by disease, luxuriance, and culture; and of such as proceed from their sexual oscillations and intercourse. As it will contain many interesting particulars respecting distinctions that are of secondary origin, especially of such as characterise plants known by the name of varieties, it is presumed that to botanists and cultivators it will not only prove an entertaining but in many respects a useful work.

*The Edinburgh Journal of Natural and Geographical Science* is announced to appear in September next. It is to be conducted by an Association of Naturalists, and to embrace all the departments of Natural History and of Geography, both physical and descriptive; and while it will be quite scientific, it will at the same time be written in a popular style. This will be the first Geographical Journal published in Great Britain.

*Supplement to Sowerby's English Botany.* — To the investigator of our native plants the *English Flora* of the late Sir J. E. Smith is an invaluable treasure; and happy are they who have an opportunity of referring from that work to the *English Botany*, for figures of the plants it describes. In consequence of subsequent discoveries, the *English Botany*, although it contains figures of 1450 flowering plants, comprises less than are described in the *English Flora*, and very many less than are given by Mr. Lindley, in his still more recent *Synopsis*. To supply this deficiency, it is the intention of Messrs. Sowerby to publish a supplement, the first number of which, price 3s. will appear on August 1. The high and well known talents of these gentlemen render any recommendation of the work unnecessary.

## PART III.

## MISCELLANEOUS INTELLIGENCE.

ART. I. *Foreign Notices.*

## FRANCE.

PARIS, June 6. 1829. — We have had a severe winter and a backward spring. The common laurel and the fig, where they were not covered, have suffered severely; but the *Magnolia grandiflora* has stood well. Admiral Tschitchigoff, as you know, has a great many at Sceau, not one of which is injured. The elm trees in the Champs Elysées are more than usually covered with seeds this season, which are now ripe, falling down, and might be swept up by sackfuls. *Robinia Pseudacacia* is now beautifully in flower, and in the evenings perfumes the air of the public walks where it abounds. There is a great appearance of most kinds of fruit all round Paris: apricot, cherry, plum, and pear trees are almost overloaded; and the vines in most places where I have travelled show so great a prospect of grapes, that the *vignerons* are crying out that they will be ruined if the crop turns out as it promises.

I do not recollect to have seen our method of cultivating early peas practised in England. The market-gardeners place their rows east and west, and raise a little ridge of earth on the north side of the row, which protects them from the north winds, and receives, at a more powerful angle, the sun's rays; by which more heat is reflected on the plants in the daytime, and at the same time more absorbed, to be radiated on them at night. When the plants show their second blossom, the top is pinched off, which throws the force of vegetation upon the forming pods, hastens the maturity of the crop, and increases the size of the peas. The operation is called *chatrer*. The crop is generally removed by the end of May, after which mangold wurzel is frequently sown; but sometimes rows of potatoes are planted between the rows of peas. Turnips round Paris are generally sown after winter barley, which is put in the ground early in autumn, and the crop cut green, for cows, in March, April, and May. Madame la Comtesse de Bruce is dead, and her place and extensive collection of plants are now to be sold. Yours, sincerely, — *Thomas Blaikie*. 5. Rue des Vignes, près la Barrière de Chaillot.

Paris, June 14. 1829. — I did not see any thing very remarkable in flowers at M. Boursault's. For rare and curious ones, I think we far excel the French in general: those they do know, I believe they bring to greater perfection. *Thunbergia alata* and *Erythrina crista galli* are not known here at all. M. Boursault had a *Wistaria* in flower outside of his green-house, on an eastern exposure (I think); it appeared rather sickly, the leaves were small and pale, and the flowers, though large, were not of a fine colour: the gardener gave me a bunch. He had beautiful *ixias*, and his geraniums were English. In the garden I remarked his rhododendrons one mass of bloom; and an elegant Austrian rose, or briar, in full bloom, overhanging some rock-work. I had been to M. Fion's before I received your letters; \*\*\*\*\* had told him she would bring me. He pointed out the *coup d'œil* which you

admired. His azaleas were mostly over: he had fine ones of a reddish orange and white. A beautiful andromeda, covered with white flowers. All his plants were healthy. He has two daphnes, which are new; one *D. Cneorum*, and the other *D. Dauphîni*. Wood's man is to take some over. I saw, for the first time, what he calls *Oranger poire*: the flowers are very dark on the outside, and the buds shaped like a pear, and black: the fruit hangs in bunches, not like an orange; I think it must be a citron. M. Fion is a clever man; he talked and joked the whole time, and said the most piquant things, which required more ready wit than either of us possessed to answer.

We often go to the flower-market. Yesterday they had a brilliant display of *Cactus grandiflora* and *speciosa*, English geraniums, and a *Viola* (heart's-ease), enormous, and of the richest purple, also English.

I was at Versailles last Sunday, to see the *grandes eaux*. I believe the pipes are out of repair, for all the jets did not play. I expected a grander effect. There was a great crowd of common-looking people, which took off from the *dignity* of the place. I was struck with the beautiful order the garden is kept in, though the court never goes there: there is not even a fallen leaf in the borders. I remark the same thing in the Tuilleries: the borders are full of handsome flowers, and they grow most luxuriantly; indeed, they take such precautions for the latter effect, that, instead of nice, clean, black mould on the borders, they have left a layer of rotten dung. From certain appearances, I rather think that they scrape the streets, or perhaps the *king's stables daily*, to contribute to their nourishment also. We have been walking this afternoon in the Duke of Orleans's park of Monceaux, Fauxbourg de Roule. You have seen it, I dare say. It is laid out in the English style, and certainly does full justice to our national taste. The groups of trees and walks are prettier than any thing I have seen for a long time. They were making hay, and I could almost fancy myself in England. I did not admire the Petit Trianon so much, the farm looked so dull, and going to ruin. — *M—a. Place Vendome.*

#### GERMANY.

*The Hot-water System of heating*, I have heard, has been established at Count Razumoffsky's, at Vienna, for upwards of eight years, and in a small propagating house at Dresden for a still longer period. — *Jacob Rinz. Ball's Pond, May 15. 1829.*

*The Cultivation of Fruit Trees, a Branch of General Education.* — Instruction in the culture of fruit trees forms part of the education of the ordinary seminaries of the state of Mecklenburg Schwerin. No school-master is admitted to exercise that function, without a certificate of his capacity to teach the management of fruit trees. The same masters are obliged to take care of fruit gardens; and those who, previously to the promulgation of the law on the subject, were ignorant of the art, receive the due instruction at the expense of the school fund. (*For. Rev.*)

#### SWITZERLAND.

*M. Schleicher's Herbarium*, he informs us, contains upwards of thirty thousand species, in excellent preservation, and arranged, according to the Linnean system, so admirably, that any genus can be referred to and examined, without disturbing any other genus. M. Schleicher, looking forward to the end of all things, is beginning to "set his house in order," and, thinking of selling his botanical treasures, invites all Europe to come and see them at Bex, Canton de Vaud.

## ITALY.

A Nursery has been established by a Frenchman of the name of Mau-poil, in the province of Dolo, about eight miles from Venice, and he now supplies all the neighbouring gentry with useful and ornamental plants, besides sending many to Greece and the Ionian Islands. He has also translated *Le Bon Jardinier* into Italian. He mentions, as a new discovery of his own, that the common black-thorn (*Prunus spinosa*) forms an excellent stock for dwarfing different varieties of the cultivated plum. — *A Constant Reader*. June 6. 1829.

## POLAND.

Warsaw, May, 1829. — The rise in the price of corn has put us all in good spirits here, and we hope soon to establish a wool market. Professor Schubert is every year adding something to his collection, as well from our native Flora as from what he receives from other countries. He makes a botanical tour in our provinces every year; and he has now got an assistant, by whose help he hopes soon to complete the examination of every parish in the kingdom. — *J. L.*

## NORTH AMERICA.

The Jamaica Society for the Encouragement of Agriculture and other Arts and Sciences held a Meeting at Kingston on April 14., when the following prizes were awarded: — To Miss Roger of Port Royal Mountains, for a specimen of starch obtained from the Arracacha, 2 dol. To Mr. Mapother, of Good Hope, for a yam weighing 58 lbs., 2 dol. To Charles Stephen, a slave belonging to Smithfield, for a yam weighing 55 lbs., 2 dol. To Mr. R. Smith, for flowers, including a newly introduced species of *Heliconia* and *Metrosideros*, 6 dol. To Mr. Macpherson, of Industry, Port Royal, for cauliflowers, 2 dol. To Briston, a slave belonging to T. L. Yates, Esq., St. Andrews, for asparagus, 2 dol. To Mr. H. Johnson, of Albey Green, for artichokes, 2 dol. To Mr. Charles Satchell, of St. Andrews, for potatoes, 2 dol. Some specimens of Jamaica mailles [?] were presented by Mr. J. H. Smith, statuary, for which thanks were voted. A dinner followed, at which Dr. Bancroft presided, and Mr. Atkinson was croupier. I remain, Sir, yours, &c. — *X. Y.* July 6. 1829.

## ART. II. Domestic Notices.

## ENGLAND.

A MODE of setting up Sheaves of Corn during harvest has been promulgated by Mr. Robert Vazee, who, it appears, has taken out a patent for his improvement. In a letter which he has sent us on the subject, however, he liberally observes, that any agriculturist desirous of ascertaining the effect of the corn preserver, “will be at liberty to apply the same during the approaching harvest, without application to the patentee.” The improvement, or corn preserver, is as follows: — “A stake from 6 to 7 ft. in length, being pointed at each end, is placed, by means of a bar, about 6 in. in the ground. There are then set round the stake eight sheaves of the usual size: a hood sheaf, of double the size of the upright sheaves, is bound tight near to the straw end of the sheaf; it is then inverted, suspended on the stake by which it is exclusively supported, and spread around the top of the lower sheaves, as per the elevation (*fig. 98. a*) and section (*b*) sent herewith. In this state the corn will remain without injury or further expense, until it is in a proper condition to be housed.” In Cornwall, Scot-

land, Sweden, and in various other wet or late countries of Europe, corn is set up in the above manner, and protected by a hood sheaf, but without the

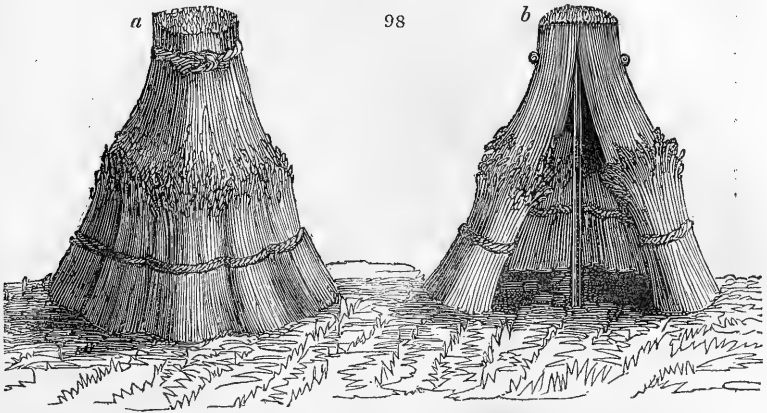

stick, which would occasion a considerable expense and trouble to farmers on a large scale: but cottage farmers and gardeners who raise seeds may find it worth while to adopt it; and it is for this reason that we have noticed the subject. The idea of a patent for a hedge-stake! — we cannot all enter into. — *Cond.*

*A Horticultural Impostor from Paris.* — Sir, On reading your account of the Sheffield impostor, I determined to inform you how I have been deceived by a Frenchman. In December last, a M. P\*\*\*\*\*, from Paris, announced his arrival in the *Times* paper, at No. 4. Green Street, Leicester Square. I called on him, and was shown a printed catalogue of his stock, and I purchased several articles. The following I have already proved, and have little faith but that I shall be equally deceived in the georginas, carnations, yellow nerium, and others: —

A double yellow camellia proves a single red; a double tricolor camellia the same; a yellow double China rose, and a tricolor, a lemon, and a brown ditto, all turn out to be *Rosa semperflorans* and common China roses; a yellow moss rose turns out to be the common moss rose, a double white the Cabbage Provins, and a tricolor the Rose de Meaux.

I hope you will caution your readers against being duped by such travelling gentry, and enable them to profit by my experience, and go in future to respectable nurserymen. — *A. B. Banbury, June 15. 1829.*

*Breaking Stones in Gravel Walks.* — The two last times we turned our gravel walks, we used a hammer of 2 lbs. weight, with a green ash rod handle to it. With this we broke all the large stones. Gravel thus prepared, as it is dug from the pit, binds well, and makes the best walks. — *William Anderson. Botanic Garden, Chelsea, February 4. 1829.*

*Ornamental Flower-pots, Vases, and Baskets,* as figured in our first volume, are now made of various sizes and prices, as indicated on a lithographic plate of patterns, by W. Dalley, Rudge, Chilmark, Wiltshire. — *Cond.*

*Hyde Park.* — We hear it is intended to conduct water pipes to different points of the highest and dryest places of the grassy surface, for the purpose of irrigation in dry weather. This will be an excellent improvement, provided it be limited to the quantity of water necessary to keep the grass green; but if it be carried so far as to produce a moist surface in the day-time, we should deprecate the idea, as tending to destroy all the comfort of walking, and to increase the production of malaria. Of course, we never

suppose irrigation gutters will be introduced, but that the water will be distributed by tubes of canvas, as at Admiral Tschitchigoff's at Sceau, or by leather tubes, or, better still, copper ones, pierced with very small holes, after the manner of the rain pipes at Messrs. Loddiges. By a little contrivance of main and subordinate tubes, all portable, and by a plug of supply in every 10,000 square yards, the whole might be regularly, speedily, and economically watered every evening after 10 o'clock. — *Cond.*

*The Tree Cabbage*, *Brássica olerácea L. var. acéphala Dec.*; *chou cavalier*, *chou à vâches*, *chou branchu*, *chou mille têtes Fr.*; *caulet Flem.* (*Bon Jardinier*, 1829, p. 251.). — The seeds of this cabbage, recently brought into notice by Dr. Hamilton (Vol. III. p. 351. and supra p. 440.), and which he enabled us to distribute last year, have grown with great luxuriance in a garden at Craven Hill, and in our own at Bayswater, and produced abundance of seed, which will be offered for distribution. Two hundred and fifty small packets will be left, in the first week of August, at 59. Pater-noster Row, and delivered to such individuals as may call for them, leaving their names and addresses; ten packets will be sent to the London Horticultural Society; ten to the Caledonian; and fifty to Mr. Mackay, Trinity College botanic garden, Dublin. — *Cond.*

*The finest Show of Geraniums* which we have seen in any private collection this season, was in a garden at Craven Hill, Bayswater. The circumstance is worthy of particular notice, on account of the plants having been kept all the winter in pits, without the aid of artificial heat of any description; but well covered up every night, aired in fine days, and never over-watered. The gardener, Mr. Samuel Daniells, is most assiduously attentive, and has been rewarded with the most gratifying success, not only with geraniums, but with the cow cabbage (supra): he is also orderly and systematic in his operations, and weeds below the economic point (p. 572.). — *Cond.*

*The King of France's Head Kitchen-Gardener* has lately been in this country, to acquire a knowledge, from ocular inspection, of the mode of heating hot-houses by hot water, and its application to the growth of the pine-apple. After inspecting a number of gardens about London, he expressed himself to us as most pleased with the pines in the Royal Forcing Gardens, Kensington, and with the boilers and mode of applying the pipes of Messrs. Cottam and Hallen. He recollects a hot-house at Malmaison being heated by hot water about twenty years ago, but paid little attention to the circumstance at the time, and believes it did not succeed. Never heard of M. Bonnemain, nor knew that tile hot-houses in the *Jardin des Plantes* were heated by hot water, till the fact was pointed out to him in the *Gardener's Magazine*. Found things in general here a little later than at Paris, but not much; not quite a fortnight, the difference of climate being more perceptible at midsummer. — *Cond.*

*Cast-iron Pins with Eyes* (*Encyc. of Gard.* § 1514. fig. 221.) have been adopted in the Earl of Stradbroke's garden, Henham Hall, for many years with perfect success. The nails cost 15s. per thousand; the shoots are tied to them with shreds of bass mat, and the walls are not disfigured with holes for harbouring insects. — *Geo. Fenn, jun. Beccles Nursery, Dec. 26. 1828.*

*Saffron in England.* — It is supposed by many persons that saffron is grown for sale in the county of Essex. It was formerly cultivated to a great extent near Saffron Walden, but has not been known there as an article of trade in the memory of the oldest inhabitant. A few years ago a man named Nott, living at Daxford, a village about six miles from Walden, cultivated about half an acre of it, which gradually dwindled down to a few rods, and about seven years since the bulbs were purchased by a medical gentleman at Saffron Walden, who planted them in his garden. This is the last remains of the saffron of Saffron Walden, and there is no prospect of its cultivation being renewed. — *J. H.*

## SCOTLAND.

*Edinburgh Green Market.* — June 26. New potatoes 3s. to 3s. 6d., and green peas 1s. 6d. to 2s. a peck; unripe gooseberries 3d. to 4d., and strawberries 1s. to 1s. 3d. the imperial quart; artichokes 1½d. to 3d., and cauliflowers 2d. to 4d. a head; common white turnips 3d. to 4d., and yellow turnips 4d. to 5d. a dozen; carrots 4d. a dozen; best cabbages 1d. each.

July 10. Peaches and nectarines are selling at from 4s. to 7s. per dozen; grapes, 2s. 6d. to 3s., and cherries, 1s. 6d. to 2s. a lb.; strawberries, 6d. to 8d.; Chile ditto, from 8d. to 10d.; currants, 10d. to 1s.; and gooseberries, 3d. to 4d. the imperial quart; melons, 2s., and pine-apples, 6s. to 7s. per lb.; new potatoes, 1s. to 1s. 6d.; and green peas, 1s. a peck. (*Scotsman.*)

*Caledonian Horticultural Society. Promenade at the Experimental Garden.* — On July 2. the Meeting of the Caledonian Horticultural Society for the adjudication of prizes for the best seedling carnations, pinks, and roses, raised from seeds saved in Scotland within the preceding three years, was held, for the first time, in their Experimental Garden at Inverleith. In addition to the subjects exhibited for competition, a splendid collection of exotic plants, chiefly from the hot-houses and green-houses of the Royal Botanic Garden, of Professor Dunbar and of Mr. Neill, was tastefully arranged on stages placed under a temporary awning. Visitors were admitted by tickets, which had been liberally distributed, and the garden was crowded with an assemblage of ladies and gentlemen. The countenances of all indicated a kindred sympathy with the verdant freshness and beauty of the surrounding scenery. The site of this garden, and the plan on which it is laid out (Vol. I. p. 90.), are well adapted to bring into view the rich combination of magnificent and picturesque objects, both natural and artificial, which environ it on every side. Though easily accessible in every part, and exhibiting in many a commanding extent of view, yet the varying heights of the ground, and the judicious distribution of belts of planting and shrubby borders over its whole area, lend to it an intricacy and seclusion which add much to its fitness as a place of public promenade. Nothing, accordingly, could be more striking or beautiful than to see the figures of so many elegantly dressed females (for the ladies greatly prevailed as to number), now starting into view and now receding from it, over all parts of the garden; to meet them at one time on the great central walk, marching, as it were, with measured step in a sort of close column, and soon again to behold them dispersed in different quarters, and promenading in all the ease and freedom of unconstrained movement. In exhibitions of this sort, it is most desirable that the company should move slowly but continually forward, so as to afford every one, in turn, an opportunity of seeing the objects to be viewed. (*Edinburgh Advertiser*, July 7.)

*The Ayrshire Horticultural Society* met for competition on June 23., in Ayr, when, after a careful inspection by the judges, the prizes were awarded as follows, viz. : —

*Plants.* Hardy Herbaceous (twenty-one distinct varieties): 1. Messrs. Smith and Son; 2. Mr. Faulds. Green-house (thirteen distinct varieties): Messrs. Smith and Son. — *Flowers.* The largest and best collection of Flowers (distinct varieties): 1. Messrs. Smith and Son; 2. Mr. Rose, gardener, Bellisle. Ranunculuses. Edged (five distinct varieties): 1. Mr. Faulds, gardener, Fairfield; 2. Mr. Hunter, florist, Prestwick; 3. Mr. Brown, gardener to D. Limond, Esq., of Dalblair. Striped (five distinct varieties): 1. Mr. Faulds; 2. Mr. Hunter; 3. Mr. Hill, gardener to Mrs. McTaggart, Ayr; 4. Mr. Brown. Mottled: 1. Mr. Hunter; 2. Mr. Faulds. Selfs: 1. Mr. Faulds; 2. Mr. Hunter; 3. Mr. Brown; 4. Mr. Hill. Anemones (seven distinct varieties): Mr. Hunter. Scotch Roses (thirteen distinct varieties): 1. Messrs. Smith and Son, nurserymen, Ayr and Monkwood



Grove; 2. Mr. Imrie, gardener, Ayr. Daisies in classes (seven plain double, seven quilled, and seven chickened, distinct varieties): Mr. Faulds. Amongst the principal ranunculuses brought forward were, Dr. Franklin, Duchess de Wurtemberg, Louissette, Pucella, Vulcan, of new varieties. Dalglish's Beauty of Scotland, Diana, William Pitt, Mrs. Dalglish, and Mrs. Hunter.—*Culinary Vegetables.* Early Horn Carrot: 1. Mr. Imrie; 2. Mr. Brown; 3. Mr. Faulds.

Amongst the splendid collections of herbaceous flowers exhibited, were fine specimens of *Pæonia* Whitlèjii, *Cypripedium spectabile*, *Gèum coc-cineum*, *Saxifraga pyramidalis*, *Lýchnis fulgens*, &c. (*Ayr Advertiser*, June 25.)

The *Ayr and Kilmarnock Horticultural and Florists' Societies* having agreed that, in order to promote a laudable spirit of emulation in the elegant amusement of floriculture, they should compete alternately, in Ayr and Kilmarnock, for a whole round of the principal florists' flowers, they met in Mr. Noble's, King's Arms Inn Assembly Rooms, Ayr, on Tuesday, April 28., to compete for auriculas and polyanthuses, viz., auriculas in three classes: 1st, the seven best green-edged; 2d, the seven best grey-edged; 3d, the seven best white-edged, distinct varieties: and in all the three classes of auriculas, the Ayr Society were declared by the judges, after a careful inspection, to be superior to the Kilmarnock Society; and, for the nine best polyanthuses, the Kilmarnock Society had the advantage. Among the principal flowers brought forward (many of which were certainly very fine) may be mentioned:—

*Auriculas.* Green-edged: Page's Champion, Cockup's Eclipse, Clough's Dolittle, Page's Duchess of Oldenburg, Barr's Flora, Harris's Blucher, Stretch's Alexander, &c. Grey-edged: Thomson's Revenge, Rider's Waterloo, Kenyon's Ringleader, Gorton's Countess of Shipbrooke, Butterworth's Lord Hood, Thomson's Bangup, Metcalf's Lancashire Hero, &c. White-edged: Wild's Bright Phæbus, Pott's Regulator, Taylor's Glory, Cox's Pillar of Beauty, Lee's Bright Venus, &c. — *Polyanthuses*: Pearson's Alexander, Manning's Lady Anne Hamilton, Manning's Sir George Monkton, Simms's England's Defiance, Cox's Prince Regent, &c.

There was exhibited, besides, on an extra-table, by the Ayr Society, a tasteful and elegant display of flowers, fruits, and vegetables; and, considering the backwardness of the season, the Show was allowed to be very fine.

On May 25., they met in Mr. Rodger's, Turf Inn Assembly Rooms, Kilmarnock, to hold their Second Competition, as agreed, for the twenty-seven best tulips, in three classes, viz. the nine best Cherry and Rose, the nine best Bybloemens, and the nine best Bizards, distinct varieties; when, after a careful inspection by the judges, the Ayr Society were decided to have the superiority of the Kilmarnock Society in all the three classes. The flowers were well blown, and in beautiful condition; and, with the addition of a fine variety of other flowers, vegetables, &c., from the Kilmarnock Society, the exhibition was considered truly grand. Among the principal flowers were:

*Cherry and Rose*: Comte de Vergennes, Rose Incomparable, Premier Noble, Triomphe de Hollande, Rose de Berlin, &c. *Bybloemens*: Grande Monarque, Louis the Sixteenth, Black Baguet, Roi de Britons, Reine des Amazons, &c. *Bizards*: Tamerlane, Sanzio, Abercrombie, Duc de Savoy, Prince Leopold Superbe, Trafalgar, &c. — *James Limond, Clerk.* *Ayr*, June 26. 1829.

The *Aberdeenshire Horticultural Society* held their Competition Show on May 28., when, considering the backwardness of the season, there was a brilliant and varied display of flowers of different kinds. The judges awarded the prizes as follows:—

*Flowers.* Tulips: 1. (large medal) David Gairns, gardener to James Mitchell Nicholson, Esq. of Glenbervie; 2. Mr. Alexander Fraser, nurseryman, Ferryhill. Ranunculuses: (small medal) Alex. Bell, Esq. Anemones:

1. (small medal) David Taylor, gardener to William Annand, Esq., Belmont; 2. William Smith, gardener to James Hadden, Esq., Grandholm Cottage. Polyanthus Narcissus: 1. (small medal) James Forbes, Esq., Broadford; 2. Captain Anderson, Skene Square; 3. Captain John Clyne. Stocks: 1. (small medal) David Gairns; 2. William Chalmers, gardener to Mr. Cheyne, Lochhead. Geraniums: (small medal) Mr. James Walker, nurseryman. Wallflowers: 1. (small medal) and 2. Mr. James Walker. — *Culinary Vegetables*. Seedling Strawberries: (small medal) Mr. Thomas Milne, nurseryman, Sunnyside.

The following gentlemen were duly admitted as members of the Society: William Watson, Esq., Sheriff-Substitute, Aberdeenshire; William Allardyce, Esq., Merchant; James Allan, Esq., Union Place. Several beautiful flowers, in pots, were sent by members to ornament the tables; and there was a numerous and respectable assemblage of visitors during the time the hall was open. (*Aberdeen Journal*, June 3.)

At a subsequent Meeting of the above Society, held June 25., the judges awarded the prizes as follows:—

*Flowers*. Ranunculus: 1. (a medal) Captain John Clyne, Aberdeen; 2. (a premium) Mr. J. I. Massie, Aberdeen; 3. (a premium) Captain John Clyne, Aberdeen. Pinks: 1. (a medal) Thomas Milne, nurseryman, Sunnyside; 2. (a premium) Wm. Barron, gardener, Blackhall. Irises: 1. (a medal) and 2. (a premium) Alex. Bell, Esq., Marywell Place. — *Fruits*. Melon: 1. (a medal) George Cardno, gardener, Woodhill; 2. (a premium) John Davidson, gardener, Dunottar. Grapes: 1. (a medal) and 2. (a premium) Wm. Anderson, gardener, Cornhill. Cherries: 1. (a premium) Wm. Barron, gardener, Blackhall; 2. (a premium) Peter Archibald, gardener, Park. Strawberries: 1. (a medal) Mrs. Gavin Hadden, Union Grove. — *Culinary Vegetables*. Early Peas: 1. (large silver medal) Duncan Cadendhead, gardener, Strawberrybank; 2. (a premium) Alexander Diack, nurseryman, Mile-End. Cauliflower: 1. (a medal) David Gairns, gardener, Glenberrie House; 2. (a premium) Robert Fraser, gardener, Woodside. Kidney Potatoes: 1. (a medal) William Lawson, gardener, Devanha; 2. (a premium) Thomas Milne, nurseryman, Sunnyside. Cucumbers: 1. (a medal) Colonel Gordon of Parkhill; 2. (a premium) John Davidson, gardener, Dunottar. Lettuces: (a medal) David Taylor, gardener, Belmont.

An extra-medal was also awarded to Peter Laing, gardener, Raeden, for a basket of beautiful preserved apples.

There were also various other baskets of preserved apples, in fine preservation. The peas were considered very fine; the ranunculuses were beautiful. Upon the whole, the Show was better than could have been expected, considering the backwardness of the season during the spring months.

Alex. Fraser, Esq., advocate, Capt. A. Farquhar, R. N., and John Lumsden Shireffs, Esq., advocate, were admitted members of the Society. (*Aberdeen Journal*, June 24.)

The Montrose Horticultural Society's Second Show for the season took place on June 25., Sir George Ogilvie, Bart., in the chair; when, notwithstanding the late season, there was a very fine display. As might have been expected, the bouquets were splendid and various, and the decorations were much superior to any thing we have seen any where else. Besides the articles presented for competition, we observed many beautiful flowers from different collections. The *Cactus speciosissima* attracted general attention from its splendid appearance; also, the *Pæonia Moutan*, in all its beauty, from the flower-garden of Fasque. The display of geraniums was superior to any thing of the kind we have ever seen; and we do not hesitate to say, that both they and the tulips might have challenged any Society out of Edinburgh. The prizes were awarded as follows:—

*Flowers.* Tulips. Bybloemens : 1. Mr. Sharp, Montrose ; 2. Alexander Smith, Rosemount. Roses : 1. Alexander Smith ; 2. Mr. Sharp. Bizards : 1. Alexander Smith ; 2. Mrs. Sim, Montrose. Double Anemones : 1. Mr. Sharp ; 2. Alexander Smith. Double Stocks : James Tough, Old Montrose. Pelargoniums. Dark Ground : 1. and 2. James Tough. Light Ground : 1. Mr. Sharp ; 2. James Tough. Best variety : 1. James Tough ; 2. Mr. Sharp. Best Bouquet of Flowers, from green-house : James Tough. From open border : 1. Alexander Smith ; 2. James Tough. — *Fruit.* Gooseberries : Mr. Robert Clark, Montrose. — *Culinary Vegetables.* Peas : John Begbie, Rossie. Potatoes : 1. John Hardie, Brotherton ; 2. Alexander Smith. Turnips : James Tough.

*Extra-Prizes.* Kept Apples : 1. James Tough ; 2. Alexander Smith. Seedling Geranium : John Begbie. Peas, from the open border : James Tough. (*Montrose Review*, June 5.)

*Dunfermline Florists' Society's Show of Tulips, June 2.* — The flowers consisted of Bybloemens, Incomparable Verports, and Bizards, and prizes were awarded as follows : —

1. Mr. David Hutcheson ; 2. William Meldrum ; 3. John Angus ; 4. John Duncan ; 5. D. Inglis ; 6. James Elder.

This was allowed to be the most splendid show of tulips ever exhibited in Dunfermline. (*Scotsman*, June 10.)

*Pine-Apples* have been grown to perfection, in common *Dung Hot-beds*, for the last seven years, by Mr. Hosie, gardener to Lord Lynedoch, at Lynedoch. I lately saw eighteen of the fruit, about 2lbs. weight each. — *Charles Sidey. Perth, Jan. 31. 1829.*

### ART. III. *The Marquess of Hertford's Villa in the Regent's Park.*

WE lately had an opportunity of inspecting the exterior of the building, and walking round the grounds. The situation of the house is elevated, and the extended front commands views of the water and a great part of the Regent's Park, in such a way as completely to appropriate them. The architecture is simple and elegant, with the exception of the conservatory, in the roof of which are two sloping semicircular windows, which instantly struck us as having been taken from two shop fronts. We are astonished that a man of the Marquess of Hertford's taste and wealth can bear the sight of them for a moment. Doubtless, we were more affected than we otherwise should have been, from knowing of two green-houses, at or near Bayswater, actually made up of old windows and shop fronts ; and of one of them, not a great way from a certain grand square called Orme's Square, containing a semicircular window-head not unlike the Marquess of Hertford's. The entrance front of the house is good, and also the main stack of chimneys ; but, at one end, there is a copper chimney tube or top, which disfigures the whole building. How that deformity can be permitted to remain, we are at a loss to conceive.

The grounds, 10 or 12 acres, possess a much greater variety of surface than we could have expected, in consequence of an ancient brook, the course of which is now turned another way, having passed through them, and worn out a fine circuitous dell, in the bottom of which a walk has been very properly introduced. We are sorry that this is the only walk that we can praise. There is a serpentine one, such as would not have occasioned any surprise had it been met with in a cockney garden of the last century ; we have seen such another in a modern garden (Vol. III. p. 362.), but not quite so bad. We hope our noticing this walk will not injure any one,

more especially as the gardener informed us that it was not made with his consent.

But, what is still worse than this naked serpentine walk, the trees and shrubs around this villa are every where of the very commonest and cheapest sorts. From ocular inspection from the roads, we think we should be justified in asserting that there is not a garden, small or large, within a mile, which contains so few good things, in proportion to things common and cheap. Probably the Marquess may not have much knowledge or taste in this way; but one would think that he would have applied the same principles to completing a villa which he does so successfully to furnishing a house, and have felt it to be a matter of propriety and good sense to have a garden laid out and planted suitably to his mansion and rank. On the whole, we were delighted with the situation, and pleased with the house, some points in the conservatory, the walk in the dell (not speaking of the plants on each side of it), and the exterior holly hedge, and quite satisfied with the high order and keeping maintained by Mr. Mackay, the very intelligent gardener; but quite disappointed in regard to all the rest. There is, in our eyes, a general appearance of meanness and poverty pervading every thing exterior to the house, which forms a sad contrast to it and to the noble distant scenery. — *Cond.*

---

#### ART. IV. *Retrospective Criticism.*

*MR. KNIGHT'S Pine-apples.*—Sir, I observe in the last two Numbers of the Gardener's Magazine (p. 1 to 240.), that you widely disagree with T. A. Knight, Esq., in the cultivation of the pine-apple, without the aid of bark-bed heat, as practised by him. For this reason, I can no longer remain silent and see his horticultural information undervalued, without making some observations on the subject. In the first place, it is well known that Mr. Knight had no pecuniary motives for writing the papers published in the *Transactions of the Horticultural Society* of London, and I am confident that it is far from his disposition to try to deceive or misguide any person; therefore, if any gardener has miscarried in the trial, I consider it must be for want of proper curvilinear houses and fuel similar to his. I must allow it is quite an impossibility for any man to grow large good-flavoured fruit on stages without bottom heat, in many of the old barns of houses that are standing about the country; but in good houses, with attention, it may be done. In the year 1819, I resided within a few miles of Downton Castle, and I remained in that neighbourhood five years, during that time (each year) I frequently saw Mr. Knight's pines, and in the year 1825, I saw them again, which you must allow is six successive years; and I do declare that I never saw finer nor more healthful pines of the *sorts* he was growing in my life; not even round the neighbourhood of London, nor in any county in England. So that what Mr. Knight has stated in the *Transactions of the Horticultural Society* is nothing but the truth; but, by your own account, the Society has rejected the Numbers of the Gardener's Magazine, so that it is easy to conceive where the grievance is. In my conclusion, I must give you to understand that I have no interest whatever with Mr. Knight, in fact he may be no more, for all that I can tell, but I like to see justice done to every man. Sir, I remain, yours, &c.—*A Practical Gardener. Exeter, May 18. 1829.*

The idea of the "grievance," &c., is good in its way, and we return our anonymous friend our best thanks for the amusement it has afforded us. However, as we have said before, our present opinion as to Mr. Knight's mode of growing the pine was expressed in 1822, and therefore the

“grievance” can have nothing to do with it. We are glad now to learn, for the first time, that Mr. Knight’s pines look well; which, however, though a proof that they may be grown well by his mode, is no proof of the superiority of that mode to the practice in general use. If there is one gardener in a hundred who is of a different opinion, we are very much mistaken. Why do they not try Mr. Knight’s mode at the Horticultural Society’s garden at Chiswick? Will any reader ever think of such a mode who can procure tan or leaves (p. 451.), or apply steam to beds of stone in the manner of Mr. Hay? (p. 445.) — *Cond.*

*The Otaheite Pine.*—Sir, For the satisfaction of Mr. M<sup>c</sup>Murtrie (p. 231.), I beg leave to give you a particular account of the introduction of the Otaheite pine into this country. In the year 1797, Mr. Birt received a package from the West Indies, consisting of yams, tamarinds, aloes, &c., and, amongst the rest, six gills of the pine in question, but so withered that it appeared very doubtful whether they would grow. Now, it happened that Mr. Tyley (then gardener to Lord Anson at Shugborough) came over to Colton, to assist Mr. Hodson in shifting some orange trees into new tubs, and, seeing the gills, wished to buy one; upon which Mr. Birt made him a present of three of them, the whole of which grew. Of the three left at Colton, only two succeeded, and these were afterwards most probably sent to Shugborough. The above, I believe, is substantially correct, as I had it from Mr. Hodson himself. In conclusion, I must beg leave to inform Mr. M<sup>c</sup>Murtrie that, if he intends to contradict this statement, he must bring forward something more than mere *probabilities*, otherwise even his great name will have very little weight with either me or the public. I am, Sir, yours, &c.—*C. F. Webster. Fazeley, May 18, 1829.*

#### ART. V. Horticultural Society and Garden.

JUNE 2. 1829.—*Read.* Description of a Melon and Cucumber Pit; by Mr. Richard Lacy, of Cayton Hall, Yorkshire.

*Exhibited.* A plant in flower of *Sýmphytum asperrimum* (a valuable food for cattle), from Mr. D. Grant of Lewisham. (p. 442.) Flowers of *Passiflora alata*, and plants in flower of *Rhododéndron catawbiense* and *R. frágrans*, from Messrs. Chandler and Son. Bananas, from Mrs. Beaumont of Hexham Abbey. Fruit of the *Cactus speciosíssima* and *Cactus speciosa*, from Mr. Henry Groom, F.H.S. Cucumbers, from Mr. Richard Lacy. A leaf of the Talipot tree, from Lieut. Seddon, R.A. Knevett’s new Pine Strawberry, from Mr. Samuel Knevett, F.H.S. Seedling Rhubarb, from Mr. Myatt of Camberwell.

*Also, from the Garden of the Society.* Flowers of *Glycine sinensis* [*Wistaria Consequana*], *Glycine frutescens*, *Mímulus luteus* var. *rivularis*, *M. guttatus*. *M. moschatus*, *Collinsia grandiflora*, *Méspilus grandiflora*, *Crataegus Oxyacantha rosea superba*, *Bignonia capreolata*, *Æsculus Pavia rosea*, *Æ. flava*, and *Æ. rosea*, *Gèum coccineum*, *Spiræa bella* and *S. triloba*, Straw-coloured Broom, *Fráxinus O’rnu* latifolia, *Ranunculuses*, *Pæonias*, *Rhododendrons*, *Azaleas*, *Yellow Ròsa Bánksiæ*, *Spartium Scòrpius*, *Scotch Roses*, *Rose de Lisle*, varieties of *Lupinus tomentòsus*, *L. polyphýllus*, *L. ornatus*, *L. arbustus*, *L. micranthus*, *L. nootkatensis*, *Pentstemon procerum*, *P. decussatum*, *ovatum*, *Chelone Sconleri*, *Clárkia pulchella*, *Eriophýllum cæspitòsum*, *Valerianella congesta*, *Æsculus Pavia parviflora*, *Yellow Scotch Roses*, and varieties of Heart’s-ease.

June 16.—*Exhibited.* Li-tchis from China, from Mr. Samuel Mart, F.H.S. Six sorts of Indian Corn, from I. A. Jones, Esq. Flowers of George the Fourth Rose, from Mr. T. Rivers, of Sawbridgeworth. A collection of bulbous Irises, from Mr. Henry Groom, F.H.S. Twenty sorts of Flowers,

from Robert Barclay, Esq. F.H.S. Dutch Rock Melon, from Mr. Henry Bailey of Middleton Park. Keen's Seedling Strawberry, from Mr. Samuel Knevet.

*Also, from the Garden of the Society.* Five sorts of Strawberries. Flowers of *Lupinus arbustus*, *L. polyphyllus*, Watts's climbing China Rose, Frazer's Noisette Rose, Frazer's climbing China Rose, Rose de Lisle, *Rosa indica centifolia*, Drummond's Thornless Rose, Boursault Rose, *Rosa Noisette rouge*, Scotch Rose, *Pæonia albiflora* Whitlèjü, *P. alb. Póttü*, *P. alb. Reevesii*, *P. alb. Humei*, *P. alb. fragrans*, *Mimulus luteus rivularis*, *M. luteus*, *M. guttatus*, *M. floribundus*, *M. parviflorus* *M. moschatus*, *Pentstemon deustus*, *P. venustum*, *P. glandulosum*, *P. speciosum*, *P. ovatum*, *P. diffusum*, *P. procerum*, *Eschscholtzia californica*, *Glycine frutescens*, *Málva Munroiana*, *Gilia capitata*, *Clárkia pulchélla*, *Láthyrus californicus*, *Geum coccineum*, *Galárdia aristata*, *Eútoxa multiflora*, *Collinsia grandiflora*, Irises, Bulbous Irises, Sweetwilliams, Rhododendrons.

*July 7. — Read.* Further Remarks on a Description of a Melon and Cucumber Pit, as read before the Horticultural Society of London, at their Meeting on the 2d of June, 1829, with additional Plans, illustrative of these Remarks; together with a Description and Plan of a Pit for raising and rearing Seedling Melon and Cucumber Plants. By Mr Richard Lacy, Cayton Hall, Yorkshire. Account of a new Melon, named Hewson's Emperor; by Mr. Richard Lacy.

*Exhibited.* Specimens of Indian corn, from Captain Peter Rainier, F.H.S. *Rheum Emodi*, from Aylmer Bourke Lambert, Esq. F.H.S. Two Fruit Pieces, sent by permission of His Grace the Duke of Bedford, and drawn from nature expressly for him, by Mr. George Lance, of 15. Clarendon Square. These were noble specimens of the art of painting, and reflected honour upon the artist. They were exhibited in consequence of having been partly executed from fruit supplied from the Society's garden. Dried fruit of *Diospyros Kaki*, from John Reeves, Esq. F.H.S. These were flat, covered with a grey sugary secretion, sweet, and pleasant. A collection of Pinks from Mr. Hugh Ronalds. Flowers of Larkspur and Rhododendrons, from Mr. Joseph Kirke, F.H.S. Flowers of *Verbena Melindres*, from Mr. James Young, F.H.S. A collection of Roses, from Mr. John Lee, F.H.S. Godfrey's Seedling Strawberry, from Mr. George Godfrey of Shirley Gardens, near Southampton. Wilmot's superb Strawberry, from Mr. J. Harman of Uxbridge. Melon, unnamed, from Mr. David Lyon, gardener to Sir Charles Pole, Bart. F.H.S.

*Also, from the Garden of the Society.* Barnet and Red Antwerp Raspberries, Elton, Black Eagle, Waterloo, May Duke, and Knight's early Black Cherries. Twenty-eight sorts of Strawberries. Flowers of *Eccremocarpus scaber*, *Gesneria bulbosa*, *Cùphea Melvília*, *Combrètum purpureum*, *Quisquális indica*, *Ænothèra*, *Lindleyána quadrivulnera viminea*, *tenélla*, *pállida*, and *rosea álba*; *Clárkia pulchélla*, *C. pulchélla* var. *integripétala*, *Galárdia aristata*, *Eschscholtzia californica*, *Lupinus ornatus*, *plumosus*, and *bicolor*; *Pentstemon diffusum*, *venustum*, and *triphýllum*; *Sida malvæflora*, *Gilia capitata*, *G. pulchella*, *Ánthemis arábica*, *Ibèris umbellata* red and lilac, *Málope malacóides* *Potentilla atrosanguinea*, *Colómia grandiflora*, Sweetwilliams, Double Poppies, *Málva Munroiana*. *Geum coccineum*, *Chelone nemorosa*.

*The Fête at Chiswick.* — Owing to the rainy weather, this fête has been much less satisfactory than any of those which preceded it; and to the disappointments in the garden have been added, as we are informed, any thing but civil treatment, by the officers in Regent Street, to those who have applied for explanation or redress. Various angry and satirical letters have appeared in the newspapers on the subject, which, in a journal like the present, scarcely require further notice. We shall, however, quote an extract or two from the *Literary Gazette*, and a letter, which, in our opinion,

deserves the serious attention of the Fellows of the Society, from the *Sunday Times*.

*The Price of the Tickets.* "The means by which the cost of the tickets for this show has been doubled, seem to us very unworthy of a respectable Society. Unintentionally, no doubt, looking at the character of the managers, the vouchers for tickets to members were so inexplicit and so loosely worded, that many, with these in their possession, were not aware the limit of time applied not to their sending in their requests, but to the future exchange of one sort of cards for another. To their surprise, when they came to understand this, they found, that for the pleasure of having kept half a dozen tickets (called orders for delivery of the other tickets of admission) in their pocket a few days, they were charged *two guineas* instead of *one*!! Such an imposition on the members for such a mistake, arising out of the Committee's own want of plain-dealing, must, we fear, excite feelings very injurious to the institution, both with regard to its fêtes and to its general interests." (*Literary Gazette*, June 27.)

*The Fête.* "Horticultural fêtes do not suit our English gardens and climate, and nothing could be more incongenial than the experiment of Saturday. Rain throughout, plashy grass meadows, gravel and mud walks, above ankle-deep, tents dripping, and too few to shelter the company from the pitiless weather; a rather inferior order of visitors, but these exceedingly well wet; a scramble for provisions (though there was plenty); a fight for carriages, and a general experience of utter discomfort, promising diseases and death to many of the fair sufferers, were the *pleasures* of this unfortunate day. We presume the failure will preclude such attempts in future, and that the space within four walls will be preferred to such absurd speculations, which, however productive they may be made to the Society (by such means as we referred to in our last), ought not to be persevered in at the public expense, and when found to be so prejudicial to the health and safety of its best friends." (*Literary Gazette*, July 4.)

The end of June has been hitherto fixed upon for the fête, in consequence of the great variety of fruits, and especially of strawberries, ripe at that season; but during the last week of June and the first week of July, or rather, we should say, during a period of thirty or forty days, sometimes partly before, but for the most part chiefly after, midsummer, the weather is rainy or uncertain. The first fortnight of June may be considered, as more likely to prove dry, than perhaps any fortnight in the year, and it might be well to have the fête during that period, forgoing the strawberries. The fête itself we should be sorry to see given up.

*Letter to the Editor of the Sunday Times.* "I beg leave to ask a few questions respecting the fête at Chiswick. I could wish to ask if a regular account is kept of the receipts and expenditure in regard to the fête, and furnished to the Fellows of the Society? It is to be hoped that the Council, or Committee of Management, will furnish such a statement; and then the Fellows will know what is the actual profit, which must be considerable.\* The Fellows, or Members, who have been treated with so

---

\* The number of Fellows of the Society to whom tickets were sold was 381, at 1*l.* 1*s.* each, making 400*l.* 1*s.*; tickets sold to non-members at 1*l.* 1*s.*, 3365, producing 3553*l.* 5*s.*; ditto, at 1*l.* 11*s.* 6*d.*, 583, producing 603*l.* 4*s.* 6*d.*; ditto, at 2*l.* 2*s.*, 309, producing 648*l.* 1*s.* The total number of tickets sold was 4438, producing 5185*l.* 8*s.* 6*d.* Of the tickets sold only 3644 were presented at the gardens, owing, no doubt, to the unpropitious state of the weather. The sum due to Mr. Gunter, who provided the repast, was stated to be 5106*l.* 12*s.* Other expenses were *estimated* at 1524*l.* 19*s.* 4*d.*, including 346*l.* for work done expressly for the fête, leaving an estimated balance on the transaction, in favour of the Society, of 125*l.* 17*s.* 2*d.* (*Times*, July 22. 1829.)

little ceremony by the officers and servants of this Society, ought to be made acquainted with the above particulars. The Society collects some thousands per annum, and is always making a great parade and profession of its labours. I am one of those who cannot at present see what good the science of horticulture derives from this Institution, in the way in which it is now conducted; and it is high time that the doings of several individuals, who are making the Society a monopoly to serve their own views, should be brought under public notice. Every person who, either as a member or a visitor, has any business to transact at the office, is really treated with so much rudeness, that not only have many resigned, but few like to go to the Meetings at all. What is the reason that the by-laws are not reprinted, and a copy given to every Fellow? The *Transactions* of the Society are a meagre performance, the plates being much better than the composition or knowledge contained in the letter-press. What is the reason that no list of Fellows and Members has been printed for the last two years? What a pity it is that some twenty or thirty Fellows, who have the real interests of this Society at heart, do not call a Meeting, throw the whole concern open to the public, and elect a really efficient Council, and not allow themselves to be treated with such contumely! Each Fellow is made to sign an obligation to obey laws and statutes which he has never read, because no copy is sent to him; although there is a section of one by-law which positively enacts that every Member shall be furnished with a copy. Very few of the Fellows know this; and the object is to prevent their knowing it. No Member is allowed to speak or address the Meeting under any circumstances. I shall shortly have occasion to address you, Sir, again, as I am well convinced any abuses only require to be made known to be remedied; and the interest you take in rendering the public constant service, induced me to trouble you on this occasion.—*An Enemy to Humbug.*” (*Sunday Times*, July 12.)

We wish we could say, with the writer of the foregoing letter, that “any abuses only required to be made known to be remedied.” We have been pointing out the abuses of this Society ever since we commenced the *Gardener’s Magazine*, and yet we know of no effect that has been produced but the secession of a few dozen members. We could say a great deal on the subject, but it would not be of much use. The fact is, nothing will ever be made of the Society, till it gets completely rid of a certain intriguing individual, whom we shall take care neither to name nor describe. The Society might then be arranged on a comparatively republican principle, which would be found much more suitable to science than its present autocratic one, by which, among other mouth-stopping regulations a Member cannot ask a question before giving six weeks’ notice in writing, and for which the Fellows are indebted to the individual in question and to the by-laws.

— *Cond.*

---

#### ART. VI. *The London Nurseries.*

As I have not lately been able to extend my rambles far, I have observed only a few articles worthy of your attention. Among these may be mentioned a fine high-bred intermediate, between *Cactus speciosissima* and *speciosa*, promising to blend the free floration of the latter with the splendid colour of the former, exhibiting the angular stem of the one with the flat leafy appearance of the other, and at the same time demonstrating that art and nature are alike fertile in the production of high-bred varieties; which varieties are often received by botanical writers, who are



not aware of their origin, as good species. The *Cactus* in question is at Mr. Tate's nursery, Sloane Street, and is said to have come from Mexico; but it differs in no respect from several others that have bloomed in the various nurseries of Mr. Mackie, Messrs. Lee, and Mr. Dennis, which have notoriously been originated by cross fecundation. Some fine plants of *Calceolaria arachnoidea*, and *C. plantaginea* are now in full bloom, promising an abundant supply of seeds; the former is also readily increased by cuttings. *Oenothera rosea alba* is also plentiful, and certainly one of the most conspicuous species in that elegant genus, to which *Clarkia pulchella*, also now plentiful, is closely allied. *Lupinus polyphyllus* promises to seed abundantly; it has been grown to the greatest perfection, throwing up its beautiful spikes of bright blue flowers more than 2 ft. high, at Mr. Russell's nursery at Battersea. — *G. C. July 18, 1829.*

*Epsom Nursery, July 19.* — New or rare plants, chiefly hardy perennials, which have flowered during the months of May and June: —

*Ranunculus (C. Bauh.) filiformis Mich., Cymbalaria Pursh., platanifolius L.*

*Pæonia (L.) Baxteri Sabine.*

*Hunnemannia (Sweet) fumarifolia Sweet's B. F. G. t. 276.*

*Iberis (L.) carnosa Willd. Sweet's B. F. G. New Series, t. 6.* All authors, as Mr. Sweet observes, consider this plant an annual; it has succeeded three successive years, on rockwork, which it adorns with dense corymbs of white flowers, varying to a pale purple.

*Hesperis (L.) excelsa Penny in Hort. Eps. Ad. p. 55.* A very ornamental species, attaining the height of 5 ft., with white flowers from May until August.

*Dianthus (L.) Balbisi Seringe. Sweet's B. F. G. ined., giganteus D'Urv. Sweet's B. F. G. t. 288., nitidus W. et K. Fischeri Spreng. Sweet's B. F. G. t. 245.*

*Málva (L.) angustifolia Cav. Bot. Mag. 2839.*

*Hypêricum (L.) fimbriatum Lam.*

*Piptanthus (Sweet) nepalensis Sweet's B. F. G. t. 264.*

*Genista (Lam.) æthnensis Dec. Bot. Mag. 2674.*

*Trifolium (Tourn.) Wormskiöldii.*

*Orobis (Tourn.) Fischeri Sweet's B. F. G. t. 289.*

*Potentilla (Nestl.) Clusiana Jacq. Bot. Mag. 1527., Russelliana Sweet's B. F. G. t. 279.* This fine hybrid plant has been raised (about the same time) in several collections, with little variation.

*Oenothera (L.) rosea-alba Bernh. Sweet's B. F. G. 268., affinis Penny in Hort. Eps. B. F. G. 294.*

*Sedum (L.) sempervivum Ledeb. Bot. Mag. t. 2474.*

*Saxifraga (L.) leucanthemifolia Lapeyr.* A curious viviparous species; crustata *Vest.*, retusa *Gouan.*, tricuspidata *Rottb.*

*Didiscus (Dec.) cæruleus Dec. Bot. Mag. 2875.*

*Tragopogon (L.) canus Willd.*

*Catananche (L.) cærulea L. v. alba.* A pretty variety, not observed elsewhere.

*Erigeron (L.) glabellum Nutt. Bot. Mag. 2923.*

*Cineraria (L.) aurantiaca Hopp. B. F. G. 256.*

*Achillea (L.) lingulata Kit., Gebleri Willd.*

*Pyræthrum (Sm.) tenuifolium Willd.*

*Lobelia (L.) secunda L.*

*Campánula (L.) infundibulum Vest.*

*Sphenótoma (R. Br. and Sweet) gracile Sweet's Fl. Aust. t. 44.*

*Escallonia (Mut.) rubra Pers. Bot. Mag. 2890.*

*Amsônia (Walt.) angustifolia Mich. Sweet's B. F. G. ined.* A rare little plant, thriving well in peat soil.

*Asclèpias (L.) quadrifolia Jacq.*

*Polemoniùm (L.) villosum Rudolphi. Sweet's B. F. G. t. 266. Specifi-*

cally distinguished from *P. Richardsoni* Graham, *Bot. Mag.* 2800., by its creeping roots, and the different form and direction of the leaflets, confirmed moreover by a totally distinct aspect.

*Phlòx* (*L.*) procumbens *Lehm. Sweet's B. F. G. New Series*, t. 7. An interesting addition to this numerous genus, with procumbent stems, and lilac flowers tinged with blue. It is at present extremely rare.

*Calystègia* (*R. Br.*) dahùrica *Bot. Mag.* 2609.

*Salpiglòssis* (*R. et P.*) stramínea *Hook. Sweet's B. F. G.* 231., atropurpùrea *Graham. B. F. G.* 271., pìcta *Sweet. B. F. G.* 258. These fine plants become suffruticose if preserved in a green-house. None can be more truly worthy of cultivation.

*Nicotiàna* (*L.*) acuminàta *Bot. Mag.* t. 2919.

*Nolàna* (*L.*) fruticòsa *Penny in Hort. Eps.* p. 34. (tenèlla *Lindl. Hort. Trans.* vol. vii. part ii. p. 252.) Mr. Lindley erroneously considers this plant an annual. It has remained perfectly shrubby, for several years, in a green-house, to which it is no common ornament: hence I have retained the above original and expressive name.

*Digitàlis* (*L.*) laciniàta *Lindl. Bot. Reg.* 1201. The account given of this interesting species (p. 156.) is not correct. It should be, a frame suffruticose plant, with shining lacinated leaves, and greenish-yellow and brown flowers, produced in abundance from May until October. It is propagated by cuttings, and also by seeds, which sometimes ripen.

*Pentstemon* (*Willd.*) èlegans *Kunth. Bot. Reg.* t. 1138.

*Calceolària* (*L.*) arachnòidea *Graham. Bot. Mag.* 2874. This exceedingly rare plant grows luxuriantly in the open ground, during the summer, expanding its lovely purple flowers in the last days of June, and continuing in beauty for several months.

*Sàlvia* (*L.*) canariénsis *L.*

*Prunèlla* (*L.*) pennsylvànica *Willd.*, álba *Pall.*

*Sideritis* (*L.*) taùrica *Willd.*

*Stachys* (*L.*) córsica *Pers.*

*Clerodéndron* (*L.*) emírnense *Bojer. Bot. Mag.* 2925.

*Verbena* (*L.*) alàta, simplex.

*Thunbèrgia* (*L.*) capénsis *Retz.*, angulàta *Hook. Ex. Fl.* t. 166.

*Prímula* (*L.*) verticillàta *Forsk. Bot. Mag.* t. 2842., scòtica *Hook. Fl. Lon.* t. 155., pusìlla *Goldie* (from the author). *Sweet's B. F. G. New Series*, t. 6. ?

*Lubínia* (*Vent.*) atropurpùrea *Link.*

*Anagallis* (*L.*) *Webbiàna* *Penny in Hort. Eps.* ed. 2. ined., *Marryàttæ* *Sweet in Obs. B. F. G. New Series*, t. 4.

*Taxánthema* (*R. Br.*) ægyptiaca *Sweet. Bot. Mag.* 2363.

*O'rchis* (*L.*) coriòphora *S. B. F. G.* t. 219.

*Habenària* (*Willd.* and *R. Br.*) fimbriàta *R. Br. Bot. Reg.* 405. One of the loveliest of this admirable tribe, about 18 in. in height, with pale purple flowers, and a singularly fimbriated labellum. It thrives amazingly in rooty peat and Sphágnum.

*Tris* (*L.*) *Falconeriàna* *Penny in Hort. Eps.* ed. 2. ined; this fine plant has been named in compliment to Mr. Falconer of Carlowrie, who, it seems, first received it from Paris (Vol. III. p. 490.); nepalénsis *D. Don*, tridentàta *Sweet. B. F. G.* t. 274. Very distinct from *I. tripétala* *Bot. Mag.* t. 2886.

*Alstrømèria* (*L.*) *Simsii* *Spreng. B. F. G.* 267., *Hookèri* *Sweet. Hook. Ex. Fl.* t. 181., *Flòs Martini* *Lindl. Bot. Reg.* 731., *hirtèlla* *Kunth. B. F. G.* t. 228.

*Scílla* (*L.*) esculénta *Bot. Mag.* 1574.

*Uropétalon* (*Ker*) fùlvum *Sweet.*

*Helònias* (*L.*) erythrospérma *Mich. Bot. Mag.* t. 803.,

*Zigadènus* *Mich. glabérrimus* *Mich. Bot. Mag.* t. 1680., *bracteàtus* *Sweet. Bot. Mag.* t. 173.

*Tradescántia* (*L.*) congèsta *D. Don. Penny Hort. Eps.* p. 48. — *Alpha.*

## ART. VII. Covent Garden Market.

		From		To				From		To				
		£	s.	d.	£	s.	d.	£	s.	d.	£	s.	d.	
<i>The Cabbage Tribe.</i>														
Cabbage, White, per dozen		0	0	6	0	1	0	Mint, per dozen bunches	0	1	6	10	3	0
Cabbage Plants, or Coleworts, per dozen		0	1	0	0	1	6	Marjoram, per doz. bunches	0	2	6	0	3	0
Cauliflowers, per dozen		0	2	0	0	6	0	Savory, per dozen bunches	0	2	6	0	3	0
<i>Legumes.</i>														
Peas	per half sieve	0	1	6	0	2	0	Basil, per doz. bunches	0	3	0	0	4	0
	per sieve	0	2	6	0	3	6	Rosemary, per doz. bunches	0	2	0	0	3	0
	per sack	0	6	0	0	10	0	Lavender, per doz. bunch.	0	4	0	0	0	0
Beans, Windsor	per h. sie.	0	0	9	0	1	0	Tansy, per dozen bunches	0	2	0	0	0	0
Kidneybeans, per half sieve		0	5	0	0	6	0	<i>Edible Fungi and Fuci.</i>						
		0	3	0	0	5	0	Mushrooms, per pottle	0	1	0	0	1	0
<i>Tubers and Roots.</i>														
Potatoes								<i>Fruits.</i>						
Good Old	per ton	5	0	0	7	0	0	Apples, per bushel						
	per cwt.	0	5	0	0	7	0	Summer Juneating	0	6	0	0	8	0
	per bush.	0	2	6	0	3	6	Streaked do.	0	4	0	0	6	0
Kidney per bushel		0	3	0	0	4	0	Hawthorndean	0	6	0	0	8	0
Scotch per bushel		0	3	0	0	4	0	Baking	0	4	0	0	6	0
Potatoes, New, per pound								Peaches, per dozen	0	12	0	1	10	0
Early Kidneys		0	0	4	0	0	6	Nectarines, per dozen	0	18	0	1	10	0
Ditto, Round		0	0	3	0	0	5	Apricots, per dozen	0	4	0	0	5	0
Fine, from Cornwall		0	0	3	0	0	4	Cherries, Wall, per pound						
Turnips, White, per bunch		0	0	2	0	0	3	Duke's	0	2	6	0	4	0
Carrots, per bunch								Circassians	0	2	6	0	4	0
Young		0	0	6	0	1	0	Bigarreaus	0	1	6	0	2	6
Horn		0	0	4	0	0	8	Cherries, in quantities by the sieve, containing from 24 to 48 lbs. per doz. lbs.						
Red Beet, per dozen in bun.		0	0	6	0	0	0	Black Hearts	0	2	0	0	2	6
Horseradish, per bundle		0	3	6	0	5	0	Dukes	0	2	0	0	2	6
Radishes, Red and White								Bigarreaus	0	2	6	0	4	0
Turnip, per doz. bunches		0	0	9	0	1	0	Bleeding Hearts	0	2	0	0	4	0
<i>The Spinach Tribe.</i>														
Sorrel, per half sieve		0	1	0	0	1	6	Kentish and Flemish	0	1	6	0	2	6
<i>The Onion Tribe.</i>														
Onions, Green, per bunch		0	0	4	0	0	6	Gooseberries, per half sieve						
Garlic, New, per pound		0	0	6	0	0	8	For preserving	0	1	6	0	2	6
Shallots, New, per pound		0	0	10	0	1	0	Ripe, for table	0	2	6	0	3	6
<i>Asparaginous Plants, Salads, &amp;c.</i>														
Artichokes, per dozen		0	4	0	0	6	0	Currants, per half sieve						
Lettuce, per score								Black	0	3	0	0	3	6
Coss		0	1	0	0	1	6	White	0	2	0	0	2	6
Cabbage, fine large		0	1	0	0	1	6	Red, for Wine	0	2	0	0	2	6
Celery, per bundle (12 to 15)		0	1	0	0	1	6	Dessert	0	4	0	0	5	0
Small Salads, per punnet		0	0	2	0	0	3	Raspberries, per gal. (2 pot.)						
Watercress, per dozen small bunches		0	0	4	0	0	6	Red	0	0	8	0	0	10
<i>Pot and Sweet Herbs.</i>														
Parsley, per half sieve		0	1	6	0	2	6	White	0	0	8	0	1	0
Tarragon, p. doz. bunches		0	6	0	0	8	0	Strawberries, per gallon (2 pottles) about 3 pints	0	0	6	0	1	6
Purslain, per punnet		0	1	0	0	1	3	Walnuts, for pickling, per bushel	0	4	0	0	7	0
Fennel, per dozen bunches		0	1	6	0	2	0	Pine-apples per pound	0	5	0	0	12	0
Thyme, per dozen bunches		0	1	6	0	2	0	Hot-house Grapes, p. pound	0	3	0	0	8	0
Sage, per dozen bunches		0	1	6	0	2	0	Figs, per dozen	0	12	0	0	0	0
								Melons (each)	0	2	0	0	7	6
								Cucumbers, Frame, p. brace	0	0	8	0	1	0
								Oranges, per dozen	0	0	9	0	2	6
								Bitter Oranges, per hund.	0	4	0	1	0	0
								Lemons, per dozen	0	0	9	0	2	0
								Lemons, per hundred	0	4	0	0	14	0
								Brazil Nuts, per bushel	0	16	0	0	0	0

*Observations.*—The weather, in the early part of June, was dry and fine; Strawberries then coming into season, it was feared the crop might be short. The late rains at first, by their genial influence, made them abundant; but, by their long continuance, have rendered them almost tasteless, and diminished their supply and value materially. Notwithstanding, our market has been furnished with the utmost profusion, and in the greatest variety, which may be fairly attributed to the improved method of culture, as well as to the new varieties introduced from seed, among which may be enumerated Keen's Seedling, the Bostock Seedling, the Roseberry, the Downton, Wilmot's Superb, Grange's Black Prince, Wilmot's new Scarlet, new Bath Scarlet, Knevett's new Pine, with Faulkner's new Scarlet Pine. The above Selection embraces all that may be considered valuable, as cultivated in the immediate neighbourhood of London. The method of culture to which I

allude is almost too well known to make it necessary to mention it; but as many of your remote readers may not be directly acquainted with it, I will just give the outline. At this season of the year, the earliest and strongest runners are placed in the most open spaces of the garden, in rows about 2 ft. apart and about 1 ft. 6 in. from each plant in the row. To fill up the space, a crop of lettuce may be planted between, for the autumn and early winter use; or the ground intended for them may be previously sown with onions, to be cleared off at the usual period in September. By this early planting the plants become strong and come into bearing the first season, producing both early and fine fruit, which, by exposure to the influence of the sun, acquire size, colour, and flavour: the following year the plants come into full bearing. By this method a constant supply of fine large fruit may be obtained, far superior to the old method of planting them in beds of several rows together and allowing the runners to fill or choke up the intermediate spaces. The practice of irrigation has been tried by a large cultivator (I believe, Mr. S. Knevet), upon an extensive scale; but I am not able to ascertain satisfactorily with what success, as to combining in the produce, quantity, size, and flavour, all of which are necessary to determine the experiment as worthy of imitation. The supply of cherries has been as great as that of strawberries; but their quality is much deteriorated by the prevalence of wet and wind. The bigarreau, formerly a scarce cherry, is now abundant; with many other varieties, and is found to be as good a bearer as many of the hitherto common sorts, which may serve to encourage the growers, in the formation of their orchards, to select the better varieties, as more likely to pay them for their trouble and labour. We have had a supply of early potatoes from Cornwall; which serves to show that the practice of growing articles of consumption in remote situations that are favourable to them, may be made to answer well; as suggested by you (Vol. IV. p. 27.), with respect to growing the pine-apple in the neighbourhood of the great coal districts, where fuel could be obtained so readily and at so small a cost. — *G. C. July 1829.*

---

ART. VII. *Provincial Horticultural Societies.*

HERTFORDSHIRE.

*BALDOCK Society for Promoting Horticultural Science.* — Sir, I beg leave to send, for insertion in your Magazine, an account of the Meeting of a Society, of the existence of which you are, perhaps, altogether ignorant; though, I trust, from its increasing prosperity and usefulness, it will, ere long, be well known, and its merits duly appreciated, in this and the neighbouring counties. It is entitled a Society for promoting Horticultural Science: patron, the Most Noble the Marquess of Salisbury; president, the Right Hon. Lord Dacre; vice-presidents, Adolphus Meetkerke, Esq., and John Izard Pryor, Esq. The business of the Society is transacted by a committee of management, who, as well as the vice-presidents, are chosen annually. Its Meetings are held twice a year, at Baldock in Hertfordshire, when prizes are distributed, in articles of plate, for fruits and flowers, to as great an amount as the funds of an infant society will permit. The members dine together on these occasions; and, after dinner, devote a considerable portion of time to the discussion of subjects connected with horticulture. This last feature is the key-stone on which, I apprehend, rests the prosperity of the Society. The Spring Meeting was held on May 4., when prizes were adjudged as follows:—

*Flowers.* Auriculas. Best pair : 1. Mr. Green ; 2. Mr. Christian of Baldock, Hertfordshire ; 3. Seedling, Mr. Troup, Baldock. Polyanthuses. Best pair : 1. Mr. Green ; 2. Mr. Rare, Biggleswade, Bedfordshire ; 3. Seedling, Mr. Jos. Tranter, Baldock. Best Nosegay of different Flowers, V. Pryor, Esq., Baldock. — *Fruit.* Apples. Best plate of three different sorts, three of each sort : 1. Mr. Troup, Baldock ; 2. Mr. Windmill, Henlow, Beds. ; 3. Mr. Abbiss, Ickleford, Herts. — *Culinary Vegetables.* Cucumbers : 1. Mr. Dall, Wimpole, Cambridgeshire ; 2. Mr. Troup, Baldock ; 3. Mr. Spetchley. Rhubarb : 1. Mr. Tompkins, Clifton, Beds. ; 2. Mr. Hyland, Hinchinbrook, Huntingdonshire.

A party, unprecedentedly large, sat down to a good dinner provided by the landlord, Mr. T. Parrington. Unwin Heathcote, Esq., of Shephalbury, in the chair. After dinner, the healths of the patron and president were given separately from the chair, and drank with acclamation. Amongst the topics brought forward were, the methods of forcing rhubarb made use of by the different competitors, and the modes to which they resorted to preserve their apples. Here it would be injustice to Mr. Troup to omit mentioning that each of his nine apples were as perfect as when first gathered. His plan was to keep them covered up with oat chaff. A vote of thanks was signified, from the chair, to Mr. Ferrars of Welwyn, for a paper on the growth of dahlias (more properly called georginas, I believe), which he had transmitted to them on a former occasion. A number of new members were proposed (two resident in London) and elected. After a most harmonious day, the party separated in high spirits, at the prospect for the future prosperity of the Society. I am, Sir, &c. — *A Member.*

#### CAMBRIDGESHIRE.

*The Cambridgeshire Horticultural Society.* — The May Show of this Society was held on May 22. The season was very favourable, and the flowers, fruits, and vegetables were of the first order. We do not remember any Show which has more strongly marked the progress and importance of the Society. Every thing was superior in its kind ; but we think the highest meed of praise was due to the anemones. The Rev. G. A. Browne being called to the chair, premiums were awarded as follows : —

*Plants.* Geraniums. Six, in pots : 1. (Medal) Royal Princess Sophia Augusta, Rollinsonii, Macranthum, Latifolium, Humei, Tippoo Saib, Mr. Widnall ; 2. Defiance, Macranthum, Latifolium, Paul Pry, Lord Combermere, Naírnii, Mr. Palmer.\* Three, in pots : 1. General Riego, Lasiocaúlon, Foliósum, Mr. Palmer ; 2. Dobreeanum var. basilicum, Anna Boleyn, Mr. Widnall. Best, in a pot : Daveyanum and Triúmphans, grafted on the stock of the Generalissimo, Mr. Searle. Pæonies. Three: *Moutzn*, Rúbra, Officinális, Mr. Gimson. Best : Officinális, Mr. Gimson. Stock. Red, grown in a pot : Mr. Catling. White, grown in a pot : Mr. Brewer. Dodecátheon Meádia : Mr. Widnall. — *Flowers.* Tulips. Six : 1. (the medal) Washington, Abercromby, Bagot, Rose Heroine, San Joe, Gloria Mundi, Mr. Gimson ; 2. Unknown, Reubens, Holmes' Pit, Charbonnie Noir, Cerise à Belle Forme, Triumph Royal, Mr. Frederick Finch\* ; 3. Ambassadeur d'Hollande, Triumph Royal, Matilda, Passe Catafalque, Majesteuse, Cancellier, Mr. Searle. Three : 1. Imperatrice de Maroc, Heroine, Reuben's Saint Louis, Mr. Dobson ; 2. Triumph Royal, Ambassadeur d'Hollande, Rose Blanca, Mr. Gimson. Best, Thalestris, Mr. Dobson. Anemones.

---

\* Mr. Widnall having already had the medal within three years, it will devolve on Mr. Palmer, and Mr. Widnall will take the second prize. Mr. Finch and Mr. Gimson will change prizes for the same reason.

Six, in pots, Therese, Belle Comtesse, Aimable Princesse, Julien, L'Episcopal, L'Empereur de Russe, Mr. Searle. Best, Déesse Flore, Mr. Searle. Heart's-ease. Six, in pots, Large Purple, Bright Yellow, Tricolor, Purple and Yellow tipped, Purple and Yellow Spotted, Dark Puce, Mr. Searle. Best, in pot, Dark Puce, Mr. Denson. — *Fruit.* Strawberries, best fifty, Roseberry, &c., Rev. G. Jenyns. — *Culinary Vegetables.* Coss Lettuce, two weightiest heads, 3 lbs., Mr. Magee. Lettuces, two best in quality, Mr. Palmer. Asparagus, fifty heads, Mr. Palmer. Cabbage, heaviest, Mr. Widnall. Cauliflowers, two, Colonel Pemberton.

*Treasurer's Prize.* Bouquet, Mr. Gimson.

*Cottagers' Prizes.* Double Stock, grown in a pot, Mary Tuck of Harston. Lettuce, Baron Moore of Grantchester. Cabbage, William Perry of Hildersham.

*Extra-Prizes.* Cottager's Stock, John French, Cherryhinton. Cottager's Tulips, William Perry, Hildersham. *Erica mirabilis*, Mr. Biggs. Heart's-ease, Mr. Dobson. Peaches, Mr. Palmer. Kitchen Apples, Mr. Brown, Fordham. (*Cambridge Chron.*, May 29.)

The Cambridge June Show took place on the 19th, when the display was very splendid and well arranged, and the company were highly gratified. The Rev. G. A. Browne was called to the chair, and announced the following adjudication of prizes: —

*Flowers.* Ranunculuses. Six, one of a sort: 1. (Prize Medal) Cedo Nulli, Charlotte, Lucrece, La Française, Louise, Theodat, Mr. Searle; 2. Thompson's Queen, Charbonnier, La Favorite, Chasselas, Naxara, Jaune en Pomponne, Mr. Twitchett. Four, one of a sort, La Singulaire, Princess of Wales, Jupiter, Passe Niobe, Mr. Twitchett. Best, Daphne, Mr. Searle. Pinks. Six, one of a sort: the first prize would have been given to Mr. John Sharpe (being No. 65.), but there were two flowers of a sort. Four, one of a sort: no first prize: 2. Mr. John Sharpe, Professor Turton's gardener. Best, Harefield Beauty, Mr. Haylock. Seedling, Mr. Sharpe. Roses. Six: no first prize; 2. Tarquin, Prince William, Early Blush, Rouge Agathe, Rouge Carmine, Violette et Rouge, Mr. Catling. Three, Mr. Dobson. Best, Princess Victoria, Mr. Gimson. Sweetwilliams, four trusses of different shades, Mr. Charles Newby. — *Fruit.* Strawberries, best pound for flavour: 1. Keen's Seedling, Colonel Pemberton; 2. Keen's Seedling, Mr. Lestourgeon. Best pound containing fewest, 30 in number, Keen's Seedling, Mr. Dobson. Cherries. Best plate: no first prize; 2. May Duke, Mr. Searle. Melon, not less than two pounds: 1. Netted Cantaloupe, Mr. Searle; 2. Early Cantaloupe, Mr. Wilson, Lord De La Warr's gardener. Grapes, White Muscat, Mr. Dall.

*Treasurer's Bouquet.* Mr. Gimson.

*Cottagers' Prizes.* Pink, Edward Dowse, Ickleton. Rose, Widow Pryor, Duxford. Geranium, James Becket, Ickleton. Potatoes, James Tuck, Windmill Cottage, Harston. Peas, Henry Hunt, Duxford.

*Extra-Prizes.* Cottager's Geranium, Jos. Beales, Cherryhinton. Nectarines, Mr. Palmer, Ely. Stock, Mr. Patrick Beales. Cucumbers, Mr. Dall.

The next Show was fixed for Friday the 24th of July, and the Committee propose to give cottagers' prizes for the best pound of gooseberries, best pound of currants, best cucumber, best carnation, picotee, or pink, best balsam, and the best hollyhock. (*Cambridge Chron.*, June 26.)

*Cambridge Florists' Society.* — The Show of Tulips, Anemones, and Stocks was held at the Town Hall on May 25., when 347 blooms of tulips were sent in to compete for the prizes, from which 36 were selected by the judges, and placed on the grand stand at the upper end of the tables, where they presented a very beautiful appearance; they were backed by the finest stocks, scarlet, purple, and white; and from them extended a column of superb geraniums, orange-trees with fruit on them, and beautiful exotics, in

full bloom, to the bottom of the tables, the whole being encircled with a border of tulip blooms. The effect of the mass of flowers, of various heights and colours, was a source of admiration to all who beheld it. For this splendid show the Society were principally indebted to the kindness of Mr. Widnall, florist, &c., of Grantchester, who sent in a number of beautiful and rare geraniums, with some of which he had gained the silver prize medal given by the Horticultural Society at their Show on Friday last. Mr. Brewer, nurseryman and florist, sent in the orange trees, and several other exotics, as well as a number of beautiful geraniums; and Mr. Gimson, nurseryman and florist, of Linton, also contributed. Prizes were awarded as follows:—

*Tulips.* Feathered Bizards: 1. Roi de Perse, Mr. R. Nutter; 2. Surpasse Charbonniere, Mr. Haylock; 3. Roi de Perse, Mr. R. Nutter; 4. Grand Cairo, and 5. Gold Beares, Mr. Bailey; 6. Gold Purse, Mr. Twitchett. Feathered Bybloemens: 1. Imperatrice de Maroc, Mr. Dobson; 2. Imperatrice de Maroc, Mr. Finch; 3. Alexander Baguet, Mr. Haylock; 4. Ponceau Unique, Mr. Dobson; 5. Black Baguet, Mr. Finch; 6. Maître Partout, Mr. Peeling. Feathered Roses: 1. Rose Heroine, Mr. Nutter; 2. Rose Heroine, Mr. Gimson; 3. Rose Heroine, Mr. Dobson; 4. Rose Heroine, Mr. Nutter; 5. Rose Heroine, Mr. Dobson; 6. Juno, Mr. Finch. Flamed Bizards: 1. Charbonnier Noir, Mr. Dobson; 2. Tippoo Saib, Mr. Gimson; 3. Abercromby, Mr. Finch; 4. Castrum Doloris, Mr. Twitchett; 5. Emperor Charles, Mr. Dobson; 6. Sir Sidney Smith, Mr. Haylock. Flamed Bybloemens: 1. Roi de Siam, Mr. Dobson; 2. Bold Lutherus, Mr. Haylock; 3. Titian, Mr. Twitchett; 4. Rigaut, Mr. Gimson; 5. Washington, Mr. Sharp; 6. Washington, Mr. Finch. Flamed Roses: 1. Rose Triomphe Royale, Mr. Nutter; 2. Rose Triomphe Royale, Mr. Dobson; 3. Hebe, Mr. Bailey; 4. Hebe, Mr. Finch; 5. Vesta, Mr. Dobson; 6. Rose Triomphe Royal, Mr. Finch. *Anemones:* 1., 2., and 3. Stearne's W. Wilkins, Esq., Mr. Stearne; 4. Leopard, Mr. Gimson; 5. Unknown, Mr. Dobson; 6. Unknown, Mr. Crisp. *Stocks.* Scarlet: 1. Mrs. Markham; 2. Mr. Twitchett; 3. Mrs. Markham; 4. Mr. Haylock. White: 1. Mr. Rickard; 2. Mr. Dobson; 3. Mr. Twitchett; 4. Mr. Dobson. Purple: 1. Mr. Balls; 2. Mrs. Markham.

The Society's Show of Ranunculuses was then fixed for Wednesday, the 17th of June, at the Town Hall. (*Cambridge Chron.*, May 29.)

#### SUFFOLK.

*Bury Floral and Horticultural Society.*—The Second Meeting of this Society was held at the Eagle and Child Inn, on June 3., and was numerous and respectably attended. The prizes were awarded as follows:—

For the best and second best feathered bizard, best bybloemen rose, and second best flamed bizard, to Mr. John Warburton of Tottington. For the best, second, and third bybloemens; second and third bybloemen roses; best and third flamed bizard; best, second, and third flamed bybloemen; best, second, and third flamed, and second and third self-roses, to Mr. James Walmsley of Birtle. For the best and second hot-house plants; second and third green-house plants; best, second, and third heaths; best geranium; second herbaceous plants; best hardy shrub; and best rose, to the gardener of J. Ramsbottom, Esq. For the best green-house plant, best herbaceous plant, and best pine, to the gardener of J. Grant, Esq. For the second rose, and hot-house plant, to the gardener of William Grant, Esq. For the third herbaceous plant, second and third hardy shrubs, best and second grapes, and best potatoes, to the gardener of J. Kay, Esq. For the best self-rose, to Mr. R. Palfreyman of Bury. For the best cucumbers, to Mr. Thomas Greenhalgh of Chesham Fields. For the best cabbage, to Mr. Robert Kaye, stationer, Bury. For the second geranium, to Mr. Charles

Openshaw. For the third geranium, to Mr. Thomas Clough. (*Manchester Courier*, June 15.)

The *Second Show of this Society* took place on June 30., and the exhibition was exceedingly good, including a great variety of exotic, hardy, and florists' flowers, among which may be particularly noted the prize *Alstrœmèria*, a fine specimen of *Cactus speciosissima*, Scarlet *Gladiolus*, Oleanders, *Dahlia compàcta*, the annual *Coreòpsis* (tinctòria) 6 ft. high, and some superb bouquets. Some shaddocks, of extraordinary size, were shown from the hot-houses of N. L. Acton, Esq. Strawberries of superb appearance, French crabs grown by Mr. Pawsey of Lidgate, in 1827, perfectly sound, &c. &c. The Cape lettuces are an admirable species, as round and solid as a drum-head cabbage. A very meritorious specimen of virgin honey, the produce of this year, in a box, exhibited by a servant, was deservedly rewarded, though no prize was offered, and was sold readily at 2s. 6d. per lb. There were a great number of visitors; and the ladies afterwards partook of some strawberries in another apartment decorated with roses. Prizes were awarded as follows:—

*Flowers.* Red Stock, Mr. Lines, gardener to N. Lee Acton, Esq. Ranunculuses, Mr. Samuel Middledith, Bury. Pinks, Mr. Barrett. Roses, Mr. Hodson, Chapel House. Plant in Bloom, *Alstrœmèria*, Mrs. Reeve, Westgate Street. Best Bouquet, Mrs. Reeve. — *Fruit.* Grapes. Forced, Black Prince, Miss Pollen, Hartest. Strawberries. For flavour, Downton, Mr. Lomax. Largest, 35 to the pound, Keen's Seedling, Mr. Marriott, Stowmarket. Cherries, White Heart, Mr. Barrett, Hardwicke. — *Culinary Vegetables.* Cauliflowers, Miss Pollen. Peas, Mr. Lord, gardener to the Rev. Jas. Cullum. Potatoes, Mr. Hammond, gardener to Sir H. Bunbury. Turnips, Mr. Knights, gardener to Mr. D. Beauvoir. Carrots, Mr. Buchanan, Stowmarket. Cape Lettuces, Mr. J. H. Payne, Bury.

*Cottagers' Prizes.* Onions, Jermyn, Timworth. Cabbages, Agar, Timworth. Brompton Stock, Brett, Stowmarket. — *Reward.* Box of Honey, James Fenton, Ingham. (*Bury and Norwich Post*, July 1.)

#### BERKSHIRE.

*Windsor Horticultural Society.* — The Second Meeting of this Society took place on June 26., when the prizes were awarded as follows:—

*Flowers.* Pinks: 1. Mr. Willmer of Sunbury; 2. Mr. Gould, Royal Gardens, Windsor; 3. Mr. Weedon, Hillingdon; 4. Mr. Lillewhite, Windsor; 5. Mr. Cooper, Bray; 6. Mr. Bowyer, Bray. Geraniums: 1. Mr. Brown, Slough; 2. Mr. Ingram, Frogmore; 3. Mr. Cameron (E. Foster's, Esq.), Clewer; 4. Mr. Cooper. Roses: 1. Mr. Willmer; 2. Mr. Gould. Dahlias, Mr. Cameron. *Gœum coccœneum*, Mr. Vare, Windsor. Poppies, Mr. Lovegrove, Windsor. — *Fruit.* Strawberries. Keen's Seedling: 1. Mr. Cameron; 2. Mr. Ingram. Wilmott's Superb, Mr. Robertson, Windsor.

A great number of other articles were produced; amongst them we particularly noticed *Cactus speciosissima*, *Lilium longiflorum*, *Polýgala cordata*, the Iver Cottage Brier, from Mr. Woodcock, Iver, &c. (*Windsor and Eton Express*, June 27.)

#### GLOUCESTERSHIRE.

*Gloucester Horticultural Society.* — The Second public Exhibition for the season took place on May 29., and, in point of splendour and attraction, was in no way inferior to former Shows. The varied beauties of the tulip and anemone classes, though, perhaps, a little too much advanced in bloom by the late warm weather, afforded great pleasure to the connoisseur, whilst the rarer ornaments of the hot-house and green-house were in high perfection. The number of specimens contributed was very great, not less than 823 appearing on the books of the Society. (*Hereford Journal*, June 3.)



The *Third Public Show* for the season, of this very gratifying Institution, took place on June 26. The competition amongst the exhibitors of pinks was very strong; and it was almost astonishing to see the perfection to which that once simple flower has been raised by careful cultivation. Of ranunculuses the show was very limited, the extreme dryness of the season having caused an almost total failure in that department of the florists' occupation. The prize roses were splendid, and well deserved the distinction awarded them. There was a delightful assemblage of the *Erica* tribe, and other choice ornaments of the green-house, were in great abundance. A profusion of fruits, calculated to please both the eye and the palate, graced the room; some of the strawberries were really superb. In addition to those fruits which appear in the prize-list below, great praise was due to some remarkably fine grapes exhibited by Mr. Jessop of Cheltenham, some melons shown by J. H. Byles, Esq., and some nectarines sent by J. C. Straford, Esq. The number of specimens entered in the Society's books amounted to nearly 1,200. Prizes were awarded as follows: —

*Plants.* Stove or Green-house: 1. *Hoya carnosa*, and 2. *Polýgala latifolia*, Mr. J. C. Wheeler; 3. *Crássula versicolor*, Mr. J. D. Wheeler; 4. *Mesembryánthemum purpúreum*, Mr. J. C. Wheeler; 5. *Gnaphálium fúlgidum*, Miss Walters. Heaths: 1. *Ventricòsa supérba*, and 2. *Depréssa*, Mr. J. C. Wheeler; 3. *Ventricòsa incarnàta*, Mr. J. D. Wheeler; 4. *Coventryàna*, Mr. J. C. Wheeler; 5. *Véstita coccínea*, Mr. J. D. Wheeler. Hardy: 1. *Kálmia latifolia*, and 2. *Andrómeda pulverúenta*, Mr. J. D. Wheeler; 3. *Cámpanula persicifolia*, R. Canning, Esq.; 4. *Hydránga horténsis*, Mr. J. D. Wheeler; 5. *Mule's Pink*, Miss Walters. — *Flowers.* Ranunculuses. Dark: 1. *Capel*, Mr. Crump; 2. *Naxara*, Mrs. Matthews; 3. Mr. Crump; 4. *Zebra*, and 5. Mr. Crump. Light: 1. *Eliza*, 2. *Druit's Yellow*, 3. *Temeraire*, and 4. *Thompson's Kitty*, Mr. Crump; 5. *Lovely Ann*, Mrs. Matthews. Pinks. Black and White: 1. and 2. Mr. George Bubb; 3. Mr. Elton; 4. Mr. Grafton; 5. Mr. George Bubb. Red Laced: 1. Mr. Crump; 2. Mr. Hitch; 3. Mr. Pullen; 4. Mr. Elton; 5. Mr. J. D. Wheeler. Purple Laced: 1. Mr. Pullen; 2. Mr. Crump; 3. Mr. J. D. Wheeler; 4. Mr. Earl; 5. Mr. Crump. Selfs and Fancies: 1. and 2. Mrs. Matthews; 3. and 4. Mr. George Bubb; 5. A. Maitland, Esq. Roses. Dark: 1. *Tuscany*, Mr. T. Ryder; 2. *Grand Sultan*, Mr. Jessop; 3. *Imperial*, Mr. Elton; 4. *Carmine*, Mr. T. Ryder; 5. *Royal Purple*, Mr. Jessop. Light: 1. *Watts's Seedling*, and 2. *Rose Unique*, Mr. J. D. Wheeler; 3. *Celestial*, Mr. J. C. Wheeler; 4. *Rosa odoràta*, Mr. Jessop; 5. *Hýbrida de Bengal*, Mr. J. C. Wheeler. — *Fruit.* Cherries: 1. *May Duke*, R. S. Davies, Esq.; 2. *Early May*, Mr. Hitch; 3. *Black Heart*, R. Canning, Esq.; 4. *Elton*, and 5. *Ronald's Black Circassian*, C. O. Cambridge, Esq. Strawberries: 1. *Wilmot's Superb*, Mr. Elton; 2. *Keen's Seedling*, Miss Button; 3. *Waterloo*, Mr. C. Bonner; 4. *Caroline*, Rev. Mr. Jones; 5. *Knight's Downton*, Mr. Hitch. — *Culinary Vegetables.* Cauliflowers: 1, 2, and 3. Mr. Hulbert; 4. Mr. Hitch; 5. Mr. Hulbert.

*Bristol Horticultural Society.* — The First public Exhibition of this newly-formed Society took place on June 25. It was most numerous and fashionably attended, and could not fail of affording a high treat to the lovers of horticulture.

On entering the show-room, the eye was struck with the rich variety of objects which presented themselves to view. In the centre of the platform, and proudly overtopping the rest, was a magnificent specimen of the *Pandanus odoratissimus*, supported by a splendid plant of the *Cactus speciosissimus* in full flower; the *Citrus sinensis*, or myrtle-leaved orange, loaded with fruit; the *Calceolària integrifolia*, covered with yellow blossoms; and the endless variety of the *Pelargonium* tribe. The fine specimens of double balsams, Russian stocks, and other tender annuals, attracted universal notice;

and the lately introduced hardy annuals, *Clárkia pulchélla*, with its profusion of purple flowers, and the *Petùnia nyctaginiflora*, covered with innumerable snow-white blossoms, will soon find their place in every garden, and add to the variety already cultivated.

The fruits and vegetables proved equally delicious to the taste, and pleasing to the eye. A fine specimen of the Rock Cantaloup Melon, from the garden of J. N. Franklyn, Esq., attracted particular notice, so early in the season, and to this was most deservedly awarded the first prize. Three fine specimens of grapes had prizes awarded to them for their great merit. The strawberries were universally admired; and a description of their enormous size would excite doubt, in the minds of those who did not inspect them, of the correctness of the statement.

Other prizes were awarded for fine specimens of flowers and culinary vegetables; among them was a vegetable possessing superior merit, called Aracacha, from South America, sent by Mr. Alderman Daniel, from the root of which a powder was obtained, of a farinaceous quality, and said to be highly nutritious.

*Plants.* Stove and Green-house: 1. *Calceolària integrifolia*, 2. *Cactus speciosissima*, and 3. *Amarýllis Johnsoni*, Mr. Maule. Herbaceous: 1. *Euphórbia stricta variegata*, Mr. Maule; 2. *Gèum coccineum*, Miss Bright, Ham Green; 3. *Cenothèra macrocarpa*, Mr. Maule. Hardy Shrubs: 1. *Cýtisis nigricans*, 2. A seedling *Rhododéndron*, à la *R. ròseum*, and 3. A seedling *Rhododéndron*, à la *R. catawbiense*, Mr. Maule, Stapleton Road. Seedling Geraniums: 1. *Pelargòonium Agrippinum*, and 2. *P. maculatum* var. *ròseum*, Mr. Young, Taunton. Heaths: 1. *Erica translucens*, Mr. Maule. — *Flowers.* Roses: 1. and 2. Mr. Lee, Lawrence Hill. Pinks: 1. Mr. Lee, Lawrence Hill; 2. Mr. C. H. Jessop, Cheltenham. — *Fruit.* Strawberries: 1. Wilmot's Superb, Ph. Protheroe, Esq., Cote House; 2. Keen's Seedling, Miss Bright, Ham Green; 3. A Seedling raised from Wilmot's Superb, Mr. S. Waring, Stoke Bishop. Grapes: 1. Black Ham-burgh, Mr. C. H. Jessop, Cheltenham; 2. Black Tripoli, Rd. Okeley, Esq., Pen Park; 3. White Muscat of Alexandria, J. W. Ricketts, Esq., St. Vincent's Lodge. Melons: 1. Rock Cantaloup (a very fine specimen), J. N. Franklyn, Esq., Clifton; 2. *Cito d'Olor* (from Carthagen), Mr. C. H. Jessop. — *Culinary Vegetables.* Potatoes: 1. Ash-leaf Kidney, Mr. Lee; 2. Shaw's Early, G. W. Hall, Esq., Sneed Park. Cucumbers: 1. Long Early Frame, White Spine, Mrs. H. Vaughan, Cote; 2. Long Prickly, J. W. Ricketts, Esq. Cauliflowers: Mr. Lee. Cabbages: 1. Early Emperor, Mr. Lee; 2. Pullin's Early Nonpareil, Mr. C. H. Jessop. Vegetables possessing superior merit: 1. The Aracacha of South America, T. Daniel, Esq., Henbury; 2. *Rhèum híbridum*, W. P. Taunton, Esq., Stoke Bishop.

Of ranunculuses, forced peaches, cherries, lettuces, pine-apples, and green peas, there were no specimens sent.

Censors: J. L. Knapp, Esq., S. Horsley, Esq., Mr. Mackay, Mr. Boys.

Mr. Miller of Durdham Down, the secretary, declined sending any specimens for prizes, being desirous of giving a fair scope to his friends. (*Gloucester Journal*, June 27.)

#### WORCESTERSHIRE.

*Worcester Horticultural and Floral Society.* — The Second Meeting of this Society for the present year was held on May 26., and was most numerous and respectfully attended by the ladies and gentlemen of the city and county. The exhibition of flowers, fruits, &c., was excellent, and gave universal satisfaction. The large stand was quite filled with the choicest specimens, presenting one uniform mass of bloom, and must have afforded a rich treat to the connoisseur and admirer of the floral tribe. There were nearly 500 tulips, and the number of specimens of all descriptions, entered

in the Society's books, amounted to more than at any previous exhibition. The Prizes were awarded as follows:—

*Plants.* Stove: 1. *Cactus speciosissima*, Mr. Smith; 2. *Strelitzia reginæ*, Mr. Fuller; 3. *Amaryllis*, J. Taylor, Esq. Green-house: 1. *Nerium* [? sp.], Sir A. Lechmere, Bart.; 2. *Alstrœmeria Pelegrina*, Mr. Fuller; 3. *Elichrysum sesamoides*, A. Skey, Esq.; 4. *Erica flôrida*, Mr. Smith. Hardy: 1. *Rôsa Bânksiæ lûtea*, E. Isaac, Esq.; 2. Mossy Rose de Meaux, Mr. Fuller; 3. *Daphne*, Mr. Mowbray. Stocks: 1. Scarlet Double Brompton Stock; and 2. White Double Brompton Stock, B. G. Kent, Esq. Geraniums: 1. *Germânicus*, Mr. Smith; 2. *Cleopâtra superba*, J. Taylor, Esq.; 3. *Spectâbile elegans*, Mr. Smith; 4. Seedling, Mr. Beech.—*Tulips* First Class: 1. Trafalgar, Mr. Smith; 2. Duc de Savoy, Mr. Smith; 3. Abercrombie, and 4. Catafalque, Mr. Harrison; 5. Trafalgar, Mr. Neale; 6. Gold Beares, Mr. Hickman. Second Class: 1. Videntra, Mr. Smith; 2. Dutch Catafalque, Mr. Smith; 3. Charbonniere, and 4. Bell's King, Mr. Hickman; 5. Earl St. Vincent, Mr. Smith; 6. Zan Zio, Mr. Hickman. Third Class: 1. Ambassador de Holland, 2. Washington, and 3. Pearson's Seedling, Mr. Smith; 4. Gadsby's Magnificent, and 5. Triomphe de Lisle, Mr. Fuller; 6. Maitre Partout, Mr. Smith. Fourth Class: 1. Cœur de Lion, Mr. Holmes; 2. Washington, Mr. Gummery; 3. Unknown, Mr. Smith; 4. Pretiosa, Mr. Fuller; 5. Roianne, Mr. Hickman; 6. Transparent Noya, Mr. Smith. Fifth Class: 1. Rose Beaupere, Mr. Fuller; 2. Rose Cerise Belle Forme, 3. Holden's Rose, and 4. Charles Fox, Mr. Smith. Sixth Class: 1. Rose Vesta, Mr. Gummery; 2. Rose Feu de Grand Valeur, and 3. Cramoese, Mr. Smith; 4. Walworth, Mr. Gummery; 5. Rose Triomphe Royal, Mr. Smith. Selfs: One Prize, Mine d'Or, Mr. Davis.—*Fruits.* Strawberries. Forced: Keen's Seedling, Mr. Linton. Oranges, English growth, A. Skey, Esq. Shaddock, A. Skey, Esq. Citron, J. Taylor, Esq.—*Culinary Vegetables.* Peas, J. Taylor, Esq. Potatoes, E. Isaac, Esq. Lettuce, Mr. Mowbray.

The following communication was received by the Secretary on Tuesday morning:—

“Sir, I take the opportunity of the meeting of the subscribers of the Society, and amateur florists, this day, to recommend to their notice the extraordinary increase of an insect of the coleopterous tribe, specimens of which I send herewith. This splendid green and gold beetle was rather a scarce insect in this neighbourhood till within the last three or four years. In fact, before this period, I have rarely observed more than, perhaps, a dozen in my garden in the course of a season. But it is now so much increased as to become a serious annoyance to the gardener and florist. The last three seasons, my lilacs, strawberry blossoms, and roses, particularly the Scotch and Chinese varieties, have greatly suffered from their depredations, and, unfortunately, they do not retire into the ground in the month of June, as is the case with the common chaffer beetle; they continue till August, devouring strawberries, raspberries, and cherries, though their favourite food, in the early part of the season, seems to be the stamina, anthers, and corolla of flowers, which are no sooner expanded than they are despoiled of their beauty. Thinking the warm dry summer and winter of the years 1826 and 1827 might have caused their sudden increase, I was in hopes the wet summer last year would have reduced their numbers. But this, I now fear, will not be the case; for, last week, I observed the first flowers of a seedling purple lilac were covered with them, and, in the course of an hour, every blossom devoured. As a matter of curiosity, I had them collected, and the specimens sent were all taken from this shrub. The mode I at present adopt to endeavour to lessen the number in my garden, is to pick them off the plants and flowers, and put them into a quart-bottle filled with water, where they soon perish. If any subscriber of our Society can give us information on the best means of reducing the stock of this destructive

insect, he will render an essential service to the cultivation of flowers and fruit. I am, Sir, your obedient servant,—*John Williams. Pitnaston, May 26. 1829.*”

In consequence of the above communication, the Society have resolved upon awarding a premium to any member of their body who shall point out the best method of destroying the above-described insect. Any communication of the above nature, or on any other subject connected with the Society, will be thankfully received by the Committee, and, at future Meetings, will be read at two o'clock. (*Worcester Herald, May 30.*)

The *Third Show* of the above Society was held in Worcester on June 17., when premiums were awarded as follows:—

*Plants.* Stove: 1. *Gloxinia* supérba, Mr. Wood; 2. *Amarýllis*, J. Taylor, Esq. Green-house: 1. *Cactus* speciòsa, Rev. T. Waters; 2. *Prostanthèra lasianthos*, and 3. *Erica* ventricòsa supérba, Mr. Smith; 4. *Lachenàlia formòsa*, Mr. Tapp. Hardy Annuals: 1. *Clárkia* pulchélla, Mr. Beach; 2. *Delphínium grandiflórum*, Mr. Smith. — *Flowers.* Ranunculuses. Dark and Dark Purple: 1. Viriat, Mr. Hickman; 2. Naxàra, Mr. Fuller; 3. Heureux, and 4. Santalìna, Mr. Smith. White Ground, Striped, Spotted, and Edged: 1. Princess Wurtemberg, Mr. Fuller; 2. Agreeable Unknown, Mr. Gummery; 3. Harpalyce, Mr. Hickman; 4. Suprèma, Rev. T. Waters. Yellow Ground, Striped, Spotted, and Edged: 1. Mélange des Beautés, Mr. Smith; 2. Albert, Rev. T. Waters; 3. Julius, Mr. Hickman; 4. David, Mr. Fuller. Orange: 1. and 2. Unknown, Rev. T. Waters; 3. Triumphant, Mr. Gummery; 4. Orange Boven, Mr. Smith. Yellow: 1. Model of Perfection, Mr. Smith; 2. Yùpi, Mr. Hickman; 3. Unknown, Mr. Holmes; 4. Miriam, Mr. Fuller. Scarlet: 1. Borsit, 2. Adonis, 3. Fernanda, and 4. Rosny, Mr. Smith. Crimson: 1. Unknown, 2. Alphonso, 3. Domingo, and 4. Zebulon, Rev. Mr. Waters. Light: 1. Orange Lion, Mr. Smith; 2. Laythea, Rev. T. Waters; 3. Orange Boven, Mr. Gummery; 4. Peronne la Pucelle, Mr. Smith. Pinks. Purple Laced: Humber's Regulator, J. Taylor, Esq. Red Laced: Beauty of Bath, Mr. Valencourt. Star: Davy's Eclipse, Mr. Hickman. Roses: 1. Rose d'Enfer, Mr. Smith; 2. Infernal, J. Taylor, Esq.; 3. Ròsa odoràta, Mr. Tapp; 4. Rose Unique, Mr. Fuller; 5. Mossa Basa, Mr. Beach; 6. Rose Provence, Mr. Hickman; 7. Unknown, Mr. Hunt; 8. Yellow Scotch, E. Isaac, Esq. — *Fruit.* Strawberries: 1. Keen's Seedling (for size), Mr. Wood; 2. Best Flavoured, Mr. Beach; 3. Taunton Black, Mr. Hunt. Grapes: 1. Black Frontignac, R. Nuttall, Esq.; 2. White Muscat of Alexandria, R. Nuttall, Esq. Melon, Sir H. Wakeman. Cherries: 1. Alton, Mr. Smith; 2. May Dukes, Mr. Hemming. — *Culinary Vegetables.* Cauliflower, Mr. Wood. Double Blossom Peas, Mr. Mowbray. Broad Beans, J. Taylor, Esq. (*Barrow's Worcester Journal, June 25.*)

*Vale of Evesham Horticultural Society.*—The Second Meeting of this Society was held at Evesham, on May 21., when upwards of four hundred specimens were placed on the stands; the major part of which were first-rate tulips, of great beauty, and the high perfection in which they were brought to the Show, did great credit to the growers. Many other very fine productions were exhibited (particularly geraniums), and a hundred of asparagus, grown by Mr. Anthony New, of Evesham, of the extraordinary weight of 9 lbs. Several new names were added to the list of subscribers. The next Show is fixed for Thursday, June 18. Prizes were awarded as under:—

*Plants.* Stove or Green-house, *Bouvàrdia* triphýlla, John Taylor, Esq. Hardy, Mr. Mayfield. Geraniums: 1. Unknown, J. Taylor, Esq.; 2. Unknown, Mr. Hartland. — *Tulips.* Feathered Bizards: 1. Trafalgar, Mr. Smith; 2. Unknown, Mr. Valencourt; 3. Sir Sidney Smith, Mr. Mayfield. Flamed Bizards: 1. Platoff, and 2. Charbonnier Noir, Mr. Raester; 3. Prince Potemkin, Mr. Smith. Feathered Bybloemen: 1. Ambassador de Holland,

Mr. Smith; 2. Triomphe de Flora, Mr. Wm. Murrell; 3. Seedling, Mr. Smith. Flamed Bybloemen: 1. Acapulco, Mr. Racster; 2. Washington, Mr. Smith; 3. Unknown, Mr. Mayfield. Feathered Rose: 1. Phoenix, Mr. Smith; 2. Rose Triomphe Royal, Mr. Hartland; 3. Dolittle, Mr. Davis. Flamed Rose: 1. Perle Brillante, Mr. Racster; 2. Unknown, Mr. Valencourt; 3. Ornament de Pouksen Rose, Mr. Racster. Selfs: 1. Koming von Pigue, Rev. Mr. Gretton; 2. Mine d'Or, Mr. Racster. *Anemones*. Dark and Light, Mr. Hunt. *Lettuce*, Mr. Cheek. (*Worcester Herald*, May 30.)

## HEREFORDSHIRE.

*Hereford Horticultural Society.* — The Second Exhibition for the present year took place on May 23., and it may safely be pronounced a most excellent display. The tulips were very numerous, generally well broken (or distinct in colouring), and many of them the produce of bulbs of considerable value. The anemones were not numerous, but good. The stove and green-house plants, including pelargoniums, were in fine flower, and uncommonly abundant; and, amongst the latter, "Paul Pry" intruded, but was completely superseded by others more recently raised, in point of colour and other essential qualities. The large stage was even crowded, and presented the appearance of a mass of bloom. The whole arrangement gave satisfaction to every subscriber of the Society anxious for its prosperity, and was witnessed by most of the rank and fashion of the city and county, the day being extremely fine. In comparing this exhibition with the Tulip Show of last season, we find that 150 productions were entered for competition on this occasion more than on that; indeed, the prize-stand was not sufficient to contain one half of them; which must have been evident to visitors, the pelargoniums and hardy plants being placed on the stationary side-forms of the room, which never had been the case on any previous occasion; and, on referring to the tickets of admission, there appeared a corresponding majority of visitors also, which, together with the additions of between twenty and thirty new subscribers of the present year, speaks for itself. Prizes were awarded as follows: —

*Plants.* Pelargoniums. Dark: 1. Daveyànum, Mrs. Gordon; 2. Decora, and 3. Zlùmü, Sir J. G. Cotterell. Light: 1. Macranthon, C. G. Cooke, Esq.; 2. Prince of Orange, Mr. Nott; 3. Fair Rosamond, Mr. Godsall. Heath: 1. *Erica mediterranea*, Sir J. G. Cotterell. Stove: *Cactus speciosa*, Mr. Godsall. Green-house: 1. *Epacris grandiflora*, T. H. Symons, Esq.; 2. *Calceolaria*, Mrs. Parkinson; 3. Unknown, Mrs. Gordon. Hardy: 1. *Daphne Cneorum*, Mrs. Gordon; 2. *Ulex europæus plèno*, Mr. Godsall; 3. *Tróllius europæus*, T. H. Symons, Esq. — *Flowers.* Tulips. Bizards: 1. Pompeius Magnus, and 2. Trafalgar, Mr. Cary Cocks; 3. Unknown, R. J. Powell, Esq.; 4. Captain White, Mr. Cary Cocks; 5. Aigle Noire, and 6. Madame Gyzelaar, R. J. Powell, Esq. Roses: 1. Cerise primo, Mr. Cranston; 2. Claudina, Mr. C. Cocks; 3. Rose Triomphante, R. J. Powell, Esq.; 4. Brillante, 5. Roi de Cerise, and 6. Rose Celeste, Mr. C. Cocks. Bybloemens: 1. Norwich Baguet, Mr. Cranston; 2. Imperatrice de Moroc, and 3. Globe Celeste, Mr. C. Cocks; 4. Washington, R. J. Powell, Esq.; 5. Charlotte, Mr. Cranston; 6. Conquest Vouray, R. J. Powell, Esq. Anemones: 1. Mr. C. Cocks; 2. and 3. Mr. Cranston; 4. Mr. C. Cocks. — *Fruit.* Gooseberries, Mr. Godsall. Strawberries, Sir J. G. Cotterell. *Culinary Vegetables.* Cabbages, R. J. Powell, Esq. Potatoes, R. J. Powell, Esq. Asparagus, Rev. Mr. Trumper. Cauliflowers, Sir J. G. Cotterell. (*Hereford Journal*, May 27.)

*Hereford Horticultural Show.* — On Friday, June 26., the Seventeenth Exhibition of this interesting Institution took place at the Shire Hall; and, although the ranunculuses have generally failed throughout the kingdom,

yet a few were exhibited; but the roses and pinks were splendid, and so numerous, that the Society's bottles were soon filled, and four dozen borrowed for the occasion: indeed, had the ranunculuses been as abundant as heretofore, 200 extra-bottles would have been insufficient. A superb plant of *Cactus speciosissima*, in full bloom, elicited general encomiums; and deservedly so, for it is the most beautiful of that tribe, and by no means a free-flowering one. Another splendid plant of this genus arrived too late for exhibition, the *Cactus flagelliformis*: it contained 100 blossoms. The summit of the pyramidal prize-stand displayed a fine plant of *Fuchsia gracilis*, 9 ft. high, containing about 700 blossoms, two thirds of which were fully expanded; the peculiar curve of its branches, disposed, as it were, in stories, and the pendent bell-shaped flowers, put us in mind of the pagoda of the East. Many beautiful specimens of full-blown dahlias were produced from Sir J. G. Cotterell's, the conduct of whose gardener is highly praiseworthy, for his liberal contribution of articles to decorate the room at each exhibition, particularly when we consider the distance he has to bring them; he does not merely exhibit two or three specimens, and expect, as a matter of course, a prize for each. The elegant new hardy annual, *Clarkia pulchella*, appeared in great abundance. The melons were very large and excellent, as were also the strawberries, among which a plate of seedlings of great promise, and a plate of Knevett's new pine, appeared. The cauliflowers were likewise of the finest description, and the cherries, French and common beans, and carrots also. Prizes were awarded as follows:—

*Plants.* Stove or Green-house: 1. *Cactus speciosissima*, Sir J. G. Cotterell; 2. *Fuchsia gracilis*, Mr. Godsall; 3. *Crassula versicolor*, C. G. Cooke, Esq. Hardy: 1. *Rhododendron roseum*, Sir J. G. Cotterell; 2. *Lonicera flexuosa*, Mr. Godsall. — *Flowers.* Ranunculuses: 1. R. J. Powell, Esq.; 2. and 3. Mr. Breeze. Pinks. Black and White: 1. Westlake's Heroine, Mrs. W. Pateshall; 2. Deacon's Baronet, Mr. Godsall; 3. Dry's Earl of Uxbridge, Mrs. Gordon. Purple Laced: 1. Knight's Lady Acland, Mrs. W. Pateshall; 2. Dry's Lord Exmouth, and 3. Unknown, Mr. Breeze. Red Laced: 1. Button's Caroline, 2. Salter's Imperial, and 3. Blush and Beauty, Mr. Breeze. Roses. Light: 1. Boursoult, Mr. Cranston; 2. Celestial, Mrs. Gordon; 3. Du Roi, Mr. Cranston; 4. Sir J. G. Cotterell; 5. Double Yellow, Mrs. J. Phillipps. Dark: 1. Pluto, Mrs. Gordon; 2. K. Evans, Esq.; 3. Mrs. J. Phillipps. — *Fruit.* Strawberries: 1. Wilmot's Superb, Mr. Nott; 2. Keen's Seedling, Mrs. H. Morgan; 3. Hautboy, J. S. Gowland, Esq.; 4. Carolina, Mr. Lee. Cherries: 1. Florence, R. J. Powell, Esq.; 2. Mrs. W. Pateshall; 3. Mrs. Gordon. Melons: 1. Pocket Melon, T. C. Bridges, Esq.; 2. White-seeded Rock, R. J. Powell, Esq. *Culinary Vegetables.* Cauliflowers: 1. R. J. Powell, Esq.; 2. Sir J. G. Cotterell. (*Hereford Journal*, July 1.)

*Ross Horticultural Society.* — The Twenty-second Exhibition of this Institution took place on May 27., when the usual attendance of the first families graced, certainly, the very best horticultural display we ever witnessed. The grand stand was covered with the very best bloomed geraniums, ericas, and other green-house plants, intermingled with various fine specimens of hardy plants, the centre showing the fine broad leaves of the rhubarb and the *Calla aethiopica*, both in fine bloom. The skilful arrangement of this stand produced an extraordinary mass of splendour and rich harmonious colouring, which powerfully reminded us of the best works of the immortal Rubens. The stage of tulips, notwithstanding the late hot weather, contained not less than 200 named varieties of this magnificent flower, and the sparkling, porcelain effect of the stage commanded great attention. The thirty prize-flowers were the best we ever saw in size, clearness, and rich transparency of colour; and the Ross florists certainly stand preeminent in this class. The anemones were small and indif-

ferent in quality, and we almost suspect that this beautiful flower excites but little interest with the florists at Ross. The prize geraniums exceeded all praise, and proved to us that the gardener of John Cooke, Esq., is one of the best growers and bloomers we know. The ericas and other house-plants were also singularly beautiful, and of great variety. The tables of vegetables, &c., were well filled, and the specimens fine. Mr. Miller of Bristol attended to receive instructions in the final establishment and management of the new Horticultural Society at Bristol, and from him we heard unqualified praise of this Show. It was notified by the honorary secretary that the London Horticultural Society's large silver medal for last year had been awarded to Mr. Hilton, Colonel Money's gardener, for the many valuable seedling, cider, and perry fruits grown by him, for his skilful mode of forcing grapes, and for the various fine specimens of fruit exhibited by him at the meetings of this Society. The number of specimens ticketed and entered in the Society's book amounted to 802, and the evening's sale of vegetables not removed to 14s. 1d. The prizes were awarded as under :—

*Plants.* Geraniums. Dark : 1. *Spectabile striatum*, 2. *Humei*, 3. *Ferònia*, 4. *Anna Boleyn*, and 5. *Daveyanum*, John Cooke, Esq. Light : 1. *Macranthon*, and 2. *Cucullata grandiflora*, John Cooke, Esq.; 3. *Prince of Orange*, and 4. *Ornatum*, Rev. T. Underwood; 5. *Apollo*, John Cooke, Esq. Heaths : 1. *Westfalingia*, John Cooke, Esq.; 2. *Perspicua nana*, and 3. *Vestita coccinea*, Mrs. Westfaling; 4. *Cylindrica*, Miss Trusted; 5. *Ventricosa carnea*, Mrs. Westfaling. Stove : 1. *Cactus speciosa*, Mr. Reynolds; 2. *Crassula coccinea*, and 3. *Hoya carnosa*, Mrs. Westfaling; 4. *Cactus flagelliformis*, Rev. R. K. Holder; 5. *Hibiscus sinensis indica*, Mrs. Westfaling. Green-house : 1. *Gorteria ringens*, and 2. *Elichrysium*, John Cooke, Esq.; 3. *Polýgala oppositifolia*, T. H. Symons, Esq.; 4. *Petunia nyctaginiflora*, W. Gillman, Esq.; 5. *Diósma rubra*, John Cooke, Esq. Hardy : 1. *Azalea odòrata álba*, Mr. Reynolds; 2. *Rhododéndron catawbiense*, Mrs. Westfaling; 3. *Kálmia latifolia*, 4. *Dodecátheon média*, and 5. *Azalea póntica*, Mr. Reynolds. — *Tulips.* Feathered Bizards : 1. *Pompe Funebre*, Mr. P. Baylis; 2. *General Murray*, and 3. *Captain White*, Mrs. C. Cocks; 4. *Gaude Beares*, Thomas Rudge, Esq.; 5. *Trianon*, Mrs. C. Cocks. Flamed Bizards : 1. *Pompeius Magnus*, W. Gillman, Esq.; 2. *Hopkins's Solus*, Colonel Money; 3. *La Lucar*, W. Gillman, Esq.; 4. *Catafalque*, J. F. Willis, Esq.; 5. *Le Ville de Paris*, Mrs. C. Cocks. Feathered Bybloemen : 1. *Imperatrice d' Maroc*, Mrs. C. Cocks; 2. *Washington*, T. Rudge, Esq.; 3. *Absalom*, Mr. Sharp; 4. *Prince Sovereign*, and 5. *Neat and Clean*, Mrs. C. Cocks. Flamed Bybloemen : 1. *Cerese Lelat*, Mrs. C. Cocks; 2. *Duchess of Wellington*, Colonel Money; 3. *Norwich Black Baguet*, W. Gillman, Esq.; 4. *Princess Charlotte*, G. Baldwin, Esq.; 5. *Diana*, Mrs. C. Cocks. Feathered Rose : 1. *Grand Valem*, 2. *Hebe Superfine*, 3. *Cramoise de Confrater*, 4. *Reine de Flesmes*, and 5. *Van Eeden*, Mrs. C. Cocks. Flamed Rose : 1. *Reine de Roses*, J. F. Willis, Esq.; 2. *Triomphe Blandina*, Mr. P. Baylis; 3. *Triomphe Royal*, T. Rudge, Esq.; 4. *Reine de Cerese*, Mr. P. Baylis; 5. *Triomphe de Lisle*, J. F. Willis, Esq. *Anemones.* Dark Double : 1. *Mrs. James Rudge*; 2. and 3. *J. F. Willis*, Esq.; 4. *Mrs. Westfaling*; 5. *Mrs. James Rudge*. Light Double : 1. *J. F. Willis*, Esq.; 2. *Mr. Reynolds*; 3., 4., and 5. *J. F. Willis*, Esq. — *Asparagus* : 1. *Mrs. Westfaling*; 2. *Colonel Money*; 3. *T. H. Symons*, Esq.; 4. *Mrs. Westfaling*; 5. *Colonel Money.* (*Hereford Journal*, June 5.)

The *Twenty-third public Exhibition* took place on June 24. We have for five years reported this Exhibition, but words now fail us to do it common justice; and it only remains for us to say, in number and quality it exceeded any we have before witnessed; and we are assured no Society, whether as downright gardeners or fanciers, can beat the Ross horticulturists. The grand stand was nobly filled, and most tastefully arranged, with a profusion

of valuables; and the group in its centre, backed by an extraordinary-sized *Spiræa ulmària*, delphiniums and campanulas could not, we think, be surpassed in brilliancy and effect. The long stage sparkled, meteor-like, with innumerable-named roses, pinks, ranunculuses, and, to us, Nature's beauty, the double dahlia (although not in quantity), much aided the splendour of this portion of the exhibition. The table for strawberries and cherries was most abundantly covered; and we heard a lady pronounce the strawberries *young lobsters*: several plates of Wilmott's Superb having the specimens exceeding an ounce in weight, and many plates of Keen's Seedling took less than twenty to the pound. The table for vegetables was well filled, and some heads of cauliflower were 12 in. in diameter. The number of specimens ticketed and entered amounted to 1151, much exceeding any previous Show. The prizes were adjudged as under:—

*Plants.* Stove or Green-house: 1. *Cactus speciosissima*, Mr. J. D. Wheeler; 2. *Célsia incisifolia*, and 3. *Calceolària rugosa*, J. Cooke, Esq.; 4. *Polýgala latifolia*, Mr. J. C. Wheeler; 5. *Acàcia arborea*, Mrs. Partridge. Heaths: 1. *Ventricosa superba*, Mrs. Westfaling; 2. *Prégnans*, Mr. J. D. Wheeler; 3. *Ventricosa densa*, Mrs. Westfaling; 4. *Triflora*, Mr. J. D. Wheeler; 5. *Dépressa*, Mr. J. C. Wheeler. Hardy: 1. *Spiræa ulmària*, E. Prichard, Esq.; 2. *Kálmia latifolia*, Mr. Reynolds; 3. *Dictámnus flore rubro*, Mr. Purchas; 4. *Delphinium grandiflora*, Mr. Reynolds; 5. *Cámpanula persicifolia*, Mrs. Platt.—*Flowers.* Ranunculuses. Dark: 1. Vortonox, Mrs. Westfaling; 2. Vulcan, Mr. Crump; 3. Vincent's Admiral, Mrs. Westfaling; 4. Capel, Mr. Crump; 5. Leo, Mr. T. Edwards. Light: 1. Eliza, 2. Pompelia, and 3. Duchess of Wurtemberg, Mr. Crump; 4. Adrian Citron, and 5. Borsit, Mrs. Westfaling. Pinks. Black and White: 1. Westlake's Heroine, Mr. T. Edwards; 2. Symonds' Eclipse, Colonel Money; 3. Burches's Maid of Kent, Miss Trusted; 4. Beauty of Wolverhampton, Mr. T. Edwards; 5. Davy's Eclipse, Mr. Reynolds. Purple Laced: 1. Buf-faloe's Beauty, Miss Trusted; 2. Oxonian, J. Cooke, Esq.; 3. Earl of Uxbridge, Mr. T. Edwards; 4. Hopkins's Bishop of Winchester, Mr. Reynolds; 5. Haslem's Ruler, Mr. T. Edwards. Red Laced: 1. Cooper's Cupid, Miss Trusted; 2. Stephens's Waterloo, and 3. Ratter's Seedling, Messrs. Breese and Reynolds; 4. Glory of Newport, J. Cooke, Esq.; 5. Salter's Imperial, Mr. Reynolds. Selfs and Fancies: 1. Blushing Beauty, Mr. Barrett; 2. George the Fourth, Colonel Money; 3. Aurora Borealis, J. Cooke, Esq.; 4. Unknown, J. F. Willis, Esq.; 5. Duchess of Albemarle, Mr. Reynolds. Roses. Dark 1. Tuscany, K. Evans, Esq.; 2. Pluto, J. Cooke, Esq.; 3. Royal Purple, Col. Money; 4. Royal Crimson, K. Evans, Esq.; 5. Africana, Mr. T. Edwards. Light: 1. Moss Provens, E. Prichard Esq.; 2. Celeste, Mr. J. C. Wheeler; 3. Unique, K. Evans, Esq. 4. New Maiden's Blush, E. Prichard, Esq.; 5. Bengalense, K. Evans, Esq.—*Fruit.* Cherries: 1. Early May, Mrs. Westfaling; 2. Dredge's Early, Mr. Barrett; 3. May Duke, R. Compton, Esq.; 4. Elton, J. F. Willis, Esq.; 5. Amber, Mr. Sharp. Strawberries: 1. Wilmott's Superb, and 2. Keen's Seedling, J. Cooke, Esq.; 3. Carolina, Col. Money; 4. Roseberry, Mrs. Westfaling; 5. Alpines, Colonel Money.—*Culinary Vegetables.* Cauliflowers: 1. J. Cooke, Esq.; 2. Mr. Reynolds; 3. Mrs. Westfaling; 4. Mr. Reynolds; 5. Colonel Money. (*Hereford Journal*, July 1.)

#### YORKSHIRE.

*Yorkshire Horticultural Society.*—On June 5., the Yorkshire Horticultural Society held their June Meeting in Wakefield. From the unfavourable state of the weather for several weeks past, it was not expected that the display of fruits and flowers would be so choice as might otherwise have been looked for. On entering the room, however, the visitors were most agreeably disappointed; indeed, we have seldom seen a more splendid



exhibition of the riches of Flora. At the top of the room, where the platform for the council was placed, there were three most beautiful bouquets of a large size; and over the president's chair was an arch, entirely composed of flowers of the most brilliant hues. The tables were covered with a profusion of hardy and exotic plants in full beauty, with pines, grapes, nectarines, peaches, and early and choice culinary vegetables, in great quantities, several of the latter being new sorts, the cultivation and introduction of which may be attributed to this Society, and afford a satisfactory proof of its utility. The company was numerous, and consisted of most of the families of the town and vicinity, with others from a distance. Prizes were awarded as follows:—

*Plants.* Rarest Exotic, *Thunbergia alata*, Mr. Menzies, gardener to C. Rawson, Esq., Halifax. Exotic Bouquet, Mr. Appleby. Hardy Bouquet: 1. Mr. Menzies; 2. Mr. Senior, gardener to F. Maude, Esq., Hatfield Hall. Best Collection of Green-house Plants, Mr. Senior. Best Green-house Plant. *Calceolària purpurea*: 1. Mr. Menzies; 2. Mr. Senior. Geraniums: 1. and 2. Mr. Marshall. The finest plant of this species, in the room, was one belonging to Mr. Ashton. This had been misplaced till after the judges had decided; but when it was brought forward, the council adjudged an extra-prize to Mr. Ashton for it. Seedling, *Pelargonium Rawsonianum*, Mr. Menzies. Heath, Mr. Senior. Best collection of Heaths, Mr. Senior. Hardy Plant: 1. and 2. *Mimulus muscoides*, Mr. Senior. *Gèum coccineum*, Mr. Senior. A beautiful specimen of *Phlox canadensis* was exhibited by Mr. Menzies, but only two prizes could be given in this class. Balsam, Mr. Ashton. — *Flowers.* Tulips. Feathered Bizards: 1. and 2. Mr. James Drakes; 5. B. Eli. Feathered Bybloemens: 1. Mr. Drake; 2. Jonathan Jackson; 5. William Clarke. Flamed Bybloemens: 1. Jonathan Jackson; 2. Mr. Drake; 5. W. Clarke. Flamed Bizards: 1, 2, and 5. Wm. Clarke. Feathered Roses: 1. Wm. Woodhead; 2. Jon. Jackson; 5. Joseph Marshall. Flamed Roses: 1. and 2. Jonathan Jackson; 5. Mr. Drake. Selfs: 1. Wm. Clarke; 2. and 5. Mr. Drake. Breeders: 1, 2, and 5. Benjamin Eli. — *Fruit.* Pine: 1. Mr. Ashton, gardener to B. Gaskell, Esq., of Thornes House; 2. Mr. Boothroyd, gardener to R. K. Dawson, Esq., Frickley Hall. Grapes. White: 1. Mr. Plant, gardener to J. Hardy, Esq., Heath; 2. Mr. Appleby, gardener to the Rev. J. A. Rhodes. Black: 1. Mr. Moore, gardener to T. B. Pease, Esq.; 2. Mr. Ashton. Cherries, Peaches, and Nectarines, Mr. Ashton. Strawberries, Mr. Appleby. Apples, Mr. Padget, gardener to W. F. Payley, Esq., Squire Pastures. — *Culinary Vegetables.* Rhubarb, Mr. Hinshey, Henshall, near Snaith. This was a new kind, and of large size. Asparagus, Mr. Campbell, gardener to H. Teale, Esq., Stourton Lodge. Mushrooms, Mr. Ashton. Cabbages, Mr. Campbell. Broccoli: White, Mr. John Marshall, Bell Hill; Purple, Mr. Palfreyman, Potter Newton. Cabbage Kale, Mr. Palfreyman, Potter Newton. This was a very fine specimen of a new vegetable, which promises to be a valuable addition to our culinary plants. Lettuce, Mr. Smith, gardener to A. Peterson, Esq., Wakefield. This prize was much admired. Potatoes, Mr. Boothroyd. Cucumbers, Mr. Marshall.

Judges for Fruit and Vegetables, Thomas White, Esq., Mr. Charles Carver, and Mr. John Crament; for Flowers, Mr. Stead, Mr. Jamieson, and Mr. Wm. Barratt; for Tulips, Mr. William Riley, Mr. John Calton, and Mr. Richard Marshall.

Several ladies and gentlemen contributed to the decoration of the room, which was beautifully arranged under the direction of Mr. Wm. Barratt. Amongst the plants we noticed a superb *Arum nigrum*, from the garden of A. Peterson, Esq.; a *Pæonia Moutan*, from that of F. Maude, Esq.; and a *Cactus speciosissima*, from that of C. Rawson, Esq. (*Yorkshire Gazette*, June 6.)

The York Florists' Society held their Annual Show of Tulips and Geraniums on May 26., in Petergate. The prizes were adjudged as follows : —

*Tulips.* Feathered Roses : 1. Rose Triomphe Royal, Mr. Parker ; 2. Hero of the Nile, Mr. W. Hardman ; 3. Compté de Vergennes, and 4. Number Seven, Mr. Parker ; 5. Doolittle, Mr. W. Hardman. Feathered Bybloemen : 1. Black Baguet, Mr. W. Hardman ; 2. Norfolk Baguet, Mr. Rippon ; 3. Violet Grand Turc, Mr. W. Hardman ; 4. Washington, Mr. Parker ; 5. Black Baguet, Mr. Parker. Feathered Bizards : 1. Trebisonde, Mr. Rippon ; 2. Duc de Savoy, Mr. W. Hardman ; 3. Ardington's Rainbow, Mr. Wilson ; 4. Surpasse Catafalque, and 5. Maitre Partout, Mr. W. Hardman. Flamed Roses : 1. Cerise Primo, and 2. Triomphe Royal, Mr. Parker ; 3. Triomphe Royal, Mr. W. Hardman ; 4. Cerise Primo, Mr. Summers ; 5. Number Eleven, Mr. Parker. Flamed Bybloemen : 1. Incom. Pomona, Mr. Wm. Hardman ; 2. Bienfait, Mr. Summers ; 3. Incom. Voorhelm, Mr. Cooper ; 4. Tour de Salisbury, and 5. Bienfait, Mr. W. Hardman. Flamed Bizards : 1. Wolstenholme's Seedling, Mr. Wilson ; 2. Bizard Incomparable, Mr. Parker ; 3. Number Thirty-nine, 4. Number Nineteen, and 5. Incomparable Primus, Mr. W. Hardman. Selfs and Unbroken : 1. White Flag, Mr. Parker ; 2. Roi de Mine d'Or, Mr. Summer ; 3. Number Eighty-nine, and 4. Number Ninety-nine, Mr. W. Hardman ; 5. Roi de Mine d'Or, Mr. Bean. — *Geraniums.* Scarlet and Dark Grounds : 1. Daveyànum, Mr. Rigg ; 2. Emperor Nicholas, and 3. Defiance, Mr. Parker. Violet and Light Grounds : 1. Husseyànum, Mr. Bean ; 2. Beauté Suprême, Mr. Parker ; 3. Countess, Mr. Rigg. White Grounds : 1. Macranthon, Mr. Parker ; 2. Coronation, Mr. Rigg ; 3. Macranthon, Mr. Bean.

At the first Show of the season, held a few weeks ago, Mr. W. Hardman was presented with a piece of plate, he having won the greatest number of first prizes during the year 1828. Mr. A. Parker was presented with another piece of plate, he being the greatest winner of first prizes with geraniums, roses, and bouquets, during the same year. (*Yorkshire Gazette*, May 30.)

*Wakefield Florists' Society.* — This Society held their Annual Show of Tulips on June 1., which was very numerously and respectably attended. The Show was most excellent, and appeared to give general satisfaction. Prizes were adjudged as follows : —

Feathered Bizards : 1. Sir Sydney Smith, Mr. Shillito ; 2. Gigantum, Mr. Blackburn ; 3. Duc de Savoy, Mr. Shillito ; 4. Gold Mont, Mr. Gill ; 5. Trafalgar, Mr. Shillito ; 6. Leopoldina, Mr. Blackburn. Feathered Bybloemens : 1. Gloria Mundi, Mr. Shillito ; 2. Washington, Mr. Stephenson ; 3. Bienfait Incomparable, Mr. Drake ; 4. Cupido, Mr. Hardman ; 5. Bienfait, Mr. Poynton ; 6. Light Baguet, Mr. Hardman. Feathered Roses : 1. Doolittle, Mr. Shillito ; 2. Neat and Clean, Mr. Stephenson ; 3. Rose Lilby, Mr. Blackburn ; 4. Rose Beaurepere, Mr. Drake ; 5. Violet Quarto, Mr. Blackburn ; 6. Gray Stella, Mr. Poynton. Flamed Bizards : 1. Bell's King, Mr. Shillito ; 2. Princess, and 3. Chat de Crickles, Mr. Gill ; 4. Magnifique, Mr. Blackburn ; 5. Surpasse la Cantique, Mr. Gill ; 6. Surpasse Catafalque, Mr. Poynton. Flamed Bybloemens : 1. Dunstan, Mr. Stephenson ; 2. Black Baguet, Mr. Blackburn ; 3. Seedling, Mr. Poynton ; 4. Woade's King, Mr. Newsome ; 5. Unknown, Mr. Hardman ; 6. Washington, Mr. Shillito. Flamed Roses : 1. Favourite Rose, Mr. Gill ; 2. Triomphe Royal, Mr. Drake ; 3. Cerise Liffe, Mr. Hardman ; 4. Rose Unique, Mr. Poynton ; 5. Unknown, Mr. Blackburn ; 6. Duc de Bronte, Mr. Poynton. Selfs : 1. Mine d'Or, Mr. Gill ; 2. Mountain of Snow, Mr. Blackburn ; 3. Unknown, Mr. Stephenson ; 4. Mirabella, and 5. Unknown, Mr. Blackburn ; 6. Queen of Sultana, Mr. Shillito. Breeders : 1. and 2. Mr. Blackburn ; 3. Mr. Newsome. Double : 1. Yellow, Mr. Hardman ; 2. Striped, Mr. Blackburn ; 3. Red, Mr. Hardman. (*Wakefield and Halifax Journal*, June 5.)

## NORTHUMBERLAND AND DURHAM.

*Botanical and Horticultural Society of Durham, Northumberland, and Newcastle upon Tyne.* — At a General Meeting of this Society, held at Newcastle, on June 5., the following prizes were awarded : —

For the best dish of grapes, of sorts named, the gold medal to Mr. Joseph Clarke, gardener to Mrs. Bewicke, Close House. For the best half peck of potatoes, from the open ground, the silver medal to Mr. John Gledston, gardener to Wm. Orde, Esq., Nunnykirk. For the best half peck of peas in pod, to Mr. James Scott, gardener to Edward Charlton, Esq., Sandoe. For the best bybloemen tulip, named (Incomparable Panachée), to Mr. Matthew Bates, Kenton. For the best rose and white tulip, named (Reine des Roses), to Mr. James Scott, gardener at Sandoe. For the best bizard tulip, named (Surpasse la Cantique), to Mr. Adam Hogg, at Messrs. Falla and Co's, Gateshead. For the best seedling geranium, to Mr. Christopher Robson, gardener at Dr. Headlam's, Jesmond, named (Isabella). For the best three double-scarlet Brompton stocks, to Mr. Harrop, Sunderland. For the best exotic plant in flower (*Agapanthus umbellatus*), to Mr. Wm. Kelly, gardener to A. Donkin, Esq., Jesmond. For the best bouquet of flowers, to Mr. Adam Hogg, at Messrs. Falla and Co's, Gateshead. An extra-prize, viz. a bronze medal, was awarded by the judges to Mr. James Scott, for a very fine bizard tulip (Mentor).

The exhibition was one of the finest that has been held by the Society, and attracted a very large concourse of subscribers and their friends, who were evidently highly gratified.

The *Hexham Meeting* of the same Society was held on June 9., when the prizes were awarded as follows : —

For the best dish of grapes, of sorts named, the gold medal to Mr. Wm. Grey, gardener to Thomas James, Esq., Beaufront. For the best half peck of potatoes, from the open ground, the silver medal; and for the best half peck of peas, the silver medal, to Mr. Thomas Watson, gardener at James Kirsopp's, Esq., Spital. For the best bybloemen tulip, named (Monsieur Pitt), to Mr. T. Grey, gardener, Humshaugh. For the best cherry-coloured and white tulip, named (Rose Unique), to Mr. Thomas Cook, gardener to T. W. Beaumont, Esq., Bradley Hall. For the best bizard tulip, named (La Cantique), to Mr. James Scott, gardener to Edward Charlton, Esq., Sandoe. For the best seedling geranium, to Mr. Clarke, gardener to Mrs. Bewicke, Close House. For the best three double-scarlet Brompton stocks, and for the best bouquet of flowers, to Mr. James Scott, gardener, Sandoe. For the best exotic plant in flower, *Echium fastuosum*, to Mr. James Charlton, gardener to Stamp Brooksbank, Esq., Hermitage, near Hexham.

The Meeting was most respectably and numerously attended; and the exhibition, which was most beautiful, evidently gave great pleasure to those who honoured it with their presence. (*Newcastle Courant*, June 15.)

At a *General Meeting* of the above Society, held at Newcastle, on July 3., the following prizes were awarded : —

For the best-flavoured Pine-apple, the gold medal; and for the best melon (George the Fourth's Favourite), the gold medal, to Mr. John Gledston, gardener to William Orde, Esq., Nunnykirk. Dish of Grapes, the silver medal to Mr. William Lawson, gardener to Matthew Bell, Esq., Woolsington. Dish of Strawberries, Bouquet of Chinese Roses, and Bouquet of Flowers, a silver medal, to Mr. Thomas Cooke, gardener at T. W. Beaumont's, Esq., Bywell Hall. Dish of Cherries, the silver medal to Mr. T. Watson, gardener to James Kirsopp, Esq., Spital, near Hexham. Double Ranunculus, named : 1. The Mulatto Maid, the silver medal to Mr. Matthew Bates, Kenton; 2. Beauté fine, the bronze medal to Mr. Harrop, Sunderland. Twelve double Roses, the silver medal to Mr. James Scott, gardener to Edward Charlton, Esq., Sandoe. Double Pink, named : 1. Davey's Lord Wellington, the silver medal to Mr. John Wilson, Newcastle; 2. Archduke Charles, the

bronze medal to Mr. Thomas Grey of Humshaugh. Best Exotic Plant in Flower (*Erythrina crista galli*), the silver medal to James G. Clarke, Esq., Fenham. (*Newcastle Courant*, July 11.)

*The Botanical and Horticultural Society of Hexham.* — This Society held a Meeting at Mrs. Wilson's, Bush Inn, on June 3., for the exhibition of tulips and stocks, when the prizes were awarded as follows : —

*Tulips.* White Ground : 1. Brown Diana, Mr. Robert Charlton, gardener, Wall ; 2. Incomparable Amazon, and 3. Rose Triomphe Royal, Mr. James Scott, gardener to Edward Charlton, Esq., Sandoe ; 4. Mr. Pitt, Mr. Joseph Robson, Hexham ; 5. Reine des Amazons, Mr. Robert Charlton, gardener, Wall. Yellow Ground : 1. Maddox's Yellow, 2. Aquavera, and 3. Grotes, Mr. Robert Charlton, gardener, Wall ; 4. La Belle Financier, Mr. Robert Grey, gardener, Humshaugh ; 5. Gloria Mundi, Mr. Robert Charlton, gardener, Wall. — *Stocks.* Best six : Mr. James Scott, Sandoe. (*Ibid.*)

*Gateshead Florists' Society.* — This Society held their Annual Show of Tulips on June 1., when prizes were awarded as follows : —

1. Incomparable O, John Pearson ; 2. Triomphe de Lisle, and 3. Archduchess, William Joyce ; 4. Rose Triomphe Royal, John Ford ; 5. King George the Fourth, Oswald Robson. (*Ibid.*, June 15.)

*Stamfordham Florists' Society.* — This Society held their Annual Show of Tulips on June 1., when the prizes were adjudged as follows : —

*Tulips.* White : 1. Hofban-Manicha, and 2. Bienfait, Mr. E. Johnson ; 3. Rose Torschia, and 4. Beauty Virginal, Mr. George Hedley ; 5. Overwiner, Mr. Joseph Charlton. Yellow : 1. Maddocks, 2. Grace, and 3. Honeycomb, Mr. G. Surtees ; 4. Black Prince, Mr. Joseph Charlton ; 5. Bell's King, Mr. Henry Weightman. (*Ibid.*)

*Morpeth Florists' Society.* — This Society held their Tulip Show on June 4., at Mr. M'Lellan's. Prizes were awarded as follows : —

*Tulips.* Rose-coloured : 1. Noble Blanche, Mr. John Dixon ; 2. Cerise Triomphant, Mr. M'Lellan ; 3. Rose Triomphe Royal, Mr. Hindhaugh ; 4. Rose Primo, Mr. Lewins ; 5. Rose Hebe, Mr. Hindhaugh. Violet-coloured : 1. Triomphe de Lisle, and 2. La Pucelle, Mr. Hindhaugh ; 3. Constant, and 4. Triomphe d'Europe, Mr. M'Lellan ; 5. Grand Alexandre, Mr. Lewins. Yellow : 1. Catafalque, and 2. General Bolivar, Mr. Hindhaugh ; 3. Goudbeures, Mr. John Dixon ; 4. Grandeur du Monde, Mr. Hindhaugh ; 5. Grandeur Magnifique, Mr. Edward Noble. (*Ibid.*)

*The Independent Society of Florists at Heworth.* — The Annual Meeting for the Show of Tulips was held on June 6., when a very great variety of that elegant flower was exhibited, and the prizes adjudged as follows : —

1. Ceres de Grande, Mr. Thomas Dixon ; 2. Lord Nelson, Mr. George Stephenson ; 3. Violet Kess Cubal, and 4. Triomphe Royal, Mr. Andrew Bouglas ; 5. Gay Stella, Mr. George Stephenson.

After which, the evening was spent in the utmost harmony and conviviality. (*Ibid.*)

*Bedlington Florists' Society.* — This Society held their Annual Show of Tulips on June 1., at the house of Mr. John Morrison, when the following prizes were awarded : —

*Tulips.* White : 1. Absalom, 2. Rose Triomphe Royal, 3. Caroline, and 4. Doolittle, Mr. John Cotes ; 5. Rose Favourite Superior, Mr. John Graham. Yellow : 1. Maddox's Yellow, Mr. John Cotes ; 2. Glory of Holland, Mr. John Johnson ; 3. Castrum Doloris, Mr. Robert Hay ; 4. King of Prussia, Mr. Henry Langlands ; 5. Duke of Bedford, Mr. Robert Hay. (*Ibid.*)

*The Union Florists of Bishopwearmouth and its Vicinity* held their Annual Show of Tulips on June 8., when the prizes were adjudged as follow : —

1. Rose Triumph Royal, Mr. John Harrop ; 2. General Loftus, Mr. Matthew Patton ; 3. Washington, Mr. Thomas Hull ; 4. Belle Actrice, Mr. John Harrop ; 5. Demetrius, Mr. Sutton. (*Ibid.*)

The *above Society* held their Annual Show of Ranunculuses on June 29., when the prizes were adjudged as follows:—

1. *Mélange des Beautés*, Mr. John Harrop; 2. *Orestes*, Mr. G. Archbold; 3. *Prince of Wurtemberg*, Mr. Thomas Hull; 4. *Prince Frederic*, Mr. Sutton; 5. *Fair Phillis*, Mr. G. Archbold. (*Newcastle Courant*, July 11.)

The *Union Florists of Sunderland* held a Sweepstake Show of Ranunculuses on June 7., when Mr. Thomas Hull gained the prize with *Orestes*. There was exhibited, from the garden of Mr. Thomas Moody, a most handsome cabbage, of the early York kind, which weighed 6 lb. 1 oz.; a cauliflower, from the garden of Mr. G. Patterson, weighing 4 lb. 2 oz.; and a most beautiful display of roses, from the garden of Mr. Matthew Patton. (*Ibid.*)

#### LANCASHIRE.

*Manchester Floral and Horticultural Society.*—The Second Exhibition, this year, of the Floral and Horticultural Society, took place on May 29., in the News-room of the Exchange. Large as this is, it was, however, found much too small for the numerous company who resorted to it during the whole of yesterday afternoon; the condition upon which the room was lent being, that every member should have free admission for himself and family. The arrangements evinced great taste; and the whole of the beautiful specimens of “spring’s early promise,” as well as the precocious productions of the hot-house, were displayed to the best advantage, and in the most effective style. The green-house, stove, and hot-house plants formed an oval in the centre of the room. On the right, as you entered the large door, were placed on tables, extending from pillar, fruits and vegetables. On the left, in a similar manner, were placed tulips, arranged in their different orders. The herbaceous plants were situated at the right hand of the lower end of the room, and the hardy plants on the left. This being what is termed the tulip show, they of course formed the principal feature in the exhibition; we cannot say, however beautiful some of the grapes were, that, taken as a whole, they were equal to those of last year. The hot-house and stove plants were the chief attraction in the room. The great advantage and convenience of the arrangements consisted in the facility afforded to the company of seeing every thing, by a way being open on both sides of the table. The Manchester band were in attendance, and played at short intervals during the whole of the day. At the conclusion of the exhibition, the stewards dined together at Mr. Lawler’s, the Dog and Partridge. The following is a list of the prizes:—

*Plants.* Stove: Two best, *Cactus speciosissima* and *Ardisia colorata*, a silver cup, Mrs. Hobson. Best, *Gloriosa superba*, Richard Potter, Esq. Green-house, *Grevillia acanthifolia*, the Rev. J. Clowes. Herbaceous, the Rev. W. Clowes. *Erica*, Mrs. Hobson. Geranium, *Feronia*, W. Garnett, Esq. Hardy Shrub, C. Wood, Esq. Basket of Flowers, R. Potter, Esq.—*Tulips.* Pan of six: 1. (the silver cup), William Turner, Esq.; 2. W. Leighton, Esq. Feathered Bizards, Mr. Winstanley. Flamed Bizard, Mr. Bow. Feathered Bybloemen, Mr. Falkner. Flamed Bybloemen, James Hardman. Feathered Rose, W. Turner, Esq. Flamed Rose, James Walker, Esq.—*Fruit.* Pine, P. Marsland. Grapes, R. Potter, Esq. Peaches, the Earl of Wilton.—*Culinary Vegetables.* Cucumber, C. J. S. Walker, Esq. Asparagus and Mushroom, F. Bayley, Esq. Peas, T. J. Trafford, Esq. Cauliflower, C. J. S. Walbe, Esq. Rhubarb, E. J. Lloyd, Esq. Lettuce, R. W. Barton, Esq. Cabbage, F. Bayley, Esq. (*Manchester Advertiser.*)

The *Third Meeting* of this Society, for the exhibition of pinks, ranunculuses, roses, stove, green-house, and herbaceous plants, fruits, vegetables, &c., was held on June 26. The display of pinks and ranunculuses was as

fine as any we ever witnessed ; the only defect apparent in the roses was that of their being too fully blown. The fruit and vegetable tables were never seen to greater advantage. The strawberries, which were of enormous size, excited particular attention ; and the other fruits were of superior growth. Amongst the vegetables we observed a cucumber, grown by Chas. Walker, Esq., which was  $26\frac{3}{4}$  in. in length ; it is to be sent as a present to Mr. Coke of Norfolk, the celebrated agriculturist. There were other vegetable productions equally entitled to admiration. The prizes were awarded as follows :

*Plants.* Stove : 1. Mrs. Hobson of Hope ; 2. Mr. Charles Wood. Greenhouse : 1. and 2. R. W. Barton, Esq. Herbaceous : 1. Mr. Charles Moore ; 2. Mr. Edward Leeds. *Ericæ* : 1. and 2. Thomas Heywood, Esq. Geranium : 1. James Ramsbotham, Esq. ; 2. Richard Potter, Esq. Hardy shrub : 1. and 2. Mr. Charles Wood.— *Flowers.* Roses Single Red Moss : 1. Mr. Moore ; 2. Mr. J. Faulkner. Red and Blush : 1. Mr. J. Hamnett ; 2. Mr. E. Deane. White Moss : 1. Mr. J. Smith ; 2. R. W. Barton, Esq. Red Moss : 1. Mr. H. Bent ; 2. Mr. T. Marvin. Marbled : 1. Mr. E. Deane ; 2. Mr. Charles Wood. Crimson : 1. Mr. J. Hodgson ; 2. Mr. C. Moore. Tuscany (new class) : 1. Mr. C. Moore ; 2. Mr. J. Smith. Purple (new class) : 1. and 2. Mr. J. Faulkner. Dark Red (new class) : 1. Thos. Boothman, Esq. ; 2. Mr. C. Moore. White : 1. and 2. Mr. C. Moore. Ranunculuses. Striped : 1. and 2. Mr. Thomas Marvin. Dark Self-colour : 1. Wm. Leighton, Esq. ; 2. Mr. J. Faulkner. Purple-edged : 1. Wm. Leighton, Esq. ; 2. Mr. Joseph Clegg. Light Self-colour : 1. Mr. J. Faulkner ; 2. Mr. T. H. Hadfield. White-edged : 1. and 2. Mr. J. Faulkner. Yellow-edged Spotted : 1. Mr. Thomas Walker ; 2. Wm. Leighton, Esq. Pinks. Purple-leaved : 1. Mr. Joseph Clegg ; 2. Mr. Scrang. Black and White : 1. and 2. Mr. Joseph Clegg. Dahlias. Double : 1. and 2. Thomas Knight, Esq. Single : 1. Mr. T. Marvin ; 2. Richard Potter, Esq., of Smedley. Pan of Anemones, Mr. Whitworth of Rochdale. Basket of Flowers : 1. Mr. J. Faulkner ; 2. Richard Potter, Esq. An extra-prize was awarded to Mr. Taylor, for the best specimen of Ten-weeks' Stock.— *Fruits.* Peaches : 1. R. J. Norreys, Esq. ; 2. Earl Wilton. Strawberries. Best dish : 1. Mr. J. Alcock ; 2. Charles Walker, Esq. An extra-prize was awarded to F. Bayley, Esq., for white strawberries. Gooseberries : 1. and 2. Mr. Peter Deane. Pine : 1. and 2. T. Mottram, Esq. Cherries : 1. Mr. Thomas Hamnett ; 2. Name unknown. Nectarines, R. J. Norreys, Esq. Red Currants : 1. Mr. T. H. Hadfield ; 2. Mr. F. Bayley. Grapes. Best dish, T. Mottram, Esq. In Pots, Richard Potter, Esq.— *Culinary Vegetables.* Cauliflowers : 1. Mr. C. Walker ; 2. T. J. Trafford, Esq. Peas : 1. Mr. F. Bayley ; 2. R. W. Barton, Esq. Carrots, F. Bayley, Esq. Cucumbers : 1. Mr. C. Walker ; 2. Lionel Lloyd, Esq. French beans, T. J. Trafford, Esq. Asparagus, R. W. Barton, Esq. Lettuce : 1. L. Lloyd, Esq. ; 2. John Thackeray, Esq. Celery, L. Lloyd, Esq. Onions and Turnips, Mr. C. Walker. Extra-prizes were given to R. W. Barton, Esq., for a dish of carrots ; to Mr. B. H. Green, for a dish of peas ; and to Mr. C. Walker, for a cabbage of ample dimensions.

Charles Wood, Esq., obtained no less than ten prizes, namely :— For the second-best stove-plant, *Hedýchium angustifólium* ; the ninth-best greenhouse plant, *Gloxínia speciósa* ; for the best hardy shrub, *Rhododéndron máximum* ; the second-best hardy shrub, *Rhododéndron ferrugíneum* ; the third-best hardy shrub, *Andrómeda cassinefólia* ; the seventh-best herbaceous plant, *Dracocéphalum Ruyschiána* ; the eighth-best herbaceous plant, *Podalýria austrális* ; the second-best marbled rose ; the third-best marbled rose ; the fourth-best dark rose.

The Salford band was in attendance, and contributed to the gratification of the company by playing a variety of popular and select airs. (*Wheeler's Manchester Chron.*, June 27.)

*Liverpool Floral and Horticultural Society.* — The grand Tulip Show, being the second exhibition of flowers, fruits, &c., of the present season, took place on May 28. The number and perfection of the tulips exhibited commanded universal admiration; and they were, indeed, beautiful beyond any expectation which the lengthened protraction of a season, particularly unfavourable for their culture, could have permitted one to indulge. The prizes were awarded as follows: —

*Plants.* Stove: 1. *Cactus speciosissima*, Mr. Cunningham; 2. *Ixora coccinea*, Mr. Davis; 3. *Amaryllis Johnsoni*, Mr. Ashton Yates; 4. *Gesneria verticillata*, Thomas Case, Esq.; 5. *Gloxinia speciosa alba*, Mrs. Edward Cropper; 6. *Thunbergia alata*, Mr. Powell; 7. *Gloxinia speciosa*, Mr. Smith, Fullwood Lodge; 8. *Oncidium flexuosum*, Thos. Case, Esq. Greenhouse: 1. *Maurandya Barclayana*, Mr. Davis; 2. *Calceolaria connata*, Mr. Whalley; 3. *Calceolaria corymbosa*, Mr. Cunningham; 4. *Calceolaria rugosa* var., Mrs. Rathbone; 5. *Agapanthus umbellata*, Mr. C. Rawden; 6. *Calceolaria rugosa*, Mrs. Cropper; 7. *Epacris grandiflora*, Mrs. Rathbone; 8. *Eutaxia myrtifolia*, Mr. Davis. Ericas: 1. *Pragnans coccinea*, Mr. Whalley; 2. *Vestita rosea*, Mr. Dyson; 3. *Donsa*, Mr. Whalley; 4. *Vestita coccinea*, Mr. Dyson; 5. *Lennox*, Mr. Whalley; 6. *Translucens*, Rev. R. Guillam; 7. *Laves*, and 8. *Vestita fulgens*, Mr. Davis. Herbaceous: 1. *Mimulus luteus*, Mr. Smith, Fullwood Lodge; 2. *Lilium longiflorum*, Mrs. Cropper; 3. *Gem coccineum*, Mr. Skirving; 4. *Astragalus uralensis*, Mr. Davis; 5. *Mimulus moschatus*, and 6. *Ramonda pyramidica*, Mr. Skirving; 7. *Lenra* [?] *alpina*, Mr. Powell; 8. *Galardia bicolor*, Mr. Skirving. Pelargoniums: 1. *Daveyanum*, Mrs. Rathbone; 2. *Paul Pry*, and 3. *Latifolium*, Mr. Skirving; 4. *George the Fourth*, Mr. Powell; 5. *Tricolor*, Mr. Skirving; 6. *Smithii*, 7. *Apollo*, and 8. *Macranthon*, Mr. Thomas Walker. Hardy: 1. *Pæonia arborea*, Mr. Whalley; 2. *Eccremocarpus scaber*, and 3. *Hydrangea hortensis*, Mr. Skirving; 4. *Azalea calendulacea*, Mr. R. B. Yates; 5. *Azalea pontica*, Mr. Smith, Knowsley; 6. *Ulex europæus*, Mr. Skirving; 7. *Ledum buxifolium*, Mr. R. B. Yates; 8. *Azalea coccinea*, Mr. Whalley. Orange Trees: 1. Mrs. Cropper; 2. H. B. Hollinshead. Lemon Tree: Mr. Roskell. Baskets of Plants: 1. Mr. Skirving; 2. Mrs. E. Cropper; 3. H. B. Hollinshead, Esq. Baskets of Cut Flowers: 1. and 2. Mr. Whalley; 3. Mrs. Rathbone. Double *Dahlia* (*Georgina*) *speciosa*: 1, 2, 3, and 4. Mr. Davies. Pæonies (Cut Flowers): 1. *Pavonia*, Mr. Skirving; 2. *Officinalis*, Mr. Whalley; 3. *Hamilles*, 4. *Rubra Plena*, and 5. *Anomalia*, Mr. Skirving. — *Tulips.* Premier Prizes: 1. *Lambert's Rising Sun*, Premier Mobile, *Rose Unique*, *Triomphe Royal*, *Duc de Savoy*, and *Black Baguet*, Mr. Leighton; 2. *Rose Unique*, *Firebrand*, *Violet Waller*, *Charbonnier Noir*, *Sherwood's Rose*, and *Baguet*, Mr. Morris, Manchester; 3. *Count de Vergennes*, *Unique*, *Cleopatra*, *Baguet*, *Firebrand*, and *Vestris*, Mr. Morris, Manchester; 4. (Best six bed-flowers) *Albion*, *Unique*, *Violet Triumphant*, *Captain White*, *Baguet*, and *Flora*, Mr. Pyke. Feathered Bizards: 1. *Firebrand*, Mr. Morris; 2. *Duc de Savoy*, Mr. Bruce; 3. *Trafalgar*, Mr. Appleton; 4. *Goud Beurs*, Mr. Morris; 5. *Catafalque*, Mr. Bruce; 6. *Surpasse Catafalque*, Mr. Taylor; 7. *Rising Sun*, Mr. Morris. Flamed Bizards: 1. *La Cantique*, Mr. Appleton; 2. *Bailey de Holland*, Mr. Bruce; 3. *Lustre*, Mr. Morris; 4. *Beauté Frappante*, Mr. Leighton; 5. *Flamed de Gurel*, Mr. Taylor; 6. *Onyxcolea*, Mr. Bruce; 7. *Smith's Alexander*, Mr. Leighton. Feathered Bybloemen: 1. *Baguette*, Mr. Leighton; 2. *Soot*, Mr. Appleton; 3. *Bienfait*, Mr. Leighton; 4. *Surpassant*, Mr. Morris; 5. *Rowbottom's Incomparable*, Mr. Harrison; 6. *Franciscus*, Mr. Morris; 7. *Washington*, Mr. Bruce. Flamed Bybloemen: 1. *Reine d'Egypt*, Mr. Leighton; 2. *Violet Alexander*, Mr. Bruce; 3. *Princess Charlotte*, and 4. *Abdalonymus*, Mr. Leighton; 5. *Laura*, Mr. Bruce; 6. *Marie Pitt*, Mr. Powell; 7. *Imperatrice*, Mr. Leighton. Feathered Cherry, or *Rose*: 1. *Count*, and 2. *Nile*, Mr.

Leighton; 5. Little, Mr. Taylor; 4. Walworth, and 5. Triomphe Royal, Mr. Morris; 6. Gastelle, Mr. Appleton; 7. Holden's Rose, Mr. Bruce. Flamed Cherry, or Rose: 1. Unique, Mr. Morris; 2. Vesta, Mr. Leighton; 5. Incomparable, Mr. Whalley; 4. Triomphe Royal, Mr. Leighton; 5. Rose Cerise, Mr. Bruce; 6. Rose Mintia, Mr. I. Taylor; 7. Rose Domingo, Mr. Pyke. Double Tulips: 1. Mr. Appleton; 2. Mr. Whalley; 3. Mr. Boardman; 4. Mr. Bruce. Self, or Breeder Tulips: 1. Yellow, and 2. Breeder, Mr. I. M. Taylor; 3. Seedling, Mr. Appleton; 4. Flag, Mr. Roby. Maiden Growers. Best Feathered Bizard: 1. Duc de Savoy, Mr. John Leigh; 2. Magnus, Mr. Carter. Best Flamed Bizard: 1. Catafalque, and 2. Phoenix, John Leigh. Best Feathered Bybloemen: 1. Baguette, John Leigh; 2. Seedling, Mr. Carter. Best Flamed Bybloemen: 1. Triumph, and 2. Prince of Egypt, John Leigh. Best Feathered Cherry, or Rose: 1. Dolittle, Mr. Davis; 2. Triumph, John Leigh. Best Flamed Cherry, or Rose: 1. Vesta, Mr. Carter; 2. Cerise, John Leigh. — *Fruit.* Pine-Apples: 1. and 2. Jamaica, Mr. Powell; 3. Enville, Mr. Comer. Grapes. Black: 1. and 2. Hamburg, Mr. Tayleure; 3. Mr. Cunningham. White: 1. and 2. Frontignac, Mr. Cunningham; 3. Mr. Smith, Fulwood Lodge. Strawberries: 1. Mr. Roskell; 2. Rev. R. Guillam; 3. Mr. Roskell. Apples of 1828: 1. and 2. Mr. Roskell; 3. Mr. Isaac Harrison; 4. H. B. Hollinshead, Esq. Nuts of 1828: 1. and 2. Mr. Whalley. — *Culinary Vegetables.* Asparagus: 1. Mr. S. Woodhouse; 2. Mr. A. Yates; 3. Mr. Smith, Fulwood Lodge. Cucumbers: 1. and 2. Mr. Smith, Knowlesley; 3. T. Case, Esq.; 4. Mr. Powell. Turnips: 1. Mr. T. Walker; 2. Mr. Smith, Fulwood Lodge; 3. Mrs. Rathbone. Lettuces: 1. Mr. Davis; 2. W. Earle, Esq.; 3. Mr. T. Walker. Mushrooms: 1. W. Earle, Esq.; 2. H. B. Hollinshead, Esq.; 3. Mr. Roskell. Peas: 1, 2. and 3. Mrs. Rathbone; 4. W. Earle, Esq. Beans: 1. T. Case, Esq. French Beans: 1. T. Case, Esq.; 2. Mr. Smith, Knowlesley; 3. Mr. Tayleure; 4. Mr. Smith, Knowlesley. Cauliflowers: 1. Mrs. Rathbone; 2. Mr. Preston; 3. Mrs. Rathbone.

*Extra-Prizes.* Cabbage, Mrs. Rathbone and Mrs. Cropper. Rhubarb, Mr. H. Barnes and Mr. Whalley. Persian Lilac, Mr. R. B. Yates. Baskets of Plants, W. Earle, Esq., Mr. Dyson, Mr. Powell, Mr. Dobson, Mr. O. Heyworth, Mrs. Rathbone, Mr. H. Wilson, Mrs. Pyke, Mr. Skirving, Mr. Cooke, Mr. Horsfall, Mr. Hadwen, Mr. Whalley, and Mr. Tudor. *Fuchsia gracilis* (green-house), Mr. Skirving and Mrs. Cropper. *Ixora coccinea* (stove), H. B. Hollinshead, Esq. *Justicia bicolor* (stove), Mr. Horsfall. (*Liverpool Chronicle*, May 30.)

The Ashton under Lyne Floral Society held their Second Meeting on June 29.; and

The Stockport Floral Society held their First Meeting on June 30. Both Meetings were numerous and most respectably attended. (*Manchester Courier*, July 4.)

Bolton Floral and Horticultural Society. — The Third Meeting of this Society was held on July 1., at the large room in the Commercial Inn, for the exhibition of pinks, ranunculuses, stove, green-house, and herbaceous plants, fruits, &c. On account of the excessive wetness of the weather, the company was not so numerous as on former occasions, but the Show itself was peculiarly worthy of admiration. The ericas of Roger Holland, Esq., attracted much notice, and deservedly, as they were truly superb and unique. The following are amongst the principal prizes obtained: —

*Plants.* Stove: 1. *Erythrina crista galli*, W. Hulton, Esq.; 2. *Hoya carnosa*, W. Grey, Esq.; 3. *Gardènia radicans*, E. Silvester, Esq. Green-house: 1. *Clèthra arborea*, Joseph Ridgway, Esq.; 2. *Polýgala cordifolia*, W. Hulton, Esq.; 3. *Calceolària rugosa*, R. Holland, Esq. Herbaceous: 1. *Delphinium grandiflorum*, R. Holland, Esq.; 2. *Pæonia álba Whitlèi*, Mr. James Rushton. Hardy: 1. *Kálmia angustifolia*, E. Ashworth, Esq.; 2. *Rhododéndron pònticum*, R. Holland, Esq.; 3. *Azàlea*



álba, Joseph Ridgway, Esq. Geraniums: 1. Victory, and 2. Lady of the Lake, R. Holland, Esq. Erica, R. Holland, Esq. — *Fruits.* Pine, W. Hulton, Esq., Joseph Ridgway, Esq. Grapes, E. Ashworth, Esq. Melon, Joseph Ridgway, Esq. Cherries, E. Ashworth, Esq. Strawberries, W. Hulton, Esq., James Cross, Esq. Gooseberries, Mr. Matthew Gaskell. — *Culinary Vegetables.* Cucumbers, James Cross, Esq. Cauliflowers, Mr. Jos. Taylor. Lettuce, Miss Pilkington.

*Extra-Prizes.* *Lèdum áltius*, Jos. Ridgway, Esq. Cucumber, E. Ashworth, Esq. Broccoli, Celery, and Carrots, W. Hulton, Esq. Spinach, R. Rawson, Esq. Onions, A. Knowles, Esq. Caláthea [? sp.], *Gladiolus cardinális*, and *Maránta zebrína*, Joseph Ridgway, Esq. *Passiflora*, E. Silvester, Esq. *Thunbérghia* [? sp.] and *Eccremocárpus scáber*, Roger Holland, Esq. *Combrètum purpúreum*, W. Hulton, Esq. Best Basket of Flowers, E. Ashworth, Esq. (*Manchester Courier*, July 4.)

*Bolton Floral and Horticultural Society.* — The Second Meeting of this Society, for the season, was held on May 29. The exhibition of tulips, stove, green-house, and herbaceous plants, fruit, &c., was excellent; and the very tasteful manner in which they were staged, gave the room a very pleasing effect. The company who attended consisted of nearly all the beauty and fashion of the town and neighbourhood. The Bolton old band was in attendance, as usual, and performed several interesting airs, in very creditable style. From the extensive and increasing patronage bestowed upon this Society, we anticipate that, at no distant period, it will rank as one of the first of the kind in the kingdom. We are sorry to say, that, from the lateness of the hour at which we received the list of the prizes, and the names of the persons to whom they were adjudged, we have been compelled to insert only the names of those who gained the first in each class:

*Plants.* Stove, *Musa coccínea*, Joseph Ridgway, Esq. Green-house, *Calceolària rugòsa*, R. Holland, Esq. Herbaceous, *Sèdum álbum*, Joseph Ridgway, Esq. Hardy, *Dáphne Cneòrum*, E. Ashworth, Esq. Geranium, the best *Triomphe de Flora*, R. Holland, Esq. *Erica tubiflòra*, R. Holland, Esq. — *Tulips.* Best pan (as in each class), and best Tulip, Goud Beurs, Mr. James Tomlinson. Feathered Bizard, Duc de Savoy, Mr. James Rushton. Feathered Bybloemen, Bienfait, Mr. Richard Greenhalgh. Feathered Rose, Comte de Vergennes, R. Holland, Esq. Flamed Bizard, Incomparable Bizard, Mr. William Crossley. Flamed Bybloemen, Atlas, Mr. James Rushton. Flamed Rose, Rose Unique, Mr. Wm. Crompton. Self: Yellow, Mr. Richard Greenhalgh. Breeder, Isabella of Cherries, Mr. Henry Pickering. Double, Crown Imperial, Mr. Richard Greenhalgh. — *Fruit.* Pine, Joseph Ridgway, Esq. Grapes, James Cross, Esq. Strawberries, J. Ridgway, Esq. — *Culinary Vegetables.* Cucumbers, E. Ashworth, Esq. Lettuce, Miss Pilkington. (*Bolton Chron.*, May 30.)

#### DEVONSHIRE.

*The Devon and Exeter Horticultural Society* is now regularly organised, and we have just received a printed copy of their rules and regulations. "The objects of the Society will be, to extend the knowledge of botany, and to encourage useful and ornamental horticulture in the south-west of England." Meetings and exhibitions are to be held, a library formed, and, if practicable, a botanical and experimental garden established. The ordinary members are of two classes, who pay yearly 21s., and 10s. 6d. respectively; payments made in advance, on the 1st of January each year — a wise regulation; and donors of 25l., and subscribers of 2l. 2s. and upwards, annually, shall be perpetual members and committee-men. The following is also an excellent regulation: — "As the property and advantages of the Society increase, no new members [except practical gardeners] shall be admitted, without the payment of a premium on admission, in addition to their sub-

scription; the amount of such premium to be fixed, from time to time, by the Annual Meeting." The list of officers and of the committee for the present year is highly respectable; and, we have no doubt, every man who has a stake in the soil, within thirty miles of Exeter, will soon connect himself with this Institution, which does credit to those who have exerted themselves to set it agoing; and of these, we know Mr. Veitch has been very active, and will soon produce an impression on its field of exertions.

The management of this Exhibition was entrusted to a committee, who employed an experienced gardener to attend, in order to receive and unpack the articles intended to be exhibited, to pay proper attention to them while they remained, and to repack and deliver such as were returned to the contributors. The following are the prizes which were awarded: —

*Plants.* Best bouquet of hardy annuals, six best tender annuals, were exhibited in pots, six best specimens of hardy perennials, six best specimens of hardy flowering shrubs, best bulbous-rooted tender exotic, and best tender exotic of any other kind, 1*l.* 1*s.* each; — *Flowers.* Best six roses of sorts, in a bouquet, best six *indica odorata* and Noisette roses, in a bouquet, 1*l.* 1*s.* each. Best three climbing roses, in a bouquet, 10*s.* 6*d.* Three best bizard carnations of sorts, 1*l.* 1*s.*; three second best, 15*s.* Three best flake carnations of sorts, 1*l.* 1*s.*; three second best, 15*s.* Best seedling bizard carnation of the exhibitor's own growth, and not before exhibited, 1*l.* 1*s.*; second best, subject to the same conditions, 15*s.* Best and second best seedling flake carnations, subject to the same conditions, 15*s.* Best bouquet of carnations, 15*s.* The three best picotees of sorts, 1*l.* 1*s.*; three second best, 15*s.* Best seedling picotee of the exhibitor's own growth, and not before exhibited, 1*l.* 1*s.*; second best, subject to the same conditions, 15*s.* Best bouquet of picotees, and six best pinks of sorts, 15*s.* each. — *Fruit.* For the best pine-apple, and best bunch of grapes, 2*l.* 2*s.* each. Best melon, best specimen of the *Citrus* tribe raised without fire or dung-heat, best dish of six apricots, best dish of six peaches, best dish of six nectarines, best dish of six plums, and best dish of cherries, not less than 1 lb. weight, 1*l.* 1*s.* each. Six heaviest gooseberries, best flavoured dish of gooseberries, best dish of raspberries, best dish of apples of any sort, and best dish of pears of any sort, 10*s.* 6*d.* each. — *Culinary Vegetables:* Four best specimens of culinary vegetables of any kind, 1*l.* 1*s.* each.

In addition to the above, the committee were authorised to award the sum of ten guineas, in such proportions as they should think proper, to such other fruits, vegetables, and flowers, not having gained prizes, as they should consider deserving of reward. (*Freeman's Exeter Flying Post*, June 11.)

---

## ART. IX. *Biography.*

*THE late William Smith.*—Scotland has long been distinguished for producing superior practical gardeners; but comparatively few of these have distinguished themselves as botanists. The meritorious young man whose name appears at the head of this article, seemed destined to excel in both characters. He was a son of Mr. James Smith, head gardener to the Earl of Hopetoun, and well known in his profession. He had the advantage of assisting his father in new-modelling the extensive garden at Hopetoun House, and in forming the collection of plants there. The subsequent part of his history we shall quote from a letter (now before us) from Mr. Sabine, secretary of the Horticultural Society of London, addressed to Mr. Neill, secretary of the sister institution in Edinburgh. "William Smith came to us in May, 1825. In April of the following year, he was made under-

gardener (i. e. foreman); and at the time of his death, which happened on the 15th of November 1828, when he was only in his 25th year, he had the entire charge of our Arboretum and Experimental Glass Houses. His skill, diligence, disposition, and manners, were all the best. He had the regard and good will of all his companions, and the esteem and respect of his superiors. Had he lived, he would not only have acquired credit as a practical gardener and botanist, but would have made a figure by his writings. He printed two papers in our *Transactions*; one on pendent trellises, and the other on dahlias. He had another paper on dahlias nearly ready; as well as a monograph on the genus *Cyclamen*. The British roses had engaged his attention, and I shall probably have to publish some new native species, distinguished by himself. Exclusive of all these, he had collected observations on several of the ornamental genera, as *Pæonia*, *Fuchsia*, *Calceolària*, and *Yucca*." — This is high praise: it is praise from the first authority on such subjects in the kingdom, and the spontaneous testimony of an honourable mind to modest merit. It may be right to explain that the Arboretum, in the Horticultural Society's garden at Chiswick, is, perhaps, the richest or most varied in Europe, and requires in the superintendent, among other qualifications, very acute botanical discrimination; that the charge of the experimental hot-houses of that establishment implies extensive trust and responsibility; and that the genus *Ròsa*, which Mr. Smith was engaged in illustrating, is one of the most obscure and difficult of our native genera. (*Scotsman*, Dec. 31.) [The above appeared during our absence on the Continent, and we regret extremely that though more than one correspondent have sent us copies of the newspaper in addition to our own copy which we receive regularly, we have hitherto, from press of matter, been prevented from giving it insertion. Having frequently seen and conversed with Mr. Smith at the Horticultural Society's garden, we can bear testimony to his great merit, and we sincerely lament his loss. — *Cond.*]

---

#### ART. X. Obituary.

*DIED*, on the 50th of May last, at his father's house near Thame, Oxfordshire, aged 24, *Mr. Francis Channer*, late gardener to Sir Thomas Le Breton, chief magistrate in the Island of Jersey.

Distinguished professional abilities, joined to a highly cultivated understanding, rendered this young man, while living, an object of the greatest promise and deepest interest. Characterised by virtues and a superiority of demeanour seldom to be found in the sphere he occupied, he attracted the regard and the respect of all who knew him. The attention shown him by his distinguished employer during his illness, and the anxious efforts exerted for his recovery, confer the highest honour upon the heart and disposition of that gentleman; and, on the part of his afflicted servant, *was felt* as a most gratifying proof of approbation. Finding his mortal career inevitably about to terminate, this amiable young man expressed a wish to return to his paternal home; where he awaited and eventually met the stroke of fate, with the calmest feelings of resignation and fortitude; feelings acquired by the habitual cultivation of a proper sense of religion, and the possession of a conscience not oppressed with the gloomy memento of moral turpitude or complicated wickedness. — *W. Jersey, June, 1829.*

---

THE  
GARDENER'S MAGAZINE,  
OCTOBER, 1829.

---

PART I.  
ORIGINAL CORRESPONDENCE.

---

ART. I. *Notes and Reflections made during a Tour through Part of France and Germany, in the Autumn of the Year 1828.* By the CONDUCTOR.

(Continued from p. 378.)

*THE Botanic Garden of Rouen, September 3.*— This garden occupies something less than two acres, enclosed by a high wall; it is entered from the south, whence a range of glass meets the eye on the opposite side. This is always a fortunate circumstance in a garden containing hot-houses; and its absence is to be lamented in the Liverpool botanic garden, and in those of Kew and of the Horticultural Society, in which we enter behind the hot-houses; and in the Paris garden, where we enter at one side of them. The director of the Rouen garden, M. Dubreuil, has also the care of the public gardens and avenues: he is a man of science and general information, and possesses a good library and herbarium. His son, who is fond of every branch of natural history, and has made a considerable collection of butterflies and other insects, is a studious and very industrious youth, and will be sent to England to complete his education as a nurseryman. What gratified us particularly in this garden was to find Madame Dubreuil fond of plants; she took a part in our conversation on the subject, and in walking through the garden with us one day, when M. Dubreuil was not there, evinced a knowledge of the application of the Natural System, by naming to us the order to which a certain plant belonged, of which she did not recollect the name. This is one grand use of the Natural System; we are less

likely to forget the name of a genus than that of a species, of a tribe than of a genus, of an order than of a tribe, of one of the grand subdivisions than of an order, and every man who knows any thing of the Natural System can tell at sight whether a plant belongs to Monocotyledoneæ, Dicotyledoneæ, or Acotyledoneæ. This is what cannot be said of the Linnean classification, and hence the importance of assembling, in private flower-gardens, types of all the natural orders and tribes of hardy plants. This (see Vol. II. p. 309.) ought to be done by every gentleman who can afford to have a pleasure-ground or a flower-garden.

The arboretum in this garden forms a narrow circumferential belt, but does not contain many fine specimens. The interior of the garden is laid out in beds, and planted with herbaceous plants and trees, with vacancies for house-plants; so that in summer, when these last are set out in their places, almost every order of the Jussieucan system is exemplified. The names of the classes, orders, genera, and species are painted black, on iron plates painted white; to these plates iron rods are riveted, of four different lengths according to the four divisions of class, order, genus, and species. The most remarkable specimen that we saw among the trees was a standard silk tree (*Acacia Julibrissin*) 20 ft. high, and finely in flower. The hybrid lilac, *Syringa chinensis* var. *rothomagensis*, was raised in this garden by M. Varin, M. Dubreuil's predecessor. M. Marquis, the professor of botany, gives lectures in the green-house here from May till August, three times a week, at six o'clock in the evenings, and herborisations in the surrounding country every Thursday.

*The principal Public Garden of Rouen* adjoins the church of St. Ouen and the Hôtel de Ville. It only contains an acre or two; but it has been laid out with care, and, as far as there is room, is planted with the rarest trees, shrubs, and flowers to be purchased in Rouen. We observed *Magnolia grandiflora*, *conspícua*, *gláuca*, *tripétala*, and *acuminàta*; *rhododendrons*, *azaleas*, *kalmias*, &c. There is a small green-house placed against the church, in which are kept geraniums, georginas, and other green-house or half-hardy plants, which are turned out in the borders and in the groups, during summer, along with balsams and other articles raised in hot dung. The whole of this garden, and all these fine plants and flowers, at this time in the greatest luxuriance, are open the whole day to every part of the public. On the seats we observed well-dressed people, servants and children, boys and girls, old men and women, and beggars and their children. No one touched any thing. In front of the Hôtel de Ville,

in the most ornamental part of the garden, are a basin and fountain, with water-lilies, flowering-rush, sagittarias, &c., and gold fish; and around them was a collection of chrysanthemums in pots. Near this are a parterre of roses and other flowers, and a sun-dial, *méridien à détonation*, for indicating midday by the firing of a small cannon, the gunpowder being ignited by the concentration of the sun's rays. We have already observed that all the public gardens are under the direction of M. Dubreuil. The planting and high order and keeping of this one does him the greatest credit; its being open to all manner of persons, at all times, afforded us the highest pleasure.

*Mr. Pugh's Villa, Sept. 2.* — This is the first suburban residence at which we called. It is situated in a street, contains about  $1\frac{1}{2}$  acres of flat surface without distant prospect, is not badly laid out, and is tolerably well kept. Near the entrance a short avenue, terminating in a painted landscape, at once characterises it as French. The principal feature is a collection of large orange trees, some of them with their boxes above 17 ft. high, and it is estimated, that they must be at least several centuries old, since the fathers of old persons still alive recollected that in their youth the trees were much of the same size as they are at present. There are a hundred of these venerable and beautiful trees, set out at regular distances, in a square hedged enclosure laid with gravel. In winter the trees are kept in a barn-like building, 85 ft. long, 30 ft. wide, and 18 ft. high, with a few small windows, and a large carriage-entrance in one end. They are taken out and in by Vallet's diable (p. 377.), with one horse and three men; and each box, which is 4 ft. square, outside measure, is with this power lifted up or set down in exactly two minutes. Two men will work the machine, but not so well as three; and four render the work so perfect in point of rapidity, that the whole of these 100 heavy boxes may be taken in or out in one day. The materials of the boxes are oak or chestnut, which, when well painted, last 35 years. These 100 trees, in 1823, produced 1400 lbs. of blossoms, which sell, on an average of years, at 3 *fr.* per lb., to the apothecaries and confectioners, and to private families who distil their own orange-water. This sum of 4200 *fr.* is supposed to pay something more than the expense of keeping these trees, a circumstance which will account for the number of orange trees in France. There is a small green-house, the sashes glazed with panes cut curvilinearly at one end, and square at the other; a bad plan, which causes a black segment of dirt, and a fracture up the middle of each pane.

Among the plants we observed a large brugmansia in flower, some good specimens of the more common Australian shrubs, and cuttings of *Nèrium* striking root in phials of water. There is a small lawn containing one or two round clumps, and a circuitous walk, sanded and rolled, but not many exotic shrubs. The kitchen-garden occupies three fourths of the whole territory, and is very well cropped. Along the tops of the walls a horizontal vine-shoot is trained and spurred in; the crop was abundant and the Muscadines beginning to ripen. By far too many of the leaves were stripped off; those left on were full of holes, which the gardener, Jean Picot, told us were the effects of a hail-storm. This good man's hobby was the georgina, of which he had raised some new sorts: his crops showed him to be a good empirical practitioner; but, as far as we conversed with him, he scarcely knew any thing of the science of his art.

*The Villa of the Abbé Gossier* is in the Rue du Nord. The situation is one of the highest in Rouen; and from a pavilion on the top of the house are seen the whole of the town, and an extensive reach of the river. The garden contains above an acre, surrounded by a wall, and somewhat varied in surface by Nature, but much more so by the art and taste of the Abbé. Before the principal front of the house is a small lawn bordered by groups of trees, which completely shuts out Rouen, and forms a varied outline to the sky and the distance. All except this lawn is in the artificial style suited to a walled garden, and consists of terraced slopes, espaliers, hedges, dwarfs, vines, shrubs, fanciful little railings, and a line of posts and chains. Among the crops we observed large and excellent alpine strawberries, of the sort which produces no runners, the space between the plants being covered with rye straw: the Abbé propagates them by division, for the reasons given by M. Racine for propagating by runners (p. 124.), and sometimes also by seeds; at all events the plantation is renewed once a year. The Abbé informed us that no sea-kale was grown about Rouen, but we have since sent him abundance of seeds, and he may at any time procure both seeds and plants from M. Vilmorin of Paris. There is an orangery; and amongst a variety of curious contrivances about the house, is a painting of a *portière* and a watch-dog, which is calculated to surprise one on entering from the street, and which, we believe, we were told was intended to startle strangers and beggars.

The Abbé is the president of the Agricultural Society here, and is very anxious for the progress of the art in this part of the country. We were amused at the account he gave us

of some British gentlemen of high agricultural character, who had solicited to become members of the Rouen Society, and promised to become regular correspondents, but who have never said or done any thing for the Society since. We were not at all surprised at the Abbé's statement; for who in England, that is not independent, can afford to love any art or science purely for its own sake? The Abbé informed us that the Rouen Society had for a number of years past been persuading the farmers to leave off naked fallows, as recommended by the Board of Agriculture; but they now found that those who took their advice had rendered their land so foul, that half the crop produced was weeds, and the Society were at present recommending fallows again. The Abbé Gosier has been some time in England and in Scotland, and is an intelligent, liberal, and most amiable man, worthy of the ease and elegance in which he lives, and of that which alone seems wanting to complete his happiness. We are happy to have formed so interesting an acquaintance in a part of France which we so much admire, and which, if we ever leave England, will be the place of our retirement. We are obliged by the honour he has done us in procuring our election as a corresponding member of the Rouen Agricultural Society; and if we do not fulfil the expectations of the Society any better than other British members, we at any rate did not solicit the honour, and, on receiving it, made no promises.

*A small Villa near Quevilly.* — The grounds, which are but little varied, may contain 30 or 40 acres; the house is a part of a large *château*; and the general impression of the whole is, that of a deserted and neglected residence, on a site capable of being made something. An Englishman who has not left his own country cannot form an idea of such apparent wretchedness as these grounds present; and yet the proprietor was said to be a man of wealth, and he must have known what comfort is, for there is a newly-formed and well-stocked kitchen-garden. This kitchen-garden was laid out by M. Prevost (p. 372.), and contains examples of his mode of training peach trees *à la Forsyth*; i. e. allowing the shoot from the bud to form a main stem, and laying in the laterals horizontally, or at a very large angle. The tree is thus never cut at all. It soon rises to the top of the wall and bears fruit; but it seldom fills the wall regularly, and, when any branch dies, it is not so easily filled up as by the fan method of training, which, even for an easy method, is greatly to be preferred. It is but justice to M. Prevost, however, to state that he wishes the trees to be cut so as in the end to present the appearance of Mr. Forsyth's apricot tree (*E. of G.* p. 720.



fig. 493.); but, judging from appearances in this garden, the desired result is not very likely to be attained. The walls, which were of rubble stone, were covered with a wooden trellis, and to this the shoots of the trees were tied with withered rushes; but the gardener here seemed to have no idea of filling every part of the wall with shoots. In short, in this operation, as in most others, an English gardener has nothing to learn, in exactness and neatness, from his brethren in France. This garden was very neatly laid out; the walks edged with box, and covered with granite pounded to about the size of peas; the borders planted with dwarfs, except in the angles formed by the turnings and intersections, where a tree trained *en pyramide* was planted. In the compartments we observed beds and rows of Perfumed Cherry (*Cerasus Mahaleb* Mil., *bois de St. Lucie*, Fr.), which were intended for forming plantations of coppice, that wood being highly prized for fuel on account of its agreeable odour. The stems of some apricot trees from which the gum had issued were covered with what seemed to be pitch, and thatched with wheat straw to exclude the influence of the sun. On the whole, the garden was in good order, and is the only part of the residence that we can recall to mind with any satisfaction. The gardener, Claudel le Coint, is a good-humoured man, walks in *sabots* when in his garden, but puts on shoes when he goes to Rouen; reads, occasionally, gardening books as well as *chansons à boire*, and says he can write *comme il faut*.

In our next we shall notice the other country seats which we visited in the neighbourhood of Rouen.

(To be continued.)

---

ART. II. *Some Account of the Duke of Northumberland's Improvements in the Kitchen-Garden and Forcing-Department at Syon.* By the CONDUCTOR.

THE improvements in these gardens, as we have formerly observed (Vol. I. p. 349. and II. p. 107.), were commenced in April, 1826, by the construction of a boundary wall along the public lane from Brentford to Isleworth (*fig. 99. a a*), the erection of an excellent house for the gardener (*b*), and the general reformation of the surface and walks of the kitchen-garden. The ground within the walls contains between three and four acres, a quantity which may appear rather small for so large a family; but it must be considered that the Duke of Northumber-

land's residence at Syon is but for a short period of the year. The chief disadvantage of too small a garden, as far as it concerns the gardener, is, the obligation it imposes on him of growing vegetables on the fruit-tree borders, in consequence of which the trees never do much good. By a reference to the plan

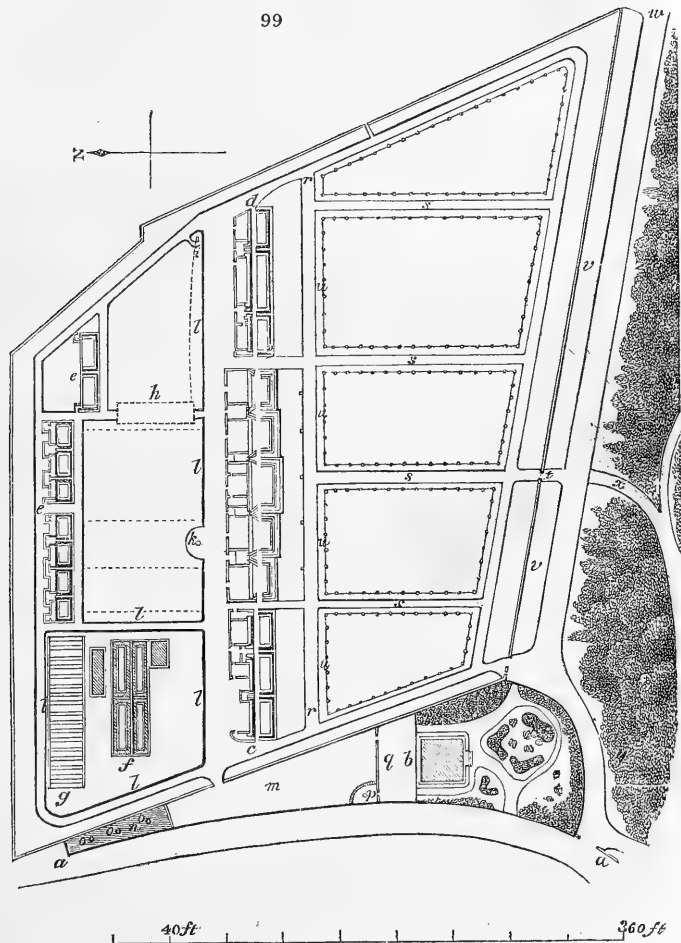

there will be observed the situation of the range of forcing-houses (*cd*), of the pits (*ee*), melon ground (*f*), and asparagus beds (*g*). The pits are remarkably complete, and we shall, on a future occasion, give detailed plans and sections of them as models for imitation. The melon ground is very small,

but as that has not yet undergone any alteration, we have no doubt it will eventually be enlarged so as to be in proportion to the other departments. The asparagus and sea-kale beds are cased with pigeon-hole brick walls, which admit linings of dung or leaves  $2\frac{1}{2}$ -ft. wide between, so that a crop is obtained every year with less trouble and expense, and of a better quality, than by any other method. These beds are very complete, and the pigeon-hole walls, which sometimes give way when not carefully treated, have a coping of cast-iron, which coping, having two depending sides, holds the upper course of bricks firmly in its place, and these retain all which are below. We do not know who invented this mode of forcing in brick beds, but we consider it by far the best for main forced crops of sea-kale and asparagus; and, we have no doubt, it might be applied with equal advantage to forcing potatoes, radishes, lettuces, turnips, carrots, cauliflowers, peas, and many other kitchen crops; some of which might require to be covered with glass frames, or with hoops and mats, or, as at Britton Hall, with wickerwork.

The whole of the water from the roofs of the forcing-range and back sheds, and from all the pits, is conducted by pipes to a cast-iron tank (*h*) containing 20,000 gallons, out of which are supplied a water-cistern in every house, and also a steam-boiler, which is used in the forcing-houses for the purpose of producing vapour at pleasure in any of the divisions. We consider this reservoir of rain-water of great importance for successful forcing, and the growth of plants generally; no water whatever being found equal to that produced in the atmosphere, and the water of several subsoils being found injurious to vegetation, especially to heaths and other Cape and New Holland plants. For watering in the open air, the water is drawn from this tank by a pump (*i*). There is also a pump (*k*) of common underground water, for the purposes of cleaning, in the back sheds and other places; a degree of cleanliness being maintained, of which we have already (Vol. II. p. 108.) pointed out the advantages. The whole of the pit and frame department is enclosed with box hedges about  $2\frac{1}{2}$  ft. high, kept neatly clipped (*l*); and their effect, at all seasons, is particularly handsome, rendering this part of the garden as neat, and even as ornamental, as the part in front of the forcing-range.

The soils and composts are kept in a secluded department (*m*), and there is an excellent contrivance for delivering and keeping the coals which well deserves attention. The coal-house (*n*) holds upwards of 150 chaldrons; all of which are carried up ladders to the roof by the coal-merchant (who de-

livers them in sacks, as is usual about London), and poured through three small holes (ooo) in the roof, which is a perfect security from stealing, and saves much labour. When wanted for the back sheds, the coals are taken out by a door which opens into the compost ground. The coals for the head-gardener's use are also delivered from the lane, through the roof, into a small shed (p) opening into the yard attached to his house (q).

The cultivated part of the garden, in front of the forcing-range, was begun to be altered in July, 1826. The old hot-houses being taken down, and the walks grubbed up, the surface was reduced to determinate levels, new walks formed, so as to throw the whole into compartments and borders, and the soil was every where renewed, or prepared with a mixture of good new soil, to the depth of three feet. The gravel of which the walks are formed was dug out of particular portions of the subsoil, and its place filled with rubbish from the removed buildings, and with exhausted soil, waste gravel, &c., which would otherwise have required to be carted away. The circumstance of procuring the gravel in this way, and at the same time getting rid of the rubbish, must have saved a very considerable expense. The perfect level of the walk in front of the range (rr), the uniform slopes from it of the north and south walks (ssss), the regularity of the borders and of the compartments, equal, in this kind of beauty, any thing we ever saw. Nothing can be finer in the way of a kitchen-garden view, than the appearance of the forcing-range, and of the garden in front of it, when entering at the main door (t), and walking up the central walk (ts). The upper border (uuuu) is planted with the finest sorts of Flemish pears, to be trained *en pyramide*; the other borders are planted with a complete collection of all the select table apples (dwarfs) on paradise stocks. Detached trees and dwarfs are preferred, as admitting more sun and air to the vegetables around them, and because, on the whole, such trees are more certain of producing a crop in adverse seasons than espaliers. The reason of this is, an espalier hedge has only two sides, and the whole of the blossom and crop is on the surface; whereas a globular or a regular bush has many sides, and has blossoms and fruit in the interior among its branches, as well as on its outer surface. On the south side of the south wall is a useful border (vv), bounded by a sunk fence, on the top of which is a holly hedge to be kept about 3 ft. high. Beyond this border is a carriage road, which leads from the public lane (aa) to the farm offices which are situated southward of the garden (w). Opposite to the main entrance of the garden (t) is the

walk ( $x$ ), leading through the shrubbery and pleasure-ground to the botanic department and the house. All on the south side of the carriage road ( $yz$ ) is pleasure-ground.

The forcing-range (*fig.* 102. p. 514.) was begun and carried on at the same time with the open garden. It consists of three vineries with fig trees on the back wall (5, 6, 7); two peach-houses with table trellises, and trees on the back wall (4, 8); and six pits or low houses (1, 2, 3, 9, 10, 11), for fruiting pines, and for forcing kidneybeans, strawberries, grapes, and figs in pots, roses and flowering shrubs, and flowers generally. We refer to p. 515. for minor details.

The old houses being removed, the foundations for the new ones, as well as for the border in front of the vineries and peach-houses, were cleared out to the depth of 5 ft., and to the width in the part to contain the vineries and peach-houses of 35 ft. measuring from the back part of the back wall. All the foundations, except that of the back wall, were begun by carrying up piers, and these were joined by arches, which being brought to a level formed a basis, on which to build the flues and all those parts which appear above ground. The entire bottom of the border, within and without the vineries and peach-houses, was formed to a smooth slope with an inclination from the back to the front of 2 ft. This slope was paved with bricks laid flat, and the joints were grouted with mortar; the object of this pavement being to prevent the descent of the roots into the sub-soil. A drain was formed in front of the border, the bottom of which was made about 1 ft. deeper than the surface of this pavement. On the pavement was next laid 12 inches of brickbats over the whole of its surface, and from this stratum air-chimneys were carried up close under the back wall in the houses, and over the drain in front. Sections of these chimneys may be seen in the cross sections of the vineries and peach-houses (*fig.* 102. E F G); and the surface gratings which cover them are indicated in the ground plan, along the edge of the garden walk in front of the border, and along the bottom of the back wall in the houses. These chimneys are 18 inches square in the inside, and covered with iron gratings; the use of them is to admit air to the porous stratum under the soil of the border; or, in case it should become necessary at any time, water or liquid manure might be poured down, and, by stopping the drain, it would rise in the rubble stratum and through the soil to any required height. It is evident, that by such an arrangement, the gardener has as completely the management of the roots of all his trees, as if they were in

pots or boxes. It is a very common thing, in breaking up the foundations and borders of old vineries, to find the soil sodden, or soured, and the roots rotten, owing to an excess of moisture being joined with rich nutritious matter without air or drainage; but where air is admitted to circulate through a porous stratum, as in these forcing-houses, the soddening of the soil and the rotting of the roots cannot take place. We, therefore, consider this excellent contrivance deserving of adoption in all vineries and peach-houses, and, if it were not for the expense of it, in all fruit-tree borders and even in open orchards.

The soil for the borders was prepared by collecting the turf or surface of an old pasture meadow of hazel loam, and laying it up in small ridges 2 ft. broad at bottom, and 3 ft. high, there to be summer fallowed, or operated upon by the sun's rays and alternate rains from May till September. During this period it was three or four times turned, but not broken into pieces. It has been found that the treatment of soil in this way during one summer is, for all horticultural purposes, worth several winters. While this preparation was going forward, about 30 tons of ground bones were laid in ridges covered with 6 inches of soil, to undergo that degree of fermentation which is found necessary before they can be applied with safety as a garden manure. They were not turned, but remained all summer covered with a layer of soil. A large quantity of horse and cow dung from London was fermented during the summer, in a dunghill about 3 ft. deep; it was watered when it appeared to be getting dry, and it was turned over four or five times. An immense quantity of leaves in a rotten state were collected from under the trees in the pleasure-ground; these were not fermented, because they were the accumulations of many years, and in consequence were, for the greater part, decomposed. The month of September being fortunately dry, the whole of these materials were then first mixed together and laid in ridges; the soil for the peaches being considerably (at least two thirds) less manured than that for the vines. This compost being all ready to be wheeled into its place, the stratum of rubbish was first covered with 6 inches of litter, haulm of beans or asparagus, clippings of hedges, summer prunings, &c. The weather being still dry, the whole was wheeled in, and thus the border was formed. It is to be observed, that during none of the turnings was the soil much broken or reduced to a fine state, or the turfy pieces and roots taken out; a matter which deserves to be particularly remarked, because many amateurs and in-

experienced young gardeners think that by sifting soil of its stones and roots they do a great deal for the plants, whereas in most cases they are merely bestowing on it a greater capability of becoming solid and sodden, than it would otherwise possess. Immediately after the border was filled with soil, from 6 to 8 inches of lime rubbish, that is, rubbish from old buildings, were laid over the whole of it; and during the ensuing winter the entire soil of the border, down to the stratum of litter, was turned twice and the lime rubbish thoroughly mixed with it.

In the March following the trees were planted. The peaches and nectarines were chiefly full-grown trees, taken from the open walls, of approved sorts, which had already fruited there. They bore fruit the same season (1827), and ripened their wood well. The vines were plants of one year's growth, partly raised on the premises from eyes; they produced shoots from 20 to 30 ft. long, which in autumn were shortened according to their length and strength. The fig trees planted on the back walls of the vineries were full grown trees taken from the walls; they were planted in a border 3 ft. wide, and the roots kept separate from the vine border by a brick wall  $4\frac{1}{2}$  in. wide, carried up from the bottom pavement. The soil consisted of lime and brick rubbish, with about one third of loam, without manure. They produced fruit the first year, and two good crops a year ever since.

In February and March, 1828, the peaches and vines were forced moderately, both produced abundance of wood, the peaches as strong as could be desired, and the vines shoots from 20 to 40 ft. long, the wood, in some cases,  $4\frac{1}{2}$  in. in circumference, with numerous bunches of fruit, all of which were taken off, except enough to prove the sorts.

In the autumn of this year (1828), the roofs of the vineries, and the table and back trellises of the peach-houses, were covered with excellent fruit-bearing wood; in November, fires were put to the peach-houses: the weather during the three succeeding months was dark and moist, and altogether very unfavourable for forcing, but, notwithstanding, ripe peaches were gathered early in the following May, weighing from 7 to 9 ounces each, which were regularly and successfully forwarded to His Excellency's establishment, Phoenix Park, Dublin.

The vines were begun to be forced on the 17th of November. From the length and strength of the shoots, it seemed doubtful whether they would break regularly at every bud; but by bending the shoots in a serpentine form (*fig.* 100.),

and retaining them about a month in that position, every bud, from the lower part of the shoot to the summit, pushed out leaves and showed fruit. As soon as this was effected, the shoots were restored to their straight position; most of them showed two or three

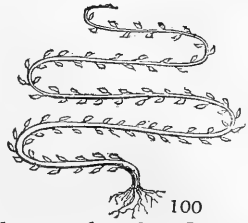

and some four or five bunches; indeed, such was the abundance of the blossom, that some shoots showed 96 bunches. In the three houses, one of 40 ft. and two of 32 ft. long, and about 19 ft. wide, 1140 bunches were cut off in a green state in order not to weaken the plants. In this, the second year of their growth, between 300 and 400 bunches were brought to perfection and sent to Phoenix Park; and be it remarked that the first bunches were cut on the 19th of April, at a time when they were worth in London a guinea and a half per lb. The berries of some of the muscats measured  $3\frac{1}{2}$  inches in circumference. The whole crop was cleared off by the end of June: the roof-sashes have since that time been removed, and the plants are now fully exposed to the weather, with their wood fully ripe, and the leaves dropping off.

With respect to the six low houses for fruiting pines, forcing a variety of articles, and growing cucumbers, we can state from our own observation, and we know it to be generally acknowledged by the profession about London, that nothing ever surpassed the excellence of their produce. Last year, the family being in England, strawberries in abundance, kidneybeans, and forced flowers of extraordinary luxuriance were produced in April, May, and June, and pine-apples of as large a size as had ever been seen at so early a period of the season. Cucumbers, some of them 2 ft. long, were gathered in the early part of the spring of the present year; and ripe grapes from plants in pots were cut on the 15th of February.

It may now be necessary to take some notice of the materials of which these forcing-houses, and also the range of pits behind them, are constructed. The pits are, for the greater part, of timber, with brick walls and smoke-flues. The roofs, ends, divisions, and trellises of the forcing-range, with the exception of three of the pits at the east end, are of metal; the bars of the sashes being of copper, and their styles and rails and the rafters and every thing else of cast and wrought iron. The floor of the path in the central range is also of cast-iron grating, supported on brick piers, which has the advantage over flag-stones of admitting the sun and air to



the soil below. The whole length of this path is on one level, and when the doors of the five divisions of these houses are open, the view from one end through them surpasses any thing of the kind we have hitherto seen. All the houses are heated by fire-flues, built of brick and covered with tiles, each tile containing a hollow panel in its upper surface, for the purpose of holding water for evaporation. The direction of these flues in the area of the houses, and in the back wall, will be seen in the plans and sections in p. 514.; and though their success is very perfect, we consider it unnecessary to enter into the details of their construction, believing that in erecting similar ranges of forcing-houses in future, the mode of heating by hot water (as at the Duke of Bedford's, but on Weekes's principle, p. 544.) will be substituted. The mode of heating by hot water had not been sufficiently brought into notice, when Mr. Forrest formed the plan of this range, to justify its adoption. The low pits behind the range are covered at nights during the forcing season by wooden shutters; but no covering of straw mats, or of any other material, is applied at any time, for the purpose of retaining the heat, to the roofs of the forcing-range. The pine-pits in the range and the forcing-pits may be shaded in the daytime by letting down rolls of canvass, which cover the roof from end to end. The

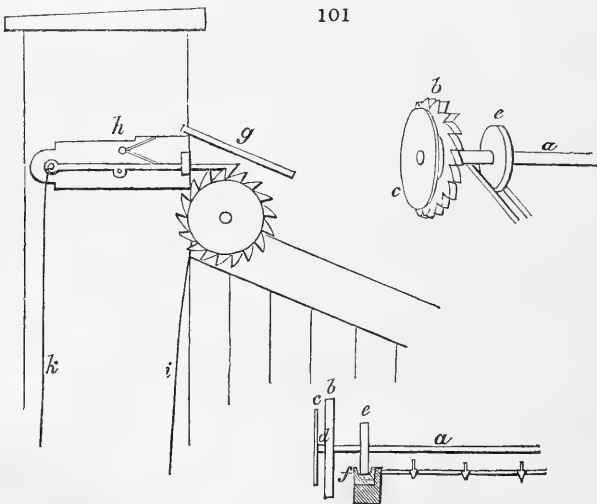

construction of these shades, invented by Mr. Forrest, deserves particular attention, not only because they are applicable to hot-houses, pits, and hot-beds of every description, but because they may be rendered available in the covering of fruit-

walls, to exclude the frost from the blossom and the birds or flies from the ripe fruit, and also in the covering of flower-beds, hay-ricks, harvested corn, temporary structures for public assemblages, &c.

The length of these rolls at Syon is between 50 and 60 ft. but we have no doubt they might be made longer, since this depends on the diameter of the pole or rod (*fig.* 101. *a*), and the toughness of the timber employed, or its power to resist torsion. On one end of this rod and not on both, as is usual, a ratchet wheel (*b*) is fixed, with a plate against it (*c*) so as to form a pulley groove between (*d*), to which a cord is fastened, and about 3 in. further on the rod is fixed a third iron wheel, about 6 in. in diameter and half an inch thick (*e*). This last wheel runs in an iron groove (*f*), which extends along the end rafter or end wall of the roof to be covered. The canvass or netting being sewed together of a sufficient size to cover the roof, one side of it is nailed to a slip of wood placed against the back wall, that is, along the upper ends of the sashes; the other side is nailed to the rod (*a*). When the canvass is rolled up, it is held in its place under a coping (*g*) by a ratchet (*h*), and when it is to be let down, the cord (*i*) of the roll is loosened with one hand and the ratchet cord (*k*) pulled with the other, when the canvass unrolls with its own weight. The process of pulling it up again need not be described. The most valuable part of the plan is, that the roll of canvass, throughout its whole length, winds up and lets down without a single wrinkle, notwithstanding the pulley-wheel is only on one end. This is owing to the weight of the rod, and its equal diameter throughout. By this plan a house 100 or 150 ft. long, might be covered with two rolls, the two pulleys working at the two ends; but if it were thought necessary, the two rods might be joined in the middle, and, by a little contrivance, the pulley and groove placed there, so as to work both of the rolls at once, from the inside of the house, from the back shed, or from the front. A more beautiful contrivance, for the purpose to which it is applied, we will venture to assert, is no where to be met with. It was constructed under Mr. Forrest's direction by Mr. Boughton, smith, Brentford End.

Such are the improvements that the Duke of Northumberland has made in his kitchen-garden at Syon; and it is important to remark that so promptly and judiciously were all the measures taken for their execution and so rapidly was that execution proceeded with, that in eight months after the work was commenced the whole was completed; the houses, borders, and walls were planted; the compartments cropped; the

walks finished; and every thing else connected with the kitchen-garden rendered as fit for the inspection and enjoyment of the family as if nothing had happened.

This magnificent range of forcing-houses may now, we think, be referred to as an additional evidence that metallic hot-houses are fit for every purpose of forcing; and we must take the liberty of saying what we have hinted at (p. 186.), that the public are greatly indebted to the Duke of Northumberland for having made this experiment, and that His Grace also has evinced a very superior degree of tact and discrimination, in adopting a description of structure, the superiority of which, though supported by the evidence of science and the opinion of some enlightened men, was yet opposed by a host of prejudices on the part of men both practical and scientific.

Though we inspected the different operations at Syon from time to time as they were going forward, yet we are, of course, indebted to Mr. Forrest for the dates and other facts which we have detailed. We should have a good deal to say of the merits of Mr. Forrest as the designer and successful and rapid executer of these works, were he not already sufficiently well known to the horticultural world. He has been engaged in works of this kind from his earliest years; and, from having received a better school-education than falls to the share of many gardeners, even those of Scotland, and been long accustomed to the management of numerous workmen, he has acquired those habits of arrangement and the division of labour, which are the only means of carrying on extensive and complicated works with that rapidity and successful result which have attended those at Syon. The great experience which Mr. Forrest has had in works of a similar kind under Mr. Macdonald, one of the very first gardeners in Scotland, at the Duke of Buccleugh's, at Dalkeith Park, and on his own account at the Hon. R. B. Stopford's, Barton Seagrove, Northamptonshire, and at the Earl of Grosvenor's, Eaton Hall, Cheshire, not to mention his botanical acquirements and his knowledge of the gardening of the metropolis while at work for several years in Kew Gardens, has not only given him habits of management, but cultivated his taste both in the art of designing kitchen-gardens and garden structures, and in laying out grounds; and the character of his mind has this particular excellence, that he embraces in his plans and arrangements every department of his art, and is not prejudiced in favour either of botanical culture, kitchen-gardening, forcing, or landscape-gardening. The Duke of Northumberland may certainly be considered fortunate in having employed such a gardener.

We must not omit to record the names of the manufacturers of these houses, Messrs. Richards and Jones, of Cheapside, Birmingham; they have evinced great ingenuity and practical skill in their construction, and will, we have no doubt, obtain the reward due to so much merit. We are inclined to think that some of the details of the rafters and sashes are improved on in the range now erecting for the Duke of Bedford at Woburn Abbey; but we shall wait till we see that range completed, and then, with His Grace the Duke of Bedford's permission, give an account of it similar to that now submitted. It is not to be considered surprising if improvements are introduced in a mode of construction comparatively new. The system of heating by hot water is undergoing astonishing improvements almost every day.

Those who know our preference for curvilinear iron hot-houses will ask whether we should not have preferred the forcing-range at Syon constructed on that principle. Our decided answer is, that we should, on account of the lightness and elegance it imparts. We are not certain, however, that something would not have been lost in point of utility, at least for vineries and peach-houses, from the difficulty of constructing the roof so as to admit of the opening and shutting of the sloping part at pleasure, and of its removal altogether after the crop is gathered. If it can be proved that peaches and grapes may be grown and forced without the direct influence of the sun and the weather to the leaves and wood of the plants at any season of the year, then we decidedly prefer curvilinear houses for them; and as they are constructed without rafters, styles, rails, pulleys, cords, &c., they must, of course, come cheaper: but if the direct influence of the weather is essential, and we believe the majority of practical men think so, then we should prefer such houses as those erected at Syon and Woburn, heated by hot water according to the latest improvement by Mr. Weekes (see p. 544.), shaded during hot sunshine by a canvass blind in Mr. Forrest's manner, and covered during the nights of severe weather by garden shutters or straw mats in the manner of Mr. Shennan (Vol. III. p. 187.) and M. Lindegaard (Vol. IV. p. 414.).

When the magnificent range of botanical hot-houses now erecting at Syon are completed, we hope, with His Excellency the Duke of Northumberland's permission, to lay a similar account of it before our readers: at present that range is not permitted to be seen by the public.

102

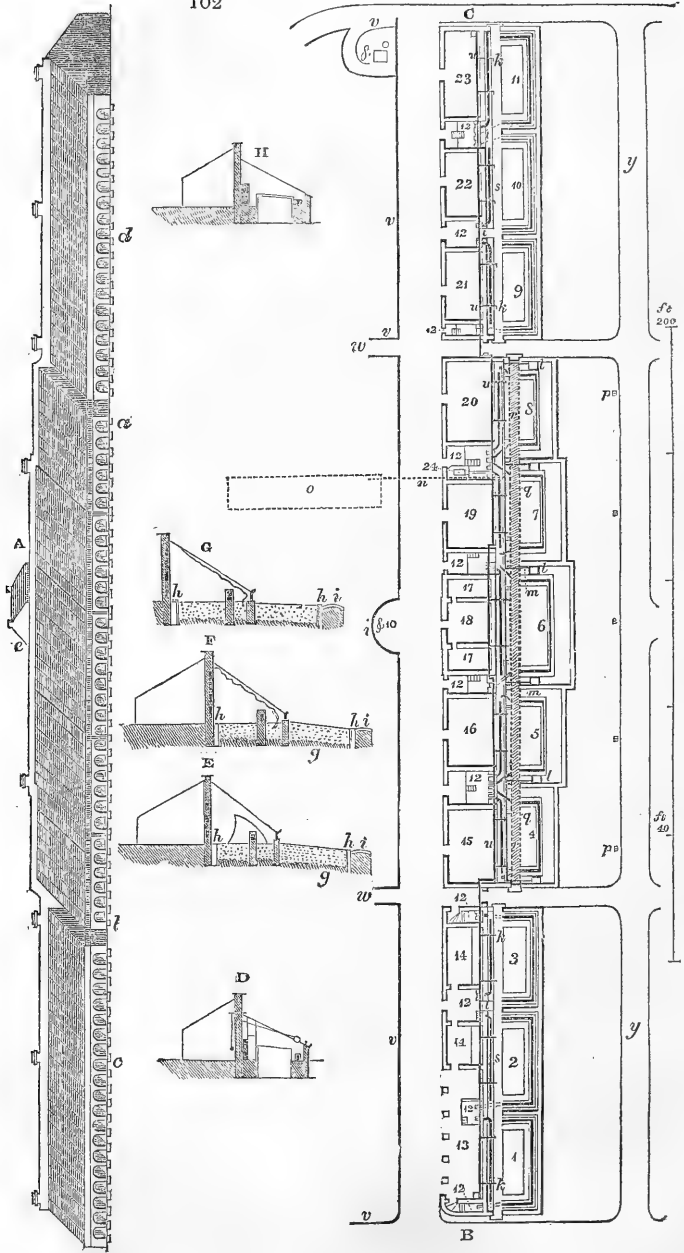

REFERENCES TO THE PLAN OF THE FORCING-HOUSES AT SYON. (*fig.* 102.)

A, The general elevation; *ab*, the two peach-houses and three vineries; *cd*, the pineries and general forcing-houses; *e*, the gardener's rooms, and garden-library.

B C, The general ground-plan.

1, 2, 3, Pine-pits, with iron and copper roofs, ends, and doors, the section of which may be seen at D. In this section will be observed the indication of the canvass blind described p. 510. On the back flue of these houses, cucumbers are grown in boxes all winter, trained on wires down the roof.

4, Peach-house, with table-trellis, the section of which may be seen at E. *gg*, rubble stratum; *hh*, air-shafts to rubble stratum; *i*, garden-walk.

5, Early vinery, the section of which may be seen at F. *gg*, rubble stratum; *hh*, air-shafts; and *i*, garden-walk, as before.

6, Medium vinery, the section of which may be seen at G. *gg*, rubble stratum, &c., as before.

7, Early vinery; and 8, peach-house, with table-trellis; exactly the same as 4 and 5. — These five houses have the roofs, ends, and doors of iron and copper; all the trellises of iron, and also the cisterns and pathway. The roof trellis of the vineries is formed of wire in meshes, 24 in. by 8 in., the horizontal wires being 24 in. apart, and the sloping wires 8 in. The distance from the glass is 15 in. at the lower, and 16 in. at the upper part, of the slope.

9, 10, and 11, Pineries and general forcing-houses, the roof, ends, and doors of wood. Those structures having been newly erected on a different part of the premises, before Mr. Forrest came to Syon, it was judged best to retain them. Their section is shown at H.

12, 12, &c. The furnaces and stock-holes to all these houses. 13, Tanshed. 14, Mushroom-houses, with potting-benches in front. 15, Room for sashes. 16, Packing-room. 17, 17, Journeyman's bed-rooms, entered through the foreman's sitting-room. 18, Foreman's sitting and business room, with his bed-room and the garden-library over. 19, Room for shutters; sashes, mats, &c. 20, Room for flower-pots. 21, Potting-shed.

22, Room for keeping esculent bulbs and roots. 23, Tool-house.

24, Steam-boiler, a pipe from which leads the steam into every house, where it is delivered at pleasure, to fill the air with vapour, by the cocks *kkk*, &c. The advantage of having the steam-boiler heated by a fire which has no connection with the houses is, that steam can be applied in the summer season, when the fires are left off, without raising the temperature of the house. In the steam-boiler is a coil of pipe (p. 454.), connected at one end with the supply cistern, and at the other with the watering cisterns (*lll*), by which, at pleasure, hot water is conducted into the early forcing-houses, for tempering the cold water for use, during the winter season.

*lll*, &c. Cast-iron cisterns, to each of which is a supply-pipe *mm*, &c., which is connected with a main pipe *n* communicating with the grand tank of rain-water *o*; and also a hot-water pipe from the steam-boiler, for tempering the water during the winter season.

*pp*, Gratings of the air-shafts in the front border, immediately within the edging of the walks.

*q*, The same gratings to the air-shafts which are placed within the house at the bottom of the back wall.

*r*, Open cast-iron work, serving instead of pavement for the footpath, the whole on one level. *s*, Stone pavement, also all on the same level.

*t*, Doors into the back sheds for shifting, potting, &c., without taking the plants into the open air.

*u*, Main trunk of the steam-pipe, which serves incidentally to heat all the back sheds at pleasure. *v*, Box hedges, 2 ft. high, kept neatly clipped.

*w*, Walk to pits. *x*, Walk to melon-ground. *y*, Level front walk.

*z*, Main kitchen-garden walk, forming the approach to the forcing-range from the pleasure-ground.

*z*, Pumps with troughs.

## PART II.

## REVIEWS.

ART. I. *Transactions of the Horticultural Society of London.*  
Vol. VII. Part III.

(Completed from p. 299.)

49. *Upon a Mode of covering the naked Branches of Fruit Trees with new Wood.* By Samuel Spyvee Street, Esq., of Penryn, Cornwall.

WALL and espalier trees often become naked for a foot or two on each side of the main stem; but by ringing the lateral branches at 6 or 8 in. distance from the main stem, young shoots will be thrown out between the ring and the stem, which may be trained over the naked parts at pleasure.

50. *An Account and Description of the Species and most remarkable Varieties of Spring Crocuses, cultivated in the Garden of the Horticultural Society.* By Joseph Sabine, Esq. F.R.S. Secretary.

Hardy bulbous plants have been the object of Mr. Sabine's attention for nearly 30 years; he had formed an extensive collection of them, and, with that devotion to the Horticultural Society for which he has ever been distinguished, he presented the whole collection to the experimental garden at Kensington, in 1818. This collection included a very extensive assortment of spring crocuses procured from all quarters, to which additions have since been made.

Linnæus, in 1753, had only one species of *Cròcus*, *C. sativus*, considering the autumnal or saffron crocus (*C. officinàlis*), and the spring crocus (*C. vérnus*), as varieties. Willdenow, in 1797, made Linnæus's two varieties species, calling the autumnal crocus *C. sativus*, and the spring one *C. vérnus*. The crocus has been found wild in the southern parts of Europe, and in the temperate regions of Asia; and botanical travellers "have proved the existence of many kinds of *Cròcus* in a wild state." Most of these remain to be described, and a monograph is preparing by M. Gay of the garden of

the Luxembourg, Paris. Those described by Mr. Sabine, "may all, with the exception of *Cròcus pusillus* and of the native British *C. vérnus*, be considered as garden productions."

[As this paper is to be completed in the succeeding part, we cannot proceed with advantage to the reader till that part appears. A coloured plate of 7 species and 12 varieties, grouped together in a bouquet, is given; but we are compelled to say that we think the arrangement of this bouquet of the same character as that of the chrysanthemums, georginas, and other flowers, exhibited by the Society in the garden at Chiswick, or at the exhibitions in Regent Street. We have repeatedly, both verbally and in this Magazine, pointed out the sameness produced by this indiscriminate mixture of colours; but it seems to produce no effect. Certain minds cannot acknowledge themselves in the wrong; we are satisfied, however, of the truth and good taste of our position, and shall endeavour to maintain it, not caring for immediate results, but perfectly confident that, like every other truth, it will finally prevail. Lest we should be mistaken, we may state that the bouquet consists of 19 crocuses of three fundamental colours, purple, yellow, and white. These colours are mixed indiscriminately. For instance, the two darkest purple varieties (*C. vérnus inflatus* and *C. vérnus Sabinus*) are put, the one at the lowest point on the left, and the other at the highest on the right, of the bouquet; the two darkest yellows (*C. sulphureus concolor* and *C. lagenæflòrus*) are also placed as far apart from each other as possible; and in the same manner the two whitest varieties (*C. vérnus álbus màjor* and *C. vérnus Andersòni*) are disposed. Now what we maintain is, that, both in a botanical and picturesque point of view, those colours or sorts which are most like each other should be put nearest together; not indeed formally, in heavy lumpish masses, but in masses broken off and blended with those adjoining, in that style which is at once painter-like, most favourable for botanical comparison, and most natural. Had this been done, instead of a spotted bouquet, a sort of hodge-podge of colours, which leaves a confused impression; we should have had a mass, one side of which was white, blended into the yellow sorts occupying the middle, and these again losing themselves in the dark sorts of different shades of purple completing the other side. No one could have looked at such a bouquet without having received a distinct impression, which he could readily remember; but has any one a distinct impression of the bouquet of Mr. Sabine? The *Transactions* are, doubtless,



seen by a number of lady-artists in the country, we appeal to them for the truth of our remarks; we appeal also to the florist and to the botanical reader. We should wish to hear what can be said on both sides of the question.

---

ART. II. *Catalogue of Works on Gardening, Agriculture, Botany, Rural Architecture, &c., published since August last, with some Account of those considered the most interesting.*

### BRITAIN.

*Curtis's Botanical Magazine, or Flower-Garden displayed; New Series.*  
 Edited by Dr. Hooker. In 8vo Numbers, monthly. 5s. 6d. col.; 3s. plain.

#### No. XXXI. for July, contains

2918 to 2925. — *Clárkia pulchélla* (Vol. III. p. 197. fig. 56.). — *Nicotiàna acuminàta*, the *Petùnia acuminàta* of Graham, in *Ed. New Phil. Journ.*, July, 1828, p. 578. "Petùnia seems to differ from *Nicotiàna* in little else but its irregular corolla; which being wanting here, I have reluctantly differed from my valued friend, who has hitherto alone described this species, in considering it not to be of that genus." — *Begònia semperflòrens*. — *Ligústrum nepalènsè* var. *glàbrum*. A considerable tree in the mountains of Nepal; here a green-house shrub, with white sweet-smelling flowers from April to June. — *Acàcia lanígera*. — *Erígeron glabéllum*; *Compòsitæ*. A perennial, from the plains of Missouri, with purple flowers from September to Christmas. First raised in the Glasgow botanic garden in 1828. — *Gília grácilis*. — *Clerodéndron emirnénsè*; *Verbenàcæ*. A branching shrub, from the province of Emirne, in the interior of Madagascar. Discovered by Professor Bojer, and seeds sent by C. Telfair, Esq., to Robert Barclay, Esq., of Bury Hill, where it blossomed in 1824.

#### No. XXXII. for August, contains

2926 to 2931. — *Bonàtea speciòsa*. (fig. 103.) A rare orchideous plant from the Cape of Good Hope, presenting a very complicated form of flower. Sent by Mr. Aiton to the Edinburgh botanic garden. — *Maxillària Harrisòniæ*. A beautiful orchideous epiphyte, named "in compliment to Mrs. Arnold Harrison of Aigburgh." — *Acàcia Oxýcedrus*. — *Céstrum alaternòides*. A stove shrub from Trinidad to the Glasgow botanic garden. — *Stenochilus viscòsus*; *Myoporinæ*. A New Holland shrub, with ovato-lanceolate coriaceous leaves, and large, yellow, ringent, curved flowers, introduced by F. Henchman, Esq. F.L.S. H.S. &c., and by Mr. Mackay of the Clapton nursery, "kindly communicated to the royal botanic garden of Edinburgh." — *Eulòphia (eulophos)*, well crested; on account of the crest of the labellum) *streptopétala*. (fig. 104.) A very handsome orchideous epiphyte; and we are not sorry



to see so many additions to this beautiful and singular order of plants, because they thrive in the back parts of stoves, and under the shade and drip of other plants, where scarcely any thing else would grow, and thus, under judicious selection and management, every spare hole and obscure corner of a tropical hot-house may be rendered highly interesting.

This plant was received by Professor Graham of the Edinburgh botanic garden, "where so much has been done lately to extend the high reputation of that noble collection."

No. XXXIII. for September, contains

2932 to 2937. — *Pontederia* (Julius Pontedera, Prof. Bot. at Padua in 1700) *azùrea*; 6 and 1, and *Pontedèra*. A floating stove aquatic from South America, introduced to Kew from Brazil a few years ago, and generally known under the name of *P. crássipes*. — *Mitèlla pentándra*; *Saxifràgea*. A hardy perennial from the Rocky Mountains of America, by Mr. Drummond, to the botanic gardens of Glasgow and Edinburgh. — *Dràba aùrea*. From North America by Mr. Drummond. — *Tradescántia crássula*. From Berlin to the Edinburgh botanic garden. Stove; white flowers. — *Andrómeda hypnòides*. "This extremely pretty little plant was introduced from Canada, by Mr. Blair, into the extensive and interesting collection of Mr. Cunningham, at Comely Bank, near Edinburgh, in 1826; and this enterprising cultivator had the satisfaction of seeing the plant come into flower in his garden in May last: the first time it had been seen in Scotland, and after it had been lost in England. Pursh and Nuttall confine the American station of this plant to the north-west coast; but this Mr. Blair did not visit. It is, therefore, more diffused in the northern parts of America; and, as it is a most abundant plant in the north of Europe and Asia, it is extremely probable that it may one day, in the north of Scotland, reward the labour of some British botanist; for, unless when it is in flower, it may be very easily overlooked." (*Graham.*) — *Orobis stipulàceus*. From the Glasgow botanic garden, and supposed to have been introduced there by accident, from North America. Resembles *O. setifórmis*, but is rather larger.



*Edwards's Botanical Register.* Continued by John Lindley, F.R.S. L.S. &c. Professor of Botany in the London University. In 8vo Numbers, monthly. 4s. coloured.

No. V. for July, contains

1247 to 1255. — *Echevèria* (*M. Echevèria*, a skilful botanical painter, employed on the *Mexican Flora*) *gibbiflòra*. "A very handsome succulent plant, belonging to a small tribe peculiar to the Flora of tropical America. It lives readily in the green-house, where it flowers in November and December." Raised in the Horticultural Society's garden from seeds received from Mr. James M'Rae. — *Pyrus sinénsis*. "This, the Chinese Pear, Sandy (from the grittiness of its fruit) Pear, or Snow Pear, as it is indiscriminately called, is a species at present very little known in Europe. It differs from the European pear in having longer and greener branches; larger, more lucid, and almost evergreen leaves; insipid, apple-shaped, warted, very gritty fruit; and a calyx, the inside of which is destitute of the down that is found in all the varieties of the European pear." Worth notice as an ornamental plant. — *Oxalis tortuòsa*. From Chile, by Mr. James M'Rae, in 1825, and here grows in the green-house, with a tortuous scaly stem, to the height of a foot or thereabouts, producing yellow flowers in June. — *Polýgonum injucúndum*, Unattractive Polygonum. An annual,

from the Cordilleras to the Horticultural Society, where it is cultivated in the frame. — *Lupinus micranthus*. Not to be compared, in point of beauty, with such fine species as *L. perennis*, *ornatus*, and others, brought over by Mr. Douglas, but nevertheless interesting, as an addition to the number of species of annual lupines. — *Begonia villosa*. A stove shrub or plant, of the easiest culture. — *Azalea pontica* var. *sinensis*. A fine plant, received from China at different times, both by Messrs. Loddiges of Hackney, and Mr. Wells of Redleaf, with each of whom it has now produced its flowers. "It is one of the most showy plants we know, and is, upon the whole, decidedly superior to the now common *Azalea pontica* of Asia Minor. Probably quite hardy."

No. VI. for August, contains

1254 to 1261. — *Viola præmorsæ*. Yellow flowers; and common, "according to Mr. Douglas, in dry upland soils, under the shade of solitary pine trees on the banks of the Colombia, and the plains of the river Aguilar in California, flowering in April. With us it is an exceedingly pretty perennial, hardy, and growing readily among rockwork, on the north side of large stones. — *Teucrium orchideum*. A half hardy green-house, herbaceous under-shrub, with whitish violet or purple flowers, in the open border, in July, August, and September. It is a native of Chile, whence seeds were brought to the Horticultural Society, in 1826, by Mr. James M'Rae, who found it common in the neighbourhood both of Conception and Valparaiso." — *Sterculia lanceolata*; *Sterculiaceæ*. A small tree, with tapered smooth branches, and oblong lanceolate leaves; "a native of China, whence it was brought to the Horticultural Society, in 1822, by Mr. John Potts, one of their collectors. It is a stove tree, producing its inconspicuous dull-red flowers in May and June. The foliage is remarkably like that of *Reevesia chinensis*, and constitutes its only claim to notice as an ornamental garden plant, unless it should hereafter produce ripe fruits, which, according to Cavanilles, are bright scarlet, with black round seeds that stick to each side of the follicle when it opens." — *Hosackia* (dedicated by Mr. Douglas to David Hosack, M.D. F.R.S., &c., of New York, a gentleman to whom the scientific men of North America owe the same gratitude as those of England did to Sir Joseph Banks) *bicolor*; *Leguminosæ Loteæ*. (*fig. 105.*) A pretty perennial plant, with yellow and white flowers, "found by Mr. Douglas in overflowed meadows between Fort Vancouver and the grand rapids of the Colombia. It is quite hardy, and easily increased by seeds." The description is by Mr. George Bentham, a near relation of the celebrated jurist; and thus we associate two names of men of liberal and enlightened minds, of no sect or party, or country, but feeling intensely interested in the whole of human nature, and the advancement of civilisation and happiness in every part of the world. It is pleasant to find a young man like Mr. Douglas indicating a sympathy with such characters as Dr. Hosack, and gratifying to see Mr. Lindley, whom we consider as the rising sun of the botanical world, and destined one day to be the Robert Brown of the age, doing justice to all parties, and not forgetting Sir Joseph Banks, one of the greatest names among the patrons of science. — *Persea gratissima*; *Laurinææ*. "The Avocado, or, as it is often called, Alligator, Pear, is one of the most esteemed fruits of the West Indies. In this country it is only cultivated in the stove, of which it is one of the rarest species. Our drawing was made in the princely garden of His Grace the Duke of Northumberland at Syon, an



105

establishment which, whether we view it with regard to the botanical or horticultural interest that attaches to it, promises to be soon the most important, as it is already the most magnificent, in Europe. Sir Hans Sloane thus speaks of the Avocado: — “This tree grows commonly to the size of our largest apple trees in Europe, and spreads pretty wide at the top. The branches are very succulent and soft, the leaves oblong and veiny, and the fruit of the form of a pear; but the pulp is covered with a tough skinny coat, and contains a large rugged seed, which is wrapped up in one or two thin membranous covers. The fruit of this tree is one of those that are held in the greatest esteem amongst all sorts of people in these colonies. The pulp is of a pretty firm consistence, and has a delicate rich flavour: it gains upon the palates of most people, and becomes soon agreeable, even to those who cannot like it at first; but it is so rich and mild, that most people make use of some spice or pungent substance to give it a poignancy; and, for this purpose, some make use of wine, some of sugar, and some of lime juice, but most of pepper and salt. Most sorts of creatures are observed to feed on this fruit with pleasure; and it seems equally agreeable to the horse, the cow, the dog, and the cat, as well as to all sorts of birds, and, when plenty, makes a great part of the delicacies of the negroes. The tree requires some care, a rich soil, and a warm situation, to raise it to perfection. It was first introduced from the Continent in 1759. — *Búddlea heterophýlla*. A handsome stove plant, presumed to be from South America. — *Pentstemon confertum*. “A very common plant, with greenish white flowers, according to Mr. Douglas, found in open places, in mountainous pine woods, in dry sandy soils, between Salmon River and the Kettle Falls on the Colombia, in 48° N. lat.; also in the valleys of the Rocky Mountains, in similar soils, at an elevation of 7000 ft. above the level of the sea. Flowering in July and August. It was introduced by its discoverer in 1827; in the autumn of which year it flowered in the garden of the Horticultural Society, where our drawing was made. It is by no means one of the handsomest of the genus; but it is a truly distinct species. A hardy perennial, propagated by seeds and division of the roots. It will grow in any common garden soil.” — *Lówea* (named in compliment to the Rev. Mr. Lowe, travelling Bachelor of the University of Cambridge; a gentleman now resident in Madeira, from whose botanical investigations of that island we expect important results) *berberifolia*; *Rosàcææ*. (*fig. 106.*) “This rare plant is a native, exclusively, of a few districts in the north of Persia, and of the Desert of Songari in Chinese Tartary. From the latter place we possess specimens collected by Shankin, an officer employed by the Russian government in surveying the province; and of the former, the plate that accompanies this article is a representation. It was taken from a plant that flowered in August, 1828, in the garden of the Horticultural Society, where it had been raised from seed sent home by Sir Henry Willock. The Persian plant differs in some respects from the Songarese one, especially in being more glaucous; and the plants raised from the Persian seeds of Sir H. Willock varied among each other in several slight particulars; none of which, however, were of any interest in a botanical point of view. The two most important topics connected with it relate, first, to its genus; and, secondly, to its cultivation. In the latter respect, no more appears to be known now than was known upon its first introduction. It resists cultivation in a remarkable manner, submitting permanently neither to budding, nor grafting, nor laying, nor striking from cuttings; nor, in short, to any of those operations, one or other of which succeeds with other



plants. Drought does not suit it; it does not thrive in wet; heat has no beneficial effect; cold no prejudicial influence; care does not improve it; neglect does not injure it. Of all the numerous seedlings that were raised by the Horticultural Society from Sir H. Willock's seeds, and distributed, scarcely a plant remains alive. Two are still growing in a peat border in the Chiswick garden, but they are languishing and unhealthy; and we confess that observation of them in a living state, for nearly four years, has not suggested a single method of improving the cultivation of the species. As to its genus, it is well known that, since the days of Linnæus, the characters of the genera of flowering plants have been exclusively taken from the organs of fructification, while those of vegetation have been rigorously excluded. This has arisen from the former having been supposed, in all cases, more constant in their modifications, and less subject to variation than the latter. No other reason can be assigned for the value thus exclusively ascribed to the organs of fructification. It is, however, time that botanists should disembarass themselves of this ancient prejudice, and admit publicly that by which they are constantly influenced in private — *that important modifications of the organs of vegetation are sufficient to divide into genera species which do not essentially differ in the organs of fructification.* Of this the Indian cypripediums are one instance, the genus *Negúndium* is a second, and the subject of this article is a third. The structure of its flower is in every respect that of a rose; but its foliage is not even that of a rosaceous plant, there being no trace of stipulæ. The simple leaves are not analogous to the terminal pinna of a rose leaf, for there is no trace of the articulation upon their petiole, which is required to indicate a reduction of a compound leaf, as we find in *Bérberis*; neither can they be considered confluent stipulæ, for their vernation is not what would be found under such circumstances, but precisely that of an ordinary leaf.

*No. VII. for September, contains.*

1262 to 1268. — *Pentstemon glandulòsum.* A handsome and strongly marked perennial species, with purplish-red flowers, from the rocky channels of mountain torrents, in latitude 47°, North America. Introduced to the Horticultural Society by Mr. Douglas, in 1827. "Of the various discoveries that have resulted from the journey of Mr. Douglas to the north-west coast of America, the new species of *Lupinus* and *Pentstemon* will probably be found the most interesting to the cultivator, in consequence of the great beauty and variety of their forms, and their hardy habits. Natives of a country, the mean temperature of which is supposed to be very like that of Great Britain, they seem as well adapted to our climate as to their own, and flourish as gaily on the fertile margin of the Thames as on the rude banks of the Colombia and the Multnoma. The following list of the pentstemons that have been found by Mr. Douglas, and which are now growing in the garden of the Horticultural Society, will show the extent to which our gardens have been enriched with them: —

<i>P. glandulòsum.</i>	<i>P. Scoulèri.</i>	<i>P. venústum.</i>
<i>triphýllum.</i>	<i>ovàtum.</i>	<i>pruinòsum.</i>
<i>confértum.</i>	<i>speciòsum.</i>	<i>deústum.</i>
<i>Richardsoni.</i>	<i>acuminàtum.</i>	<i>attenuàtum.</i>

*Ribes cereum.* A small hardy shrub, from dry rocks in the north-west of North America, by Mr. Douglas — *Argemone grandiflora.* An annual from Mexico, with white flowers from June to September. "One of the multitude of fine plants with which our gardens have been enriched by the importations of Robert Barclay, Esq., of Bury Hill. It is one of the most ornamental hardy annuals we are acquainted with, and far superior to any other of the poppy tribe, except *Eschscholtzia californica.*" — *Heliánthus lenticulàris.* A handsome annual sunflower, attaining the height of 6 ft.,

and with much smaller flowers than those of *H. ánnuus*. From North-west America, by Mr. Douglas. “ We are informed by its discoverer that it is a variable plant, abounding over the greater part of the temperate countries situated in the interior and western coast of North America. In sandy parched ground it is a diminutive annual, scarcely a foot high; while, on the banks of streams, or on the margin of lakes, particularly in deer or buffalo ground, it attains the height of 6 or 8 ft. The native tribes that inhabit the interior of North California apply the grains to the same purpose as that for which, we are informed by Nuttall, the Indians of the Missouri use *H. tubæfórmis*. They collect them in the autumn, and dry them on heated stones, or in wooden troughs, with small embers, stirring them with a stick to prevent their burning. When dried, they are panned, and made into a sort of cake which is not unpleasant. — *Scóttia angustifólia*; *Leguminósæ Lótææ*. A beautiful addition to an interesting genus raised at the Clapton nursery, from New Holland seeds. Twiggy, linear leaves, and solitary flowers pink and yellow. — *Caméllia japónica punctàta*, Dotted Japan Camellia, or *Gray's Invincible Camellia*. Raised in 1824, by Mr. George Press, gardener to Edward Gray, Esq. F.H.S, Harringay House, Hornsey. (Vol. II. p. 358.) — *Pimelèa húmilis*; *Thymélexæ*. A low green-house shrub from the Comte de Vandes's, at Bayswater.

*Botanical Cabinet*. By Messrs. Loddiges. In 4to and 8vo Parts, monthly. Large paper, 5s.; small paper, and partially coloured, 2s. 6d.

*Part CXLVII. for July, contains*

1461 to 1470. — *Azàlea índica purpúrea*. An elegant green-house shrub, introduced from China, by Mr. Brookes of the Ball's Pond Nursery, in 1819. — *Scilla bifólia*. — *Caméllia japónica Knightii*. A pretty variety raised from seed by Mr. Joseph Knight of the Exotic Nursery, King's Road. — *Andrómeda calyculàta*. — *Dorónicum caucásicum*. A charming, little, very hardy, herbaceous plant, with yellow flowers in March and April. — *Erìca Archeriàna*. *E. spársa*. — *Aspidístra lùrida*. (*fig. 107.*) A most singular-looking stove-plant from China; “ from a sort of knobby root, producing three or four upright leaves, 8 or 9 in. in length, and, in the months of March and April, a number of dingy-coloured flowers lying on the ground.” *Acàcia ornithóphora*. — *Dodonæa attenuàta*. A New Holland shrub, lately introduced, of easy culture, but no great beauty.



*The British Flower-Garden*. By Robert Sweet, F.L.S. &c. In 8vo Numbers, monthly. 5s.

*No. II. for July, contains*

5 to 8. — *Prímula pusílla*. A pretty little tufted stemless plant, becoming dormant in winter. — *Ibèris carnòsa*. A pretty little annual or biennial plant, raised by the gardener of P. B. Webb, Esq., from seeds sent home by his master from the mountains of Granada in Spain. — *Phlóx procúmbens*. A beautiful and very distinct species from North America to Bury Hill, producing bluish purple flowers in May. “ It appears to be of very free growth, producing numerous roots, some of which strike root as they trail on the ground, so that it may be easily increased; it succeeds well in a light sandy soil, or a mixture of sandy loam and light peat or decayed leaves will suit it very well; it will probably require a little protection in winter, such as a garden pot placed over it in severe frost, but exposing it as much

as possible at other times; it also thrives and flowers well in a small pot, in which it may be preserved in a frame in winter, if found not to be sufficiently hardy; at present it is very rare, and we do not know that it is for sale at any nursery, but it will soon become plentiful, and, of course, will be cultivated in every collection of hardy plants. Cuttings of it will root readily, planted under hand-glasses; it may also be increased by dividing at the root. — *Philadelphus grandiflorus*. A handsome dwarf bushy shrub, attaining the height of 6 to 8 feet, producing large pure white flowers, scarcely scented, in May and June. It thrives well in the shrubbery in the common soil, and is generally increased by layers, or suckers from the root; but ripened cuttings, of one year's growth, will root freely if taken off as soon as the shoot is hardened, and planted in a shady situation and well watered."

*No. III. for August, contains*

9 to 12. — *Verbena chamædryfolia*, the *V. Melindres* of *Bot. Reg.* (*Gard. Mag.* p. 106. 229.) "Certainly one of the finest and most splendid plants that have been introduced to our collections for some time past, particularly as it is so easily cultivated, and propagates so freely from cuttings, thriving well in any rich light soil; and, when planted out in a bed or border, nothing can make a more brilliant appearance."

*Rhododéndron Mortèrii*. Handsome; from the "nursery of Messrs. Whitley, Brames, and Milne, at Fulham, who received it from the Continent under the specific name that we have adopted; it is of hybrid origin, and is intermediate between *R. calendulæceum* and one of the red varieties of *R. nudiflorum*. Several other hybrid species and varieties were received by them at the same time, but none more interesting than the present; another variety which we have distinguished under the name of *præstans* was in flower at the time, and was sent by the name of *Azalea præstantissima*. The different hybrid productions and varieties that are now raised from seed, and will be in a few years, will, we have no doubt, bring this handsome tribe into great repute. We saw them flowering in great perfection at Messrs. Whitley and Co.'s nursery, at Fulham, this summer; and we also had the pleasure of seeing a splendid collection at Mr. Waterer's nursery, at Knap Hill, in Surrey, where many of them have almost attained to the size of trees, and are growing in the common soil of the nursery, which is of a sandy peat, as luxuriantly, and perhaps more so, than in their native wilds. Mr. Waterer has also succeeded in raising many fine new varieties, and hybrid productions between most of the old ones, the flowers of which are finer than the old varieties, and of every shade of colour between white, scarlet, purple, and yellow; they all thrive well in the open air in a sandy peat soil, or a light sandy loam suits them as well. They are generally increased by layers, but new varieties are only to be obtained from seed."

*Iris nepalensis*. Beautiful and singular. Flowered for the first time, in the latter end of June last, in the Fulham nursery; flowers of a delicate blue; roots fleshy, resembling those of a *Hemerocallis*; stem leaves inflated a little at the base. — *Lupinus versicolor*. A handsome upright frutescent species. From Mexico to the Bury Hill garden, where it attained the height of 2½ ft. by the side of a wall in the flower-garden.

*No. IV. for September, contains*

13 to 16. *Phlòx cordata*. A handsome rather tender species, sent by Mr. T. Nuttall to the collection of Robert Barclay, Esq., of Bury Hill. — *Habránthus* (*habros*, soft and delicate, *anthos*, a flower) *robustus*; *Amaryllidææ*. Imported by Mr. Mackay from the neighbourhood of Buenos Ayres. "The present species flowers frequently, and at different times, through the summer and autumn; and is, therefore, a very desirable plant for the flower-garden; the flowers have also a pleasant scent, but not a powerful

one. The best situation for it is by the side of a wall, in a southern aspect, as it will not be so liable to be injured by too much moisture, as if grown in a more exposed situation; if several bulbs of it are grown together in the same place, a slight covering will do for the whole of them; and if the bulbs are planted about 6 in. deep, in a light sandy soil, they will not require the least protection, except the frost be unusually severe: if grown in pots, an equal mixture of turfy loam, peat, and sand, will be the best soil for them; and they will require the protection of frames, or of the green-house, in winter, giving them a good supply of water, when growing freely or coming into bloom; but they require very little when in a dormant state. They may be increased by offsets from the root, or by seed which will ripen in abundance, if a little care be taken to fertilise the stigma with the pollen when in bloom."—*Alstrœmèria psittacina*; *Amaryllidææ*. From Dr. Lehmann, through Mr. Hunnemann, to Robert Barclay, Esq., of Bury Hill. It is a native of Mexico, and thrives well in a warm border in the open air, with a little protection in winter. At Bury Hill it is planted in the open border in front of the hot-houses, where it does better than any of the other species. *A. hirtélla* and *Símsii* are now magnificently in flower with Mr. Sweet, for the fourth season, with no other protection than a single mat in severe frost.—*Fúchsia microphýlla*. A handsome bushy evergreen shrub from Mexico, covered with bright red flowers nearly all the summer. There can be no doubt but it will prove as hardy as *F. coccínea* and *F. grácilis*, which endure the winter well in a sheltered situation by the side of a wall, where, if they are protected by a mat or any other slight covering in severe weather, they will pass the winter uninjured, and produce an abundance of flowers all the summer; and if not protected at all, they will still survive, though killed down to the ground; in spring they push out strong young shoots, which soon attain a good size, and become loaded with flowers.

*Geraniaceæ*. By Robert Sweet, F.L.S. &c. In 8vo Numbers, monthly. 5s.

*Nos. XIV. and XV. for August and September, contain*

55 to 60.—*Pelargónium melanchólicum*, *intertíctus*, *exquisítum*, and *Annesleyànum*. The last species a hybrid of unknown parents, "raised by L. Weltje, Esq., of Hammersmith, who named it in compliment to Miss Annesley of Bletchington, Oxford, a lady much attached to this handsome tribe of plants. *P. mirábile*, *Kenríckæ* (in compliment to Mrs. Kenrick of Broome, Dorking, in whose collection it was raised from seed), *Yeatmaniànum* (in compliment to Miss Jane Yeatman of Dorchester, by whom it was raised), and *dissímile*.

*Cistíneæ*. By Robert Sweet, F.L.S. &c. In 8vo Numbers, every alternate Month. 3s.

*No. XXV. for July, contains*

97 to 100.—*H. arábicum*. A handsome and very distinct species with saffron yellow flowers and small hairy leaves, requiring the protection of a frame.—*H. diversifólium* var. *múltiplex*. A handsome double variety from Lee's nursery, with variable narrow hairy leaves and dark purplish red flowers nearly all the summer.—*H. caroliníanum*. A beautiful species, requiring to be grown in peat. Leaves petiolate, obovate, and hairy; flowers pale yellow—*H. lanceolàtum*, narrow leaves and white flowers. All these species are propagated by cuttings, and are in every respect of the easiest culture.

*The Botanic Garden*. By B. Maund, F.L.S. &c. In small 4to Numbers, monthly. Large paper, 1s. 6d.; small paper, 1s.

*Nos. LVI. and LVII. for August and September, contain*

221 to 228.—*Potentilla spléndens*, *Aster Nòvæ Àngliæ*, and *Muscàri comòsum*. *Campánula nítida*; a desirable little subject for cultivation either



in the margins of borders or in pots. *Narcíssus Jonquílla*, *Coronílla vâria*, *Lêdum latifolium*, and *Campánula speciôsa*.

The author tells his correspondents, on the cover, that in January next he will give them such directions for propagating *Pædônia Moútan* as "will enable the nurseryman to sell those plants at one shilling each, with ample profit, for which he must now, from the tedious method of propagation, charge seven shillings and sixpence." This announcement, we hope, will set young gardeners to work in speculating on what may be Mr. Maund's method. Is it by ripening seeds; or by ringing under every bud, and then laying down the whole plant; or by inserting buds in the common pæony?

*The Supplement to English Botany*. By J. D. C. and C. E. Sowerby. In svo Numbers, monthly.

"Fifteen years have now transpired since the *General Index* appeared, which formed the concluding part of Smith and Sowerby's *English Botany*. Often during that period, it was in the contemplation of the proprietors of that work to publish a supplement of those plants which had been discovered to be British, since its termination. The death of Mr. Sowerby in 1822, and the recent loss of the learned president of the Linnean Society, immediately after he had put the finishing touch to the last and most valuable of his writings, *The English Flora*, effectually prevent the original conductors from having any share in the continuation. Already a number of drawings have been prepared, and it is now the intention of the two sons of the late Mr. Sowerby, Messrs. J. D. C. and C. E. Sowerby, to publish these and figures of other plants necessary to the work, as supplementary volumes; which, when completed, will at least comprise every known *British Phænogamous Plant*. The proprietors calculate upon extending the work to two more volumes; by which means they will be able to introduce likewise such new *Cryptogamic Plants* (exclusive of the *Fúngi*) as have not been introduced in Dr. Greville's *Cryptogamic Flora of Scotland*. The Messrs. Sowerby will be grateful to any botanist who will supply them with living native specimens of plants, suited to the work, addressed to them at No. 2, Mead Place, Westminster Road, Lambeth."

*No. I. for July, contains*

2595 to 2597. — *Isnárda palústris*; 4 and 1, and *Onagrâriæ*. Found by Mr. Borer, growing in a pool at Buxtead, Sussex. — *Rôsa Sabîni*. Found wild in various places in Scotland and the North of England. — *R. sarmentâcea*. A common briar in hedges and thickets. — *O'phrys arachnites*. From the chalk downs of South Kent, between Folkstone and Sittingbourne. — *Verucâria olivâcea*; *Cryptogâmia Lichènes*. On the smooth trunks of thorns, ash trees, &c. — *V. rhyphónta*. An obscure production on the trunks of young trees in the New Forest, Hampshire, and in Sussex. — The engravings are beautifully executed, but we think the letter-press ought to have contained the natural order, as well as the class and order of Linnæus.

*The Florist's Guide and Cultivator's Directory, &c.* By Robert Sweet F.L.S. &c. In svo Numbers, monthly. 3s. coloured; 2s. plain.

*No. XXVI. for August, contains*

101 to 104. — *Cremona Ranunculus*. From the collection of Richard Percival, Esq., of Highbury Park, Islington — *Juno Georgina*. Raised from seed by W. Wells, Esq., of Redleaf [altogether the most romantic, beautiful, and highly enriched small place we have ever seen in this or any country], near Tunbridge Wells. — *Emperor of Austria Tulip*. From the collection of Mr. Pile of Cambridge Road, Mile End. Price 1l. — *Ford's Prince George Pink*. From the collection of Mr. Hogg of Paddington Green.

## No. XXVII. for September, contains

105 to 108. — Moore's Violet Auricula. From the "choice collection of J. P. Morgan, Esq., of Formosa Cottage, Holloway; a gentleman who cultivates a fine collection of the choicest flowers with great success." — Lord Holland Tulip. "A grand flower, like the noble-minded individual after whom it is named." From the fourth row of the tulip bed of W. Strong, Esq. — *Croësus Picotee* Carnation; "from the collection of Mr. T. Hogg of Paddington Green, who possesses the finest collection of picotees that is to be seen at any one place in this kingdom."

*Medical Botany, &c.* By John Stephenson, M.D., and James Morss Churchill, Esq., Surgeon. In 8vo Numbers, monthly. 5s. 6d.

## No. XXX. for June, contains

117 to 121. — *Prunus Laurocérusus*. The distilled water of this plant, the virtues of which depend on the prussic acid that it contains, is a deadly poison, taken internally, or applied to wounds. The oil of laurel is also a virulent poison. Like various other poisons, it is considered an important medicine. It is a narcotic, but has not the property of lessening pain, nor of procuring sleep, like opium; nor of controlling the pulse like *Digitális*; but it soothes the stomach when in a state of morbid irritability. — *Prunus doméstica*. The dried fruit is gently laxative. — The fruit of the sloe (*P. spinòsa*) is a powerful astringent; the juice is largely used for adulterating port wine, and the leaves for adulterating tea. — *Erythræa Centaurium*; *Gentiânæ*, Common Centaury. The flowers form a useful stomachic, and were formerly used instead of cinchona. — *Rhámnus cathárticus*. The juice of the berries is a violent griping drastic purgative, more used by the veterinary surgeon than the physician. From the inspissated juice of the ripe berries, with a very small addition of alum, is obtained that green colour so well known by the name of *vert-de-ressie*, or sap-green. "Sometimes it is prepared by adding eight pounds of lime-water to twelve pounds of the expressed juice, and six ounces of gum arabic; which mixture is afterwards evaporated into the consistence of an extract, and dried for use." — *Ulmus campéstris*. The decoction of elm bark has been recommended in cutaneous diseases. "The bark of the elm, dried and ground to powder, has been mixed with meal, in Norway, to make bread in times of scarcity. The leaves also afford a pleasant nourishment to cattle, and in some parts of Hertfordshire the poor people gather them in sacks for this purpose."

## No. XXXI. for July, contains

121 to 125. — *Diósma crenàta*. The odour of this plant is very strong and peculiar, and incredible virtues are ascribed to it by the natives of Southern Africa. It appears to be an excellent aromatic stomachic, and it now ranks among the officinal drugs of the Dublin *Pharmacopœia*. — *Anchùsa tinctòria*, Dyer's Anchusa, or *Alkanet root*. Sometimes used as a dye stuff for reds and blues, and formerly administered as an astringent in medicine, but now neglected. — *Arnica montàna*; *Corymbíferæ*. The dried leaves are aromatic, and they excite sneezing. The root is bitter and accurate. It is given in fevers by some physicians on the Continent. — *Mýrtus Piménta*. The pimento, or allspice tree, is a native of South America and the West Indies, and succeeds very well in our stoves. In its native country it attains the height of 50 ft., retaining its leaves like an evergreen. It prefers a marly or chalky soil, and arrives at maturity at seven years from the seed. "The berries are picked from the branches in their green state, and are then laid on cloths spread on terraced floors. During the first and second days they are often turned, to be freely exposed to the sun. When they begin to dry they are frequently winnowed, and laid in cloths to preserve them from rain and dews, still being exposed to the sun every day, and removed under cover every evening, till sufficiently dry; which usually hap-

pens in twelve days, and is known by the darkness of their complexion, and the rattling of the seeds. At this time they appear wrinkled, and are of a very dark brown colour, in which state they are stowed in bags or casks for market. Some planters kilndry them, and it seems the most eligible method, when, from abundance of the crop, despatch and security against the rain are very essential.

“The more odoriferous and smaller the berries are, the better are they reckoned. The leaves and bark of the tree are full of aromatic inflammable particles, on account of which the growers are extremely cautious not to suffer any fire to be made near the walks, for, if it once catch the trees, they consume with great rapidity. Nothing, it is said, can be more delicious than the odour of the walks in which the trees are planted, particularly when they are in blossom. The friction of the leaves and smaller branches, even in a gentle breeze, diffuses a most fragrant scent through the air, which is thought to render it very salubrious.”

The berries smell and taste like cloves, juniper berries, cinnamon, and pepper, or rather a mixture of all of them, and hence they are named Allspice. They are employed under the latter name as a condiment, and in medicine as an adjunct to bitters in dyspepsia, and other affections — *Laúrus nóbilis*. The leaves and berries are carminative and sedative, but they are little used by modern practitioners.

*No. XXXII. for August, contains*

126 to 129. — *Laúrus Sássafras*. The bark and wood were formerly much celebrated in the cure of rheumatism and dropsy, but they are now only prized as stimulant and diaphoretic in the “compound decoction of sarsaparilla,” formerly called the “Lisbon diet drink.” — *Laúrus Cinnamómum* (for details of its culture and uses see p. 74.). “The cassia bud of commerce is the fleshy hexangular receptacle of the seed of the *L. Cinnamómum*. When gathered young, the receptacle completely envelopes the embryo seed, which progressively protrudes, but is continually embraced by the receptacle. The buds have the appearance of nails, with roundish heads of various sizes. If carefully dried, the receptacle becomes nearly black, and the point of the berry light brown. The seeds contract by drying, and often fall out: the receptacle is then cup-shaped. When kept long, they have a dirty brown colour, and possess very little of the flavour of cinnamon. By distillation, they yield an essential oil, not inferior to that of cinnamon bark.” — *Laúrus Cámphora*. The Japanese camphor is obtained by distillation from this tree, but the greater part of what is brought to Europe from Sumatra and Borneo is now fully ascertained to be the produce of the *Dryobálanops Cámphora*, a tree belonging to a distinct genus from the laurel.” — *Centaurea benedicta*. “This plant was formerly in such high repute, that it obtained the name of the ‘blessed thistle,’ and was given for the plague, worms, and numerous other diseases. If we are to believe Simon Pauli, it has no equal in healing obstinate ulcers, and even cancers; and Arnoldus de Villa-nova lauds it in the same extravagant manner. Notwithstanding that it is now little employed, it is a useful medicine; the strong decoction, or infusion, being capable, like the chamomile, of inducing vomiting. The infusion, less strong, taken while warm, produces a copious determination to the skin; while 6 drachms of the leaves, to a pint of cold water, forms an elegant bitter infusion, which is very efficacious in loss of appetite and dyspepsia. The dose in powder is from 10 to 40 grains; of the infusion, a wine-glassful every four hours.” — *Pistacia Terebínthus*. This tree affords the Chian or Cyprus turpentine, by wounding “the bark of the trunk in several places during the month of July, leaving a space of about 3 in. between the wounds: from these the turpentine exudes, and is received on stones, upon which it becomes condensed by the coldness of the night, so as to admit of being scraped off before sunrise. To free it from

extraneous substances, it is again liquefied by the sun's heat, and pressed through a strainer, when it is fit for use. The quantity produced is so very inconsiderable, that large trees, sixty years old, yielded only 2 lbs. 9 oz. 6 drs. : but in the eastern part of Cyprus and Chio the trees afford somewhat more, though still so little as to render its price high; on which account it is much adulterated with the other turpentine."

*No. XXXIII. for September, contains*

150 to 152. — *Pistacia Lentiscus*. The lentisc, or mastic tree, is a native of the south of Europe, and is very common in the Island of Scios, where its resin, called mastic, is chiefly obtained. The tree is there cultivated, and attains the height of 12 ft. The mastic is obtained by making transverse incisions in the bark about the beginning of August, from which the resin exudes in drops, and, hardening on the trees, or running down and concreting on the ground, is thence collected for use. In Turkey mastic is chewed for sweetening the breath, and strengthening the gums, whence the name. With us it is principally used by varnish-makers, and sometimes also as an astringent and diuretic. — *Origanum vulgare*. A mild stimulant and tonic, now in disuse. — *Origanum Majorana*. This is the sweet or knotted marjoram of the gardens and shops, and though chiefly employed to give relish to soups, runlets, and stuffings, yet the dried herb is considered sternutatory, and enters as an ingredient into the composition of some cephalic snuffs. — *Gentiana lutea*. The dried roots of this plant are imported from Germany, where they are cultivated in deep, rich, loamy soil, rather shaded than otherwise. Their medical properties depend on the substance called gentianine, which was discovered by M. Henry and M. Caventon at the same time, unknown to each other; a proof of the perfection to which the modes of vegetable analysis have of late years reached. Gentianine is one of the best bitters that can be employed in scrofulous affections. The root has been used from time immemorial as a tonic and febrifuge, and is only surpassed by the cinchonas. The infusion is most generally employed. It is remarked by the editors, that the cultivation of Yellow Gentian for sale to the apothecaries might be worthy of the attention of British market-gardeners, because, though not a native, it grows abundantly on the alps of Switzerland and Austria, the Apennines, the Pyrenees, in the mountainous forests of many parts of Germany, and in North America.

*The Pomological Magazine*. In 8vo Numbers, monthly. 5s. coloured; 3s. 6d. plain.

*No. XXI. for July, contains*

81. *The Sykehouse* (a village in Yorkshire) *Russet Apple*. "One of the most favourite of our russets, being remarkable among them for the clearness of its skin, the beauty of its form, and the excellence of its flavour." Hardy, a good bearer, ripening in the middle of winter, and among our best keepers.

82. *The Beachamwell Seedling Apple*. Raised several years ago by John Motteux, Esq., at Beachamwell in Norfolk. Hardy, a good bearer and keeper, and being of a small size is well adapted for a select collection. "No good garden ought to be without either this, the Golden Harvey, or the Court of Wick, all excellent substitutes for the delicate and unhealthy Golden Pippin."

83. *The Beurée d'Arenberg Pear*. "Truly characterised in the *Horticultural Transactions* as deserving 'to be placed at the head of all the pears in cultivation.' We certainly do not know any variety which can, upon the whole, be said to equal it; for its flavour is not only excellent, and its flesh tender and juicy, but it is hardy, a great bearer, and will keep till March." Usually cultivated as a dwarf on quince stocks, and trained against an east or west wall; but it succeeds perfectly well as an open standard. The

Gloux Morceaux, and the Colmar Deschamps, come very near it in good qualities.

84. *The Dutch Mignonne Apple.* Originally made known to English gardeners by Mr. George Lindley (*Hort. Trans.*, vol. iv. p. 70.), who procured scions from the garden of a Norfolk gentleman, by whom it had been imported from Holland. It is the Golden Reinette of Christ, and the Redorée of Mayer. "One of our very best winter fruits, being very hardy, a great bearer, keeping well till March, and retaining its beauty, along with its fine aromatic subacid flavour, till the very last."

*No. XXII. for August, contains*

85. *The Barcelona Pearmain.* A very good table apple, ripening in November, and keeping in perfection through December and January. "The singular speckled appearance of its surface distinguishes this from all other apples."

86. *The Old Nonpareil Apple.* "Perhaps the most general favourite with persons of every taste, on account of its peculiar, agreeable, brisk flavour, and the length of time it keeps." It is supposed to have been first brought out of France, and planted by a Jesuit in the time of Mary or Elizabeth. Nevertheless, Mr. Thompson, the foreman of the arboretum department, remarks "that the French do not seem to know what an English Nonpareil is, notwithstanding the publication of their countryman Du Hamel, because Noisette speaks of it as being very like the Reinette de Canada, only less in all its parts: and further, that it is probable that the Americans are unacquainted with it, for their great writer Coxe speaks of what he calls the Nonpareil in terms of no great praise, and figures it with a very short thick stalk, a character the reverse of that of the Nonpareil, which has uniformly a long slender stalk." A tender tree, but a good bearer, and the fruit keeps with care till May.

87. *The Scarlet Nonpareil Apple.* Very like the common in constitution and quality, but differing in colour, and scarcely keeping so long, being in greatest perfection in January and February.

88. *The Beurée Rance Pear.* Middle-sized; described by Dr. Van Mons as being the best of the late pears, keeping from December to May. The tree vigorous, a good bearer after a few years, but straggling and pendulous in its mode of growth.

*No. XXIII. for September, contains*

89. *The Forman's Crew Apple.* Raised in Glamorganshire, by Thomas Seton Forman, Esq., at Pennydarron Place, near Merthyr Tidvill. "One of the best table apples we have, combining the excellence of the Old Golden Pippin and Nonpareil. It keeps as late as any variety we know, and the tree is among the most healthy. It bears abundantly as an open standard, and is especially well adapted for cultivating as a dwarf, either upon paradise or crabstock."

90. *The Ross Nonpareil Apple.* Of Irish origin, and introduced to notice by Mr. Robertson of Kilkenny. "One of the few fennel-flavoured apples which are cultivated among us. Its good qualities are, that it is a great bearer on an open standard; that the tree is vigorous and healthy in all soils; and that the fruit, which is very handsome, keeps well till March or April, ripening in the end of November. The tree is round-headed."

91. *The Keen's Seedling Strawberry.* Large, good, and very prolific; forces better than any other, carries extremely well, and bears its fruit high enough above the earth to keep it free from the soil. Raised from the seed of Keen's Imperial by Mr. Michael Keen, a market-gardener at Isleworth.

92. *The Elton Cherry.* Raised in 1826 by Mr. Knight, from a seed of the Graffion or Ambrée Cherry, which had been fecundated by the pollen of the White-heart. "Its merit can scarcely be too highly spoken of. In flavour it is by many considered the most delicious of cherries." It is

heart-shaped, bright red on one side, and of a golden yellow on the other. "Its hardness and productiveness, whether upon a standard or against a wall, are ascertained." Ripe with the May Duke in the beginning of July. Trees strong and healthy, wood dark brown, shoots rather drooping, and leaves large and doubly serrated.

*Fleming's British Farmer's Magazine*, exclusively devoted to Agriculture and Rural Affairs. In 8vo Numbers, quarterly. 4s.

*No. XI. for May.*

A paper in this number, by Mr. Ayton of Hamilton, entitled "Instances pointed out of false Philosophy imposed on Farmers by Men of Science, deserves notice." To attempt to detect and refute all the errors that have been gone into, either by voluntary writers, or those who have been selected by public bodies to draw up statistical accounts of districts or surveys of counties, Mr. Ayton observes, would be an endless, and, in some measure, an unnecessary task. "But where men, who are justly esteemed eminent in other branches of science, and are looked up to as men of superior abilities and profound erudition, who have been employed to deliver lectures before the Board of Agriculture, have either put forth errors of their own, or retailed those of others, as sound and correct data for the guidance of farmers in an important part of their profession, and when such errors are published and extensively circulated under the sanction of high names, the detection of such errors becomes the more necessary.

"The Board of Agriculture employed Sir Humphrey Davy to deliver lectures on agricultural chemistry, and others to explain the mechanic powers; but owing to Sir Humphrey and the others employed having been, in a great measure, strangers to practical husbandry, they formed their opinions on that art from their own particular branches of science, and fell into many errors. Mr. Nasmith," author of *Elements of Agriculture* and other works, "having, as he thought, acquired some knowledge of chemistry, and wishing to turn it to good account, procured about half a bushel of moss earth, on which he experimented *in flower-pots in his cow-house*, and then detailed the results, or corollaries as he termed them, to the Highland Society, as data for the practical cultivation of all the mosses in Scotland; and he was much offended at those who could not trust to his prattling conceits, or who sought different results by cultivating that earth on the broader scale of acres and fields, not in a byre, but where Nature had laid it down.

"Sir Humphrey Davy, the first chemist in Britain, but who seems to know little about practical husbandry, has evidently gone into a similar error as Mr. Nasmith, by applying his chemical experiments to agricultural purposes, without perceiving that the one operation was altogether different from the other."

Sir Humphrey said that the mode by which he and Mr. Sinclair determined the nutritive powers of the pasture and hay grasses, "by the quantity of matter they contain soluble in water," is sufficiently accurate for all the purposes of agricultural investigation. Mr. Ayton will not admit this, because the analysis described seems to him to be "so entirely different from the much more complete processes of Nature, by which food is converted into nutriment in the stomachs and intestines of animals." The author, after describing the process of the stomach in extracting nourishment from food, and objecting in detail to various results of the experiments of Sir Humphrey and Mr. Sinclair thus concludes: "I cannot view the solutions or extracts these gentlemen say they procured by mashing or boiling dried grasses, as containing the whole nutritive matter in the plants they subjected to that process; and as to the analysis of the dung, it appears to me a mere freak. I am disposed to believe that a considerable portion of nutritive matter remained in the plants or hay after the scalding

or boiling operations had been gone through. I am also of opinion, that the mere weight of what boiling extracts is not a good criterion of the quality of that matter; for I am certain that a solution of equal or still greater weight than any they found in the grasses they brought to trial, might, by the same means, be got from willows, alders, birch, firs, or broom, which cattle do not eat; or from rag-weed, nettles, docks, or mugwort, all rejected by cattle; or even from hemlock, which is of a poisonous quality.

“The errors these gentlemen have fallen into have proceeded from an over-degree of confidence in their botanical and chemical knowledge, and in applying these to agriculture, of which it is evident they know but little. For however much each of them may be conversant in his own proper vocation, it is evident neither of them understands practical agriculture, and, therefore, they can scarcely fail to err when they attempt to direct its operations by chemical or horticultural rules.”

We regret to see such a paper as this; first, because, as our quotation will show, it is not written in a good spirit; and secondly, because nothing can be more injudicious than to turn into ridicule the efforts of scientific men to throw light on the processes of the arts. It is perfectly clear to us, that Sir Humphrey Davy and Mr. Sinclair adopted the most scientific method of which the present state of chemical knowledge admits to attain the ends they had in view; because we know from the writings of Thaer, that similar methods to attain similar ends have been adopted by the most eminent French and German chemists. Mr. Sinclair has given an able answer to this paper in the succeeding number of the *British Farmer's Magazine*, and our esteemed correspondent, Mr. Shirreff, of Mungoswells, has laughed at it in the *Farmer's Journal* for September 7. We recommend Mr. Ayton's paper to the scrutiny of Mr. Hayward and Mr. Johnston.

Strictures on Dr. Fleming's remarkable Law of vegetable Life; by Mr. Patrick Shirreff. Dr. Fleming endeavours to establish that an abundant supply of food operates differently with animals and vegetables with reference to the reproductive system; and Mr. Shirreff, to show that the effects of an abundant supply of food, in reference to the reproductive system, are similar in animals and plants, as far as it respects agriculture. It is certain that, in both kingdoms, there is a medium state, in the fundamental organs, between weakness and luxuriance, in which the reproductive system is found to be most fruitful; but it is equally certain that the starvation of plants, in almost all cases, throws them prematurely into a state of inflorescence; we shall not, however, at present, enter into this controversy, but recommend the subject to the care of our correspondent, Mr. Hayward.

A clever paper, by a Lancashire correspondent, recommends the goat as a milk-giving animal for cottagers, and even for farmers. “Not a farmer in England but would find very many advantages in keeping a little herd, yet we do not meet with it from the Tees to the Thames; not a cottager in his employ who would not have reason to be thankful to Heaven for a cleanly docile animal, that would supply him with milk, the finest in nature, at morn, at eve, and in the summer at noon-day; that would bring him two, and sometimes three, young ones yearly, requiring less at his hands than can well be conceived; and yet we see him consorting with dirt, and labouring in slops, to fatten a filthy and voracious animal of quintuple the cost, for any return from which he must wait long and risk a loss, which, if he escape, only compels him and his family to feed a great portion of the year on a salty unsalutiferous diet, and entails on his offspring a scorbutic constitution; we see a day-labourer starving a family to fatten an animal, which, in the end, perhaps, helps to fatten no one but the doctor, and losing sight altogether of another, which would feed his children daily with wholesome food, and get fat itself on what a pig wastes.

“ May I hope that some of that bright galaxy, who are anxious to see every cottager in Britain keeping his own cow, and are ready to every good work, may kindly step forward in favour of the lowest grade of our English cotters, and enable those who cannot keep a milch cow to keep at least a milch goat. It is undeniable that engagements of this kind among the poor restrain many from evil habits, whose leisure would lead them thereto; who, instead of being the poachers of the next generation, or the sauntering tipplers of the village, may become industrious breeders and owners of the little herds browsing on the common, or feeding on the village green and in its grassy lanes.”

We would strongly recommend this subject to the attention of married gardeners, who might feed a goat with the prunings of trees, clippings of hedges, and other articles that a pig would not eat: but we would not do away with the pig, nor with poultry, for the sake of the goat. The grand, and, we fear, insuperable, difficulty attending introducing goats on farms, is the expense of herding them; they can never be left to themselves among hedges or bushes of any kind, and therefore before a gardener or cottager can attempt to keep one, he must enclose a piece of ground, 30 or 40 ft. square, with a wall or pales at least 6 ft. high, and he may build a hut of any rude materials in the centre, on which the animal may climb up, and thus amuse itself and take exercise. A great many goats are kept in Italy and Switzerland for the sake of their milk, but they are carefully tended in herds. At Epinal, in France, a good many are also kept, without being always tended, and the consequence is, the hedges of the numerous little gardens that surround the town are cropped by them to such a degree that they look like low turf mounds. On enquiring, in October last, into the cause of this appearance, the gardener of M. Doublat informed us, that after the vintage, and at certain other times, the goats were left at liberty, and cropped every thing that came in their way. It is clear, therefore, that in most parts of Britain goats must be kept in such enclosures as we have described. That they would add much to the comforts of a poor family we can easily conceive, and we therefore hope that some liberal and enlightened proprietor will second the views of this benevolent writer. In many cases the goat-yard might be so joined to the cottage as that the goat might take exercise on the roof, and this roof might be trellised and covered with a rapid growing creeper between the trellis and the slates or tiles, in such a way as to supply the goat with a good deal of food, without permitting him to eat through the main shoots of the creeper. To effect this it would only be necessary to train each main shoot exactly under a trellis rafter. Dr. Clarke tells us, that in some parts of Sweden sheep are pastured on the tops of the houses; pasturing a goat in that situation would be no difficult matter in this country.

*The Quarterly Journal of Agriculture; and the Prize Essays and Transactions of the Highland Society of Scotland.* Edinburgh. In 8vo Numbers, quarterly. 5s. 6d. No. V.

In the present number is the commencement of a series of essays on the Origin and Natural History of Domestic Animals, which we hope will be continued, and the subject of breeding, not properly understood in Scotland, scientifically discussed. The harrow is in this number treated of in a similar manner to what the plough was in a former one. (p. 179.) There is a valuable paper on beet-root sugar, the important conclusions of which have been already quoted (p. 325.); and one on planting hedges, on which we shall have a word to say at an early opportunity. On the whole, this journal, already stated (p. 173.) to be worthy of the times in which it is produced, continues to maintain its reputation.



*Anon.*: A Letter to Thomas Andrew Knight, Esq. Pres. Hort. Soc., on the Management of the Garden and Funds of the Horticultural Society. London. Pamph., 8vo, pp. 26. 1s. 6d.

We are well satisfied to see this spirited pamphlet, not that we think it will do much good at present, for the reasons which we have already given (p. 469.), but because it will prepare the way for judicious reformation at a period when it shall become practicable. We recognise in the author of the pamphlet one of our earliest and best correspondents, and one of the most active and valuable members of one of the grandest associations of the present age, the Society for the Diffusion of Useful Knowledge. It is but justice to this eminent individual, here to state that at the commencement of the Gardener's Magazine he communicated to it many of his ideas as to the management of the affairs of the Horticultural Society, but that we considered it prudent, at that time, only to publish a part of them, lest we should give our work a controversial character. We published enough in our Second Number (Vol. I. p. 149.) to show what was our opinion at the time. Had the Society with their immense income confined their attention to such objects as could not be attained by individuals; had they given an impulse to the science of the art, and to the minds of gardeners, instead of monopolising the introduction of fruits and flowers, and such like matters, which would all have found their way into the country through travellers and nurserymen; had they in short directed their efforts to the mind of gardening, instead of its empirical practices, they would have done much good. But they have mistaken the means for the end, and staked their claim for public approbation on the most costly quarto volumes of Transactions, the house in Regent Street, the garden at Chiswick, with its splendid fêtes, and their list of Fellows, which, like that of the Medico-Botanical Society, is graced with all the crowned heads of Europe.

"*Ille ego qui quondam, &c.* I am he who, some few years ago, took the liberty of addressing a Letter to the late Sir Humphrey Davy, then President of the Royal Society, on the Management of the British Museum, and in which I took a glance at the affairs of the Society under his management. I now, with humbler flight, am about to take the same liberty with you, as President of the Horticultural, which I did with Sir H. Davy, as President of the Royal, Society.

"I feel, however, the difference of the subject — that the motion of sap and the cutting of cabbages are not such important points as those I formerly touched on. I beg my address may excite no uncomfortable feeling. I wish to set your mind at ease on this score at once. I have no cause of positive complaint against you. — I am not going to say one word about Turner's defalcations\*, though I must say it was vexatious, that, amongst all the responsible and non-responsible officers of the Society, none were found cunning enough to make him give security, and that none were found active enough to prevent his running away — which might, it is said, have been easily done. . . . I am well aware you have never willingly descended to prosecute the poor devils of collectors, and were no zealous party to the hauling Mr. Don into the Court of Chancery, and threatening him with the abyss of a court of common-law. † — Of all this I acquit you; but you are sorely guilty of misprision of treason, if not of actual commis-

\* Turner, we are informed, is now a waiter at a coffee-house in Paris. — *Cond.*

† Mr. Don was employed as a collector to the Society, and because he ventured to publish (contrary to his agreement, I admit) some recollections on a botanical subject, he had a bill in Chancery filed against him, poor devil; but the public has never yet reaped the benefit, in any other shape, of his labours. [We hope the history of the prosecution of Mr. George Don, and of the persecution of the gardener Christie, may at some future time be given to the public. Christie has never held up his head since; and, indeed, he and Mr. Don are not the only persons who have been connected with the Horticultural Society whom a certain individual has threatened to ruin.]

sion — you stand by — the watchman of the state — the very cherry-clapper put up by us to scare away the obscene birds — and not one single flagging clack is heard from your tongue — all grim silence — you are a very King Log — and this is what I complain of.

“I am one of those who have always been willing to allow you full merit, both for your knowledge of the physiology of vegetation, and your experiments in the cultivation of plants; and I am one who thinks the knowledge of the one, and the practice of the other, no mean attainments. You have done much towards the elucidating many points in the circulation of the sap, and have given many practical hints to gardeners: you have a large fortune, and were the very best person who could have been selected as our President; but though you have communicated to the Society what occurred to you from time to time (which, however, would have had more publicity if put in *Brande's Journal*, or any of the magazines of the day), you have absolutely done nothing for the Society, as to the administration of its affairs — you have been looking after your own garden instead of ours — our garden is . . . .

“Now it is asked, what are you to do? what has been omitted? what has been done wrong? All very fair questions, I admit. I shall not answer them in order, though I will answer them all before I have done. In the first place, look at the published *Transactions* of the Society: with the exception of some papers of your own, and a few from practical persons, was there ever such a heap of trash impressed on wire-wove paper, and dealt out to the public at three or four guineas a volume? Was it necessary that a Society should come together for the purpose of printing a volume in quarto on the characters of sportive varieties of Chrysanthemums, and figures of fugitive Georginas? Had you any such notion that this was the end and object of your being called into legal existence? I know you laugh at all these things as well as I do, and amuse your guests at the expense of some of the amateurs and dabblers of the Society: but you should do more; you should first stop the evil, and then laugh at those who would have perpetrated it. . . . .

“Next, as to the administration of the affairs of the Society. A garden is taken without any calling-in of the general members and subscribers — the king and council decide on this — but they do not find the money — this must be got from the members — they (the members) may pay, but not vote. This, you will say, is an old complaint, and that it savours much of radicalism. I am aware that it involves the grave question of universal suffrage; but let that pass. The garden is to be taken, though ten times too large for a mere experiment garden — but who is to pay, to effect this object of taking the garden? — The whole class of subscribers were, in my opinion, imposed on, actually dealt unfairly by: they were told, if they did not consent to pay extra, they would be reduced, turned into *yellow admirals*; they were to be put into an inferior class, should not have a twig from the new garden, nor should they even have the privilege of taking their friends to see it. Now, the original subscribers, viz. those who first set the thing afloat, were treated as old friends sometimes are, that is, ill-used, and all the favour bestowed on the new ones. And here was the first error you made — it was two-fold: you affronted many of the real friends of the Society, who did not, however, care to tell you so, and you began to dabble with money; then came patronage, a clerk to be recommended, a bricklayer friend or a stone-mason cousin to be pushed forward, and the true English process of jobbing and patronage began — and has not yet ended. This is the fate of every institution in this country, wherever there are funds or patronage; and perhaps it might have required more than mortal vigilance in you to have stemmed the torrent — but you have absolutely done nothing, and therefore are surely to blame. . . . .

“ Will you venture to say that any one set or course of scientific experiments has been carried on at the gardens by any officer of the Society, whereby the knowledge of vegetable physiology or the cultivation of plants has been really improved or forwarded? . . . .

“ *Botany* is not the end of our institution — our charter was not granted for the cultivation of that science. There is the Linnean Society for botany, and yet some thousands have been thrown away purely in the collection of rare plants, without the collecting them being the object of the Institution. How many men and how much money do you think have been spent in growing orchideous plants, merely to figure in the *Botanical Register*? Is this a fair mode of expending our money? I am aware that you are averse to this — that you complain, or are said to complain, of the waste of money in *growing so many parasites* in the garden; but again I say, it is not enough merely to complain, if you do not use your influence on these points.

“ And it may be asked, how have the botanical stores of the Society been used? It is true that some of the periodical magazines were allowed, *under restrictions*, to figure them, but the permission was given under severe conditions. I myself saw a complaint made by one of your officers against a writer in one of the magazines, for having ventured to call a plant after the name of so humble a person as a mere *collector* — viz. the person who, at the risk of his life, at a guinea per week, had dug it out of the burning sands of Sierra Leone, or the dank pestilential woods of South America. All this is very trumpery for a Society with a charter, a council, and a president, honorary secretary, &c.

“ I have said, what have the Society done with its funds? Is there any thing to show? Has any taste been shown in the distribution of the garden? What is it but a flat square piece, with a snake-shaped ditch trickling through it, with three or four straight walks, and three or four meandering ones, a lawn, and a dozen of kidney clumps? This is as much as its staunchest advocate can say in its praise. Surely you would not like a foreigner, who comes over here open-mouthed to see our gardens — les jardins Anglais, — to go down to Chiswick to see ours as a fair specimen of what an English garden is. How many have been taken there who have stared when told this was the result of the expenditure of vast sums of money, under the guidance of yourself, and assisted by a council! Surely if we were to spend our money in ornament, we should (if we had no person of taste in the Society) have called in those who created such fairyland as is to be seen at Dropmore, at Lord Farnborough’s, or at Ashridge, &c. &c. If some part of the thousands which have been buried at Chiswick had been put at the disposal of Lady Grenville or Lady Farnborough, should we have seen such rock-work, such clumps, such walks, such hodge-podge arrangements, as grace and deck our garden? At all events, we have failed in the ornamental department — that is admitted: how we succeed in the fruit, the periodical exhibitions show. . . . .

“ I write to you in a style something like that which guided the laying-out of our garden — it is of no moment, so long as I bring the points before you.

“ Most people have some cure for every disease, some theory, some universal panacea: for my part, I really and fairly think the fountain of all the evil in the management, the “*origo et fons*,” is, that we have not any PAID RESPONSIBLE OFFICER — no person who is paid, and who takes the real control and management of the Society’s affairs on himself. I am very much prejudiced against any honorary officers. I do not mean that we shall be liable, as the Mendicity Society were, to such claims as were made by their secretary; but, I take it, every body, or society, pays either in *meal* or *in malt*, and that if our secretary is not paid, we cannot expect that particular attention can be so rigidly exacted in the fulfilment of duties, and, what is worst of all, cannot so strictly confine him to his particular

line of duty, as would be the case with a paid officer. If a person who, for the mere pleasure of control, for the enjoyment of a little patronage, for the mere power of drilling labourers and inducting aspirant assistants to the clipping of edgings, rolling gravel walks, and forking up hot-beds, will undertake a drudgery that others would not go through without being well paid, one must pay him by concession: the result is, that the servant becomes the master, and you, Sir — the actual President — with your hammer, mace, &c., of office, after all, are but a king with a viceroy over you. I have said before, that if you undertake the office, you should perform it. A scientific institution in this country will not do with a King Log: you must govern, or lay down your mace. I suspect that it is odious to you to mix yourself up with the squabbles of a scientific society; that you feel it is beneath a man of your attainments and fortune to interfere when you know things are wrong; but you must submit to importunity — to vexation — to something else not to be named, to set things right, or you ought to yield your office to some one who will condescend to perform faithfully its duties. Rich, devoted to your garden and the pursuits of science, you are unwilling to set your shoulder to the wheel: but this is hardly fair; those who placed you where you are depended on your superintendence, and any conduct whatever of yours which disappoints them of their fair expectations is unjust. Of the Council, not many ever attend, and I believe I am correct when I say, the great stars rarely, if ever, appear. These are edged into the list . . . .

“I know you never made yourself a party to this nonsense of giving a breakfast in a garden which was originally intended for scientific purposes, and which has not a spark of pretension to beauty or elegance in its disposition or arrangement. There is not a single building which displays either taste or architectural design in the whole thirty acres. There is not a single bed or border arranged better than may be seen at a common nurseryman’s; so that there was no excuse that it would improve the *taste* of the visitors, or leave them in admiration of ours; or that the march of intellect, as far as relates to ornamental gardening, would be accelerated by the exhibition. And then the trumpety operation of making a profit by the tickets, like a charity dinner, or a subscription concert. The College of Physicians might as well, instead of their evening parties, give a “tea and turn-out” at so much per head, and then lay out the gains in buying mummies for their museum — if, indeed, they have one. But there is another light in which this was objectionable: many individuals in a middling class of life, as well as the aristocracy, are members of the Society. Now it was unfair on this class to give a *fête*, as it was termed, and put an exorbitant price on the tickets of admission, which would virtually exclude them, or put them to unreasonable expense; and further, to give a party in their own garden, at which it would be no pleasure to them or their families to be present; at which, if they appeared, they would have some chance of being jostled in the mud by the patrician order. And, if I mistake not, some hints were given as to those who were not wished to attend — those who were expected to *remember to forget* to come. This only came to me in a whisper, and it may not be true — but enough of this. My chief complaint is of the *management*. What has been done by the Society? Has there been a bunch of grapes grown that would have been creditable to a market-gardener? Have we attempted to grow or produce that which people of smaller means or less knowledge could not do? Have we sought to rival Mr. Loddiges’s house, or to exceed what the Duke of Northumberland is doing at Syon?

“I have before asked, who lectures at the garden? What instruction is given? What success have the *élèves*, who have graduated in the horticultural departments of the Society? What is the general opinion of the concern? What is the number of the seceders? What the number of

malcontents? Members are tired of seeing two or three acres devoted to *Rosa Sabini* and *Rosa Dónni* and their supposed varieties, and the clerk's time devoted to record their supposed names. Did you hear of the poor man who was set to taste three hundred and sixty-five sorts of potatoes, at one sort per day, and then to write a description of the flavour of each — a pigeon a day for a month they say kills a man — but to carry the flavour of two shades of a variety of a *red champion* or an *ox noble* on the tongue from one day to the next, so as to form an estimate of the difference of taste between each, and then to distinguish both from the taste of a *lady's finger*, and so on through the whole series, and write down his sensations in a journal, was too much even for a poor Scotchman: he rebelled, and was dismissed as contumacious, after having tasted through a quarter of the task — at least so goes the story, or rather so says the man. . . .

“ If a new plant arrives, say a camellia from China, I, a simple member, can know nothing of its coming; but if I had a friend in the Council, or, what might be better, one of the officers, I should soon know, and he would say, “ apply in time, and you will get it first; ” so that the result is, when there is any such rarity, such as a new camellia, a pæony, *Pinus Lamberti*, &c. &c., these are all bespoken before those members who have no friend in council or at court know any thing of the matter. The same mode of distribution takes place with regard to the nurserymen. Ask such respectable men as Mr. Knight or Mr. Mackay, what their opinion is of the benefit done by the Society, and what are the advantages said to be derivable by the nurserymen from the distributions. Ask them what they have received. Look to the selection of the nurserymen, who are put on (as practical men) to manage the affairs of the garden, and say if a real and judicious selection has been made, and what possible advantages are derived from their superintendence or assistance; in fact, if it is even known that they interfere at all. One very respectable nurseryman admitted to me, that, though on the Council, except in giving an opinion on the choice of the site of the garden, he never ventured to interfere. . . .

“ What have the Society done to diffuse science at a cheap rate? Why they refused to let their *Transactions* be abridged, or at least I know their secretary wished it not to be done. They publish what they idly suppose worth printing, at a price perfectly beyond the reach of the middling class; they do nothing for the education of the men they employ, nor generally for those connected with the pursuit of gardening.

“ With respect to the rules for the management of the garden, they have been framed in the true mercantile spirit: those who pay most shall get most. The hope of gain, and a feeling of selfishness, have acquired the Society many as subscribers, who, I am quite sure, would never have thought of belonging to a scientific institution, but for the hopes of getting back their money in money's worth. Many have paid their additional guinea to the garden, or laid down their 10*l.* or 20*l.*, in the hopes of reaping the fruit of it, notwithstanding so great a man as Aristotle has said that money is barren. But what has been the result? Every one of them has been disappointed, every one grumbles, and many take out their names; indeed, I think they have not been fairly dealt with. You and the Council have expressly introduced the mercantile spirit and feeling in your dealings with the public, and your members and you ought (particularly seeing that you have a royal charter) to have kept up the true old mercantile spirit, rather than the tradesman-like tone of the present day. You say expressly, that the surplus of new and rare plants shall be distributed amongst the nurserymen, and amongst the members according to the amount of *their subscription* — now mind that. Here is a *direct encouragement* to subscribe liberally — there is to be a *quid pro quo* for all paid — the subscribers to the garden are to have the produce of the garden; of which, however, the old members, who set the affair afloat, are to have none. . . .

“ I should almost doubt whether you do not come within the meaning of the bankrupt laws. As you are a Society growing cabbages and strawberries for profit, perhaps the selling them amongst yourselves may make a difference. The point is worth considering, particularly as the law is proverbially uncertain, and the Society has the reputation of being poor. . . .

“ One of the reasons I have heard advanced for this superabundance of cultivation is, for the purpose, not only of producing cabbages, but for the simultaneous production of young gardeners. What has been the result? I could vouch the experience of many of your subscribers (some of high rank), that never were such servants sent out of the most trumpery nursery. And how could it be otherwise? Poets are born, not made, we all know—but is a gardener? What experience can they acquire at Chiswick? Who is there at this moment to teach them? Does Mr. Sabine profess to be a gardener? does he attend at all to the details? Does Mr. Lindley wield the hoe? or, if either of them did, are they practical gardeners? Who else then is there? The late Mr. Turner was a printer. Who, then, but Mr. Monro is the Coryphæus of the whole set? And it is this person to whom the management of the education, practical and theoretical, of the whole establishment is confided—for there is no other person in office—he alone teaches the young idea of the whole class how to shoot. You, of course, never deign to “ prune the vine:” you, if report says truly, think it better each time you come up, to be a “ better stranger” with the garden. In fact, there is indeed little taught. No lectures are, as I before said, given on botany in practical gardening, or agricultural chemistry; on the physiology of plants, &c.: nor is there one competent to give such lectures; and I defy you to show a good gardener who has been made by the Society. If you were to disguise your dignity, and go round the garden like the sultan *Haroun Alraschid*, you would hear one half of them laugh most heartily at their teacher—at the institution—its rules—its bye-laws—the drilling—the orders as to dress—straw hats, &c. They admit that if they were to conduct their employer’s garden at the same expense and with the same result, they should not stay in their place a year; nor, indeed, could any thing but the Society afford it.

“ I hope I, or some one whose voice is more powerful, will be able to stimulate you into exertion. Do not be supine, do not act like the countryman in the fable; you must not call on Hercules to get you out of the mire—no, not even on *Priapus*—you must at once clap your shoulder to the wheel. All you have to do is to give the Society and its affairs fair attention; call around you an active Council; divide the work into departments, put a responsible person at the head of each; kick down the apple and cabbage stalls, burn the pottles and punnets; dig up the kidney clumps, invite some persons of skill to lay out the grounds over again, dig up the dog-roses, arrange the arboretum properly and scientifically; do away with growing of plants, &c., for other gardens; instruct the gardeners, let them have lectures on each department of their art, and have encouragement to educate themselves; let some of the most deserving have the sole management of some particular branch of culture; let there be a real and accurate catalogue of fruits and vegetables; turn out nine tenths of the trashy varieties of fruit (which are only fit for pigs) from the fruit quarters; if there is to be any produce distributed (of the wisdom of which I cannot but doubt), let it be done fairly and openly, according to priority of application, not according to merit, which no Council can gauge, or let this be distributed to the nurserymen alone; sell your *Transactions* cheap, and let the contents be good—not, as now, dear and bad, use wood-cuts instead of fine copper-plates, judge yourself of their contents or set proper persons to do so;—we shall be safe, and shall prosper.”

Every gardener who can spare 1s. 6d., ought to read this pamphlet.

*Kennedy, Lewis, Esq.*, son of Mr. Kennedy, the late eminent Nurseryman of Hammersmith, Steward to Lord Willoughby De Eresby, Author of *The Tenancy of Land in Great Britain, &c.*: On the Cultivation of the Waste Lands in the United Kingdom, for the purpose of finding Employment for the able Poor, now receiving Parochial Aid, and thereby diminishing the heavy Burthens of the Poor Rates; and on the Expediency of making some Provision for the aged and disabled Paupers of Ireland. London. Pamph. 8vo. 2s. 6d.

Mr. Kennedy, obviously influenced by the most benevolent motives, recommends, with Mr. Allen, colonies at home in preference to colonies in Australia or Canada, and paying for labour what now is paid as poor rates for nothing. We entirely agree with him, but having already given our opinion at length on this subject, and recommended the same thing in our concluding review of Slaney, and in our notice of Mr. Allen's pamphlet (Vol. II. p. 321.), we need not follow Mr. Kennedy into details. It gives us much pleasure to find from his dedication, that "to promote the happiness and to increase the comforts of the labouring and distressed poor," has been "a favourite and cherished purpose" of Lord and Lady Willoughby De Eresby. We should be most happy if Mr. Kennedy would enable us to record the acts of his noble patrons; to give plans of the cottages they have built, the size of the gardens they have laid to them, and the description of village schools, established on the very extensive estates of this family in Perthshire, Lincolnshire, and Wales.

*Lawrence, John*, Author of *A Philosophical and Practical Treatise on Horses, The History of the Horse, &c.*: The Horse in all his Varieties and Uses; his Breeding, Rearing, and Management, whether in Labour or Rest; with Rules, occasionally interspersed, for his Preservation from Disease. London, 1829. Small 8vo, pp. 315. 8s.

The name of Lawrence is familiar to every agricultural and veterinary reader, and the present work may be considered as the concentrated essence of all that the indefatigable and patriotic author had formerly written on the subject of the horse, combined with some new matter of his own, and with whatever he found valuable in recent works on the same subject. To every one who keeps a horse, or intends to keep one, we can strongly recommend the book, as both good and cheap.

*Lambert, Joseph, Esq.*: *Observations on the Rural Affairs of Ireland, or a Practical Treatise on Farming, Planting, and Gardening, adapted to the Circumstances, Resources, Soil, and Climate of the Country.* Dublin. 8vo, pp. 327.

This is a valuable little volume; valuable because practical, plain, and rational. It is not inflated by theoretical dreams of what should, but common sense directions of what may, be done. Nothing is advised to be undertaken or executed but what experience has already proved to be beneficial. The amelioration of the soil by the introduction of the best practice, and the greatest improvement of the moral and personal condition of the Irish peasantry, are the results at which the author aims, and which will certainly follow the adoption of the measures and means proposed by him. He looks to no parliamentary interference, or forced regulations, to alter the customs, by thwarting the opinions or prejudices, of the agriculturists; but by the evidence of expedients which, from uniform success, bring conviction to the mind of the cultivator. The only blemishes are those of nomenclature; but on all the subjects treated of the advice is sound, the directions plain, and the phraseology respectable. The work should be in the hands of every rural improver; not in Ireland only, but every where else.—*J. M. Chelsea.*

*Haworth, B., Esq. M.A.:* A Dissertation on the English Poor, stating the Advantages of Education, with a Plan for the gradual Abolition of the Poor Laws. 3s. 6d.

"No scheme for the amendment of the poor laws merits the least attention, which has not their abolition for its ultimate object." — *Ricardo.*

*Wetten, Robert, Architect:* A Series of Designs for Villas, in the Italian Style of Architecture. To be published in six Parts, each containing one Design, illustrated by Plans, Elevations, and Scenic Views. London. Part I. 4to. Two Ground Plans, an Elevation, and a Perspective View. 6s.

"The author has been induced to arrange these compositions in the Italian style of architecture at the suggestion of several amateurs, partial to its beauties, who, from the few specimens hitherto published, have regretted that it has not been more frequently adopted. He has been further recommended to submit them to public notice, under the impression that this style of architecture is entirely deserving of the high encomiums that were formerly passed upon it, although of late years it has been partially superseded by the Gothic; and that without destroying the harmony of its proportions, or the beauties of its appearance, it may be accommodated to the means of those who, however they may have felt disposed to patronise the professors of this style, have, hitherto, in some measure been deterred by the apprehensions of expense.

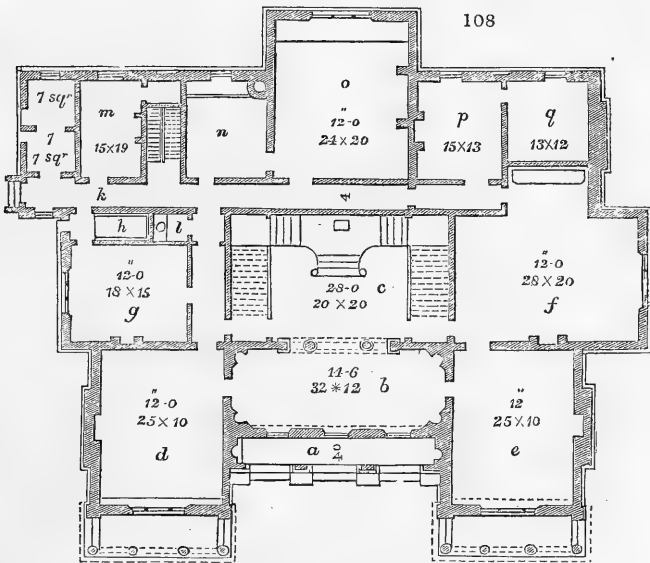

Design No. I. A Villa prepared for a lady near Bristol (*figs. 108, 109.*) is exceedingly handsome in the elevation, and not badly arranged on the ground plan. The principal floor is entered by a loggia (*fig. 108. a*), which communicates with a vestibule (*b*), staircase (*c*), drawing-room (*d*), breakfast-room (*e*), dining-room (*f*), library (*g*), bath (*h*), water-closet (*i*), servants' entrance (*k*), larder (*l*), man's room (*m*), scullery (*n*), kitchen (*o*), house-keeper's room (*p*), and store room (*q*). The chief objections which we have to this arrangement are, the situation of the water-closet in the interior of the house



without exterior ventilation or light. Such conveniences should, as much as possible, be placed in a sort of loggia, so as that not only their windows but doors might open to the free air. The loggia, which of course should only be entered from some passage or lobby, might be contrived to shut in with glass or Venetian blinds in severe weather; or it might have the appearance exteriorly of a large window. The second objection is the projection made for the chimneys in the rooms (*de*), which, being common in brick cottages, always conveys something of vulgarity and weakness or meanness to buildings of a higher character. We imagine, for example, on looking at the elevation (*fig.* 109.), that, if the walls had been sufficiently thick, the chimney-

109

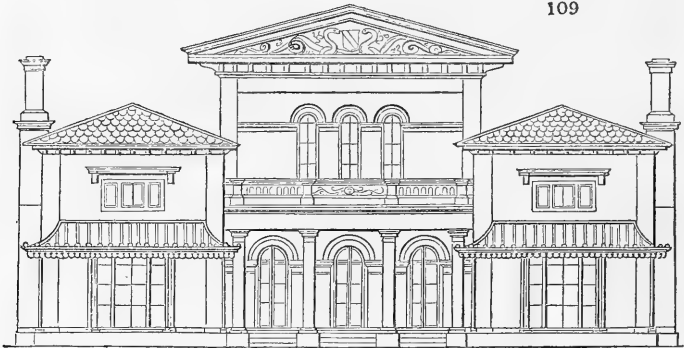

flues would have been carried up in them, instead of in a stack or portion of wall of an extra-thickness, built on purpose to contain them. With this exception we consider the elevation as truly beautiful. The three central windows over the three windows of the same kind placed farther apart attract the eye to the centre, and retain it there in admiration, while the two smaller windows over the verandas in the wings have a similar effect in their way. The building is thus a well-defined whole, composed of three parts, separately wholes also and well defined. The colonnade and balustrade of the loggia harmonise with the centre pediment, as the verandas do with the pavilion roofs. Had the chimneys been in the walls instead of outside of them, it would have been perfect in its kind.

*Castle, T.*, F.L.S. : An Introduction to Botany, including the History, Elements, and Language of Botany, the Linnean Artificial System, the Natural Systems of Linnæus and Jussieu, the Anatomy and Physiology of Plants, and the Harmonies of Vegetation. London. 1 vol. plates. 10s. plain, and 12s. 6d. coloured.

*Jones, the Rev. J. P.*, and *J. F. Kingston* : Flora Devonensis; or a Descriptive Catalogue of Plants growing wild in the County of Devon, arranged both according to the Linnean and Natural Systems, with an Account of their Geographical Distribution, &c. London. 8vo. 16s.

*Phillips H.*, Esq. F.H.S., Author of *Pomarium Britannicum*, and other Works : Flora Histórica. 2d ed. 2 vols. 8vo. 21s. bds.

## PART III.

## MISCELLANEOUS INTELLIGENCE.

ART. I. *General Notices.*

*APPLICATION of the term Involucrum.* — Sir, Sweet, in his description of *Davallia gibberosa*, Nat. Ord. *Filices*, *Fl. Austral.* t. 31., has adopted the term *Involucrum* for the membranous covering of the sori, or tufts of flowers, in preference to the superfluous *Indusium* of modern authors. The decided superiority of such an adoption, I think, does him the highest honour, and deserves to be imitated by all systematists!! — *Botanicus.* April 16.

*Principle of Human Development.* — Taking the mind and the body together, their united functions may be reduced to three: 1. the *constructive*, or those which relate to growth; 2. the *intellectual*, or those which relate to mind and morals; and 3. the *reproductive*, or those which have reference to the continuation of the species. Now it appears to be a universal principle in nature, that any intension [design] of one of these three functions is attended by a corresponding remission of one or both of the other two; in other words, if any one of the functions is employed in excess, a corresponding deficiency will be found in the usual exercise of the others. "In all cases there is evidently *in utero* a very great activity of the constructive functions. This activity generally diminishes after birth in a degree, which, setting disease aside, bears an evident ratio to the increasing exercise of the intellectual functions. The *remission*, or temporary suspension, of the intellectual functions, which occurs during sleep, is attended with an evident *intension* of the constructive functions, by which, in the time of healthy repose, the wearied or impaired organs are put into a state fit for renewed action. Great precocity of intellect I have certainly seen attended with a marked decrease of the constructive functions. It is common for young persons of either sex to acquire, about the time of puberty, a sudden and extraordinary activity of the constructive functions; and I have long observed that the intellect then, except in matters that regard the *final cause of that activity*, becomes uncommonly sluggish and inactive. The reproductive functions succeed to the completion of the constructive, and it is well known that too great exercise of them is incompatible with an intense application of the mind to study. On the other hand, excessive intellectual exercise is sometimes destructive of health (which depends upon a due performance of the constructive functions), and also of the reproductive powers or inclinations. Sir Isaac Newton, whose intellectual powers were never perhaps exceeded, is said to have exhibited this inactivity or deficiency of the reproductive." (*T. Smith, Esq., Surgeon, Kingussie, Inverness-shire, in Brewster's Journal of Science for July, 1829, p. 55.*)

*The Conservative Tendency of Prosperity.* — In Hawkins's *Elements of Medical Statistics*, a most original and interesting book, are collected together a great number of facts, which prove, beyond a doubt, that health and the duration of life are promoted by occupation and prosperity, and

retarded by their opposites. The mean duration of life has gradually increased in England, and even more strikingly in cities than in rural districts, since statistical tables were kept. In the middle of the last century, the annual mortality of London was about one in twenty; by the census of 1821 it is as one in forty. On the continent of Europe similar changes have been taking place, but in a very inferior degree. A great portion of the deaths in cities is assigned to the constant importation from the country of individuals who have attained to maturity, but who having been previously habituated to frequent exercise in a pure atmosphere, and to simple regular diet, are gradually sacrificed to confined air, sedentary habits, or a capricious and over-stimulating food. A large portion of the disease of the country population arises from the excessive use of spirituous liquors, or of low sour wines or ciders. Masons are most subject to consumptions, and tanners least so: soldiers are more healthy than sailors; there is more disease in an army during an unsuccessful than during a successful campaign: gardeners and agriculturists, who have families, produce somewhat more male than female children, and the contrary as to those who are engaged in the pursuits of commerce and manufactures. Improvements in the public health are uniformly attended by a diminution of marriages and births, because there being only a certain quantity of subsistence, if men live longer, there must be a smaller number of them produced. Thus, with an equal mass of living beings, there is a smaller drawback by deaths and the pains and dangers of child-birth. — *Cond.*

*Heating by hot Water.*—Mr. Weekes, manufacturer of horticultural buildings in the King's Road, has made one of the greatest improvements which have been accomplished in this mode of heating since its application to gardening purposes. One of the few objections to the system has hitherto been, that, in a cold morning, the temperature of a forcing-house cannot be so suddenly raised, and in foggy weather the damp in a green-house cannot be so suddenly dried up, as by fire flues. Mr. Weekes has completely removed this difficulty, by circulating the water along a box or tube, 12 or 18 in. broad, and only  $\frac{5}{8}$  in. deep, inside measure. The boiler being small, and exposing a long surface to the fire, on Mr. Cottam and Mr. Fowler's principle, the water is soon heated, and passes rapidly along the broad tube (*fig. 110. a a*), which, exposing

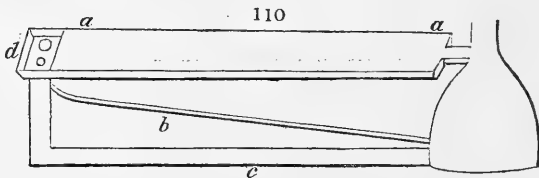

so large a surface, quickly gives out its heat. At the further end of the house this broad plate is connected with two returning pipes; one of a very small diameter, barely sufficient to carry back the water sent forward in the broad tube (*b*), and the other of 6 in. or a foot in diameter (*c*), to serve as a reservoir of heat in the night-time, or to be employed instead of the small returning pipe, when the house is once heated to the proper degree. The returning pipes open into a small cistern (*d*), formed in the end of the broad tube, and the opening to each pipe is stopped by a plug; the one or the other of which is taken out, according to the tube the water is meant to return by. Nothing can be more beautiful, simple, and effectual, of which any one may be convinced, by inspecting the apparatus, placed in a house 60 ft. long, on Mr. Weekes's premises. Of course, the direction of the pipes may be varied at pleasure, to suit every form of house; and instead of a returning pipe of large dimensions, a second one, of small diameter, might pass through a series of cisterns, of such dimensions as would retain the heat for any term considered necessary. To retain a layer of water on the upper surface of the broad tubes, for the

purposes of evaporation, it is only necessary to raise two ledges on their outer edges. Mr. Weekes has taken out a patent for his improvement, but we hope he will soon make some arrangement by which his broad tube, whether set on edge or kept flat, will be generally adopted as the going pipe by the numerous persons throughout the country now heating hot-houses by hot water.

Mr. Weekes is a simple harmless man, not very likely, we fear, to make the most of his invention. We trust, however, that the numerous tradesmen to whom he shows and explains it, will act as honourably to him as they would wish to be done by, if in his circumstances. It is not uncommon with rich manufacturers in Birmingham and Sheffield, when they find a patent taken out by a poor one, for what they consider a good thing, to infringe it under various pretences, and risk the consequences, well knowing the expenses of the law, even when the law-suit is gained; but when a man like Mr. Weekes has hit upon a thing that is really entitled to a patent, that patent, however much it might be liable to be technically infringed, ought to be held sacred. This should be a point of honour among commercial men, and we know it is, in corresponding cases, among the respectable part of the London booksellers and other tradesmen. On the other hand, patentees ought to be liberal, and this we have counselled Mr. Weekes to be. — *Cond.*

*Siebe's Rotatory Garden Engine and Pump.* — This machinist has made a very great improvement on garden engines, and has also produced a description of forcing pump, and a lifting or common pump, which offer very considerable advantages. The garden engine will be found a great deal more easily worked than the most improved modification of those in common use. The motion is rotatory, by a handle, as in turning a coffee-mill. The machine being entirely made of metal, without leather or other fibrous material, no changes of temperature, or of moisture in the air, will put it out of order when not in use. The stream of water thrown out being continuous, a greater quantity is delivered in a shorter time. On the whole, we think it an excellent improvement. Our attention was first directed to it by Mr. Nash, head flower-gardener to Lord Farnborough at Bromley Hill; and we soon after went to see the machine operate at the manufactory, 145.

High Holborn, and were amply gratified. A pump, also, on a rotatory principle, was invented some years ago by Mr. Joseph Eve; but this engine (*fig. 111.*) had two cylinders, whereas Mr. Siebe's has only one, composed of four wings. In Eve's engine two cylinders (*a b*), working into each other, raised the water from the well or other supply by a tube (*c*), and delivered it by another tube (*d*). It was stated in the *Quarterly Journal of Science* for January, 1827, to have great advantages; but we believe it has never come much into use. Siebe's engine we consider to be a great improvement on it, and we shall prove this to be the case, in next Number, by engravings. In the mean time, we counsel every reader not to purchase a hydraulic engine, or a pump of *any kind whatever*, before calling, or sending some competent person, to see Mr. Siebe's invention. Mr. Siebe being a foreigner, not knowing a great deal of the ways of the English world, has neglected to do himself that justice by publicity which we hope in some measure to do. — *Cond.*

*Downe's Self-acting Water-Closet.* — This machine is to be seen in the same shop with Siebe's garden engine, and we can pronounce it with con-

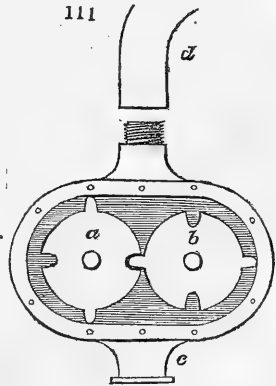

fidence to be the most perfect of all the water-closets hitherto invented. We are certain that no one who has seen it will ever adopt any other. It is the only form we have ever seen perfectly adapted for foreign countries, and we would strongly recommend it to our friends and correspondents in the north of Germany and Russia, provided they will always keep the temperature of the place where it is kept above 32° of Fahr. But another excellence of this machine which fits it for cold countries is, that it will operate in frosty weather without the use of water. We could not describe it in such a way as to enable a foreign workman to construct a similar one, without several engravings upon a large scale; but the price, complete, is only seven pounds. — *Cond.*

*The Stachys palustris, as an Esculent Vegetable.* — The Society of Arts have lately voted the silver Ceres medal to Joseph Houlton, Esq. F.L.S. &c., Lecturer on Botany at the Western Hospital, and one of the Editors of the *London Medical and Surgical Journal*, for the introduction to public notice of this plant. "The *Stachys palustris*, or Marsh All-heal, is a plant not unfrequently occurring on the sides of ditches, or of moist rich corn fields: it increases rapidly by creeping roots, and forms on these, during the summer, a number of thick, half-tuberous buds, from which the stems of the next year are to arise. From the end of autumn to the close of winter, these tuberous buds abound in a mild, somewhat sweetish, farinaceous matter, and are then fit for domestic use, being crisp, without fibre, and of a peculiar but scarcely perceptible flavour. The plant and roots are figured in Curtis's *Flora Londinensis*, but Mr. Houlton has the credit of having first suggested its use as an esculent vegetable, and of having made some experiments on the best way of cultivating it. In one respect the subject is interesting to the philosophical botanist, as offering, perhaps, the only known instance of a plant belonging to the natural order of the Labiatae producing farinaceous tubers, capable of being applied to human food. In general, the only use derived from plants of this order is as condiments, like sage, mint, thyme, &c.; or as affording essential oil, like origanum, rosemary, peppermint, and lavender." (*Pref. to Trans. of the Soc. of Arts, Manufactures, and Commerce*, vol. xlv. 8vo, 1818.)

*The Stalks and Roots of the common Comfrey (Sýmphytum officinale)* are very farinaceous: the stalks have been blanched and eaten like those of Angélica, and we have no doubt of the tuberculated roots being at least as good as those of the *Stachys palustris*. The shoots of *Sýmphytum aspérimum*, as we have seen (p. 442.), are greedily eaten by cows. There are very few plants, indeed, that are poisonous, and there can be no doubt that a great many, by culture, might be increased in the whole, or in certain of their parts, so as to be worth cultivating as esculents. It is good to know every thing that can be done in this way, and Mr. Houlton has been very deservedly honoured for his exertions. — *Cond.*

---

## ART. II. Foreign Notices.

### FRANCE.

*BOTANY among the common People in the Neighbourhood of Paris.* — There are at Paris three courses of *Botanique rurale*, that is, three botanists make weekly excursions with a number of pupils. Jussieu is the public professor of this branch, and his high reputation induced me to wish to join the party. There is no difficulty in it, the lecture is perfectly open, and no introduction is necessary. On Wednesday, 29th of May, I repaired to the appointed place (of which public notice is always given), at the entrance of the avenue of St. Cloud. I was told that the class sometimes amounted to two hun-

ered : on this occasion there were, I suppose, half that number ; but it is difficult to judge, as a large portion is always scattered about. It was quite a novelty to botanise in such a *crowd*, and a very amusing novelty. The party seemed to be taken from all classes ; among them were several ladies, and many who had the appearance of gentlemen ; but the larger portion, I apprehend, were students in the School of Medicine at Paris, and these are, in a great measure, derived from a lower class in society than that which peoples the English, or even the Scotch, universities. No person can exercise the trade of an apothecary without a certificate of having attended certain courses of botany. Some were evidently mechanics, and one or two private soldiers. It has, I understand, always been the case in France, that, among the private soldiers, there have been some who have attended the different courses. How honourable this is to the French character, and how much more favourable to morals than where the only resource for an idle hour is the alehouse ! Nor should I be satisfied with the observation, that they would be better employed in working for their families. Man has a right, occasionally, to relaxation, and to some exciting amusement ; nor do I believe that either his moral or physical health can be well preserved without it. In England, a gentleman or lady would not choose to be seen in such an assembly of all classes : why is it that our pride will not permit us to enjoy, without excluding our inferiors ? In fact, with all our boast of superior religion and superior charity, there are more of contempt in our manners towards the lower classes, and less of kindness, than in, I believe, any other nation of Europe. It may be merely in manner, and may regard only trifles : but nine tenths of human life is made up of trifles ; I am more indebted to him who will make me happy in them, than to him who would relieve me in the other tenth of serious misfortune. (*Wood's Letters of an Architect*, vol. i.)

*The Cultivation of Maize* is likely to become general in France. At the sitting of the Academy of Sciences in Paris, on the 31st ult., it was proposed to give a prize of 1500 francs value to the author of the best essay on the cultivation of Indian corn in the four departments surrounding Paris, with a view to render this grain useful for the nourishment of the human species. Hitherto it has been grown chiefly in the south of France, as food for cattle and fowls. It is a singular fact, that fowls fed exclusively upon this food have a yellow appearance. (*Lit. Gaz.*, April 11. 1829.)

*Superior Salubrity of high and dry Situations.*—In the French *Annuaire*, or Almanack, for 1829, various statements respecting population are given. Among 855,658 deaths in 1826, 158 had reached or exceeded their hundredth year ; and, what is remarkable, and shows the superior salubrity of high and dry countries, by far the greatest proportion of these centenarians was in the two departments of the Upper and Lower Pyrenees. (*Scotsman*, March, 1829.)

## DENMARK.

*Royal Gardens, Rosenburgh.* Aug. 20. 1829. — If the weather do not change, we shall have no harvest at all. No gardener living remembers such a season. Grass and cabbages, and the like, thrive luxuriantly ; but grapes, peaches, and the late sorts of pears, on the open wall, will not ripen this season. For several nights the thermometer has been down at the freezing point, and, one day, it was only 4° above it at 12 o'clock. Even the grapes in the vineries do not ripen. I am told, by one of our principal nurserymen, that *Campánula pyramidalis* will stand our most severe winters in the open ground, provided it be not covered ; if covered, it rots. I shall try it this winter. Professor Schouw's *Geography of Plants* is an excellent work which you should translate from the German, and publish in your *Magazine of Natural History*. Rothe (a young gardener of education) has published his horticultural tour in Germany, Holland, France, and Upper Italy, in

Danish ; I shall send you a translation of it, with remarks. I am, Sir, yours, &c. — *Jens Peter Petersen.*

*Garden Library.* — M. Petersen, C.M.C.H.S., has lately been appointed successor to the celebrated Danish court-gardener, Lindegaard, and has commenced forming a garden library. We have sent him our *Encyclopædia of Plants*, and one or two other volumes ; and if any society or gardener has any duplicates, and feels disposed to assist M. Petersen, they may be addressed to him, to be left at Mr. Bérgröm's, 10. Tottenham Court Road, London. — *Cond.*

#### SWEDEN.

*Maritime Schools* are established in Sweden in all the sea-ports, and a law passed, by which, from the 1st of January, 1829, no captain of a ship shall enjoy the rights of a Swedish citizen who has not previously received from the superintendant of the said schools, or from a naval officer duly authorised, a certificate of his having been examined and found in every respect duly qualified. (*Unit. Serv. Jour.*)

#### SWITZERLAND.

*Liquid Manure.* — The farmers of German Switzerland give the name of *gülle*, in French *lizier*, to the liquid manure obtained from their stalls and stables, and collected into underground pits or reservoirs, in which it is allowed to ferment in a mucous or slimy state. The manner of collecting it, adopted by the agriculturists of Zurich, is as follows :— The floor on which the cattle are stalled is formed of boards, with an inclination of 4 in. from the head to the hinder part of the animal, whose excrements fall into a gutter behind, in the manner usual in English cow-houses. The depth of this gutter is 15 in., its width 10 in. ; it should be so formed as to be capable of receiving at pleasure water to be supplied by a reservoir near it : it communicates with five pits by holes, which are opened for the passage of the slime, or closed, as occasion requires. The pits, or reservoirs of manure, are covered over with a floor of boarding, placed a little below that on which the animals stand. This covering is important, as facilitating the fermentation. The pits, or reservoirs, are made in masonry, well cemented, and should be bottomed in clay, well beaten, in order to avoid infiltration. They should be five, in order that the liquid may not be disturbed during the fermentation, which lasts about four weeks. Their dimensions should be calculated according to the number of animals the stable holds, so that each may be filled in a week : but whether full or not, the pit must be closed at the week's end, in order to maintain the regularity of the system of emptying. The reservoirs are emptied by means of portable pumps. In the evening the keeper of the stables lets a proper quantity of water into the gutter ; and on returning to the stable in the morning, he carefully mixes with the water the excrement that has fallen into it, breaking up the more compact parts, so as to form of the whole an equal and flowing liquid. On the perfect manner in which this process is performed, the quality of the manure mainly depends. The liquid ought neither to be thick, for then the fermentation would be difficult, nor too thin, for in that case it would not contain sufficient nutritive matter. When the mixture is made, it is allowed to run off into the pit beneath, and the stable-keeper again lets water into the trench. During the day, whenever he comes into the stable, he sweeps whatever excrement may be found under the cattle into the trench, which may be emptied as often as the liquid it contains is found to be of a due thickness. The best proportion of the mixture is three fourths of water to one fourth of excrement, if the cattle be fed on corn : if in a course of

fattening, one fifth of excrement to four fifths of water will be sufficient. (*Bull. du Comité d'Agri. de la Soc. des Arts de Genève.*)

This mode of increasing the manure produced by stalled cattle and cows is in general use in Holland and the Netherlands, and we have seen it practised in France, at Trappe and Grignon, near Versailles; at Roville, near Nancy; at Ebersberg and Schleissheim, near Munich; and at Hohenheim and Weil, near Stuttgart. We would strongly recommend the practice to the British farmer, and not to the farmer only, but to every cottager who keeps a cow or pig; nay, to the cottager who is without these comforts, but who has a garden, in which he could turn the great accession of manure so acquired to due account. Let him sink five tubs or large earthen vessels in the ground, and let the contents of the portable receiver of his water-closet, all the water used for washing in the house, soap-suds, slops, and fermentable offal of every description, during a week, be carried and poured into one of these tubs; and if not full on the Saturday night, let it be filled up with water of any kind, well stirred up, the lid replaced, and the whole left for a week. Begin on the Monday morning with another tub; and when, after five weeks, the whole five tubs are filled, empty the first at the roots of a growing crop, and refill; or use two larger tubs, and continue filling one for a month; then begin the other, and at the end of a month empty the first; and so on. — *Cond.*

#### GREECE.

*Lancasterian Schools in the Ionian Islands.* — Sir F.A. spoke to me about establishing Lancasterian schools at Corfu and in the other Ionian Islands. It would be very desirable, because these islands would form a point from which education might be extended over the adjacent continent; and it would probably much forward it in Italy, where superstition and bad governments will oppose it. I should not despair of making the Turks adopt it in time, if it were introduced without any attempts at proselytism, and the lessons consequently adapted to their religion. (*Wood's Letters of an Architect*, vol. ii. p. 586.)

#### INDIA.

*Of the State of the Schools and of Education in India*, Bishop Heber, in his *Journal*, speaks rather favourably; and is very desirous that, without any direct attempt at conversion, the youth should be generally exposed to the humanising influence of the New Testament morality, by the general introduction of that venerated book, as a lesson book in the schools; a matter to which he states positively that the natives, and even their Brahminical pastors, have no sort of objection. (*Ed. Rev.*, Dec. 1820, p. 535.)

#### MADAGASCAR.

*General Education in Madagascar* seems to be making very considerable progress. From the second report of the Madagascar Missionary School Society, it appears that there are 38 schools and 2,309 scholars, and that what is called the king of the country is very favourable to these schools; and from a note in the *Evangelical Magazine*, it appears that the schools have been increased, since the report was published, from 38 to upwards of 90. (*Evangel. Mag.*, March, 1829.)

#### NORTH AMERICA.

*The Aracacha Plant of Bogota and New Grenada in Colombia* "has not, that I know, been as yet cultivated with any promising results. From the failure to propagate it in maritime and northern regions, I despair of obtaining any benefit from its abundant and nutritious roots. The late Baron de Shack wrote me, that, although it vegetated in Trinidad Island,



there was an expenditure of the whole vegetative effort in producing herbage and upper growth; while there was not a single tuber, but only fibrous roots, under ground. Under this view of the case, I am inclined to the belief that, whether it be an *Apium*, as commonly supposed, or a *Cònium*, as others say, it is a native of very elevated tracts, and will, in all likelihood, require a long and patient course of experiments to reconcile it to low lands and places near the sea; if, indeed, that object can be effected at all." (S. L. Mitchell, in *New York Farmer*, Nov. 1828.)

*Agricultural Societies.* — Addresses to the Charleston, South Carolina, and St. John's Agricultural Societies, by Messieurs Horry, Seabrook, and Townsend have been sent us. It is gratifying thus to mark the spread of agricultural science and industrious pursuits. An infant state of things is precisely that state in which societies can be of real use to the public: in a more mature state they become monopolies, and while they do good on the one hand, do harm on the other. The Horticultural Society of London is as much a monopoly as the East India Company: both monopolies did good at first, and both are now, to a certain extent, oppressive to the free industry of individuals. The three addresses alluded to are written with very considerable ability and knowledge of the subject; and we speak with the utmost impartiality when we say, that, during the rage for agricultural societies which existed in this country some years ago, no one address appeared, not even those of Sir John Sinclair or Arthur Young, at all to be compared with them, either for extensive knowledge of the subject, or sound general views on agricultural legislation. — *Cond.*

*A Quantity of Rhubarb and Sea-kale Seeds* has been sent us by Mr. Hale Jessop of Cheltenham, and by Messrs. Noble and Co. of Fleet Street, in compliance with our invitation (Vol. IV. p. 501.), for the Horticultural Society of Pennsylvania. We forwarded these seeds in February last, through Mr. Charwood of Russel Street, to Messrs. Thorburn of New-York, to be sent by them to Dr. Mease of Philadelphia. We have also more recently sent Messrs. Thorburn a few of our pamphlets on Education (p. 70. note), to be forwarded by them to some of our friends in America, to which we request their particular attention. — *Cond.*

#### AUSTRALIA.

*Sydney, May, 1829.* — I have now been here eight months. Notwithstanding all the care I took to acquire a knowledge of this colony and country before I left Scotland, you can hardly conceive how little I knew about them on my arrival. First, as to the feelings of the people, and the tendency of public opinion, I am sure that very few people in Britain know what these are. Would you believe it possible that the majority of persons in this country are thirsting after independence and a government of their own; and that, instead of having any desire to return to the mother country, they view it with indifference, or even hatred? Such, however, is the case. We are here in two parties, far more violently opposed than Whigs and Tories, or Catholics and Protestants, are in Britain. One party, by far the more powerful, but forming not a hundredth part of the population, consists of those government officers and commercial speculators who think of making fortunes, and returning home again; the other is composed of the settlers, who think of remaining, and forming a country and government of their own. . . . There is no regular chance of making money in this country; nor can I conceive that there will be, for generations to come. The principal article of export at present is wool; but that will never afford much profit, because it can be produced here to an unlimited extent, at almost no expense. I have no doubt the Australians will, in a few years, attain their grand object, that of underselling all Europe in this article. The climate and the pasture are formed for sheep; and the wool is superior to that of Saxony or Spain. The great thing which we want here is labourers; and I should think your government might contrive some means of sending out the super-

fluos population without loss. You will be shocked at the idea that I am going to mention to you, which is that of government making it legal for captains of ships and others to purchase the labour of such men and women in England as might volunteer themselves, for a certain number of years, say seven, and take them abroad to any British colony to be previously agreed on by the purchaser and seller, and there dispose of the term yet to run of their lease. I acknowledge, this seems a very harsh mode of supplying us with labourers; but, as a general principle, I believe you will agree with me that the service to both countries will be performed much more effectually when it is made the interest of individuals to do it, than when it is done by government. A single act of parliament, comprising all the necessary details, would set the whole of this matter to rights, and effect an inconceivably great service to this country, and, I should think, also to England. — *R. S.*

---

### ART. III. Domestic Notices.

#### ENGLAND.

*BLenheim House*, the once proud seat of the illustrious Marlborough, presents now but a melancholy and almost desolate appearance to the visitor. The courtyards are overgrown with grass, and the wallflower has introduced itself beneath the colonnade. Many of the windows are broken, and the ripples of the beautiful lake are intercepted by weeds, which luxuriate in all the perfection of undisturbed possession. (*Berks Chronicle*.)— If the laws relating to landed property were just and equitable, Blenheim House and all its dependencies would long since have been sold for the benefit of the creditors. But the probability is, that if the estate had not been entailed, the sale of Blenheim would not have become necessary. Good, however, will result from this example of the abuse of aristocratical privilege; before any disease can be cured, it must come to what is called by physicians a crisis: in this view a bad duke may be better than a good one. — *Cond.*

*Gardens for the Poor.*— The Earl of Clarendon has appropriated to the use of the poor at Wootton-basset, fifty acres of land for gardening purposes, thereby materially contributing to the comfort and advantage of nearly a hundred families. A more general adoption of this system would be highly desirable, inasmuch as it insures important benefits to the poor, and greatly tends to encourage in them habits of industry and sobriety. (*Devizes Gazette*.)

If, in addition to such benevolent, and, in the end, advantageous, practices, proprietors would establish schools, and make it a condition in the leases of the cottages, that all the children born or brought up in them should undergo a certain degree of tuition, the benefit to the country and the individuals would be great; otherwise it might, to a certain extent, aggravate, at a future time, the evil to which it is a present relief. — *Cond.*

*Artesian Wells.*— At a late Meeting of the Institution of Civil Engineers, it was stated as an ascertained fact, that a supply of water equivalent to the wants of even one district of the metropolis cannot be obtained from the water-bearing strata beneath the blue London clay. (*Literary Gazette*.)

*Mr. Mackay*, of the Trinity College garden, Dublin, is now on a horticultural tour in this country. He informs us that there is a horticultural society in Dublin, which holds regular meetings and distributes prizes, which we are happy to hear, notwithstanding the indifference of its secretary in not sending us now and then a newspaper containing an account of its transactions. — *Cond.* Sept. 10.

*The Cycas revoluta* (Vol. IV. p. 162., fig. 59.) has lately been in full fructification at Wentworth House, Yorkshire; I believe it to be the second instance only of its having flowered in England.—*J. S. H. Cambridge, Sept. 5. 1829.*

*A Strawberry*, measuring  $7\frac{1}{4}$  in., and weighing nearly  $1\frac{1}{2}$  oz., was gathered on Friday, at Birdholme, near Chesterfield. (*Hull Advertiser*, July 10.)

*A Snake Cucumber* (*Cucumis flexuosus*), 6 ft. 8 in. long, and 1 in. diameter at the largest end, furrowed, but straight from having been grown in a hanging state, has been received from *R. F. August 2. 1829.*

*Gigantic Asparagus*.—Sixty heads of asparagus were sold in Leeds market, last week, which weighed upwards of 7 lbs. (*Yorkshire Gazette*, June 6.)

*Large Cauliflowers*.—On May 30. Mr. Anderson, gardener, in Mickle-gate, cut a cauliflower, which weighed  $3\frac{3}{8}$  lbs., and measured 2 ft. 4 in. in circumference. On looking over his garden, June 4., he saw a much larger cauliflower, which he cut, and found that it weighed 4 lbs.  $8\frac{1}{2}$  oz. and measured 3 ft. in circumference. (*Wakefield and Halifax Journal*, June. 5.)

### SCOTLAND.

*Edinburgh Green Market*.—*August 21.* Grapes 1s. 8d. to 2s., cherries 8d., and melons 1s. 6d. to 2s. per lb.; black currants, 6d., red, 4d., gooseberries 4d. to 6d. and raspberries 6d. old Scotch pint; peaches and nectarines from 5s. to 8s., and apricots from 1s. to 1s. 6d. a dozen; geans 6d. to 9d. a lb. Prematures, Gold Naps, Crawford's, and Jargonelle pears are now ripe, and selling at reasonable rates. Cucumbers bring from 3d. to 6d. each; green peas from 8d. to 1s. 2d., and beans from 6d. to 10d. a peck. (*Scotsman*.)

*Caledonian Horticultural Society*.—In our last we endeavoured to give a description of the promenade which took place on July 2., in the experimental garden of the Caledonian Horticultural Society at Inverleith. We now submit a correct account of the award of prizes which took place on that occasion:—

For the best three carnations, from seedlings of the preceding year, only one parcel was produced; these, however, were regarded as good, and the thanks of the Society were voted to Mr. Thomas Spalding, gardener to Mrs. Macnab at Arthurstone, who was found to have sent them.

For the best six seedling pinks, from seeds of the previous year, five competitors appeared. After a careful comparison, the premium was awarded to Mr. Spalding at Arthurstone. Another collection of seedling pinks was considered so excellent, that a copy of the last volume of the Society's *Transactions* was voted to the cultivator, Mr. Allan Carsewell, Newington Place, as a mark of approbation.

For the best garden rose, double or semi-double, from seed saved in Scotland, within the three preceding years, the Society's silver medal was adjudged to Mr. J. Howie, gardener, Perth Road, Dundee. The Committee reported, that on proceeding to examine the merits of the competition articles under this head, they were agreeably surprised with a remarkable exhibition of seedling roses from Messrs. Charles and John Peacock, who transmitted a basket with their engraved card attached to it, containing no fewer than twenty-four kinds, raised from seed saved from their own rich collection at Stanwell Lodge in 1825. But, although the Messrs. Peacock had precluded themselves from competing by attaching their name to the basket, the Committee did not hesitate to recommend the award of an extra-medal, for such a very unusual display of new roses. Messrs. Peacock also exhibited a fine display of Dutch roses, amounting to one hundred named varieties. A very beautiful seedling rose having been sent by Mr. William Henderson, gardener to Sir Alexander Muir Mackenzie of Delvine, Bart., the last part of the Society's *Transactions* was voted to Mr. Henderson, as a mark of the approbation of the Committee.

For the six finest exotic plants, the medal was found due to Mr. Donald M'Rae, gardener to George Dunbar, Esq. Rose Park, Trinity. Under the head of exotics also, the Committee felt constrained to recommend an extra-medal to be given for a superb collection transmitted by Mr. William Macnab, superintendent of the Royal Botanic Gardens, which were merely sent for exhibition. Most of these plants were of great rarity, all of matchless beauty, and evincing the utmost perfection in culture, particularly the heaths, a class of plants, in the treatment of which, all who have visited the Royal Botanic Gardens must admit Mr. Macnab to excel. The Committee were likewise much pleased with the plants which were sent from the garden of the Secretary at Canonmills, which were both rare and well cultivated. The last part of the Society's *Memoirs* was accordingly voted to Mr. Alexander Scott, gardener to Mr. Neill, in testimony of his professional merit.

No competitors appeared for the premiums offered for the best quart of American Scarlet Strawberry or of the Duke of Kent Strawberry, on account of which much regret was expressed. (*Edinb. Advert.*, July 10.)

*Caledonian Horticultural Society.*—The Anniversary Meeting of this Society was held Sept. 5. in the hall of the Royal College of Physicians, Daniel Ellis, Esq., one of the Vice-Presidents, in the chair, when several new members were admitted, and the Report of the committee of prizes read, from which it appeared, that, at the competition in the Society's apartments on the preceding day, prizes were awarded as follows:—

Four sorts of peaches, from open walls, without artificial heat, three of a sort, with their names, Mr. James Stewart, gardener to Sir J. Hope, Bart., Pinkie House. Four sorts of peaches, from flued walls, without glass, three of a sort, Mr. Jas. Scott Thomson, gardener to Viscount Strathallan, Strathallan Castle, by Crieff. Three sorts of nectarines, from flued walls, without glass, three of a sort, Mr. Thomas Inglis, gardener to William Ramsay, Esq., of Barnton. Six sorts of plums, six of each sort, with names, Mr. Jas. Young, gardener to John Richardson, Esq., of Pitfour, by Perth. Two imperial quarts of retarded gooseberries, three sorts, red, white, and yellow, with their names, &c., Mr. William Oliver, gardener to the Earl of Rosslyn, Dysart House. Four sorts of summer pears, six of each sort, with their names, Mr. William Oliver, Dysart House. Queen pine-apple, Mr. John Mitchell, gardener to Sir David Moncrieff, Bart., Moncrieff House. Pine-apple of any other variety, Mr. Walter Henderson, gardener to W. F. Campbell, Esq., Woodhall. Cantaloup Melon, Mr. James Anderson, gardener to John Bonar, Esq., Ratho House. Highest-flavoured green-fleshed melon, Mr. John Mitchell, gardener, Moncrieff House. Three bunches of Frontignac grapes, three different sorts, Mr. James Simpson, gardener to Capt. Wemyss, M. P., Wemyss Castle. Two finest and heaviest bunches of black Hamburgh grapes, Mr. John Kinmount, gardener to Miss Yeoman of Murie, by Errol. Best grapes, of three different sorts, and two bunches of each, with names, Mr. James Goodall, gardener to the Marquess of Lothian, Newbattle. Two sorts of figs, three of each, Mr. William Pearson, gardener to Dowager Countess of Hopetoun, Ormistoun Hall. Six kinds of summer apples, six of each kind, Mr. David Sinclair, gardener to James Donaldson, Esq., Broughton Hall. Six double or semi-double georginas, from seed saved in 1827 or 1828, Messrs. Dickson and Co., nurserymen, Leith Walk. An extra-medal was awarded for the greatest variety of fruits, of good quality, to Mr. Macnaughton, gardener to John Wauchope, Esq., Edmonstone. Extra-medals were awarded to Messrs. William Henderson, gardener to Sir A. Muir Mackenzie, Bart., Delvin, and William Todd, gardener to the Hon. Mrs. Norton, Abbeyhill, for new seedling China roses. For the best home-made gooseberry wine, to Mr. Lewis Pederaner, Halyburton House, Cupar-Angus. An extra-medal for elder-flower wine, of excellent quality, to Mrs. Campbell, of Ormsary, Argyleshire.

The Meeting unanimously approved of the Report of the Committee, after which, the Chairman addressed the meeting in nearly the following terms:—

“ When I had the honour of addressing you in June last, I submitted to you a few remarks on the comparative coldness of the preceding months and the consequent retardation of vegetation in all the departments of horticulture. I stated this condition of climate to have prevailed very generally throughout England; and we have since learned that it extended to neighbouring countries, particularly to France. Hence it has happened that, contrary to ordinary experience, the actual period at which various flowers and esculent vegetables were produced was, this season, pretty nearly the same in all parts of Great Britain. Of this fact, a striking illustration soon after appeared in some of the public papers of this city, in which it was stated that, in a former year, a dealer in Edinburgh, who had imported green peas from London, which he was enabled to sell at *2s. 6d.* when the market price in Edinburgh was *4s. 6d.* per peck, had tried the same experiment this year, but not with the same success; for the green peas were nearly as early with us this season as with our neighbours in the south, and could not be purchased in Covent Garden Market at a price that enabled the dealer to undersell the native grower. It was stated, also, on the occasion before alluded to, that though vegetation had been kept back some weeks beyond its ordinary progress in this country, it had at length come forward with so much vigour, and the blossom on the fruit trees was then so general and so fine, as to hold out the promise of a more than usual production of late fruit. This promise, with regard to the actual crop, especially of the hardier fruits, has not disappointed expectation; but, from the unusual prevalence of rain, and deficiency of sunshine, the period of growth has not ceased sufficiently early, but has run, as it were, into that, which, in other years, has been employed in the ripening process. The fruits, therefore, of various kinds, which were sent in yesterday for competition, as raised in the open air, were inferior, both in number and quality, to what they have usually been. This was more particularly remarkable as to the more delicate kinds of fruit, as peaches, nectarines, and apricots, the best specimens of which were not deemed to possess the rich flavour and mellowness they acquire in better seasons, and many of them were far from being ripe. Of apricots not one sample was sent in for competition, whilst in 1826, the Fruit Committee was summoned at least three weeks before the ordinary time of meeting, to inspect some uncommonly fine apricots, remarkably alike, both for size and quality, and which were then advancing fast to the condition of over-ripeness. The more hardy fruits sent in for competition, as apples and pears, were not deficient in size, but few of those which appeared to have been recently plucked from the tree had reached maturity, and the greater number were far short of it. Of course, the fruits raised in stoves and hot-houses are little affected by the lowness of atmospheric temperature; but even these may be expected to suffer in some of their finer qualities from the deficiency of sunshine. It was partly from this failure in the fruits of natural growth, and in part too from the very unfavourable state of the weather for some weeks past, that the Committee appointed to make arrangements for the projected fête in the garden, which was to have been held this day, deemed it prudent, after mature deliberation, to abandon it altogether for this season. They did not wish to incur the responsibility of putting the Society to the expense of such an exhibition when there would have been so much difficulty in procuring a sufficient supply of good fruit; and when the season was so precarious, that little dependence could be placed on an adequate attendance of company, especially at the time when the more influential classes of the community were absent from town. They were also of opinion that a failure in a first attempt at an exhibition of this kind might go far to ob-

struct success on any future occasion. The Committee, however, remained fully of the opinion that a promenade, such as was proposed, might be rendered extremely acceptable to the public, and in its effects advantageous to the Society. But they seemed to think that it should take place at an earlier season of the year; and that although it would not then be possible to exhibit any great variety of the finer fruits, yet that compensation for this single disadvantage would be found in the superior fineness of the season, the greater beauty of the garden, the fulness of the town, and the number and rank of those who might then take an interest in the Meeting. In connection with these remarks, and as giving new importance to the subject to which they refer, I may mention, that, in order to meet the increasing desire of the community for this kind of horticultural produce, the magistracy of this city have lately formed a fruit-market of great extent, where fruits are sold by wholesale. This new market for several Saturdays past has been crowded with carts, filled with vast stores of the smaller fruits, as summer apples, pears, &c., and the Society will participate in the satisfaction of learning that hitherto the demand has fully kept pace with this augmented supply.

“I have only to mention that a treatise on an interesting subject has just been presented to the Society, which the author wishes should be made known to its members. It is a *Treatise on the Insects most prevalent on Fruit Trees and Garden Produce, with an Account of their History, the Depredations they commit, and the Recipes used for their Destruction*, by Mr. Joshua Major. The author, under the several heads of the trees, shrubs, and herbs, cultivated in our gardens, gives a list and description of the different insects which severally infest them, and the means which have been used either by himself or others to effect their destruction. As the work has but just been received, little can be said of its execution, but it seems to treat of the several points relating to this very interesting subject on a more comprehensive plan, and in a more practical way, than any work yet written upon it. Should any member consult it, and put in practice any of the recipes recommended by the author, the Society will be glad to hear the result of his trials, or to learn any information respecting the varieties of insects which attack different trees as enumerated by the author, their natural history or habits as related by him, and the efficacy of any means that may seem best adapted to counteract their depredations, or to destroy them.”

Mr. Robison begged to corroborate what had been stated by Mr. Ellis in regard to the backwardness of the season. He had access to know that, even in the south of France, the weather has been equally unpropitious for horticultural experiments.

The Secretary then stated, that, along with other communications, he had received one from Sir John Sinclair, giving an account of his having discovered a beautiful dye, extracted from the flower of the potato, and along with it a piece of very fine woollen cloth. The specimen sent was of a beautiful bright amber colour, admirably adapted for ladies' shawls.

In the afternoon, the Society, to the number of about 120, met in the Waterloo Tavern, to celebrate its twentieth anniversary, where an excellent dinner was served up by Mr. Steventon. The dessert, which consisted of the fruits competed for, was served up in no fewer than 300 dishes; of these, fifty plates were grapes, eighteen melons, and several pine-apples. Dr. Hope, Professor of Chemistry, was chairman, and Mr. A. Dickson and Mr. J. Linning, croupiers. After the usual loyal toasts were given, the prosperity of the Horticultural Society was drunk with great enthusiasm. This was followed by a toast to the memory of Dr. Duncan. Dr. Hope, in proposing it, described the doctor as a man whose amiability of disposition often led him to the performance of acts of kindness far beyond his means. He described him as the father and founder of the Royal Public Dispensary, the Lunatic Asylum, and the Caledonian Horticultural Society. The healths of Daniel Ellis, Esq., and the vice-presidents; Patrick Neill, Esq., the secre-

tary; the treasurers, Mr. Dickson and Mr. Linning; Professor Dunbar and the Committee of Prizes; the successful competitors, and the unsuccessful competitors, were given and drank with great applause. The conviviality of the Meeting was much enlivened by the vocal powers of Messrs. Kenward, Smith, and Gleadhill. (*Edinburgh Advertiser*, Sept. 4.)

*Aberdeenshire Horticultural Society.* — A Competition was held in Aberdeen on July 15., when the judges awarded the prizes as follows : —

*Flowers.* Pinks : 1. William Barron, gardener, Blackhall ; 2. Geo. Johnston, gardener, Haddo House. Seedlings (best six) : 1. James Mennie, gardener, Hardgate ; 2. Captain John Clyne, Aberdeen. Irises : 1. Mr. Wm. Davidson, jun., Aberdeen ; 2. Alexander Diack, Mile-end. Roses. Double : 1. William Chalmers, gardener, Loch-head ; 2. Alexander Bell, Esq., Marywell Place. Seedlings : 1. Diack's Ecyd Rose, Mr. Alexander Diack, Mile-end ; 2. John Roy, jun., seedsman, Aberdeen. — *Fruit.* Melon : 1. William Anderson, gardener, Cornhill ; 2. George Forbes, Esq., Springhill. Gooseberries : 1. and 2. Alexander Malcolm, gardener, Damside. Currants : 1. William Smith, gardener, Grandholm Cottage ; 2. Peter Archibald, gardener, Park. Strawberries : 1. John Davidson, Dunottar House ; 2. Alexander Malcolm, gardener, Damside. Cherries : 1. George Johnston, gardener, Haddo House ; 2. John Wood, gardener, Logie Elphinstone.

The Society's large medal, with a premium also, as an extra-prize, was awarded to Alexander Malcolm, gardener, Damside, for a species of very superior new seedling strawberries.

The show, particularly in strawberries, irises, pinks, roses, &c., was very fine. There were also various packages of rare plants in pots from the gardens of Messrs. J. Walker, W. Davidson, jun., and James Forbes, Broadford. The prize melon (*Willox's Fame*) from the garden of Mr. Young, Cornhill, weighed  $7\frac{1}{2}$  lbs., and was highly flavoured. William Simpson, Esq., advocate, was elected a member.

Upon this occasion, the president, Mr. Crombie of Phesdo, presented to Mr. John Davidson, gardener, Dunottar, the London Horticultural Society's large silver medal, voted to Mr. Davidson by this Society last year. (*Aberdeen Journal*, July 22.)

*Dunfermline Florists' Society.* — A Show was held on June 19., when the best six ranunculuses were adjudged to Mr. David Hutcheson ; the second to John Duncan ; the third to Wm. Meldrum ; the fourth to John Angus ; and the fifth to D. Inglis. The heaviest twelve early potatoes were produced by Mr. William Anderson ; the second by James Beveridge ; the third by Robert Sinclair ; the fourth by John Duncan ; and the fifth by Wm. Meldrum. The heaviest six early turnips were produced by James Elder ; the second by J. Inglis ; the third by Robert Sinclair ; the fourth by David Hutcheson ; the fifth by D. Inglis ; and the sixth by William Meldrum. (*Scotsman*, July 1.)

*Library of the Falkirk School of Arts.* — In addition to the many valuable volumes which this institution can now boast of having in their library, Lord Dunmore, with that liberality which distinguishes his family, has this week given a very valuable donation of 21 volumes on science and history. (*Scotsman*, June 24.) We feel great pleasure in recording donations of this description, scarcely knowing any way in which a man of property can do more good to his neighbourhood. Were such schools, libraries, museums, and gardens, as we contemplate, established in every parish, we have no doubt the donations to them, from the surrounding proprietors and clergymen, would be considerable ; and as there can be no doubt that every future author would send a copy of his works to his native village, and every painter and sculptor a specimen of his works, for the approbation of his townsmen, the accumulation of interest of mind and of power which would thus be made in every village and hamlet, would produce effects on human character and happiness in this country, of which it is difficult to foresee the result. — *Cond.*

ART. IV. *Calls in Hertfordshire, Bedfordshire, Berkshire, Surrey, Sussex, and Middlesex.*

LONDON to Flitwick House. July 22. — It happens that the most direct route from Bayswater to Flitwick House is by secondary roads and lanes, so quiet and rural, that such a proprietor as the Duke of Bedford, riding along them, might fancy himself on his own estate. As we passed Cannons, at Edgeware, the magnificent and truly aristocratic idea of the Duke of Chandos recurred to our mind, viz. that of having a straight avenue from his house here to his house in Cavendish Square, a distance of above nine miles, entirely on his own estate. Had he lived but a few years longer, it is said he would have realised the idea, as he had succeeded in purchasing every thing necessary but a small spot at Paddington. We can conceive something of the feelings of a man thus desirous of isolating himself from general sympathies, and of the kind of enjoyment which results from being looked up to and flattered, and from the conscious possession of great power; but we cannot conceive that this species of happiness is at all to be compared with that which would be sympathised in by the whole of human nature; with that, for instance, of a man cultivating his own acres, and happy in his wife and children. At the same time, the enjoyment produced by every natural feeling depends so much on its cultivation, that any state of existence may yield happiness by being made the most of; and, without some degree of cultivation, no state, either of riches or poverty, will yield much. Notwithstanding the *beau ideal* of an English yeoman or an American farmer's manner of life, there are few states of existence duller or less enviable than that of an ignorant man and woman working hard on their own farm. To the uncultivated who know any thing better, such a state can only be rendered bearable during a certain period of life, from the interest which man, in common with all animals, takes in bringing his offspring to maturity. By the time that work is completed, such parents as those to whom we have alluded will have become habituated to dullness.

To return to Cannons and the Duke of Chandos: what must strike every one as the most remarkable feature in the character of this duke, is his regulated magnificence; his employing the best calculators to ascertain exactly to what extent he might carry his annual expenditure without exceeding his income, and how that income might be expended so as to produce the most brilliant effect. The magnificence of the house is still talked of by the old people in the neighbourhood. The principal staircase consisted of blocks of Italian marble, 20 ft. long, and the hand-railing was of silver. This house has long since been pulled down, but the lodges at the entrance gates still exist, and are so ample in their dimensions, and commodious within, as to have been let, at different times, as country-houses, to gentlemen of the rank of esquires, magistrates, and officers in the army and navy. The duke had a horse-patrol, which perambulated the boundaries of the park, by night and day; a body-guard; a band of music for general purposes, and one or two eminent musicians for joining them on grand occasions, and leading the church music. That the whole establishment should have been broken up at his death is looked on by some people as a visitation of Providence, for certain alleged irregularities in the mode (in the army, and by marriages) by which he acquired his immense fortune; we know of nothing on record, however, that indicates him to have been less honest than other men of like rank in his time. Perhaps, indeed, he may be considered as superior to his contemporaries; not only in having made such an immense fortune, but in having spent it with so much magnificence and liberality. We would much rather see such an establishment as Cannons demolished, than such a one as Blenheim kept up to the ruin or injury of creditors, and to the protection of disgraceful conduct from its natural consequences. We should be



sorry to see one stone of the palace of Blenheim touched, or the park diminished by one acre; but not so to see the family of Marlborough made subject to the like penalties with other men. In the present stage of civilised society in Britain, there ought to be no special laws by which certain individuals may, with impunity, set the general laws of society at defiance.

No outlet from London has been more improved within the last fifteen years than the road to Edgeware, which, from passing through naked grass fields, with, here and there, a miserable cottage, farm-house, or a hay-barn, is now bordered by villas and gardens, vying with each other in architectural taste, in the display of flowers, exotic trees and shrubs, and in what no foreigner can form an idea of who has not been in the country, English turf and gravel. The hills on the road have been lowered, the direction of the road straightened, its width regulated, and its surface Macadamised. A nursery at Edgeware, founded by Mr. Greg, an industrious Scotch gardener, nearly 40 years ago, has now extended to a number of acres. He yielded up his interest in the nursery to his son, on consideration of an annuity to retire on; a plan of life rarely yielding the happiness it promises, and ruinous to all parties in this case. We mention the circumstance as a cautionary hint to other gardeners, and to parents in general. The churchyard has been enlarged, and surrounded by an elegant iron railing; we wish two dozen of exotic trees, and as many shrubs of so many distinct species, had been scattered over the surface, the walks better arranged, gravelled, bordered with trees and a few perennial flowers, and a few creepers planted against the church; but one step on the road of improvement having been taken, these and others will, no doubt, succeed in due time. New almshouses are building a little beyond Edgeware. We confess we do not like the sight of such buildings perpetually recurring through the country, as if it were a condition of human nature that a certain portion of society must live on alms. We would rather see a parochial school-house, library, museum, and garden; and we can prophetically see such buildings rising up from the hands of local architects and builders, by command of parliament and the vestries, all over the country.

The road from Edgeware to St. Albans is very retired, and almost wholly pastoral or agricultural. Some few of the cottages and gardens which border it appear comfortable; but not many. The doors of those of the lowest class were open, and we could see mothers and their children seated at little tables, with cups and saucers and a small loaf before them, but without a table-cloth; the men, doubtless, at work in the fields, had carried with them their bread and bacon. The landlord of the public-house at Ellestree, a man apparently more than usually religious, described to us the manner in which three men had, ten days before, been drowned in the reservoir. Four companions, somewhat intoxicated, went to take a sail on the Sunday afternoon, and fell overboard; only one of them, who could swim, was saved. They were single men, and bad characters; and the parish, he observed, would be rather a gainer by their loss than otherwise. How dreadful to have such a tribute to one's memory paid by a neighbour! The very idea of it seems enough to reform a man. A new inn in the outskirts of St. Albans, in the Dunstable road, has an ample garden, not made the most of. Such a piece of ground, and a gardener of taste, would give an inn so situated so great a superiority, that every body would be tempted to stop there; but the garden of this Boniface exhibits but the beginning of a good idea. Every thing that creates an allusion to home ought to be encouraged at an inn; and, therefore, every place of entertainment, from the smallest hedge-alehouse upwards, ought to have a large garden, a library more or less extensive, a book of country maps, a road-book, a Shakspeare, a Don Juan (purified copies, of course), a newspaper, and one periodical or more. In many parts of Germany, the commonest

public-houses have pianofortes, because there all are musicians and dancers. Freedom from national debt, and a thorough general school education, *high and equal* (*Mag. Nat. Hist.*, vol. ii. p. 76.), would soon render us so, and, in fact, make us every thing to which man, in our latitude, may hope to attain. The road to Dunstable has been greatly improved by that first of road-makers, as Macadam is the first of road-menders, Mr. Telford. At Dunstable, notwithstanding the number of workers in plait-straw, we could find no one to undertake the manufacture of our Epinal hat. (Vol. IV. p. 491.) The objection was, that the straw did not require to be plaited, that the hats were only calculated for poor people, and that the poor would never buy a thing that was in no case used by the rich; an argument from which the rich may learn how to introduce good fashions among the poor. The very small village of Flitwick is composed of as miserable cottages as any in England; the inhabitants, following no manufacture, and having very little agricultural employment, derive a great part of their scanty subsistence from the poor-rates. The men are said to be almost all poachers, and three fourths of them, we were told, had been on the tread-wheel; some had been transported, one belonged to the Cato Street conspiracy, and one or two have been hanged. At church, on Sunday (July 26.), very few men attended, and the congregation consisted chiefly of young women and children, by no means healthy for a country population. We were not much surprised at hearing two marriages announced; for, when mankind are in a state of degradation and suffering, there is nothing to restrain them from doing all they incline to do; and every thing will be resorted to that has any chance of procuring present enjoyment, without reference to future consequences. The marriages of poor people are always prolific in children; they do not always grow up; but their births and deaths are at least food for the church, as poaching is for the magistracy and the lawyers. The clergyman had an excellent discourse on contentment, and against covetousness!

*Flitwick House*; John Thomas Brooks, Esq. — We have already mentioned this place (Vol. III. p. 246.) as a pattern of order and judicious arrangement; and the proprietor is a warm-hearted man, a kind and liberal master, and a great friend to gardeners and gardening. Both the grounds and house have been materially improved since the period referred to, and the whole continues to maintain its high character for good keeping. A public road has been changed in direction, which, while it has added to the beauty and free unrestrained air of the scenery, has, of course, increased the value of the property. There is not a more universal error in improving grounds than that of sacrificing useful arrangement and permanent beauty to the accidental position of existing trees or plantations. Mr. Brooks has had the courage and good sense to free himself from this morbid senseless feeling, and to thin out some plantations, and entirely remove others, which, though beautiful and thriving of themselves, yet tended to counteract the general effect of the place. The arboretum has grown so luxuriantly, that the trees are almost as much crowded as they are in the arboretum of the Chiswick garden; and Mr. Brooks, therefore, very judiciously proposes to distribute them along a shrubbery or plantation walk, at such distances from one another, and from the walk, as will at least admit of their finally attaining their full size. To make room for these trees and shrubs, spaces will be cleared of from 6 ft. to 12 ft. in diameter, among the trees and shrubs already there; and as the arboretum plants increase in size, these spaces will be increased also, by thinning out more trees, so as that the specimens will always stand free of, and untouched by, any other tree. The climbers and twiners will have larch or oak poles terminating in crosslets placed beside them as props, and every species will be named on the ends of bricks, either in Messrs. Loddiges' manner, in that of Mr. Murray of the Glasgow botanic garden (Vol. III. p. 29.), or in the manner which we shall

afterwards describe as about to be adopted by an eminent nurseryman. The length of the home shrubberies and plantations destined to receive this arboretum is about  $2\frac{1}{2}$  miles, so that nothing hitherto executed in pleasure-grounds or ornamental plantations will equal it. Mr. Brooks deserves the highest credit for an improvement which will soon be found productive of so much interest as to be frequently adopted. The ground hitherto occupied by the arboretum and the botanic collection, at Flitwick House, will be laid out as a Natural Arrangement of Herbaceous Plants, combining also an exemplification of each of the classes and orders of Linnæus. A Natural Arrangement will, in a short time, we trust, be as common to every gentleman's seat as a flower-garden; and will, we have no doubt, take the place of the sort of mixed botanical flower-garden in present use almost everywhere, as being much more truly beautiful and intellectual. (Vol. III. p. 300.) Trotter, the gardener here, is enthusiastically devoted to his profession, and much attached to the place and to his master; the latter knows the value of a good servant, and has presented him with a copy of the *Encyclopædia of Plants*. Most employers, we hope, will place this work in the library of their gardens; but Mr. Brooks has not only placed one in his library, for the general use of all his future gardeners, but given one to his present gardener individually. Such attentions on the part of masters to faithful servants are mutually gratifying and beneficial.

*Woburn Abbey*; the Duke of Bedford. July 28. — We have been blamed by some correspondents and readers, who have lately been here, for not saying more of a place which, taking it altogether, is perhaps the very first in England, and at which so many improvements are now going forward. No one has more respect for the high and consistent character of the family which owns this property than we have, because we think there are few families in Britain, to whom estates have passed from the church, that have managed them in a way calculated to do so much good to all the occupiers and dependants; and because we consider Woburn Abbey, and the surrounding farms, as standing examples of good management and rational magnificence. If the great mass of society in England had remained in the state of ignorance in which they were before the abolition of religious houses, we have no hesitation in saying it would have been much more for their happiness that the church property should have remained untouched; and that, instead of the palaces, castles, and mansions of the present nobles and gentry, open only to their friends and equals, we had the monastic abbeys and priories of former times, open and hospitable to all, from the beggar to the prince. But freedom and knowledge have increased by this change of property; instead of depending on voluntary charity, the poor are supported as a matter of right; and, though this last provision of the legislature, has led to the greatest abuses; still, on the whole, the chains of mental slavery have been broken, and we believe human improvement and happiness have gained by the change. The statistics of Woburn Abbey and its dependencies, in 1500 and in 1800, if they could be obtained, would be a striking exemplification of the difference between a society consisting of rich men and slaves, partly beggars, and one consisting of free men, some of them beggars, and some of them rich and powerful, but all of them free, and subject to the same laws. We admire, in the present and late Dukes of Bedford, the simple manners and style of living of the private gentleman, notwithstanding the enjoyment of an income which could command all the personal sumptuousness of a Continental prince. A Duke of Bedford has a legal and prescriptive right to surround his person with all the pomp and splendour, all the lacqueys and trappings, the heralds, the guards, and what not, of a rich duke of the age of Louis XIV. or Charles II.; but a duke of the present day shows great superiority of mind, as well as worldly wisdom, in not doing so. In fact, there is too much good sense in this country for a man to procure himself any sort of credit or applause from his personal retinue; it

is by no means essential to the most dignified actions, and the most munificent hospitality, and we question if, in half a century hence, the establishment of a duke, perhaps even of a British king, will differ much from that of a private man of fortune. It is absurd to suppose that people, when they become free and enlightened, will bolster up a king so highly as they did when they were ignorant, and, comparatively speaking, slaves; or that the enlightened king of an enlightened people should set any value on such bolstering. Formerly, a wig was considered as essential to a physician as it is now to an advocate or a judge; but the physicians have laid aside their wigs for some time, and both the clergy and the lawyers will soon follow their example.

The fine circumstances at Woburn Abbey are, the extent and variety of surface of the park, its unequalled oak groves and evergreen plantations, the commanding situation of the house, the judicious distance and good effect in the view of the village of Woburn, and the beauty of certain pieces of water, as seen from the house. Add to these established features the more recent ones of the grass garden, thornery, nursery, the Northumbrian farm, dairy, aviary, the sculpture galleries, heathery, the very complete kitchen-garden now forming, the salicetum, rockwork, flower-gardens, children's gardens, and other improvements in the pleasure-ground; and the ornamental cottages, with their gardens, in the outskirts of the park, and the principal points of interest will be enumerated; but to describe any of them at present is what we cannot undertake. We hope the Duke of Bedford will authorise his learned librarian, his local draughtsman, and his head gardener, to draw up a description of the whole place, and to publish it at a moderate price, accompanied by a general plan and memorandum views for the benefit of visitors. The profits of sale might go to a fund for aged and infirm servants. We take the liberty of suggesting that, at such places as Woburn Abbey, Wentworth, Blenheim, Stowe, Arundel, and all show places where there is a public day for showing the house and grounds, there should be a portion of that day, say the first time of going round with company, which may commence at nine o'clock, set apart for those who cannot afford to pay. Thus the poorest and humblest individuals would acquire ideas, and be made happy by the gratification of a natural curiosity. We think, also, that in all gentlemen's seats which are considered show places, it would be much more honourable to their owners, and procure more impartial attention to strangers from their servants, to allow the payment for the sight to be voluntarily dropped into a box, as in the case of some foreign show-buildings and gardens, than to have it paid like a physician's fee, as at present. This box might be opened at certain times, and the money apportioned either among all the servants, or chiefly to the aged and infirm, or applied to some other benevolent or enlightened purpose. A portion of the money received in all the gardeners' boxes we would appropriate to the garden-library; and another portion, from the house-boxes, for the supply of books or newspapers for the servants' hall, or for a house-servants' library, or general servants' reading-room. There ought to be one such reading-room about all first-rate places. The custom of dinner-guests giving money to the servants of their hosts on leaving his house, is nearly done away with; and it is time that the expectations of the housekeepers of show-houses (we know cases where, some years ago, the housekeeper would take nothing less than gold, and had this intimated to strangers by previous notice from her maid) should undergo the changes required by the age. We shall, probably, have more to say on this subject when we come to speak of Arundel Castle and Blenheim; in the mean time, we protest against any thing we have said having any particular application to Woburn Abbey, or to our treatment there or elsewhere, which, with very few exceptions, has always been perfectly satisfactory.

The defects of Woburn Abbey are, the site; the entrance to the house, which is not dignified; and the disposition of the pleasure-ground, which, for the greater part, is on a dull flat surface, without distant views. The pleasure-ground is also very deficient in exotic trees and shrubs, though this defect the present duke is rapidly removing; and when he has completed the kitchen-garden, he will most likely plant a complete arboretum, and a garden of herbaceous plants, arranged according to the natural system. The collection of heaths, hardy and exotic, is the most complete in the world, and not less so the collection of willows. The present duke is a scientific botanist, and a great lover of gardening and the fine arts, as his predecessor was of agriculture. He, with the assistance of Mr. Sinclair, has printed, for distribution among his friends, a descriptive catalogue of the heaths at Woburn Abbey; and is now, with the assistance of Mr. Forbes, and Mr. Stratford of Woburn, preparing a work with coloured engravings and descriptions of above 150 different species of willows, all of which are in the salicetum.

The kitchen-garden, since our visit in February (p. 215), is rapidly advancing towards completion, and will be one of the first in England. The two misplaced pine-stoves, which we objected to in 1828 (Vol. IV. p. 504.), have been removed, and the effect even surpasses expectation; the head-gardener or his wife, sitting in the parlour by the fire, can now, without any change of position, see through one window over the whole of the garden, in front of the hot-houses; and, through the other window, over the whole of the triple range of pine, melon, and forcing-pits behind the range. Experience proves that this power of inspection is something more than an imaginary advantage. The gardener's house is altogether one of the best we have seen; it does honour to the feelings of the duke, who thus evinces a wish to see his upper servants not only comfortable and healthy, but living in a comparatively elegant and respectable style; and to Mr. Atkinson, his architect, for so completely embodying the duke's wishes. We could name a duke, the whole of whose head-gardener's shed, chimney-top included, in which the gardener keeps a tall young wife, and one or two children, might be erected in the parlour referred to. There is no class of gentlemen's servants so badly lodged as gardeners generally are; but, while we state this, it is proper to mention, at the same time, that the fault is very often owing to the gardener not making known his wants. This silence on the part of the gardener proceeds, for the most part, from an idea that his master already knows what sort of a house he has to live in, and that, if he wished him to live in a better house, he would provide it; but this is a false mode of viewing the subject: the master is too far removed from the servant to enter into all his feelings, however much the former may wish to render the latter comfortable. It is, therefore, clearly the duty of a gardener, a duty fully as much to his employer as to himself, to look about and see what description of house is suitable for such a description of garden as he has the charge of, and to represent the state of the case, in a respectful manner, to his employer. We are sure that nine tenths of the employers of gardeners would be better pleased with a servant who would act in this candid open way, not only as to dwelling-houses, but as to wages, additional hands, additional houses, or machinery, or, in fact, whatever he considered wanting, than with another who would quietly submit to whatever he felt to be privations, look upon his master as his enemy, become first careless, then indifferent, afterwards neglectful, and, finally, after having injured various things under his care, either oblige his employer to discharge him, or leave his situation of his own accord. It will not be our fault if gardeners do not know what a good house is, for we shall supply them abundantly with plans of every description of cottage, from that of the labourer to that of the retiring tradesmen. Henceforth let every gardener speak out candidly and respectfully to his employer, and thus avoid the temptation of

speaking harshly of him without reason, and of generating and nourishing bad feelings on either side. It is as much the duty of a gardener, considered as a man, to generate, nourish, and cultivate good and kind feelings in himself and others, but especially in his fellow-servants and master, as it is his duty, professionally, to originate, nourish, and cultivate useful or ornamental plants in the gardens and scenery under his care.

In our former notices respecting the hot-houses here, we called them iron houses; but Mr. Jones, who manufactures them, says they may as well be called copper houses, the rafters being of iron, and the sashes of copper. The peaches and vines in these houses have done as well as at Syon Gardens, which is saying all that can be said. Not having been so long planted as at Syon, they have not produced so much fruit; but, in leaves and wood, the plants cannot be surpassed. We hope to be able to give a similar account of this garden to that which we have given of the Duke of Northumberland's operations in the kitchen-garden at Syon (p. 502.) A rockwork has been formed in the pleasure-ground, which is as well as such things usually are, or can be made, out of small loose stones; but we must not omit to state, that such works, with such stones, are not to our taste; this at Woburn is too much like a heap of small stones; and if the plants among these stones are not very constantly and carefully watched, the stones will soon be entirely covered by the plants, and it will, by their luxuriance and confused intermixture, become like a heap of earth or rubbish covered with weeds. It wants rocky protuberances, large prominent masses of stone that will furnish features for a landscape-painter, and make, on every observer, an impression to be felt and remembered. Such rockworks a gardener will find at Redleaf, near Tunbridge Wells (perhaps the most romantic, highly enriched, and best kept small place in England); at Syon; and at a few, and but a very few, other places. Where large masses of rock are not to be had, large conglomerations of small stones or brickbats, by means of Roman cement, should be formed; not, however, so as to resemble plum-pudding stones, but of right-lined shapes, such as an artist like Mr. Aglio, now employed in fresco pictures on the walls of the fruit-room at Woburn, would design by three or four strokes of his pencil, and would show also how to dispose of them among smaller stones. In a very few months, such masses would be covered with weather-stains, or this effect might be anticipated by art.

There is a handsome flower-garden here, designed by the present duchess; and near it is the most magnificent sculpture gallery to be found in any private house in England; the lofty and ample conservatory, the heathery, the botanic stoves, flower-houses, florist's garden, and a veranda of nearly a quarter of a mile in length, leading to the tennis-court, dairy, &c. We could not help contrasting the magnificence of the garden scenery and orangery with the meagre effect of those we had lately seen at Windsor (p. 605.); but we consoled ourselves by reflecting, that there being but one king, his example could be but of little consequence; whereas we have many country gentlemen of knowledge and taste possessing seats of different degrees of magnificence and beauty to raise and maintain the character of the country. So long, indeed, as we have such noblemen as the Dukes of Bedford, Northumberland, Portland, Buccleugh, Devonshire, &c., and such commoners as Mr. Hope of Deepdene, Mr. Wells of Redleaf, Mr. Coke of Holkham, Mr. Barclay, Mrs. Marryatt, &c., we need not fear the example of a British king, of the late palace at Kew, the modern one at Pimlico, or the gardens at these places, and at Windsor. What we greatly admire at Woburn is, the perfect order and keeping of every part of the place, from the little cast-iron margins of the squares of grasses (Vol. I. p. 115.), the box edgings to the small beds of hardy heaths, or the hen-coops in the aviary, to the approach roads, park wall, trees, and plantations. The order and neatness are every where perfect, and this perfection is produced by division

of duties, and by assigning to every division rather too many than too few to perform its labours. One leading manager sees that the duties of every division is properly performed; the divisions are checks or stimuli to one another, and the duke and the public are stimuli to the manager and the whole. The grand secret of the plan of all this is the *division of duties*; and the secret of the execution, the *abundance of hands* to perform them. Let this principle be borne in mind by every master. Nine tenths of the slovenliness about gentlemen's seats arises from a want of sufficient hands; from attempting more than there is means adequate to perform.

It is but justice to the late Mr. Repton to say, that much of the scenic beauty of the views from Woburn Abbey may be traced to his suggestions for the formation of pieces of water. Some future duke will pull down the house and offices, reduce the site to a *tabula rasa*, rebuild them probably on the same site, and in the same style of architecture, but so arranged as to have a more dignified effect exteriorly, to be approached from behind rather by a rising than a descending road, and lay out the pleasure-ground, stretching along the irregular line of eminences, which lies to the right and left of the present front.

*Milton Bryant Rectory*; the Rev. W. Mansfield. July 29.—This place maintains its character (Vol. III. p. 505.) for neatness, for chaste and refined design in the forms and dispositions of the flower-beds on the lawn, and for the choice selection of rare and beautiful plants there, and in what a French gardener would call the *parterre* of embroidery in front of the hot-house. The gardener, John Skerrat, formerly of Clarence Lodge, is a quiet young man, much attached to his profession, and he takes in, and makes a good use of, both the Gardener's Magazine and the *Magazine of Natural History*. We have sent him the new edition, by our much esteemed correspondent Miss Kent, of *Galpine's Compend of British Botany*, as a mark of our approbation of his professional talents, and of gratitude for his patronage of both our Magazines.

*Spring Grove, Middlesex.* Aug. 1.—This place, interesting from having so long been the residence of that valuable man Sir Joseph Banks, and the scene of the horticultural operations of our valued correspondent, Mr. Oldaker, appears to be neglected and going to decay, at which we cannot avoid recording our deep regret.

*Whitmore Lodge, near Sunning Hill*; Robert Mangles, Esq. Aug. 2.—We have before (Vol. III. p. 246.) noticed this place as very highly kept; it is still equally so, and has been greatly improved by additions to the house, and by alterations in the grounds. Mr. Mangles has a very marked taste for symmetry in architecture, and for order and contrivance in interior arrangement; fitting up, as the upholsterer terms it, and finishing and furnishing; and he is happy in finding the counterpart of his own tastes in Mrs. Mangles. The interior of the house, therefore, it may easily be conceived, is a perfect museum of contrivances, excellent furniture, and rare, precious, or curious articles. We have examined every corner of the house, from the cellar to the bed-rooms, and shall shortly enumerate a few things from recollection.

*Cellar.* The bins divided by slate, to save room. The French portable ice vessel (Vol. I. p. 444.), found to preserve the ice for a number of days after it is taken from the ice-house.

*Kitchen.* The walls lined with Dutch tiles, which, being glazed, do not retain the dust, and they are always clean. The cook said they rendered the place too hot. Instead of charcoal stoves for compound cookery, one immense cast-iron plate is heated on the principle of a common hot-house flue, by a common coal fire below. Steaming-closet and oven very perfect. Cistern behind the fire, which, by communicating-pipes (p. 454.), heats a bath. Ventilation openings near the floor, and near the ceiling, and through wire grating to exclude flies.

*Out-house.* Knife-cleaning machine. Wheel-brush for brushing shoes, and the common description of clothes.

*China closet.* Very complete collection; the walls covered with paper, in imitation of Dutch tiles. Here we have forgot something we intended to notice.

*Entrance-hall and garden-front saloon.* Sunk panels in the floor, for the large mats, 6 ft. square, to allow of the doors opening over them. A raised bed for flowers in the centre of the garden saloon, with stone curb. A large recess in the wall, enclosed with brass wire, serves as an aviary for canary birds; the birds pass through small unobtrusive openings on one side of the recess to their eating and drinking place, so that no husks of seeds are ever seen from the saloon. Shutters double, and curiously contrived both for warmth and security. In the flower-bed is now a collection of hand-some balsams, the pots covered with green moss.

*Mr. Mangle's dressing-room and business-room.* Clothes-press admirably arranged; the drawers containing the different parts of dress, named and numbered. Complete system of housekeeping books; letters and copying machine; engraved forms of bankers' checks; with the family arms, view of the house, &c.

*Breakfast-room.* The walls covered with brown moreen, bordered by gimp, with cable cord in the angles. Egyptian fire-irons, ornaments, tables, &c., from the late sale at White Knights, of the Duke of Marlborough's rarities. Frames to mirror, doors, &c. of bird's eye maple, and corresponding patterns.

*Dining-room.* Slips of lead, three-sided, and covered with oil cloth, laid along the skirting on the carpet, to prevent the chairs from being pushed too near to the wall. Contrivance for receiving the dinner hot, direct from the kitchen, as at Arundel Castle, and said to be also at Dregghorn Castle, near Edinburgh. Large bay window for the dessert table during the summer season.

*Drawing-room.* The whole of the light admitted from a bay of three large windows. Bird-cage, with an under-story, in which the bird descends through a small opening, by a trap-ladder, to its eating-place, so that no husks of seeds are ever exposed to view. Flower-stand, in which cut flowers are kept in moist sand. Set of musicians in Dresden china, numerous other articles of virtù, &c. &c.

*Staircase, &c.,* heated by a Brussels stove, which is of iron, cased inside with fire-stone, very handsome and effective.

*Bed-rooms.* Three sorts of blinds are in use; the best kind seems to be that in which the cloth is rolled up by pulling a string which coils up and unrolls in a groove on the end of the roller. The end of the string hangs loose.

What is particularly deserving of imitation in this house is the admission of light into all the rooms, not by rows of windows, but by bays or large windows without any cross lights, so that the light always comes in masses, and thus sets off all forms to advantage. There is not a room in the house with two windows, nor a door with a display of locks, knobs, handles, and other fastenings, as if, in a house of enjoyment, the security of person or property were a matter of constant consideration. The view of the pleasure-ground from the dining-room displays a plain lawn, ornamented with shrubs and trees, but without flowers; that from the breakfast-room the same view, but introducing an inviting portion of extreme distance; that from the drawing-room, a lawn highly enriched with baskets of flowers of different shapes, grouped so as to exhibit handsome combinations; a large one (*fig. 112.*) being directly in front, two irregular ones at each side along the walk, and a smaller regular one (*fig. 113.*) placed beyond the first at some little distance. The bordering of these figures is of cast-iron basket-work, and the flowers this season are as follows:—



- Fig. 112.* 1. Variegated-leaved scarlet flowering Pelargonium.  
 2, 3, 4, and 5. The same.  
 6. Ivy-leaved Pelargonium.  
 7. Bath scarlet Pelargonium.  
 8. Ivy-leaved Pelargonium.  
 9. Horse-shoe-leaved scarlet Pelargonium.  
 10. Ivy-leaved Pelargonium.  
 11. Waterloo scarlet Pelargonium.  
 12. Ivy-leaved Pelargonium.

13. *Sálvia splendens*.

- Fig. 113.* 14. *Calceolària corymbòsa*.  
 15. Standard Rose and Mignonette.  
 16. *Calceolària corymbòsa*.  
 17. Standard Rose and Mignonette.  
 18. *Calceolària corymbòsa*.  
 19. Standard Rose and Mignonette.  
 20. *Calceolària corymbòsa*.  
 21. Standard Rose and Mignonette.  
 22. Choice Pelargoniums.

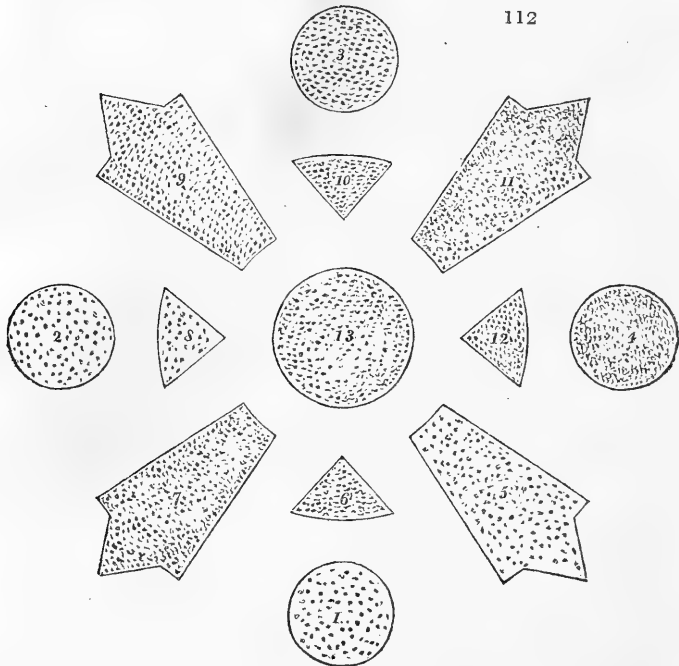

While we were here, orders were given to the gardener to prepare for the following arrangements in 1850 :—

- Fig. 112.* 1, 2, 3, and 4. Variegated-leaved pink flowering Pelargonium.  
 5. Bath scarlet Pelargonium.  
 6. *Calceolària corymbòsa*.  
 7. Waterloo Pelargonium.  
 8. *Senècio élegans*.  
 9. Bath scarlet Pelargonium.  
 10. *Calceolària corymbòsa*.  
 11. Waterloo Pelargonium.  
 12. *Senècio élegans*.

13. *Petùnia nyctaginiflòra*.

- Fig. 113.* 14. Ivy-leaved Pelargonium.  
 15. Standard Rose and Mignonette.  
 16. *Fúchsia grácilis*.  
 17. Standard Rose and Mignonette.  
 18. Ivy-leaved Pelargonium.  
 19. Standard Rose and Mignonette.  
 20. *Fúchsia coccínea*.  
 21. Standard Rose and Mignonette.  
 22. Dwarf Georquinas.

A new rosary has been formed; a summer garden, surrounded by a trellis walk, covered with the most rare and beautiful hardy and half hardy climbers; a fountain; a rustic covered seat; a green-house heated by hot water in zinc pipes, &c. The whole is in as perfect order as it was when we

saw it formerly; and only now, as then, a little defective in having the gravel of the walks too much sunk below the level of the grass, which always

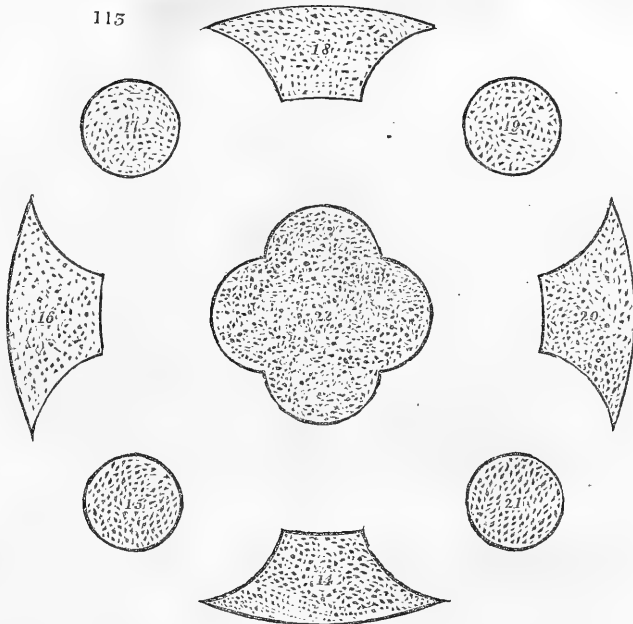

produces more or less of a ditch or kitchen-garden alley appearance, accompanied by deep harsh ridges. This defect, we are promised, shall be removed. The pots on the chimney-tops should be changed for square, or some other forms not at present so common as to be considered inelegant.

Independently of the beauty and high keeping of Whitmore Lodge, it is interesting, as affording an example of a small villa that would gain nothing in character or effect by additional acres. All the views are to the south and east, over an extensive, richly-wooded country, and terminating in the south-west in the hilly parts of Bagshot Heath. Mr. Gilpin, whose professional assistance was called in, some years ago, when the property was purchased, and Mr. Mangles, have managed the foreground so as completely to appropriate all beyond it; and were the possessor now to have an opportunity of rendering the whole landscape his property, though he might add to his power and consequence, he could not add to the beauty of his residence. The important lesson to be learned from all this is the great advantage of building and gardening in elevated situations. The proprietor of thousands of acres, whose establishment requires a baronial mansion, may form his park on a flat surface, elevate his house by a terraced platform, and look from the centre to the circumference, over a home-made landscape; but the smaller gentleman, if he is a man of taste, will make choice of the top or the side of a hill, where he can command an extensive prospect, at least on two sides, and where one acre will go as far, in point of enjoyment and picturesque effect of scenery and sky, as a hundred acres on a plain decorated with all the art of the architect and the landscape-gardener.

*Wingfield Spa, in Windsor Forest (4 miles from Windsor, and  $4\frac{1}{2}$  from Maidenhead).* August 4. — A spring has been discovered here, of which it

is said "that the quantity of muriate of magnesia being greater than is usually met with, and its being conjoined with sulphate of magnesia and sulphate of soda, render it superior to Cheltenham water."\* A rustic pump-room (fig. 114.), from a design by Mr. Mangles, has been erected

114

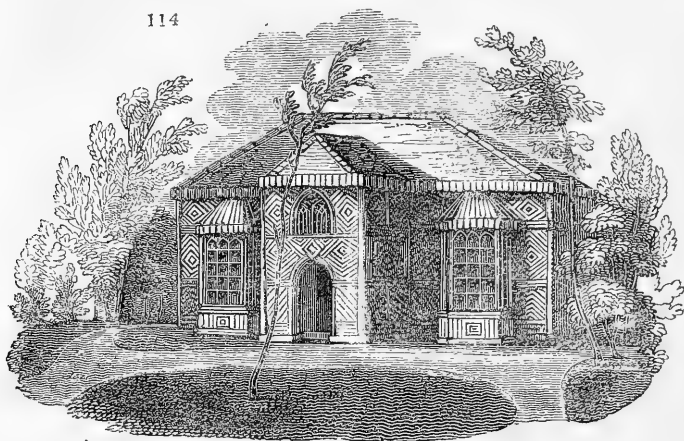

over it; extensive walks, formed in the copse woods around it; and, hard by, a spacious mansion, late the residence of Captain Forbes, R.N., has been opened as a hotel and boarding-house, on reasonable terms. The situation being desirable in point of distance from London, and in a country affording abundant food for the botanist, and the lover of the picturesque, we should hope it will succeed. As in the case of our Epinal hat (p. 559.), the patronage of some distinguished person would be a useful beginning. Two or three poor nobles of high fashion might have the run of the hotel and spa for the summer, in consideration of their coming to the hotel in bad health, taking the waters, and finding the greatest benefit from them.

*Sandpit Gate.* Aug. 4. — The effect on entering is very grand, and the castellated lodge is not unsuitable to a royal forest. The eye, passing over a portion of naked ground, looks down on descending groves, and rises again to meet a horizon of hanging oak-woods; all the mass is grand, the minor parts bold and irregular, and the effect of the whole at this time heightened by a cloudy sky, with occasional gleams of sunshine. The only tree which appears planted by the hand of man is a variegated holly in the foreground, tall, aged, but retaining its variegation. Near the gate are some miserable-looking wooden hovels, containing the king's menagerie. This was not the state-day for seeing the giraffe; but we had a glimpse of the noble animal through the large chinks of the weather-boarding of the old barn in which he is lodged: he appears thin, sickly, and very inferior to the giraffe of the Jardin des Plantes.

*Ascot Place, near Sunning Hill;* Miss Ferrard. Aug. 4. — The park here has long been celebrated for its grotto, designed by the late proprietor, Daniel Agace, Esq., and executed under his directions by one Turnbull, a Scotch mason. It is in better taste than most grottoes; and we do not

---

\* See the analysis of the water, with remarks, in the *Quarterly Journal of the Royal Institution* for March, 1829, and in the *Philosophical Magazine* for August, 1829.

know any that can be compared with it excepting that at Pains Hill, which we consider the first in England. The Ascot grotto is chiefly executed of stones collected on the surrounding lands, and they are built up and keyed together so judiciously and substantially, that the structure is almost as perfect as when it was first erected, and it will, doubtless, last a great many years — a prediction that can be made of very few buildings of this kind. The grounds of Ascot park are flat; but, being of considerable extent, and displaying a large piece of water, with abundance of wood, they are not without interest, even independently of the house and garden scenery. We admire the house for its simple grandeur, both without and within. It consists of a square centre, with four fronts and four stacks of chimneys, and two wings each with one stack; the wings are after additions, the sub-story having been found too damp for the kitchen offices. We mention this to account for what the architect, Paul Sandby, must have felt with us, had been better omitted. We looked through the offices and principal rooms, and were gratified by the elegant simplicity which pervaded the whole, though the finishing, and part of the furniture, are not of the latest taste. We are happy to see, occasionally, rich and sumptuous apartments, and a multiplicity of objects of taste and contrivance combined in little space: a suite of magnificently-furnished rooms like those at Goodwood, and a cabinet villa like Whitmore Lodge; but, for our own particular taste and use, whether it be in houses or gardens, in men or in women, or, in fact, whatever is to be permanently near us, we prefer scope, simplicity of design, and obvious use. Simple, useful, and economical; these are the words. Whatever is costly and superfluous soon satiates. A connoisseur in building and furnishing is never happy but in adding something, contemplating changes, or carrying them into execution; the man of elegant usefulness, or simple grandeur, attains his end, and rests satisfied. There is an excellent oak staircase; a small collection of choice shells in the drawing-room; a good library; and, among the pictures, some landscapes by Both, a pupil of Claude, eminent for his touch and style of handling. A book of Chinese drawings of plants contains, among some articles of which we never saw the originals, a double yellow *Pæonia Mou-tan*, and a deep blue chrysanthemum.

The late proprietor was his own landscape-gardener, and has succeeded in forming very agreeable walks among exotic trees and shrubs, and erecting some ornamental buildings of stone in good taste, and so substantially executed, that they are not like those of Stowe, and many other places, falling into decay. An open temple, in a grove of oaks rising from the smoothest turf, is worthy of notice. We should like to see all the country boys and girls, for miles round, enjoying a fête under these oaks. Among the shrubs are many American things, such as were furnished by the nurseries about 1786. Miss Ferrard has lately added some rhododendrons, azaleas, and similar exotics, a collection of standard roses, and other things, which she selected last autumn in Paris. Among the old trees are several cedars of Lebanon, with tall, straight, clean trunks, which proves the truth of what is asserted by Mr. Sang (*Planter's Calendar*, Edin. 8vo), that if these trees were planted; or, in preference, sown in masses, as Scotch pines and larches are, or, among other trees, they would produce as clean straight timber as could be desired. We have no doubt of it, and should like to see a few acres of waste planted with nothing else but cedars, at, say 10 ft. apart every way.

There is an excellent collection of geraniums and carnations, with a considerable number of green-house plants. These, with the vinery, are exceedingly well managed; and the pleasure-ground is kept in perfect order by Mr. James Beal, who has long been head-gardener here, and who, as a faithful industrious servant, is duly valued by his employer; and we have sent him the first volume of our *Magazine of Natural History*, in testimony of his professional merit.

The defective point of Ascot Place is the kitchen-garden, which is over-shaded and oversheltered by high trees, and ought either to be removed, and its place occupied by a flower-garden, agreeably to the natural system, or renovated. The shrubbery and woods, in general, require thinning, and such new sorts introduced as will bring the place forward, in point of botany and gardening, to others of the same rank.

*Selwood Park*; Michie Forbes, Esq. Aug. 4.—The house, which we only saw at a distance, appears an elegant structure. The kitchen-garden is remarkable for a very large Hamburg vine, which covers more space than that of Hampton Court, and bears well, considering that it is only twelve or thirteen years of age. It will not, however, continue to bear well long, unless the ground in front ceases to be cultivated and cropped. Instead of this, it should merely have an occasional layer of rotten dung or leaves, and be forked over annually not more than 3 in. deep. If reservoirs of liquid manure could be supplied, the quantity and size of the fruit would be increased. In the garden we found the Ironmonger gooseberry, which is superior to the Warrington, and is indeed decidedly the best variety of red gooseberry. Cummings, the gardener here, is a most industrious and skilful young man, and has his charge in remarkably good order, considering an apparent want of sufficient assistance. We have sent him Vol. I. of our *Magazine of Natural History* as a mark of our approbation, and we expect from him the account of his vine, which he promised.

*Bagshot Park*; the Duke of Gloucester. Aug. 5.—The flower-garden here is in as complete order as it was when we first viewed it in May, 1828 (Vol. IV. p. 435.). The trees in the arboretum are growing rapidly, and already require to be thinned out; in short, the whole garden will soon be overgrown. The rosary has flowered remarkably well this season, and the herbaceous garden is now in a high state of beauty. We hope, after we have published certain designs for laying out flower-gardens according to the natural system, which we are now preparing, the Duchess of Gloucester will authorise Mr. Toward to remodel it according to that system. The scene which struck us with most force during this visit was the American ground, in which the tufted masses of peat-earth shrubs, magnolias, rhododendrons, andromedas, azaleas, kalmias, ericas, &c. looked admirably. As minor subjects of interest we noticed the following:—*Amaryllis purpurea*, now *The-lôta purpurea*, flowers all the season. The large plants of *Hydrangea*, in the common loam of the place, always come with blue flowers; but small cuttings taken from the same plants in June, after the flower buds are formed, and rooted and the flowers expanded in July and August in pots of the smallest size, invariably have the flowers red. It would thus appear necessary that the sap should circulate through the roots, or through the whole of a large plant, before it partakes of the quality which renders it blue. In the greenhouse is a large *Fuchsia coccinea*, covered all the season with such an abundance of berries, that tarts might be made of them if they were considered eatable. These berries drop and produce good plants the same season; from which it would appear that the *Fuchsia* might be treated as a half-hardy annual, and raised from seed every spring in hot-beds along with Marigolds and China asters, and transplanted in the borders. The same thing might be done with *Pelargonium* seeds; but it is doubtless a much better thing to raise abundance of *Pelargoniums* early every spring from cuttings, and distribute them through the borders in May. Mr. Toward turns out of the pots all his *Pelargoniums*, when they have done flowering, into beds in the open ground; in a week or two afterwards, when they have struck root, he cuts them down, or very close in: they push vigorously, and in autumn he repots them. Pipings taken from the grass of forced pinks, when they have done flowering early, having been planted out in beds where they had struck root, were now beginning to push up flower-

stalks. *Gnaphalium eximium* very finely in flower. The front wall of the green-house concealed by a projecting oblique, or nearly horizontal, trellis, covered with passion flowers, which is thought better than seeing so much of the wall. Mr. Toward's dwelling-house is one of the smallest and lowest we have ever seen, and, on observing this to him when last there, he informed us that a new one was about to be built; for which reason we said nothing, though we had been blamed by certain gardeners who knew Mr. Toward's case, and sympathised with him, from not being much better off themselves. The truth is, that in this case, and several others, our silence has proceeded from a fear of doing more injury than good, by leading the employer to take offence at his gardener. Candour and sincerity, however, is doubtless the best for all parties in the long run, and we are determined in future to speak our own mind as to gardeners' houses, and every thing else, without considering whether it may be pleasing or otherwise to either servant or master. It is our duty to do so; and we are the more likely to do it without injuring any one, since we are always open to the correction of all our readers, from the most humble to the most learned or powerful. We have repeatedly stated that there is no class of servants so badly lodged as gardeners; and we are perfectly certain of this, that we cannot do masters a greater service than by inducing them to render their servants comfortable. We are not alluding to wages, but to those requisites and conveniences which every country gentleman may create on his estate, by the mere application of a little labour from those servants whom he already employs. A good and comfortable home is the first source of happiness to every man; and thereafter a good and well-furnished house, a certain quantity of fuel, of potatoes, of flour, of cow's milk, and the keep of a pig or a goat, will go much farther in rendering a married servant content than an increase of money wages. The skeleton of a new house is put up for Mr. Toward; but we regret to say that it is such as we cannot approve of. The situation is too shady and damp. The ground floor should have been raised at least 4 ft. above the surface, which, by sinking 4 ft. under it, would have given two useful cellars. The bed-rooms cannot be much above 6 ft. high in the clear, whereas in the meanest cottage they should not be lower than 9 ft. We were informed the house was kept low, in order to prevent it from intruding on the view from the walks; but the humane way of doing this would have been to have had all the rooms on the same floor. This house is proceeding very slowly; it is not yet floored or plastered, and we would recommend its being pulled down, and a proper one built in a more dry, open, and airy situation. Mr. Toward will be deeply offended at our having mentioned his house at all; but we must do our duty. No servant ever spoke with more respect and attachment of his employer than Mr. Toward does of the Duchess of Gloucester, whom we firmly believe to be a most amiable woman. The defect we have complained of, we are persuaded, proceeds entirely from want of a little reflection on the part of her upper managers, and by no means from want of humanity.

The kitchen-garden here has a ruinous appearance; the forcing-houses seem to be tumbling down, and the tops of the walls would require to be weeded as well as the walks, which is the case, as we are informed, with the garden walls of that fine old place, Longleat. Notwithstanding these disadvantages, Mr. Smith continues to raise good crops of various articles. There is a bee-house with a good many hives, for the purpose of producing glasses of fresh honey every day: they are under the care of an enthusiastic and enlightened bee-master, once a lieutenant in the navy.

*Knapp Hill Nursery*; Mr. Waterer. August 6. — We had heard much in London, and from various gardeners in the country, of the splendid collection of new seedling azaleas which flowered here in June last, not one of which is yet given out to the trade; but, of course, at this season we could only see the foliage. Among other things we noted *Andr meda* ar-

bòrea, 10 ft. high, and finely in flower; *Vaccinium Arctostáphylos*, the Madeira bilberry, 6 ft. high, and richly covered with fruit; another species, unknown, bearing very large fruit. Both species well deserve culture, where peat earth is not scarce, as fruits for tarts and for eating with cream, like other bilberries. *Andrómeda acuminàta* and *mariàna*, *Rhododéndron caucásicum*, *Clèthra alnifolia*, *Gualthèria procumbens*, *Córnus canadénsis*, *Hypéricum Kalmiànnum*, *Stuártia Malachodéndron*, finely in flower; *Magnòlia auriculàta*, very luxuriant; measured one of the leaves, and found it 22 in. long, and 11 in. wide. *Lílium supèrbum*, 10 ft. high, coming into flower. The great art in getting this species to flower well, as Mr. Cameron of Bury Hill informed us, is to keep the bulbs single, by taking them up, separating, and replanting. It is evident that, by this practice, the greatest possible supply of nourishment will be obtained by each plant. *Phlóx Thomsòni*, a new variety, in flower. *Dáphne collina*, a variety with striped leaves. This nursery excels in the management of hedges, which are in some cases 8 or 10 ft. high, and not more than 8 or 10 in. thick: but, in general, it is not quite so neat and orderly as we could wish; and though we have never seen the weeds exceed the economic point (p. 572.), we would rather see weeding carried lower. We never yet knew a nursery or market-garden, where any money was made, that was not kept *orderly*, at all events, and most of them even *neatly*. We do not say that much is wanting at Knap Hill; but still we should like to see both principles pushed farther; a good many of the old things grubbed up, the walks and compartments more correctly lined out, and no weeds ever suffered to grow above an inch high. We hint this with the more confidence, knowing that Mr. Waterer will take it in good part, and that it will be in his favour with the hundreds of gardeners and gentlemen that will come from all quarters next June to see the bloom of new azaleas.

*Goldworth Nursery*; Mr. Donald. August 7. — The usual order and neatness prevails. Mr. Donald contemplates a carriage-drive through his Home Nursery, with a border on each side, containing a complete display of flowering specimens of peat-earth shrubs. He has lately erected a propagating pit on a very good construction. It is without flues, but in the centre is a division of one light, which is destined to receive hot dung, and the separation walls being very thin, and the boundary walls hollow, the principal part of the heat is given out to the two divisions. The dung may either be thrown in from above, removing the sash, or from one side by an opening in the wall. Mr. D. having a number of large tubers of *A'pios tuberòsa*, thought of trying them as an esculent, and, boiling and roasting them like potatoes, found them very agreeable and wholesome. An ingenious mode of preventing pear-stocks from becoming mildewed, viz. that of intermixing them in the quarters of plum-stocks, at the rate, perhaps, of 3 or 4 per cent, deserves notice. Might not the same plan be adopted with cherry-stocks to preserve them from the black fly, thorns from the mildew, &c., and with other plants, herbaceous and ligneous, liable to be blighted from various causes, both in gardens and fields?

August 7. We met at Mr. Donald's Mr. John Damper Parks, F.H.S., late gardener to the Earl of Arran, at Bognor (p. 295), and at one time Voyaging Botanist to the Horticultural Society. He had just left his place, and was on a walking botanical excursion, calling at all the interesting gardens on his way, and gathering the more rare wild plants, and examining them, by *Galpine's Compendium*. Mr. Parks is a good botanist and gardener, and a prudent man. He was sent to China by the Horticultural Society some years ago, and gave us a good deal of curious information as to the customs and garden culture of that country; but we will not plough with the Society's heifer, but rather repeat our approbation of Mr. Park's mode of travelling through the country on foot, and procuring information in his profession; and recommend to all gardeners,

whether in or out of place, to call and see other gardens as frequently and extensively as they possibly can. We can assure them from the experience of others as well as our own, that they will, if they are men of any observation, learn more in a week spent in this way, than in a year of close attention, and even reading at home. We would lend our head gardener a horse, perhaps a velocipede might do, and allow him so much a day, say 20s., for a certain number of days in every year, and oblige him to make tours, and write in a journal, to be kept in the garden library, where he had been, and what he had seen. It would be a good thing, also, for every gardener to keep a list of the places he has seen from his earliest years upwards, and show it, when necessary, as a presumptive proof of his qualifications. No master ought to hire a gardener without being informed where he has served his apprenticeship, and what he has been doing since. The German gardeners have all this written in a little book, in which also are short characters from their different masters; and an English gardener might do worse than adopt the practice. We know some masters that are alive to the importance of what their gardeners may acquire by looking about them; and both the late Duchess of Dorset and the present Countess of Radnor, ladies fond of gardening, sent their gardeners, for some weeks, the former, we think in 1820, and the latter in 1829, to see the gardens of Paris, and its environs.

Mr. Parks informed us that he had found the Medlar an excellent stock for forcing the pear into early bearing: that *Kálmia latifolia* was not poisonous to deer, but so much so to dogs, that the entrails of some deer containing *Kálmia* leaves, having been eaten by dogs, killed them.

*Guildford Castle*; — Elkins, Esq. August 7. — The grounds round the ancient keep, to the extent of an acre or two, have lately been enclosed and laid out as a garden, in a mixed style, combining culinary crops, fruits, flowers, and picturesque scenery. The prevailing produce is fruit, and the whole is very neatly kept. A good many filberts have been planted and trained to single stems, about 5 ft. in length; the true method of bringing them to, and keeping them in, a bearing state. The bad effect of raising the earth about the roots of fruit trees is here strikingly exemplified in two large apricot trees trained against a wall, both of which a few years ago were excellent bearers; but the border in which one of the trees stood requiring to be raised about a foot, the tree has since ceased to bear. It might be easily raised and restored to a state of fruitfulness. We observed the carnations, pinks, and sweetwilliams, in the borders, to be of an extraordinary degree of luxuriance, such as we seldom recollect to have seen any where: on examination of the soil, we found it to be deep, loose, dry, and principally composed of chalk and black earth; and recollecting that all the *Díánthus* family grow naturally on clalky soils, on the debris of limestone, and that such soils are invariably dry, the fact of the strength of these species in this dry chalky garden, seemed to point out the great importance, in preparing an artificial soil for any plant, of keeping in view its natural soil, and the condition in which such soil is likely to be with respect to water. From a seat near the keep some of the public buildings of Guildford, and, among others, the treadmill, come into view. It appears, from what Mr. Elkins stated to us, that this machine has no effect whatever in reforming the character of those who are punished by it; the utmost that it is calculated to do is, to prevent future offences, from the fear of a repetition of the punishment; but this it does not do to a great extent even on young offenders, several of whom, who have quitted the Guildford treadmill in the morning, having been lodged in Brixton jail in the evening. Even the society for reclaiming young offenders is not often successful in its operations, and especially, as we were informed, with the female sex. We are not surprised at these things, believing that they will take place in some degree, even in the most improved state of society;



but still they lead us to conclude, that, as it is found to be so extremely difficult to alter the habits of grown up people, the greatest exertions should be made to form in them good habits in their earliest youth, by properly conducted infant schools, and by cultivating the heart and mind of every individual to a high degree. It appears to us to be the duty of the legislature to facilitate the means of applying this degree of cultivation, by obliging every parish to establish proper schools, and to render it illegal to employ any young person after a certain year, who cannot produce a certificate, which may be a copy of the Parochial Gazette (*Mag. Nat. Hist.* vol. ii. p. 77.), proving that he or she has undergone a certain degree of education. Even this state of things would not extinguish crime from the annals of society, and especially from a society with an overflowing population, and in a progressive state of improvement; but it surely cannot be doubted that it would greatly lessen its amount, and that the description of crime committed would be less horrible. We think we can see something of its effects in the mild and philosophic character of the murders and suicides of the present day, as compared with that of those perpetrated before a sense of the influence of what is said in newspapers, and a knowledge of chemistry, was less perfect and less generally extended.

*The Godalming Subscription School.* August 7. — It is gratifying to know that some schools on the Lancasterian plan, supported by voluntary subscriptions, have been established in this part of the country. There is one in Guildford, which we had not time to look into; that at Godalming is principally supported by Quakers. It is a plain substantial building in a dry open situation, in the outskirts of the town; and at present is attended by 150 boys and 120 girls. We entered the girls' school, and saw them take their places, go through their preparatory manœuvres, and execute a lesson in arithmetic, under the direction of Miss Elizabeth Mills, a most agreeable young woman, who, though not more than 16 or 17 years of age, seems to be a perfect mistress of the system of teaching, and to have her pupils in a state of excellent training. In proof of our approbation, we have sent Miss Mills *Conversations on Botany*, for her own perusal, and a small microscope for the purpose of gratifying the children with sights of flies and other minute objects, occasionally, and on holydays, as suggested in *Magazine of Natural History*, No. VIII. (vol. ii.) p. 286., which Number we have also sent her. We have sent the articles through Mr. Sawyer, an ingenious young botanist, residing with Mr. Donald at Goldworth, who will be so good as to explain at length the uses of the microscope to Miss Mills.

*Lea House, near Godalming;* J. and E. Leach, Esqrs. August 7. — The Turkey oak-tree has been very extensively planted here between 60 and 70 years ago; and there is a fine plantation of them along the Haslemere road, which, from the size of the trees, must have been regularly thinned out as it advanced. Though not very extensive, it is still the greatest assemblage of this tree that we have hitherto seen.

*Stroud House, near Haslemere;* Miss Perry. August 8. — A small villa exhibiting a perfect model of order and neatness in the house and grounds, and quiet, elegant, rural retirement in the family. The road from Godalming to Haslemere, a distance of eight miles, is one of the most grand and romantic in Surrey or Sussex. It is chiefly through natural woods and open woody commons, and it passes over two or three hills, from the highest of which, between Stroud and Haslemere, a very extensive prospect is obtained. Stroud House (*fig.* 115.) is built in a glade in the skirt of an extensive natural oak copse near the road, with a lawn in front and behind, the kitchen-garden and offices at one side, and an orchard and gardener's cottage at the other. Two or three paddocks or ploughed fields, and extensive copse woods, with a winding brook and circuitous walk, complete the

leading features. The keeping of the lawn, and every thing about the house, is as high and perfect as any thing we have ever seen; and the walks in

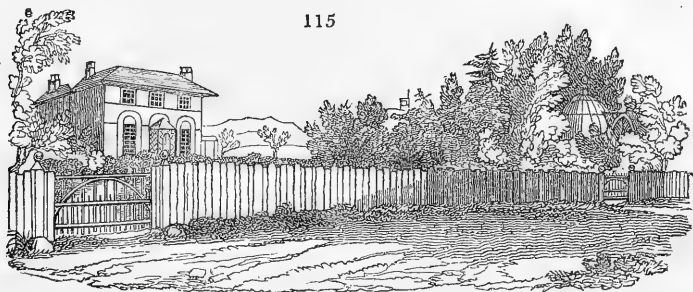

the copse are kept as clean, dry, and open as copse walks can be. The various bridges over the brooks, and the consequent turns of the walk; the glimpses of the water and broken banks, caught here and there through the trees; the numerous wild plants, abundance of pheasants, singing birds, butterflies, dragon flies in their season, owls in the evening, &c. constitute the attractions of the wood. The house was formed by additions and alterations to an old structure by John Perry, Esq. the proprietor, an architect in Godalming, who has distinguished himself by several meritorious erections there and in the surrounding country. Among other contrivances in the interior which deserve to be mentioned, are bell-pulls in every room, which communicate with a bell placed at the head of the gardener's bed, in his adjoining cottage (seen in the right of *fig. 115.*). The communication of the wire from the house to the cottage is through a leaden pipe, sunk some feet under ground, and protected by brick-work, so that no intended housebreaker could easily dig down to it and cut it off. In the evening, this bell serves to call the gardener, who is married, when he may be wanted for any domestic purpose, and, in the night time, serves as an alarm. The family here consists of five sisters of highly cultivated minds; our reason for mentioning which is, to refer to them as an example of what may be attained to in botany by self-instruction, without a single hint of any kind from a botanist, or any person knowing the names of plants. Three of these ladies are acute systematic botanists, and discover the name of every British plant in flower which comes in their way, from Galpine's *Compendium*, and every exotic from the *Encyclopædia of Plants*; and one of them has commenced a series of outlines of British plants, nearly, or wholly, as large as life, so accurate and characteristic, that Mr. Don, of the Linnean Society, who has seen some of them, says they have seldom been equalled, and never surpassed. We hope they may one day be engraved and published; though we cannot help stating, that the pleasure of discovering the names of plants from descriptions, as now done by the Misses Perry, must be much greater than the lazy enjoyment of indentifying them with engravings of any kind. The labour is greater, and the reward is as the labour. The Misses Perry were the first who introduced the practice of archery into this part of the country, about fifteen years ago, and it is now become general in the neighbourhood among ladies.

The gardener here, Arthur Morrey, is a most industrious and valuable man, and every thing under his charge does him great credit. He has two boys and four girls, healthy children, to each of whom we have sent a school-book, and, to the father, a pair of French *sabots* for putting over his shoes in the pruning season. We would strongly recommend these *sabots* (wooden shoes) to all journeymen gardeners, as most valuable for keeping

their feet dry and warm while standing on wet ground pruning trees in the winter or spring season. They may be had through any London or Edinburgh nurseryman, who may easily procure them from any sea-port on the Continent, and they are very cheap and durable. Indeed, we are of opinion that every head-gardener ought to keep a stock of them for the use of the men under his care, in the same way as he keeps spades, rakes, and other tools. Nurserymen and gentlemen's gardeners find that it pays to warm, by a flue or a steam-pipe, the back sheds in which their men work in the winter time. Why should it not, also, pay to keep their workmen's feet dry and warm when they are working in the open air at that season? To begin the thing, we hereby offer a copy of our *Hortus Britannicus* to the first head-gardener in England who shall, with the consent of his employer, procure 20 pairs of *sabots* from a London nurseryman, for the use of his men; the like stimulus to the first gardener in Scotland, the *sabots* being procured from an Edinburgh nurseryman; and the like for Ireland, the *sabots* being procured from a Dublin nurseryman. We are desirous that the *sabots* should be procured from nurserymen, in order that these may get into the way of keeping a stock of them; and we shall be glad to know the nurserymen's names, that we may publish them for the benefit of gardeners generally.

*Denby House, near Haslemere*; Mrs. Fielding. — The situation is lofty, and commands a most extensive prospect. The house is a plain substantial edifice, the interior most commodiously arranged, and finished in a superior style of elegance by Mr. Perry, of Godalming. From the same gentleman's designs a very complete set of stable offices have been erected. When the plantations, also, we believe, designed by Mr. Perry, are grown a few years, and the approach from Haslemere is improved both in direction, forming, and keeping, Denby House will be a place of interest to strangers, from the unexpected and striking effect of the prospect from the house.

*Petworth House*; the Earl of Egremont. August 11. — This is in many respects a very noble place. The house stands close to, and indeed may be said to form a part of, the town. In the angle of a narrow street is situated the principal entrance, from whence the visitor, leaving a small porter's lodge, passes through low cloisters to a noble saloon in the centre of an extensive suite of rooms; these rooms look on the park, and have no fault in our eyes but that of being three or four feet too low in the floor for dignity of effect, in consequence of which the view to the park is less commanding. This view contains a large piece of water, a wooded hill to the right, a portion of distance to the left, a church steeple beyond a wood in the centre, and is, on the whole, as well managed and as striking as a view over a surface which does not fall away from the house, as at Woburn Abbey for example, can be. The park, the walls of which are said to be twelve miles in circumference, is well stocked with deer, cattle, sheep, and pigs, and once contained buffaloes, quaggas, zebras, wild horses, asses, and other quadrupeds. On remarking to the person who showed us the rooms on the quantity of pigs grazing in front of the windows, and on the number of townsmen playing at skittles beside them, she observed, that the earl, her master, took delight in seeing every living thing enjoying its existence; an expression indicative of a character which greatly pleases us; for what can be more gratifying than to see a rich man giving undeniable proofs that he wishes not only to share the bounties of Providence with his poorer neighbours, but to reflect them back as it were upon all nature! In the house are a number of excellent pictures, both of ancient and modern masters; and what is always satisfactory to hear, because it leads to the mutual improvement of patrons and artists, most of the modern pictures were painted during the stay of the artist in the house. Among the sculptures is a marble bust of the celebrated Arthur Young, the earl having frequently consulted him respecting his agricultural improvements. In one of the

garden courts in the back front of the house are some fine old specimens of exotics, a basin rockwork and fountain, and a conservatory. Against the house is the largest *Glycine frutescens* which we have ever seen; two large plants of *Magnolia grandiflora*, and a very fine *M. purpurea*. In the conservatory is a magnificent *Brugmansia arborea*, some good camellias, and *Calla æthiópica*, bearing seed. The beds in this conservatory are about two feet higher than the paths, and they are enclosed in cast-iron plates, painted green, which, though executed about a dozen years ago by Messrs. Bailey, of Holborn, do not yet show the slightest symptom of rusting. In another garden court is a large standard fig-tree, which bears tolerable crops annually, without any care whatever, though it can have very little sun after two o'clock in the day. In a conservatory in this court there is a lemon tree, trained against the back wall, which, in consequence of Mr. Harrison's mode of pruning, bears large crops, and has all the year fruit of different sizes, together with blossoms. Mr. H. finds that the *Citrus* tribe bear best on weak side and terminating shoots of an inch or two in length; and his object in pruning is to produce these shoots regularly all over the tree: this he does by pinching in strong shoots wherever they appear. In this garden a tortoise has lived for many years; it is fed on the leaves of lettuce, &c. occasionally, but derives the greater part of its food from the grass and plants with which it is surrounded. In winter it buries itself in the soil below the depth to which the frost penetrates. In a third court is a small flower-garden recently formed, and a *Pelargonium* house containing a variety of new sorts raised here from seeds. The beds of the flower-garden are planted with the choicest new half-hardy annuals, such as *verbena Melindres* (or *chamædryoides*, as it is named by Sweet), *Clarkia pulchella*, *Sálvia splendens*, and also a new variety of this *Sálvia* raised here from seed, and of which a drawing was made for us (*fig.* 116.) by Miss Sarah Perry. On the north side of the house the shrubbery commences, and consists of a walk with glades of turf, shrubs, and lofty trees on each side, among which are some fine old hollies and four silver firs of extraordinary dimensions. Farther on is an open grove of various trees, among which are twelve large silver firs, and a Grecian temple, commanding an extensive prospect. On the glades in different places small groups or patches of different sorts of ferns are planted, which, rising in tufts through the turf, have a good effect.

The kitchen-garden had been for many years behind the rest of the place, from the delicate feelings of the proprietor, who would not superannuate an old servant. Two years ago it was put under the management of Mr. Harrison, late gardener at Wortley Hall, and author of one of our best treatises on fruit trees, who is renovating every thing, and has already made important improvements. The peach and apricot trees were naked and almost worn out; and it became necessary to renew the borders and plant young trees, which are gradually taking the places of the others. The pear, plum, and cherry trees against the walls were covered with spurs eighteen inches in length, which Mr. Harrison has cut in according to his system. (*Encyc. of Gard.* § 4454, *Gard. Mag.* vol. iii. p. 1., and *Treatise*



116

on *Fruit Trees*, 1825, 8vo. p. 187.) On some pear trees a few branches, with the old spurs, are allowed to remain, which renders the increased size of the fruit on the reduced spurs very apparent. There are two rows of fig trees against east and west walls; the wood of which has been thinned out, and they are now covered with a most abundant crop, which began to ripen in the end of July. A vine wall, 110 yds. long and 14 ft. high, the sorts chiefly the white muscadine and black cluster, shows a good crop. When ripening they are covered with leno, as are at this time the plums and cherries, and the openings for air to the vineries and peach-houses. There is a large bed of cranberries on peat earth kept moist; but Mr. Harrison finds the plants bear better when the shoots are raised on bricks or stones, and he intends placing small ridges of these at regular distances of about a foot over the whole bed. The crops of pines, grapes, and peaches were abundant. Mr. Harrison thins away the leaves from his lemons, oranges, figs, grapes, and sometimes from peaches and other fruits when they are full grown, but only so far as to admit the direct influence of the sun a part of the day, and no leaf is ever taken from those embryo buds which are to come into use in the ensuing season. This operation is of the greatest nicety, and none are more frequently over-done by gardeners, if the men with blue aprons may be so named, who do not know the use of leaves, and that the bud at the base of a leaf-stalk depends entirely on the leaf of that stalk for its perfect formation, and can never be perfected by the adjoining leaves, however numerous these leaves may be. Every master and mistress who does not keep a scientific gardener, that is, a reading one, ought to bear this in mind, and keep an eye to what is done with the leaves of all manner of plants, and especially of fruit trees. A plant can no more thrive with its leaves injured, than a warm-blooded animal with diseased lungs; leaves performing the same office to the sap of plants which lungs do to the blood of animals.

*Cockscombs.* In the pinery we observed 60 pots of cockscombs of uniform size, the comb about 22 inches in length, and the height of the flower not more than 10 inches. The art of raising them with such large combs on so short stems, Mr. Harrison says, is after transplanting them for the first time out of the seed pot, to let them remain in a small sized pot till the comb has made its appearance, and then, and not before, to begin to transplant, as in the case of balsams, into larger pots, and thus supply as much rich earth, liquid manure, and moist heat, as they can make use of. The *rationale* of this practice is, that after the comb or flower has made its appearance, the stem ceases to increase in length, and consequently all the nourishment supplied by the transplanting goes towards increasing the size of the comb.

*Melons.* But what struck us above every thing under Mr. Harrison's management was his abundant crops of melons, all growing on plants raised from cuttings. We have already described this practice (Vol. II. p. 415.) as adopted by Mr. Harrison, for the purpose of obtaining a second crop; but as he has here adopted it for almost the whole of his main crops, we shall give an outline of his present practice, subject, if we should err, to his correction in a future number. In the beginning of the season one hill of seedlings is planted of each of the sorts it is intended to cultivate during the summer, and from these seedling plants, or their offspring, cuttings are taken for all the crops. A one-light frame is set apart expressly for striking the cuttings, and in it a stock of rooted plants, but never of more than three or four days' growth, are kept all the summer. A bed or pit being ready to plant, rooted cuttings are chosen, on which fruit blossoms have already appeared, and these are distributed over the beds at distances so as to allow one or from that to two square yards of surface to each plant, according to the size of the leaves and the mode of growth. In five or six days after planting, if the cuttings have been taken at the right time, that

is, newly rooted, and with the fruit blossom just beginning to expand, the fruit will be as large as hen eggs; in three weeks the greater part will be full grown; in five weeks some of the plants will have furnished three or four ripe fruit, and will be ready to be pulled up and replaced by others; and thus in an extensive pit or set of frames, every two or three days during the summer, the process of taking up and replanting will take place. It must be evident to every practical gardener that no such rapid and certain mode of having an abundant crop of fruit has hitherto been practised. For our parts, we were quite astonished to see so many fruit with so small a proportion of leaves and vines, and to find fruit in every part of every sash of above a hundred sashes. The plants are watered with the drainings of the melon ground, which are led to a well in which they are concentrated by evaporation and fermented. If the liquor is not sufficiently strong, there is a heap of recent sheeps' dung ready to add to it. Mr. Harrison prefers that it should ferment some time before using, which is in unison with the practice of the German and Dutch gardeners and farmers, who never use the contents of their urinariums till they have fermented for five weeks. (p. 548.) All Mr. Harrison's crops of cucumbers, after the first crop, are raised and perpetuated in a similar manner from cuttings, and, as may easily be conceived, the advantages are proportionably great. He is fond of flowers as well as of fruits, and has the borders of his central walk well stocked with the more showy sorts. He has also a hundred and twenty choice varieties of auriculas in pots, all healthy, and some good pinks, carnations, and georginas, for which as well as for pines and melons he has received prizes at the Chichester Horticultural show, as will be seen by referring to the proper department of this Magazine. There are sixteen acres in the kitchen-garden here, besides eight acres of slip and of orchard. Mr. Harrison, as the head manager, has one of his sons as a foreman, and all the rest of the men are common country labourers. A regular scientific gardener as a foreman is essential in such a place as this; and there should also be a regular-bred gardener to attend to the small gardens, and green-houses at the house, if it were only for the purpose of telling any stranger that asks him the names of the plants. The poor fellow who is the master of that department at present, being, as he informed us, *no scollard*, and unable either to read or write, makes sad havoc with the scientific names, and it is impossible that Mr. Harrison or his son can always be in the way.

On the whole, we were very much gratified with the house, the grounds, and the gardens, all of which, especially the kitchen-garden, were in the most perfect order. We shall not attempt to present any thing to Mr. Harrison in the way of encouraging him; but we hope his noble and benevolent employer will present his son with the Magazine of *Natural History* in our name. We must take the further liberty of stating, that we do not think it altogether creditable to a nobleman of the Earl of Egremont's wealth and good character to have the people about him so utterly ignorant as the mass of them appear to be. It would not cost much either of trouble or money, to establish proper schools and libraries all over His Lordship's estate in this part of the country, and to lay down a rule to be acted upon by all managers and upper servants, and which would soon be voluntarily imitated by the farmers and tradesmen; viz. that no man or woman, born after the year 1826, should be employed, who could not produce a certificate from one of these schools, or otherwise show that there or elsewhere he or she had received a competent stock of school education, and could at least read, write, cipher, measure land and work, and draw. In the mean time, we think a garden library should be formed, and Mr. Harrison encouraged to take young men, as at Welbeck and other places, in order to initiate them in his practices, and produce a few good gardeners for a part of the country which seems at present to be very much in want of them.

*Blackdown House*; William Yaldwin, Esq. August 12. — From Hasle-

mere, this place is approached through three or four miles of lane, such as we do not recollect to have seen in any part of England south of York ; it is, for the greater part, a deep narrow gutter passing over a very hilly surface, and the soil being composed of sand and stones unequally mixed, the rains have washed out the bottom of the road into irregular hollows, and strewed the whole over with stones of different sizes, so that many parts have more the appearance of the dried up bed of a mountain torrent than of a road. There is no better approach to this house in any other direction ; but nothing could be easier than to make one, the soil being easily worked, and stones every where abundant. Bad as this approach from Haslemere is, however, we felt ourselves repaid on arriving at the romantic scenery in which is situated Blackdown House. This house has been upwards of five centuries in possession of the same family, and was at one time occupied as a place of concealment by Cromwell, whose room and various articles of furniture are still shown. The surprise and delight which we experienced on arriving at this place through wild heaths and woods, arose from coming suddenly and unexpectedly to a comfortable and commodious house in a secluded, hilly, umbrageous situation, surrounded by gardens, terraces, covered seats, waters in the French style, and furnished within with all the luxuries of the modern drawing-room ; a harp, an upright piano by Stoddard, books from Colburn's library, the *Library of Useful Knowledge*, and the *Library of Entertaining Knowledge*, and a young lady who had just returned from finishing her education in the Rue St. Honoré, Paris. In front of the house is an avenue of very old silver firs, some of which have taken curious irregular forms, and one is 15 ft. in circumference at the surface of the ground, which leads up a steep hill formed into terraced slopes to a prospect house. In the kitchen-garden there is a standard white fig-tree, and another of a brown fig, both of which are very old trees, covered with moss, which make little wood, but what they do make is well ripened, and they in consequence bear abundantly, and the situation on the southern declivity of Blackdown Hill being very warm, the fruit ripens early. Figs had been gathered from these trees this year in the last week of July. There is an arbutus between 18 and 20 ft. high, two large myrtle bushes, which only get a little protection during very severe east winds, large hydrangeas splendidly covered with flowers, and *Fumaria lutea* beautifully sprinkled over the old walls and buildings. Mrs. Yaldwin, the mother of the present proprietor, has for a number of years, since the death of her husband, farmed very extensively, and in the best style of this part of the country, which however, compared with Northumbrian practice, cannot be called good. Mrs. Yaldwin grows turnips extensively in the broad-cast manner, and uses oxen as well as horses in her teams. For a lady farmer she is a pattern of intelligence, activity, and orderly management. In the kitchen-garden she has a plantation of Cobbett's corn, which, being already in the ear, is as likely to ripen as any we have seen. The grounds near the house and along the side of the hill afford remarkable facilities for elegant landscape, water, woods, variation of surface, distant prospect, and a hill-side walk ; the latter in our opinion the finest description of walks which Nature affords or art can create. But the house, which is concealed in a bottom, would require to be removed, and the whole of the present garden scenery and offices rearranged. There are some remarkably fine situations for cottages or small villas in different parts of this estate. A gamekeeper's lodge, situated on one of these knolls, taken on lease by a Mr. Fitzherbert, has been very much improved ; and the same gentleman built a prospect house on the brow of the hill, and formed several public walks in the neighbourhood. The prospect house was furnished with a table and benches for the use of parties of pleasure from Haslemere and elsewhere ; but we regret to state that they have lately, since the death of Mr. Fitzherbert, been stolen or broken to pieces. This, however, ought not to deter from similar acts of public spirit,

because it is the infrequency of such acts that, by keeping the rich and poor too far apart, renders the kindness of the former liable to be abused by the latter. Raise the character of the poor by education, and every act of the rich, whether good or bad, will be appreciated as it ought to be.

*Haslemere to Goodwood.* August 15. — This is a beautiful road, hilly, but presenting numerous richly-wooded views. Near Midhurst are the magnificent ruins of Cowdry House, and about a mile from these ruins a modern house, the present residence of the proprietor, W. S. Poyntz, Esq. The ruins are seen from the road, and the walks round them form an elegant recreation for the inhabitants of Midhurst. We deferred going to the new house till an other season; but Mr. Bowers, Lord Selsey's gardener, informed us, that near it is one of the finest situations for garden operations in England. Near Midhurst is *Midhurst Cottage* (fig. 117.),

117

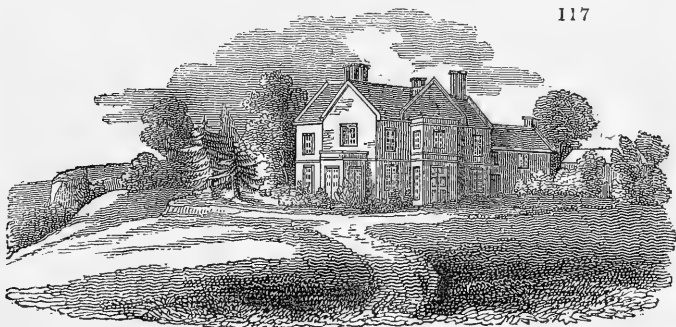

designed and built for the Rev. Dr. Bayley, many years master of the celebrated Midhurst school, by Mr. Perry of Godalming. It is in very correct taste, and superiorly fitted up with the best materials from old English examples, and with particular attention to internal convenience. The walls are of free sandstone worked fair, and being of a fine soft brown tint, the effect with the green of the landscape, and the blue and white of the sky, is particularly harmonious. Mr. Perry, who excels in drawing landscape no less than in architectural drawing, and who also paints both landscape and architecture in oil, has presented us with a neat little view of the cottage, from which the engraving is executed.

*Westdean House*; Lord Selsey. August 15. — Before arriving at this place, a regularly laid out farm and offices in the Berwickshire manner, attracted our attention, and further on we observed the plantations remarkably well thinned and pruned. These plantations, and many other acres that we had not leisure to go to see, Mr. Bowers informed us were planted by him, and are under his care, and certainly we have seen but few so scientifically managed. We hope Mr. Bowers may be induced to send us some account of his practice.

Westdean House is situated near the bottom of one of those flat dry valleys which are common in chalky countries. The spot is by no means marked by Nature, and perhaps something more might have been done by art, in the way of a terraced basement, to enhance that which is fixed on. However an exceedingly good, plain, Gothic house is built; and as the views from it cannot be rendered striking, from the absence of natural features and water, they are at least pleasing. According to the momentary impression made during our hasty glance, the carriage entrance ought to have been in the other front, which, being without distant view, would have left what interest there is in the distant scenery to have surprised the visitor from the windows of the garden front. This mode of entering a house from the front,



containing the best views, is in our opinion a prevailing error in the arrangement of country residences. There are exceptions, but in general the best view which every house affords ought not to be enjoyable otherwise than from the windows of the best rooms. This once adopted as a principle will readily point out the subordinate arrangements.

The pleasure-ground here owes every thing to art, and is beautifully arranged. The masses of shrubs and flowers were more finely tufted, and more profusely covered with blossoms, than any we have seen during our excursions this year. The only masses that came up to them in point of compactness, were those in the Duchess of Gloucester's American garden at Bagshot; but as these were exclusively American shrubs, and mostly out of flower, and those at Westdean peat-earth shrubs mixed with flowers, a comparison cannot properly be made. There is a certain age or size at which American shrubs, in masses and mixed with flowers, look better than at any other; from which it may be inferred, that when this kind of ornamental scenery attains a certain age, if the expression of youth and beauty is meant to be continued, it should be taken up and replanted. Among the contrivances adopted for giving interest to the walks, and to separate one scene from another, are portions of walk covered with arched trellis work. One of these is grown over with climbing roses; another with laburnums, which in the flowering season has a remarkably fine aspect, few colours looking so well in the shade as yellow, because, with the exception of white, none suffer so little from the absence of light. This laburnum trellis has a new feature, that of a table border of trellis work (*fig. 118. a*)

intended to be covered with ivy: we have no doubt its effects will be good, especially in winter. We must remark some circumstances in the construction of garden trellises which should never be neglected: they should be ample in their dimensions, strictly geometrical in all their forms, and most accurately and substantially executed. Nothing can be more miserable in its effect on the eye than a low narrow archway, the supports leaning in different directions, and the curve of the ground plan and of the roof in no marked style of determinate lines. The most accurate carpentry and smith work ought always to be employed in such structures, otherwise they had much better be omitted as garden decorations. Some attempt forming trellises over walks with long hazel rods; but nothing can be meaner than the effect. Such rod trellis-works or arbours are at best fit for a cottage-garden, or a hedge alehouse. We would refer in proof of this to a quarter of a mile of this description of structure in the garden of one of the most wealthy of British noblemen, were it not for hurting the feelings of his very worthy gardener, who, we believe, erected them from the desire of saving his master's pocket. We have sometimes thought of recommending *Wistaria Consequana* for arched trellises; but as the purple blossoms of this plant require a good deal of light, it is better adapted for arcade trellis-work in which the sides are open, or for wire umbrellas. (Vol. IV. p. 168.) There is a rustic house here very well managed, and made of some consequence by being placed on a raised basement; not a bad cascade, but the bed of the stream below it rather too regularly studded with grotesque stones; some very fine specimens of broad-leaved elms; one or two large limes; a very large *Aràlia spinosa*; several tree rhododendrons which live in the masses of the other species with very little protection; and various large hollies.

The kitchen-garden contains the largest Elruge nectarine tree in England (Vol. I. p. 174.), still in a very healthy state. The soil of the garden is thin loam on chalk. Mr. Bowers, two or three years ago, finding a number

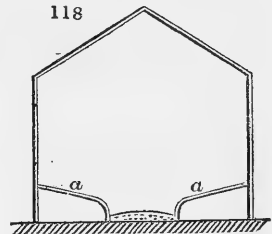

of the wall trees which were trained horizontally thriving but indifferently, by unnauling the shoots, and relaying them in, at an angle of 40 or 45° in some cases, and merely turning up their points in others, according to the degree of suffering, has succeeded in throwing new vigour into them. Many of the trees have their main stems trained in the screw manner of Hitt, and some vines in the serpentine manner of Forsyth, who was patronised by the late Lord Selsey. This garden contains what we think ought to be in every good kitchen-garden, a fruit room and fruit cellar, because it must in most cases be gratifying to the mistress of a family to be able to see what fruits are gathered, and how they are keeping, and sometimes desirable to sit down with her friends or children and eat fruit fresh from the plants. The gardener's house is in one corner of the garden, and it gives us pleasure to state that it is convenient and commodious, though we wish Mr. Bowers had made the ground floor two steps higher. The floor of no dwelling-house whatever, nor of any garden seat, temple, or ornamental building, ought to be on a level with the surrounding surface, but always above it, for dignity's sake, and for dryness; and a dwelling-house at least three steps. The whole of this place was in most excellent order, even though the family were not there, and were not expected for several weeks. This is as it ought to be. On the whole, we were highly gratified; in proof of which we have sent Mr. Bowers's foreman, Thompson, the first volume of our *Magazine of Natural History*. Mr. Bowers himself is known to rank among the very first of his profession, and therefore is above our praise.

*Goodwood*; Duke of Richmond. August 12. — This is a very extensive place, but without any very striking features, and without water. However, from a belvedere, about half a mile from the house, a very extensive prospect is obtained, which includes the sea and the Isle of Wight. The native woods are very extensive, and chiefly of beech. Miller informs us that one of the Dukes of Richmond planted a great many exotic trees, and especially cedars of Lebanon, and the true service. We saw a good many cedars of a considerable size in the pleasure-ground, and in that part of the park nearest the house; but neither from the kitchen-gardener, nor flower-gardener, nor a man nearly ninety years of age, who had been all his life on the premises, could we learn any thing of the true-service trees. We found the *Sórbus torminàlis* *Lin.* and *S. Aria* *Lin.* both here and in the woods about Arundel, but no other. In what is called the American grove are several tulip trees, standard magnolias of different kinds, American oaks, acers, nettle trees, sassafras trees, catalpas, &c.; the most remarkable of which was a standard *Magnòlia grandiflòra*, in the slip of the kitchen-garden, which we think must have been one of the first layers taken from the original tree in the Fulham nursery: it is about 25 ft. high, with a trunk at least a foot in diameter at the surface of the ground. Round the garden are also some very large and handsome hollies.

The great fault of the pleasure-grounds here is, that there is no grand leading walk proceeding from the house through the scenery. Whatever may be the beauties of a residence, they are lost without this master-walk, which operates as a leading principle to guide in the emplacement and character of all the details. It is totally wanting at Goodwood, and therefore the pleasure-ground is to a stranger a confused assemblage of scenes and objects, good, but unenjoyable. A great fault in the management of the scenes is, that there is an obvious want of hands to keep them in order; and another fault is, that masses of flowers are planted in many places under the drip of trees, where they can never thrive, and in others, as in a regular apple orchard, where they are not in character. Under all the circumstances of this pleasure-ground, the flowery part is by far too much scattered; and in consequence of this, and the want of hands, all that is not immediately round the house is in very bad order. It gives us pleasure to state, however, that in the front of the house the flower-beds looked well,

being filled with geraniums and other showy articles, and immediately under the eye of the Duchess, who is known to be a lady of great taste, and much devoted to floriculture. Good and rare things are wanting; some trumpery rustic structures are not worth keeping up, and there are rather too many rustic boxes in the Dropmore manner.

The kitchen-garden is large, surrounded by excellent old walls, but without any of the modern improvements in glass structures. The soil is very bad. When the present kitchen-gardener came there twenty years ago, the peach trees and borders were in a very bad state. He removed the earth from above and from under the roots, laid a bottom of lime rubbish sloping from the wall, replaced 18 in. of soil, mixing it with chalk and some manure, and he has never since either dug or cropped the borders, but occasionally covered them with a thin coat of rotten leaves; and once a year he stirs the surface with a fork about 2 in. deep. In a few years the trees began to do well, and have continued in a good state ever since. This practice in like cases, and also that of not cropping and not digging in every case, ought to be imitated by every gardener who has front walls and borders. There is a row of standard fig-trees of different sorts, which bear most abundantly. Nothing is ever done to them, excepting thinning out a few branches; and some years ago, as the row was rather crowded, every other tree was removed. It might be an improvement to pick off the summer figs in September, and thin out a few of the leaves, in order to favour the ripening fruit; but it has been found that they bear and ripen very well without these operations. The asparagus here is grown in single rows, 4 ft. apart, and attains a good size. Some vines are trained in single shoots within 18 in. of the top of the wall; and short upright shoots, led up from these as bearers, are spurred in, and produce freely. One of these vines is upwards of 100 ft. long, and all of them are healthy and excellent bearers. The head-gardener, whose name we regret to have forgotten, is a man of sound sense, and master of his profession: his house, which is in the garden wall, is not inconvenient, but the floor is on a level with the walks; so that it is deficient in that degree of dignity which ought ever to distinguish the habitations of men from those of cows and horses, and it must be rather damp. On one side of the garden is an immense tennis-court, much out of repair. The melon ground is in a hollow pit in the centre and lowest part of the garden, the very worst spot within the walls in which it could be placed for the purposes of early forcing; since the cold air being the heaviest, that of the whole garden will gravitate to the lowest surface.

We were much gratified with a view of the house, which we enjoyed unexpectedly, and under very favourable circumstances, it being the week of Goodwood races. The dining-room, drawing-room, and Duchess's room, with the exception of the fire-places and grates, are equal to any thing we ever saw. The dining-room is an oblong, lighted from one side; the walls are painted in imitation of Sienna marble; the furniture, though magnificent, retains still a certain degree of simplicity, which gives the idea of habitableness: the dining-table was laid out to its greatest extent for the visitors during the races; and the row of gilt vases, all won by the Duke's horses at different times, contrasted with the silver and crystal, had a splendid effect. At one end of the room is the side-board, and at the other the door into the drawing-room. This room is apparently the same in shape and size as the dining-room. The end opposite the door from the dining-room terminates in an alcove, the floor of which is raised one or two steps; and in the angle to the right is the door to the Duchess's cabinet, and to the left a door to the hall and staircase. The walls are hung with yellow satin, striped; the curtains and sofas, &c. are of the same material, and the woodwork and cornices are gilt. The effect of the gold and yellow satin is good. The whole appeared to us, if the expression is allowable, chastely magnificent, habitable, and occupied as it ought to be. The only things we should

wish to alter are the grates, and, of all the forms we know of, Metthley's (p. 238.) is what we should prefer. There are some good pictures in the other rooms of the house; a charming picture of the amiable Duchess in the Duke's study; a good mummy; landscapes, by Smith of Chichester; and a marriage supper, by Paul Veronese, reduced from an original of the same, 15 ft. by 8 ft., which we bought in Warsaw in 1813 for 9 ducats, and sold in London in 1818, though it had been much damaged by the fire at the custom-house, for 150 guineas.

*Haslemere to Arundel.* August 13. — The by-roads in this part of the country are very indifferent, which prevents the traveller from having the full enjoyment of scenery which, from its variety and woodiness, is always agreeable, and, from the portions of extreme distance which occasionally intervene, sometimes striking. The entrance of the London road into Arundel is one of the worst town-entrances in Britain, and reminds us of some of the smaller Alpine towns on the Continent. Nothing could be easier than, by a circuitous sweep to the right, to effect an easy and commodious entrance and exit. The present state of things is dangerous, and creates a prejudice against the nobleman who has, or is supposed to have, the power of removing the evil. There are three inns; but the stranger, if he wishes to see Arundel Castle, is recommended to go to the Norfolk Arms, from whence tickets, as if by authority, are issued for seeing the castle. We hate monopolies of every kind, and therefore cannot approve of this seeming preference, though we believe a sight of the castle would not be refused to any person whatever, and at any time, whose appearance did not forbid the hope of his having the usual fee in his pocket. The Norfolk Arms is a good inn, and we were much gratified to find the landlady, Mrs. Flood, much attached to natural history. Notwithstanding the direction of this immense establishment, and the cares of a family of three or four children, she continues to collect every description of insect which she can find, and to hatch the eggs of moths and butterflies, in order to add the perfect insects to her collection. This collection is arranged in glazed frames, which are hung up in different rooms of the house. She is fond of drawing, and has made portraits of several of the prize animals fed in the neighbourhood. On the whole, she is a woman of very superior mind, and, in testimony of our respect for her, we have sent her this Number of the *Gardener's Magazine*, and one or two of the *Magazine of Natural History*.

*Arundel Castle; the Duke of Norfolk.* August 14. — This is an excellent place for a critic, since there is much to condemn, something to admire, and a great deal to anticipate. The only thing which came up to our expectation was the situation of the castle, and the only thing that surpassed it was the variety of surface and facilities for improvements in the grounds. In the elevation of the castle there is not a single good architectural feature, and we should not be far wrong in saying, that the interior did not contain a single room worthy of such a residence. The library, which has been much spoken of, is too narrow and confined, and the mahogany book-cases, like the mahogany four-post beds in the bed-rooms, overloaded with workmanship. The dining-room is gloomy, and only fit for the winter season: some of the bed-rooms are better, and contain mahogany bedsteads most elaborately worked; but no workmanship in timber can come up to that of the needle or the loom for a bed roof. The details of almost every part of the castle, both within and without, were executed by workmen and artists brought to reside on the spot, and are, with very few exceptions, designed or copied with little taste or judgment. The truth is, that the Duke was his own architect, and having nobody to please but himself, caring little for public opinion, and being altogether unlimited in his means, he produced what we see, and probably failed of his object. Had he been guided by a first-rate artist, he at least could not have been blamed by the public; a man is justified in attempting any thing he can do well; but when he engages in what he

knows very little about, the richer he is he commonly renders himself the more ridiculous: good taste is more frequently the result of necessity than of superabundance. Arundel Castle, as a piece of architecture, and as a nobleman's residence, is bungled from the want of one grand general plan to commence with and proceed upon, as well as from the bad taste of the details. We cannot recall to mind any quadrangle of castellated building so nobly placed by nature, and yet so deficient in dignity of expression when viewed from the entrance near the keep. On analysing this expression, we find it proceeds from the lowness of the floor of the main entrance, and the descent to that entrance from the gate to the quadrangle, instead of an ascent; from the want of determinate character in the lines of the plan, which is neither that of a quadrangle nor that of any other determinate figure, which operates on the eye of an artist like imperfect notes on the ear of a musician; from the want of such bold and striking features in the elevation as might have carried off any deficiency in the plan; and, finally, from the details of the architecture, which, setting at defiance all the received associations of art, have yet failed in making us forget this by grandeur or singularity of effect. In short, whatever might be said in favour of some particular parts or details (and we admire some other points besides the picture in stained glass of the signing of Magna Charta, and the alto-relievo in artificial stone of the trial by jury), the general impression is, that of the desire and the pecuniary means of doing something grand and suitable to the situation and the family, without the requisite knowledge or taste.

What has been done in landscape gardening is not better than what has been done in architecture. The place is frittered into details, without connection, and without any pervading principle. There are three or four kitchen-gardens, and three or four places that may be called flower-gardens; but not one grand leading walk to show either these or any thing else. In all that relates to plan, in short, nothing can be worse; but there are some good trees and shrubs in a very thriving state, most extraordinary and successful care having been bestowed on them by Mr. Wood, an estimable man, a gardener of great experience, and interesting to us as being the only Scotch gardener that we know or ever heard of who is a Roman catholic. The present Duke, with that liberality and benevolence which every wealthy family of character in civilised countries shows, or ought to show, to their good and faithful servants, has permitted him, being no longer young, though only nine years in His Grace's service, to retire on his full salary. The characters of the present Duke, and of the Earl of Surrey, in this respect stand very high, and it gives us the most sincere pleasure to put it on record, as a stimulus and example to other wealthy men, and as affording us an opportunity of reminding gardeners, and the other servants of such masters, how attentive they ought to be to them, and how grateful to Providence. We know of families whose maxim it is never to keep servants more than six or seven years, lest they should have a claim on the family bounty for themselves, their widows or children. Mr. Wood is succeeded by Mr. Deas, a young man of great merit, recommended by the Horticultural Society: but no young man, whatever may be his merits as a cultivator, will ever make much of this place till a general system of arrangement, very different from the present, is fixed on, and the main roads and walks executed.

In our excitement at the want of plan, however, we must not forget the fine old trees of different kinds about the castle and in the park. The native trees are the beech, the common maple, and about the castle probably the elm, the ash, and the ivy may be added. There are many very fine old maples, some curious-rooted elms on the castle banks, some large oaks, and some of the largest ivy we ever saw. This ivy has fastened itself on the ash trees, covered every part even of their extreme branches, and

formed an evergreen tree of an entirely new character, having completely killed the ash which supports it. We never saw trees so effectually suffocated by ivy, or ivy with so much of the tree character, and can only compare the operations of the ivy to that of a petrifying spring on the objects immersed in it. In the ancient garden of the castle are five large standard fig-trees, which bear good crops: we had one of the trees measured, and found it 20 ft. high, and the head 22 ft. in diameter; the trunk, about a foot from the ground, is 6 ft. in circumference; it there divides into two stems, which about 5 ft. higher subdivide into numerous branches, which hang down at the extremities till within 2 or 3 ft. of the ground. A Breda apricot against a flint wall in this garden has been planted seventy years; it covers a space 43 ft. long by 18 ft. high, and ripens every year about 1500 fruit, besides a great number thinned off for tarts; the soil is apparently lime rubbish and black earth. There are four large sweet-bays, one of which measures 20 ft. high and 22 ft. in diameter, and ripens abundance of fruit every year, which being greedily eaten by the birds, one can easily conceive how, if the surrounding country were in a state of waste, this and other plants would become naturalised. *Buxus baleárica* has attained a large size, and also ripens its fruit: the largest specimen measures 16 ft. high and 10 ft. in circumference. As we have already observed, there are abundance of modern trees and shrubs, mixed up with fruit trees and roses in such a manner as to destroy all distinctive character; but all in the most thriving state as plants. In the park extensive plantations of forest trees have been made, the ground being carefully trenched before planting, and the subsoil, which is generally chalk, kept on the top. This subsoil being without seeds of weeds keeps the surface clean for several years, by which time it is nearly covered by the trees. The chalk also becomes soil by the operations of the weather, the leaves which fall from the trees, and the lichens, mosses, and insects which are produced: the only unavoidable evil is, that the wind and the birds soon deposit in it so many seeds of bad weeds, that less is gained in practice than we should anticipate from theory.

Having gotten over the most disagreeable part of our duty with respect to Arundel, we have now shortly to hint in what way the grounds of this residence may be rendered among the finest in England. Fix on the two banks and the valley which lie to the east of the castle as the scenery for walks and pleasure-grounds; form a lake in the valley, with islands, peninsulas, and margins for peat-earth plants; the valley being in fact chiefly peat; lead a carriage walk from one of the terraces of the castle, suitably altered, round this valley on a seeming level along the steep wooded bank, opening occasional views, from one bank to that opposite, to the park, the castle, the sea, &c. Join this walk at the head of the valley by two inclined planes, in opposite directions to another walk on the level ground which shall surround the water, and let this lower walk ascend to the castle very gradually, so as to join the grand terrace at a very gentle inclination. Carry on the lake on one level to the back of the main street of the town, and conceal its termination there; forming, near a chalk cliff on the opposite side of the valley, a cascade which shall be seen from the windows of the castle, and give the idea, the springs on this valley being insufficient to drive a mill, that the river Arun flows from the lake. Remove the ditches, fences, willow trees, and all those appearances about the low meadows which at present give them the character of marsh or fen lands, and render them a source of malaria and typhus fever; and by scattered oak trees and other means give them a character of park scenery; render the old garden containing the fig trees a highly enriched ancient flower-garden, surrounded by a rampart or terrace walk, and change into open park scenery a number of the other petty garden scenes, shrubberies, and walks. These are a few of the features of future improvement which struck us at first sight; but it would require days of consideration to form the basis of a general plan suitable for a subject ren-

dered so complicated and deformed by what has been already done. It is but justice to Mr. Wood to state, that the leading feature of these suggestions, the water and the pleasure-ground around it, belongs to him.

The gardener's house here is not inconvenient; but the floor is on a level with the walks, and the walls of the rooms having been plastered with sea sand have an appearance of dampness. The common excuse for low floors and low ceilings is the desire of concealing the building from the general view; but surely good sense and humanity require that this concealment should never be effected at the risk of the health and comfort of fellow-creatures of any kind, more especially of those on whom so much of our enjoyments depend as servants. Wherever two stories of ample-sized rooms would be too high, the bed-rooms may easily be built on the same floor as the day-rooms.

*Michel Grove, near Arundel.* August 15.— This is a place of considerable extent and some natural beauty, arising from the undulating chalk hills, but unfortunately without water. The house is situated in a dry valley, and looks on a rising bank, and like West Dean, Blackdown, and every other house so situated, conveys to a stranger the expression of fixed and impracticable melancholy. It was purchased about the end of the last century by Mr. Walker, the son of a Liverpool merchant, who, it is said, was his own architect, probably in imitation of the late Duke of Norfolk, and whose landscape-gardener was Mr. Repton. The castellated exterior of the house is not bad, though deficient in simple and grand masses; the interior, an ill-natured critic might say, displays a mixture of prettiness and gorgeousness; we shall only state it not to be simple, elegant, or grand. There is an immense drawing-room most gorgeously finished and furnished, with an obvious allusion in the form of the ceiling to one of the three notable rooms, we forget which, in the Pavilion of Brighton, which rooms we do not like much better than that at Michel Grove. The whole estate having been lately purchased by the Duke of Norfolk, he has sold the furniture and materials of this costly house to a local auctioneer, and in a few months it will be rased to the ground. As characteristic of the late proprietor's character, we shall relate one circumstance that was stated to us by Mr. Wood: The Arundel coach having repeatedly refused or neglected to bring from London some brass work intended for a staircase erecting at Michel Grove, Mr. Walker was so angry at the neglect or insult, that he determined on starting an opposition coach; did so, procured the swiftest horses, regardless of their price, drove the coach himself, killed several horses worth 100*l.* each, and ultimately put down the coach which he opposed, by ruining the family who were its proprietors. When acting as coachman, Mr. Walker was most active in seeking for, and assiduously attentive to, his passengers, and received from them the usual gratuity of 6*d.* or 1*s.* uncovered and with every expression of thanks.

In the kitchen-garden is a vinery which was planted, the present gardener states, between 50 and 60 years ago, by one Russel, a Scotch gardener, and this man's master. The stems of the vines are outside the house, their roots in a bed of earth 3 ft. wide and 3 ft. deep, and completely confined by the front wall, which is not built on arches, on one side, and by the native bed of chalk which rises to within 6 inches of the surface, on the other side, and at bottom. Notwithstanding this limited space for the roots, the branches inside the house have all along borne good crops. Last year the gardener found the bed of earth matted with fibres, as he expresses it, like a wig of black hair, and he has removed the chalk in front and widened the border, not doubting that he shall thereby add to the fruitfulness of the vines, and to the size of the berries. We have no doubt Russel's object was to prevent the vines from running too much to wood, the shoots being confined to the rafters, and to induce fruitfulness. At all events, it is important to know experimentally that vines will bear for such a length of

time with their roots so much confined; because it confirms the idea of our correspondent F. N. B. (Vol. III. p. 145.) as to the practicability and proper mode of growing vines in the open air in this country. The same plan of operation will apply to figs, and probably to a certain extent to pears and peaches. The gardener here, Lasaney, is a member of the Brighton Co-operative Society, which he informed us was going on successfully; his employer rents the garden of the Duke of Norfolk, and sends the produce to the watering places along the coast.

*Arundel to Dorking.* August 16. — An agreeable road through a varied and fertile country. *Cnicus acaulis* is abundant on the Downs, and the summits of the broad purple flowers, spread out on a level with the surface of the grass, have a fine appearance. At Pulborough a cottage covered with a very large and handsome parsley-leaved grape, which we were told ripened its fruit in ordinary years. In the churchyard four children of one birth in one grave. Some picturesque, Gothic cottage villas on the right of the road, on the margin of a common two or three miles before entering Dorking, most agreeable to look at; but knowing the small, gloomy, low-ceiled rooms which architects generally form in these buildings, as being characteristic of the style, we have no pleasure in the idea of inhabiting them. Whoever wishes to know the immense importance of continual supplies of fresh air to health, should read Holland's *Enquiry into the Laws which regulate Organic and Animal Life*. (8vo. 1829.) The entrance into Dorking is highly enriched by cottages, villas, gardens, trees, and hills; the town, as compared with many others, may be described as elegant and picturesque. William Fuller, a tinman, makes a very ingenious seed-box for feeding pheasants; and Mr. Carter, Woodhatch, Hargate, potter, makes handsome garden vases, in use at Deepdene and other places; both these articles are worth having, and may be obtained through Donald and Westland, in Dorking; or Charwood, seedsman, Great Russel-street, London.

*Donald and Westland's Nursery.* August 17. — Mr. Westland is an excellent cultivator, and an ingenious mechanic. He built, glazed, and painted his own green-houses, and has a propagating pit heated by dung thrown in at one end. He propagates very successfully all the more rare and elegant Cape and New Holland plants, has raised several new georginas, and maintains a good collection of the more showy border flowers, annual and perennial. Those fine showy plants, *Lupinus mutabilis*, *Oenothera speciosa*, introduced by Mr. Bunbury (Vol. II. p. 298.), are here finely grown, and now in great beauty. Water for the green-house is kept in large cisterns of pavement stones grooved into each other, and made water tight by Roman cement, as is done with the Plymouth and Welsh slates, when used for the same purpose.

*Deepdene; Thomas Hope, Esq.* August 17. — This is a place which presents but little food for the critic, since it contains so much beauty, both by Nature and by art, that there is little left for him to do but to walk round and admire. Even the historical associations of the place are beautiful. The situation was distinguished by its natural beauties and delightful prospect so long ago as the time of Charles I., at which time it was selected as the retirement of the Honourable Charles Howard, a man of science and taste, who effected several garden improvements here in the terraced style of his time. In Camden's *Britannia*, Deepdene is said to contain "gardens, vineyards, grots, terraces, and plantations." Aubrey, in his *Antiquities of Surrey* (Vol. IV. p. 164.), describes it as "a long hope, i. e. according to Virgil *deductus vallis* (a lengthened valley), contrived in the most pleasant and delightful solitude for house, gardens, orchards, boscages," &c. which he had seen in England. Mr. Hope has greatly enlarged the house and offices, and having combined in them all the finest parts of what may be called the landscape architecture and sculpture of Italy, has formed a whole,



the greatest praise that we can bestow on which is to say, that it will delight such men as Sir Uvedale Price and Gilbert Laing Meason. The house, with the conservatory and sculpture galleries on one hand, and the dairy, laundry, &c. on the other, forms a group so rich in classic forms and combinations, that no one can duly appreciate its beauties, whose mind is not thoroughly imbued with Italy and the fine arts. It is, in short, an

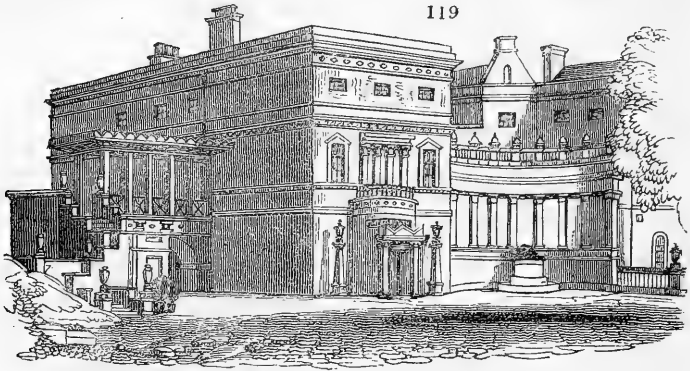

example of what the Germans call the ecstatic in architecture. There is not one English architect who would of his own accord have designed such a house; nor, if he had designed it, could he have found more country gentlemen by whom it would have been understood or carried into execution, than the Gard. Mag. would find readers if it were published in Greek. Accordingly, as we are informed in the account of Deepdene published in Neal's *Views of English Country Seats*, "the house was altered under Mr. Hope's direction, and from his own designs, in which the more recent discoveries in Grecian and Roman antiquities make a prominent feature, by P. Atkinson, Esq."

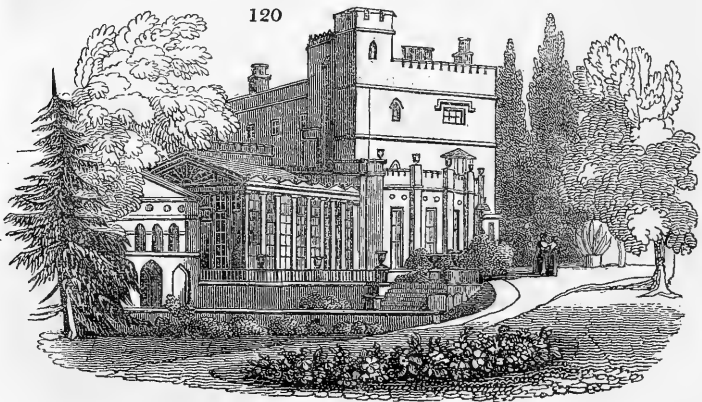

The property, we are informed in the same work, "consists of above 400 ac. of pleasure ground, so judiciously disposed, that a walk admitting a pleasing transition of view, of upwards of 12 m. may be undertaken without retracing one step. The surface partakes of the greatest irregularity, and

the ground, in general bold, sometimes hangs abruptly over the walks, and at others declines in gentle slopes to the level parts." We refer to Mr. Neal's work for a historical and detailed description both of the house and grounds, and shall content ourselves with copying from it slight outlines of the elegant engravings given of the entrance front (*fig. 119.*); south front (*fig. 120*); north-west front (*fig. 121.*) of the house; and one of the entrance

121

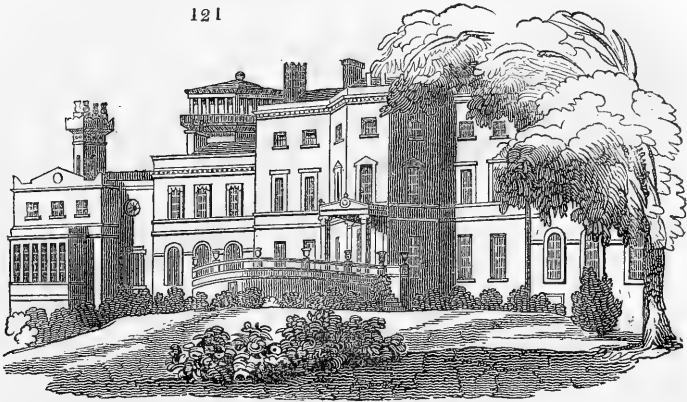

lodes (*fig. 122.*):—and merely put down some gardening recollections, and but a few, as the almost incessant rains that fell while we remained at Dorking, prevented us from seeing more than the kitchen-garden, and the immediate vicinity of the house.

The kitchen-garden has been lately much enlarged, and surrounded by a wall. On the fruit-tree borders of this wall Mr. Woods intends growing no crops, nor even digging it after the second or third year. In the brick-built pits excellent crops of cucumbers have been grown in beds of earth, supported by fir poles covered with turves, and heated by recent stable dung thrown in at one end. The plants grow so vigorously after the first great heat of the dung is exhausted, as to send the roots through the turves and moist air into the fermenting dung, and the dung and earth being now removed, we saw the remains of the roots adhering to the side walls. There is an arched trellis over the main walk, which connects the kitchen-garden with the fruit-garden, on which gooseberries are trained, and bear most abundantly. This trellis is here admirably placed, because it disguises the descent of the walk to the tunnel through which it passes under a public road to the fruit-garden, and is therefore desirable as an object of design and taste, and it is rendered most economical by the heavy crops it produces. Mr. W. grows more sorts of peas than we ever before saw in any one garden. He has three sorts that are eaten in the pod like kidneybeans, one of which, the dwarf sugar, he recommends as particularly prolific. In gathering for use, he varies the sorts, so that one kind is never sent twice in succession. The dry sandy soil is peculiarly favourable for this description of culture, in wet seasons, and not less so by the aid of water when the season is dry. Every year Mr. W. gathers peas from the end of May to the end of November, and we hope he will send us a paper

122

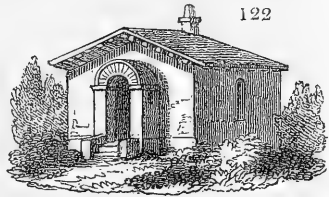

on the subject. In the fruit-garden there is an excellent crop of grapes, in a vinery on Mr. Atkinson's construction, and one of peaches in low Dutch pits, like those of Mr. Labouche (Vol. III. p. 390.), without artificial heat of any kind, by which the fruit comes into use between the forced peaches and those in the open air. In a botanic stove in this garden there are forty-nine species and varieties of *Hibiscus*, recently raised from imported seeds; only one or two of which have yet come into flower. *Francisja Hopeana*, formerly noticed, is here in great luxuriance and beauty. In the open border is a fine specimen of Mr. Barclay's scarlet thistle, and another thistle 8 ft. high, which Mr. Woods, who is an excellent British botanist, considers a new species, and we hope it will be named after him. In a smaller inclosure the American and English cranberry are doing remarkably well in beds of dry peat.

The valley, open and sloping to the south, from which this residence takes its name, besides its architectural and sculptured decorations, pæsantry, fountain, grotto, and some rare antiquities, is richly ornamented with groups of American and other rare shrubs and trees, exotics and annuals; and no situation can be better adopted for half-hardy articles. *Sálvia chamædryöides*, with its deep-blue flowers, has a very fine effect in summer masses. The *heliotropiums* planted out here are of a very distinct variety, large in their leaves and flowers, and so hardy, that they ripen, seed, and sow themselves. Mr. Woods pointed out to us several plants which had sprung up from this year's seeds. The *georginas* are remarkably good, and the whole of them were raised in the early part of the season from cuttings, the advantages of which Mr. Woods has promised to point out in a professional communication. There is an excellent collection of tree and dwarf roses; and at few places does the yellow rose bloom so freely as here. The *Liquidambar* and *Magnölia tripétala* are rising in the woods from self-sown seeds; the former is so abundant that it might pass as indigenous.

The conservatory is highly ornamental from the style of its architecture, the free growth of the plants, the fine disposition of the climbers, the exterior approach through a terraced garden of orange trees and exotics, and, above all, its connection with the galleries and cabinets of the most exquisite sculpture, antique and modern. A specimen of *Fúchsia grácilis* is remarkably fine, and perhaps the largest in the country. Most of the things have grown so bulky, that, with the exception of some of the creepers, Mr. Woods proposes to take them out, renew the soil of the beds, and replant, with a selection from the best and most suitable things now in green-house culture. This practice deserves the particular attention of all who possess conservatories. Experience will soon prove, that whenever ornamental plants are planted out in beds of earth under glass, they will require renewal every five or seven years, in the same way as do plantations of gooseberries or raspberries. In front of the conservatory is a plantation of orange trees in pots sunk in the ground; and of different descriptions of green-house plants, chiefly from the Cape of Good Hope and New Holland, turned out of the pots into the soil, in order to grow and flower freely during the mild season, and take their chance of standing the winter. The effect in summer is excellent, and it has been found that several New Holland species, such as *Acácia dealbàta*, and others, have survived several winters. We have repeatedly recommended this practice, both with hot-house and green-house plants, not only for the sake of the rare and splendid appearance produced during summer, but for the chance of finding some of the species hardy enough to stand the winter, and thus adding to our acclimated trees. Every gardener who has a green-house or a hot-house, or even pits, which will keep plants during winter better than either, ought to have a clump on his lawn expressly devoted to this purpose; and in this clump, every May, he ought to turn out all his spare plants. If he has no lawn, he undoubtedly will have borders; and he will

find no way of rendering them so interesting as by the use of his spare exotics, especially the free-flowering Cape and Australian plants. Gentlemen's gardeners in the country, who have abundance of showy green-house things, such as pelargoniums, fuchsias, brugmansias, heliotropes, cinerarias, celsias, &c., might give some of them to the cottagers on their masters' estates, for the sake of ornamenting the roadside gardens. Snakes and adders are occasionally seen in the grounds here; but Mr. Woods has nearly extirpated them, by giving 3*d.* for each of the former, and 6*d.* for the latter, to his men.

The only fault that we can find with Deepdene is, a want of high keeping in the grounds near the house, and in the fruit and kitchen gardens. We do not speak of the walks in the woods; these, and almost every thing a furlong from the house, are just as they ought to be: the whole place, indeed, may be called well kept; but it does not display that high and polished neatness which the architecture of the house, and its sculptured and classic appendages, seem to demand. The grass about the house ought to be mown oftener, and a part of the walks and roads, especially in the focus of art and ornament, laid with Kensington gravel. The walks in the kitchen and fruit gardens, being rather steep, we would form of flagstones, placed on piers, with open joints, by which means they would at all times be in perfect order; whereas now, in consequence of the slope and sandy soil, every shower deranges them. We are sure such walks, at such a place as Deepdene, will be found cheaper in the long run than those of gravel with box edges. These walks formed, and the addition we should suppose of three garden labourers, would make all the difference between Deepdene as it is now, and as it is in our *beau ideal* of what it ought to be.

We do not speak of the sculpture gallery, because, greatly as we admire its contents, and respect the high and cultivated mind that selected and placed them there, we feel that we are incompetent to do it justice. Duly to appreciate works of art of such extraordinary rarity and excellence as are here assembled, would require more of the mind of the artist and the classical scholar than we can pretend to. All must feel the effect of sculptures and paintings to a certain extent; but this feeling, like every other, to be made the most of, must be highly cultivated. The feeling which these sculptures excite in us, when viewing them, is that of reverence and awe at the presence of so much mind; on leaving them, the idea presents itself of the man who has shown his appreciation of such excellence, and we think of him with profound respect. To say a word in the praise of either, we do not think necessary.

We were gratified by a view of the house in September, 1827, from which much is to be learned, and in which the value of admitting light in masses is well exemplified.

Mr. Woods, who stuffs birds, and has formed a cabinet of the objects of natural history found on the estate, has promised us, at some future time, a general account of Deepdene, with a catalogue of its native productions, animal, vegetable, and mineral, with which, we are sure, our readers will be highly gratified. He is above our praise or reward; but we have, nevertheless, sent him a part of Jardin and Selby's *Ornithology*.

*Bury Hill*; Robert Barclay, Esq. Aug. 15. — This is a fine old place, simple and grand, like its excellent and benevolent proprietor. We cannot do justice to the whole residence at present, and therefore shall confine ourselves to a very short notice of the kitchen-garden, well known to every botanist in the world as a centre for the reception of plants from, and their dissemination through, all countries. M. Otto of Berlin, who had lately been here, told us he was more struck with the collection at Bury Hill than with that of any private gentleman's garden he had ever been in, either in this country or on the Continent. The hot-houses (*fig. 125.*) have a remarkably mild and harmonious effect exteriorly, from being painted of a

stone or cream colour ; the stoves have lately been heated by hot water, by Mr. Fowler (p. 455.), entirely to the satisfaction of Mr. Cameron. Mr.

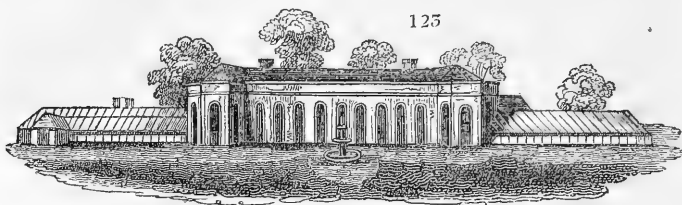

Fowler, in his boiler, combines the improvement of Mr. Cottam (Vol. IV. p. 17.), and one in use by several engineers, that of causing the flame completely to surround the boiler. He also places all his pipes on a gentle slope to the boiler, in such a way that, when the water is not wanted, he can, through a cock there, drain off the whole. He introduces in the pipes several air-holes, which facilitate circulation ; and, on the whole, he may be considered as having added something useful to the improvements already made in this system of heating. Mr. Cameron lighted a fire, to show us in how few minutes the pipes were heated from one end of the house to the other.

The plants in the houses are in the very best order ; the collection is most numerous, and the rare species of far too frequent occurrence among them to be noted down in a passing visit. The collection of ferns is considerably increased since Mr. Cameron sent us his catalogue (Vol. IV. p. 1.). In the border in front of the hot-houses, the usual sanctum for choice half-hardy exotics, are many rare and fine things. *Cönium Arracàcha* in good health, but Mr. Cameron thinks there are two varieties or species, and is doubtful whether this be the true one. *Oxalis tetraphyllus Cav.*, and another species, the roots of both of which are eaten, like those of the *Arracàcha*. *Verbena chamædryoides* is trained against the wall, like a tree, and, covered with its deep-scarlet blossoms, has a most splendid effect. *V. pulchélla* is also so trained, and looks well. There are many new and rare things in the borders, and we hope Mr. Cameron will find leisure to make a supplement to the list he formerly sent us. (Vol. II. p. 297.) In front of the hot-houses is a fountain (see *fig. 125.* above), supplied by the aquatic ram of Montgolfier, which also supplies an aquarium in another part of the garden lately formed, different cocks in the compartments, the offices behind the hot-houses, the gardener's house, and the family mansion and offices. We have before alluded to this very ingenious machine (Vol. III. p. 253.) when speaking of No. II. of the *Library of Useful Knowledge*, where it is described. No machine hitherto invented can effect so much, with so small a quantity of water, and so trifling a fall. The Washington plum, introduced by Mr. Barclay, shows abundant crops on the walls, and is now nearly ripe. In the open garden is an enormous crop of large onions, which, Mr. Cameron informs us, he never fails to have, by sowing in autumn, and transplanting in rows early in spring. Success in this practice often fails from the transplanter burying or dibbling in the bulb, instead of *firming in*, or pressing the earth to the fibres only ; the bulb, or rather the part destined to become the bulb or onion, ought to be entirely above ground, or, at least, in loose earth. In the garden-room, between the green-house and vinery, we observed a straw seat with a back, formed of layers of straw, in the manner of the straw bee-hive (*fig. 124.*), which seems a clean and comfortable piece of garden furniture ; and, in the tool-house, a two-edged blade,

124

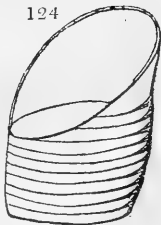

fixed obliquely to a long handle (*fig. 125.*), used as a daisy-rake for cutting off flowers and herbs which obtrude themselves on grass lawns. For using this daisy-knife the handle is held with both hands, and the blade is moved to the right and left along the surface of the grass; the operator advancing from behind the work, as in mowing.

125

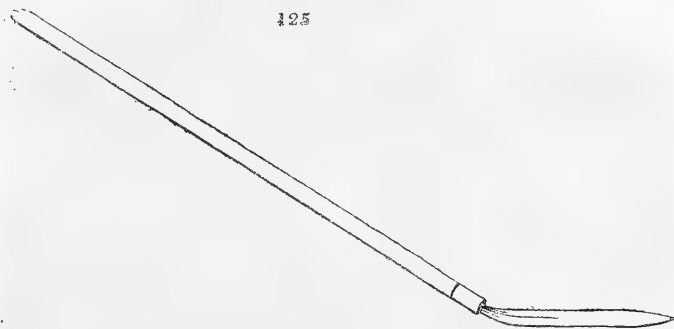

*Denbighs.*—This house is on the top of a hill, which commands a fine prospect, with the town of Dorking at its base; and beyond that, Deepdene. The approach is a mile and a quarter in length; great part of it through a plantation, mixed with spruce firs, which, notwithstanding the dry calcareous soil, in 1827 made shoots from 2 to 4 ft. in length. This is the more remarkable, since the natural soil of the spruce fir is soft and moist, as in the north of Prussia, and in the Black Forest on the Rhine.

*Ashtead Park*; Col. Howard. August 18.—The house is a plain substantial building, in a situation not much marked, either by nature or art, but surrounded by turf and good trees, the latter not badly disposed. The kitchen-garden is the best managed of any which we have seen during this tour. The soil is very unfavourable; but Mr. Hislop has overcome this, and every other difficulty, so as to produce excellent crops both of fruit and vegetables, and no garden was ever in more perfect order and neatness.

At one end of the house is a flower-garden (*fig. 126.*) on the open lawn, in the form of a parallelogram, surrounded by a gravel walk (*a*), and the whole

126

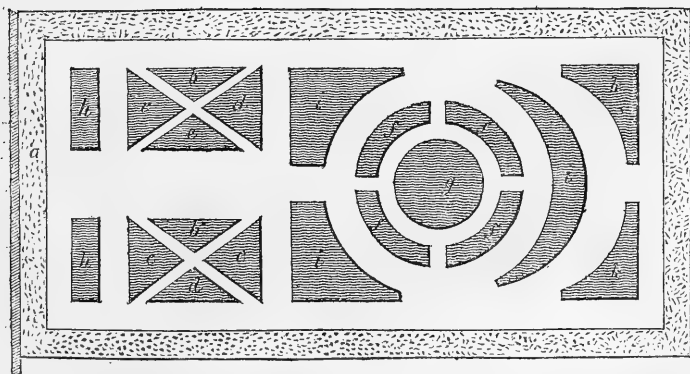

enclosed by a light wire sheep fence: it is simple, but suitable to the house, and the effect is good. It consists of three compound clumps (*b* to *g*), and

seven simple ones (*h* to *k*), and is thus planted : *b*, pinks ; *c*, heliotropes ; *d*, greenhouse plants of various sorts ; *e*, carnations ; *f*, dwarf roses, mignonette, and standard roses, every 6 ft. ; *g*, standard roses and mignonette ; *h*, pelargoniums ; *i*, herbaceous plants of choice sorts, with bulbs intermixed, an equal number for every month of three fourths of the year ; *k*, a collection of cistuses and helianthemums.

There are two pine and grape stoves heated by hot water, by Mr. Cotnam ; the vines are *spurred in*, and have produced remarkably large leaves and berries, and a regular and most excellent crop. We do not know that we ever saw the *spurring in* method of pruning attended with so few superfluous summer-shoots ; though we could not find that Mr. Hislop did any thing more than pinch off these at the first leaf, in the usual manner, and always on their very first appearance. He had lately lifted the plants, and placed the whole of their roots in a bed of new soil, on which he has placed turf and a few beds of flowers. We hope he will give us a detailed account of the manner in which he performed this operation. The pines looked as well as the vines. The wood of certain fig trees, trained against a wall, grew so luxuriantly that it never ripened, and of course little or no fruit was produced. Though the trees were covered every winter, the points of the young shoots were generally found rotten when the covering was taken off in spring. Mr. Hislop thinned out the wood of these trees, and cut off and walled up their roots about 3 ft. from the wall ; the consequence of which is, that the supply of nourishment being limited, the trees now make but little wood, but that little being perfectly ripened, it requires no covering in winter, and every year a crop of fruit is ripened. The fig trees in the Duke of Northumberland's forcing-houses at Syon are walled in a similar manner by Mr. Forrest. The garden being too small for the consumption of the family, Mr. Hislop is obliged to put slight crops on his borders ; but he entirely disapproves of the practice, and would not even dig them, but do every thing in his power to encourage the roots to come to the surface ; a practice, as Agronomer advises (Vol. IV. p. 478.), which deserves adoption in orchards, and wherever fruit trees are grown on a bad sub-soil. In such a garden as this we think the mode we have suggested (p. 595.) of forming the walks of flag-stones would be decidedly economical ; because the stones being laid on brick piers, founded sufficiently deep in the soil, and the surface of the soil being kept 3 or 4 in. under the flags, the width of the walks might be considered as so much added to the width of the fruit-tree borders. By placing the flags a quarter of an inch apart, instead of close-jointing them, the rain would run through the joints to the soil below ; and there being no danger of ice being formed in the joints, the stones would not be displaced by the operation of frosts and thaws. In a garden of an acre, with a surrounding walk and two cross-walks, the saving of ground by such walks would often be about one-sixth part ; besides the saving of labour in trimming the box or other edging, weeding, and rolling the gravel. We hope some gardener in a district where flag-stone abounds will try this description of walk, and let his brethren know the result. In steep slopes the flags might be laid like broad oblique steps, with rises of half the thickness of the flag, in the manner of the broad staircase to the Monte Capitolino in Rome. A wheelbarrow is easily wheeled up and down such steps, and they are walked over as easily as a common slope.

The borders in this kitchen-garden are without fruit trees or bushes, and wholly devoted to herbaceous and annual-flowering plants, with which they are at present exceedingly well stocked. The soil is particularly favourable for the growth of carrots and parsneps, which attain a very large size, but do not keep. The crops in the melon-ground are good, and the succession pine-plants in excellent health. Every part of the back sheds was orderly and neat, and more especially the tool-house, which is a shed, open in front, in which every tool, and even the ladders were suspended from the back

wall. Mr. Hislop has invented a short grass-rake (*fig. 127.*), which consists of a piece of thin plate iron (*fig. 128.*) cut into teeth,

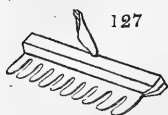

127

with two slips of ash, or other tough wood, between which it is firmly riveted, to form a back, and keep it from bending. When put

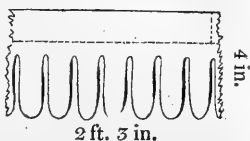

128

together, the back is  $1\frac{1}{4}$  in. thick. The wood is beveled to nothing half an inch above the interstices of the teeth, at which point the iron is slightly bent longitudinally, to admit the thickness of wood underneath, and give a proper inclination to the handle. The instrument serves both as a grass-rake and a daisy-rake, and has the advantage over the daisy-rakes in common use of being easier cleaned, from the wideness of the interstices between the teeth. We have not time for further details, and indeed have partly forgotten some other things which we intended to notice; but we repeat that we were better pleased with this kitchen-garden than with any other which we have seen on this excursion; in testimony of which we have presented to Mr. Hislop Vol. I. of our *Magazine of Natural History*, and a copy of the *Encyclopædia of Plants*.

*Epsom Nursery*; Messrs. Young. August 18. — This nursery has undergone considerable changes since we last saw it in 1827. At that time it had been enlarged and improved, and one of the foremen, a self-taught drafts-

129

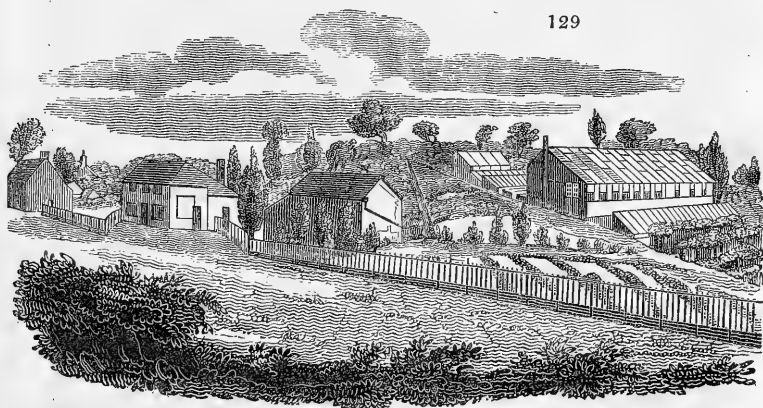

man, had made us a general view of it as seen from the road. (*fig. 129.*) Since that sketch was made, several plant-houses and pits have been erected, and, as will be allowed by any one who is in possession of *Hortus Epsomensis* (vol. iv. p. 260.), the most extensive collection of herbaceous plants, at least in Britain, has been assembled. A great many species have been added since the catalogue was published, and some of very great rarity. The lists of rare plants which flower in the Epsom Nursery, furnished us by the botanist of the nursery, our very intelligent correspondent, Mr. Penny (p. 470.), render it unnecessary for us to enter much into detail, and indeed, if we were determined upon this, we do not know where we should begin. Mr. Penny is a most successful propagator, and the number of young plants, of rare articles, both of the green-house and open air, is sufficient, one would imagine, to supply all the trade, both in Britain and France. Messrs. Young have bought the entire stock of *Magnolia Soulangeana* from M. Soulange Bodin for 500 guineas, in consequence of which that fine tree will soon be



spread over the country. The collection of phloxes here amounts to 60 species and varieties, and of *Diánthus* to 40 species, one of which, the *D. Fischèri*, is highly odoriferous. A new hardy evergreen honeysuckle was pointed out to us, which, from its rapid growth, promises to be as valuable an addition to our ligneous twiners, as *Eccremocárpus scáber* is to our herbaceous climbers. Hardy orchideous plants are grown to an extraordinary degree of perfection, and also such rare bog genera, as *Pinguicula*, *Dionæa*, *Nepénthes*, &c. In small square enclosures, which they call sanctums and paradises, are many new things not to be shown to the uninitiated till they come into flower, and not to be sold till a number of plants have been propagated; and in several places are beds of green-house plants, to prove how far they will stand the winter. The bed of fuchsias made a very rich appearance, and Mr. Penny thinks that several species will be found hardy enough to stand our winters in a dry soil, and under the protection of a wall, or near a bush with very little protection.

We are very much gratified to find this nursery devoted in so marked a manner to herbaceous plants, believing this circumstance will further our plan of introducing every where Jussieuean flower-gardens. It will be a great point gained in spreading a knowledge and love of plants, to be able to exemplify almost every natural order by species that will grow in the open air in this country. At the end of our *Hórtus Británnicus*, we intend to state the number of orders that can be so illustrated, and as we think Messrs. Young will be able to illustrate more of these orders than any other nurserymen, we propose ascertaining from them and publishing the price for collections of different degrees of extent; and we shall suggest, probably in our next Number, a more complete and durable mode of naming private collections than has hitherto been done any where, founded, however, on Mr. Murray's invention (Vol. III. p. 29.), and Messrs. Loddiges' name-bricks.

In conclusion, we have to express our highest approbation of the liberality of Messrs. Young, whose collection is at all times open to gardeners and botanists of every description; and who most readily allow specimens to be gathered of every thing that can be spared for such as are forming herbariums. No nurseryman ever loses by this kind of liberality. As the London botanist who would study trees ought to spend two days a week in Messrs. Loddiges' arboretum at Hackney, so he who would acquire a knowledge of herbaceous plants should pass two other days a week in the herbaceous ground of the Epsom nursery.

The fruit-tree and timber-tree departments of this establishment, being at a little distance, we had not leisure to look into; but all that we saw in the home ground was in as good order, and as neat as the present wet season would permit. Mr. Penny is a most ardent and highly scientific botanist, and ranks as such with George Don and Mr. Sweet, with the prospective advantage of having his mind in a larger body than has either of these botanists. As a proof of the pleasure which we feel in seeing such a man in such a place, and of our personal esteem for him and his employers, we have sent him the First Volume of our *Mag. Nat. Hist.* and the *Encyc. of Plants*.

In consequence of the continued rains, a good deal of anxiety was very naturally expressed respecting the getting in of the harvest, and, as is usual, different plans have been suggested for drying corn in wet weather. Our readers have seen Mr. Vazie's plan, and his patent hedge stake. (p. 459.) Mr. Donald, of the Goldworth nursery, purposes to introduce Sylvester's air-stoves in the corn-barns throughout the country, at the expense, of course, of the landlord; and some writers in the provincial newspapers, we observe, suggest the Russian mode of kiln-drying, either in the straw or after being thrashed. There can be no doubt that the simplest mode of gaining knowledge on the subject of harvesting in a wet season, is to study the practice which prevails in countries or districts wetter or colder than

our own. The mode suggested by Vazie, with the exception of the hedge-stake, is resorted to in the wet districts both of Scotland and England; but when it is applied to the oat-crop, the ears of the hood or cap sheaf are kept uppermost, instead of the lower ends of the stalks; the latter presenting a broad surface to receive the rain, but the former a cone or tuft which is found to throw it off. In Sweden, where the climate is still more cold and moist than in Britain, and where, of course, evaporation goes on more slowly, the corn is spread out or suspended in small handfuls on frames (*Encyc. of Agr.* § 685.), by which the rain, when it falls, readily runs off, and the straw, when the weather is dry, is exposed on greater surfaces for evaporation. In that country the corn often remains so suspended till it is dried by the setting in of the winter's frost, and during this often long period it seldom or never germinates. This arises from the coldness of the atmosphere, and from this particular circumstance, that in the intervals between showers the air is not often so charged with moisture, or fog and damp, as in England and Ireland. It is important to mark this difference of climate, in order to account for the seemingly paradoxical fact, that the quantity of rain which falls during the harvest months is not always a proof that the harvest weather has been proportionately unfavourable.\*

The grand objects to be attended to in harvesting corn in a wet season are, to cut down only when the corn is dry, to dispose of it so as it may throw off the rains which may afterwards fall, and to tie it in small sheaves so as to preserve the largest evaporating surface. Small sheaves and shocks with hood-sheaves will suffice under all ordinary circumstances, and Mr. Vazie's mode, with small sheaves, in difficult cases. We cannot think it can

---

\* The following judicious remarks on this subject are from the *Scotsman*:—In some of the newspapers attempts have been made to trace a relation between the quantity of rain which falls in August, and the injury done to the harvest. "If in August 1828, when less than three inches of rain fell, the crop was considerably injured, how much more must it be injured in August 1829, when upwards of five inches of rain have fallen in less than twenty days! This mode of stating the question certainly has, at first sight, a very formidable appearance; but the damage done to the harvest is by no means in proportion to the *quantity* of rain that falls whilst it is in progress. The worst harvest during the last twenty years was undoubtedly that of the year 1816, and perhaps the best in the year 1822; and yet a greater *quantity* of rain fell in the harvest months of 1822 than in those of 1816. According to Hanson's Meteorological Chart, the rain in the months of August and September 1816, which entirely ruined the crop of that year, amounted to less than four inches; whilst in 1822 it amounted to five and a half inches. If the month of July in each year be added to the statement, the fall of rain in the three months in each year would stand thus:—

In July, August, and September, 1816,  $8\frac{1}{2}$  in.

In July, August, and September, 1822,  $15\frac{3}{4}$  in.

Yet the harvest of 1816 was the worst, and that of 1822 the best for many years past. The fact is, that it is not the *quantity* of rain, but its *continuance*, that is most detrimental to the harvest. A drizzling rain, that lasts a whole day without producing any sensible effect on the rain-gauge, will cause greater injury to the crops than a short and copious shower, though the latter may bring down ten times as much water as the former. The rain during the present month has generally fallen in heavy showers, which have been speedily followed by brisk drying winds; and hence the injury to the crops, so far as we have had an opportunity of observation, has been much smaller than might reasonably have been expected from its quantity.—(*Scotsman*, Aug. 26.)

ever be worth while in Britain to build stoves, or form any other erections for drying corn, because what would be gained to the farmer in a bad season, would be lost to him by the capital thus employed, which would be unproductive in good seasons. If an extraordinary exertion were to be made for drying the corn crop, a temporary structure of poles, to be covered and uncovered at pleasure, with rolls of canvass, in Mr. Forrest's manner (p. 510.), might be erected in a twenty-acre field, and the corn either placed in shocks under it, or spread in layers on hurdles, supported from the ground by other hurdles. But even this plan could never become general in a corn country, and we think it would be a folly to introduce any thing of the kind in Britain. The circumstance of such plans being thought requisite, in consequence of the wetness of our seasons, affords an additional argument in favour of free trade; in which case corn would only be grown in those countries where the climate was most favourable to all the operations connected with its production. Comparing one country of Europe with another, nothing can be more certain than that the British Islands, both in soil and climate, are formed by nature for the growth of the pasture grasses and herbage plants; and hence we have always said, that beef, mutton, and horses will one day be the staple produce of the country.

It is a common and well-meant remark of town's-people, that a bad harvest, by requiring more labour for getting in the crop, is better for the labourers; but in proportion as it is good for the labourers, it must be bad for the farmer and the consumer, and surely no good is worth much that is not good for the whole. With respect to the advantages which labourers now derive from the extra-labour required at harvest, we should not be surprised to see them reduced in a very few years, at least in the northern counties, to little or nothing, and the scythe and the sickle laid up in a corner, as well as the spinning-wheel and the flail. In Scotland, where men of large capital have embarked in agriculture, it will probably not be long before this result is realised. Various reaping machines have been produced from time to time during the last 15 years, and the approaches have been nearer and nearer towards perfection. In September, 1828, a reaping machine, invented by Mr. Peter Bell, was tried at Powrie, in the county of Forfar, before the member of parliament and the sheriff of the county, and forty landed proprietors and practical agriculturists, all of whom put their names to a declaration which is given in the *Quarterly Journal of Agriculture* for Nov. 1828. This declaration states, that the machine cut down a breadth of 5 ft. at once, was moved by a single horse, and attended by from six to eight persons to tie up the corn; and that the field was reaped by this force at the rate of an imperial acre per hour. The cost of the machine is 30*l.*, unquestionably too much for a small farmer; but if such machines were to come into general use, a class of men would arise who would hire them out to be worked, or probably work them themselves; and should this last mode become general, we have no doubt Finlayson's harrow (Vol. II. p. 250), and a portable threshing and winnowing machine, would be worked by the same persons. The declaration mentioned thus concludes:—"We consider it unnecessary to advert to the advantages attending the introduction of an efficient reaping machine, as these advantages are universally acknowledged; but we beg leave to express our conviction, that Mr. Bell's reaping machine will come immediately into general use; that it will confer a signal benefit on agriculture; that his invention is of national importance, and that he deserves the highest encouragement for his active and strenuous exertions for the public good."

Notwithstanding the very unfavourable weather, and disappointments at Dorking and various other places, we have not passed these fifteen days without instruction and gratification. The wheat crop appeared in general to be at least of the average quantity and quality; in some places, as between Godalming and Haslemere, and from the last place to Midhurst on

the one hand, and Petworth on the other, it was very bad; and, indeed, an extensive district in this part of Sussex is only fit for pasture and wood. We may safely say we saw no good agriculture, and only one field of turnips on raised ridglets. Nothing can prove more completely the general ignorance of the farmers of England than the slowness with which they admit improvements in their own profession. Compare them only for one moment with Scotch farmers in this respect, or with English manufacturers. The cause is clearly to be found in their general ignorance, which in all trades and professions is the grand obstacle to improvement. Enlighten a man generally, and he will soon bring his knowledge and reasoning powers to bear on the particular subjects of his pursuits, or on whatever concerns his personal interest. Let his knowledge be confined to one subject, and he will rest where he is, nor believe that there is more to be known. The superiority of the Northumbrian method of cultivating the turnip has for nearly fifty years been placed beyond all doubt among the reading farmers of Britain, and scarcely one can be found who cultivates that plant in the broad cast manner, north of York. Yet the practice seems unknown in Sussex; though, as we shall probably be told, there are some farmers there who grow the turnip in rows. The row culture, however, is quite a different process from the ridglet system, and one attended with comparatively few advantages. The only chance that we can see for improvement among the Sussex farmers, is through the education of the rising generation. But, indeed, how can a farmer, whether ignorant or enlightened, be expected to adopt improvements when he is struggling for existence? The low price of corn and wool, the increase of paupers and of poor rates, and executions for rent and for assessed taxes, were almost the only subjects that we heard talked of, either by farmers or tradesmen; and the influence of those evils we saw every where obvious, both on the landowners and their gardeners. Almost every farmer seems to be looking to the government, and hoping for relief through new restrictions on importation; but whoever holds out either to landlord or tenant any relief from the influence of government exercised in this way, in our opinion, takes but a very confined view of the subject. If restrictions on corn and wool could do any thing, it would be but a very momentary relief, to defer the crisis of the disease and render it more dreadful. With respect to wool, it is perfectly clear to us, from sources both public and private, that Australia will in a short time undersell not only England but all Europe in this article. It appears to us equally certain that, unless a free trade in corn and every thing else is opened, the manufacturing capital of this country will be carried to others, where it can be employed to greater advantage. No restriction can be imposed that will prevent this result; and, supposing it to take place, what then would the agriculturist call upon government to do? The landlord who has not mortgaged his estate, and the farmer who has no lease, has nothing to fear from a free trade in corn, because, as the price of food is, fundamentally, the price of every thing else, each will have the same command of labour then as now. The landlord deeply in debt, and the tenant with a long lease and an inexorable landlord, must unavoidably suffer sooner or later; but we question if even for these it would not be better to have the evil day over than to have the certainty of its future arrival hanging over them. "When things are at the worst they sometimes mend;" and with mortgages and existing leases got rid of, the national debt reduced, and a perfectly free trade in every thing, we have no doubt both landlords and tenants would thrive, in spite of the increasing population, for a long period. The great object is to effect the contemplated changes with the least quantum of evil to all parties; and however difficult it may appear to do any thing for possessors of deeply-mortgaged estates and of long rack-rent leases, yet it is practicable to save the agricultural and commercial world, by introducing free trade in every thing by

degrees. Every evil is lessened by being foreseen; and if every agriculturist, manufacturer, and commercial man knew that in 1840 trade would be perfectly free, commerce would be regulated accordingly.

It is in vain to think of continuing the prosperity of the country, if the national debt is not either paid off, or the interest of it paid by some other means than the assessed taxes. Government must unavoidably resort to a tax on real property, or to yearly loans, perhaps to both; and to a free trade things will certainly come sooner or later. A free trade, taken in connection with general peace and the extraordinary facilities of universal intercourse of the present day, cannot but lead to an extraordinary degree of prosperity in all countries. Australia will not undersell Europe and America in wool, without taking its value in commodities in return. When an article is produced, the producer will not then, as now, look to any one country for a market for his commodities. Every country will produce that which it finds it can produce cheapest and best, and commerce will do the rest. The climate and soil of England and Ireland is better adapted for the production of butcher-meat than those of any other country in Europe, not even excepting Holland and Denmark, where the winters are too severe for perennial grasses and the preservation of roots. We cannot help thinking, therefore, that the day is not very far distant when Britain will export fatted live bullocks to various parts of the Continent, and more especially to France. Suppose for a moment that butcher-meat was as generally consumed by the laborious classes on the Continent as it is in England, to what a consumption of fat bullocks would this not give rise? It is certain these bullocks would be fatted at less expense in England and Ireland than on the Continent, because grass grows in these countries all the year, and because the growth of grass and of monocotyledonous plants generally during summer is always greatest in a humid atmosphere. Here, then, is a permanent cause, that will always maintain the value of landed property in Britain on a high level: but, that it may rise to this level, trade, in the first place, must be free.

In the *Transactions of the Highland Society of Scotland*, vol. vii. published along with the *Quarterly Journal of Agriculture* for February 1828, is a description, accompanied with plans and sections of a steam-boat for conveying live stock, the cattle stalled so as they may be fed and watered, and the accommodation for 200 head of cattle, or 1560 sheep. How easy to convey these from any British sea-port to any part of the Continent, or even the Peninsula!

If it is distressing to witness the present state of the proprietors and farmers, it is still more so to hear the complaints of the common labourers. The want of employment is general throughout the country; it exists even about London, and the effects of the want of food are too obvious in the countenances of mothers and young children. We shall here mention a suggestion that we have just received from a correspondent at Sydney, whose letter will be found in another part of this Magazine. As is the case in every colony, the want of labourers at Sydney is felt as the greatest evil, and the supply of convicts is now out of all proportion to the increasing demand. R. S. suggests, therefore, that the English government should pass a law to render it legal for British subjects, merchants, captains of vessels, or others, to purchase the labour or life of individuals, with their consent, for a certain number of years, not exceeding, say seven, on condition of taking them to New South Wales, and reselling their interest in them there to persons in want of labourers. This is no doubt a species of temporary slavery; but R. S. thinks the law might be arranged in such a way as to render it a great blessing to the individuals, a great relief to many parishes in England, and a most acceptable supply for Australia. We have since mentioned the idea to a gentleman who has been several years in a public situation at Sydney, who has lately passed two years on the Conti-

ment, and who is now in London. He says the thing has already been done on a small scale by what are called redemptionists, i. e. labourers, who, before leaving England, agree to labour a sufficient length of time after their arrival at Sydney, to pay for their passage there, with interest, and the expense of insurance. If the plan, with some improvements, were rendered legal, he thinks it would be attended with immense advantages to both countries, and, above all, to the labourers themselves, who would eventually become proprietors. He is of opinion, that if government were only to pass a proper law on the subject, so as to protect all parties from injustice or cruelty, and to justify the overseers of parishes in forming contracts on behalf of such of their poor as might volunteer themselves as emigrants, that the exportation of labourers would go regularly on according to the demand, in the same way as the exportation of any other article. He is far from thinking it necessary for government to incur any expense in aid of emigration, because the interest of all parties would be sufficiently great to carry it on as a matter of business. We sincerely hope government may be induced to take the subject into serious consideration, and have no doubt of thousands being found who would sell themselves for seven years, for the certainty of independence and plenty afterwards. As to the pain of leaving one's native country, it is but very trifling, when in that country a man can no longer obtain a sufficiency of daily bread; and, indeed, as a general principle, in an age like the present, when every man is a citizen of the world, wherever a man's family and his property is, there will be his heart, his happiness, and his country.

Perhaps we shall be told that these matters are foreign to the *Gardener's Magazine*; but this we deny, for though they are not horticultural, they are still intimately connected with the prosperity of gardeners and gardening, and with rural and domestic improvement. It is our duty to open up to young gardeners what we conceive to be correct views on all these subjects, because the prosperity or adversity of the whole of a country involves the prosperity or adversity of every part of it. Should government continue the same system of taxation and restriction, many of the landed proprietors will soon be ruined. Gardeners and the *Gardener's Magazine* will be among the first to feel the effects of this, and it is proper that they and we should know this in time. It is a grand moral error to suppose that every man ought to rest content with a knowledge of his own trade or profession, leave every other to follow his, and the government of the country to its administrators. This is a very convenient doctrine under absolute governments; but it is unsuitable to the present age, and especially to the state of society in England, where scarcely any man can be said to be eminent in any art or profession, without having just, or at least enlightened, views on every other subject, and especially on those most important of all subjects, morals and politics. It is the first duty of every man to acquire the art of labouring at something by which he may, at all events, gain his daily bread, support a family, and, if possible, acquire independence in the country in which he lives; but, having fitted himself for living in society, it is his next duty to ascertain the place he occupies there, the rights to which he is entitled as a man and a citizen, and the power he has of maintaining these rights. If he and others neglect this, such indifference will soon be turned to account by the natural cupidity of aspiring individuals.

A man, whether he be a labourer, an artist, or a man of science, whatever may be his talents or his industry, provided he knows nothing more than the subject of his pursuits, is only the better fitted to become a slave to superior power. Let every gardener and farmer, therefore, look around him, hear different opinions on all subjects, especially on those important ones, morals and politics, and endeavour to select the best in these sciences, no less than in his profession. In a reading age like the present, it is only by the operation of this principle among the most intelligent part of a com-

munity that good government can either be formed or maintained. Every day shows more and more the influence of general opinion on modern governments, as promulgated through the daily and periodical press; and hence the great importance to the government and the landed interest of the country of enlightening those who cannot enlighten themselves, in order that their power may not be turned *en masse* against them by a revolutionary or party spirit of any kind; and to the poor and ignorant themselves, that they may the better be able to understand and maintain their natural and political rights. Having given this advice, it may be asked what books we would recommend to young gardeners and farmers, from which to acquire that degree of knowledge in morals and politics that every man ought to possess; and as the subject must always be considered secondary to professional reading, we shall content ourselves for the present with recommending the most prominent reviews and newspapers. Those newspapers whose knowledge of political economy we consider the most sound are the *Scotsman*, the *Morning Chronicle*, the *Examiner*, and the *Globe*; but there may be others, and especially country newspapers, equally scientific in their general views. We regret that the *Farmer's Journal*, a newspaper read every where by the farmers, and containing many valuable agricultural communications, should pursue a line of politics, which, as far as it has any effect, can only encourage false hopes in farmers. Were that extensively-circulated paper to take a different line of argument, we cannot help thinking it would render the farmers a much greater service than by encouraging their outcry against free trade.

---

#### ART. V. *The Improvements at Windsor Castle.*

HAVING from time to time heard of the orangery and flower-garden formed by the king, a pompous and fanciful account of them, and of the grounds at Virginia water, which appeared in the *Morning Chronicle* of May 21., determined us to go to Windsor soon afterwards. The new flower-garden forming there, of which we present a general outline from memory (*fig. 150.*), occupies between three and four acres, which are enclosed from the park on the east side of the grand terrace. This garden is surrounded by a new terrace (*aa*) on the same level as the old ones (*ef*), and the arena of the garden being 12 or 15 ft. below the level of the terraces, the descent to it is by two staircases (*bc*). The orangery is formed under a part of the terrace (*da*), and is lighted by upright windows in the manner of the old orangeries at Kensington and Versailles, facing the south and south-west. It follows from this arrangement that walking on the terrace all round the flower-garden, the eye looks down on its arena of grass and beds of shrubs and flowers on the one hand, and outwards on the exterior park scenery on the other: the effect thus produced is dignified and grand and altogether suited to the castle and the situation. When we have stated this, however, we have, we think, stated all that can be said, either in favour of the orangery or the garden.

The first grand deformity which strikes the eye of a stranger when looking down on the flower-garden towards the orangery from the old terrace (*de*) is, that this building has been a second thought, the ground being excavated in front of it, in the manner of a sunk fence (*fig. 150. gh*). The surface has no doubt been lowered in this awkward form in order to obtain a sufficient height for the orangery; but by spoiling the symmetry of the flower-garden it greatly injures its effect, and destroys in our minds all

idea of a perfect whole. We have no doubt there may be persons who would hardly venture to question the beauty and propriety of any thing in the garden of a king; but we hardly think there can be a single individual who, if he saw an orangery so situated in the garden of a private gentleman, would not consider it as deforming the scene to which it belongs. A farmer

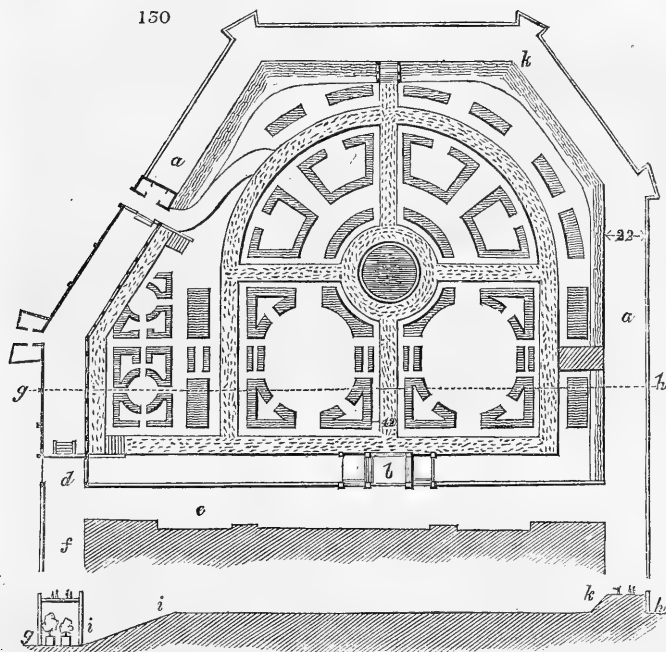

would call it an orangery at the bottom of a ditch, and a gardener in describing it would say that it formed the wall of a ha-ha. If the true history of its formation could be known, we have little doubt it would turn out to be an afterthought, and like most afterthoughts it remains a blemish on the original design. The deformity would have been less had there been a level plot of 50 or 60 yds. in breadth in front; but the slope coming abruptly down to the upright glass, makes the very worst of a bad idea. Let any reader imagine such a bank raised in front of the orangery windows at Versailles, and then say what would be the effect. The diminution of reflected light by such a bank is demonstrable; but that is comparatively not worth enquiring about.

This ha-ha orangery appeared to us to be about 300 ft. long, 18 or 20 wide, and 25 or 30 high; the roof is of flag-stones, laid on cast-iron rafters; the stones are covered with lead to prevent the rain from penetrating, and this with clay and the gravel of the terrace. The grass slope (*fig. 150. ii*) may be about 100 ft. long, and the rise about 15 ft.; but these dimensions are entirely guesswork, and being made from memory, after a very hurried glance, are probably far from the truth. Their inaccuracy, however, will not affect our argument. The defects of the level part of the flower-garden, unlike those of the orangery and the ha-ha part of the garden, are remarkable. The greater part of the level surface of the garden is in grass, with beds of shrubs and flowers parallel to the walks. The objection that



we have to the whole is, a general meagreness of effect both in the number and forms of the beds, and in the disposition of the trees and plants. There is a slope of turf from the inner edge of the terrace (*fig. 150. k k*) to the level arena of the garden, which is without beds or plants, and without even an architectural margin at the upper angle. The beds in the arena are altogether too simple, or rather poor in their outlines for the architecture of the castle; some of them are raised panels in imitation of the raised beds at the Tuileries and the Luxembourg; but the effect of those at Windsor is insipid from their not being sufficiently raised and relieved from the general surface. The justice of this criticism may be deduced from the principle which ought to guide the architect or gardener in the choice of forms for a geometrical flower-garden near a house or other building. All writers, including Sir Uvedale Price, Mr. Hope (*Essay on Gardens in the Artist*), Mr. Meason, and our correspondent An Amateur (Vol. IV. p. 85.), agree that these forms ought to be taken from the building; and therefore it may be asked, whether any one looking at the east front of Windsor Castle, and especially at that part of it containing the 400 rooms used as the king's private apartments (these alone, as we were informed, being finished externally), and then, looking down to the flower-garden, could discover any connection of the latter with the former? The answer to this question will determine the beauty of the garden on this principle. But, perhaps, it will be said that the architectural principle was not adopted. In that case it is to be criticised by a comparison with other gardens in the geometrical style; and whoever has seen either the remains of parterres still existing in France, or the plans of them in Le Blond or Switzer, or the plan of Marshal Tollard's garden at Nottingham, which they will find in our succeeding Number, will allow that they are not less deficient when tried by this test. Whoever laid them out, and we could not learn whether it was Sir Jeffery Wyatville or Mr. Aiton, must furnish us with some other principle by which to try the work: we know of no other; and when the works of an artist have failed in carrying off our applause, it is but justice to him to enquire into his intentions, in order to discover whether the fault may not lie with ourselves.

The planting of the beds we pronounce with confidence to be as far behind the present state of science in this branch of gardening, as the plan is deficient in those of design and taste. The artist can take no shelter under historical associations, because he has introduced American shrubs, and Mexican and Peruvian flowers, and therefore it may fairly be presumed, that if he did not mean to give all the beauty he could in the forms of the beds, he intended to produce every practicable beauty in planting them. If he did so, his ignorance, or his indifference, is not a little remarkable. The beds are filled with an indiscriminate mixture of rhododendrons, azaleas, kalmias, and other evergreen American shrubs, with lilacs and some of the commoner deciduous sorts, but with some few beds planted with standard roses and flowers. With the exception of the distinct features of the standard roses and the flowers, there is not the slightest indication of design. Such a garden properly planted would have had a very different appearance, and so far from presenting a general aspect of mixture and confusion, every part of it, and all the kinds of trees and shrubs, would have appeared so exactly fitted to their place, that it could not be removed without presenting a deficiency, or occasioning a derangement. Considering the modern catalogue of choice shrubs, their disposition in this way is not to be undertaken without a good deal of previous care and labour in arranging the sorts on a plan; but the labour taken, and the plan executed, the effect will amply repay. But it is not in a royal garden, which is only one of half a dozen under the same gardener's direction, that this description of planting is to be expected. We could not observe a single shrub in flower, though a few days afterwards we saw at least a dozen

species in blossom in the London nurseries. A judicious planter of such a garden would have had shrubs in flower every month in the year. A mass of the hardy heaths alone would have produced this. What a fine effect a compartment of *Althæa frutex* would have had at this moment! (Sep. 7. 1829.)

To the exterior of the architecture of the palace we cheerfully yield our unreserved admiration: on whatever side we view it, we feel it to be a whole; and that every part is of the same kind, and contributes to one kind of expression. This expression is every where sufficiently powerful to prevent its absence for a moment from the spectator's mind. This is what cannot be said of Buckingham palace, which, on the north side, might be mistaken for a part of a street, and after having passed the east side and imagined it to be the grand entrance, we come to the south side, and are puzzled by a semicircular colonnade, an evident afterthought, which seems to be another entrance; and yet, both in proportions and in style, the second entrance seems to have no connection or harmony with the front which it is placed against. However the architect of Windsor may have failed in the garden, no one will question his success with the exterior of the building. Every one must feel also the suitableness of the main entrance to such a castle directly at the grand avenue. — *Cond.*

---

#### ART. VI. *Retrospective Criticism.*

*FOWLER'S Thermosiphon.* — Sir, In your Magazine for August (p. 453.), I have read the notice of Mr. Fowler's thermosiphon. In the year 1812, when in Philadelphia, I had the pleasure of being introduced to a gentleman, one of the Society of Friends, who showed me his plan for a warm bath, in a room situated over the kitchen; the water was conveyed to it from the kitchen fireplace, on a principle, as nearly as I can recollect, similar, if not the same, to that mentioned in Mr. Fowler's pamphlet. I have frequently mentioned this method of procuring warm baths in our dwelling-houses, as both easy and unexpensive, and as a thing much wanted, whether regarded in a medical point of view, or as adding to domestic comfort. I am glad it has been made public, having long contemplated giving it publicity.

*Brown's Gas Engine.* — I beg to add, that, in the same year, 1812, the Rev. Dr. Allison, a resident in Philadelphia, suggested to me the practicability of using *gas* instead of *steam* for engines. You will, I doubt not, allow this communication a place in your useful publication, of which I have the happiness to be a constant reader, and remain, yours, &c. — *William Johns, M.D. F.L.S. Aug. 1829.*

*The Anson or Otaheite Pine.* — Sir, I beg leave to trouble you once again respecting the Anson or Otaheite Pine, as I observe a Mr. C. F. Webster has written a very ingenious letter respecting that pine in the last Number of your Magazine (p. 466.), and which is only calculated to mislead the public; but it is to be hoped that truth and justice will always overcome caprice and falsehood. Since my last letter respecting that pine appeared, in No. XIX. of the Gardener's Magazine, in pages 231. and 232., I have found such evidence, that there cannot be the least doubt but that that pine was first cultivated at Shugborough. I am now authorised to state from Mr. Dermott, who is at present living as gardener at Tixall Hall, that he very well remembers the pine in question growing and fruiting in the most luxuriant state at Shugborough in the year 1795. At the first sight it struck Mr. Dermott very forcibly that it was a distinct variety; and, on enquiring of Mr. Tyley (who was then gardener to Thomas Anson, Esq., of

Shugborough) what pine it was, he was informed that it was a seedling pine raised by Mr. Allen, a former gardener there, and who received from his employer the seed, which had been imported from the West Indies. Now, to convince Mr. C. F. Webster, who seems so very sanguine about the origin of this pine, as Fazeley is but a very few miles from hence, and as several coaches run through that place daily, and pass within a quarter of a mile of Shugborough, I shall be most happy to see Mr. C. F. Webster, and to introduce him to Mr. Dermott, who lives only two short miles from this place, whom he will find as respectable and intelligent a man as any in the profession, and who grows the Anson or Otaheite pine in abundance. Mr. Dermott will be happy to give him some other particulars respecting this pine, which I have not here mentioned. I also beg to state, that I saw Mr. Hodson a few days ago, who expressed himself much surprised and indignant at the manner in which Mr. C. F. Webster had written concerning that pine. Mr. Hodson assured me that those imported pine plants (which Mr. C. F. Webster chooses to write about) did not fruit while they were under his care at Colton, viz. from 1797 to 1810: he therefore positively denies ever saying that the pine in question was produced from those imported plants. Now, from what has been said before upon this subject, it is very apparent that this pine has lost the original name (the Anson pine) since 1810, which was the year that Mr. Nicol (then gardener at Shugborough) left his situation. Ever since Mr. Nicol gave me the information relating to it (as I stated in my last letter), I have considered the Otaheite an erroneous name given to that pine, but could not prove that it was so until within these few weeks, when Mr. Dermott gave me so correct a statement, and produced such facts respecting that pine, that there cannot be now a doubt remaining but that it is the Anson pine, and I shall adopt that name in future. I am very sorry to trespass on your time with the present article, but as it may be satisfactory to some of your correspondents, I hope you will give it insertion, and I promise not to trouble you any more upon this subject. I remain, Sir, &c. — *W. M' Murtrie. Shugborough, August 15. 1829.*

*Mr. Knight's Experiments on the Potato.* — With reference to Mr. Knight's experiments on the culture of the potato, there is not well-authenticated accounts of more than 400 bushels of potatoes having been produced per acre, in the ordinary course of farm management in East Lothian. The value of an experiment depends upon the process by which the result has been obtained, and the worth of Mr. Knight's is rendered doubtful, not merely by the want of particulars relating to the extent of surface from which the result was attained, but by circumstances which he has mentioned connected with the experiment. Could not a spot have been found undamaged by "rabbits" and "pheasants," and how was the allowance of 2 lb. of earth in every bushel ascertained? Mr. Knight's personal character may probably stamp a value on the experiment, but if he did not superintend every operation connected with it, the character of others must be taken into account, and the assumption of 2 lb. as the weight of earth adhering to each bushel of potatoes is so unphilosophical a step, as to throw discredit on the whole experiment. Mr. Knight's mode of culture scarcely differs from that adopted by the late Mr. Curwen of Workington, in 1816, whose produce in that year, over an extent of  $41\frac{1}{2}$  acres, was stated in the *Farmers' Journal*, by Mr. Sibson, to average 498 bushels; but Mr. Curwen's, like that which is the subject of remark, does not seem to have been accurately ascertained. Viewing such crops as partaking of the marvellous, yet, in this respect, they yield to one obtained by Mr. Prentice, Covington Mains, Lanarkshire, from newly reclaimed moss, which amounted to 591 bushels. — *An East Lothian Correspondent. Aug. 1829.*

ART. VII. *Queries and Answers.*

*POSSIBILITY of enlarging the size, and hastening the maturity of Fruit.* — Sir, As a proof of the possibility of materially enlarging the size and hastening the maturity of fruit, I send you two peaches (*figs.* 131, 132.), just

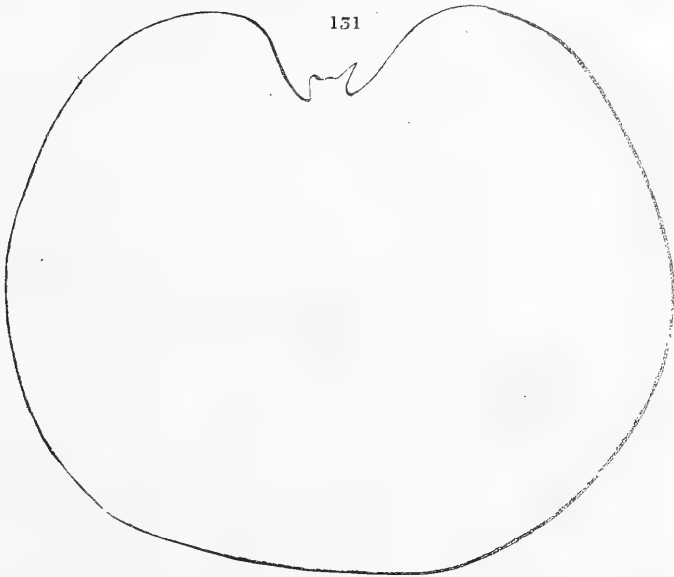

plucked from separate branches of the same tree, each the largest, but not materially so, on its respective branch; the smallest peach being the usual state of the fruit at this season. The tree is a Royal George, received from Messrs. Ronalds, and has always been one of the latest to ripen its fruit; but this year the fruit on one branch is ripening the earliest in my garden, whilst that on the other, I have no doubt, will be the latest. The early fruit is also nearly double the size of that hitherto produced on the same tree. The cause of this great change is accidental, but arises, I suppose, from the loss of the bark on the lower part of the branch: of this, however, you will be the best judge, when I relate the circumstances attending it. In consequence of an injury in the stock, received, I believe, in the carriage from the nursery, one of its three main branches, an outer one, died last summer from canker. In the spring I therefore pulled down the middle branch from its upright position, and nailed it nearly horizontally (which, perhaps, might also produce some effect on the fruit), elevating, at the same time, the remaining branch, so that the tree might again assume a shape adapted to fill its allotted space on the wall. The canker having also af-

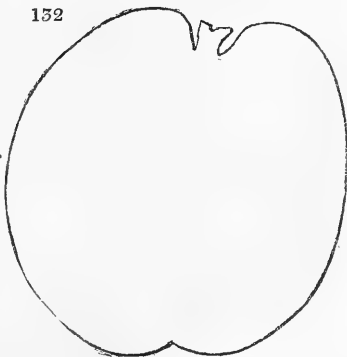

fecting the middle branch, I cut out the diseased part, and in doing so, separated the bark all round the branch, applying the usual composition.

These are, I believe, the only circumstances which could have caused any change in the fruit, respecting which, however, I shall be glad to know your opinion. I am, Sir, &c. — *William Halcomb. Poulton House, Marlborough. Sept. 2. 1829.*

The accident of losing the bark seems to have produced the same effect as ringing, and to have given the large proper-sized early fruit; the want of nourishment in the depressed branch the small ill-shaped late one. — *Cond.*

*Wilmot's Superb Strawberry.* — Sir. I have had several strawberries from two or three plants of Wilmot's Superb, of great size and weight; I, at least, have never met with any to equal them. The smallest of those which I have particularly noticed, measured  $4\frac{1}{2}$  in. in circumference, and weighed upwards of  $\frac{1}{2}$  oz. troy weight; another measured 6 in. round and 4 in. across, and weighed 5 dr. 1 sc. 6 gr.; and the one which I have gathered to-day weighs 7 dr. 15 gr. It is, indeed, a beautiful specimen, and I only wish I could preserve it to look as it does now. Pray are these beautiful, though almost monstrous, productions common? or are they the result of something favourable in the season, which, though not dry, has certainly not been inimical either to flowers or fruit here? and I must mention in particular, that I have had several perfectly beautiful and well opening yellow roses, an indulgence I never had until this year; for though former seasons have held out abundant promises, they have never until now been fulfilled. — *J. M. White Leaf, near Risborough, July 6. 1829.*

Wilmot's Superb, in common with most other strawberries, has attained a larger size this season than usual, for the reasons assigned by our correspondent. We have heard of none larger than his largest, unless it be that alluded to in the following extract from the *Coventry Mercury* (July 5.): — "Amongst the strawberries exhibited at Hereford Horticultural Show, on Friday, was a plate of Wilmot's Superb, one of which measured 7 in. in circumference, and weighed  $1\frac{1}{2}$  oz. avoirdupois." — *Cond.*

We have seen an outline of a Wilmot's Superb, exhibited at the Bristol Horticultural Society (p. 622.), which measured 2 in. across, and in looking over the article Provincial Societies, some other large ones will be found noticed. — *Cond.*

*The Wire Worm in Gardens.* — Sir, Will you, or any of your correspondents, have the kindness to inform me if there is any effectual remedy for the wire worm? as our garden is so much infested with it, that it is with the greatest difficulty we can bring any of the Brassica tribe to perfection. If you will insert this query, or give me an answer through the medium of your valuable Magazine, you will greatly oblige — *A Subscriber and Well-wisher. Wiltshire, July 10. 1829.*

Our correspondent may refer to Vol. IV. p. 191. and p. 317., where the experience of four persons, and their success in the destruction of this pest, are given. — *Cond.*

*Insects on an Oak Coppice.* — On a tour into Wales in the last month, I observed, in the mountains beyond Machynlleth, an immense number of flying insects, about the size of the moth which so frequently destroys clothes by eating small holes in them; but this insect had pale-green wings. These insects had laid complete siege to a fine coppice of natural oak, and had almost stripped the whole of the leaves off. They did not appear to have eaten any other than the oak leaves. Perhaps some of your numerous correspondents would favour the public with the cause of the insects attacking the oak, and state some method to get rid of them, or a method to prevent their multiplying. I never saw the like before, and was very much astonished at the sight of the coppice, as it appeared to be all alive, and would, I feel persuaded, suffer very considerably from the depredations

committed by this little creature. I am, Sir, &c. — *John Owen. Oswestry, July 16. 1829.*

*Hybrids between Sinapis arvensis and Brassica Napus.* — Will either of the varieties of charlock, or wild mustard, blossoming at the same time with, and contiguous to, turnip, produce hybrid seeds? — *P. S. East Lothian. Aug. 22. 1829.*

*The Navet, or French Turnip, and Cape Broccoli.* — Will any of your correspondents inform me of the time of sowing these plants, in a very wet cold soil? — *A young Beginner. Arundel, April 22.*

*The Russian Violet.* — Is there such a plant as the Russian Violet? I do not see it mentioned in Sweet's *Hort. Brit.* If there is, what is the time of flowering, what the colour of the flower, where can it be purchased, and at what price? I am, Sir, &c. — *F. R——d.*

*Bees.* — I would beg to suggest that there is a subject of rural economy that is not altogether unconnected with gardening, which you have never touched upon; it is the cultivation, improvement, and management of the honey bee. I dare say many of your readers have apiaries, and at times could point out various improvements in their culture, accompanied by observations on the best mode of obtaining the greatest profit from their labour. I should like to know if any society exists which offers premiums for keeping the greatest number of stocks, or any thing else connected with the subject, what their rules are, and where they are to be obtained? If you think this suggestion not unworthy of your attention, the noticing of it in your next Number will confer an obligation, and perhaps I may trouble you at a future period with a few hints respecting these interesting insects. I am, Sir, yours, &c. — *G. A. E. Chichester, May 29. 1828.*

*Irideæ.* — Sir, A species of *Iris* was some years ago found growing wild at Lochnawe, in Wigtonshire, as I am informed. Having received a plant last year from Messrs. Dickson, nurserymen, Leith Walk, I was surprised to find that it proves to be the *Iris Pseudacorus* var. *pallido-flava* of Curtis's *Botanical Magazine*, vol. xlviii. pl. 2239. and is there said to have been imported from Carolina by Mr. Lyons. Can you refer me to any book containing the description or figure of *Iris Monnièræ*? — *David Falconar. Carlourie, near Edinburgh, July 20. 1829.*

### ART. VIII. Horticultural Society and Garden.

AUGUST 4. 1829. — *Read.* Measurement of an American Aloe now in progress of blowing at Castle Freke, Ireland; by Lord Carberry, F.H.S.

*Exhibited.* *Banksia serrata*, from Mrs. Leader's garden, at Putney, brought by Mr. Gibbs, the gardener. Carnations, from Messrs. Osborn and Willmer of Sunbury; these were very handsome flowers. Fourteen sorts of Apples, a branch bearing fruit of the Summer Portugal Pear, and a branch bearing fruit of the Green Chisel Pear, from Mr. Hugh Ronalds, F.H.S. Black Prince, and Black Hamburg Grapes, and a Green Pine-Apple, from Mr. Charles Spring, C.M.H.S. A Seedling Grape raised from the Black Damascus, by Mr. Benjamin Fielder, gardener to William Linwood, Esq. F.H.S. A specimen of Flanagan's Cucumber, from Mr. Patrick Flanagan, F.H.S.

*Also, from the Garden of the Society.* Fruits: A Melon, from the Crimea; Cantaloup gros noir de Hollande, *Psidium Cattleianum*, four sorts of Pears, four sorts of Apples, seven sorts of Cherries, Otaheite Pine-apple. — Flowers: *Lobelia Tupa*, *Coreopsis Atkinsoniæ*, *Eccremocarpus scaber*, *Potentilla nepalensis*, *Rosa Champneyana*, Double Georginas, Anemone-flowered Georginas,

Brown's Mule Pink, French Marigolds, Double ten-week Stocks, *Verbena pulchella*, *Aublètia* and *Melindres*; *Eschscholtzia californica*, *Ceanothera quadrivulnera*, *viminea*, *Lindleyana*, and *decumbens*; *Trachymene cærulea*, *Lupinus plumosus*, *polyphyllus*, and *ornatus*; *Gilia pulchella*, *Clarkia pulchella*, *Galardia aristata*, *Chelone nemorosa*, *Mimulus moschatus*, *Pentstemon Richardsoni*, *campanulatum*, *atropurpureum*, and *Hollyhocks*.

August 18. — *Read*. On acclimatising Plants; by William Pyle Taunton, Esq. F.H.S. History and Description of the Varieties of *Camellia japonica* that have been imported from China; by Mr. William Beattie Booth, A.L.S.

*Exhibited*. A Hoe, invented by Mr. Lea of Warley, near Halifax, communicated by the Rev. John Armitage Rhodes. This was a contrivance by means of which the blade of the hoe could be unscrewed from the shank, and taken off to grind; it had also the advantage that one handle would answer for several hoes, and the necessity of taking off and resetting the hoe in its handle every time it was ground was obviated. Seedling and Dwarf Dahlias, Seedling Noisette Rose, and Hamburg and Frankendahl Grapes, from William Wells, Esq. F.H.S. Seedling Dahlias, from Mr. Renné Langelier, gardener to William Hervey, Esq. F.H.S., of Acton. *Magnolia grandiflora*, and five sorts of Apples, from Mr. Joseph Kirk, F.H.S. Bellegarde and Millets, Mignonne Peaches, five sorts of Melons, Elruge Nectarines, and Black Hamburg Grapes, from Mr. Henry Bailey, F.H.S. Moor Park Apricots, from Mr. John George Fuller, F.H.S. Ten sorts of Apples, from Mr. Thomas Gibbs, F.H.S. Green-fleshed Melon, from Mr. Thomas Bailey.

*Also, from the Garden of the Society*. Fruit: *Ribes aureum præcox*, *sanguineum*, and *tenuiflorum*; *Gaultheria Shallon*, nine sorts of Pears, twelve sorts of Apples, Late Duke Cherry, Red August Siberian Crab, *Prunus dasycarpa*, and Melon of Nukschevan. Flowers: *Chrysanthemum monspeliense*, *Combrètum purpureum*, *Eccremocarpus scaber*, *Donia villosa*, *Verbena Melindres*, *pulchella*, and *Aublètia*; *Trachymene cærulea*, *Eschscholtzia californica*, *Anthemis arabica*, *Ceanothera viminea*, *Lindleyana*, *decumbens*, *quadrivulnera*, *pallida*, and a new species; *Galardia aristata*, *Gilia pulchella*, *Hibiscus africanus*, *Coreopsis tinctoria*, *lanceolata*, *diversifolia*, and *Atkinsonii*; *Pentstemon ovatum* and *Richardsoni*, *Clarkia pulchella*, *Agératum mexicanum*, Double Stocks, Mule Pink, Double China Asters, *Senecio elegans*, Double French Marigold, Double Georginas, French Marigolds, and *Heliánthus lenticularis*.

---

#### ART. IX. *The London Nurseries.*

A NEW seedling variety of *Gœum chiloense*, first observed at Messrs. Whitley, Brames, and Milne's, proves to be more general, and in some places to be found exclusively, the original species being smaller-flowered, and not even known to some cultivators, who have the former and wish to obtain the latter. Some difficulty appears to prevail as to the origin of this plant, but as it is the only variety known about Edinburgh, I have little doubt of its having been obtained there from seeds received by Mr. M'Nab from some of his numerous correspondents. That most beautiful plant, *Verbena chamaedryfolia* [*Melindris* Bot. Reg.] figured in Sweet's *Flower-Garden*, No. 5. new series, from its ready method of increase, promises to become a permanent ornament of our conservatories, as it may be cultivated to bloom at all seasons. I have little doubt in time it will prove half-hardy, and only require a slight protection in winter. A new *Alstrœmèria* (*psittacina*), one of the most showy of that beautiful genus, also figured by Mr. Sweet, from Mr. Barclay's prolific collection, and said to be hardy, as is the case with A.

*hirtella* and *Simsii*, promises to enrich our flower borders for the enjoyment of all our cultivators. It is with regret that I have heard from time to time some of our best and most extensive nurserymen observe, that any particularly handsome plant is too free to increase either by seeds or cuttings, that it will soon be common; this evinces too much of the selfishness of commerce, to the exclusion of the more liberal feeling of science, which should rejoice in the ready facilities of communicating gratification to others, rather than the paltry feeling of self-interest. Besides, I think the principle of this feeling may be fairly disputed, inasmuch as the increased distribution of any thing by its cheapness, will amply compensate by the increased demand for it.

The new varieties of *Dahlias*, now rightly called in our botanical works *Georginas*, serve to enrich the gardens with every variety of the most splendid colours, and by their increased distribution have certainly created a more extensive demand for them. The most conspicuous as novelties are the Irish anemone-flowered; and, from their peculiarity of appearance so different from any hitherto observed, I am almost at a loss to conjecture by what means of culture they have been obtained, perhaps you may possess the secret. A great variety of almost every shade of colour are daily to be observed in the extensive collection of Messrs. Dennis, at Chelsea, as well as in those of many other nurserymen and private gardeners in the neighbourhood of London; nor are they confined to these, but appear to exist in equally splendid profusion throughout the country. A beautiful new shrub, *Fuchsia microphylla*, covered with a profusion of bright scarlet, is now in full bloom at Mr. Mackay's, at Clapton, as well as at Messrs. Young's of Epsom. *Cyclamen europæum* (true) is now in full bloom at Mr. Knight's, in the King's Road, its very delightful and delicate fragrance enhancing its value to all the admirers of that beautiful genus. *Cyclamen repandum* has bloomed beautifully with Messrs. Dennis during the summer, and is well worth the attention of all cultivators. These, with *colum*, *vernum*, *hederifolium*, and *persicum*, may be kept blooming in almost constant succession throughout the year. Our gardens are now enriched with many new splendid species of *Lupinus* and *Pentstemon*, from the exertions of Mr. Douglas, during his journey over a part of the north-west territories of America; and it is only to be lamented that so rich a collection did not pass immediately (like those of the late Mr. Lyons, Mr. Frazer, and Mr. Bradbury) to the public, instead of being so closely confined to the Horticultural Society's garden, from which they are only distributed very sparingly, and I believe in very many instances with more of partiality than justice. — In my last you have printed the word hybrid, high-bred, which is a most unscientific mistake. — *G. C. Sept. 9, 1829.*

*In Waterton's Nursery at Knap Hill, near Woking*, was one of the most splendid displays of azaleas ever seen in England, in the first week of June last. Mr. Waterton has raised many hundreds of hybrid seedlings, and has, besides, all the best old varieties, and many of the new sorts raised by others. Mr. Waterton has lately purchased the premises and stock of the late Mr. John Taylor of Bagshot, and has thus greatly extended his resources. — *J. W. B. June, 1829.*

*Epsom Nursery.* — New or rare plants which have flowered during the months of July and August: —

*Malcomia* (R. Br.) *arenaria Dec.* Apparently suffruticose; stem ascending much branched, 12 to 18 in. in height, with lanceolate dentate leaves and lilac flowers. Frame; propagated by cuttings and seeds.

*Helianthemum* (*Tourn.*) *glutinatum Pers.* Sweet's *Cistinea*, t. 83. Stem ascending, much branched, branches clothed with villose hairs, glutinose. Leaves lanceolately linear, with sub-racemose small yellow flowers. Frame. — *H. glaucum Pers.* A small upright bushy shrub, with roundish or elliptic oblong glaucous leaves, and yellow flowers. It is hoped, that samples of this interesting species will be transmitted to Mr. Sweet, previously to the close of his indispensable *Cistinea*.



*Dianthus* (*L.*) *pubescens* *Sib. et Sm.* Sweet's B. F. G. ined. An erect much-branched plant, densely clothed with a viscous pubescence, with linear awl-shaped leaves, and intense rose-coloured flowers elegantly spotted with white. Cuttings and seeds; perennial; frame in winter. — *D. erubescens* *Trev.* — *D. monspessulanus* *L.* Stem paniced, few-flowered; flowers solitary, with serrulated linear leaves and digitately fimbriated lilac flowers. Hardy, and admirably adapted for rockwork. — *D. Fischèri* *Spreng.* Sweet's B. F. G. t. 245. Stem 18 in. in height, paniced, leaves lanceolate, flowers aggregate, of a beautiful purplish lilac, delightfully fragrant. Perennial; frame; propagated by cuttings and seeds, which are occasionally produced.

*Silène* (*L.*) *regia* *Sims.* Bot. Mag. t. 1724. Stems erect, 3 to 4 ft. high, clothed with a viscous pubescence, with lanceolate leaves, and paniced splendid scarlet flowers. Decandolle considers it a doubtful perennial, and in other works it is considered a green-house biennial; but it is evidently a perennial, and perfectly hardy. It is successfully cultivated in peat soil, and propagated by very young cuttings in spring.

*Althæa* (*Cav.*) *Frolòwii* *Penny* in Hort. Eps. Addenda, p. 51. No. 3845.

*Lavatera* (*L.*) *maritima* *Gouan.* A handsome evergreen shrub, 6 or 8 ft. in height, with tomentose roundish obtusely angular leaves, and axillary pearl-white flowers, purple at the base. Requiring the protection of a mat in winter; propagated by cuttings and seeds.

*Pelargonium* (*L. Herit.*) *melancholicum* *Penny.* Sweet's Ger. sec. s. t. 55. *mirabile* *Penny.* Sweet's Ger. sec. s. t. 57. (*Donna Maria*, of the gardens about London.)

*Oxalis* (*Lin.*) *floribunda* *Lehm.* Bulb solid, leaves shorter than the scapes, leaflets obcordate, scapes numerous, terminated with twelve to twenty elegant rose-coloured flowers. This admirable species should be planted in a border of rich soil, in May, where it produces a profusion of flowers until October. Requires protection in winter; propagated by seeds. The *O. floribunda* of *Lindl. Bot. Reg. t. 1123.* and of *Hooker's Bot. Mag. t. 2850.* is a very different species.

*Dorýcnium* (*Tourn.*) *réctum* *Ser.* Suffruticose, with small rose-coloured flowers.

*Galèga* (*Tourn.*) *pérsica* *Pers.* Sweet's B. F. G. t. 244. A hardy perennial, with white flowers from May until October. Division and seeds.

*Lupinus* (*Tourn.*) *mexicánus* *Cerv.* Bot. Reg. t. 457. An extremely rare biennial species. — *L. versicolor* *Sweet.* B. F. G. t. 12. A handsome upright branching shrub, with numerous racemes of small flowers elegantly variegated with blue and light purple; the lanceolate bractæ fall before the expansions of the flowers. Propagated by cuttings and seeds; frame.

*Spiræa* (*L.*) *digitata* *Willd.*

*Potentilla* (*Nestl.*) *dahùrica* *Nestl.* *floribunda* *Pursh.* The above two unquestionably distinct species are considered varieties of *P. fruticosa* *L.* by *M. Seringe* in *Dec. Prod.!*

*Fúchsia* (*Plum.*) *microphýlla* *H. B. et Kunth.* Sweet. B. F. G. new s. t. 16. An elegant small upright bushy shrub; leaves elliptically oblong, dentate, shining; flowers axillary bright red nodding; berries roundish, black, shining. According to *Decandolle* this is the *F. grácilis* of the unpublished *Flora* of Mexico. This favourite genus has now become rather extensive. In this collection I observed fifteen species and varieties, the whole of which are perfectly hardy with the exception of *F. lycioides* *And.*, *F. arboréscens* *Sims.* and *F. excorticata* *Lin. f.* which require the protection of a green-house.

*Hélmia* (*Link et Otto*) *salicifolia* *Link et Otto.* Sweet's B. F. G. t. 281. An elegant bushy shrub, with lanceolate leaves and axillary yellow flowers. Hardy; propagated by cuttings.

*Scorzonèra* (*L.*) *pusilla* *Pall.* *tuberosa* *Pall.*

*Silybum* (*Vail.*) *cérnum* *Gärtn.* A handsome hardy perennial. Stem 3

to 4 ft. in height, radical leaves cordate, stem leaves ovate amplexicaul, with large drooping yellow flowers. Propagated by seeds and division.

*Erigeron (L.)? maximum Link et Otto.* Stem 5 to 6 ft. high, much branched, with large oblong semi-amplexicaul deeply-toothed leaves, and showy white flowers. Frame; seeds and division.

*Aster (L.) acuminatus Mich.*

*Podolepis (Lab.) gracilis Graham.* Sweet's B. F. G. t. 285.

*Galardia (Lam.) aristata Pursh.*

*Asclepias (L.) Greeniana Nutt.*

*Houstonia (L.) purpurea L.* Stem erect branched, 5 to 4 in. in height; leaves linear lanceolate, with terminal corymbs of pale purple flowers. — *H. serpyllifolia Mich.* Bot. Mag. 2825. Cæspitose. Branches numerous, rooting; leaves spatulate, somewhat hairy; peduncles elongated terminated by a solitary white flower. This species and the preceding are excellent furniture for rockwork; they also thrive well in small pots, well drained, composed of turfy loam and peat.

*Phlox (L.) cordata Ell.* Sweet B. F. G. n. s. t. 15. This is really a handsome and very distinct species with smooth stems, 4 to 5 ft. high, cordate oblong leaves, and corymbed panicles of purplish lilac flowers, delicately fragrant. — *P. disticha Sabine.* Stem erect, smooth, purplish, 3 to 4 ft. high; leaves undulate, oblong, acuminate, smooth, margin rough, panicles distichous, petals lanceolate distinct, flowers of a beautiful lilac, fragrant. The distichous mode of flowering at once distinguishes this species from its coordinates, it has perhaps the nearest affinity to *P. undulata Ait.*

*Digitalis (L.) micrantha Roth.*

*Salvia (L.) phlomoides Ass.*

*Phryma (L.) leptostachya L.*

*Scutellaria (L.) serrata Andr. Rep.* 494. Stem 18 in. to 2 ft. in height, with ovate acuminate serrate leaves and terminal racemes of elegant purple and white flowers. It succeeds best in peat soil. Division.

*Leonurus (L.) lanatus Pers.* Introduced in 1752, but now become rare. It is a curious and pretty species, of low growth, with densely woolly stems, palmated woolly leaves, and verticillated villose sulphur-coloured flowers. Hardy. Propagated by seeds and division.

*Phlomis (L.) pungens Willd.* Sweet's B. F. G. t. 55.

*Chasmônia (Presl) incisa Presl.* Bot. Reg. t. 1244. This genus has emanated from the Linnean Moluccella, of the propriety of which there can be no question: it attains the height of 6 or 7 ft. with numerous erect branches from the bottom. Leaves cut-palmate; flowers in whorls of twelve or fourteen, yellowish and lilac, calyx armed with strong spines. It is a biennial, flowering from May until October. Cuttings and seeds.

*Lysimachia (L.) dubia Ait.*

*Taxantheme (Neck. et R. Br.) incana Sweet.* B. F. G. t. 272. This is perhaps the most elegant of the red-flowered kinds; the dark red flowers exhibiting a peculiar contrast with the persistent scariose calyx. Flowers from July to September. It may be occasionally increased by splitting the crown; but unless this operation is effected with due care, it is certain to prove fatal to the plant. It has not produced seeds, consequently it is very rare.

*Begonia (L.) semperflorans Link et Otto,* not Bot. Mag.

*Habranthus (Herb.) robustus Herb.* Sweet's B. F. G. new s. t. 14. A bulbous plant with a solitary rose-coloured flower, appearing throughout the summer. Perfectly hardy. Propagated abundantly by seeds.

*Alstrœmeria (L.) psittacina Lehm.* Sweet's B. F. G. t. 15. Stems several from the same root, 18 in. to 2 ft. high, erect, maculate. Leaves oblong lanceolate, twisted at the base, with many-flowered umbels of splendid crimson, purple, and green flowers. Frame or mulch in winter; propagated by division and seeds. — *Alpha.* Sept. 9. 1829.



times determined by the supply, but depending in a great measure on the demand, which, in the case of ripe fruits, is increased by the state of the weather, the consumption being increased by fine and warm temperature.

Pears of the commoner varieties have been sent from the lower counties in great abundance. Jargonelles have not been a general crop, though in some places plentiful. Windsor pears have been very fine and large, and, if possible, with less than their usual flavour; but in consequence of their size and showy appearance, have met with ready sale. Williams's Summer Bon Chrétien has not been by any means in such supply as in former seasons, and is at all times very transient and of limited demand.

As a proof of the improved state of culture prevailing (which may be fairly attributed to the increased means of communication, by the publication of the remarks of individuals, through the means of the Gardener's Magazine, and other cheap and useful periodicals more particularly devoted to the purposes of improvement in agriculture and horticulture), may be remarked the early production of the larger varieties of carrots, such as the Altringham, now grown extensively in Bedfordshire; the Studley variety, and the Surrey or Long Orange, entirely superseding the older varieties of the Horn and the Short Orange in our market; the latter one still generally cultivated for the provincial markets, more particularly those of the north of England and Scotland. French and scarlet beans, which, in the early part of the season, promised a most abundant return, have in a great measure failed, in consequence of the prevalence of so much wet. This leads me to remark the change of taste in the public with regard to vegetable productions, in now preferring the scarlet runners to the dwarf varieties. Formerly the scarlet beans could not be disposed of on any terms in the London markets. The same change of taste has taken place in favour of the Green Artichoke, which is now preferred to the Old Globe variety, that hitherto had been exclusively cultivated.

Some interest is necessarily attached to any thing which may be offered as a new vegetable. Indian corn, or maize, has been hitherto well known as an ornamental plant, rather than as one of extensive utility; but many of its valuable properties have been somewhat exaggerated by a very popular political writer. Several varieties, amounting in all to more than twenty, have been cultivated by Mr. Poynter of North End, among which that so strongly recommended by Mr. Cobbett is to be found, which is neither more nor less than the variety extensively cultivated in Nova Scotia and New Brunswick; of which I have by me good specimens, grown from seed imported from Halifax in the year 1822. A more dwarf variety from Egypt, with corn almost ripe, which will grow freely in rows not more than 12 in. or 15 in. apart, is also to be observed. The remainder are principally of the tall varieties, among which may be enumerated the Early Flint, the Long Island White, the Meat and Sugar Corn, with the Pearl Corn, evidently a distinct species [?]. This, in the present season (very unfavourable), gives no indication of fructification, but would yield the largest quantity of succulent herbage, if required for that purpose. The green corn should be in season in August, to supply, in case of an extremely dry season, the deficiency of peas at that period; to obtain which it will always be necessary to sow it on a very moderate hot-bed in April, and transplant it in May: but this would present no difficulty, where labour is so readily obtainable; and should drought prevail at the time of planting out early in May, a crop for general use might be obtained from dibbling in the seed. A very considerable mistake appears to prevail with respect to the quantity generally expected in return as a crop per acre. I have had opportunities of observing it in America, and I have made enquiry of my friends there, who are in the habit of cultivating it extensively, and cannot find that, under very favourable circumstances, it ever yields more than sixty bushels to the acre. Should

you consider a comparative estimate of its probable value as an article of culture, in lieu of oats, barley, or peas, in our general system, desirable, I think I could, with some attention, furnish it to you. — *G. C. Sept. 9, 1829.*

---

ART. XI. *Two Articles in the Constitution of the Dunfermline Florists' Society.*

SIR, A society for the cultivation of fine flowers, &c., was formed at Dunfermline in 1827, called "The Dunfermline Florists' Society." As the principles upon which it is formed have given universal satisfaction, a wish has often been expressed that a short outline of them might be sent to you. Being secretary of that Society, and now in London for a week or two, I herewith give you two of the leading articles, which probably may be of some use to such of your readers as are about to form similar institutions.

*Article 1.* — That there shall be six prizes awarded at each competition; the first to be entered No. 6 in the prize-book, the second 5, the third 4, and so on down to 1: that, at the end of the season, each gainer's numbers shall be summed up, and the person whose numbers are greatest shall receive the greatest prize, in the ratio of six to one. For example, suppose A. B. to have got a first (6), a third (4), a sixth (1), and a second (5), making in all 16; C. D. has got three seconds and a first, making 21; J. D. has got numbers to the amount of 18, W. M. to the amount of 20, D. J. 12, and J. A. 21 (those gainers whose numbers are below twelve get nothing, the six highest being only taken). Now add A. B. 16, C. D. 21, J. D. 18, W. M. 20, D. J. 12, and J. A. 21, making a total of 108. Let the sum to be shared, *8l. 2s.*, be divided by 108, when the quotient will be *1s. 6d.* Now each person will be entitled to as many 108th parts as his number amounts to; therefore, A. B. gets 16 times *1s. 6d.*, or *1l. 4s.*; C. D. 21 times, or *1l. 11s. 6d.*; J. D. *1l. 7s.*; W. M. *1l. 10s.*; D. J. *18s.*; and J. A. *1l. 11s. 6d.*; making a total of *8l. 2s.*, the sum to be divided. — The members pay *2s.* each annually.

*The next Article* that we reckon most encouraging to such members as have not a large stock of flowers is, "That when more than one sort of flower is to be competed for at the same time (for example, at the spring show, the auricula, polyanthus, and hyacinth form but one competition), the judges shall first go over all the different parcels sent in, and select the best one from each" (for example, A. B. sends in auriculas, polyanthuses, and hyacinths; his auricula is reckoned the best of his parcels, it is brought forward, and the others are set aside: another member may send in only two varieties; the best is taken, and the other set aside: another may send in only one, it is taken, and brought forward for the second selection; and so on), "and setting the rest aside, they shall then go over the first selection again, and say which is the best one of all these:" so that the member who has only four good auriculas, or four polyanthuses, or four hyacinths, has as good a chance as the one who has all the twelve.

These are the two main articles; the others, I presume, are common to all societies of the kind. — *D. Inglis. Sept. 1.*

---

ART. XII. *Provincial Horticultural Societies.*

SUSSEX.

*CHICHESTER Horticultural Society.*—The Annual Meeting of this Society was held on August 5; and it afforded us much pleasure to witness the

obvious improvement which this institution has effected in the productions of the hot-bed and vinery, the display of melons, grapes, and pines, far exceeding any previous show, both as to number and quality. The tables were arranged down the middle of the room, and contained a profusion of fine melons, grapes, pines, nectarines, peaches, gooseberries, and other fruits; a beautiful plumbago from the conservatory of T. Rhoades, Esq., two magnificent cockscombs from Lord Egremont's and Messrs. Humphreys'; a stand of seedling picotees and carnations from the Rev. W. Watkins, which was particularly admired, and several other splendid and highly cultivated flowers. The prizes were awarded as follows:—

*Flowers.* Picotees: 1. Rev. W. Watkins; 2. Mr. Gorsuch. Carnations: 1. Rev. W. Watkins; 2. Mr. Gorsuch. — *Fruit.* Pines: 1. Mr. Saunders, gardener to W. Newland, Esq.; 2. Mr. Harrison, gardener to Lord Egremont. Grapes: 1. Mr. Cakebread, gardener to Messrs. Henty; 2. Mr. Fielder, gardener to C. Dickens, Esq.; 3. Mr. Coates, gardener to the Rev. G. Porcher. Melons: 1. Mr. Hammond, gardener to Messrs. Humphreys; 2. Mr. Sims, gardener to W. Leeves, Esq.; 3. Mr. Lasseter, gardener to W. Wyatt, Esq.; 4. Mr. Hislop, gardener to Mrs. Smith; 5. Mr. Gorsuch, gardener to the Bishop of Chichester. Gooseberries: 1. Mr. Goddard, gardener to Col. Todd; 2. Mr. Dicks, gardener to J. Dyson, Esq.; 3. Mr. Softly.

The following extra-prizes were awarded:—Rev. W. Watkins, for his stand of seedling picotees and carnations; Mr. Hammond, cockscomb; Mr. Gorsuch, celery; gardener to W. Ridge, Esq., raspberries. (*Brighton Gazette*, August 6.)

#### HUNTINGDONSHIRE.

*Huntingdonshire Horticultural Society.*—This Society was formed in 1821, and originated with a few gentlemen of Huntingdon and its immediate neighbourhood, who elected John Maule, Esq., their president, and Mr. James Wood of Huntingdon, secretary, under whose care, together with the cooperation of an active committee, it has extended itself into the surrounding counties, and has now upon its list of members nearly 200 ladies and gentlemen. There are two annual shows: one in the spring, for auriculas, polyanthuses, hyacinths, cucumbers, &c.; and the other in July, the objects of which may be seen in the subjoined report. The Society is open to members for competition, from any part of the kingdom, and its regulations may be obtained from the treasurer, Mr. James Wood, or the secretary, Mr. Robert Fox, on application, post-paid. Mr. Maule having resigned the presidency, that office is now filled by Lord Strathaven. The Eighth Anniversary was celebrated with increased splendour at the Assembly-room, Huntingdon, on Wednesday, July 29. 1829.

*Flowers.* Carnations (extra-best flower), Gregory's King Alfred, Purple Bizard, Mr. John Franklin, jun. Bizards. Scarlet: 1. Yeomanson's Metropolitan, Mr. Raye; 2. Smalley's Foxhunter, Mr. Franklin, jun.; 3. Wood's President, Mr. Fordham. Purple: 1. Gregory's King Alfred, Mr. Franklin, jun.; 2. Gregory's King Alfred, Mr. Todd; 3. Cartwright's Rainbow, Mr. Reed. Flakes. Scarlet: 1. Wood's Lord Strathaven Seedling, Mr. James Wood; 2. Pearson's Madam Mara, E. Howson, jun.; 3. Tomlinson's Duke of Rutland, Mr. Reed. Purple: 1. Turner's Princess, Mr. Furze; 2. Turner's Princess, Mr. Franklin, jun.; 3. Kenney's Excellent, Mr. Dearlove. Rose: 1. Fletcher's Duchess of Devonshire, Mr. Furze; 2. Wood's Lady De La Warr Seedling, Mr. J. Wood; 3. Fletcher's Duchess of Devonshire, Mr. Franklin, jun. Seedlings: 1. Wood's Lord Strathaven, Mr. James Wood; 2. Howson's Beauty of Huntingdon, Mr. E. Howson, jun. Picotees (extra-best flower): Rose, Purchas's Granta, Mr. Fordham. Purple: 1. Hufton's Miss

Willoughby, Mr. Franklin, jun. ; 2. Wood's Lady Strathaven Seedling, Mr. James Wood ; 3. Russell's Lady Bagot, Mr. Reed. Red : 1. Wood's Triumphant, Mr. Franklin, jun. ; 2. Wood's Triumphant, Mr. Raye ; 3. Wood's Triumphant, Mr. Furze. Rose : 1. Purchas's Granta, Mr. Fordham ; 2. Cornfield's Lady Miller, Mr. E. Litchfield ; 3. Jeeves' Lady Arabella, Mr. Franklin, jun. Yellow : 1. Hird's Miss Harriot, Mr. Reed ; 2. Louis the Sixteenth, Mr. James Wood ; 3. Hyland Xenobia, Mr. E. Litchfield. Seedlings : 1. Wood's Lady Strathaven, Mr. James Wood ; 2. Dalley's Goliath, Mr. Dalley. — *Fruit.* Gooseberries. Heaviest, Farr's Roaring Lion (Red), 21 dwts. 7 grs., Mr. Hyland. Red : 1. Farr's Roaring Lion, 21 dwts. 7 grs., Mr. Hyland ; 2. Farr's Roaring Lion, 21 dwts. 1 gr., Mr. Furze ; 3. Farr's Roaring Lion, 20 dwts. 17 grs., Mr. James Wood ; 4. Farr's Roaring Lion, 20 dwts. 11 grs., and 5. Hoopley's Jubilee, 20 dwts. 5 grs., Mr. Hyland. Yellow : 1. Hardcastle's Royal Gunner, 17 dwts. 8 grs., Mr. Hyland ; 2. Prophet's Rockwood, 17 dwts. 8 grs., Mr. James Wood ; 3. Seedling, 16 dwts. 2 grs., Mr. Hyland ; 4. Andrew's Nelson's Wave, 15 dwts. 5 grs., Mr. Bleet ; 5. Andrew's Nelson's Wave, 14 dwts. 12 grs., Mr. Dalley. Greens : 1. Ingham's Green Ocean, 17 dwts. 3 grs., Mr. Bleet ; 2. Moore's Troubler, 15 dwts. 20 grs., Mr. James Wood ; 3. Ingham's Green Ocean, 15 dwts. 11 grs., Mr. Hyland ; 4. Moore's Troubler, 14 dwts. 6 grs., Mr. Dalley. White : 1. Hyland's Earl of Sandwich, 20 dwts. 4 grs., 2. Hyland's Earl of Sandwich, 19 dwts. 14 grs., 3. Hyland's Earl of Sandwich, 19 dwts. 6 grs., and 4. Cook's White Eagle, 17 dwts. 15 grs., Mr. Hyland ; 5. Bratherton's Wistaston Lass, 16 dwts. 17 grs., Mr. Franklin, jun. Seedling, Hyland's Earl of Sandwich, 20 dwts. 4 grs., Mr. Hylands. Best dish for flavour : 1. Champagne, Mr. Hyland ; 2. Champagne, Mr. Franklin, jun. ; 3. Champagne, Mr. E. Litchfield ; 4. Champagne, Mr. Dall ; 5. Champagne, Mr. Slight. Currants. White : 1. New White Grape, 16 bunches to the lb., Mr. Hyland ; 2. New White Grape, 17 bun. to lb. Mr. Fordham ; 3. White Dutch, 20 bun. to lb., Mr. Bleet. Red : 1. New Red Grape, 17 bun. to lb., Mr. Hyland ; 2. Red Dutch, 26 bun. to lb., Mr. Boucher ; 3. Red Dutch, 28 bun. to lb., Mr. Dalley. Cherries. For flavour : 1. Turkey Bigarreau, 49 to lb., Mr. E. Litchfield ; 2. May Duke, 49 to lb., Mr. Dalley ; 3. May Duke, 51 to lb., Mr. Boucher ; 4. May Duke, 57 to lb., Mr. Slight ; 5. Turkey Bigarreau, 58 to lb., Mr. Fordham. Peaches. Dish of six : 1. and 2. French Mignonne, Mr. Frazer. Grapes. For flavour (fruited in a pot) : 1. Black Hamburg, and 2. Royal Muscadine, Mr. Boucher. Pines : 1. and 2. New Queen, Mr. Dall.

## CAMBRIDGESHIRE.

*Cambridge Horticultural Society.* — This Society held their July Show on July 24. The arrangement of the Show was very judicious, and the *coup d'œil* imposing. The Rev. R. Lascelles took the chair at half-past two precisely, and announced the following adjudication of prizes : —

*Flowers.* Carnations. Five best : 1. Wilde's Perfection, Rainbow, Timm's Lord Byron, Yate's Supreme, Potter's Lord Belmont, Mr. John Bailey ; 2. Wilde's Perfection, Madame Mara, Duchess of Devonshire, Princess Charlotte, Gregory's King Alfred, Mr. Twitchett. Three best of different sorts : 1. Pearson's Madame Mara, Yeomanson's George the Fourth, Mason's Duchess of Gloucester, Mr. John Sharp ; 2. Turner's Princess Charlotte, Wilde's Perfection, Cartwright's Rainbow, Mr. Robt. Nutter. Best, Wilde's Perfection, Mr. John Sharp. Seedling : 1. Mr. Grimson ; 2. Haylock's Curator, Mr. Haylock. Picotees. Six best : 1. Purchas's Granta, Matilda, Beauty, and Eliza, Martin's Linnæus, Chilwell Beauty, Mr. Purchas ; 2. Bunton's Miss Neville, Mufton's Will Stukely, Cornfield's Lady Miller, Wood's Countess of Sandwich, Martin's Linnæus, Howlett's Paragraph, Mr. Rickard. Three best bloom : 1. Biggleswade Beauty, Cleopatra, Miss Neville, Mr. Dobson ; 2. Wood's Countess of Sandwich, Miss Neville, Seedling, Mr. John Sharp. Best, Miss Neville, Rev. G. A. Browne.

Seedling: 1. Rev. R. Lascelles; 2. Mr. Dobson. Hollyhocks: three best, Mr. Brewer; best, Mr. Catling. Balsam, Mr. Searle. Cockscomb: 1. Mr. Thomas Ready; 2. Mr. Lestourgeon. Georginas. Best six: 1. Fúlgida nàna, Imperiòsa, French Lilac, Princess Augusta, Imperial Purple, Perfècta, Mr. Widnall; 2. Coronation, Sans Rival, Phœnix, Sanguinea, Gloriòsa, Marshall's Purple, Mr. Gimson. Best three, Colville's Perfècta, Theodore, Coronation, Mr. Searle. Best, Donna Maria, Mr. Widnall.—*Fruit.* Melons: 1. Royal Windsor (Scarlet Flesh), Mr. Catling, grown at Dr. Haviland's; 2. Cantaloup, Mr. Palmer of Ely. Apricots, Masculine, John Hemington, Esq. Cherries. Duke: 1. 55 to the lb., Mr. Challis; 2. 56 to the lb., Mr. Wilson, Lord De La Warr's gardener. Heart, 51 to the lb., Mr. Fordham, gardener to T. Quintin, Esq. Raspberries: white, Mr. Challis; red, Mr. Dall. Gooseberries: red (Roaring Lion and Rough Robin, 14 to the lb.), Mr. Gimson; white (Cheshire Lass, 20 to the lb.), Mr. Gimson; green (Green Ocean, 20 to the lb.), Mr. Challis; yellow (Nelson's Waves, 19 to the lb.), Mr. Gimson. For flavour: 1. Champagne, Col. Pemberton; 2. Warrington, Mr. Palmer, of Ely. Heaviest (Rough Robin, 1 oz. 1 dwt. 1 gr.), Mr. Gimson. Currants. White: 1. 19 bunches to the lb., Mr. Palmer of Ely; 2. 19 bunches to the lb., Mr. Fordham of Hatley. Red: 32 bunches to the lb., Mr. Patrick Beales.—*Culinary Vegetables.* Lettuces, best three Paris Coss, Mr. Widnall.

*Treasurer's Prize.* Bouquet, Mr. Gimson.

*Cottage's Prizes.* Gooseberries, Joseph Beales, Cherryhinton. Currants, James Tuck, Windmill Cottage, Harston. Cucumber, Henry Hunt, Duxford. Carnation, John Munns, Barnwell. Balsam and Hollyhock, Joseph Beales, Cherryhinton.

*Extra-Prizes.* Bigarreau Cherries, Mr. John Eaton, Cambridge. Cottage's Bouquet, Joseph Beales, Cherryhinton. Cottage's Cabbage, Robert Freeman, Abington. Wilmot's Superb Strawberries, Mr. Wilson, Lord De La Warr's gardener. Turnips, Maltese, Mr. Denson, Waterbeach. Kitchen Apples, Kentish Pippin and Norfolk Beffin, Col. Pemberton. Double Sweetwilliam, seedling, Mr. Brown, Fordham. White Spanish Onions, Mr. Lestourgeon. Table Pears, Citron des Carmes, Mr. Searle. French Marigolds, Mr. Dall. Fúchsia, Mr. Palmer of Ely. Double Scarlet Lychnis, Mr. John Bailey. Hydrangea, Mr. Haylock. Candytuft, *Ibèris umbellatus*, C. Pemberton, Esq.

The Committee then proposed prizes for cottagers, at the next Show, for apples, pears, plums, onions, parsneps, three china asters, and georgina. (*Cambridge Chronicle*, July 31.)

#### SUFFOLK.

*Bury Horticultural Society.*—At the Meeting of this Society on July 28. the show of flowers, fruits, and vegetables was excellent: amongst the most note-worthy were *Eùcomis striàta*, *Thunbèrgia alàta*, and *Cràssula coccinea*, by Mr. Hodson; georginas, carnations, melons (including some very fine ones, not offered for the prize, by J. Phillips, Esq.), lettuces, and onions of immense size, &c. Several specimens arrived too late to be submitted to the judges. The two prizes of one guinea each for cottage gardens gave great satisfaction, and, we trust, will be of the most beneficial tendency. The following was the award:—

*Flowers.* Carnations: Bizards, six sorts, Mr. Barrett; Flakes, Mr. Barrett; Picotees, Mr. Lord. Best Bouquet, Mr. Hammond.—*Fruit.* Melon, Gros Cantaloup, Mr. Lines. Apricots, R. Petteward, Esq. Cherries, Elton, Mr. Barrett. Raspberries, red, Mr. Stacey. Gooseberries. Heaviest: red, Mr. Brett; white, Mr. S. Nunn; green and yellow, Mr. Levett. For flavour, Mr. Musk. Currants, white, 22 to the lb., Mr. Levett; red, R. Petteward, Esq.; black, Rev. W. Basset.—*Culinary Vegetables.* Lettuces, Mr. Francis Clark, jun. Onions, Mr. Pierson.



*Cottagers' Prizes.* Fruit, Rickwood, Timworth. Vegetables, Jermyn, Timworth. Best managed cottage-gardens: Jermyn, Timworth; and Spink, Hengrave. (*Bury and Norwich Post*, July 22.)

## BERKSHIRE.

*Windsor Horticultural Society.* — At the Meeting of July 22., prizes were awarded to the following gentlemen: —

*Carnations.* 1. Mr. Gould, Windsor; 2. Mr. Willmar, Sunbury; 3. Mr. Willmar, jun., Sunbury; 4. Mr. Bates, Oxford; 5. Mr. Beedon, Hillingdon; 6. Mr. Smith, London. — *Melons.* (30 shown): 1. Mr. Ingram, Frogmore; 2. Mr. Austin, Burnham; 3. Mr. Ingram, Frogmore; 4. Mr. Anderson, Ditton; 5. Mr. Ingram, Frogmore; 6. Mr. Anderson, Ditton; 7. Mr. Stevens, Harefield; 8. Mr. Cooper, Bray. — *Gooseberries.* 1. Mr. Brown, Hammer-smith; 2. Mr. Gould, Windsor; 3. Mr. Turner, Eton; 4. Mr. Stevens, Harefield; 5. Mr. Bowyer, Bray. — Some fine peaches and grapes were exhibited, but these fruits not being entered for a prize, none was awarded.

*Miscellaneous Class.* — Four prizes were awarded to Mr. Ingram for georginas, *Cactus speciosissima*, hollyhocks, and a blue hydrangea. — *J. P. B.* July 24. 1829.

## GLOUCESTERSHIRE.

*The Bristol Horticultural Society.* — The Second Exhibition of this Society was held on August 4., which abundantly realised the warmest hopes that the friends of that institution had conceived. The suite of Assembly Rooms were opened on this occasion; the front and central rooms were fully occupied by a magnificent display of ornamental plants and flowers, tastefully arranged on an elevated platform, in the centre of the front room, and on tables extending completely round that apartment, and in two pyramidal groups in the middle room.

Amongst others, for which no prizes were awarded, were conspicuous — a very fine lemon tree, belonging to Mr. Hurle; a beautiful *Hydrangea hortensis*, sent by Miss Shepherd of Compton; a fine plant of *Yucca filamentosa*, in full bloom, belonging to Mr. Maule; to *Maurandya Barclayana*, promising soon to blossom, belonging to A. Hilhouse, Esq., accompanied with an engraving of the flower; a fine *Theophrasta longifolia*, a *Cycas revoluta*, and a very large *Coffea arabica*, nearly 10 ft. high, belonging to the Rev. Mr. Pring of Hambrook; a beautiful specimen of *Musa paradisiaca*, and a large scarlet seedling geranium belonging to Colonel Græme. We also observed, belonging to Mrs. March Phillips, a *Cycas revoluta*, a *Phoenix dactylifera*, two beautiful plants of *Hydrangea hortensis*, and some flowers of the large *Agave americana*, now blooming, which is open to the inspection of the curious under the care of Mr. Dunn, her gardener, at Brislington; a very vigorous young *Clèthra arborea*, in full bloom, the owner of which we could not ascertain; some fine myrtles; a *Yucca acuminata*, and several others, belonging to Gabriel Goldney, Esq.; a beautiful plant of *Thunbergia alata*, in full bloom, belonging to John Scandrett Hartford, Esq., of Blaize Castle; a handsome *Cactus Opuntia* in blossom, from Mrs. Acland of Clifton; a beautiful plant of *Lobelia Erinus*, sent by Mrs. John Hurle of Brislington; superb flowers of *Bignonia radicans major*, and magnificent blossoms of *Magnolia grandiflora*, from Miss Bright of Ham Green. Mr. J. Young of Taunton exhibited a box containing a number of beautiful georginas; two in particular, which he has named *corymbosa* and *globosa*, excited marked attention; a large pale yellow one, and a deep purple, also called forth much admiration. We noticed some beautiful georginas from Mr. Wheeler of Warminster; also plants of *Roëlla ciliata*, *Matricaria grandiflora*, and many others; and fine trees of the Hawthornden apple and Keswick codlin, loaded with fruit, belonging to Mr. Maule.

Mr. Miller, the honorary secretary, contributed to the ornaments of the day a beautiful *Amaryllis*, believed *revoluta*, *Erica Ewerana pilosa*, *E. Savileana*, *E. ampullacea*, *E. Bandoniana*, *E. juliana*, *E. cerinthoides*, several fine pelargoniums, a beautiful plant of *Swainsonia galegifolia* in blossom, *Gloxinia caulescens*, plants of *Crassula coccinea*, *C. falcata*, and *C. odoratissima*, *Fuchsia conica* (a rare species), a magnificent plant of *Banksia marcescens*, *Cussonia spicata*, *Dryandra longifolia*, and some fine specimens of the new annual and herbaceous plants, *Collomia grandiflora*, *Browallia elata*, *Clarkia pulchella*, Russian stocks, *Cleome rosea*, *Lupinus mutabilis*, *Spigelia marilandica*, *Delphinium chinense*, a new *Lythrum* from America, *Campánula pyramidalis*, var. *lactiflora*, and var. *versicolor*, and several fine plants of *Phlox*, viz. *P. Wheeleri*, *P. corymbosa*, and *P. pyramidalis*; a superb collection of about fifty varieties of georginas in two boxes, and a box containing about the like number of carnations and picotees of distinguished beauty, together with many exotic and other shrubs, and a profusion of flowers and evergreens, tastefully disposed in ornamenting the rooms.

In the third room were exhibited the fruits and vegetables, amongst which, besides the articles which obtained the prizes, were some fine cherries, sent by Col. Houlton and Mr. Ricketts; and among the vegetables were fine specimens of *poirée à carde*, sent by Mr. Shepherd of Compton. A specimen of Cobbett's Indian corn was sent by Mr. Rankin; and some fine drumhead cabbages not belonging to a subscriber.

It is to be regretted, that there were only two competitors in the class of cottagers' prizes; but on future occasions the donations of these will haply be made more extensively known, and the competition increase, so that the subscribers may attain their much wished for object, of making this institution not less subservient to the increase of comforts to the agricultural labourer, and of plenty to the markets, than it is to the luxuries of the rich, and the gratification of a taste for the most elegant productions of nature.

The judges chosen by the Committee were, J. L. Knapp, and S. Horsley, Esqrs., the Rev. W. Phelps, Mr. Fedden, and Mr. Rootsey. The prizes were awarded as follows:—

*Plants.* Green-house: *Fuchsia gracilis*, Miss Bayly; *Cotyledon orbiculata*, Christopher George, Esq. Hardy: *Yucca filamentosa*, Col. Græme; *Potentilla formosa*, Mr. Lee.—*Flowers.* Carnations: Scarlet Bizards, Mr. Taylor and Mr. Jacques; Scarlet Flakes, Mr. Taylor; Purple Flakes, Mr. Taylor and Mr. Jacques; Crimson Bizards, Mr. Jacques and Mr. Taylor; Rose Flakes, Mr. Taylor and Mr. Maule; Pink and Purple Bizards, Mr. Taylor and Mr. Maule; Seedling Carnations, Mr. Jacques and Mr. Taylor; Purple Picotees, Mr. Maule and Mr. Jacques; Red Picotees, Mr. Taylor and Mr. Jacques; Yellow Picotees, Mr. Taylor and Mr. Maynard. Georginas: Dark Purple, Mr. Wheeler and Colonel Houlton; Double Scarlet, Mr. Wheeler and Mr. Maule; Double Light, Mr. Maule. Double Balsams; Mr. Maule and Mr. Varney. Cockcombs: John Warne, Esq. and Mrs. Cartwright. Hollyhocks: Richard Oakley, Esq., and Mr. Lee.—*Fruit.* Pine-apples: Prize Queen, W. P. Jillard, Esq.; St. Vincent, Mr. Varney. White Providence, Mr. Maule. Grapes: Black Hamburg, Mr. C. H. Jessop; White Muscat, W. P. Jillard, Esq. Melons: Netted Cantaloup, J. W. Ricketts, Esq.; Black Rock, Miss Bright. Peaches, Mrs. March Phillips and John Hurle, Esq. Nectarines, Mrs. March Phillips and Philip Protheroe, Esq. Apricots, Breda, Mrs. Lydia Gregory. Cherries, Morello, Miss Bayly and J. N. Franklyn, Esq. Early Apples: Kerry Pippin, D. Staunton, Esq.; Keswick Codlin, J. W. Ricketts, Esq. Early Pears, Citron des Carmes, Mr. Fry and Mr. Lee. Raspberries, Red Antwerps, Mr. G. W. Hall. Currants, Red Dutch, P. Protheroe,

Esq., and Mr. S. Warring; White Dutch, Mrs. Sheriffe and Mrs. John Hurle; Black, W. P. Taunton, Esq. Gooseberries: Red Roaring Lion, Mr. Cartwright; Crown Bob, Henry Brooke, Esq.; Green Angler, Mr. Cartwright; Ocean, D. Stanton, Esq.; Yellow Rockwood, Mr. Cartwright. — *Culinary Vegetables.* Kidneybeans, Mr. Lee and Mr. John Hurle. Celery, White Solid, Mr. Lee. Cauliflower, Mr. Lee. Cucumbers, Mr. Jessop and W. P. Taunton, Esq. Peas, Rev. Dr. Sweete and Mrs. John Hurle. Potatoes, Ash-leaved Kidneys, Mrs. L. Gregory and Miss Bayly. Carrots, Mr. Maynard and D. Stanton, Esq. Artichokes, Richard Oakley, Esq. Cabbages, Battersea and Emperor, Mr. Lee. Turnips, Mrs. John Hurle and Mr. Lee. Vegetable Marrow, J. N. Franklyn, Esq., and Mr. Maule.

*Extra-Prizes.* Keswick Codlin, Mr. Maule. Cantaloup Melon, Mrs. John Cave. Citrus *médica tuberosa*, and Citor d'Olor Melon, Miss Bright. Black Hamburg and White Sweet Water Grapes, Mrs. Harford.

*Cottagers' Prizes.* Large Cabbage, Elizabeth Martin, Ashton. Codlin Apple, J. Bullock, Tockington. (*Bristol Gazette*, August 15.)

#### WORCESTERSHIRE.

*Vale of Evesham Horticultural Society.* — The Third Meeting of this Society for the present year, was held at Evesham, on the 18th inst., when the following prizes were awarded: —

*Plants.* Stove or Green-house: 1. Mr. Hartland; 2. Mr. Procter; 3. Mr. Hartland. Hardy Annuals: 1. Rev. G. Shute; 2. Mr. Mayfield. — *Flowers.* Ranunculuses. Class 1: 1. Rev. Mr. Gretton; 2. Mr. Smith. Class 2: 1. Mr. Mayfield; 2. Mr. Smith. Class 3: 1. and 2. Mr. Smith. Class 4: 1. and 2. Mr. Mayfield. Class 5: 1. Mr. Smith; 2. Mrs. Eyston. Class 6: 1. Mr. Smith; 2. Mr. Mayfield. Class 7: 1. Mrs. Eyston; 2. Mr. Mayfield. Class 8: 1. Mr. Gratton; 2. Mr. Hunt. Pinks. Purple-laced: 1. Mr. Valencourt; 2. Seedling, Mr. Racster; 3. Mr. Jessop. Red-laced: 1. Mr. Hunt; 2. Mr. Valencourt; 3. Mr. Smith. Stars: 1. and 2. Mr. Valencourt; 3. Seedling, Mr. Mayfield. Roses: 1. Mr. Racster; 2. Mrs. Eyston; 3. Edward Rudge, Esq.; 4. Mr. Valencourt; 5. Mr. Hunt; 6. Mr. Racster; 7. Mr. Hunt; 8. Mr. Racster. — *Fruit.* Strawberries, Heaviest: 1. Black Taunton, and 2. Keen's Seedling, Mr. Hunt. Best flavoured: 1. Mrs. Eyston; 2. Keen's Seedling, Mrs. Charles. Cherries, Mr. Goodall. — *Culinary Vegetables.* Garden Beans, Mr. A. New.

After the prizes had been announced, and exhibited to a numerous assembly of the members and visitors, the London Horticultural Society's silver medal, which had been awarded to Mr. George Fulton, gardener to Lord Northwick, of Northwick Park, Worcestershire, for his general productions in horticulture, of superior excellence and flavour, and for his communications read to the Society, was presented to him by the president, E. Rudge, Esq., with the following address: —

“ In presenting to you, Mr. Fulton, this medal, as the merited reward of your labours, I congratulate you on being the first member of this Society on whom this honour is conferred; the presentation of a medal to its members is the highest mark of distinction which any learned society has in its power to confer, and we are greatly indebted to the liberality of the Horticultural Society of London, for having placed annually one of theirs at our disposal. There is no doubt but you will fully appreciate its value, and that it will be a stimulus to your future exertions in the cause of horticultural science. I take this opportunity of thanking you, in the name of this Society, for the various floral and horticultural specimens which you have exhibited to the Society at its Meetings, and to express a hope for their continuance, as well as for any future communications on such new or improved modes of culture, as you may find, by experience, have proved successful.” (*Worcester Herald*, July 4.)

HEREFORDSHIRE.

*Hereford Horticultural Society.* — The Fourth Show of this Society, for the present year, took place on July 27., and although the late ungenial weather gave little promise of the usual excellence displayed at this exhibition, we were agreeably surprised by a rich assemblage of choice varieties of stove and green-house plants (many of them from the gardens of Sir J. G. Cotterell, Bart. M. P. and C. G. Cooke, Esq.), georginas, picotees, carnations, balsams, &c. &c. The grand stand was richly decorated with choice plants, and the small one in the centre of the room presented a beautiful variety of Flora's choicest favourites; most of the georginas were remarkable for luxuriance of growth and richness of colour, and, with the picotees, were deservedly admired. The stage for fruits and vegetables was crowded with the finest melons, peaches, nectarines, apricots, plums, grapes, apples, cherries, gooseberries in great variety and of extraordinary size, raspberries, and currants, and remarkably large carrots, turnips, cauliflowers, and onions, and afforded additional proof that the horticultural productions of this county are not inferior to those of any other part of the kingdom. A lemon tree on the grand stand contained fruit by far the largest we have ever seen growing in this country; and amongst the vegetables there was a new esculent imported from Hungary, and called *kohl rabi*. The introduction of new varieties of vegetables forms one of the advantages of these societies, and it would be well to encourage them by a specific reward. The following was the award of prizes : —

*Plants.* Stove or Green-house : 1. *Pancrätium mexicanum*, C. G. Cooke, Esq.; 2. *Höya carnösa*, Sir J. G. Cotterell; 3. *Solanum melöngena*, C. G. Cooke, Esq. Hardy : 1. *Potentilla formösa*, Mr. Godsall; 2. *Chelöne barbata*, Mrs. Canon Morgan. — *Flowers.* Carnations. Scarlet Bizards : 1. Yeoman's Triumph, Col. Money; 2. Hale's Defiance, and 3., Mrs. W. Pateshall. Scarlet Flakes : 1. Strong's Sir S. Romilly, Mrs. W. Pateshall; 2. Hayley's Marquess Cornwallis, Col. Money; 3. Walker's Ruby, Mr. Godsall. Rose Flakes : 1. Fletcher's Duchess of Devonshire, Mr. Godsall; 2. Davey's Lady Shannon, R. J. Powell, Esq.; 3. Col. Money. Crimson Bizards : 1. Wild's Standard of Perfection, Mrs. W. Pateshall; 2. and 3. Mr. Cranston. Purple Flake : 1. Strong's Emperor, and 2. Smith's Fair Ellen, Mrs. W. Pateshall. Picotees. Purple : 1. Mr. Cary Cocks; 2. and 3. Mr. Godsall. Red : 1. Mrs. Gordon; 2. Salamander, Mrs. W. Pateshall; 3. Weldon's Litchfield Hero, W. H. Bellamy, Esq. Yellow : 1. Prince Maximilian, Mr. Godsall. Georginas. Dark : 1. Coronation, Mrs. Gordon; 2. Sir J. G. Cotterell; 3. Cranston's Seedling, Mr. Cranston; 4. Young's Triumph, R. J. Powell, Esq. Light : 1. Ne plus ultra, Mr. Cranston; 2. Grisette, Mr. Godsall; 3. Lady Hardinge, Sir J. G. Cotterell. Red : 1. Festina, Mr. Cranston; 2. Morning Star, Mr. Nott. Balsams : 1. Mr. Lee; 2. C. G. Cooke, Esq. Cockscombs : 1. and 2. C. G. Cooke, Esq. — *Fruit.* Gooseberries. Red : 1. Bang-up, Mr. Spencer; 2. Red Walnut, Mr. Godsall; 3. Ironmonger, Sir J. G. Cotterell. Green : 1. Green Ocean, and 2. Sirrell's Green, Mr. Spencer; 3. Wilmot's Early, Mr. Godsall. Yellow : 1. Mr. Godsall; 2. T. C. Bridges, Esq.; 3. Mr. Godsall. Grapes : 1. and 2. Sir J. G. Cotterell. Melons : 1. Green-fleshed, R. J. Powell, Esq.; 2. Sir J. G. Cotterell. Plums, Mrs. Gordon. Raspberries, R. J. Powell, Esq. Currants : 1. T. C. Bridges, Esq.; 2. R. J. Powell, Esq. Peaches, Royal George, Sir J. G. Cotterell. Nectarines, Elruge, C. G. Cooke, Esq. — *Culinary Vegetables.* Carrots, R. J. Powell, Esq. New esculent vegetable (*kohl rabi*), J. S. L. Pateshall, Esq. (*Hereford Journal*, July 29.)

*Ross Horticultural Society.* — The Twenty-fourth Public Exhibition of this long established Society took place on the 22d of July, and notwithstanding the wet and chilly weather of the previous month, the grand stand supported a rich and harmonious display of the house and hardy July families, much heightened by the tasteful arrangement of the prize fruits at its base

At the back of the long table, the twenty prizes in green-house and hardy plants, cockscombs, and balsams were placed, and the front was covered with upwards of two hundred plates of gooseberries, currants, raspberries, and other fruits. The cockscombs were remarkably fine, many of the blooms much exceeding a foot in length. The grower, Mr. Reynolds, has been long known as first rate in this rich flower. In the centre of the room the long stage was covered with an infinite variety of named double georginas, carnations, and picotees; this mixed assemblage formed a most fascinating sight, and we never witnessed a field of colour so rich, mellow, and sparkling. We understand that the Ross florists will in future exhibit their georginas in seven classes, which alone can meet the merits of this most delightful production. The prizes in carnations, picotees, and georginas were placed on a separate table, and the florists declared that they had never seen staged such prime blooms. The prizes were awarded as under:—

*Plants.* Green-house: 1. *Høya carnōsa*, and 2. *Eūcomis punctāta*, J. Cooke, Esq.; 3. *Euphōrbia punicea*, 4. *Gardēnia flōrida*, and 5. *Gloxīnia ālba*, Mr. J. C. Wheeler. Hardy: 1. *Monārda fūlgida*, and 2. *Campānula pyramidālis*, John Cooke, Esq.; 3. *Coreōpsis lanceōlata*, Mrs. Robertson; 4. *Ænothēra lineāris*, W. Gillman, Esq.; 5. *Lysimāchia capitāta*, Mr. Reynolds.—*Flowers.* Carnations. Scarlet Bizards: 1. Yeomanson's Triumphant, Col. Money; 2. Davey's Sovereign, Mr. Reynolds; 3. Seedling, Mr. Crump; 4. Howarth's Rifleman, Col. Money; 5. Prince William Henry, Mr. Reynolds. Crimson Bizards: 1. Clarke's Rainbow, Mr. Crump; 2. Bosted's Queen, and 3. Davey's Duchess of Devon, Col. Money; 4. Lord Ashbrook, Mr. Crump; 5. Lyford's Regent, Mr. Reynolds. Scarlet Flakes: 1. Seedling, Mrs. Westfaling; 2. Stainard's Britannia, and 3. Lacey's Wellington, Mr. T. Edwards; 4. Durett's Lord Hill, and 5. Seedling, Mr. Crump. Purple Flakes. 1. Butt's Lord Rodney, Mr. Reynolds; 2. Castle's Mrs. Barrington, and 3. Turner's Princess Charlotte, Mr. Crump; 4. Strong's Esther, Mr. T. Edwards; 5. Fripp's Jemima, Col. Money. Rose Flakes: 1. Seedling, J. F. Willis, Esq.; 2. Mason's Lady Hamilton, Mr. Reynolds; 3. and 4. Seedlings, Mrs. Westfaling; 5. Brown's Eliza, Mr. Reynolds. Picotees. Purple: 1. Salamander, and 2. Marchioness of Ormond, Mr. T. Edwards; 3. Martin's Linnæus, Mrs. Platt; 4. Davey's Lady Craven, Mr. Reynolds; 5. Cornfield's Leopold, Mr. J. C. Wheeler. Red: 1. Pearson's Chilwall Beauty, Mr. T. Edwards; 2. not named, Mr. Crump; 3. Woner Van Twiller, and 4. Louis Sixteenth, J. T. Willis, Esq.; 5. Lord Effingham, Mr. T. Edwards. Georginas. Dark Double: 1. Coronation, Mrs. Westfaling; 2. Seedling, H. Rosser, Esq.; 3. Young's Triumphant, and 4. Westland's Fimbriata, Mr. J. C. Wheeler; 5. Superbissima, T. Rudge, Esq. Light Double: 1. Ronald's Superb, Mr. Reynolds; 2. Footina, and 3. New Lilac, Mr. J. C. Wheeler; 4. Mont Blanc, Mrs. Westfaling; 5. Clifton Yellow, Mrs. James Rudge. Balsams: 1. Mr. Reynolds; 2. Mrs. Westfaling; 3, 4, and 5. Mr. Reynolds. Cockscombs: 1, 2, 3, 4, and 5. Mr. Reynolds.—*Fruit.* Gooseberries. Red: 1. Rough Robin, Mr. J. C. Wheeler; 2. Roaring Lion, T. Spencer, Esq.; 3. Crown Bob, Mrs. Westfaling; 4. Raspberry, Mr. J. C. Wheeler; 5. Champaign, Mrs. Westfaling. Green: 1. Green Ocean, T. Spencer, Esq.; 2. Nelson's Waves, Mr. Crump; 3. Smiling Beauty, C. Biss, Esq.; 4. Chissell's Green, Col. Money; 5. Rough Green, Miss Harvey. Yellow: 1. Scorpion, Mr. Crump; 2. Viper, T. Spencer, Esq.; 3. Hornet, Mrs. Webb; 4. Gunner, Mrs. Westfaling; 5. Small and Sweet, John Cooke, Esq. Grapes: 1. New Black Hamburgh, Mrs. Westfaling; 2. Hamburgh, Col. Money; 3. Muscadine, and 4. Sweetwater, Mrs. Westfaling; 5. Red Hamburgh, John Cooke, Esq. Melons: 1. Silver Rock, Mr. Reynolds; 2. Amacan, Mrs. Westfaling. Raspberries: 1. R. Compton, Esq.; 2. Col. Money; 3. Mrs. Webb; 4. Mrs. Westfaling; 5. Col. Money. Currants: 1. Mrs. Westfaling; 2. R. Compton, Esq.; 3. John Cooke, Esq.; 4. Rev. T. Underwood; 5. Col. Money. (*Hereford Journal*, July 29.)

NOTTINGHAMSHIRE.

*Newark Gooseberry Show.*—The Anniversary Show of this Society was held on August 6., when prizes were awarded as follows:—

*Gooseberries.* Heaviest of all colours. Red: 1. Roaring Lion, 21 dwts. 17 grs., William Swift; 2. Sir John, 21 dwts. 16 grs., Edward Rose; 3. Roaring Lion, 20 dwts. 22 grs., Thomas Gregg; 4. Huntsman, 19 dwts. 1 gr. William Swift. Yellow: 1. Gunner, 18 dwts. 3 grs., and 2. Sovereign, 16 dwts. 3 grs., Thomas Gregg; 3. Rockwood, 46 dwts. 2 grs., William Swift. Green: 1. Favourite, 16 dwts. 16 grs., William Swift; 2. Jolly Angler, 16 dwts., Thomas Gregg; 3. Independent, 14 dwts., 11 grs., William Swift. White: 1. Eagle, 19 dwts. 16 grs., and 2. Lady of the Manor, 17 dwts. 19 grs., Thomas Gregg; 3. Bonny Lass, 15 dwts. 17 grs. Least number to a lb.: 1. Roaring Lions, 16, T. Gregg; 2. Lions and Sir Johns, 18, E. Rose.—*Currants.* Fewest bunches to a lb.: thirty-seven bunches, Richard Cawkwell, Newark; one bunch, having twenty-one berries, weighed 9 dwts. 15 grs.—*Carnations.* 1. Scarlet Bizard, Lord Eldon; 2. Crimson Bizard, Rainbow, 3. Purple Flake, Commander, 4. Pink Flake, Seedling, and 5. Picotee, Cleopatra, G. Bowley, Nottingham. (*Newark Times*, Aug. 12.)

*Kirkgate Gooseberry Show.*—The Annual Show of this Society took place on August 6., Mr. Gilstrap in the chair, when prizes were awarded as follows:—

*Gooseberries.* Heaviest of all colours: Red Roaring Lion, 20 dwt. 1 gr., Mr. Chatwin, Muskham. Red: 1. Roaring Lion, 20 dwts. 1 gr. Mr. Egglestone, Newark; 2. Regent, 18 dwts. 5 grs., Mr. King, Newark; 3. Ploughboy, 16 dwts. 11 grs., and 4. Huntsman's Viper, 15 dwts. 16 grs., Mr. Chatwin, Muskham. Green: 1. Ocean, 17 dwts. 15 grs., and 2. Favourite, 16 dwts., Mr. Egglestone, Newark; 3. Angler, 14 dwts. 4 grs., Mr. Chatwin, Muskham; 4. Independent, 15 dwts. 8 grs., Mr. H. Fletcher, Muskham. White: 1. Rockwood, 16 dwts. 21 grs., Mr. H. Fletcher, Muskham; 2. Eagle, 16 dwts. 12 grs., Mr. King, Newark; 3. Cottage Girl, 14 dwts. 21 grs., Mr. Egglestone, Newark; 4. Viper, 14 dwts. 4 grs., Mr. Chatwin, Muskham. Yellow: Royal Gunner, 14 dwts. 20 grs. and 2. Governess, 14 dwts. 15 gr., Mr. H. Fletcher, Muskham; 3. Reformer, 15 dwts. 12 grs., Mr. Egglestone, Newark; 4. Bonny Lass, 13 dwts., Mr. King, Newark. Least number to a lb., 17, Mr. Egglestone, Newark.—*Carnations.* 1. Coxon's George the Fourth, 2. Welby's Duchess of Devonshire, and 3. Fletcher's Queen Caroline, Mr. W. Fletcher, Newark. Picotee: Lee's Robin Hood, Mr. H. Fletcher, Muskham. (*Newark Times*, Aug. 12.)

YORKSHIRE.

*Yorkshire Horticultural Society.*—This Society held its July Meeting on July 1., in the Festival Concert Room, which was arranged as usual. Four tables formed a square in the middle of the room, on which the fruits, flowers, and plants were set out; there was a fifth table at the bottom of the square, on which a gigantic bouquet was placed; and a sixth, in front of the gallery, was covered with culinary vegetables. Another table stood in front of the orchestra, at each end of which was placed a specimen of the *Cactus speciosissima* in flower; one from the garden of the Very Rev. Archdeacon Markham, and the other from that of N. Yarburgh, Esq., of Heslington; with several bouquets and stove plants; and there were two elegant pyramids of flowers on the table in the centre of the room, sent by S. W. Nicoll, Esq.; and one from the Rev. Archdeacon Markham's. Some fine stove plants, in pots, were placed in the passage leading to the gallery.

Amongst the plants we noticed the following, sent by J. Smith, Esq., Hunsigate. *Stove Plants:* *Maránta bicolor*; *Phrynium violaceum* (a very rare and beautiful plant, belonging to the class *Monándria*); *Cánna limbàta*; *Cánna coccínea*; *Gloxínia cauléscens* (a new and beautiful species); *Thunbérghia alàta*; *Clerodéndrum frágrans*; *Asclèpias curassávica* var. *álba*; *Calá-*

*dium* bicolor; *Xylophylla latifolia*; *Passiflora* (new hybrid); *Begonia argyrostigma*; and the *Phœnix dactylifera*, a fine and noble plant. *Green-house Plants*: *Passiflora cæruleo-racemosa*; *Maurândya Barclayana*, a beautiful climbing plant from Mexico, quite new, not yet inserted, we believe, in any catalogue; *Hæmáanthus puniceus* and *multiflorus*; *Sempervivum tabulæforme*; *Hûmea elegans*; and *Lýthrum alatum*. The following were from Messrs. T. and J. Backhouse: *Eccremocárpus scàber* (this beautiful climber lately introduced from South America, with its fine spikes of deep orange-coloured flowers and rapid growth, is likely to prove one of the greatest ornaments to our gardens); *Digitális minor*; *Cistus venústus*; *Verónica taúrica*; *Prímula scótica*; and *Spigèlia marylándica*, &c. Mrs. Archdeacon Markham, Mrs. Pickard, S. W. Nicoll, Esq., &c., also sent plants to ornament the room.

In the fruit department there were forty-one dishes of strawberries; twelve dishes of grapes, with pines, melons, peaches, nectarines, cherries, currants, gooseberries, preserved apples, &c.

The culinary vegetables consisted of remarkably fine cabbages, seven dishes of cauliflowers, four dishes of salads, five of cucumbers, three of potatoes, one of peas, together with turnips, onions, &c.

Amongst the flowers were a large basket of roses, sent by Mrs. Markham (in which were some beautiful specimens of the moss-rose); two trays of roses, from Messrs. Backhouse, containing 127 different kinds; several most beautiful single roses, which were shown for prizes; as well as some choice specimens of the ranunculus, pink, and georgina tribes. The chair was taken by the Rev. Danson R. Currer, and premiums were awarded as follows:—

*Plants.* Hardy: 1. *Eccremocárpus scàber*, Henry Baines; 2. *Spigèlia marylándica*, Joshua Brooks, gardener to Mrs. Pickard, Bootham. Stove: 1. *Cactus speciosíssima*, Anthony Smithers, gardener to the Very Rev. Archdeacon Markham; 2. *Phrynium violáceum*, James Hodgson, gardener to John Smith, Esq., of Hungate. Green-house: *Cotylèdon hemisphéricum*, Hen. Baines.—*Flowers.* Ranunculus. Dark: 1. *Caffre Royal*, and 2. *Rosney*, Mr. Thomas Wilson, York; 3. *Rosney*, Mr. Alexander Parker, York. Grey and Olive: 1. *Bishop von Lima*, Mr. A. Parker; 2. *Bouquet Sanspareil*, John Raby, gardener to Messrs. Backhouse, York; 3. *Quintin*, Mr. Thomas Wilson. Yellow and White Striped: 1. *Mignonne*, John Raby; 2. *Lanza Beauty*, Mr. Daglish of Myton. White and Yellow Selfs: 1. *Model of Perfection*, Mr. T. Wilson; 2. *Model of Perfection*, John Raby; 3. *Argus*, Mr. Godfrey Bean. Red Selfs: 1. *Conqueror of the Indies*, and 2. *Charlemagne*, Mr. Thomas Wilson; 3. *John Raby*. Spotted: 1. *Tendresse*, 2. *Julius*, and 5. *Ma délice*, Mr. A. Parker. Yellow and Red Striped: 1. *Mignonne*, Mr. T. Wilson. Purple-laced; 1. and 2. *Cleopatra*, and 3. *Bowes's Leicester*, Mr. T. Wilson. Red-laced: 1. *Bowes's Claudius*, Mr. W. Hardham; 2. *Bowes's Cardinal*, and 3. *Bowes's Eclipse*, Mr. T. Wilson. Plain Pinks: 1. *Davey's Eclipse*, Mr. T. Wilson; 2. *Davey's Eclipse*, Mr. A. Parker; 3. *Davey's Eclipse*, Mr. T. Wilson. Georginas. Single: 1. *Mr. Robert Hindsall of Elmsall*. 2. *Single Striped*, John Raby. Double: 1. *Luny*, John Raby; 2. *Camelliafflora*, Thomas Deuxberry. Bouquets. Hardy, H. Baines. Exotic: 1. *Thomas Appleby*; 2. *H. Baines*; 3. *Samuel Currie*. Best Collection of Roses, Messrs. Backhouse, for an assortment of one hundred and twenty different kinds. Best Roses: 1. *Tuscany*, and 2. *Tinwell Moss*, George Clarkson, Walmgate.—*Fruits.* Melon, Elias Hildyard, gardener to Sir Thomas Frankland. Pines: 1. *William Ashton*, gardener to B. Gaskell, Esq., of Thornes House; 2. *Joseph Benson*, gardener to Colonel Croft of Stillington. Grapes. White: 1. *Muscat*, James Brown, gardener to J. Hebblethwaite, Esq., Leeds; 2. *Muscat*, William Suttell; 3. *Muscat*, William Bunting, gardener to John Hutton, Esq., of Sobergate. Black: 1. *Hamburgh*, James Brown; 2. *Frontignac*, Thos. Appleby; 3. *Frontignac*, Thomas Cooper, gardener to R. S. Thompson, Esq., of Bilbrough. Peaches, William Ashton. Nectarines, Thomas Appleby,

Cherries, William Ashton. Currants, Charles Haigh. Apples, William Ashton. Strawberries: 1. King's Seedling, Joseph Benson; 2. Wellington Seedling, James Burnett, gardener to H. J. Baines, Esq., Bell Hall; 3. Keen's Seedling, T. Walker; 4. Keen's Seedling, William Amys; 5. Roseberry, J. Ricketts of Bishopthorpe; 6. Roseberry, Messrs. Backhouse. — *Culinary Vegetables*. Onions: 1. David Empson, gardener to R. Swann, Esq., of Askham; 2. John Sharples, gardener to T. Price, Esq.; 3. Charles Haigh of Bishopthorpe. Peas, C. Suffield, of Bishopthorpe. Potatoes: 1. Thomas Appleby, gardener to the Rev. J. A. Rhodes, Horsforth Hall; 2. T. Walker, gardener to the Rev. D. R. Currer. Carrots, S. Currie, gardener to J. Ingham, Esq., Mirfield. Cabbages, William Amys, gardener to J. Walker, Esq., of Sandhutton. Lettuces: 1. John Sharples; 2. Thomas Appleby. Cucumbers: 1. H. Baines, gardener to Messrs. Backhouse; 2. William Suttell, gardener to William Garforth, Esq., of Wiganthorpe; 3. Thomas Walker. Cauliflowers: 1. and 2. Thomas Deuxberry, gardener to H. Preston of Moreby, Esq.

Though no prize was advertised for geraniums, the Council awarded prizes to H. Baines, for his *De Vere*, and to Mr. A. Parker, for his *Humei*, in consequence of their excellence. As there was great difficulty in deciding between the white grapes furnished by William Suttell, and a dish of the Tokay kind, furnished by William Bunting, gardener to J. Hutton, Esq., of Sobergate, a premium was also awarded to the latter. A premium was also awarded to the roses already mentioned, from Mrs. Archdeacon Markham's, which in the first instance escaped the notice of the judges, owing to the gardener having mixed the very valuable sorts contained in the collection with some of a common description, omitting to state that there were some very rare specimens in the basket. The premium for the second best white grapes would have been awarded to William Cooper, gardener to the Rev. R. S. Thompson of Bilbrough, but he only produced one bunch; and the rules of the Society require that not less than two shall be offered for a prize. A prize was awarded to James Hodgson, gardener to John Smith, Esq., for ornamenting the room. The Chairman expressed the thanks of the Council to the ladies and gentlemen who had sent bouquets and plants, particularly to Mrs. Markham, Mrs. Pickard, N. Yarbrough, Esq., S. Nicoll, Esq., J. Smith, Esq., and Messrs. Backhouse; Also, to the Rev. J. A. Rhodes, for two dishes of grapes presented to the Society. Mr. E. S. George, one of the secretaries, then read the list of the officers and council for the ensuing year; the Rev. J. A. Rhodes was elected President; Mr. Price and Mr. Wolstenholme, Curators; and Dr. Belcombe, Robert Denison, Esq., John Hutton, Esq., Henry Preston, Esq., Thomas Smith, Esq., and R. J. Thompson, Esq., the York Committee. The Secretary also announced, that the next Meeting would be held on the 5th of August, at Leeds. Thanks having been voted to the Chairman, the Meeting broke up. The Judges for the Fruit and Vegetables were, Col. Croft, Thomas Price, Esq., Mr. Alderman Smith, Mr. E. S. George, and Mr. H. Baines, Judges for the Flowers, the Rev. W. Hinckes, Mr. Bulmer, and Mr. H. Mills.

We cannot help remarking that the number of prizes awarded to the ranunculuses and pinks was greatly out of proportion to the whole number distributed; particularly when it is considered that there is a Florists' Society in York (and in many other places), expressly for competition in flowers only. We would suggest that in future the prizes of this description should be greatly curtailed in number, and that more should be awarded for stove and green-house plants. The meetings of the Society should not degenerate into mere flower shows; but every encouragement should be given to the cultivation and production of rare plants, fruits, and vegetables, in preference to, though not to the exclusion of, flowers; the cultivation of which is promoted by other Societies, which do not aim at a higher object. (*Yorkshire Gazette*, July 4.)



The Summer Meeting of the *Yorkshire Horticultural Society* was held on August 5. For the decorations of the room the Society was greatly indebted to Christopher Rawson, Esq., of Halifax, who sent a variety of rare and beautiful plants, as well as one of the most splendid bouquets we ever witnessed. The Rev. J. A. Rhodes contributed, in pot, a fine pine, the foliage of which was most healthy and luxuriant, and we regret extremely that neither our time nor space will allow us to do justice to the numerous other gentlemen and gardeners who did so much towards the ornamental part of the exhibition, and which could not fail to be highly gratifying to all who witnessed it. A little after two o'clock, the Rev. J. A. Rhodes, of Horsforth Hall, was called to the chair, and awarded the prizes as follows :—

*Plants.* Stove : 1. Thomas Appleby ; 2. J. Menzies, gardener to Christopher Rawson, Esq., Halifax ; 3. Thomas Appleby. Green-house : 1. 2. and 3. T. Appleby. Hardy : 1. J. Menzies, gardener to C. Rawson, Esq. ; 2. Thomas Appleby ; 3. and 4. J. Menzies. — *Flowers.* Carnations. Scarlet Bizards : 1. William Riley, Leeds ; 2. John Gill, Wakefield ; 3. William Woodhead, Halifax. Pink Bizards : 1. William Riley ; 2. William Woodhead ; 3. James Spence. Purple Flakes : 1. and 2. Benjamin Ely ; 3. James Spence. Scarlet Flakes : 1. John Gill ; 2. Benjamin Ely ; 3. William Riley. Pink Flakes : 1. J. Spence ; 2. J. Gill ; 3. J. Spence. Purple Picotees : 1, 2. and 3. Benjamin Ely. Scarlet Picotees : 1. and 2. William Riley ; 3. Benjamin Ely. Seedlings : Scarlet Bizard, William Woodhead. Pink Bizard, J. Spence. Scarlet Flake, William Riley. Scarlet Picotee, William Pickersgill. Purple Picotee, William Woodhead. Georginas. Double Dark : 1. H. Baines, York ; 2. William Morris, gardener to Mr. Clarkson, York ; 3. John Paget, gardener to F. Payley, Esq. Double Scarlet : 1. William Morris ; 2. H. Baines ; 3. John Paget. Single Scarlet : 1. John Kearsley ; 2. Joshua Marshall. Single Purple, John Kearsley. Hardy Bouquets : 1. J. Menzies ; 2. William Clarke. — *Fruit.* Pine. Best flavoured, Thomas Appleby, gardener to the Rev. J. A. Rhodes ; largest, Thomas Appleby. Grapes. White : 1. James Brown, gardener to J. Hebblethwaite, Esq. ; 2. S. Currie, gardener to Joshua Ingham, Esq., of Blake Hall. Black : 1. W. Reynolds, gardener to Edward Armitage, Esq., Farnley Hall ; 2. J. Deuxberry, gardener to Abram Rhodes, Esq. Seedling, T. Appleby. Melons : 1. John Southward, gardener to James Armitage, Esq., Cookridge Hall ; 2. James Brown, gardener to John Hebblethwaite, Esq. Apricots, W. Ashton, gardener to B. Gaskell, Esq., Thornes House. Peaches, Joseph Moore, gardener to T. B. Pease, Esq. Nectarines, Joseph Moore. Plums and Cherries, Wm. Ashton. Apples, eating, Wm. Clarke of Rodney ; baking, the gardener of Wm. Hadfield, Esq., Wakefield. Strawberries, J. Southward. Currants : 1. gardener to Wm. Hadfield, Esq. ; 2. J. Moore ; 3. Mrs. Kennedy, North Hall. Gooseberries : 1. William Clarke ; 2. Mr. Hicks, Benningbro' ; 3. J. Marshall, of Rothwell Haigh, nurseryman. Sorts, John Kearsley, market-gardener, who exhibited the astonishing number of 151. — *Culinary Vegetables.* Celery and Turnips, S. Currie. Artichokes, gardener to E. Birchall, Esq. Cucumbers : 1. H. Baines, gardener to Messrs. Backhouse of York ; 2. gardener to E. Birchall, Esq. ; 3. Holding, gardener to — Brown, Esq. of Mirfield. Vegetable Marrow, S. Currie. Peas, Wm Appleby. Onions : 1. John Royel, gardener to W. F. Paley ; 2. and 3. Mr. Thomas Abbot of Knaresbro'. Kidneybeans, Thomas Appleby. Lettuce, J. Deuxberry. Cabbages : 1. gardener to Edwin Birchall, Esq. ; 2. Wm. Clarke ; 3. T. Appleby.

The Chairman, in distributing the prizes, drew largely upon that fund of humour and knowledge of horticulture, which he is well known to possess ; and addressed the successful competitors, in such a way as was calculated to suppress any improper feelings of triumph, and at the same time, to console those who had experienced a defeat. He was loudly applauded on

vacating the chair, when a vote of thanks was proposed by the Rev. Samuel Sharp (vicar of Wakefield), and carried by acclamation.

Judges of Fruits and Vegetables: Mr. Wm. Pontey, Kirkheaton; Mr. Wm. Baines, gardener to F. H. Fawkes, Esq., of Farnley Hall; Mr. James Jameson, gardener to Lady Beckett of Gledhow; and Mr. Duncan Macdonald, gardener to Colonel Tempest of Tong Hall. Carnations and Pico-tees: Mr. John Rhodes; Mr. Joseph Barstow; and Mr. Edward Fletcher. Flowers: Mr. Holland of Leeds, and Mr. Baines of York.

The following is a list of the rare and beautiful plants exhibited by the gardener of Christopher Rawson, Esq., of Halifax:—*Pentstemon diffusum* (this obtained the first prize for the hardy plants), *atropurpureum*, and *roseum*; *Gesneria bulbosa* (this obtained the second prize for the stove plants); *Eccremocarpus scaber*; *Gilia capitata*; *Lobelia senecioides*; *Phlox triflora*, *penduliflora*, and *corymbosa*; and *Lilium penduliflorum*. (*Leeds Intelligencer*, Aug. 6.)

*York Florists' Society*. — On July 7. the Ancient Society of York Florists held their Annual Show of Pinks and Roses in Petergate. The prizes were adjudged as follows:—

*Pinks*. Dark and Purple-laced: 1. Westlake's Hero, and 2. No. 44., Mr. Summer; 5. Hardman's Perfection, Mr. Wilson; 4. Bowes's Claudius, Mr. Summer; 5. Bowes's Claudius, Mr. W. Hardman. Scarlet and Red-laced: 1. Gordon's George the Fourth, Mr. Wilson; 2. Turner's Princess Charlotte, 3. No. 64., 4. No. 14., and 5. No. 4., Mr. Summer. Plain or unlaced: 1. Davey's Eclipse, Mr. Wilson; 2. Williamson's Prince of Wales, Mr. W. Hardman; 3. Williamson's Prince of Wales, Mr. Wilson; 4. No. 15., and 5. No. 45., Mr. W. Hardman. — *Double Roses*. Coloured: 1. Sultan, and 2. Rose des Ranoncles, Mr. Parker; 3. Kutusoff, Mr. Wilson. White: 1. Rose Unique, and 2. No. 33., Mr. W. Hardman; 3. Rose Unique, Mr. Summer. (*Yorkshire Gazette*, July 11.)

*Hull Floral and Horticultural Society*. — The Fourth Meeting this season was held on July 7., for the exhibition of Pinks, Roses, Bouquets, and Strawberries. The display of pinks was numerous, and consisted of the choicest kinds, many of which were of a new variety, and far superior to any ever exhibited by this Society. The roses were less attractive and fine than on former occasions. Several of the strawberries were of an extraordinarily large size. The show, upon the whole, was of a more interesting character than any which preceded it. The judges were Messrs. James Carr, Thomas Lambert, and J. R. Lumb.

*Premium*. Bowes's Lustre, Mr. Burman. — *Pinks*. Purple-laced: 1. Bowes's Lustre, Mr. Burman; 2. Bowes's Cato, Mr. Wharton; 3. Bowes's Suwarrow, Mr. Burman; 4. and 5. Bowes's Lustre, Mr. Wharton; 6. Suwarrow, Mr. Burman. Black and White: 1. Davey's Eclipse, Mr. Norman; 2. Davey's Eclipse, Mr. C. Lambert; 3. Bray's Incomparable, Mr. Norman; 4. Cupid, Mr. Deighton; 5. Wellington, Mr. Norman; 6. Bates's Freeholder, Mr. C. Lambert. Red-laced: 1. Bowes's Cato, Mr. Beecroft; 2. Brooks's Eclipse, Mr. Smithson; 3. Cowper's Cubit, Mr. Beecroft; 4. Bates's Favourite, Mr. Allinson; 5. Bowes's Miss Foote, Mr. Burman; 6. Bowes's Suwarrow, Mr. Wharton. Semi-double: 1. Bowes's Cato, Mr. Wharton; 2. Lustre, 3. Prince Leopold, and 4. Verona, Mr. Allinson; 5. Thesedia, and 6. Facista, Mr. Norman. Seedling, Mr. Norman. *Roses*. Moss: 1. Venus (single), Mr. Wadsworth; 2. double white, and 3. red, Mr. Robson; 4. red, Mr. Allinson; 5. red, Mr. Norman; 6. red, Mr. Robson. Plain: 1. Duke of York, Mr. Robson; 2. Maiden Blush, Mr. Wadsworth; 3. Lady Hill, Mr. Allinson; 4. Duchess of St. Albans, Mr. Wadsworth; 5. Grand Duke of Tuscany, Mr. Allinson; 6. Grand-duchess of Tuscany, Mr. Wadsworth. — *Bouquets*. 1. Mr. Robert Oglesby; 2. Mr. Wadsworth; 3. Mr. G. Wharton; 4. Mr. Smithson. — *Strawberries*. 1. Lord Wellington, Mr. Robson; 2. Wilmot's Superb, Mr. Wadsworth; 3. and 4. Keen's

Seedling, Mr. Voase; 5. Wilmot's Superb, Mr. Wadsworth; 6. Sykes's William Pitt, Mr. Wharton. (*Hull Advertiser*, July 10.)

*Bedale Horticultural Society.* — At the General Meeting of this Society, held at Bedale on the 26th of June, prizes were awarded as follows: —

*Geranium.* Macranthon, Mr. Elsworth. — *Pinks.* Purple-laced: 1. Bowes's Cato, Mr. Hewson; 2. Bowes's Cardinal, Mr. May; 3. Bowes's Suwarrow, Mr. Elsworth; 4. Miss Georgiana Beresford, Mr. Hewson; 5. Mr. W. Mafham; 6. Bowes's Suwarrow, Mr. Hewson. Red-laced: 1. Bowes's Rosanna, Mr. W. Mafham; 2. Cotton's George the Fourth, Mr. May; 3. Cotton's George the Fourth, Mr. Hewson; 4. Bowes's Claudius, Mr. W. Mafham; 5. Bowes's Rosa, and 6. Cotton's George IV., Mr. Caven. Plain: 1. Bowes's Premier, 2. Rushton's Beauty of Flora, and 3. Davey's Victorious, Mr. May; 4. Davey's Eclipse, Mr. Caven; 5. Black Baguet, Mr. Hewson; 6. Bowes's Premier, Mr. Mafham. Seedling, Mr. Hewson. — *Ranunculuses.* Dark and Purple: 1. Bishop Von Lima, 2. Viriat, 3. Nakapa, 4. Quintus, 5. Rosney, and 6. Condorcet, Mr. Weatherald. Striped: 1. Mélange des Beautés, 2. Monument of China, and 3. La Temeraire, Mr. Weatherald; 4. Passe la Cour de France, Mr. Hewson; 5. Favorite Mignonne, Mr. Weatherald; 6. Monument of China, Mr. Hewson. Spotted, Mottled, and Edged: 1. La Tendresse, Mr. Hewson; 2. La Tendresse, 3. Pucella, and 4. Quilla Folia, Mr. Weatherald; 5. Thompson's Queen, Mr. Elsworth; 6. Julius, Mr. Hewson. White and Yellow Selfs: 1. Model of Perfection, Mr. Elsworth; 2. Skiddaw, 3. Countess of Exeter, and 4. Director-General, Mr. Hewson; 5. Model of Perfection, and 6. Skiddaw, Mr. Weatherald. Rose, Red, and Crimson Selfs: 1. Domitian, 2. Fontenoy, and 3. Adonis, Mr. Wetherald; 4. Aurora, Mr. Hewson; 5. Domingo, Mr. Weatherald; 6. Flaccus, Mr. Hewson. — *Strawberries.* 1. Taylor's New Emperor, and 2. Keen's Seedling, Mr. Caven; 3. Scarlet, Mr. Hewson. — *Cherries.* 1. Mayduke, Mr. Hewson; 2. Mayduke, Mr. Donass; 3. Mayduke, Mr. W. Harker. (*Yorkshire Herald*, July 4.)

*The Ripon Horticultural Society.* — This Society held their Second Meeting this season in Ripon, on June 27., Colonel Dalton of Sleningford Hall in the chair, when prizes were awarded as follows: —

*Plants.* Geraniums. Scarlet Ground: 1. Lord Lynedoch, Mr. Cuthbertson; 2. Ferònia, Mr. May. White Ground: 1. Macranthon, Mr. G. Grayson; 2. Macranthon, Mr. J. Binn. Purple Ground: 1. and 2. Seedlings, Mr. Cuthbertson. Rarest Exotic, *Calceolària purpùrea*, Mr. May. Hardy Bouquet, Mr. May. — *Flowers.* Ranunculuses. Dark: 1. Bravura, Mr. Wetherald; 2. and 3. Violet Fonce, Mr. Bateman. Purple and Grey: 1. Viriat, Mr. Wetherald; 2. Mr. Bateman; 3. Quintus, Mr. Wetherald. Olive: 1. Cox's Buff, Mr. Reed; 2. Mr. Abbot; 3. Orange Brabancon, Mr. Reed. Spotted: 1. Princess of Wurtemberg, Mr. Reed; 2. and 3. Mr. Abbot. Edged: 1. and 2. Mr. Bateman; 3. Mr. Banning. Striped: 1. Le Mélange des Beautés, 2. Surpass le Mélange des Beautés, and 3. Mr. Bateman. Selfs: 1, 2, and 3. Mr. Bateman. Pinks. Purple-laced: 1. Bowes's Suwarrow, Mr. T. Harrison; 2. Bowes's Cardinal, Rev. H. Chaloner; 3. Bowes's Cato, Mr. May. Selfs: 1. Fulbrooke's Beauty, Mr. May; 2. Chetwin's Beauty, Mr. Banning; 3. Bowes's Premier, Mr. Chaloner. Red-laced: 1. Bowes's Cato, Mr. T. Harrison; 2. Bowes's Rosa, Mr. J. Binn; 3. Cotton's George the Fourth, Mr. May. Pan of Roses: 1. Captain Smith; 2. Mr. May; 3. John Reed, gardener to T. K. Stavely, Esq., Old Sleningford. — *Fruit.* Pine, Mr. Cuthbertson, gardener to Mrs. Lawrence of Studley Park. Melon: 1. Richard Lacey, Esq., of Cayton Hall; 2. Mr. Daglish, gardener, Myton. Grapes: 1. Mr. Dauriss, gardener to Mark Milbank, Esq., of Thorpe Hall; 2. Mr. Cuthbertson. Cherries: 1. Christopher Whytell, gardener to Thomas Mason, Esq., of Copt Hewick; 2. Mr. Thomas Harrison, Ripon. Strawberries: 1. Mr. Cuthbertson; 2. Mr. Lumley, gardener, Hay Park, near Knaresborough; 3. Mr. Daglish. — *Culinary Vegetables.* Cucumbers: 1. Mr.

Daglish; 2. James Middlemist, gardener to Colonel Dalton. Cauliflowers : 1. Mr. Cuthbertson; 2. Christopher Whytell. Potatoes : kidney, Mr. Lumley; round, George Whitton, gardener, Aiskew, near Bedale.

Judges. For Plants and Flowers : John Hill, Esq., Richard Lacey, Esq., and Mr. G. Grayson. For Fruit and Vegetables : William Morton, Esq., Mr. May, and Mr. Banning.

Amongst the plants which decorated the show-room were the following : *Lilium longiflorum*, *Calceolaria integrifolia* var. *angustifolia*, *Petunia nyctaginiflora*, &c., exhibited by Mr. Cuthbertson; a splendid bloom of the new plant *Gœum coccineum*, also a beautiful hardy bouquet, by Mr. Idle, gardener to John Yorke, Esq., of Bewerley Hall; a fine bouquet of white moss roses, of about 20 blooms, gathered from one plant, which covers a wall 12 ft. high for the length of 3 yards, and is supposed to be one of the oldest and finest plants in the kingdom, shown by Colonel Dalton's gardener; *Calceolaria purpurea*, *rugosa*, and *integrifolia*, *Mimulus luteus* var. *rivularis*, *Didymocarpus Rhœxi*, and also a magnificent exotic bouquet, 10 ft. high, &c., exhibited by Mr. May; and also an exotic bouquet, shown by Mr. Weatherald.

The Chairman called attention to the superiority of the cucumbers and cauliflowers. The strawberries were deserving of much notice, particularly the first prize dish, one strawberry of which measured full 6 in. in circumference, and several others were nearly of the same magnitude. The first prize melon, which was grown in a forcing-pit, the invention of Mr. Lacy, afforded a further instance of the advantages of his plan. (*Yorkshire Gazette*, July 4.)

#### DURHAM.

*The Botanical and Horticultural Society for the Counties of Durham, Northumberland, and Newcastle upon Tyne.*—A Branch General Meeting was held at Alnwick on July 10., when the following prizes were awarded :

For the best-flavoured pine (Queen), the silver medal, to Ralph Naters, Esq., Sandyford House. This was a most beautiful fruit, and was produced upon a plant only one year old. For the best-flavoured melon, best dish of grapes, best bouquet of China roses, and best bouquet of flowers, silver medals, to Mr. McLeish, gardener to A. J. Cresswell Baker, Esq., of Cresswell Hall. For the best dish of strawberries, the silver medal, to Mr. Balfour, gardener to the Right Hon. Earl Grey, Howick House. For the best dish of cherries, the silver medal, to Mr. Lowrey, gardener to Ralph Riddell, Esq., Felton Park. For the best double ranunculus (Coquelicot), the silver medal, to Mr. Wm. Newton, gardener, Alnwick. For the second-best ranunculus, the bronze medal; and for the best exotic plant in flower (*Cactus speciosa*), and the best 12 double roses, silver medals, to Mr. Oliver, gardener to the Hon. H. T. Liddell, M.P., Eslington House. For the best pink, the silver medal, to Mr. Scott, gardener to Edward Charlton, Esq., Sandoe. There were some very fine seedling strawberries, named the Broome Park Seedling and the Lass of Glenshey, and also two fine seedling pinks, and a number of seedling myrtles, grown in the open ground, exhibited by Mr. Allan McPherson, gardener to Wm. Burrell, Esq., of Broome Park. (*Newcastle Courant*, July 18.)

#### LANCASHIRE.

*Manchester Floral and Horticultural Society.*—The Fourth Meeting of this Society was held on August 5., for the exhibition of carnations, georginas, and the various fruits and vegetables of the season. Notwithstanding the unfavourable weather, which had prevailed for some time previous to the Meeting, and which had retarded the blowing of many choice specimens, the show of flowers, and particularly of carnations, was extremely good, though not quite so large as on former occasions. Prizes were awarded as follows :—

*Plants.* Stove: 1. *Curcuma Amada*, Charles Wood, Esq.; 2. *Ardisia so-laifæa*, Mrs. Hobson. Green-house: 1. *Fúchsia grácilis*, James Ramsbotham, Esq.; 2. *Crássula coccínea*, Mrs. Hobson. Hardy: *Azàlea viscòsa*, Charles Wood, Esq. Ericas: 1. and 2. Richard Potter, Esq.; and extra-prizes were adjudged to Thomas Heywood, Esq., R. W. Barton, Esq., Richard Potter, Esq., Mr. William Bow, and Mr. J. Darbyshire (who received two prizes). Geraniums: 1. Richard Potter, Esq.; 2. James Ramsbotham, Esq. Orange tree in bearing, G. R. Chappell, Esq. — *Flowers.* Bizards: Scarlet, Mr. S. Hall; Pink, Mr. Wakefield. Flakes: Scarlet, Mr. James Booth; Purple, Mr. Leighton; Rose, Mr. Whittaker. Picotees: Purple-striped, Mr. H. Thomas; Feathered, Mr. Faulkner; Red-striped, Mr. C. Lee; Purple-feathered, Mr. Buckley. Georginas. Double: 1. Rev. J. Clowes; 2. Nathaniel Philips, Esq.; 5. Mr. William Skirving. Single: 1. Mr. James Smith; 2. Mr. William Bow; 3. Mr. John Alcock. Basket of Flowers, Richard Potter, Esq. — *Fruit.* Pines: 1. Edward Lloyd, Esq.; 2, 3, and 4. Richard Potter, Esq. Grapes: 1. Peter Marsland, Esq.; 2. Charles Wood, Esq. Peaches: 1. Mrs. Hobson; 2. Edward Lloyd, Esq. Melons: 1. Mr. Lane; 2. James Darbyshire, Esq. Nectarines: 1. Earl of Wilton; 2. Rev. J. Clowes. Plums: 1. Mr. R. Smith; 2. Mr. C. Walker. Pears, John Moore, Esq. Apples: 1. C. Walker, Esq.; 2. T. H. Hadfield, Esq. Extra-prize for some very fine apples of last year's growth, Mrs. Smith. Raspberries: White, R. W. Barton, Esq.; Red, N. Philips, Esq. Currants: Black, Mr. C. Moore; White, Thomas Knight, Esq.; Red, C. Wood, Esq. Gooseberries. Best dish: White and Yellow, Mr. P. Dean; Red and Green, Mrs. Smith. Premier prize for single: Red Roaring Lion, weighing 21 dwts. 17 grs., Mrs. Smith; White, 18 dwts. 4 grs., Mr. Thomas Slater; Yellow, 16 dwts. 12 grs., T. H. Hadfield, Esq.; Green, 16 dwts. 11 grs., Mrs. Smith. — *Culinary Vegetables.* Dish of Peas, Robert Tebbutt, Esq. Celery: 1. Lionel Lloyd, Esq.; 2. G. R. Chappell, Esq. Onions, Mr. Thomas Thorpe. Cabbage, Mr. C. Walker. Kidneybeans, R. W. Barton, Esq. Vegetable Marrow, Mr. Edward Taylor, Oldfield Lane. (*Manchester Guardian*, Aug. 8.)

*Liverpool Floral and Horticultural Society.* — The Summer Show of carnations, green-house and stove plants, fruits, &c., of this Society, was held on July 31., and was numerous and fashionably attended. Carnations and georginas formed the most prominent part of the show. The pines, grapes, nectarines, &c. were extremely fine, and the loaded benches gave ample proof that nature's choicest productions were not wanting to give *eclat* to an exhibition which has taken so great and so just hold of public attention. Prizes were awarded as follows:—

*Plants.* Stove: 1. *Crinum amabile*, Mr. G. Cunningham; 2. *Cùphea Melvìlla*, Mr. Skirving; 3. *Hedýchium Gardnerianum*, Thos. Case, Esq. 1. *Crinum cruéntum*, Mr. Richard Harrison; 2. *Ixòra coccínea*, H. B. Hollinshead, Esq.; 3. *Thunbérghia alàta*, Mr. Powell; 4. *Gloxínia hirsùta*, Mr. R. Harrison; 5. *Gloxínia cauléscens*, Mr. Cunningham; 6. *Poinciana pulchérima*, Mr. Powell; 7. *Cactus speciosus*, Mr. Smith; 8. *Erythrina cristagalli*, Mr. T. Davis. Green-house: 1. *Fúchsia coccínea*, Mrs. Edward Cropper; 2. *Maurándya Barclayana*, and 3. *Fúchsia grácilis*, Mr. Skirving; 4. *Fúchsia coccínea*, Mr. Cunningham; 5. *Maurándya Barclayana*, Mrs. Rathbone; 6. *Fúchsia grácilis*, Mr. Lowe; 7. *Crássula coccínea*, and 8. *Clèthra arborea*, Mr. S. Woodhouse; 9. *Lagerstræmia índica*, Mr. Powell; 10. *Phytolácca decándra*, T. Case, Esq.; 11. *Streptocárpus Rhéxi*, Mr. Horsfall. Herbaceous: 1. Mr. Smith, Fulwood; 2. and 3. Mr. Davis; 4. Mr. Powell; 5. Mr. Skirving; 6. Mr. Smith, Fulwood. Hardy Shrubs: 1. *Eccremócárpus scàber*, Mr. Skirving; 2. *Hydránga horténsis*, Mr. T. Walker; 3. *Azàlea álba*, H. B. Hollinshead, Esq. Pelargoniums: 1. Victory, H. B. Hollinshead, Esq.; 2. Germanicus, and 3. Dennis's Royal, Mr. Skirving; 4. Tricolor, and 5. Pelargonium, Mr. T. Davis; 6. Spectá-

bilis, Mr. C. Lawrence. Ericas : 1. Ampullæca, Mr. Whalley ; 2. Irbyàna, Mr. Davis ; 3. Jasminiflora, Mr. Whalley ; 4. Ventricosa, Mr. H. Wilson ; 5. Savileana, Mr. Whalley ; 6. Aitonia, Mr. Davis. Orange tree, Mrs. Rathbone. Basket of Plants : 1. T. Davis ; 2. Mr. Whalley ; 3. T. Davis ; 4. W. Earle, Esq. — *Flowers*. Premier Prizes : 1. Foxhunter, Dr. Franklin, Lord Anson, Miss Foote, Princess Charlotte, Will Stukely, and Unknown, Mr. Gandy ; 2. four Seedlings, Lady Hood, Queen Charlotte, and Cleopatra, Mr. Wakefield, Manchester ; 3. Triumphant, Rainbow, Seedling, Lady Hood, Queen Charlotte, Lady Chatham, and Incomparable, R. F. Buckley, Esq., Chester. Bizards. Scarlet : 1. Seedling, Mr. Large, Prescott ; 2. Roby's Salamander, Wm. Leighton, Esq., Preston ; 3. Seedling, Mr. B. Bruce ; 4. Seedling, Mr. Wakefield ; 5. Wild's Pass Perfection, Mr. Roby, Prescott ; 6. Foxhunter, W. Leighton, Esq. ; 7. Charles the Tenth, Mr. Faulkner, Manchester ; 8. Birtle's Commander, Mr. B. Bruce. Pink or Crimson : 1. Rainbow, 2. Seedling, and 3. King Alfred, Mr. Wakefield ; 4. Summit of Perfection, Mr. Leighton, Preston ; 5. Seedling, Squire Trafford, Mr. Buckley, Chester ; 7. Prince Leopold, Mr. Appleton ; 8. Chance, Mr. Leighton. Flakes. Scarlet : 1. Atlas, Mr. Leighton ; 2. Unknown, Mrs. E. Cropper ; 3. Seedling, Mr. J. Smith, Devonshire Place ; 4. Seedling, Mr. Wakefield ; 5. George the Fourth, Mr. Leighton ; 6. Duke of Rutland, Mr. B. Bruce ; 7. Seedling, Mr. Lowe ; 8. Madam Mara, Mr. Powell. Pink : 1. Miss Foote, 2. Sir George Crewe, and 3. Supreme, Mr. Leighton ; 4. Lady Hood, Mr. Buckley ; 5. Eliza, Mr. Wakefield ; 6. Seedling, Mr. Thomas Roby ; 7. Seedling, W. Large ; 8. Lord Essex, Mr. Leighton. Purple : 1. Queen Charlotte, Mr. Leighton ; 2. Alfred the Great, Mr. Wakefield ; 3. Major Cartwright, Mr. Buckley ; 4. Mary Anne, Mr. Wakefield ; 5. Minerva, Mr. Leighton ; 6. Bates's Wellington, and 7. Seedling, Mr. Appleton ; 8. Smith's Fair Ellen, Mr. W. Range. Picotees. Red-feathered : 1. Seedling, Mr. Wakefield ; 2. Sir R. Peel, Mr. Faulkner ; 3. Will Stukely, Mr. Wakefield ; 4. Seedling, Mr. T. Roby ; 5. Seedling, Number Thirty-three, Mr. Buckley ; 6. Queen Caroline, Mr. Gandy. Red-striped : 1. Chilwell Beauty, Mr. T. Roby ; 2. Seedling, Mr. Potter ; 3. Seedling, Mr. Faulkner ; 4. Seedling, Mr. W. Large ; 5. Seedling, Mr. T. Harrison, West Derby ; 6. Salamander, Mr. Faulkner. Purple-striped : 1. Taylor's Lord Nelson, Mr. Wheeler ; 2. Mary Anne, Mr. Potter ; 3. Mumford's Lord Nelson, Mr. B. Bruce ; 4. Seedling, Mr. Potter ; 5. Seedling, Mr. Carter ; 6. Mumford's Lady Nelson, Mr. Buckley. Purple-feathered : 1. Lee's Cleopatra, Mr. Wakefield ; 2. Pearson's Lad, Mr. B. Bruce ; 3. Florentine, and 4. Hannibal, Mr. J. Faulkner ; 5. Mason's Wellington, Mr. B. Bruce ; 6. Charlotte, Mr. Gandy. Maiden Growers. Bizards : Scarlet, Sir James Boughey, Mr. J. Leigh ; Pink, Unknown, Mr. J. Thompson. Flake : Scarlet, Queen, Mr. J. Thompson ; Pink, Unknown, Mr. J. Thompson ; Purple, Unknown, Mr. J. Leigh. Picotees : Red, Unknown, Mr. J. Thompson ; Red-striped, Mr. S. Colquitt ; Purple, Mason's Wellington, Mr. J. Thomson ; Purple-striped, Mr. J. Leigh. Georginas. Double : 1. Sovereign, Messrs. Dickson ; 2. Scarlet Turban, and 3. Kentish Hero, Mr. G. Cunningham ; 4. Triumphant, Mr. Powell ; 5. Black Turban, Mr. Skirving ; 6. Yellow, Mr. Powell. Best Pan, Mr. Skirving. Single : 1. Mr. Whalley ; 2. Mr. G. Cunningham ; 3. Mr. Skirving ; 4. Mr. G. Cunningham ; 5. Mr. Powell ; 6. Mr. Wheeler. Basket of Cut Flowers : 1, 2, and 3. Mr. Whalley ; 4. W. Earle, Esq. — *Fruit*. Pines : 1. Antigua, Mr. T. Davis ; 2. Jamaica, and 3. Enville, Mr. Potter, Manchester ; 4. Providence, Mr. Powell. Melons : 1. Cantaloup, Mr. Whalley ; 2. Rock, Mr. T. Booth ; 3. Antigua Nutmeg, T. Case, Esq. ; 4. Unknown, Mr. Smith, Fulwood. Peaches : 1. Noblesse, Mr. Colquitt ; 2. Yellow Alberge, Mrs. Rathbone. Nectarines : 1. Murray, and 2. Brugnion, Mr. Colquitt ; 3. White, Rev. R. Gwillym. Apricots : 1. and 2. Moor Park, H. B. Hollinshead, Esq. ; 3. Orange, Mr. Tayleur. Figs, Mr. Cooke, Millbank. Grapes. Black : 1. and 2. Ham-

burgh, Mr. Preston; 3. Damascus, W. Earle, Esq. White: 1. Muscat, Mr. Tayleur; 2. Muscat, H. B. Hollinshead, Esq.; 3. Frontignac, Rev. R. Gwilym. Currants: Black, Mr. Whalley; White, Mr. Walker; Red, Mr. Whalley. Cherries: 1. Mrs. Rathbone; 2. Mr. Roskell. Apples: 1. June-cating, Mr. H. Wilson; 2. Margarett, Mr. Roskell; 3. Summer Pippin, Mr. A. Yates. Pears: 1. Citron, Mr. Manifold; 2. Citron, Mr. Powell; 3. Early Spring, Mr. Manifold. Gooseberries. Heaviest ripe Red, Sportsman, Mr. Skirving. Red: 1. Roaring Lion, Mr. Whalley; 2. Huntsman, Mr. Skirving; 3. Mr. Leighton. Heaviest ripe Yellow, Sovereign, Mr. Appleton. Yellow: 1. Rockwood, Mr. Skirving; 2. Mr. Range; 3. Mr. C. Logan. Heaviest ripe Green: Premier Prize, Gunner, Mr. Skirving. Green: 1. Greenwood, Mr. Whalley; 2. Ocean, and 3. Wainman's Ocean, Mr. Skirving. Heaviest ripe White: Premier Prize, Eagle, Mr. John Appleton. White: 1. Mr. Skirving; 2. Scholefield's Royal, Mr. W. F. Porter; 3. Gunner, Mr. Skirving.—*Culinary Vegetables.* Celery: 1. Mr. Walker; 2. H. B. Hollinshead, Esq.; 3. Mr. Horsfall. Onions: 1. Mr. S. Dutton; 2. Mr. Smith; 3. Mr. O. Heyworth. Broccoli: 1. Mr. S. Woodhouse; 2. Mr. Comer. Lettuce: 1. T. Case, Esq.; 2. Mr. Smith, Fulwood. Cucumbers: 1. Mr. Smith, Fulwood; 2. Mr. Whalley. Cabbage, Mr. T. Orret.

*Extra-Prizes.* Grapes in Pot, Mr. Smith; *Dracæna frâgrans*, Miss Waterhouse; Fruit of the Palm, John Blackburne, Esq.; Two Baskets of Flowers, Mr. Powell; *Thunbérkia alâta*, Mr. Skirving; *Campânula pyramidalis álba*, Mr. Powell; *Clárkia pulchélla*, Mr. Smith, Fulwood. (*Gore's General Advertiser*, Aug. 6.)

*Bolton Floral and Horticultural Society.*—The Fourth and last Meeting for the season, of this Society, for the exhibition of carnations, stove, greenhouse, and herbaceous plants, &c. was held on August 12. It would be a dereliction of duty to omit noticing the unequalled specimens of horticultural art produced this year by Mr. Whittle, the gardener of W. Hulton, Esq. There were three turnips exhibited of his cultivation, called early stove; they were nearly of the same size: the heaviest weighed 14 lbs., and measured 2 ft. 9 in. in circumference; he had a yearling vine in a pot, which contained fifteen bunches of fine fruit. He also had two dishes of magnificent celery, one of which won the first prize. He has obtained prizes this year with blanched celery at four different shows of auriculas, tulips, pinks, and carnations. Nor must Mr. Holland's gardener be passed over in silence. He produced the best pan of carnations, which attracted much notice, and some went so far as to say that it surpassed all they had witnessed this year. He won twenty-one prizes, viz. four stove plants out of five: three greenhouse out of five; four ericas out of five; two geraniums out of five; and three hardy plants out of five. Miss Pilkington's currants and raspberries were also much admired. Prizes were awarded as follows:—

*Plants.* Stove: 1. *Pitcairnia bromeliæfólia*, E. Ashworth, Esq.; 2. *Me-lástoma corymbósa*, 3. *Thunbérkia alâta*, 4. *Begónia Agrostémma*, and 5. *Pan-crátium amœnum*, R. Holland, Esq. Green-house: 1. *Crássula coccínea*, W. Hulton, Esq.; 2. *Fúchsia grácilis*, and 3. *Loddigèsia oxalifólia*, R. Holland, Esq.; 4. *Nerium spléndens*, W. Hulton, Esq.; 5. *Polýgala cordifólia*, R. Holland, Esq. Ericas: 1. *Bowieána?* and 2. *E. ventricósa*, R. Holland, Esq.; 3. *E. Savílii*, Mr. W. Faulkner; 4. *E. ampullácea*, and 5. *E. trícólor*, R. Holland, Esq. Geraniums: 1. *P. Banksiànum*, Mr. W. Faulkner; 2. *P. mac-ránthum*, Mr. W. Crompton; 3. *Victory*, and 4. *Daveyànum*, R. Holland, Esq. Herbaceous: 1. *Ænothèra missouriénsis*, R. Holland, Esq.; 2. *Poten-tílla nepalénsis*, W. Hulton, Esq.; 3. *Campânula pyramidalis*, and 4. *Che-lône barbàta*, R. Holland, Esq.; 5. *Lobèlia fúlgens*, E. Ashworth, Esq. Hardy: 1. *Colútea Pocóckii*, Mr. W. Faulkner; 2. *Spiræa sorbifólia?* E. Ashworth, Esq.; 3. *Potentilla fruticósa*, Mr. W. Faulkner.—*Flowers.* Carnations. Best pan, R. Holland, Esq. Premier Prize, Gregory's King (a most

admirable specimen), Mr. James Rushton. Scarlet Bizards : 1. Perfection, Mr. Rich. Greenhalgh ; 2. Fox-hunter, Mr. James Haslam ; 3. Lord Baggot, Mr. Wakefield ; 4. Surpass Perfection, Mr. James Haslam. Pink Bizards : 1. Seedling, Mr. John Wakefield ; 2. King Alfred, Mr. James Haslam ; 3. Rainbow, R. Holland, Esq. ; 4. Duke of Kent, Mr. Joseph Clegg ; 5. Lord Denbigh, Mr. James Rushton. Scarlet Flakes : 1. Mountaineers, Mr. W. Wakefield ; 2. Florentine, Mr. W. Faulkner ; 3. Enchanter, Mr. J. Stewart ; 4. Lord Anson, Mr. W. Lomax. Purple Flakes : 1. Knot's Alfred, C. Todd, Esq. ; 2. Wellington, Mr. Wm. Lomax ; 3. Major Cartwright, T. Booth ; 4. Seedling, Samuel Ogden. Picotees. Purple-striped : 1. Rob Roy, Mr. W. Faulkner ; 2. Fair Helen, Mr. W. Wakefield. Purple-feathered : 1. Wellington, Mr. Joseph Clegg ; 2. Cleopatra, Mr. R. Greenhalgh. Red-striped Seedling, W. Faulkner. Red-feathered, Sir Robert Peel, Mr. W. Faulkner. Georginas : Double, Black Turban, W. Hulton, Esq. ; Single, Mr. Richard Greenhalgh. — *Fruit*. Pine, W. Hulton, Esq. Grapes, best and heaviest, E. Ashworth, Esq. Seedling Nectarines, Peaches, Apricots, and Plums, W. Hulton, Esq. Gooseberries, heaviest : Red, Mr. John Bradshaw ; White, Mr. Peter Norris ; Green, Mr. Matthew Gaskell ; Yellow, Mr. John Bradshaw. Plate of Gooseberries : Red, White, Green and Yellow, Mr. M. Gaskell. Currants : White, Red, and Black, Miss Pilkington. Raspberries : White and Red, Miss Pilkington. Apples, Mr. George Greenhalgh. Pears, Benjamin Rawson, Esq. — *Culinary Vegetables*. Onions, Mr. George Greenhalgh. Celery, W. Hulton, Esq.

*Extra-Prize*. Basket of Flowers, Joseph Ridgway, Esq. (*Manchester Courier*, Aug. 15.)

*Radcliffe Gooseberry Show*. — This show was held at the house of Mrs. Leah Hampson at Radcliffe, near Manchester, August 29. The meeting consisted of seventy-nine subscribers at 5s. each. Four very handsome silver cups, total value 9l., given by gentlemen desirous of encouraging the meeting : eighteen copper kettles, value 11 guineas, two garden spades, and 11l. 12s. in money were distributed. A fat goose also was offered for the least berry of any colour.

*Maiden Prize* : 1. Roaring Lion, 18 dwts. 18 grs., Edmund Baines ; 2. Roaring Lion, 18 dwts. 13 grs., Hampson Wood. Best Berry : Red, Roaring Lion, 22 dwts., Geo. Leigh ; Yellow, Globe, 19 dwts. 13 grs., Wm. Berry ; Green, Angler, 17 dwts. 5 grs., H. Anderton, Esq. ; White, Eagle, 19 dwts. 11 grs., James Chapman. Best two Berries on a stem, Roaring Lion, 36 dwts. 1 gr., John Baker. Heaviest beaten Berry, Roaring Lion, 20 dwts. 18 grs., Richard Taylor. Red Berries : 1. Roaring Lion, 21 dwts. 17 grs., Geo. Leigh ; 2. Bell's Fancy, 19 dwts., Jas. Cranshaw ; 3. Huntsman, 18 dwts. 22 grs., Robt. Kay ; 4. Trumpeter, 18 dwts., John Haslam ; 5. Lancashire Lad, 18 dwts. 1 gr.,\* Geo. Leigh ; 6. Overall, 17 dwts. 1 gr., Wm. Allen ; 7. Seedling, 16 dwts. 22 gr., Wm. Horsefield ; 8. Seedling, 16 dwts. 21 grs., William Cooper ; 9. Prince Regent, 16 dwts. 13 grs., John Barlow ; 10. Squire Hammond, 16 dwts. 15 dwts.,\* Abraham Rostron ; 11. Seedling, 16 dwts. 10 grs., John Saxon ; 12. Sir John, 16 dwts. 9 gr., Robert Smith. Yellow : 1. Gunner, 19 dwts. 12 grs., John Barlow ; 2. Duckwing, 17 dwts. 12 grs., Wm. Hardman ; 3. Cottage Girl, 17 dwts. 2 grs., Jacob Wolstencroft ; 4. Bunker's Hill, 16 dwts. 23 grs., Jas. Birtwistle ; 5. Job, 16 dwts. 11 grs., John Worrall ; 6. Rockwood, 16 dwts. 9 grs., Thomas Walwork ; 7. Viper, 16 dwts. 8 grs., Geo. Leigh ; 8. Husbandman, 16 dwts. 8 grs., Jn. Barlow ; 9. Sovereign, 15 dwts. 17 grs., Abraham Rostron ; 10. Teazer, 15 dwts. 13 grs., Richard Taylor ; 11. Old Queen 15 dwts. 11 grs., and 12. Leader, 15 dwts. 5 grs., John Rothwell. Green : 1. Favourite, 16 dwts. 20 grs., Geo. Leigh ; 2. Angler, 16 dwts. 18 grs., John Worrall ; 3. Bang-down, 16 dwts. 11 grs. ; 4. Peacock, 16 dwts. 3 grs., and 5. Seedling, 16 dwts.

\* Lost their places by not being weighed in time.



2 grs. Richard Taylor; 6. Providence, 15 dwts. 18 grs., John Saxon; 7. Troubler, 15 dwts. 5 grs., George Leigh; 8. Ocean, 15 dwts. 2 grs., Charles Knight; 9. Lord Crewe, 15 dwts., Robt. Kay; 10. Greenwood, 14 dwts. 13 grs., Geo. Leigh; 11. Bang Europe, 14 dwts. 5 grs., Richard Taylor; 12. Mountain, 14 dwts. 4 grs., George Wolstencroft. White: 1. Eagle, 18 dwts. 15 grs., Joseph Ramsden; 2. First Rate, 18 dwts. 10 grs., Wm. Hardman; 3. Lord Valentia, 18 dwts. 5 grs., John Haslam; 4. Nailer, 17 dwts. 3 grs., John Worrall; 5. White Lion, 17 dwts. 2 grs., John Barlow; 6. Ostrich, 17 dwts., James Barlow; 7. Delamere, 17 dwts., John Openshaw; 8. Nonpareil, 16 dwts. 20 grs., and 9. Seedling, 16 dwts. 20 grs., George Leigh; 10. Wellington, 15 dwts. 12 grs., John Bradshaw; 11. England's Glory, 15 dwts, 11 grs., Richard Taylor; 12. Lady of the Manor, 14 dwts. 22 grs., Abraham Rostron. Least Berry: Whitesmith, 1. gr., Sam. Cranshaw; Lancashire Lad, 1 gr. John Warrall. Prize divided. — *John Smith. Bury, Lancashire, Aug. 29.*

## DEVONSHIRE.

*Devon and Exeter Botanical and Horticultural Society.* — The day fixed by this Institution, for their First Exhibition of fruits, flowers, and vegetables, was July 30. Upon the doors being opened, the room was filled almost immediately, and shortly afterwards the President (the Right Hon. Lord Clifford) took the chair, and, in the name of the Society, thanked the individuals who had contributed to the splendid display of horticultural productions exhibited. He expressed, too, his full confidence, that as the climate of Devonshire was more favourable to horticultural pursuits than that of any other part of the kingdom, so this Society would shortly become inferior to none in its extent and usefulness. Mr. Gidley then, at the request of His Lordship, read the names of the successful candidates, and as he announced each prize, he at the same time, wherever it was practicable, exhibited to the company the article for which it was awarded.

*Plants.* Hardy Perennials (best six), Mr. Young, nurseryman, Taunton. Hardy flowering Shrubs (best six), Messrs. Pince and Co., nurserymen, Exeter. Bulbous-rooted tender Exotic, *Amaryllis ornata* var. *gigantæa*, John Milford, Esq. Tender Exotic, *Allamanda cathartica*, John Newcombe, Esq. — *Flowers.* Roses, Mr. Charles Sclater. Carnations. Bizards: 1. and 2. H. Pigou, Esq., Taunton. Flakes: 1. and 2. H. Pigou, Esq. Seedling Bizard (of the exhibitor's own growth, and not before exhibited), 1. W. Gray, Esq.; 2. G. Whittaker, Esq. Seedling Flake (of the exhibitor's own growth, and not before exhibited), W. Gray, Esq. Best Bouquet of Carnations, Mr. Charles Sclater. Picotees: 1. and 2. H. Pigou, Esq. Seedling Picotee (of the exhibitor's own growth, and not before exhibited), 1. G. Whittaker, Esq.: 2. W. Gray, Esq. Bouquet of Picotees, John Newcombe, Esq. Bouquet of Hardy Annuals (Russian Stocks), Sir S. H. Northcote, Bart. Tender Annuals exhibited in Pots, Cockscombs, John Newcombe, Esq. — *Fruit.* Pine, John Newcome, Esq. of Starcross. Grapes, Muscat of Alexandria, Sir Trayton Drake, Bart. Melon, Romàna, Colonel Wright. Apricots, J. W. Buller, Esq. Peaches, H. Porter, Esq. Plums, Mr. Williamson of Peamore. Cherries, John Newcome, Esq. Heaviest Gooseberries, the Lancashire Lad, G. Whittaker, Esq. Best-flavoured Gooseberries, Mr. C. Sclater, Nurseryman, Exeter. Raspberries, Mr. Townsend, nurseryman, St. David's Hill, Exeter. Apples, Lemon Pippin, John Cole, Esq. Pears, Mr. Hall of Powderham. — *Culinary Vegetables.* The best Cucumber, John Newcome, Esq.

The judges also recommended rewards to be given for the undermentioned specimens, which they considered highly deserving of notice: —

To Mrs. Waldon of Monrath House, for three seedling Pines. To Edward Divett, Esq., for a bunch of Muscat Lunel Grapes. To John New, Esq., for a bunch of white Nice Grapes. To the Rev. T. Putt, for a dish of

Apples of the last season, in good preservation; who also exhibited a fine bunch of the Black Prince Grapes. To Dr. Tayleur, for a dish of China Strawberries. To Sir Thomas D. Acland, Bart. for *Erythrina crista galli*, *Metrosideros saligna*, and *Fuchsia gracilis*. To Miss Johnes, for *Thunbergia alata*, trained, and *Pelargonium Devonixæ* grafted. To Mr. Dymond, nurseryman, Exeter, for Gloxinias, *Yucca filamentosa*, and hardy Perennials; and for a new Seedling Apple raised by Mr. John Hutchings, his foreman.

The judges were the Rev. Finney Belfield of Primley Hill, Mr. Pontey of Plymouth, and Mr. Veitch of Killerton. (*Western Times*, Aug. 1.)

The three cucumbers of the Turkey sort, grown by William Billingsley, gardener to John Newcome, Esq., and exhibited on the 30th of July, at the Subscription Rooms, measured in all 6 ft. 3 in. in length, and weighed 10 lbs. The dwarf cockscombs in pots, of which there were six from the same garden, were also extraordinary productions; some of them not being more than 1 ft. high from the surface of the mould, and measuring 26 in. in length over, and 14 in. across the crest. This account appeared on the 15th inst. in *Trewman's Flying Post*. — *An Exonian*. August 28. 1829.

#### SOUTH WALES.

*Glamorgan, Monmouthshire, and South Wales Horticultural Society.* — At the Meeting of this Society on the 1st of July, the show was held in the Town-Hall, Cardiff, instead of the Grand Jury Room, as heretofore, the latter having been found too small for the purpose, and to the Hall also the General Meeting was adjourned, as soon as the judges of the show had announced that they were ready to deliver in their adjudications. The chairman, J. H. Moggridge, Esq., of Woodfield, congratulated the Meeting upon the increasing respectability and prosperity of the Society, which, he said, he had no doubt would both progressively increase, till it had attained that high rank amongst the horticultural societies of the island, to which it was on every account entitled. Its finances he pronounced to be in a very satisfactory state, the number of its members continually increasing, its shows more and more enlarged and varied, and its prospects of doing credit to the district in which it was situated, and of being the instrument of rational amusement and good to all classes of the community, more and more flattering. The Hon. W. B. Grey, president, was reelected, as were all the vice-presidents; and the names of the Earl of Jersey, Lord Dynevor, Col. Lewis, Sir C. Cole, Major Mackworth, Col. Cameron, J. P. Wilkins, Esq., and the Rev. F. Gough, added to the list. The gratifying proposal of Sir Charles Morgan, Vice-Patron of the Society, for holding the Monmouthshire show, on the 5th of August, at Tredegar, with the offer of his green-house for the occasion, was announced from the chair in terms of suitable commendation; and extracts from Sir Charles Morgan's letters read, from which it appeared that his liberal offer was accompanied by the very handsome expression of the Hon. Baronet's desire, that "the show should be held at Tredegar solely under the Society's regulations, as if at the King's Head, or elsewhere." The report from the judges of the show being then handed to the chair, the following adjudication of prizes was announced, viz.

Melons, John Moggridge, Esq., Gabalva. Grapes: Black, Col. Morgan, Llandough Castle; White, and best Frontignac, the Hon. W. B. Grey, as well as that for the best raspberries. Cherries, J. Moggridge, Esq. Currants: White, Col. Morgan; Red, Richard Hill, Esq., Llandaff. Pinks, the Hon. W. B. Grey. Balsam, Richard Hill, Esq. Best and most curious plant of any description: 1. Rev. J. M. Traherne; 2. Rev. E. W. Richards. Best and most beautiful plant: 1. Rev. E. W. Richards; 2. Richard Hill, Esq. Roses, Col. Morgan.

*Extra-Prizes.* Strawberries, E. P. Richards, Esq., Cardiff. Second best Melon, the Hon. W. B. Grey. Best Red and White Currants, 1. and 2. J. M.

Richards, Esq., Roath Court. Flowers, R. Reece, Esq., Hon. Sec. Strawberries: 1. E. P. Richards, Esq.; 2. R. Hill, Esq. Grapes, 1. and 2. Sir C. Morgan. An extra-prize was also adjudged to J. H. Moggridge, Esq., for his exhibition of the foliage of certain American timber trees, now first attempted to be introduced into South Wales, and for his description of the trees, and another to Mr. Murrell, for his fine onions, &c. &c.

Enquiries having been made in vain for cottagers applying for the numerous premiums exclusively offered them, the Chairman commented thereon very feelingly, expressing his deep regret that one of the most favourite objects of the Society should thus far, and up to this period, have been defeated by circumstances of which no competent knowledge had been hitherto obtained. He had, he said, been informed, that, at the time of the last show, it had been mischievously given out by persons unknown, that entrance-money would be demanded from competitors for the prizes who were not subscribers. This utterly unfounded report had, he knew, deterred some persons from applying for the cottager's premiums, and, although pains had been taken to contradict the falsehood of the report, and particularly in the public papers, it was to be feared it still operated. In the hope of assisting to counteract more effectually and speedily the cause of the injury done to the kind intentions of the Society, as well as to the cottagers themselves, the Chairman requested permission to offer the premium with which he had been honoured, in the name of the Society, as a prize to the owner of the best cultivated cottage garden in Blackwood village, to be adjudged under conditions (which would in the mean time be made known), at the Monmouthshire show at Tredegar, on the 18th of August, in addition to those already announced as applicable only to the cottager; which proposal being assented to, it was ordered to be announced accordingly. Although the state of the weather prevented the dressing up of the Hall in the manner intended, a great many groups, baskets, and wreaths of beautiful flowers were placed on the judges' seats and desks, and tastefully, though hastily, arranged in other parts of the Hall, whilst the large table and stands were loaded with fruits of a description which would have done no discredit to the first provincial society in the kingdom. The pine, from Tredegar, and the grapes were particularly fine; the size of the bunches of the latter unusually large, though exceeded in size of berries by those from Llandough Castle, to which the first prize had been adjudged before Sir Charles Morgan's grapes (detained in consequence of the stormy weather) had arrived. The day, which was one throughout of high gratification, afforded a most convincing proof to all present that, as was asserted in the opening address, Glamorganshire, Monmouthshire, and South Wales afford abundant materials for rescuing that naturally favoured part of our island from the reproach of being behind any other in the productions of the garden, the field, or the orchard. (*The Cambrian*, July 11.)

---

### ART. XIII. Obituary.

*DIED*, in February, 1829, M. Holböll, our universally respected botanic gardener, whose name will long be remembered by the horticulturists of this country. In the November preceding his death, His Majesty the King of Denmark graciously conferred on him the honour of Knight of the Order of Dannebrog. — *Jens Peter Petersen. Royal Gardens, Rosenburgh, July 4. 1829.*

---

THE  
GARDENER'S MAGAZINE,  
DECEMBER, 1829.

---

PART I.  
ORIGINAL CORRESPONDENCE.

---

ART. I. *Notes and Reflections made during a Tour through Part of France and Germany, in the Autumn of the Year 1828.* By the CONDUCTOR.

(Continued from p. 502.)

*CHATEAU de Queville, the Prince de Montmorency, about two miles from Rouen, September 3.* — A flat sandy situation, with no apparent boundary; the house a large plain modern edifice, approached through a broad avenue of lime trees, descending rather than ascending; the effect of the whole, to an English eye, the reverse of grandeur, dignity, order, neatness, and habitableness. It put us in mind of some of the wretched châteaux which we have seen in Poland and Russia; and with every desire to be pleased and to commend, we could really find nothing on which to bestow our approbation, except the urbanity of the gardener, and of another man who went round with us. The house is surrounded by a very broad sandy area, on which are placed a profusion of old orange trees and pomegranates, and a number of the commoner green-house plants of the last century; few of them well grown, or, in our idea, at all ornamental. There are a conservatory and a green-house; the former in great part below the level of the surrounding surface, with a temporary flooring over it, to be used at pleasure during winter and in bad weather, as a place of exercise and romping for the family children. The green-house had sloping glass and a flue in the English manner. There is a considerable court of stable offices, with a number of carriages and horses, and some of both are English. The house, we were told, was full of company. In a shed were a

diable for moving orange trees, a large cast-iron roller for the roads, and some rude agricultural implements. Adjoining these offices is the kitchen-garden, containing perhaps 2 acres within the walls. The soil is sandy and very poor; it requires constant watering during the summer season, and the water is raised by a horse-wheel from a deep well in the centre. The surrounding walls are about 10 ft. high, of stone, and covered with a wooden trellis, on which pear trees are trained, chiefly in the fan manner, but not neatly. The trees had very little fruit on them, which, considering that the borders were cropped and the soil soft and deep, was not to be wondered at. There was a considerable breadth of red alpine strawberry, and the walks were, for the most part, edged with common sorrel. The asparagus was in rows between 2 and 3 ft. apart, but less strong than might have been expected, probably from want of manure. Plenty of artichokes and kidneybeans.

On what may be called the garden front of the house was an open avenue of grass, perhaps 150 ft. wide and on each side was a wood, in some places open like a grove, and in others thicker like an artificial plantation. In the thick parts the Pin de Bourdeaux (*Pinus marítima*), which the gardener informed us was greatly to be preferred to the Pin d'Écosse (*P. sylvéstris*) or the Sapin épicéa (*Abies commùnis*), because shrubs and grass grew much better under it, and the cones, which are thick and from 6 to 8 in. long, made an excellent fuel for the poor, being picked up by them as they fell from the trees, so that the proprietor of the wood sustained no injury. There are various walks, straight and winding, both in the woods and in the grove. In the latter, near the house, are several swings of different kinds, very completely equipped, for ladies and gentlemen; and roundabouts, which the gardener informed us were much used by the younger part of the family. There are also a skittle-ground, a place for playing at bowls, and a sort of rustic house containing a table nearly as large as a billiard table, but fitted up like a bagatelle board, for playing at *trou madame*. These contrivances for amusement seemed to be very judiciously placed under the shade of the trees, which were at the same time so lofty, naked-stemmed, and far apart, as to create or admit a gentle cooling breeze. It was now near noon, and a very warm day; no one was taking amusement in the grove, but a billiard table in the house was in use by a party of gentlemen. Directly in front of the house, on the centre of the grass avenue just mentioned is a *méridien à détonation*, the cannon 3 ft. long. Beyond the wood there is a small meadow with winding walks, *à l'Anglaise*, which we looked at over the turf fence, but did not enter.

*Rouen to Mailleraie and Landin, September 4.* — These residences are situated on the left bank of the Seine, between Rouen and Honfleur. The nearest road is on the right bank of the river, probably 10 or 12 miles in length, exceedingly hilly, grand, varied, and picturesque. The most agreeable way of making the excursion is by water. A steam-boat sets out on certain days for this purpose, and for affording a view of the beautiful and rich scenery on the river, from Rouen to Havre, said to be unequalled in France; but we had not time to adopt this mode. In leaving Rouen we passed two or three small villas, apparently in a better style than that near Quevilly (p. 501.); the nursery of M. Morelle, in very perfect order; and, near Duclair, the Château du Taily, a small residence, occupying a walled parallelogram of about two acres, surrounded by an open corn country. This château, as far as could be seen from the road, is about the date of the Tuilleries, and unchanged in a single external feature, either in the house or grounds. As a piece of antiquity we felt it to be extremely interesting. We passed several cottages and gardens, and one or two villages; but, except some houses in the latter, we cannot say that we saw much appearance of comfort. Most of the cottages were in very bad repair, but almost all of them seemed to have cow-houses, a place for pigs, and sometimes for sheep. We learned afterwards that the occupiers were for the greater part small farmers or proprietors. The road, though of the secondary or cross-country description, was bordered in most places by fruit trees, in general young. The surface of the country was undivided by hedges, except near villages and cottages; but it was occasionally varied by patches of native wood. Clover, wheat, kidneybeans, and potatoes, seemed to be grown by every one. Little could be said in favour of the cottage gardens; not so many vines were planted against the houses as in the suburbs of Rouen, nor so many flowers before them as in the manufacturing district of the Dieppe road (p. 369.). Still the soil was every where a brown loam on limestone rock, the surface varied, and the distance agreeable or grand. The germs, therefore, of riches and beauty exist every where; and future, and, we hope, not distant, prosperity will call them into existence.

*The Château du Mailleraie* is built close on the margin of the river, on a bank somewhat higher than that opposite, but not so much so as to give the situation any decided advantage in point of character or effect. Behind and on one side lies the park scenery, chiefly avenues and woods in the ancient style; and on the other side the stable offices, kitchen-garden, church, and village. The park, we were told, contains above

100 acres ; about three fourths of it consist of a flat or very slightly varied surface, planted with hornbeam avenues, and close woods pierced by numerous clipped alleys diverging from centres in the usual manner, of which the only one that has left any impression on our mind, is the triple vista, from a *patte d'oie* to the river. The remaining fourth part consists of a surface a good deal varied, and is laid out in imitation of the English manner, with numerous buildings, and on the whole it is not an unsuccessful imitation.

The kitchen-garden is close to the house, and in former times must have been its chief ornament in the way of pleasure-ground ; at present it is in a state of ruin and desolation, such as no British gardener can form the slightest idea of. The walls, terraces, slopes, platforms on different levels, basins no longer fit to hold water, ruined fountains, broken statues and urns, the remains of an old conservatory and of some pavilions, neglected wall trees, and old shrubs, show what it has been, and the luxuriance of the weeds what it might very soon be. An English gardener would turn the whole into one of the richest flower-gardens in the world. The house is grand, considered with reference to its size, accompaniments, and antiquity ; but it has little architectural merit either externally or within. A great deal, however, might be said about the house and grounds, the view to the Abbaye de Jumiéges, built in the 11th century, and containing the ashes of Agnes Sorrel, and about other views ; but the reader, we fear, must be tired with the unavoidable sameness of our details. With the exception of the kitchen-garden, it gives us pleasure to state that the grounds were tolerably well kept. We were shown them by the gamekeeper, who could write very well.

*The Village of Mailleraie* is situated close by the river, and, though small, contains an inn, tolerably good for the country, which is said to be much frequented by visitors during summer. After dining on stewed eels and eggs, this being Friday, we hired a one-horse vehicle of a very rude description, with a man between seventy and eighty, who could neither read nor write, and a pony, to take us to Landin, a distance of five or six miles. The road is indescribably bad, and of very little variety or interest in a picturesque point of view. Great part of it is through a forest of birches and oaks, which seems to be cut down periodically for fuel, and the rest is a narrow crooked lane. We arrived at Landin about five o'clock.

*Landin*, at present the residence of the Marquis de St. Marie, has long been celebrated for its situation, on the bank of the river, here lofty, irregular, and covered with natural wood. The château must be at least 300 ft. above the level of

the water. We were told at Rouen that Landin was neglected and no longer worth going to see, but we felt ourselves amply compensated for the journey, even if we had not seen Mailleraie, nor any thing else. Almost the entire interest of the place, in our eyes, consists in the grandeur of the situation, and the facilities which it affords of forming what we have always considered as the grandest description of walk or road in nature or art; that of a level line carried along the side of a steep, irregular, winding, wooded bank or hill, looking up to woods and hill tops on one hand, and down to water, rich and varied country, and extreme distance on the other. At Landin the hill tops are wanting, but the irregularity of the bank affords every opportunity that we could desire for varying the line of walk, by retiring into wooded recesses with rocks, caverns, and springs, and advancing to bold prominences commanding the whole extensive reach of the river. In the alluvial plain on the opposite side, and directly under the Château de Landin, is a very remarkable feature in rural economy; a strip or strand of one or two hundred acres close by the river, some yards higher than all the rest, and entirely covered with cottages and fruit trees. We were informed that, being found particularly suitable for the culture of table fruits, especially apples, it is let in portions of an acre or two for that purpose; that every allotment has a cottage for the occupier and his family; and that the whole have for many years formed a very remarkable colony. We regretted our inability to examine it minutely. The fruits, chiefly the apples, are said to be sent to many parts of Europe, especially the celebrated Reinettes Grises. Beyond this alluvial island, and on each side of it, up and down the river, for several miles, the surface is flat, in meadow, and often during winter and spring entirely covered with water. The Château de Landin on these occasions looks down on an immense lake, with the island of fruit trees and cottages in the foreground, and in the distance a cultivated hilly country, varied by natural woods, and the remains of some châteaux and religious buildings.

Before the revolution, the Château de Landin was possessed by the Abbé Boismont, a man of learning and a gardening amateur of that day. Some of his verses may be seen in the summer houses in the English part of the grounds at Mailleraie; and the numerous walks which he traced in the woods at Landin, with the ruins of some of his root houses and temples, still remain. The Abbé Gossier informed us that the Abbé Boismont had a flock of sheep, a herd of cows and bullocks, and several milkmaids and shepherds, all formed of plaster of Paris, and stuck about the grounds, and that it cost him 2000 francs



a year to keep them in repair. People of all ranks came from every part of the country to see them ; but since they had gone to decay, no body looked near the place ; so true it is that man in a rude state admires only art, because it is only in works of art that he can recognise mind. The Abbé had doubtless mind to enjoy the sublime prospect from his château, and feeling to be amused with his delighted and astonished visitors.

We advanced to this château without any letters of introduction, but on requesting permission to walk through the grounds every attention was paid us, and we were conducted to the principal points of view by a very interesting and intelligent young lady, Mad. —, to whom, through the Abbé Gossier, we have sent a copy of this Magazine as a mark of our esteem ; and this record will remain as a remembrance to ourselves of a château, the situation of which, and the circumstances attending our view of it, produced an impression upon our minds stronger by far than did any other object or circumstance in or about Rouen. We hope we may again see Landin with more leisure for examination and enjoyment.

*Rouen to Fleury, Sept. 5.* — Passed a variety of suburban villas, those nearest the town in very commanding situations, ornamented with flowers, and enriched with vines, but, in appearance of solidity, refinement, and comfort, very distant from analogous villas in the suburbs of London, or of any of the larger towns in England south of York. Still these Rouen villas are almost as far in advance of what the suburban villas of Edinburgh and Glasgow were twenty years ago, the time which has elapsed since we saw them, as those of London are in advance of those of Rouen. The London villa indicates in the possessor a love of comfort, luxury, and neatness ; the Rouen villa indicates taste, style, and superficialness ; the Scotch villa, ambition, poverty, and slovenliness.

A residence, which we think was called *Franqueville*, was undergoing changes in what is called in France the English manner ; and the lines and forms produced with this view, as seen from the road, were such as might be expected from a cockney jobbing gardener, who had never been five miles from London : here and there a round or an oval clump ; a piece of water of the shape of that in the Horticultural Society's Garden ; a semicircular bridge over it ; a naked road of three equal bends, as an approach to the house ; and a serpentine walk round the boundary of the park or paddock. It is a pity the proprietor had not called in Mr. Blaikie, who two years before was in this neighbourhood, laying out the grounds of the Marquis d'Etamps near Laboulle. But even this would not have done every thing ; for the best plan ever

given may be rendered ridiculous, when the execution of it is committed to men wholly ignorant both of the science and the practice of that part of their art. Frequent as are the handsome residences, and numerous as are the examples of beautiful landscape-gardening, in England, yet it is certain there is not one residence in a hundred that is any thing like well laid out; comprehending under this term, well designed and well executed. Every competent judge will allow that we are correct in this assertion; and we know, from 25 years' experience, that things will never be otherwise till the patrons of gardening acquire by a very different education from that which they receive at present, by travelling, and by reflection, a degree of taste far superior to what one in a hundred of them now possesses; or till a new race of gardeners arise, educated to the utmost, and allowed by their masters opportunities of looking about them, and of reading, reflecting, and sketching from nature. It is not likely that there ever will be many such serving gardeners in this or in any country; and, therefore, our hopes of improvement are from the rising generation of small proprietors, who, highly educated, travelled, and accomplished, will act as their own architect, landscape-gardener, and botanist. All the professions in the world have arisen from the ignorance, privations, or superfluities of individuals. When, by a high degree of education and its effects, mankind become more nearly alike in knowledge and in property, professional men will be less necessary, and some professions, and among these that of landscape-gardener, will probably cease to exist. But in this, as in every other contemplated advance in the progress of mind and of happiness, all will depend on the degree of increased education given to both the employers and the employed.

*Fleury* is a small village of one straight street across a valley ten or twelve miles from Rouen, on the road to Paris. A stream which drives two or three cotton machines is the principal cause of the village, and accounts for the houses being chiefly new. Radepont is about half a mile distant from it down the stream, on the north side of the valley; it is approached through some very wretched-looking thatched mud cottages, with earthen floors and small windows.

*The Château de Radepont, M. le Marquis de Radepont*, presents no grand or striking feature; but the grounds are varied, well planted, very well laid out, and exceedingly well kept. The extent of the demesne may be 30 or 40 acres, partly on the side, and partly along the bottom, of a valley. The house, a plain modern building, is situated in the middle of a low flat surface, and unaided by any external feature. The interesting part of the grounds is the irregular declivity which rises from

the platform of the house, and the leading feature of this declivity is formed by the ruins of an ancient castle or fortress, and of its various outworks. These are exceedingly well managed, and made the most of by walks leading to different points of view, and by a chapel, hermitage, mausoleum, and armoury. Another feature is a conservatory with some good orange trees, and perhaps 30 or 40 species of the common green-house plants. There are a Temple of Fame, with a statue in it of some prince or other person belonging to the court, who had honoured Radepont by a visit; various seats covered and open, the former with rush mats or cushions, both for sitting on and to place beneath the feet; an American ground; a hanging wood with a dark walk; a bridge over the stream which drives the cotton mills and passes through a part of the low grounds; a cascade; an aviary and a menagery with a lemur, turtle doves, pheasants, &c.; English cottages; a dairy and very neat cow-houses; with some similar objects of amusement and interest. The walks are, for the most part, ornamented with groups of showy annuals of the commoner sorts, asters, marigolds, poppies, mallows, &c. The views from the rising grounds are over the house and the low grounds, to the naked down-like chalk hills on the other side of the valley; and those from the low grounds are, in most places, limited by a boundary of wood, and are chiefly from one object to another within this boundary. The kitchen-garden may contain three acres, surrounded by a mud wall trellised, and has a very good gardener's house, a fruit-room, a hot-house, pits, and frames. The hot-house contains some good old plants of general interest, such as the sugar-cane, date palm, Indian-rubber tree. The frames were shaded with straw mats, and contained, if we recollect right, a few pine plants, cantaloup melons, and some pots of cuttings. The walks, like all the others about this residence, were laid with fine river gravel, which, as it does not bind, is kept soft and even, by frequent raking. The edgings in the kitchen-garden were of strawberries, sorrel, and other culinary plants. The borders were planted with dwarfs, and trees trained *en pyramide*, and in the compartments were some standards. The whole, even to the melon ground, was in the most perfect order, the walks newly raked, and scarcely a weed to be seen. With no part of the grounds could we find fault in this respect. On expressing our surprise and admiration at this degree of order and neatness to the gardener, a gay old man, who could read and write, with a stout healthy wife of nearly the same age who looked out on us as we passed the door of her dwelling-house, he said that his master insisted that it should always be so, and therefore it could not

be otherwise. Nothing gratified us more than to hear of this taste, and rigid exaction of duty, on the part of the master. An easy master is not so bad as a whimsical or capricious one; but he is much worse than one who requires even a military exactness in the performance of duty. All servants, whether of the public, like ourselves, or of individuals, like many of our readers, are, from the nature of things, more or less machines; an easy master lets them rust and go out of order, but a systematic one polishes the cogs and oils the gudgeons, so as to increase their mechanical efficiency, prevent noise, and accelerate motion.

On the whole this place only requires an English-looking house, to be a very successful imitation of the English manner. The house servant who showed us round, a German from Alsatia, who could not read, and who excused himself by saying he did not understand the French letters, said it was entirely laid out by his master, who had passed some time in England.

Thinking that the new village and the old one might indicate the present and the former states of the habitations of the poor in this part of France, and being on a walking excursion, we entered some of the cottages in both villages. The interior of the thatched mud structures was not so uncomfortable as we expected. The total internal dimensions might be 12 ft. by 20; there was one fire-place, large, open, and raised about 6 in. from the floor, for burning wood; a boarded partition separated a space about 12 ft. by 6 or 8 ft., which we had not an opportunity of looking into, further than to see the corner of a box-bed without curtains; this partition was not higher than the side walls, and in one case it was formed of a straw mat stretched on posts and rails; the common ceiling to the whole interior seemed to be of loose boards, and in one cottage there was no ceiling. The furniture consisted of a large oak chest in every case, with a table and some straw-bottomed chairs, a cupboard, a bench, earthen pots, wooden plates, a distaff, bill-hook, reaping-hook, spade, hoe, and a few other articles.

In New Fleury, the dwelling houses are substantially built of brick and stone, of ample dimensions, and two stories high. On the ground floor are a large apartment with a fire-place, and a smaller one entered from it without a fire-place. Over these are two sleeping-rooms to which the ascent is by a staircase which proceeds from the entrance door.

Our next will commence with the gardens of Paris and its environs.

*(To be continued.)*

## PART II.

## MISCELLANEOUS INTELLIGENCE.

ART. I. *General Notices.*

*PRICES of Commodities.* — The progress of a town depends greatly on the abundance and cheapness of consumable commodities; and hence we find that all the large cities of ancient times were situated either near the sea, or on the lower part of navigable rivers. Such were Nineveh, Babylon, Memphis, Carthage, Rome, and Constantinople. All these places enjoyed the advantage of water-carriage, without which even Babylon, though placed in the midst of a most fertile country, never could have swelled its population to a million, or three-quarters of a million, of souls. At the union of the crowns of England and Scotland, Edinburgh did not probably contain 20,000 inhabitants; and yet such was the difficulty of feeding them, that every foot of the soil to which the plough could be applied, on the high parts of Arthur's Seat, was torn up. Why was this? Simply because Scotland having few ships, and being no match for England by sea, her capital necessarily had all its supplies brought in by pack-horses. Hence the expense of conveyance was so great, that it was more profitable to raise corn on the very worst soils in the neighbourhood, than to bring it from the best soils at some distance off. With our improved roads, our canals, and our shipping, 150,000 persons could be more easily fed in Edinburgh at this day, than 20,000 at the time of the union. Railways will go far to place inland towns, remote from rivers or the sea, on a level in this respect with those which have the most abundant means of water communication. (*Scotsman*, April 18. 1829.)

Extending this reasoning to countries, corn and raw commodities of all kinds ought to be cheaper in Great Britain than in any other country in Europe; because there is a greater demand there than in any other country, and because Great Britain is surrounded by the sea, which serves as a canal to any other country, and, unlike other canals and tracks of communication, requires no expense to keep it in repair. What is it, then, that renders corn, with every other raw material, dearer in Britain than in any other country? The corn laws, restricted commercial intercourse, the interest of the national debt, and the expense of the national church; and the problem is to get rid of these with perfect justice and honesty to all parties concerned. No plan that is not perfectly just and honest is worthy of Great Britain. — *Cond.*

*Use of Systematic Names.* — Every gardener is at home with every other gardener, no matter whether he ever saw him before, or in what part of the country he may find him, or even if they do not understand the common language of each other. To be convinced of this, it is only necessary to observe the personal intercourse of the Continental and British nurserymen, which with a few exceptions is almost entirely carried on by pronouncing a few systematic names of plants; these systematic names being what may be called the universal language of gardeners. If, therefore, the systematic

names of plants and animals were in universal use, there would be to a certain extent a universal language, and this, we think, is one reason why systematic names should be adopted into all languages without altering their terminations. There are few travellers who have not experienced the advantages of belonging to that universal society the Masonic brotherhood; the Society of Jesus is another universal institution; and the universal propagation of the Christian religion by missionaries, and of the Bible by the Bible Societies, will tend towards uniting mankind in one family. The probable destiny of the human race, it is not unreasonable to suppose, is ultimately to speak one language, to use the same weights and measures, to be governed by nearly the same laws, and to be much nearer an equality in point of knowledge, manners, and even property, than they are at present. The changes required before this state of things is attained may be various, and their accomplishment may be distant; but they have already been effected to a certain extent: the English and French languages and literature are spreading every where; and gardeners and naturalists are every where springing up, who all make use of the same systematic names. It ought to be gratifying, therefore, to gardeners to know that, independently of other advantages, in the mere acquirement of the systematic names of plants, and in teaching them to others, they are absolutely contributing to the spreading of a universal language, and certainly, though slowly, clearing the way for the greatest human improvement that the mind can contemplate. — *Contd.*

*Ploughing and digging very tenacious Soils.* — It may be useful now and then for farmers and gardeners to turn their attention to the implements with which they perform their principal operations; the most frequent and important of which, both in the farm and garden, are ploughing and digging. Now, the friction of the plough and the spade are very different in different soils, and in the same soil under different circumstances. The most difficult soils to plough are strong, tenacious, flinty clays, such as those of Kent, when between the wet and the dry. Mr. Finlayson, in his excellent practical work, the *British Farmer*, observes that, when the clays of Kent, Surrey, and Middlesex are betwixt the wet and dry, they adhere to the body of the plough like glue, and double or treble the friction that would otherwise take place. Hence the necessity of such clumsy unwieldy implements as the Kentish turnwrest plough, requiring five or six horses to draw them. "Considering the great expense of working land with this plough," says Mr. Finlayson, "I began to consider, that, in place of a mould-board, three or four rods of iron might be substituted. On trial I found it to answer

135

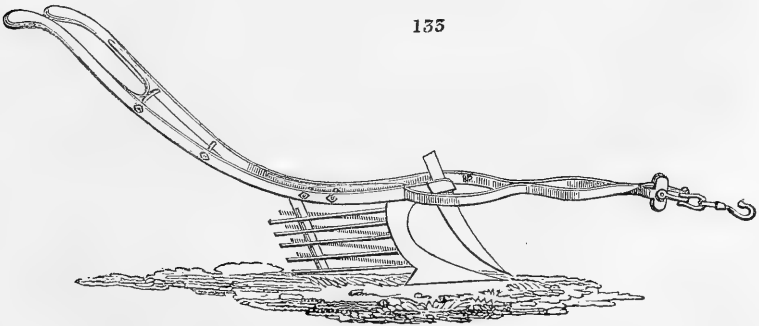

the purpose completely; and I have no hesitation in saying that the most adhesive land may with ease be ploughed with the skeleton plough (*fig. 135.*) and one pair of good horses. The clay or earth being prevented from

adhering to the plough, the draught is thereby much diminished; the whole surface of this plough not being more than one third or one fourth the surface of other ploughs will account for the ease of draught." Notwithstanding the Kentish farmer's well known aversion from reading and from innovation of any kind, we confess we are a little surprised that this skeleton plough has not been fairly tried. It may not on every soil succeed without wheels; but these could easily be joined to the construction. 134 It is worthy of notice, that another individual, we suppose a machinist, Stothard, has taken out a patent for a plough with a perforated mould-board, the object of which he states to be exactly the same as that of Mr. Finlayson's. We hope some of our readers will give Finlayson's skeleton plough a trial; and we hope that gardeners, by reflecting on what we have stated respecting this plough, will see the great saving of labour in digging or hoeing stiff clays, between wet and dry, with two-pronged spade-forks and hoes. (fig. 134.) The navigator's spade, with a semi-cylindrical blade (fig. 135. a); with a rounded blade (b); with a scolloped blade (c); with a tapering blade (d); with a triangular blade (e); with a pierced blade (f), and with a shield blade (g), are all for the purpose of piercing the earth with greater ease, and, of course, diminishing friction.

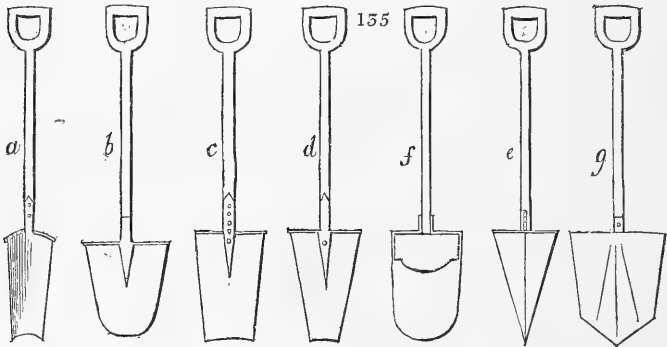
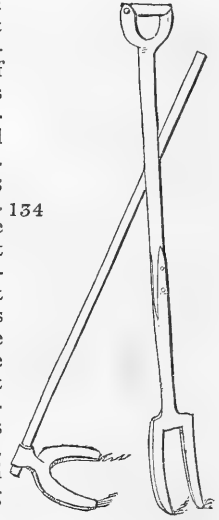

For diminishing friction in loamy soils, and in all such as can be worked with ease, the most perfect plough hitherto produced is that of Wilkie of Uddington, near Glasgow. (fig. 136.) Wheels are generally placed under the

136

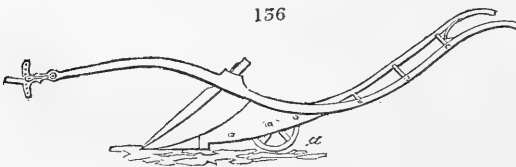

beams of ploughs, with a view to render them easier to hold; but a wheel fixed like that of Mr. Wilkie (a) is for the purpose of diminishing the

friction of the land side and the sole. This wheel is placed so as to incline from the perpendicular at an angle of about 50°, and following in the angle of the furrow cut by the coulter and share, it insures a greater degree of steadiness in the motion of the plough, than when rolling only on the bottom

of the furrow. The father of the present Mr. Wilkie constructed a plough on the above principle in 1825, and they have since been highly approved of both in clayey loams and free soils. The sock, or share, is of cast iron, which is a great saving both in first cost and repairs; costing only 1*s.*, and ploughing at an average upwards of 10 acres. The coulter alone requires to be taken to the smithy, the share being renewed by the ploughman at pleasure. The wheel, which is of cast iron, will last many years. The draught of this plough has been proved, at a public ploughing match in 1829, to be fully 30 per cent less than that of the common swing-plough of the most improved form. The price is also lower than that of any iron plough now in use. A specimen may be seen at Weir's, Oxford Street, London, and we would strongly recommend a trial. — *Cond.*

*Improvements on Wilkie's Wheel Plough.* — Sir, Since writing, I have received the most satisfactory testimonials in favour of the wheel plough from the different gentlemen who have used them; in particular, from Mr. Shedholm of Carlisle, Mr. Rothwell of Manchester, and Mr. Rooke of Leicester who has got three of them. The latter gentleman writes me that his soil is a strong deep loam, very difficult to plough: that his neighbours work with ploughs having a wheel on each side of the beam to keep them steady, drawn by four and five horses, a man holding and a boy driving; while he employs only one man and a pair of horses to perform the same work. The only improvements suggested are, to increase a little the breadth of the rim of the wheel, so as to prevent it from sinking in loose or wet soils; and to place a cover over it, to protect it from any loose earth getting over the top of the mould-board and obstructing its motion. I intend likewise to have the rim of the wheel cast in an iron mould, by which means the casting will become extremely hard, and, when polished, little or no earth will adhere to its surfaces; but the *stickage* from the present position of the wheel is nothing to what it was when the wheel was placed vertically. I am at present making a plough for a farmer in this immediate neighbourhood, embracing all these improvements: the beam is made almost wholly of steel; the plough is intended, when completed, not to weigh more than half the common plough, and the draught is expected to be diminished in the same proportion. It is likewise proposed to have a piece of mechanism attached to the wheel, by the revolution of which the quantity of ground passed over by the plough may be indicated.

You seem to think that the wheel plough will be more difficult to manage than the common plough. With respect to this point there is rather a diversity of opinion among the ploughmen; but, for my own part, although I have had little experience in holding the plough, I was able to make a straighter and evener furrow with the wheel plough than with the other: from having fewer points in contact with the bottom of the furrow and land side, it keeps a firmer hold of the ground, and is not so apt to deviate on encountering different resistances; this is seen to great advantage in breaking or taking up the last furrow, in which its superiority over the common plough is most conspicuous. — *James Wilkie. Uddingston, Oct. 17. 1829.*

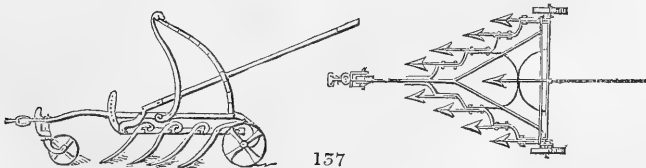

157

*Wilkie's Brake or Cultivator, and its various Applications.* — Another excellent invention for diminishing friction in labouring the soil is Wilkie's parallel adjusting brake. (*fig. 137.*) This implement is said to penetrate the



soil with less draught than Finlayson's harrow; and, by the application of a parallel movement, the tines, which may or may not be hoes, may be regulated to work at any depth, from 1 to 8 or 9 in. This is done instantaneously, and with mathematical exactness. In gardening, the Spanish hoe (Vol. II. p. 233. fig. 64.), the Grenoble hoe (fig. 138. *a*), the pick hoe (*b*), and the Sarthe hoe (*c*), with some others of the French (*d e f*), may be considered as the nearest approach to this application of pronged instruments. The French have a great variety of hoes (figs. 139, 140.), because a greater part of the agriculture of France alternates with a sort of garden culture.

The hoe, M. Thouin observes (*Cours de Culture, &c.*), is an implement of universal use, and by it the surface of the soil can be stirred to the

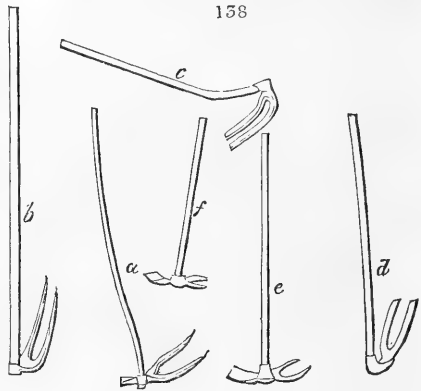

depth of from 3 to 7 in. at less expense of time and human strength than by any other manual implement whatever. It is among manual implements what the plough is among implements drawn by cattle. Pronged hoes are particularly suitable for gravelly, stony, and clayey soils, and those full of root weeds; but, in any soil, they require less strength on the part of the operator than common hoes. The vineyards of France are mostly worked with hoes; and as the operator has most power over the implement when he is bent with his head half way to the ground, this position is said to produce anchylosis of the spine, and to deform

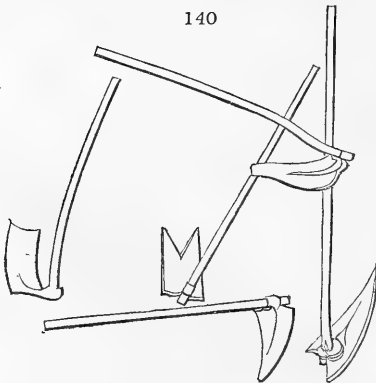

the operator during his future life. Gardeners and others ought to bear this in mind when they send women to hoe turnips, and to other field work.—*Concl.*

*Improvements in Wilkie's Brake.*—With regard to the brake, it certainly has a nearer resemblance to Finlayson's harrow than to any other implement of the kind, more particularly in the form of the tines and mode of adjustment. With respect to the tines I do not conceive that I have followed Mr. Finlayson's plan, but rather that of my late father, to whom the merit of originality in this instance unquestionably is due. He first applied the principle of the bent lever to the hoes attached to his drill implements, a perspective drawing of which I furnished for the *Farmer's Magazine* for 1821. The drill harrow, with the hoes on the principle alluded to, you have copied into your *Encyclopædia of Agriculture*. The following sketches (*fig. 141. A, B, C*) will at once show the identity of principle.

*c* (*fig. 141.*) is that of my father; *A* Finlayson's; and *B* mine. They are all bent levers;

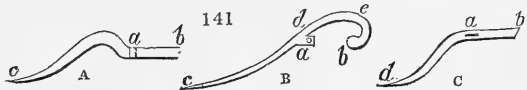

the fulcrum being at *a*, the power at *b*. *B* I conceive to be stronger than *A* or *C*; the upper curvature at *e* serving to introduce the principle of tension; the power at *b* acting with greater effect as a counterpoise to the resistance at *d* than in either of the former. The curve *cd* is that of the cycloid, described by mathematicians as the solid of least resistance: this curve has been considered only as a *jeu d'esprit* of its great author; but I have found it, from repeated experiment, to answer better than any other. Nor do I think that I have copied Mr. Finlayson in the mode by which the implement is regulated. By an application of the simple, yet beautiful, principle of the parallel movement, I have effected, by one instantaneous operation, what, in Finlayson's harrow and every implement of the kind, required three separate adjustments. In Finlayson's harrow, the lever has only power to lift the fore part out of the ground; the hind part being raised by means of screws at each extremity of the axle; always a tedious process, and one which cannot be performed while the implement is at work. The tines of Finlayson's harrow are ranged in two parallel rows, at right angles to the line of draught. I have adopted the form of an isosceles triangle, the tines being attached to its equal sides, and by thus having their resisting points obliquely to the line of draught, they act more on the principle of the wedge, and consequently with greater effect and less waste of power. Although, in the first instance, I have fitted up this implement to serve as a brake or harrow, this is but one of the many uses to which it may be applied in tillage operations. 1st, By attaching tines, with triangular feet, it makes a scarifier; or, in place of tines, one large triangular blade suspended from each of its extremities or angles. 2dly, By substituting cutting wheels, in place of tines, it is converted into a sward-cutter. 3dly, From its extreme accuracy of adjustment, it will make an excellent drill or ribbing machine, and may be made to sow at the same time. And 4thly, If steam is destined ever to supersede the labour of horses in drawing the plough, this machine, from its peculiar formation, and mode of management, will afford the greatest facility for trying the experiment, as it may be made to take a number of furrows at once.

*Steam has never yet been applied to tillage*, but I am perfectly convinced of its practicability, if the weight of the engine could be reduced so as not to sink in the soil, or consolidate too much the surface on which it moved. I have not yet seen any of the portable steam threshing-machines, but expect to have one fitted up by and by, which may be applied to other important agricultural operations. Mr. Bell's reaping-machine appears to be a nearer approach to perfection than has hitherto been attained, and from

what I learned, when at Perth, has given very great satisfaction. Steam could certainly be employed to great advantage in impelling this machine, as horse power is awkwardly applied when required to push instead of to pull forward. I am, &c. — *James Wilkie. Uddingston, Oct. 17. 1829.*

The *Soude* (fig. 142.) is a watering-machine, said to be used in the neighbourhood of Avranches; and where much watering in the open air is requisite, as in the market-gardens of France and Italy, it must produce a considerable saving in labour. It is simply a cylinder of copper, brass, or tin, (wood might do) with the bottom fixed an inch or two above the lower rim, and pierced with holes like the rose of a common watering-pot, to let the water enter and escape; and there is a hole in the handle of the upper part of the utensil (*a*) to let the air escape when it is filling with water. To fill it, plunge it into a well or cistern, and, when full, let the person who carries it place his thumb on the hole (*a*), or turn the cock (*b*). To let the water escape in a fine shower, remove the thumb or return the cock. The operator should have a utensil in each hand, and the sizes may be those of common watering-pots. The *soude* is not likely to be of much use in English gardens; but one of the simplest, cheapest, and best shower baths hitherto in use may be formed from it. We shall have one constructed, and send it and the *soude* to Weir's manufactory, Oxford Street. The *soude* was brought to us from Paris by the Baron Baude, at the suggestion of M. Soulligné, late editor of the *Journal Hebdomadaire*. — *Cond.*

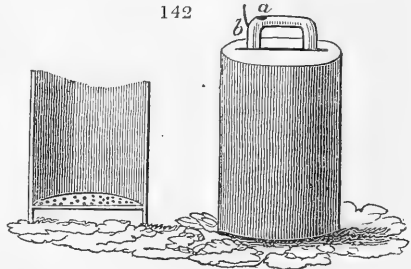

## ART. II. Foreign Notices.

### SWITZERLAND.

*EDUCATION in the Canton of Geneva.* — It is interesting to compare the state of education in our little canton with that of the neighbouring countries, France and Sardinia. In 1827, in the department of the Seine and Loire, there were 4555 young men found liable to the conscription; of these, 2925 could neither read nor write, 1511 could both read and write, 235 could only read, and 65 uncertain. In the department of the Ain there were 3095; of whom 227 could read only, 1079 who could read and write, 1718 who could neither read nor write, and 79 uncertain. In this department is the little town of Gez, on the southern declivity of Mount Jura, in which there were 198 liable to the conscription; of these 122 could read and write, 3 could read only; so that there were but 56 in 100 who could neither read nor write. In this place, therefore, which is on the frontiers of Geneva, and the Canton de Vaud, five eighths have been at school, and acquired, at least, some knowledge. In Gez also, among all the towns in the department, agriculture, breeding of cattle, and manufactures are the most flourishing. This is, however, entirely owing to its proximity to Geneva. According to the above computation, nearly two thirds of the French youths were wholly uneducated. Of the females, six eighths may be reckoned as in the same predicament. (*For. Quart. Rev., Jan.*)

*Education in Savoy.* — In Savoy, out of ten young people of both sexes, we may reckon that eight are without education, and, in the interior of the

country, for instance in the Tarantaise and Maurienne, nine. Here, in Geneva, and, for the last five years, in the Canton de Vaud, it would be difficult to find a healthy child, of ten years of age, that cannot both read and write with facility. (*For. Quart. Rev.*, Jan.)

*Education in the Canton of Argovia.*—The little council of the canton of Argovia has issued an ordinance, in order to secure the benefits of education to children who are employed in manufactories. By this ordinance the owners of all such manufactories are compelled to establish a school, and provide a proper schoolmaster to instruct the children employed by them. One hour daily, or two hours every other day, is to be allowed them for the purpose. All these schools to be under the special superintendence of the counsellors of schools. No manufacturer is allowed to receive a child into his establishment without a certificate from the clergyman of the parish that the child is of proper age. (*Ibid.*)

*In the Gymnasium at Bern* the children are taught not only the exercises of the mind, but also those of the body; to swim, to jump, to climb, to ride; a plan which seems to me excellent, as giving a wholesome direction to that restless activity of boys, which so often leads them first into mischief, and then into vice. (*Wood's Letters of an Architect*, vol. i. p. 192.)

*The Vallais* is a fine valley, much narrower here than I had imagined from my view of it from above Martigny. The mountains which bound it are steep slopes, the bottom appears flat, and, altogether, it wants variety: yet it offers some beautiful scenes, especially at the openings of the little valleys. The inhabitants are esteemed to be lazy, dirty, and goitrous, and by far the most licentious in Switzerland, but rather improving of late years. Till the road over the Simplon was made, it was one of the most unfrequented parts of the country, and it may serve as an encouragement to those who fear that good roads, and freer intercourse with their neighbours, will spoil the sobriety and simplicity of the Swiss character. (*Ibid.* p. 197.)

#### ITALY.

*Food of the lower Classes.*—On one occasion I listened to a capuchin preaching in the Coliseum: his subject was a comparison between the Virgin Mary and the river Jordan, which descends from Lebanon as the virgin descended from heaven; and he added a great deal of stuff, which you would not thank me for remembering. I asked one of the more respectable clergy why such conduct was permitted, and he pleaded that it was necessary to please the lower classes with nonsense, as hogs are fed with garbage. To amuse and to cheat the people has been too often the endeavour of those who think themselves called to rule the world; but if they vitiate the taste of the multitude, by furnishing them with unwholesome food, it is the fault of the teachers, not of the people, if the latter lose their relish for plain and salutary truths; and this argument seems to come with a very bad grace from the Roman Catholic clergy. The watchfulness over the press, and the refusal of the Scriptures to the people, can only be defended on the plea of refusing to them, not only every thing but good and wholesome food, but all such as they can by any means misdigest, if I may coin a word, and continue my metaphor. Particular truths may be hurtful at certain times; general ones are good at all times; and he who imagines that the multitude is incapable of understanding the principles which guide his own conduct, has either mistaken his way, or is led by vanity to attribute to himself a superiority over his fellow-creatures which he does not possess. (*Wood's Letters of an Architect*, vol. ii. p. 586.)

#### SICILY.

*The Botanic Garden at Palermo.*—There is a good botanic garden at Palermo, and the warmth of the climate gives us an opportunity of seeing

many of our green-house plants growing freely and in great perfection in the open air. Among them we may observe the sugar-cane, the papyrus, and the banana; and the botanist will also be gratified by meeting with many Sicilian plants, which are hardly to be seen elsewhere. The casino was designed by M. du Fourny, whom I have already mentioned to you at Paris; the general form is good, but the details do not please me. The metopes (for the order is Doric) are ornamented with different fruits. The idea is ingenious, but it ought to have exhibited the various modes of fructification, especially such as tend to elucidate the different families of plants. In the present instance, they have neither been well chosen nor well executed. (*Wood's Letters of an Architect*, p. 341.)

*Hedges in Sicily.* — About Monreale the aloe is very abundant, and I once counted ninety-eight flowering stems in one view. It is employed as a fence, but it is not a good one; for though excellent for one or two years before flowering, yet, as the old plant dies immediately afterwards, two or three years elapse before the offsets are sufficiently advanced to supply its place effectually. I sometimes, also, see the cactus employed as a fence; but, after some time, the lower part loses its prickles, and men and animals may creep through. (*Ibid.*, p. 354.)

#### NORTH AMERICA.

*Growth and Manufacture of Silk.* — During 1828, six thousand copies of a compilation on the growth and manufacture of silks were published by order of the House of Representatives in congress. This compilation contains an abridgment of all that is relative to its introduction into America. Dr. Mease, of Philadelphia, has also translated Count Hazzi's *Lehrbuch des Seidenbaues für Deutschland*, and published it with plates. (*New York Farmer and Hort. Rep.*, Oct. 1828.)

*The Maize* was the finest I had seen, having stalks 14 ft. in height, abundantly furnished with ears of grain (*helotes*), in which, I was informed, a minute and very venomous snake is sometimes secreted. Here the delicious cherimoyer flourishes in a wild state; roses are absolutely weeds. Among some neglected peach trees I saw an orange tree covered with fruit. (*Lyon's Mexico*.)

*Gooseberry in Albany.* — The gooseberry has not been extensively cultivated among us, and our assortment is but indifferent. The fruit is very liable to be blighted by mildew ere it is half formed, and we know no remedy for the evil. (*Communicated to Mr. Saul from a Correspondent at Albany*, Nov. 7. 1828.)

*Sugar made from the Water-Melon.* — It has been discovered in the state of South Carolina, that a very fine quality of sugar may be extracted from the water-melon, which grows in great perfection there. The landlord of a public-house has shown that all the sugar used in his house during the preceding twelve months, and which had passed as the finest cane, had been obtained from water-melons of his own raising. (*Newsp.*, Jan. 1829.)

*General Education.* — The New England states and New-York have made the most liberal provision for the instruction of the people. It appears from a note in Mr. Cooper's book, that there were in the last-mentioned state in 1825, without including 656 schools from which no returns were made, 7775 common schools, which were supported wholly, or in part, by the public, and attended by 425,000 scholars. Besides the means afforded for the lowest elements of education, the state of New-York has a fund which has contributed largely to classical schools, and endowments to no inconsiderable extent have been made to colleges. Other provinces have been equally munificent; and congress, in authorising the admission of new states into the union, has made to them distinct

appropriations of public lands for common schools, and for the establishment of colleges. (*Rev. of Cooper's Notions of the Americans*, in *Westminster Rev.* for Jan. 1829, p. 66.)

---

ART. III. *Domestic Notices.*

ENGLAND.

*PRESTON Institution for the Diffusion of Knowledge.* — On Thursday night last, Mr. John Dewhurst, mason and slater, gave a historical lecture on architecture, to the members of the above institution. The lecture was well attended, and Mr. Dewhurst gave an elaborate account of the science, from the earliest ages to its perfection by the Grecians and Romans, which he exemplified by many well executed drawings from the most celebrated buildings of the ancient architects. He lamented the decline of the science, and concluded his lecture by exhorting his fellow-members, such as masons, joiners, and smiths, to form themselves into classes, for the study of the qualities of stone, the strength of iron, timber, &c., attributing the many accidents from the fall of buildings to a want of this knowledge. He announced the subject of his next lecture to be, the state and progress of the art from the invasion of the Romans to the present time. He then presented the whole of the drawings, together with a beautiful model of the Choragic monument of Sycirates, which is called by the modern Athenians the "Lantern of Demosthenes," to the institution. The model was executed by Mr. Ducket, sculptor, in this town. It is composed of three distinct parts: first, a quadrangular basement; secondly, a circular colonnade, of which the intercolumniations were entirely closed; and, thirdly, a *tholus*, or cupola, with an ornament upon the crown of the dome. For this magnificent gift of Mr. Dewhurst, the members expressed their gratitude by a simultaneous clapping of hands. (*Preston Chronicle.*)

We have great pleasure in recording this attempt to diffuse architectural taste and knowledge. No description of science, or of taste, is more in want of a stimulus, especially in the country. It is remarkable that, notwithstanding the great number of societies in England for objects of utility, there should be so few for objects of taste. Scarcely one of the numerous gardening societies pays any attention to the art, as one of design or taste. We should like to see a society established for the diffusion of architectural knowledge, which a society might do by merely publishing periodically a series of desigus and details of all manner of ordinary buildings, at a price which would come within the reach of every journeyman bricklayer and carpenter. — *Cond.*

*State of the Poor in Colne.* — The labouring population at Colne, we hear, are at present suffering more severe distress than they suffered in 1825 and 1826. The wages for weaving are now something lower than they ever were at that period, and provisions are nearly one third dearer. A survey of the poor was made last week, by personal visitation at their houses, and the result is, that there are 1940 individuals (being nearly one third of the population), whose average weekly income per head, inclusive of parish relief, amounts only to 1s. 2¼d., or 2d. a day; and that there are 1248 individuals, whose average weekly income per head does not exceed 1s. 9¾d., or 3d. a day; thus there is nearly one half of the population who have not on an average above 2½d. a day to live upon. Similar returns have been obtained from the adjoining townships, with nearly the same results. It is added, that preparations are making for forwarding to government a

memorial on this unnatural state of society. Surely it forms a strong ground of appeal on the subject of the corn laws. (*Bolton Chron.*, May 2.)

The unfortunate difference between the poor of England, and the poor of every other country in Europe is this, that being raised higher by artificial circumstances, their fall to the lowest state is so much the greater. Requiring a good deal to live even miserably, when misfortune arrives they cannot live at all. Small as may be the sum of 2*d.* a day, it would support a man in France or Germany. In all countries, the only poor who can be considered as having any fixed comfort, either in hand or in prospect, are those who derive their income direct from the produce of land; who rent or own a cottage and large garden, or who are labourers in agriculture, paid chiefly in kind, as in the northern counties. In all that relates to food and warmth, the poor of Russia and Poland are incomparably better off than the poor of England; but this evil in England, like every other evil, will work its own cure, and in proportion as it presses on the class next above them, in the same proportion will remedies be sought after and found. Nothing worth mentioning will ever be done for either the poor, the farmer, the tradesman, or the manufacturer, till the trade in corn be perfectly free. — *Cond.*

*Atherstone Self-Supporting Dispensary.* — The object of this institution is to furnish medicine to the poor, not gratuitously, but on a certain scale of payment, according to the means of the applicants. We would strongly recommend it as deserving encouragement and imitation, were we not deeply impressed with the opinion, that nine tenths of the diseases of the poor arise from want of sufficiency of good food and clothing, and from low, damp, uncomfortable cottages; and we know very well that medicine cannot do much in curing these evils. Would not the same amount laid out in soup do them more good? It is lamentable to think, that, in such a place as Atherstone, stated in the *Gazetteer of England* to contain only a population of 2500 individuals, there should have been so many as 765 under the medical treatment of this dispensary in one year. Surely this in a country population cannot be what may be called natural disease. We highly applaud the elevated motives of the members, but we can see no hopes for the poor of England but in the general diffusion of education, and in a perfectly free trade in corn and in every other raw material. The poor of England will then, and not till then, be upon an equal footing with the poor of other countries. — *Cond.*

*The Drainage of extensive Tracts of Marshy Country*, by means of steam, begins to be adopted; though it is surprising that it has not long ere now become more general in the marshy and fenny districts of the eastern coast. A steam-engine of 40-horse power, with a water-wheel of 28 ft. in diameter, has lately been erected at Misterton, near Gainsborough, for the purpose of draining upwards of 6,000 acres belonging to different proprietors, and lying in four parishes. After the engine had worked one hour, it was ascertained that the main drain running from the cars had been lowered eight inches, and that the drain into which the water was thrown, measuring from the stop-gates of the engine to the sluice-doors adjoining the Trent (which were kept closed), about three quarters of a mile in length, and about forty feet in breadth, had risen two feet. The commissioners and proprietors present, after intimating their entire satisfaction with the engine, buildings, &c., and as to the capability of the former performing the work for which it was calculated, presented the workmen, about sixty in number, with a sum of money to regale themselves, and expressed their thanks to Alfred Smith, Esq., the engineer employed on the occasion, and also to the contractors of the work, for the manner in which it had been executed. (*Farm. Jour.*, Jan. 26. 1829.)

*The A'rbutus h'ybrida*, in the Fulham Nursery, is sixteen years old, and 16 ft. high, with a large head completely covered with foliage. No frost has

ever hurt it. It is more prolific of bloom than any other species or variety, and its flowers are also much larger than those of the *Arbutus Unèdo*. The following is the origin of this plant:—

At Dr. Fothergill's, at Camberwell, was a fine specimen of the *Arbutus Andràchne*, and one season it produced ripe berries, which were given to the late Mr. Thoburn, nurseryman at Old Brompton, who was at that time celebrated for his success in raising seedlings. He was fortunate enough to raise about ten plants; I say fortunate, as I do not believe the *Andràchne* ever perfected seeds in this country but in this one instance. Several of the seedlings were sold to the amateurs of plants of that day; but Messrs. Whitley reserved one, the most dissimilar to the parent plant they could select; for though this hybrid has the deciduous bark of the *Andràchne*, yet it partakes more of the habit of *Arbutus Unèdo*; and the leaves being so much larger, and more deeply serrated, it may be called a Giant *Arbutus*. After the death of Dr. Fothergill, his plants were disposed of by public auction, and the contest for the purchase of the *Andràchne* was carried on by two spirited nurserymen of that day, till the biddings amounted to forty pounds, and I think Mr. D. Grimwood was the fortunate purchaser. — *R. W.* April 7. 1829.

*Márica Northiàna*. — I have flowered a plant this summer, which I never recollect having seen in flower before, and which is well worth the attention of all plant-growers, I mean the old *Márica Northiàna*. I put a plant of it in the hot-house last May, gave it plenty of water, and kept pulling off the suckers as they made their appearance. In August it threw up a strong spike of flowers, ten or twelve of them opening every day, for more than two months. Nothing could be more beautiful. I mean to flower a dozen or more of them every year in future. When in flower, the plants may be put in the green-house, or even out of doors. The plant above mentioned has been out this month past, and even now (November) continues to show a flower or two almost every day, and altogether there have not been less than 400 flowers upon it. I make no doubt but this plant has flowered in many places; but still it is a plant that is generally despised as worthless, and difficult to flower; but the contrary is the case, and any one who will manage it as I have mentioned, I will answer for it, will be highly gratified with the result. I often wonder you have not more communications on the best method of making plants flower, that are difficult to flower, or of cases in which the method of flowering them is not generally known. For instance, how many have been trying to flower the *Combrètum comòsum*, and wondering what sort of treatment Mr. Campbell gave his plant, when out comes the secret of fastening a piece of wire round the stem. Many of us country gardeners would be glad of as many hints of the same kind as you can find room for. I am, &c. — *Robert Reid.* *Montrath House, near Columpton, Devonshire, Nov. 8. 1828.*

*New Plants from the Caraccas*. — Mr. Fanning, the proprietor of the Botanic Garden at the Caraccas, has lately arrived in London with the following plants, most of which he considers are new to this country:— The *Arbol de Leache*, or Milk tree; *Brównea grandiflora*, *grándiceps*, and *coccínea*; *Canalindea*, Span.; a new *Hedýchium*; *Coral*, Span.; a new *Bréxia*; Velvet plant; a new *Heritièra*; *Bolivèra montàna*, *gloriòsa*; a new splendid *Polýgonum*; *Calàdium*, new species; two sorts of *Arachacha*; with a variety of other plants all new.

Mr. Fanning returns to the Caraccas in the course of a few weeks, and in the mean time he will be happy to enter into correspondence with such naturalists as may wish to avail themselves of his services. His agent is Mr. Hunneman, Queen Street, Soho.

*Garden Vases*. — Mr. Peake, a manufacturer of draining tiles, conduit pipes, and other articles of this kind, of a very superior description, at Tunstal near Newcastle, Staffordshire, has lately begun to produce em-



bossed flower-pots and ornamental garden vases, of a very superior description and very cheap. The articles are made in moulds, and the foliage and other ornaments are as sharp and as amply relieved as in sculptured productions. Mr. Peake assures us that there are roof tiles in his part of Staffordshire which have been in use for upwards of three centuries, and are still perfectly good; and that the vases and flower-pots are made of the same material as the tiles, and will last equally long. Having purchased some specimens from him, and among others a richly ornamented vase 3 ft. high for only 2*l.* 10*s.*, we can safely speak of their elegance, and from the appearance of the material we have little doubt of their durability. There are several other articles manufactured by Mr. Peake, which will deserve the attention of gardeners, agriculturists, and builders, especially his draining tiles, conduit pipes, flue tiles, and hip and valley tiles. Specimens will be sent for exhibition to Weir's manufactory, Oxford Street, and at Charlwood's seed-shop, Great Russel Street, London. — *Cond.*

Garden vases have also begun to be manufactured of very substantial and apparently durable materials, by Mr. Jones of Lambeth, who has sent us one of an elegant form and most correctly executed, as a specimen. A great number of ornamental garden vases have been lately brought from Florence by the Earl of Mansfield, and from these Mr. Jones has taken his patterns. Specimens may be seen at Mr. Charlwood's, Russel Street, Covent Garden. — *Cond.*

#### SCOTLAND.

*Fruit Market.* — *Sept. 26.* Fruit is uncommonly abundant this season, and consequently it is selling remarkably cheap. Baking apples are selling at 1*s.*, and best at 1*s.* 6*d.* a peck of 16 lbs. Pears are nearly over. Magnum Bonums are from 8*d.* to 1*s.* a dozen; Orleans 4*s.* a peck. Black damsons are selling at 6*s.* a peck: last year they sold from 18*s.* to a guinea the gallon, that is 1 peck and a half. Grapes are 1*s.* 6*d.* to 1*s.* 10*d.* a lb.

*Oct. 15.* All horticulturists agree that this is the most abundant fruit season that we have had for half a century, and the quality is not so inferior as might have been expected. Damsons from Cheshire, which are bought there for 2*s.*, sell here for 16*s.* a bushel. (*Scotsman.*)

*Village Library at Ceres.* — By the exertions of a number of the most respectable and best informed of the inhabitants, a public library was lately established in this village; and, from the support with which it has already met, we are inclined to augur favourably of its ultimate success. During its brief existence, a collection of books, amounting to upwards of 500 volumes, has already been obtained, principally as donations; and, among the various donors, we would in particular mention Mr. Robert Gourlay, as having been extremely liberal to this institution. (*Scotsman*, Sept. 17.)

*Education in Fifeshire.* — A manufacturer of the small town of Kirkaldy, the birthplace of Adam Smith, has left 80,000*l.* for the education of poor children in the seven adjoining parishes. In so far as charities are commendable at all, this is unquestionably by far the most useful kind; but as it is clear from past experience that all manner of charities are liable to be very grossly abused, we should not be sorry to see government take possession of the whole of those left for the purpose of education, and apply the income, as far as it would go, in the establishment of parochial schools, libraries, museums, and gardens, on the plan that we have elsewhere suggested. Neither should we be sorry to see the superfluous church property so applied, and livings reduced to something like what they are in Scotland. A national clergy, to be of any service to a country, must be kept so poor as to belong to the middling rather than to the higher classes. The experience of all ages proves this to be true; it equally proves that

in no age or country were the higher classes ever reformed by religion. People who are exceedingly well off in this world seldom care much about the next, nor is it our business whether they do or not. It is, however, a part of our duty to suggest every thing which we think calculated to promote the general improvement of our country, and of our fellow-creatures every where; and we cannot help directing attention to the charities for education, and to the superfluous wealth of the church.

— *Cond.*

*Loudon's Howe and Loudon's Brae.* — Two gentlemen in Perthshire, who received some of our Scotch pine seed from Hagenau, have sown it in exposed hilly situations, where the plants are to remain, without removal, till they become timber; and one gentleman has named the site of the future pine grove *Loudon's Howe*, and the other *Loudon's Brae*. We are by no means insensible to this description of honour, because we associate the idea with the durability of the earth itself. We despise a monument that can be removed by a change of property, or destroyed by the revolution of a government. Here are a valley and a hill dedicated to our memory, which will be recorded in the maps of the country, and exist, bearing our name in these maps and in this Magazine, during the remainder of the interval between the past and the next geological change of our island's surface. We feel this to be an ample gratification for the act of procuring and bringing home the seeds — in itself a pleasure. — *Cond.*

*Hot-house in Islay.* — In Islay House garden, Island of Islay, Mr. Gray erected, last year, a splendid hot-house, on a new principle, which promises to admiration. A single cluster of citrons, produced in it, consisted of four fruit, averaging each 19 in., making a total of 6 ft. 4 in. (*Scotsman*, May 2. 1829.)

*Gardening in the Shetland Islands.* — Crossing Brassa Sound, a distance of near a mile, we landed on Brassa Island, a place of considerable size, partly marsh, covered with peat moss, and partly hilly. It contains the mansion-house of the proprietor, William Morrat, Esq., standing close to the water, and surrounded by arable land, producing oats, bere, potatoes, and clover, the finest in Shetland. This gentleman has an extensive garden, maintained at considerable expense, producing cabbages, greens, turnips, carrots, parsneps, artichokes, and other hardy vegetables, with a few strawberries and peas; the peas seldom fill, from the sea breezes and the severity of the climate. It is enclosed by a high stone wall, against which a few scraggy apple trees are shown as a curiosity. The Siberian crab appears to thrive tolerably well; and the gooseberry bush, trained against the wall, produces leaves and branches in luxuriance: a few fruit of good size, ripening during the month of September, are all that repay the labour and expense. Amongst the flowers, which consisted of wild ones introduced from the sea coast, the most showy were the Seathrift (*Státice Armèria*), Persicària, Sea-catchfly (*Silène marítima*), Ragged Robin Campion (*Lýchnis flòs cùculi*), Red Campion (*Lýchnis dioíca*) the flowers of which were particularly beautiful, *Tormentilla officinàlis*, *Antirrhinum*, *I'nula*, Common Yarrow (*Achillèa Millefòlium*) with reddish-coloured flowers, &c. In front of the house, surrounded by a very high stone wall, which protects the vegetable world within from the sea breezes, is a square parterre, containing plants in full flower, partly from the hot-house, and partly from seed. Concealed from the bleak country and the surrounding ocean, it appears like fairy land, and is the finest thing of the kind that I have seen in Orkney or Shetland. Its smoothly cut grass-plots, traversed by gravel walks, resemble a bowling-green. Near the mansion is a hot-house, in which, by means of constant fires, the vegetable world prospers as well as it would do in any other country. What will give a very good idea of the state of gardening in Shetland is, that Mr. Morrat, every few years, gets a young gardener from the south country, who, though he enjoys a good

salary and every comfort, disgusted with the unsuccessful result of his labours, becomes low-spirited, and returns to a more genial climate, where his professional toils are rewarded with success. (*From Dr. Howison's MS. Notes.*)

*Spots in Leaves.* — In summer, when, after some days of fine weather, a storm happens, accompanied by a slight shower, and the sun appears immediately afterwards resuming his usual strength, his beams produce upon the flowers and leaves an effect similar to that of a burning glass, marking them here and there with round spots. Naturalists have been much puzzled about the cause, but the truth I think is this: — During fine weather a certain portion of dust is deposited by the wind upon the foliage as well as on other places. When the shower falls upon the dust, the drops collect together, and assume a rounded form, as we may observe within doors on a dusty floor, when we sprinkle a little water on it. Now, these little globules of water collecting upon the leaves act like convex glasses, and produce the same effect. If the shower happens to be heavy and to last for some time, the same effect is not produced, because the dust is by degrees washed off, and the drops of rain, losing their globular form, spread over the leaf, and cease to exert their caustic effect. (*Constable's Miscellany*, vol. x., Table Talk, p. 65.) As you invite extracts from books, I send you the above. The hypothesis is plausible, and I should like to know if it coincides with your view of the subject. Every year the leaves of the wall apples, pears, and cherries in my garden are more or less affected with these spots, and this year particularly so. The epidermis of the leaf (if I may so call it), as far as it is covered with the spot, readily separates, and, in its early stage, is occupied by a small brown maggot. — *John Ferme. Haddington, Sept. 25. 1828.*

*Snag-pruning of Trees.* — Some time ago I had occasion to be on the public road, about a mile west of Paisley, and was astonished to find, in the neighbourhood of that enlightened town, a number of fine old trees, consisting of beech, ash, and elms, on which had been committed the unmerciful operations of snag-pruning: a practice which every lover of his country should try to abolish. — *X. Y. Z. Near Renfrew, May 26. 1826.*

*List of a few of the rare Plants which have flowered in Carlourie Garden this season.* — *Mimulus moschatus*, luteus var. *rivularis*, alatus, and guttatus, *Gentiana alpina*, *Bellevàlia romana*, *Diphylleia cymosa*, *Xerophyllum asphodeloides*, *Chamælrimum carolinianum*, *Cyclamen vernum* and *repandum*, *Lýchnis fulgens*, *Aconitum volubile*, *Zigadenus glaberrimus*, *Hypoxis erecta*, *Nuttallia digitata*, *Silène regia*, *Salpiglossis atropurpurea* and *sinuata*, *Sieversia montana*, triflora, and *Péckii*, *Astrantia minor*, *Dryas integrifolia*, *Trillium pictum*, *Iris tripétala* of *Bot. Mag.* 2886: the plant figured by Mr. Sweet in *Brit. Flower Garden*, pl. 274., appears to be a distinct species. — *David Falconar. Carlourie, near Edinburgh, July 20. 1829.*

*Cállá æthiópica* (*Richárdia* of Kunth). — Having seen this plant in the open air on a terrace at Beil, in this county, where the intelligent florist, Mr. Street, informed me it stood the winter with the protection of only a little litter thrown over it, I turned out a large plant, in the beginning of last summer, at the foot of a wall with a west aspect. It throve remarkably well, and had a fine flower on it as late as the month of November. The stalk and leaves were all cut down by the subsequent frost, but I am glad to see that the root is quite safe, and that it is already beginning to throw up fresh shoots. I have little doubt (although it is marked as a green-house plant in Sweet's *Hortus Británnicus*) that the Cállá has already grown in the open air in other places; but, as it is considered by most persons as a green-house plant, I think it proper to notice it, for the purpose of introducing it as an inhabitant of our borders, to which it forms an elegant addition. The plant received no shelter from me, and I may mention (though usually treated as an aquatic) that the situation was dry, and it

was but sparingly supplied with water.—*John Ferme. Haddington, September 25, 1828.*

*A Black Cluster Vine* on a wall with an easterly aspect in the open garden at Clarkstone is now covered with numerous well-formed clusters of perfectly ripe fruit. (*Scotsman, Oct. 14.*)

*Caledonian Horticultural Society.*—A Meeting of the Council and Committee of the Horticultural Society was held in the Experimental Garden on the 1st of October. At this Meeting eight competitors produced each six different varieties of hollyhocks, in flower, raised from seed sown in 1827. All of the flowers were good; but three sets of specimens were placed apart by the Committee as superior to the others. After a very careful comparison among these three, the medal was awarded for a set which, on opening the sealed letter, was found to have been sent by Mr. William Oliver, gardener to the Earl of Rosslyn, at Dysart House.

The other two selected collections were found to have been sent by Mr. James Scott Thomson, gardener to Viscount Strathallan, Castle Strathallan, near Crieff; and by Mr. James Foulis, gardener to James Tytler, Esq., of Woodhouselee. A most splendid collection from Redbraes was presented, but not for competition. This collection consisted of no fewer than ninety varieties, many of the very best and double. Thanks were voted to Walter Dickson, Esq. for this fine exhibition.

A letter from Mr. John Macnaughton, gardener to John Wauchope, Esq., of Edmonston, was read, giving account, 1st, of a seedling nectarine; 2d, of two seedling peaches; 3d, of a seedling plum; and, 4th, of a seedling grape vine; all of which were approved of, and considered as highly promising.

The Society's silver medal was unanimously voted to Mr. John Macnaughton, for these interesting productions, and he was requested to attend to the progress of the fruits, and also to furnish grafts or buds for the Experimental Garden.

A letter from Mr. Thomas Spalding, gardener at Arthurston, was read, mentioning his having now sent (1st of October) some seedling carnations, in addition to others sent in the beginning of July, showing the long duration of the carnation season. Mr. Spalding also presented specimens of a promising seedling plum, resembling a damson in colour, though raised from seed of the green gage. The Committee recommended that Mr. Spalding should attend to this seedling plum for another season; and they voted him a copy of the half volume of the Society's *Memoirs* lately published, as a testimony of their approbation.

Specimens of a very promising seedling apple, raised by Mr. James Goodall, at the seat of the Marquess of Lothian, were presented and tried. The meeting also voted to Mr. Goodall a copy of the *Memoirs* as a testimony of their approbation.

Specimens of the new Smooth-leaved Royal George and Noblesse Peaches, and of the Elruge Nectarine, from the open wall at the new garden at Luffness, planned by the Hon. Sir Alexander Hope, were exhibited, and much admired for their size and beauty.

Mr. James Dick, gardener to the Right. Hon. Lady Mary Lindsay Crawford, at Crawford Priory, near Cupar, Fife, sent a specimen of the half-hardy melon, which originated from a seedling plant that accidentally appeared in the asparagus quarter in the fine summer of 1826, and ripened its fruit in that situation. This was now the third generation, and the fruit sent was raised in a cold frame. Although the present season has been very unfavourable, the fruit was found to be well flavoured and ripe. The Meeting likewise voted that a copy of the *Memoirs* should be presented to Mr. Dick for his zeal and attention, and they recommended to Mr. Barnet to cultivate this half-hardy melon in the Experimental Garden. (*Edin. Advert., Oct. 16.*)

## IRELAND.

*Remedies for existing Evils.* — In the *Monthly Magazine* for October is a valuable paper on the causes of the distressed and disturbed state of the country. These causes are proved to be various, but the chief of them obviously is the want of some system of providing for the poor. "Every civilised state in the world, except Ireland, has prevented the extortion of the landlords, by institutions, either springing from the nature of society, or established by positive legal enactments." The writer proposes that government should appoint a civil engineer for public works which may afford productive employment, and that the overseers of parishes be empowered to send any pauper on application, who has no occupation, to these works for employment, and to charge his wages to the township or parish wherein he was born.

"There is a chain of three lakes in Galway very near one another — Corib, Marsh, and Caira; by cutting a gallery 3,000 yards long through a limestone rock between the first and second of those lakes, an interior navigation of 50 miles would be opened up, and 17,000 acres of land now under water would be drained. The cost of the gallery is estimated at 30,000*l.*, and the value of the land gained 350,000*l.* By removing the bar of the Cashen River in Kerry, you open a navigation of 50 miles, and drain 200,000 acres of waste land. By removing a small impediment in the River of Lough Gara, a large tract of submerged land would be gained. By removing the bar of the Shannon at Athlone, you could drain a large tract of land at Lough Ree." There are, no doubt, a variety of evils in Ireland, that would probably require a variety of measures for their eradication; but it is a remarkable fact, as Mr. Nimmo, the celebrated engineer observed in his evidence before the House of Commons, that Ireland is the only country in Europe, where the landlords are not bound by law to take care of the poor. At first sight it appears not a little singular that this seeming want of feeling should exist among a people who are said to be "all heart;" but the fact may be accounted for, from the circumstance of the landlords of Ireland being for the greater part foreigners, residing in other countries. Be the cause what it will, surely the fact of there being no provision for the poor points out the justice of introducing the poor laws of England, with such amendments as they may admit of or require. This is a very simple measure, and we are convinced it would be of great service to the country in various ways. It is the only effectual method of compelling landlords to reside on their estates; or of employing a very different description of agent from what they are said to do at present. The very meetings of the vestries, that would be necessary two or three times in every year for making assessments, would do good, by the discussion it would create on individual and general interests. The Irish peasantry suffer privations greater than those of any peasantry in Europe, with a degrading degree of resignation; and this is the reason why nothing has hitherto been done for them. As it may be expected, therefore, whatever is done will originate with England in her own defence against the inundation of Irish labourers, and to lessen the expense of keeping the country in subjection. It is clearly for the interest of the Irish landlords to resist the establishment of poor-rates, as long as the superfluous population on their estates can find employment in England or elsewhere; but the moment this ceases, it will be their interest to establish a poor-rate.

But a poor-rate system established in Ireland, though it will relieve England, will do but little for the former country, unless it be joined to a system of general education. When an Irish peasant knows that himself and his offspring are sure of receiving support from the parish when it becomes necessary, he will be more regardless as to the number of children which he may bring into the world. In this as in every case, therefore, in

increasing the comforts of the poor, raise also their character by education. The writer in the *Monthly Magazine* considers education *alone* as a dangerous experiment. "Many insist upon education as a panacea for the disorders of Ireland. We deem it a dangerous experiment to leave the cure of its disorders to education *alone*; for you are only making the line of demarcation between the rich and poor still broader, by rendering the latter still poorer; adding the wants of education to those superinduced by poverty, you fling a new poison into the bitter cup of indigence; you give a new weapon to the enemies of social order." It would be well if the supporters of this opinion would tell us how much is the effect of education, and how much of habit. Educated men at present are for the most part men used to indulgences, which long habit renders wants; and these wants are attributed to education, which, in truth, alleviates, instead of producing or increasing them. The writer seems to forget, or probably he does not believe, that "knowledge is pleasure as well as power." If education teaches the poor their wants, it will also teach them how to supply them, if that be practicable, or how to endure with a good grace evils which are inevitable. Education will make them acquainted with the nature of the ameliorations of which their nature is susceptible, and enable them justly to appreciate what is done for them by government or society; it will prevent them from being worked upon by fanaticism; and will enable them to make known their sufferings to their countrymen and to other nations, and sooner or later to obtain that sympathy, and those ameliorations in their condition, which human nature and the nature of things admit of and require. — *Cond.*

*The Mulberry Plantation at Mitchel's Town, near Cork, we regret to learn, has been utterly abandoned, as has that in England, near Slough, by the British Silk Company. The cause assigned is, that the air is too humid for the vigorous health of the insect. — Cond.*

---

#### ART. IV. *Domestic Economy.*

*VARIETY in Food.* — From various experiments it appears that the chyle is of a different quality when produced from different alimentary substances; and as this nutritive fluid has to supply the various textures and juices of the body, differing in composition from each other, may not a chyle, composed of these different alimentary materials blended together, be more adapted for the purpose than that from a single substance? It is well known that a successive change of aliments is peculiarly grateful, and, indeed, almost essential to the human appetite, and that it is apt to pall on the repeated and daily use of one particular food; and that this is not a consequence of over-luxurious corruption; may be fairly inferred from the fact, that graminivorous animals are fond of a change of pasture, and of blending a variety of herbs and grass in their feeding; and birds, too, though one species of food, such as a particular grain, should be in abundance before them, delight to have a variety in their meals.

*With regard to the Modes of Cookery,* it is almost enough to say that that kind is to be preferred which, while it renders the food sufficiently tender and savoury, so as duly to excite all those organs connected with the digestive functions, yet leaves some labour for the stomach itself. On this account the roast beef and plain joints of the English seem, on the whole, preferable even to the best made dishes of the French, which either concentrate the nourishment too much, or present it in a state too nearly approaching the chyle to which it is to be reduced. (*Ed. Rev.*, Jan. 1828.)

*To make Kitchen Vegetables tender.* — When peas, French beans, and similar productions, do not boil easily, it has usually been imputed to

the coolness of the season, or to the rains. This popular notion is erroneous: the difficulty of boiling them soft arises from a superabundant quantity of gypsum imbibed during their growth. To correct this, throw a small quantity of subcarbonate of soda into the pot along with the vegetables, the carbonic acid of which will seize upon the lime in the gypsum, and free the legumes, &c., from its influence. (*Bull. des Scien. Econ.*)

*To prepare Verjuice for bottling and keeping.* — Express the juice of unripe grapes or gooseberries, without bruising the seeds, which would give a disagreeable taste to the liquor. Strain the juice through a linen cloth; bottle it, and expose it, uncorked, to the sun for six or seven days. The liquor will ferment, and a part will be lost in froth, which must be replaced every morning. When the fermentation has ceased, decant the liquor into other bottles, cork them, and place them in the cellar for use. In this way, the juice of any sour fruit as the citron, crab, &c., may be preserved, and no expense of sugar incurred till the moment it is to be used. Verjuice is much used in France as a summer beverage; a little syrup or sugar is mixed with a small part of it, which is then well shaken, and afterwards poured into a glass, and filled up with water. Gooseberry verjuice is commonly used; and, when mixed with sugar, it is sold by the confectioners of Paris, under the name of *Sirope de Groseilles* (*Gooseberry Syrup*). Any gardener or cottager might make it for himself. (*Jour. de Connoissan. Usuelles.*)

*Bread of the Shetland and Orkney Islands.*—Over those islands, with the exception of the capital towns of Kirkwall and Lerwick, the superior classes are compelled to bake their own bread, and this they do in great perfection without the assistance of yeast. Their method, which is as follows, may be adopted with great advantage in countries where yeast is difficult of attainment:—Mix two pounds of mashed potatoes with a table-spoonful of yeast (or double the quantity of porter), two table-spoonfuls of flour, and a table-spoonful of salt; beat these ingredients well together, adding as much lukewarm water as will reduce the composition to the consistency of butter. Let it stand for twenty-four hours in a closely covered earthenware jar, when it will be fit for use. For every pound of flour to be baked, take four table-spoonfuls of the composition; mix up two thirds of the flour, adding a little lukewarm water or fresh cream, then knead the remainder of the flour into the mass of dough; give it the desired shape, and let it stand four hours covered with a large dish, before it is put into the oven. Replace the composition by an equal quantity of mashed potatoes, flour, and salt, in the proportions stated above; and beat the whole together in the jar, having first poured off the liquid collected at the bottom of the vessel. Let the jar be kept well covered, in a warm place in winter, and in a cold place in summer. The loaves or rolls may not rise well on the first or second attempt; but after a few repetitions, they will be found superior to any baker's bread, and the composition, if daily renewed according to the directions, will continue for years to improve in quality. (*From Dr. Howison's MS. Notes.*)

---

#### ART. V. *Hints for Improvements.*

*THE Fine Arts as a source of Moral Improvement for the People.* — Why do not our societies for the improvement of the people avail themselves of the fine arts, as at least a powerful auxiliary in the attainment of their laudable objects? They may depend upon it, that “the ocular proof” of the miserable consequences of vice hanging on the walls of a cottage, would have more effect than a hundred moral essays bidden in the cupboard. With

the facilities which lithography and steel plates afford, infinite good might be accomplished in this way, at a very moderate expense. (*Literary Gaz.*, April 11. 1829.)

*A Mode of Existence for Gardeners.*— In a letter of Dr. Franklin to B. Vaughan, Esq., in 1784, at that time M.P. for the borough of Calne, Wiltshire, is the following remarkable paragraph :—

“ It has been computed by some political arithmetician, that if every man and woman would work four hours a day on something useful, that labour would produce sufficient to procure all the necessaries and comforts of life; want and misery would be banished out of the world, and the rest of the twenty-four hours might be leisure and pleasure.”

“ Why should poverty exist in the world ? ” &c. &c.

A celebrated gardener at Brighton [who ?] gives it as his opinion, that one acre of rich land, by the best mode of cultivation, would support a man, his wife, and three children, giving a proportionate quantity of animal food, bread, and vegetables.

I seriously would recommend ten or twenty gardeners to club their means, and, by the assistance of the friends of horticulture, an experiment might be tried as to the number of hours *now* necessary to accomplish what four hours would accomplish forty-four years ago.

The gardeners should accumulate, by their own deposits, and by donations from noblemen and gentlemen, a sufficient sum of money to purchase land enough, tithe-free, to support double their number of families, getting an equal number of the families of artisans, of a respectable class, to join with and contribute their share of capital, skill, industry, and perseverance.

Buildings could be erected at trifling cost, by means of fir poles being cut down to proper thickness and length, placed at distances of 4 or 6 ft. and in rows 6 in. apart, rods and twigs thin nailed along, and the centre filled with clay and straw, or other material of that kind, and plastered over with a little lime added to the clay, the walls coloured; a story added, if desired, and roofed with thatch or cheap composition.

I have by me a calculation of the cost of such, which I will furnish the gardeners with, if they consider it of the least service; but the sum at this moment strikes me to be not above 6*l.* for a room, exclusive of labour, which would be comparatively trifling, considering the rapidity with which such buildings could be erected.—*J. V. London, Sept. 5. 1828.*

*Trials of Green-house Plants in the open Air.*— Sir, Were all your readers and correspondents to send you lists of plants from time to time, which from their own experience and observation they found hardy enough to resist the winters in our climate, I am sure they would confer a benefit upon many of your readers; I mean those plants that have not yet been known to resist the frost in this country. I am led to make these observations from your notice of the *Digitális canariensis* in Vol. IV. p. 139.; there it is said to be “ an elegant plant from the Canary Islands, long since introduced, but by no means common.”— This plant is certainly an elegant one; but that it is by no means common seems rather surprising, as it is one of the hardiest plants we have, and ripens its seed abundantly, retaining its verdure throughout the severest winter, and is indeed quite an evergreen shrub.

*Verbena triphýlla*, changed to *Aloýsia citriodóra*, I have growing upon the east end of a vinery, and it has stood these eight years. It nearly covers the whole end of the house, and the only protection it gets is a loose mat hung over the root about 3 ft. high. By all who have seen it, it is considered to be the finest plant of the kind in this part of the country.

On this west coast of Scotland, *Cratægus glàbra* endures the severest winters without protection, in the open border. This plant is marked hardy in Donn's *Catalogue*. *Dáphne Gnídium* and *odóra*, *Pittósporum*



*Tobira*, *Camellia japonica*, and *Olea europæa* and fràgrans, stand upon a wall without protection.

I am trying some others out of doors; if they succeed, I will give you an account of them. I am, Sir, &c. — *M. A. Jan. 1. 1829.*

*Plans of Gardens and for Systematic Arrangements of Plants.* — Sir, Being amongst the earliest subscribers to the *Gardener's Magazine*, it has been with increased interest that I have perused its columns, as there is manifestly a progressive improvement in each succeeding Number. Writers of more abilities now appear in its pages, and those who were your first correspondents evidently improve in their style of arranging and transmitting their ideas. Those correspondents who intend continuing their communications deserve the highest praise and grateful thanks of every reading gardener. G. W. Johnson is more especially entitled to our thanks, for his valuable papers on Horticultural Chemistry; as is likewise "A Landscape-Gardener," for his excellent articles. I hope that practical gardeners will take the hints that the latter gentleman has given them. *Juvenis Olor*, I fear, has forgot the proposal he made, of sending the plans of the different structures in the garden plan (Vol. IV. p. 214.), which I and more of your readers would like to see if J. O., will favour us with a continuation of them [in the hands of the engraver]. I beg leave to call your attention to another subject, which opens a wide field in which to exercise the abilities of the young aspiring botanist or gardener; that is, to commence a series of plans for laying out a garden on the *Jussieuean* system of classification, where systematic arrangement will associate with the beauties of *Flora* to form at once both a flower and botanic garden; to unite nature and art together, both to be visible in the design, but by imperceptible gradations, to be always advancing to or receding from each other; and for each tribe and genus of plants, whether they be natives of plains, mountains, woods, marshes, rivers, &c., to be assigned a situation congenial to their natural habits, as far as nature and cultivation can be connected together. I shall add no more at present, but leave the hint to you and your readers. I am, Sir, yours, &c. — *J. P. January, 1829.*

*Churchyards.* — Sir, You have recommended ornamenting churchyards with trees and plants, and rendering them arboretums or flower-gardens. Allow me to suggest the idea of surrounding some of them, in rich parishes, with a colonnade or arcade, which might be built of the material cheapest on the spot, and the interior painted al fresco, as in the *Campo Santo* at *Pisa*. The interior of the colonnade of a metropolitan sepulchre might be divided into portions, allotted among the principal historical painters of the day, and the result would be a work unparalleled in the world. But, perhaps, you would like better to have the walls covered with objects of natural history, or casts of all the best pieces of sculpture in the world; to which I have no objection, provided you agree to let me have a part in my own way. The colonnades would require to be glazed like our old-fashioned conservatories. What would not such a colonnade, painted by such an artist as *Mr. Haydon*, be worth? Yours, &c. — *An Artist. May 10. 1829.*

*Transmitting the Heat of Dung by Pipes.* — I wish some of your philosophical readers would impose upon themselves the task of enquiring whether any real advantage is gained in respect to the resistance of frost, by the insertion, in the body of a hotbed, of the tubes proposed by the President of the Horticultural Society. My doubt originates in the consideration, that a given quantity of heat, being generated in a given time by the fermenting dung, is transmitted through the body of the dung to the entire external surface of the bed, and from that surface is communicated to the ambient air within the frame. The heat being transmitted from the bed into the air in so many points of the surface, the quantity of heat, transmitted at each point of contact with the air, is necessarily the less; and the entire surface is consequently cooled down to a temperature

much lower than that which exists in the centre of the dung; but there is a continual transmission of caloric from the centre to the surface, to supply this abstraction of heat at the surface. Now, if a certain portion of the caloric generated in the centre, instead of being transmitted to the surface through the body of the bed, is communicated to the ambient air through tubes, it appears probable to me that a less quantity of the caloric will be transmitted from the place where it is generated, through the body of the bed, to the several points of the surface, and thence to the ambient air, so that precisely the same quantity of caloric will be given off into the air of the frame, whether proceeding, as it does, from the internal part of the bed to the atmosphere of the frame, or transmitted partly through a tube, and partly through the residue of the surface of the bed which remains, after deducting the section of the tube. It would not be a difficult experiment to place a thermometer in the hotbed, and, after noting the heat while the tube was open, to closely cork up the tube below, or in the plane of, the surface of the hotbed; and, after an hour or two, when the transmission of the entire quantity of caloric, through the body of the dung to the surface, may be supposed to be restored, to again examine the thermometer, and if (making due allowance for the change of weather in the interval) the temperature of the air in the frame should be found just the same as it was while the tube gave passage to a part of the caloric, I confess it would not at all surprise me. Until the experiment be tried, I shall be incredulous of the effect of the President's method for resisting frost, though I fully expect that the heat, given out at the orifice of the pipe, will be greater than will be given out by any other equal area on the whole surface of the bed: but that will be gained at the expense of the residue. I am, Sir, &c. — *Causidicus*. Nov. 24. 1828.

---

ART. VI. *Garden Memorandums made during a Tour in Rutlandshire, Nottinghamshire, Lincolnshire, Yorkshire, Derbyshire, Staffordshire, Worcestershire, &c., in October, 1826.*

THE following notes were made immediately after our return, and we have not thought it necessary to rewrite them, for the sake of introducing the changes which have subsequently taken place at some of the residences mentioned, because we have not had an opportunity of seeing these changes. A few additions are made which are enclosed in brackets [ ].

*London to Wandsford, October 1.* — Passed Albany Street behind Mr. Horner's Pantheon, Colosseum, or Colliseum: the first name the most appropriate as that of its prototype in Rome; the second admissible as expressive of its colossal size; but the third absurd, as having no relation to it whatever. Saw on the lofty boundary wall, blocks and tackle projecting for hoisting up the evergreens of 20 and 30 ft. high, which are now planting in an immense wooden trough, supported on posts upwards of 20 ft. high, along the inside of the wall. The intention is to shut out from the garden of the Pantheon the view of the tops of all the surrounding houses. [Most of these boxes have been since taken down, and the wall has also been taken down and rebuilt, with a view to another arrangement.] The garden of the Colosseum will be divided into two parts, completely separated; a Swiss garden, with a cottage and waterfall, and an evergreen valley, including a conservatory; both will be "works to wonder at." — Paltry gateway into the Regent's Park, a little farther on. The steep banks of the road leading to the Highgate archway, now in a state of waste, might be made interesting and ornamental as terrace gardens to small villas. Good effect of the historical figure of Whittington, placed in the centre of the flower-garden of

the alms-houses which bear his name. Had Whittington lived in the present day, instead of these alms-houses we should have had a parochial institution, or a university, or some other medium for the diffusion of knowledge, instead of the production of comfort. [Had the late Mr. Farquhar lived in Whittington's time, he would have acted like Whittington; for no man can steal a march upon his age. All improvement is more the result of the general mind of society, than of the mind of the individual who is the immediate instrument.] Awkward approach now forming to a new villa on the left of the road near Barnet; affected as well as awkward, because the trees are not placed so as to account for the bends in the line of road. Mr. Cattley of Barnet at church, and therefore declined calling to see his fine specimen of *Psidium Cattleyanum* or Guava, which has attained a large size in his stove, and bears two crops a year of fruit, equal to the plum in the dessert, and, preserved in jam, not inferior to the Guavas of the West Indies.

*Between Stanborough and Lemsford Mills*, about twenty-one miles and a half from town, in the front garden of a cottage on the left side of the road, is a mountain ash with proliferous drooping shoots; which shoots, if grafted on a common mountain ash, or on a thorn, standard high, would probably produce a weeping tree like the weeping cherry, which was so originated. A weeping birch, from grafts of the proliferous shoots of the monstrosities called birds' nests produced on that tree, might be worth a nurseryman's attention, and also a weeping elm, of the narrow-leaved kind, from the monstrosities of the elm. A weeping birch, so originated, would be quite different in form and stature from the natural weeping birch, and, besides being an object of curiosity, would be odoriferous.—Magnificent park, and ivied, buttressed, and picturesque park wall, of Viscount Melbourne. Meagre entrance lodge, and common-looking avenue road to *Hatfield House*, a magnificent Elizabethian palace. We viewed these gardens in detail about this time last year (1825), and then, as now, found them in good order, and well stocked with common showy flowers. Around the garden front of the building the green-house plants are tastefully grouped, and the pots as completely covered with green moss as if the plants were growing in that material; the effect exceedingly good. We dislike as much to see plants in pots about a country house, as we desire to see pots of plants in the balconies, porches, and on the stair-cases of a town-house. In the country pots should never appear; even large boxes with orange trees we would sink in pits, so as to give the trees the appearance of growing in the free soil. It must be in bad taste to raise attributes about a country-house that belong to a town-house, and to give the air of a nursery garden to a place of retirement and repose. The operation of this feeling on the sensitive minds of the female part of the occupants of *Hatfield House*, in all probability led to covering these pots with moss. Some fine magnolias, myrtles, arbutuses, and laurustinuses are trained on, or fringing the basement of, the three garden fronts; but an attempt to grow *Cobæa scândens* and *pelargoniums* on the back wall and ceiling of a dark arcade is in bad taste, because in such a situation they can never be grown well. If a naked back wall, under a dark projection like this, is to be decorated, basso-relievos, or fresco paintings would be more appropriate. To render *Hatfield* what it ought to be, a little more enrichment and finish are wanting immediately round the house; and the briar hedge, boarded hut, and some other petty objects on the left, should be removed; and a good deal should be done between the entrance front and the fine old Gothic building on the right. A noble conservatory and some fine architectural terraces might be added in that direction.

Near *Biggleswade* there are fields of cucumbers on both sides of the road grown for pickling and salting, and sold in the surrounding market towns, and in Covent Garden, by the bushel. The inn at *Wandsford* is good, and

well known by its sign, indicative of the liability of this part of the country to be flooded after great rains. One of the greatest comforts of England is, that if a man travels with an agreeable companion, he may, at almost every inn, find the same comforts which he enjoys at his own house. On the Continent this can only be said of the inns of the larger towns. A solitary traveller, however, never feels himself so much alone at these inns in the evenings as he does in England. Commendable attention of the inn-keepers on this road to their gardens; some of the flower-gardens in front very well laid out, and neatly kept.

*Burleigh House, October 2.*—The entrance lodge here, unlike that at Hatfield, is suitable to the mansion, and both are truly noble. The parapet and other finishing ornaments of Hatfield, Holland House, Burleigh, Wolaton, and other houses in the same style, have for the most part reference to masonic symbols. The chimney tops at Burleigh are in the form of Grecian columns, single, coupled, or quadrupled, and in a line, square, or circular, in their plan. These columns have the effect of removing the vulgar air of stacks of chimneys in brick; but whether they will raise emotions of a grand or elevating character, instead of the other feeling, will depend on the degree of refinement which the spectator has attained in architectural knowledge and taste. A painter will certainly enjoy them much more than a scientific practical architect. The true way to judge of them, that is to determine the merit of the artist, is to consider them relatively to the age in which they were produced. In the time of Elizabeth this house must have struck with astonishment and delight; but such a building erected in modern times would be considered deficient in unity of style, and in many respects a senseless deviation from simplicity. The gardens here are not shown to strangers; but, if the gardener had not been from home, we have no doubt that, as one of the craft, we would have been favoured with a view. We saw the pictures which are admired by that superior-minded man, Mr. Hazlitt, and several of them described by him in the *New Monthly Magazine*. We hoped to have heard some of Mr. Hazlitt's remarks on particular pictures from the housekeeper, but she did not recollect the name. A mass of plantation near the lodge, and some clumps in that part of the park, are so crowded with trees as to have in a great measure defeated the object in planting them. Light is seen through their haggard stems in every direction. They ought to be immediately thinned. The true way to produce a thick and dark wood is to plant thin, or to keep thinning after having planted thick.

At *Stamford* we took a sketch of a "rolling barley-chopper." (*fig. 143.*) This being a barley-growing district, such implements are a good deal used for chopping off the awns from barley. The one figured is rolled backwards and forwards over the barley, when separated from the straw and spread out on the barn floor about 6 in. thick. At *Grantham* we took a sketch of one on a different construction. (*fig. 144.*)

This implement is applied in the manner of a turf-beater.

*Exton Hall*, having been burnt down some years ago, is in a dilapidated state, unoccupied, surrounded by untenanted out-buildings, including extensive stables, dog-kennels, hutches for hawks and ferrets, and all the other appendages of an ancient English residence of rank. It is approached by a road which can scarcely be called

public; thus the house and the naked park form a complete picture of desolation, and one cannot help wondering that such a scene should exist within a few miles of the most frequented road in England. The more

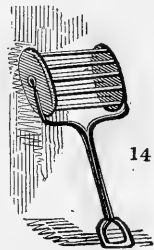
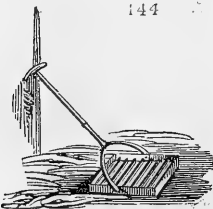

the place is examined the more is the first impression confirmed. A fire, which happened in 1810, laid half the building in ruins, and in that state it still remains. The walls of the kitchen-garden, all the pleasure-ground, which bears some interesting marks of the old style of art, and the ruins of a hot-house, built in the Dutch style, with oak rafters of ample dimensions, still remain. A temporary abode for the proprietor during his occasional visits has been formed by additions to a cottage, to which are appended a small piece of modern shrubbery and a pond; for pleasure-ground to a gentleman is a necessary of life. The church is particularly interesting from the antiquity and excellence of its family monuments. The park is extensive, but dreary; it is deficient in timber, especially near the roads, and in water; the latter is confined in detached ponds, formed by throwing dams across hollows, and is not managed with any reference to general effect. The whole place forms a fine scene for some future improver.

At *Grantham* is one of the largest manufactories in England, for agricultural implements, by Seaman and Hornsby; and an extensive iron-

mongery warehouse and manufactory, by Messrs. Rodgers and Shipman. We looked over their premises, and took sketches of the following articles:—A cast-iron frame for a grindstone (*fig. 145.*), which any person wishing to grind an instrument may turn for himself, by operating with his foot on the treadle (*a*), and which frame can be adjusted to a small or large grind-

145

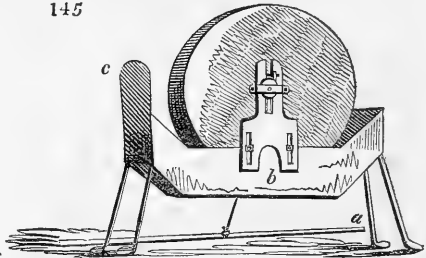

stone, or altered as the stone wears out, from the construction of the support for the gudgeon (*b*); a loose shield of sheet iron (*c*) is used to protect the operator from the water thrown off by the wheel when in motion. A daisy rake (*fig. 146.*); iron measure for filling sacks with corn (*fig. 147.*); steel-yard and

146

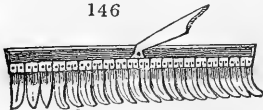

iron frame for weighing sacks (*fig. 148.*); and guard for single trees, and small groups of two or three trees, or

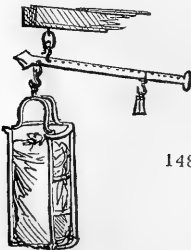

a tree and shrub planted in one hole (*fig. 149.*). We never before saw such expensive and durable fences for single trees. They can only be wanted for very particular situations; for in most parts of England trees may be got and planted, which will succeed perfectly well, of such a size as to admit

147



148 of protection by tying round them a few rods, laths, or thorn bushes, and wrapping them round with straw or with shoots of bramble, or working a wicker case on them. The adoption

149

of either of these modes is on the supposition, that the tree is closely cut in, or that if the situation is exposed, and the head entire, or nearly so, the stem must be tied to a stake. We are aware of the common assertion, that single trees cannot be grown in exposed situations, or that sufficiently large trees cannot be got, &c.; but we know, from many years' experience, that the first is only an excuse for planting unsightly lumps to nurse up



single trees, because this clumping is a cheap mode; and that the second excuse proceeds also from a false economy. Young trees with trunks of 3 or 4 in. diameter can always be spared out of young plantations; and if a gentleman has not such plantations on his own estate, he may always purchase them at a fair price of some neighbour who has such plantations to thin. If he cannot purchase them at a fair price, it will always be cheaper and better for him to purchase them at an extra-price than to grow them for himself in clumps.

*The Inn at Scarthing Moor*, and the fields and hedges in its neighbourhood, are greatly improved since we saw them in 1811, not long after the enclosure of the moor; the landlord has a large farm and keeps forty servants. The hedges, corn fields, cottages, and gardens, and the bustle of the grand north road, seemed to give this moor all the life and interest of the road between Hounslow and Windsor.

*Scarthing Moor to Gainsborough, Oct. 5.*—There is such a thing as the preparation of the mind for the first impressions expected to be received from a person and a place never before seen, and not known by description. In general, tolerably correct ideas may be formed of one individual, relatively to others of his time and rank, from the handwriting and style of his letters; and some idea of the style of a country seat, from the character of the country in which it is situated. Expected to find a flat place from the name of the county, but found it an elevated situation, commanding extensive prospects on three sides. The property is of considerable extent, the soil among the best in Lincolnshire; the farms of from 200 to 500 acres in extent, and some of the best farmeries we have seen are constructing on them; the cattle stalls are contrived for feeding with oilcake, and each ox has a stone trough or manger before it for its oilcake, chaff, or roots, and a smaller one at one side self-supplied with water. There is one of the oldest manor houses on this estate to be found any where in England. (*fig. 150.*) The oldest part is framed with oak, and filled in with brick-

150

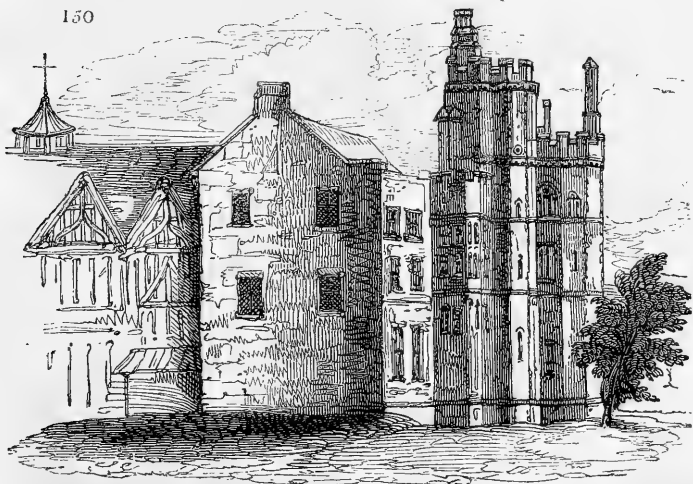

work; the oak is in complete preservation; the interior contains one apartment of spacious dimensions with the floor of plaster, the walls wainscoted,

and the fire-place an arch of the size of that of an ordinary bridge. The door of the kitchen is large enough to admit a waggon ; it is on the first floor, with an immense oak staircase. We remained at ——, making sketches, and staking out improvements till the 12th. The time was spent in beating down prejudices in favour of certain trees, hedges, and fences ; in defending the positions of certain proposed single trees and small groups ; and in opposing notions in respect to various improvements, which it was our business and duty to point out. Nothing could ever make up to us for the pain and slavery of ten days spent in this way, but the pecuniary compensation. When an artist is not great enough to be an autocrat in matters of his profession, and at the same time is not little enough to chime in with whatever is proposed to him ; when he has to address himself to a mind that is without faith in his taste, that cannot reason on what is proposed, and that has a morbid feeling of opposition to all ideas that are not already familiar ; every change which it is proposed to introduce produces a battle. At least fifty of these stormy but perfectly good-natured discussions, took place during the ten days which we remained at ——. One of these discussions our travelling companion, who acted at the time as our draughtsman and amanuensis endeavoured to commemorate by a sketch (*fig. 151.*), which, as it has been

151

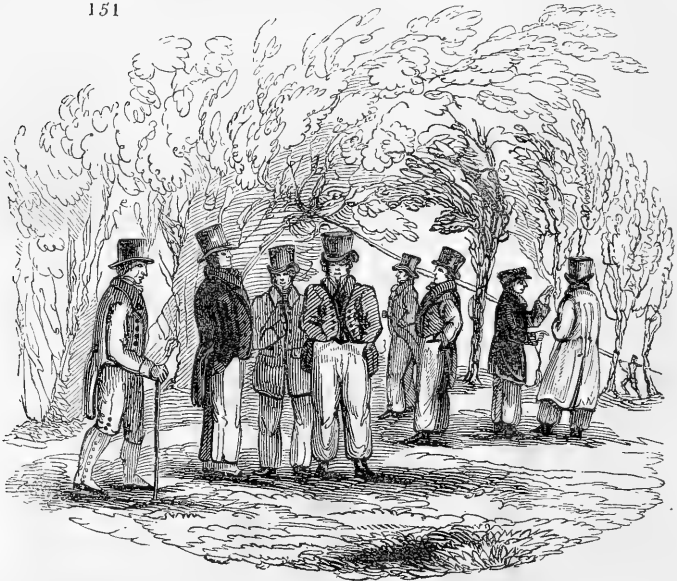

engraved at his expense, may be said to cost nothing to our readers, and as neither the names of persons nor places are mentioned, it is hoped no one will take offence where none is meant to be given. The grouping and expression may serve as hints to young gardeners learning to draw.

*Gainsborough to Retford and Barnsley.*— Passed by a fine field of cows near Marton ; they were of the long-horned breed (*Encyc. of Agr.*, § 6108.), which are preferred here for butter, as the short-horns are about London for milk. The field was a rising ground, and on the highest knoll, overlooking great part of the surrounding country, stood an open shed formed of brick pillars supporting a tiled roof in the form of a pyramid. The proportions and situation of this simple building had a most agreeable effect

(*fig. 152.*), from the suitability of the situation, the stability and simplicity of the form, and the durability of the materials. Something also must be attributed to the weather and the state of our feelings — the day being fine, and we just relieved from ten days' incessant excitement; and with money enough in our pockets for a fortnight's free enjoyment in that first of all our enjoyments, travelling in search of information. Had this building been placed in a flat field, it would probably have escaped our notice: so much does the effect of structures in the country depend on situation. In the town the

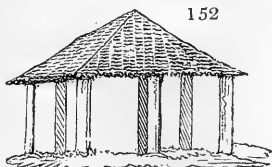

153 beauty of buildings is in a great measure absolute; in the country it is almost always relative. Draining tiles (*fig. 153.*) and the pressing plough (*fig. 154.*), are much in use in this country. The pressing plough consists of two cast-iron wheels which follow a common plough, and form two small gutters



on the back of the furrow; the furrow being laid flat to admit of two wheels passing along it. Each of these wheels is kept clean by a scraper. (*fig. 155.*)

The advantages of using the pressing plough are

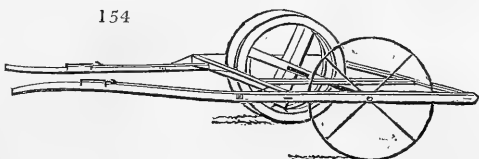

155 said to be, that the seeds root into a firm bed, and are therefore not so likely to be thrown out by the frost; and that the plants rise in rows, which admits of their being trod or harrowed between. In light sandy soils it is considered as good as dibbling; and we see no reason why a small drill should not be added to the pressing plough, so as to deposit the



seed with greater accuracy than can be done by the hand broadcast. A broad-leaved elm, apparently what is called the Scotch elm, is here common in plantations and hedge rows; its timber is superior to that of the narrow-leaved elm, and it is not apt to throw up suckers; but as it is a widely spreading tree, it is more injurious to crops: in masses or strips it is valuable, and in a park it is very desirable. Pigeons are here remarkably common. Instead of lead for the ridges of roofs stone is used, cut and painted to imitate that metal, from the ambition of being thought rich enough to use it, or at least from an allusion to the mansions of the rich; in London lead is sometimes painted in imitation of stone, to prevent the colour from attracting thieves. The lime of this part of the country, when made into mortar, sets under water; consequently external plaster and the jointing in brickwork and masonry are very durable. Plaster flooring is also common, and is at once durable and less sonorous than boarded floors; if executed on brick arches abutting on cast-iron rafters, tied by wrought-iron rods, as invented by Mr. Strut of Belper, and practised in building most manufactories, and in the whole of the building operations going on by Colonel Wildman at Newstead Abbey, they become fire proof. To turn such arches in the best manner two sizes of bricks are necessary, the smaller for the middle part of the arch. In dwelling-houses these arches and ribs may form the groundwork of very handsome coved ceilings; and if they were to become general, the improvement would be not less elegant in appearance than important as lessening the risk from fires. The roads here are generally metaled with round land or river stones, and it is a gratifying sight to see the comparatively interesting manner in which these stones are broken; we say gratifying and interesting, because breaking stones upon a public road has hitherto been considered as the lowest and dullest descrip-



tion of country labour; perhaps it is so still, but one is more reconciled to it by seeing it partake in some degree of modern improvement, and become, by the use of a machine, a species of manufacture.

[By the use of railroads and steam carriages along the sides of all our main roads, so many stones will not require to be broken. By means of locomotive stone-breaking machines, of which some are said to be already employed in Lancashire and Northumberland, this lowest degree of country manual labour may be almost entirely superseded, or probably limited to felons. We would never, at all events, send paupers on the roads; because, unless they are men of some strength, and paid by measure or the job, they will never do any good. They are heart-broken already, and to send them to break stones on a public road must be like a lingering death to them. We hope the time will come when the labours of all paupers, not able-bodied, will be confined to the workhouse gardens, and the gardens of parochial institutions. (p. 696., and p. 714.)]

The diameter of the stones to be broken according to the mode in question should not exceed 5 or 6 in. They are placed on a table of a triangular shape (*fig. 156.*), boarded on three sides like a dressing-table, but open at the narrow end, which is placed next and in front of the operator, who sits on a stool (*b*), or stands as he may choose, and has a block between him and the point of the table (*a*), the top of which is about 6 in. lower than the top of the table. By means of an iron ring fixed into a handle of wood (*fig. 157.*), he draws from the table as many of the stones as the

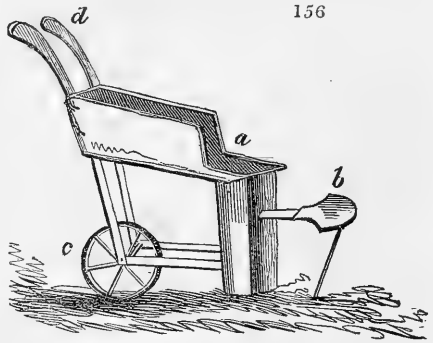

ring will enclose on the block, and then breaks them while still enclosed in the ring, which is held by his left hand. When this is done, then with another motion of the left hand, he draws them in the ring off the block till they form a heap at one side, or he at once drops them into the handbarrow measure. (*fig. 158.*) To prevent any fragments from getting to his face, he puts on a wire guard or veil (*fig. 159.*), which may be tied by a riband round his head, or suspended from his hat. In the same handbarrow, which serves as a cubic yard measure, stones are conveyed to any distance. The price paid is so much a yard. In some places the breaking apparatus consists of three separate parts, the table, the block, and the stool; in others the whole is combined in one machine, furnished with a wheel (*fig. 156. c*), which serves as one foot when the machine is stationary, and handles (*d*), by means of which it may be moved from place to place as easily as a common wheelbarrow. It only wants a light portable roof to protect the operator from the rain or sun, and a moving side to shelter him from the wind. These could be formed of sheet iron or sheet zinc, at very little expense.

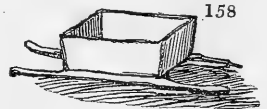

Observed some brick walls of sheds of open work, like the walls of McPhail's pits, to save materials and admit light and air; also some field walls, built in the same manner, simply for the sake of saving materials.

The zigzag walls (*Encyc. of Gard.*) we consider both better and cheaper. Enter on a country of stone walls and hilly roads.

*Wentworth House.*—Fine effect of the mausoleum from Greasborough (*fig. 160.*); of the arched gateway and appropriate alto-relievo of the head of Diana projecting over the archway. This place is in many respects one of the first in England; all the features, both of nature and art, are grand, and cooperate with each other in the general effect. What confirms us in this opinion is the perfect recollection that we had of all the main features, after a lapse of twenty years, while we had almost entirely forgotten those of some residences in the neighbourhood. It appears by our memorandum journal that we viewed Wentworth House on the 21st of Sept. 1805, and the mausoleum, breadth of lawn, masses of wood,

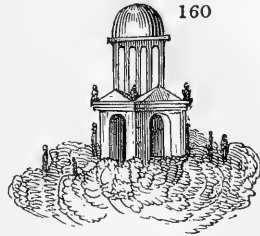

grand hall of the mansion, and straight walk in the flower-garden are noted as leading features. Some clumps are objected to in our notes of that date, which have since probably been thinned out, as we did not now observe their bad effect. After viewing the house, we went to the kitchen-garden, where Mr. Thompson showed us three stools of queen pine-plants, each of which had produced a fruit of about 5 lbs. weight early in the summer; and each of these stools had now four suckers in fruit, and this fruit of a size that would probably ripen about Christmas to 1 or 2 lbs. weight each. We also saw a sucker taken off about two months ago bearing a fruit of considerable size. The flues in the hot-houses here, at Bretton Hall, and other places, are cased with rubbed flag-stone, with a vacuity of two or three inches between the brickwork and the stone, which has a handsome appearance, prevents smoke from getting into the house, lessens the risk of overheating, and such a body of materials, by retaining a large mass of heat, lessens also the risk of overcooling in the night-time. At Bretton Hall and other places the stone covers are hollowed so as to hold water for the purpose of supplying moisture to the atmosphere (*fig. 161.*); an excellent plan, which we have generally supposed to be the

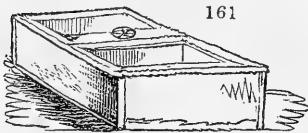

invention of the very ingenious Mr. Butler, formerly gardener to Earl Derby, and afterwards nurseryman at Prescott. Two excellent pine and grape stoves have recently been erected here, the plants in which are most luxuriant. The upper sashes are hung and balanced by

weights which rise and fall in the back shed, in the manner practised by Messrs. Richard and Clarke, and by others of Birmingham. In 1805 we saw for the first time, in the hot-houses here and at Harewood Hall, the *Passiflora quadrangulàris* in fruit. Mr. Thompson grows that very large pumpkin, known in the London seed-shops as the Mammoth, and he has had it weighing half a cwt. when ripe. It is used in soups, and keeps during the whole of the winter. One or two would supply a small family with a slice every day, for nine months in the year. We expect from him some account of the uses of this pumpkin, and the weight of the fruit now growing on his pine-stools. [It is not now (1829) too late to hear from him upon these subjects.]

All the walls of the kitchen-garden are flued, and some of them had, in 1805, projecting wooden copings. There are still a number of sashes destined for forming a temporary covering to any part of them at pleasure. Late crops of grapes and figs were now so covered, and we observed among the leaves heart-shaped pale green glasses (*fig. 162.*) filled to the widest part

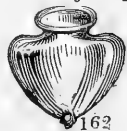

with honied water for catching flies. Mr. Thompson found this form more effective than any other. The glasses are made in Rotherham, and cost 5s. each. The New Zealand spinage is cultivated here and in other gardens in this part of the country, and much approved of as an autumn spinage. Mr. T. grows excellent crops of strawberries in Mr. Knight's manner:— 1. He pricks out the runners in beds, in July. 2. He transplants these in rows at the ordinary distance in the following spring. 3. He has a full crop the third season, and having taken three crops, he digs in the whole.

Mr. Cooper has the management of the botanic garden and pleasure-ground: he excels in the growing of hot-house plants, and especially of Scitamiñæ; he has seventeen species of Hedýchium, some of which are now finely in bloom. The pitcher plant (*Nepénthes distillatòria*) has been propagated by him, and grows vigorously; *Orchídeæ* also are very fine, and *Cactus truncàta*, *speciosa*, and *speciosissima*, with other showy plants, are well grown. *Amarýllis* and *Hedýchium*, being flowers of this season, were finely in bloom. There is an excellent collection of herbaceous plants arranged after the Linnean manner, a native flora, grass garden, rockwork, aquarium, aviary, architectural green-house, rotunda, noble terrace walk, and various other objects and scenes which a drizzling rain and the approach of night prevented us from examining so fully as we could have wished. Wretched road to Barnsley.

*Barnsley to Bretton Hall, Oct. 13.*—Handsome Gothic railing to Barnsley churchyard. (*fig. 165.*) Roads metaled with the scoria from the iron works; bad field gates, without diagonal braces. Parfaite (?), a seat on the right, finely situated for hanging gardens and water-works. Too much ground on the outside of the gate at Bretton Hall for the extent of the park within.

*Bretton Hall* has been celebrated for upwards of twenty years for its gardens, and deservedly so; and there are at present such additions and improvements going forward as will maintain this celebrity. The principal of these is a magnificent "domical" botanic stove, by Messrs. Bailey of London (*fig. 164.*), and the secondary are an elegant curvilinear vinery by the same mechanics, and several culinary hot-houses and other improvements, under the direction of Mr. M'Ewen, the gardener. A great

deal has been done here since we saw the place in 1805, and the chief thing to be regretted is that, as a whole, the pleasure-ground is so much intersected by roads, walks, and gates. Half the roads, by a little arrangement, might be done without or concealed, and some of the walks admit of improvement in their direction. The recently erected curvilinear vinery is one of the handsomest structures of the kind we ever saw, and if occasionally painted will last for ages. Of the "domical" stove, which is 60 ft. high, we shall say little, because it is not yet completed; and after it is we expect to be favoured with a plan and some account of it, after the manner of M'Arthur's paper (Vol. I. p. 105.), by Mr. M'Ewen. [Mr. M'Ewen has since left Bretton Hall, and we have therefore for the present given an elevation of the grand "domical" hot-house from the original model in the possession of Messrs. W. and D. Bailey, the manufacturers.] We cannot, however, avoid expressing our astonishment that the building containing the steam apparatus should have been erected side by side with a glass dome; it spoils every thing, and should be immediately sunk and concealed. As the ground

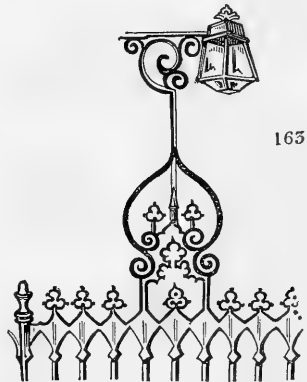

165

164

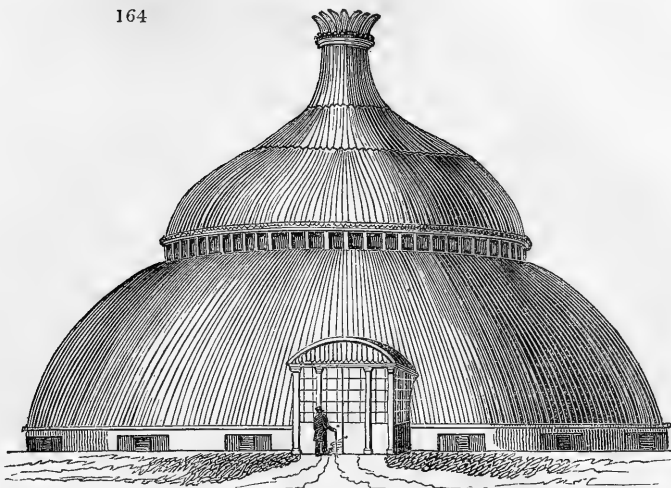

rises considerably from the site of the dome, there never was a better opportunity for carrying the smoke flue under ground, like a drain, to some distance, something in the manner practised at the lead works of Messrs. Hall and Co. near Richmond, Yorkshire, as seen by us there in 1811. The drain or flue might be carried to such a distance, as that any soot, not burned by some of the best devices for that purpose, might be deposited before the smoke escaped into the atmosphere. We wonder, indeed, that a situation was not fixed on midway between the culinary hot-houses and the botanic hot-houses, all of which it might have heated as far as was desirable. It might also have steamed hay and roots in the farmery, heated water baths, or produced vapour ones, &c., in the house, and thus done away with the numerous chimneys and clouds of dense smoke which at a distance give Bretton Hall the air of an iron foundery; in part, no doubt, owing to the nature of the coals, which give out a quantity of soot more than double that of the coals of Newcastle. The situation of the dome is excellent; it is finely backed by wood, supported by a group of three fine old oaks, and contrasted by a massy stone-built conservatory, which only requires the back to be made exactly the same as the front, to be widened, raised, and to have the roof entirely of glass. When this is done, Bretton will contain two of the most magnificent plant structures in the kingdom, in two distinct styles, and both excellent of their kind. [Both are now (1829) surpassed by the range of botanic stoves at Syon.] We might notice a number of things in the pleasure-ground and kitchen-garden here that reflect credit on the late and present gardener. There are a number of American trees and shrubs in a very thriving state;

165

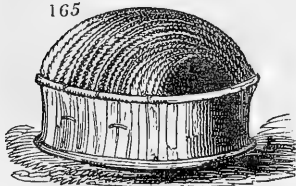

we never saw scarlet oaks in finer autumnal tint. *Cytisus purpureus*, grafted standard high on the laburnum, is singular and fine. Groups of *Rhododendron arboreum* have stood several winters protected by a cover of wickerwork (*fig. 165.*), and one of the plants has flowered.

The case or cover consists of two parts; the sides which have an iron rim at top

and bottom, and the top which has an iron rim at bottom, where it rests on the top rim of the sides; there are openings in each end of the top for giving air, with covers which fit into them. There are various other protecting cases of wickerwork, in the form of hand glasses, and of different sizes, so as to cover shrubs from 1 ft. to 6 or 8 ft. high. There are very convenient garden seats (*fig. 166*), the backs of which fold down (*a*) when they are not in use, to exclude the rain from the parts which come in contact with the clothes in sitting. Asparagus and sea-kale are forced in an excel-

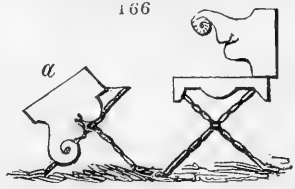

lent manner, by linings of dung or leaves in trenches between the beds, as they stand in the garden [as at Syon, p. 504.]. The sides of the beds are supported by 4 in. walls of open brickwork, like that of a M'Phail's pit; they have a narrow stone coping, and are surmounted in the forcing season by a wooden frame or box, which has openings with hinged shutters for gathering the crop. The walls are bevelled a little towards the bed, which renders them stronger; and as the dung lining shrinks in sinking, this inclination arising from the pit between being rather widest at top, compensates for the vacuity that would otherwise be formed between the dung and the brickwork, and, by preventing the contact of the former with the latter, admit of the escape of heat. We consider this by far the best plan of forcing these plants which has yet been devised. Not only do the plants produce crops annually, while when they are taken up, and forced on dung beds, they are destroyed; but, in consequence of the same plant being forced every year, their habits become changed; they vegetate early in the season, as it were of themselves, and provided the chilling rains and snows be kept from the surface of the bed by the boarded cover, and the trenches be kept full of leaves, haulm, or almost any kind of vegetable rubbish, the plants will begin to grow in December. To keep the dung or other matter in the linings from being chilled by the rain which falls on the covers, the latter ought to have gutters to carry the drip to the ends of the beds; a very judicious practice, adopted in many places, in early forcing of cucumbers, to keep the drip of the glass from chilling the linings. But asparagus and sea-kale may be forced exceedingly well in this way, by covering both beds and linings with abundance of loose litter. If the beds were on a sloping surface, they might be regularly thatched, so as to throw off the whole of the rain both from the beds and linings. To throw the rain off the beds into the linings, a layer of litter or leaves, covered with reed mats, is almost as good as boarded covers. It should not be forgotten, that loose litter does not carry off the rain which falls upon it, but merely absorbs it; and the evaporation of this water from the litter afterwards, carries off a great deal of the heat of the bed or body below. *Xanthochÿmus pictorius* was fruited here, for the first time in England, last spring; the plant, we believe, had no particular treatment. There is a handsome arcade of trellis-work over a principal walk in the kitchen-garden, which is covered with a great many sorts of apple trees, and when the trees are in fruit it is said to have an excellent effect. The dwarf apple-trees along the borders are in part trained on a cast-iron espalier rail (*Encyc. of Gard.*, p. 1579.), and in part as spiral or globular dwarfs. Mr. Duff's beds of American cranberries (Vol. I. p. 151.) are doing well; the English cranberry less so, from the supply of plants not having been abundant when the beds were formed. *Passiflora albida* and *Chianthodéndrum platanifolium* have flowered here, and the former now carried several fruit. In the conservatory different species of *Bánksia* and *Dryándra* make shoots from 3 to 6 ft. long in one season. The walks of this conser-

vatory are ornamented with lead-vases painted of a stone colour (*fig. 167.*), in which are placed pots of plants in flower; the pots concealed by saucers, which are in two parts (*fig. 168.*) and planted with succulent plants or creepers, and which fit into the top of the vase, having an opening in the centre for the stem of the plant in the pot below. By keeping these vases supplied at all seasons with plants in flower, the paths are bordered with a line of rich fringe, which contrasts well with the masses of dark green foliage of camellias, banksias, oranges, &c., in the beds.

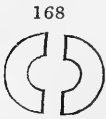

The fruit-room here, and those at Wentworth and Worksop Manor, are very completely fitted up with open shelves and drawers; the latter for the more select fruit. The names are painted on labels of tinned iron (*fig. 169.*), which can be hooked on any shelf or drawer at pleasure. There is a complete cabinet for seeds, and another for bulbs; pieces of furniture which are too generally wanting in gardens. Indeed, in almost every establishment, the whole system of garden offices, from the pot-shed and tool-house upwards to the head gardener's house, requires reformation and improvement. Every one will allow that the same progress has not been made, during the last twenty years, in these departments, as in others which more immediately strike the eye; in gardens, as in other places, the eye is to be caught first, and the understanding afterwards.



The want of good gravel in this part of the country is a considerable drawback from the beauty of garden scenery; in the kitchen-garden it is of less consequence; but we rather wonder that, in such places as Wentworth and Bretton, it should not have been thought worth while to employ Kensington gravel in the walks of the pleasure-ground, and in that part of the approach road which is within the kept ground. We think that this ought to be done at every residence having any pretensions to distinction. We have known this gravel employed in very small places in Scotland; and every body knows that it is employed in many eminent gardens in Poland and Russia, and even in India and South America. At Wentworth crushed bricks, or the *debris* of brick or tile kilns, are employed as substitutes for gravel in the kitchen-garden, and some of the walks at Bretton are of grass, with a line of flag stones along their centre. We should think a very handsome and durable walk might be formed by laying the bottom with brick rubbish, or small stones, gravel, &c., with a little lime, and then embedding a thin coat of Kensington gravel in Roman cement. Such a walk, formed with care, might be expected to last many years; no worms or weeds would rise in it, and to prevent moss from appearing it might be watered occasionally with salt water. On leaving Bretton we observed a latch with a stopper (*fig. 170. a*), for preventing a swing gate from rebounding after falling too; a very useful appendage.

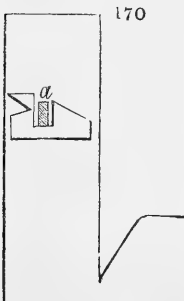

On the whole, Bretton Hall is a most unsatisfactory residence, though perhaps more money has been laid out on it than on any other place of the same extent in Britain. The grand misfortune is, that there is no marked natural situation for the house; this building, with the whole of the offices, splendid hot-houses, and gardens, is placed on an inclined plane or bank of considerable steepness, but with

scarcely any undulation or irregularity. As this bank is confronted by another of a similar character, which rises from the narrow bottom of the same streamless valley, the views from the house are either directly across to this bank, or obliquely along the bank on which it is placed. The approach road descends to the house, and that considerably, which is always bad, and here very bad. In consequence of the whole of the extensive stable-offices and farm-yard being placed between the house, and the hot-houses, kitchen-garden, and pleasure-ground, the walks to the latter objects necessarily cross both the main approach and several back roads and paths, which destroys all idea of seclusion. As the valley, and consequently the banks, lie in a direction more or less north and south, the hot-houses are, in order that they may front the sun, obliged to be built across the slope. This is very inharmonious; and as these hot-houses, and many of the leading objects, have been built at different times within the last thirty years, there is an appearance of disorder combined with abundance and magnificence, that is not favourable to grand and dignified effect. The whole of these evils, which are utterly incurable, are owing, first, to the idea of building the house in a situation unmarked by nature; secondly, to not having strongly marked the featureless situation by appropriate art; and, thirdly, to the want of a general plan for arranging the details. Some future lord of Bretton Hall will raze the whole, rebuild the house at the head of the valley, and lay out the pleasure-grounds on each side of it along the banks. We regret to be obliged to disapprove so much of this place as a whole, more especially, as, in common with every gardener and botanist in the country, we highly admire and approve the noble-minded and munificent proprietress, who so liberally spends her princely income in enriching it, and encouraging all arts and trades. No lady was ever a more liberal and kind mistress to all her servants, or a better landlady to her tenants; and that splendid exotic, the *Beaumontia decussata* (so named by the celebrated Robert Brown), will, in all future times, remind gardeners of one of the greatest patrons of their art.

(*To be continued.*)

---

ART. VII. *Steam Carriages, and their estimated Influence on Domestic and General Improvement.*

THE progress that has been made, within the last few years, in the adaptation of steam to road-carriages, has been most extraordinary; and the prospects which it holds out of human improvement are almost beyond the power of the imagination to contemplate. It is not clear to what extent steam may be applied to carriages on common roads, unless by stationary engines, or where the roads are level; but it has been proved by the experiments lately made at Liverpool, that carriages can be impelled along a railroad at the rate of upwards of 50 miles an hour. It cannot be too much, then, to conclude that, on the average of the main roads of Britain, if a railroad were laid down on one side of the common road, the travelling between all the grand points, as London, Edinburgh, Glasgow, Aberdeen, Inverness, Fort George, Greenock, Liverpool, Bristol, &c. &c. might be performed at the rate of 24 miles an hour. The cheapness of this mode of travelling is not less remarkable than its rapidity. The editor of the *Scotsman*, in a most interesting article on the subject (Oct. 21.), calculates the coach-hire per head at 1s. for 15 miles, and the hire for goods at about 2d. per ton per mile. In a work like ours, professing to record the progress of rural and domestic improvement, it cannot be considered irrelative to give the following extracts:—

“When the carriage of goods, which is now about 9*d.* or 10*d.* a ton per mile by land is reduced to 2*d.*, and when, in point of speed, one day does the work of four, the heaviest commodities, such as corn, potatoes, coals, will bear the expense of carriage for a hundred miles. The result of this will be, that the expense of living in great towns will be reduced, and the price of raw produce will rise in remote parts of the country. The facility, celerity, and cheapness of internal intercourse, contribute more, probably, to the advancement of civilisation than all other circumstances put together. Sixty or seventy years ago, the journey from Edinburgh to London occupied twenty days. At present, taking the average of all the modes of conveyance by land and water, it occupies three or four, and the quantity of travelling has increased probably twenty or thirty fold. Are we too sanguine in anticipating another increase equally great, when the time is reduced from three or four days to twenty hours, the expense almost in the same proportion, and when the traveller is put in possession of a much higher degree of ease and comfort? Let the improvement we speak of be realised, let what was once a journey of twenty days be reduced to one of as many hours, and we have not a doubt that we shall have five hundred times as much travelling as we had in the year 1760. In point of fact, when the time is reduced from eighty hours to twenty, the result is exactly the same as if Edinburgh were brought as near to London as Leicester or Birmingham; and, to pursue the comparison, when the journey was one of twenty days, the effect was the same as if Edinburgh had stood in Iceland. Besides, we must always remember that the intercourse grows in a much greater ratio than the distance is shortened. Volumes might be written without exhausting the materials for speculation arising out of such a change. To use our own words, when writing upon this subject in 1824: — ‘With so great a facility and celerity of communication, the provincial towns of an empire would become so many suburbs of the metropolis — or rather the effect would be similar to that of collecting the whole inhabitants into one city. Commodities, inventions, discoveries, opinions, would circulate with a rapidity hitherto unknown, and, above all, the intercourse of man with man, province with province, and nation with nation, would be prodigiously increased.’”

“We now look back with some pride to the series of papers which we published in the *Scotsman* on this subject four years ago, which first developed the advantages derivable from employing locomotive carriages on railways, for the purposes of commercial intercourse of all kinds. *Practical men*, as they term themselves, were shocked.\* The trial has been made, however, and the result has confirmed and even exceeded our most sanguine anticipations.”

---

“\* Mr. Nicholas Wood, one of the judges at Liverpool, published an octavo volume, in 1825, containing the result of his own experiments at Killingsworth, and inserted the following remarks in allusion to the articles in the *Scotsman*: — ‘It is far from my wish to promulgate to the world that the *ridiculous* expectations, or rather *professions* of the enthusiastic speculatist will be realised, and that we shall see engines travelling at the rate of twelve, sixteen, eighteen, or twenty miles an hour. Nothing could do more harm towards their adoption or general improvement than the promulgation of such *nonsense!*’ Mr. Wood, as the editor of the *Mechanics’ Magazine* observes, has been spared to see, not only what he declared to be ‘ridiculous’ and ‘nonsense’ reduced to an unquestionable matter of fact, but of witnessing something so much more extraordinary, that had any one hinted it to him in his days of incredulity, he would, we presume, have pronounced it to be absolute madness.”



“ A notable project is suggested in the *Journal des Debats*, in a letter from a Frankfort correspondent. This is nothing less than the formation of a canal to unite the Danube and the Rhine, and thus to secure the means of an uninterrupted navigation from the Tower of London to the Golden Horn at Constantinople, or the most distant part of the Euxine and Levant. Thus Europe might be traversed from its western to its eastern extremity by steam-boats; and travellers, without changing their conveyance, might start from the Thames to visit the ruins of Troy, or the pyramids of Egypt.”

This project was talked of at Munich when we were there about this time twelvemonth, and the engineer Bader was of opinion, that a suspension railway was greatly to be preferred, in that and in every country liable to much frost and snow. We have no doubt that the time will come when a railway will be laid down between Paris and Peking, and steam carriages employed on it. The tract of country by Berlin, Vienna, Moscow, and Astrachan, we understand, is almost level; and if the governments of Europe were to become shareholders in such a railway, there can be little doubt it would pay. In contemplating the introduction of railways and steam carriages in Russia, North America, and Australia, it seems to reduce these immense countries to the size of Britain, and viewing their extension to Asia and Africa, the travelling capacity of the whole world is brought within that of Europe. The editor of the *Scotsman* truly says that whole volumes might be written on the changes which this improvement is calculated to effect, that the French revolution sinks into nothing in comparison with it, and that the only single impulse to civilisation that has ever surpassed it is the art of printing.

“ The experiments at Liverpool have established principles which will give a greater impulse to civilisation than it has ever received from any single cause, since the press first opened the gates of knowledge to the human species at large. Even steam navigation gives but a faint idea of the wondrous powers which this new agent has put into our hands. It is no exaggeration to say, that the introduction of steam carriages on railways places us on the verge of a new era — of a social revolution of which imagination cannot picture the ultimate effects.”

There are many, no doubt, who think that we are far too sanguine in our ideas as to the practicability of establishing a system of high and equal national education (p. 692.); perhaps we may be so, but before our scheme be pronounced to be utterly impracticable, let the history of the progress of gas and of steam be deliberately considered. — *Cond.*

---

#### ART. VIII. *Hints for Breathing Places for the Metropolis, and for Country Towns and Villages, on fixed Principles.*

A LATE attempt in parliament to enclose Hampstead Heath has called our attention to the rapid extension of buildings on every side of London, and to the duty, as we think, of government to devise some plan by which the metropolis may be enlarged so as to cover any space whatever with perfect safety to the inhabitants, in respect to the supply of provisions, water, and fresh air, and to the removal of filth of every description, the maintenance of general cleanliness, and the despatch of business. Our plan is very simple; that of surrounding London, as it already exists, with a zone of open country, at the distance of say one mile, or one mile and a half, from what may be considered the centre, say from St. Paul's. (*fig.* 171.) This zone of country may be half a mile broad, and may contain, as the figure shows, part of Hyde Park, the Regent's Park, Islington, Bethnal Green, the Commercial Docks, Camberwell, Lambeth, and Pimlico; and it may be succeeded by a zone of town one mile broad, containing Kensington,

Bayswater, Paddington, Kentish Town, Clapton, Lime House, Deptford, Clapham, and Chelsea; and thus the metropolis may be extended in alternate mile zones of buildings, with half mile zones of country or gardens, till one of the zones touched the sea. To render the plan complete, it would be necessary to have a circle of turf and gravel in the centre of the city, around St. Paul's, half a mile in diameter. In this circle ought to be situated all the government offices, and central depôts connected with the administration of the affairs of the metropolis. That being accomplished, whatever might eventually become the extent of London, or of any large town laid out on the same plan and in the same proportions, there could never be an inhabitant who would be farther than half a mile from an open airy situation, in which he was free to walk or ride, and in which he could find every mode of amusement, recreation, entertainment, and instruction.

171

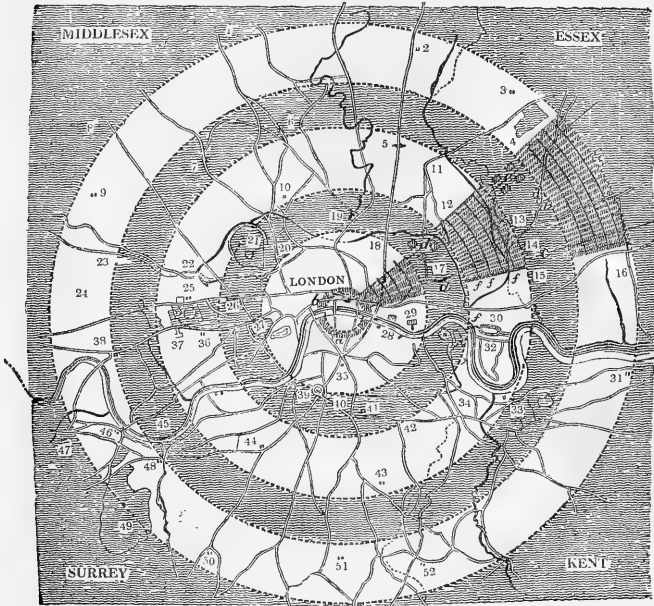

- |   |                              |                              |
|---|------------------------------|------------------------------|
| 1. Finchley Common; in the zone of country. | 17. Bethnal Green; country.  | 35. Walworth; town.          |
| 2. Tottenham; in the zone of town.          | 18. Hoxton; town.            | 36. Brompton; town.          |
| 3. Walthamstow; town.                       | 19. Islington; country.      | 37. Kensington; town.        |
| 4. Forrest House; town.                     | 20. Somers Town; country.    | 38. Hammersmith; town.       |
| 5. Stoke Newington; town.                   | 21. Regent's Park; country.  | 39. Lambeth; country.        |
| 6. Highgate; country.                       | 22. Paddington; town.        | 40. Kennington; country.     |
| 7. Hampstead; country.                      | 23. Paddington canal; town.  | 41. Camberwell; country.     |
| 8. Kingsbury; country.                      | 24. Six Elms; town.          | 42. Peckham; town.           |
| 9. Wilsdon; town.                           | 25. Bayswater; town.         | 43. Dulwich; town.           |
| 10. Kentish Town; town.                     | 26. Hyde Park; country.      | 44. Clapham; town.           |
| 11. Clapton; town.                          | 27. Green Park; country.     | 45. Fulham; country.         |
| 12. Hommertown; town.                       | 28. Southwark; town.         | 46. Putney; town.            |
| 13. Stratford; country.                     | 29. London Docks; town.      | 47. Roehampton; country.     |
| 14. West Ham; country.                      | 30. West India Docks; town.  | 48. Wandsworth; town.        |
| 15. West Ham Abbey; country.                | 31. Woolwich; town.          | 49. Wimbledon Park; country. |
| 16. East Ham; town.                         | 32. Isle of Dogs; town.      | 50. Tooting; town.           |
|   | 33. Greenwich Park; country. | 51. Norwood; town.           |
|   | 34. Deptford; town.          | 52. Sydenham; town.          |

Supposing such a plan considered desirable, it could not be carried into execution in such a metropolis as London, unless in consequence of accident or revolution, in less time than one or two centuries; because it could never be recommended to purchase and pull down so many valuable houses

as would be requisite to form the central circle of country, and the first zone of country. But were government to determine the boundaries of certain future zones, and to enact a law that no buildings now standing on the future zones of country should be repaired after a certain year, and that when such houses were no longer habitable, the owners should be indemnified for them by the transfer of other houses of equal yearly value in another part of the metropolis, belonging to government, the transition, considering the great increase that will take place in the size of London during two centuries, and the alteration in the relative value of property in consequence of the law respecting zones, would not be felt as the slightest injustice or inconvenience. Government would be justified in adopting a plan of this sort, from its obvious reference to the public welfare; and a committee being appointed to carry the law into execution would begin by purchasing such lands as were to be sold in the outskirts of the metropolis, in order to be able, at a future period, to exchange them for lands destined to form the central circle of the first zone.

In endeavouring to give an idea of the situations of the zones round London (*fig.* 171.), we have drawn the boundary lines as perfect circles; but in the execution of the project this is by no means necessary, nor even desirable. The surface of the ground, the direction of streets already existing, which it would not be worth while to alter, the accidental situations of public buildings, squares, and private gardens, with other circumstances, would indicate an irregular line, which line would at the same time be much more beautiful as well as economical.

Supposing a town to be founded on this principle, a capital for an Australian union for example; then we should propose to place all the government public buildings round the central circle, in one range (*abc*), with the house of representatives in the centre; and between it and the government buildings as many markets, churches, and play-houses as might be deemed necessary for the inner half mile of the inner zone of town. In the first and succeeding zones of country we would place the slaughtering-houses (*de*), markets, churches, burial grounds, theatres, universities, parochial institutions, workhouse gardens, botanical and zoological gardens, public picture and statue galleries, national museums, public conservatories and tea-gardens (p. 251.), gasometers, public water-works, baths and swimming ponds, sewer works, and all public buildings and places whatever not connected with the national or municipal government, and therefore belonging to the circle in the centre. The zones of town we would confine as much as possible to private dwellings, not admitting squares, burial-grounds, market-places, or any naked space, save good broad streets; because we think the closeness together of the buildings containing fires, or otherwise heated by art, would materially aid ventilation, by producing a greater rarefaction of air over them, and the advantage for business and visiting would be greater. In the zones of country we would contrive to have the hay, corn, straw, and cattle markets not far apart; and we would limit certain of the streets which proceed from the centre to the circumference, and certain also of the others which run parallel to the zones, exclusively to the supply of these markets from the distant country, and to the transfer of articles from one market to another.

All the streets of such a city we would limit to two kinds; radiating main streets communicating in direct lines from the centre to the circumference (*dc*), and concentric main streets for lateral communication (*ff*). Every alternate grand radiating street (*deg*), and concentric street (*dddh*), should be those alone by which cattle, hay, fuel, and similar bulky articles were brought to the markets, or conveyed from one market to another. In the radiating and concentric streets, alternating with these, the mails might be understood to depart; and in all the main streets, radiating and concentric, public conveyances, like the omnibuses in Paris, propelled by steam or otherwise, according to the improvements of the age and country, parcel

carriers, letter carriers, &c., might be established for ready and economical intercommunication. Every man might thus ride from any one point in the metropolis to any other point without loss of time, and at very little expense. For instance, A living in the central circle, wishes to call on B in the second zone of town; then, by the radiating coach which passes nearest B's house, he will be set down where the radiating street crosses the concentric street in which B lives; and when one of the concentric street coaches belonging to B's street passes, A will step into it and be set down at B's door. Supposing steam carriages running on railroads to be established in every street, or even in all the main streets, this might be done with inconceivable rapidity.

It is evident that every description of goods and provisions being brought in by the radiating market roads, might be distributed by the concentric market-roads, on public conveyances, and by the ordinary concentric roads on private conveyances, with as great ease as in the case of personal intercourse. Letters and books, also, could be so distributed with great facility and rapidity. Under every street we would have a sewer sufficiently large, and so contrived as to serve at the same time as a subway for the mains of water and gas, and we would keep it in view that hot water, hot oil, steam, or hot air, may in time be circulated by public companies for heating houses; and gas supplied not only for the purposes of lighting, but for those of cookery, and some for manufactures. The matters conveyed by the sewer we would not allow to be all wasted in a river; but here and there, in what we would call *sewer works*, to be placed in the country zones, we would strain the water by means of machinery, so as to gain from it almost every particle of manure held in mixture. This manure being dry from compression might be conveyed to any distance without smell or other inconvenience. The water, freed from its grosser impurities, might be raised to towers, and, by the pressure of the atmosphere, forced through pipes to tracts of country beyond the outer zone, for the purposes of irrigation.

In the country zones we should permit individuals, on proper conditions of rent and regulations, to establish all manner of rural coffee-houses, and every description of harmless amusement; and the space not occupied by these establishments, and by the public buildings before mentioned, we would lay out as park and pleasure-ground scenery, and introduce in it all the plants, trees, and shrubs which would grow in the open air, with innumerable seats, covered and uncovered, in the sun and in the shade. We would also introduce pieces of water, under certain circumstances (especially if there were no danger of it producing malaria), rocks, quarries, stones, wild places in imitation of heaths and caverns, grottoes, dells, dingles, ravines, hills, valleys, and other natural-looking scenes, with walks and roads, straight and winding, shady and open; and, to complete the whole, there should be certain bands of music to perambulate the zones, so as at certain hours to be at certain places every day in the year.

Though we have not the slightest idea that this *beau ideal* of a capital for an Australian or a European union will ever be carried into execution; and though we would rather see, in every country, innumerable small towns and villages, than a few overgrown capitals; yet we think, that, as there must probably always be some grand central cities in the world, some useful principles for regulating the manner in which each is increased may be deduced from the foregoing hints. The principle of having all the public or government buildings in the centre will apply in all cases, and so will that of radiating and concentric roads. Wherever a country town is likely to extend beyond a diameter of half a mile, we think a zone of breathing ground should be marked out as not to be built on, for the sake of the health of the poorer part of the inhabitants. In cases where towns and villages stretch along rivers, in very narrow vales,

on the ridges of hills, or in narrow stripes along the sea coast, these zones become unnecessary, because the surface of the land is supposed to be open on one or on both sides; but in by far the greater number of cases, which are continually occurring in every country, the principle of concentric zones or breathing places will be found to present advantages which no other form or disposition of breathing places could produce. In country towns or large villages, where the greater number of the inhabitants cannot be supposed to keep horses or to support steam hackney coaches, or street conveyances of anykind, the first zone or breathing place ought not to be farther from the centre than a quarter of a mile, and the exterior zones of building should not be of greater width than half a mile, in order that the inhabitants may never have more than a quarter of a mile to walk. It is much to be regretted, we think, that in the numerous enclosure acts which have been passed during the last fifty years, provision was not made for a public green, playground, or garden, for every village in the parishes in which such enclosures took place. We hope the subject will be kept in view in future enclosure bills; and we hope, also, that the legislature may not think it unworthy of their attention to take into consideration the subject of breathing places, on some systematic plan, calculated for the benefit of all ranks in all parts of the British metropolis.

---

ART. IX. *Hints for a Plan for saving the Manure lost in the Common Sewers of London, and for rendering the Thames Water fit for Domestic Purposes.*

THERE are few gardeners or agriculturists who have not regretted the immense loss of manure which takes place in London: though it is not likely that any one would think of giving up the public sewers for the sake of saving this manure; but as the time may possibly come when it may be found worth while to be as careful of the manure of cities in England, as they are of that of Brussels, Paris, and other cities on the Continent, we shall here suggest how every particle of that which now finds its way to the common sewers, and through them to the Thames, may be saved, and made up in a portable form for agricultural or gardening purposes in Britain, or exportation to any part of the world.

Along both margins of the Thames form main sewers of dimensions adequate to contain the contents of all the sewers and rivulets which now empty themselves in the Thames, between Fulham Bridge and Deptford, but which should henceforth fall into these main sewers. Continue these main sewers down the river, gradually raising the bottoms of them, till at Gravesend, or higher or lower, they delivered their contents on the surface of the ground. Proceed there as at the *poudrette* manufactories in the neighbourhood of Paris.

Instead of sewers or tunnels underground, an aqueduct might be formed by cast-iron troughs raised on columns along both margins of the river; and into these the contents of the sewers might be raised by lifting wheels, or pumps, worked by steam. These aqueducts must be raised so high as to pass over the tops of carriages at the bridges; and they must sink underground and rise up again, or be carried round on a level, where they come to docks for masted ships; or, instead of carrying the aqueducts down the river, they may be carried up, or they may recede from the river in any direction to convenient situations for depositing their contents. By raising the commencement of the aqueduct 20 or 50 ft. above the level of the river, the contents might be conveyed several miles up the country. This would certainly be the cheapest mode, but it would be attended with

the disadvantage of producing malaria in the neighbourhood of the basins where the contents were left for settling, running off, filtration, and drying.

Instead of one main sewer, or one aqueduct or more, form a well at the mouth of every sewer where it enters the Thames; filter off whatever is larger than an inch in diameter, and force through underground pipes, of adequate capacity and strength, all the liquid contents of the sewers several miles' distance into the country for evaporation and desiccation. However expensive this might be, there can be no doubt of its practicability. Notwithstanding the large size of the sewers, there are few if any of them that deliver, at an average, more fluid matter than would pass through a pipe of 2 ft. in diameter; the contents of some of them, we are persuaded, would not, at an average, fill a pipe of 1 ft. in diameter.

A better plan, and, we think, the best, would be to construct a building, 50 or 60 ft. high, rectangular, and from 50 to 100 ft. in diameter, over the mouth of each sewer. In this building there might be 30 or 40 floors, at about a foot apart, each floor being a grating or filter; commencing at the top with a filter of wire with the meshes half an inch apart, and ending with a floor of sponge. The contents of the sewer, after passing through a grating to separate bones and other matter above an inch in diameter, might be pumped up to the upper floor by the power of steam, every floor being in, say eight divisions. The discharge from the pumps might easily be so contrived as to be delivered for about five minutes at a time into the top floor of each division. From this it would filter to the bottom floor, gradually becoming purer and purer, leaving a deposit of different degrees of fineness on each floor, and coming out pure water. This would give half an hour to the deposit on each floor to dry, and to be brushed off by machinery into vats or boxes, where it might be compressed into cakes for sale. The bones and other bulky matter separated by the first filter or grating, before the liquid matter entered the well from which it is to be pumped, might be passed through a bone mill, to be worked by the same machinery, and would be found not the least valuable part of the manure. Perhaps it might be worth while to mix the ground bones, and other bulky matters ground along with them, with the finer matter procured by filtration, adding a little quicklime; by this means the cakes would be less liable to break by carriage.

The average discharge of any sewer being ascertained, it would be easy to determine the proportionate size of all the apparatus, and the whole might be roofed in with glass to admit the influence of the sun, while the sides might be formed of open weather-boarding, like the late horizontal windmill at Battersea, in order to admit a free circulation of air. The cakes of manure, or *poudrette* cakes, might be dried in a separate building, or set up in walls and thatched in the manner of unburnt bricks, mushroom spawn, or turves cut from peat bogs to be dried for fuel.

After the water had passed through the last filter of sponge, it would at least be free from all the impurities it held in mixture; and though there would remain the impurities held in combination, still these would be nothing like what mix with the water of the Thames at present.

We cannot help thinking that an apparatus of the sort contemplated, placed at the Chelsea Dolphin, would pay as a manure manufactory: and it may be worth while for the government and the water companies to consider how far the establishment of similar manufactories, at the mouths of all the sewers, would contribute to render the Thames water sufficiently wholesome for domestic purposes, which it is acknowledged not to be at present. Perhaps the time may come when the 140 sewers, which empty themselves into the Thames between Deptford and Battersea, may be let out to manure manufacturers by the city of London, as toll-gates now are.

ART. X. *Parochial Institutions ; or an Outline of a Plan for a National Education Establishment, suitable to the Children of all Ranks, from Infancy to the Age of Puberty.*

INSTEAD of pointing out the uses of education, in body, in mind, in heart, and in manners, we shall at once take it as granted —

That all human happiness and prosperity, whether public or private, domestic or national, are founded on individual cultivation.

That knowledge is pleasure as well as power ; and that of any two individuals in society, whether rich or poor, the more highly cultivated, other circumstances being the same, will possess the greater share of happiness, and will be the more valuable member of society.

That every good principle in society, to do good effectually and generally, ought to be effectually and generally applied ; and that, therefore, to raise any society or nation to the highest degree, individual cultivation should be carried to the greatest practicable extent in all classes of society.

That individual cultivation carried to its greatest practicable extent in any one society, however corrupt or misgoverned it may be, will, sooner or later, effect, in the laws and government of that society, every amelioration, and, in the people, the highest degree of happiness and prosperity of which human nature is susceptible under the given geographical circumstances.

That the education of every individual has been encouraged by government for the last thirty years in Bavaria, Wurtemberg, Baden, and other states of Germany, and has been attended with the happiest effects on all ranks in these countries ; that it reformed the government of Wurtemberg contrary to the wishes of its late king ; and that it has neutralised the animosity of different religions, and produced and maintained a marked superiority of happiness in Bavaria, Baden, and other states.\*

That a National Education Establishment in Great Britain would ultimately, by degrees, and as far as human nature admits, lead to arrangements which would correct every evil at present existing in society.

These positions being granted, we shall present an outline of what we think ought to be, I. The degree of education to be imparted ; II. The description of school buildings ; III. The qualifications and duties of the teachers ; IV. The obligations of parents, with respect to sending their children to be instructed ; V. The obligation of the parochial governments or vestries, with respect to seeing that the parents do their duty ; VI. The expense ; VII. The immediate national advantages ; and lastly, VIII. we shall notice the objections to the scheme.

We premise, however, that our plan is neither original on our part nor striking, being little more than what is already put in practice in Bavaria, Wurtemberg, and Baden. We have merely made such variations in the application of the system which has been for upwards of thirty years in use in those countries, as we think suitable to the present state of things in Britain. We by no means offer this plan as perfect : but, such as it is, we think it advisable to make it as public as possible, in order to call attention to the subject, and we shall be happy to hear all that can be suggested for or against it ; requesting only that our critics or commentators will previously

---

\* For proofs we refer to *Des E'tablissements pour l'E'ducation Publique en Bavière dans le Wurtemberg et à Bade, &c.* (1829. Paris, and Treuttell and Würtz, London. 8vo, 2s. 6d.) *Athenæum*, April 22. 1829, p. 215. *Monthly Review*, Aug. 1829, vol. xi. p. 604. *Gard. Mag.*, vol. iv. p. 487. *Mag. Nat. Hist.*, vol. i. p. 585. *The Ecclesiastic*, vol. i. p. 204. See also *Ensor on National Education*, 8vo, 1811, by far the best work that has yet appeared on the subject in any language.

inform themselves, as we have done, with regard to the plan and result of the public education in Wurtemberg, Bavaria, Baden, Silesia, and Sweden.

I. *The Degree of Education to be imparted.* —The kind and degree of education that we think ought to be given to every human being in this and in every country, and in every state of civilisation, may be thus defined:— *All the knowledge and accomplishments that a child's body or mind, and the state of knowledge and the art of teaching at the time, will admit, previously to the age of puberty; giving preference to those branches of knowledge considered the most useful, and those accomplishments and manners considered the most humanising, by the wise and good of the age.*

We consider this degree of cultivation to be as much the birthright of a child in a community where there is a high degree of civilisation, as food and clothes are its birthright in the rudest states of society; because, without it, a man or woman is ushered into society without a fair chance of being able to procure the means of subsistence and of happiness which belong to human nature, under the given degree of civilisation; in short, without a fair chance of making the most of life. To introduce an ignorant youth into a highly civilised country, under the supposition that he could obtain the requisite degree of prosperity and happiness, would be more absurd than to turn an educated child into a country of savages. This is one view of the subject, and it is a view on which all who can afford the expense act with respect to their own children.

If we regard the subject in the light of humanity, and the sympathy of one part of society with another, this principle will equally dictate the duty of bestowing, as far as practicable, that good on others which we feel to be a good in ourselves, and which we are convinced would add to the general happiness.

Viewed as a matter of public policy, and considering that the grand object of every government ought to be, with reference to its subjects, their happiness and prosperity; and, with reference to other governments, its own stability; reason dictates the use of the most important means for gaining these ends; and that it would be prudent, no less than just, in government, so to legislate, as that every individual subject should have the degree of education above defined.

Let none, therefore, exist in society who have not their minds matured by the care and culture of public teachers, as their bodies are by the nourishment and clothing of their parents. The religious and humane owe this to the poor as a part of human nature; the benevolent, as sympathising with the miseries they suffer; the enlightened, in order to raise them to their rank in the scale of creation; the rich man, to give them a greater chance of possessing property, in order that they may respect the property of others; the prudent man, that they also may become prudent; and government, that they may not be made the tools of faction, foreign or domestic.

Knowledge gives power; and if one part of society has the degree of cultivation defined, and the other has it not, it is evident that there can be very little sympathy between them. The experience of ages shows the continual tendency of the powerful in wealth or in skill to oppress the weak; and the continual tendency of the weak to react by personal force, by cunning, or by numbers, on the strong. Materials so discordant can never form the basis of a sound, healthy, and permanent state of society. The poor and ignorant, becoming, under such circumstances, little better than slaves to the rich and enlightened, regard them as their enemies, and often finding them to be such, must and will rebel; and the result is, sooner or later, a subversion of society. It would evidently contribute to the stability and harmony of society to moderate this action and reaction, by a more equal distribution of power; and, as knowledge gives power, the most obvious and effectual way of attaining the end proposed is, by



diffusing such a high and equal degree of school education as we have defined. It must be evident, we think, that the state of society which this degree of education will sooner or later produce, will include in it every amelioration and happiness of which human nature, under any given circumstances, is susceptible.

In all countries, education, in as far as it has been carried, has had the effect of rendering the poor content. Compare the poor of Sweden and Germany with those of England. The uneducated are prone to consider wealth and happiness as synonymous, a delusion which knowledge quickly dispels; philosophy teaches its fallacy, and history exemplifies it. For our part, we can see nothing in education but increased security to the rich, and increased happiness to the poor.

One of the great evils which at present afflict society in this country is over-production; not only of manufactured goods, but also of human beings. We are apt to believe that the plan proposed would remedy even this calamity; for if every labourer in the country considered a high and equal degree of education as a necessary of life, and no more to be dispensed with in a child than food or clothing, he would not think of marrying till he could bestow this degree of education on his children. If any labourer acted otherwise, he would bring himself into disgrace among his own class; he would suffer a loss of reputation for good sense and good taste; his wife and himself would no longer be able to associate with their neighbours, either from the extraordinary exertions which they must make, in order to educate their children up to the general level, or in consequence of not being able to do so, and having it done for them by the parish as paupers. The dread of the reflections and neglect of the children when they arrived at maturity, and found that they were indebted to the parish more than to their parents for their education, and that they had, in fact, to pay the parish for this education themselves, would also act as a powerful inducement to prudential conduct. Besides, when parents themselves have once enjoyed the degree of education defined, they will consider it cruel and unjust not to bestow the same degree of education on their children. This is, in fact, the feeling of all educated parents; and one great object that we have in view is to communicate the same feeling to the very lowest members of society. We are justified in concluding that universal education would do so, by what actually takes place at present among the educated classes.

But, supposing that a high and equal degree of education had no influence whatever on the amount of the population, the question is, Would any thing like the same degree of misery exist as at present? Would an enlightened superfluous population be as miserable individually, and as expensive and dangerous to the state, as an ignorant superfluous population? Unquestionably not. An enlightened superfluous population would emigrate, and try their fortune in other countries, like the superfluous population of the comparatively enlightened part of the Continent and of Britain. How is it that there are more Scotchmen to be found in other countries than either Englishmen or Irishmen? It is simply because they are taught a little more at school.

We consider that it has been satisfactorily proved, that, by means of infant schools, and the judicious application of the most improved modes of teaching after infancy, boys and girls may attain the degree of knowledge and manners contemplated in our definition by their fifteenth or sixteenth year. We would, therefore, commence with infant schools on the most approved principles, and embracing all the subjects taught in those of Edinburgh and Glasgow; ample details of which have been given, from time to time, in the *Scotsman* newspaper, and in various publications on the subject, to which it is needless to refer. In many cases, from the distance of families from the school, it would be impracticable to send infants there; but these might after-

wards attain the requisite degree of cultivation in the adult schools; in which, also, the infants should enter after a certain period, and continue, whatever might be the degree of progress they made, till the time of puberty; or say, in Britain, fourteen years for the girls, and fifteen for the boys. It is an essential part of our plan that both sexes continue till the age of puberty, because, before that age, we do not consider that their faculties, under any system of education, can be fully developed. At that age, we conceive, they may; but to educate to any period short of it, would not be just to the poor, because the children thus incompletely educated would not have a fair chance with those of parents who could afford fully to develop their children's faculties.

We know very well that the capacities of individuals are so very different, that probably no two persons are capable of deriving equal benefit from instruction; but still we would give the same opportunities to, and take the same pains with, all. Supposing education to be a fluid, we would immerse every male and female child in it, not only for the same length of time, but in order to let the rich become personally acquainted with the poor, and the poor with the rich, *in the same vessel*: in short, we would wish, as far as should be found practicable in the state of society which we contemplate, to keep the children of the rich and the poor on the same level in the public school in all respects. If in some minor details, such as equality of pocket money, and of the ornamental part of dress, we would borrow from the school system of the Jesuits, it must not be supposed on that account that we would wish to extend this jurisdiction beyond the limits of the school, and the age of puberty. At that age, those parents who could afford it might cultivate their sons and daughters by private teachers, or in superior schools, colleges, or universities, as much more as they considered necessary for the profession or part in society which their children were intended to fill. The children of the poorest, on their part, would have imbibed a sufficient degree of elementary instruction to enable any one of them of extraordinary capacity to pursue any subject, by the aid of books, as far as he chose.

The subjects to be taught as essential may be stated, as reading, writing, arithmetic, geography, drawing, geometry, anatomy, physiology, vegetable culture, the care of live stock, natural philosophy, political economy, morals, and natural theology, with a knowledge of French, and the rudiments of Latin. The accomplishments for the boys alone should be, the manual exercises, military tactics of every approved kind, swimming, wrestling, and self-defence, with and without weapons; those for both boys and girls, marching, dancing, singing, music \*, and, to a certain extent, even horsemanship. Works and accomplishments for the girls alone may be, the principles of cookery and housewifery, tailoring, hair-dressing, mantua-making, millinery, embroidery, lace-making, knitting, straw-plaiting, and such other female works as are useful in families, and for the ornament of individuals. †

We will not stop to reply to the objections which will be made to teaching girls who may never rise higher than maids of all work, and men

---

\* We would not omit this even in the case of pauper children: the guitar might be taught to boys as well as girls. It is of all musical instruments the most easily learned, and one which more than any other encourages and calls forth the exercise of the vocal powers, which after all form the most charming and agreeable part of the musical art.

† With the exception of horsemanship, swimming, and one or two other articles, all these branches are taught to the children of even the commonest labourers and paupers, in the public school in Carlsruhe. We saw the school, and received the printed half-yearly account of the progress of the pupils, in November, 1828. See *Des É'tablissemens*, &c., p. 18.

destined to be common labourers, the guitar or horsemanship, farther than to repeat that our principle is that of keeping every child at school till the age of puberty, whether he or she learn little or much; and to give to each, previously to that period, an equal chance of acquiring all useful knowledge, and as many accomplishments as possible. We wish to repeat, that our principle is that of making *no distinction between the studies of rich and poor previously to the age of puberty*, except in the single article of languages; the dead languages not being generally useful, and the most universal and easily acquired living language, the French, being sufficient for every other purpose. We contemplate, indeed, as an ultimate, and perhaps not very distant, result, the total disuse of the dead languages, except for scientific nomenclature; the universal prevalence of the English and French languages; the universal use of one nomenclature in natural history and natural science, of one system of money, weights, and measures, and, to a certain extent, of laws, religion, and government; and the total disuse of professional soldiers and sailors. We consider it good, at all events, to encourage the idea of such a result.

II. *Schools.* — We propose that there should be established in every parish at least one suitable school-house, with not fewer than three school-rooms, a room for a library and museum, and another for public lectures in the evenings for the benefit of adults; a piece of ground for a garden, and for exercises and amusements; a house for the master, and another for the mistress.\* These houses should not be liable to assessed taxes, nor their occupants to serve in the militia or as constables, &c. A plan might be given for such school-houses and gardens; but, providing that the house consist of not less than five rooms, one for the boys, one for the girls, one for the infants, a fourth room for the library and museum, and the fifth for the lecture room; the size and disposition of these rooms might be left to the vestries of particular parishes. † So might the size of the garden, provided it contained not less than an acre, and exhibited an exemplification of twelve of the Linnean classes, and of six of the orders under each of the leading subdivisions of the Jussieuan classes. The minimum accommodation of the dwelling-houses of the masters and mistresses may be three sitting-rooms and five bed-rooms. Both of the dwelling-houses and the garden ought, if possible, to be near the school; but, as this might not be always convenient, the garden, in the case of towns, might be at some distance. A few books and philosophical instruments, and an anatomical model (such as are made by Mr. Simpson, Charles Street, London), would be required to make a beginning in the museum, and to enable the master to go through the proper instructions; but these being purchased, the more wealthy parishioners would not fail to present duplicates of books, models, curiosities, &c., and no author or artist would ever fail to send specimens of his works to his native parish. Very little expense would be required to stock the garden. Twenty shillings would procure the plants requisite to illustrate the orders; or the master, if a practical botanist, might collect most of them in the fields. Nurserymen and gentlemen's gardeners, we are persuaded, would, in many cases, supply not only these plants, but all else

---

\* One house might often serve for both master and mistress; but in large parishes and in towns the mistress might often be the wife of some of the occasional teachers, as the drawing-master; or of a clergyman, or of some person in trade. Much of this part of the details must be left to circumstances, and to the vestry.

† In many, a commencement might be made in buildings already existing; even the parish churches might be made use of in this way, as in many places in Ireland. Dwelling-houses might in some cases be hired for the teachers, till certain houses in England, and others in Scotland, fell in to the parish, in consequence of the deaths of their occupiers.

that was wanted for the garden department ; and any naturalists that might be in the parish would feel a pleasure in sending articles to the museum.

III. *Teachers.*—Every school would require a properly qualified master and mistress, with assistants and occasional teachers, according to circumstances. Both master and mistress should obtain their places by competition, and be removable at the pleasure of the vestry of the parish. They should have a fixed salary from the parish, independently of a house rent free, and certain quantities of provisions, either delivered in kind, or paid in their money value. The fixed salary, we think, should not be less, in the present value of money, than 200*l.* to the master, and 200*l.* to the mistress, in order to produce efficient teachers. It ought to be the same in every parish in the empire, in order that there might be no temptations, but such as would involve in them additional activity, for a teacher to remove from one parish to another. No living ought to be lower, and no teacher ought to be allowed to hold two livings. The hopes of advancement to a teacher would be, those of being the successful competitor for a parish where there were probably several acres of ground attached to the school and school-house ; or where there were a great many pupils, and consequently a considerable amount of sessional and premium fees ; or where he might be handsomely paid for performing the offices of religion or philosophy to some sect or party on Sundays ; or where he might take boarders. But the greatest inducement of all to this profession would be what we should wish established by law ; viz. that every teacher, after a certain number of years' service, say thirty years in any one parish, or forty years in any number of parishes, ought to be allowed to retire on a third of his or her fixed salary. The retiring salary should always be paid by the parishes in proportion to the time which the retiring teacher may have lived in them. Thus, if a man had been head teacher in three parishes, ten years in each, he would be entitled, on retiring, to receive an equal portion of his salary from each of these three parishes. The fees ought to be so much per annum, according to the age of the child, and so much in addition half-yearly, according to the number of premiums awarded at the examinations of the vestry. Considering that the head teachers would always have a house rent free, fuel, light, water, and the produce of the garden, they would in every case be in easy circumstances, as such men ever ought to be ; and it would be their interest to get as many scholars as they could, for the sake of the fees of the session ; and to cultivate these scholars to as high a degree as possible, for the sake of the fee on the premiums to be awarded by the vestry half-yearly. The assistants should be paid a fixed salary, to be agreed on by the master and the vestry, and the hope of advancement to the general assistants would be that of succeeding to vacancies in head teacherships. The hope of advancement to teachers of particular branches, such as drawing, fencing, swimming, military tactics, &c., would be that of succeeding to schools where larger salaries were given for these branches.

We do not consider it necessary, as in Germany, to establish colleges on purpose to supply teachers ; because the system once commenced, an effectual demand would soon produce the requisite supply. We would also make it legal for the clergyman of any parish, to give up his duties as clergyman, and commence on the salaries and duties of parish teacher. In many cases the teacher might act both as schoolmaster and clergyman, with the exception of the duties of registering births, marriages, and deaths, which we would intrust to the vestry clerk, under the superintendence of the vestry, of which the teacher should always be a member, in right of his profession.

There ought to be one system of discipline for all the schools, and, as far as we have been able to observe and reflect on the subject, a modification of that adopted in Latymer's free school at Edmonton is the most suitable.

In conformity with this plan, a ledger may be kept, in which every child may occupy seven pages for the last seven years it is to be at school. The

page may have as many perpendicular columns as there are studies and accomplishments to be taught, with an additional one for general remarks, and as many lines across as there are weeks in the year, with two additional lines for summing up half-yearly. Taking 0 as the minimum, and 100 as the maximum, of excellence in each study and accomplishment, and also in general conduct, cleanliness, and health, every scholar ought to have his progress in studies, manners, and conduct, entered weekly, and all the columns summed up at the end of every half year would give the data for the premiums. This large book ought to lie at all times on the table of the library, for the inspection of parents and visitors; and abstracts of each examination, with the sum of each scholar's columns, ought to be printed half-yearly, and a copy preserved in the museum to be bound up in what may be called the *Transactions* of the school, and another sent to the parents as a family record, and as affording data for estimating the future characters of the children. But these, and many other details, would require further consideration. If the general idea were adopted, it might be worth while for government to offer a handsome sum for the best general plan for regulating and managing such schools. Much also must and ought to be left to the local authorities; and, above all things, no regulation ought to be introduced which would prevent the introduction of any subsequent improvement in the art of teaching.

IV. *Obligation of Parents to send their Children to the Local School.*— A law should be passed, rendering it obligatory to the parents or guardians of all children born or residing in the parish, to send such children to the parish school, under certain penalties, and with certain exceptions. The penalties may, perhaps, be left to the vestry, under defined limitations; but, with respect to this part of the law, the experience of thirty years in Germany has shown that it hardly ever requires to be enforced. As the lower classes become cultivated, they no more think of refusing education to their children than food. The exceptions may be, distance, ill health, poverty, or superiority of rank. Distance would preclude infants from being sent to the infant school, but it would not apply to boys and girls of six and seven years of age.\* Children so situated, and also those in ill health, unless independent, ought to be sent to school for some time beyond the age of puberty, so as to bring them up to the par of cultivation of the other boys and girls of that age. This also might be left to the vestry. The children of poor persons, pauper children, foundlings, &c., ought to be regularly sent to school at the expense of the parish; and it should be at the option of the vestry to require the service of such children, after they have left school, for such time as should pay back the expenses of the session fees. This repayment would not apply to foundling children, or to those of parents who, after the children were born, were, from causes not originating in misconduct, incapacitated from gaining their bread. As to persons of wealth or rank, it would be sufficient for them to satisfy the vestry that their children were properly educated somewhere. At the same time, as it was before observed, we think it would be greatly for the advantage of all classes in a parish, if the children of the rich and poor went to the same school, from infancy till the age of puberty. The effect would be to humanise both classes, and to create a sympathy between them which does not at present exist; It is evident that, by this means, both classes would know more of human nature; and “knowledge is pleasure as well as power.” It would produce a salutary feeling of gratitude to Providence, in the mind of a rich man in the enjoyment of his wealth, to be able to compare his state with that of the poor; and, in the day of adversity, it would be useful to him to be able to

---

\* Little children are taken by their elder brothers and sisters to the infant school in Marylebone, and left there in their way to the higher school.

reduce to practice his knowledge of the mode in which the poor contrive to live. It is a great thing to know how easily the wants of man are supplied, when he confines himself to what is necessary. A landlord, by mixing at school with those men who were likely to become his tenants, tradesmen, or servants, would know better what might be expected from them in these capacities; and the same as to a mistress with her future governesses, cooks, and housemaids.

To cooperate with this law rendering it obligatory to send children to school till the age of puberty, we would also render it illegal to employ any child for hire before that age.

We wish it to be distinctly understood, that we do not consider either the law obliging parents to send their children to school, or that rendering it illegal to employ children under the age of puberty, as essential parts of our plan, but rather as stimulants to put it in action; and because we know that these stimulants worked well in Germany, and especially in Bavaria, thirty years ago, when, probably, not above five in every hundred of the labouring population could read. We were every where informed in that country, in Wurtemberg, and in Baden, that these laws were now totally unnecessary. We think, however, that they might be useful in protecting pauper children, foundlings, orphans, and the children of the unfortunate and of bad characters, for which reason we should prefer commencing with them.

We are aware how unsuitable these ideas will appear to a number of minds among the higher classes, but it must not be forgotten that we are supposing our plan to have been some time in operation; and, in that case, we should regard this state of feeling in the higher classes as one of disease, which it would be for the benefit of all parties to remove, and which, in fact, circumstances would remove.

V. *Obligations of the Local Police or Vestries of Parishes.*—A law being passed by the government to render it obligatory to all parishes to establish such schools, to such an extent as to insure the education of the whole of the community, the execution of this law would devolve on the vestries of parishes. These, we think, ought to be perfectly independent of each other, and of any superior authority, in carrying the law into execution. We wish to guard, above all things, against any thing like a hierarchy or an oligarchy creeping into this system. We would impose on the parishes the duties of finding the school and garden, and paying the salaries; and we would leave it to them to judge of the efficiency of their teachers. The local press, we think, would be a sufficient check upon the evils incident to this part of the system. The teachers ought to be independent as to their manner of teaching, except that they should be obliged, for the benefit of grown-up people, to complete a course of universal knowledge in evening lectures, once in each year, in the lecture-room of the school; to lecture on every evening; and not to employ a substitute more than three times a week, without consent of the vestry.\* The Sunday evening lectures might be devoted to natural theology and morality. But as we consider the institution of vestries, though liable to abuse, as one of the best in this country, we would pass the general law by the central government, and leave it to work its way among the parishes. It would be an unspeakable satisfaction to us if the legislature were simply to pass a law, obliging the vestries of all parishes

---

\* The difficulties of giving a useful course of universal knowledge would not be great, considering that there are so many excellent encyclopædias. Even a course of public reading would be of great importance. As no one man or woman could be expected to attend every evening, a manuscript syllabus of the lectures for the past and approaching week or month should always lie on the table of the library, with references to books for such reading as would serve as a substitute for the lecture.

to provide for, and enforce the education of, all children within their jurisdiction, to the extent of reading, writing, arithmetic, drawing, geometry, and natural history\*; to provide competent teachers, who should, with their assistants, deliver evening lectures for grown-up people; and to oblige every child, not incapacitated by distance, disease, or rank, to remain at school from its sixth or seventh to its fourteenth or fifteenth year. So much information is to be obtained from books, and books are now so abundant, that it would be a great point gained if all were taught to read and understand works of science before the age of puberty, and had an opportunity of attending the evening lectures of the parish afterwards. It would also be a great point, to communicate to all some knowledge of vegetable culture, and a taste for a house and garden. To communicate a taste for architecture, we would place some thousands of miniature bricks under a shed in the garden, and offer small premiums for the best-contrived ground plans, the most ingenious miniature bridges, farm buildings, &c. (See *Des E'tablissements pour l'E'ducation Publique*, &c. p. 55.) What is powerfully desired will sooner or later be attained; and if an ardent desire for a cottage and garden were general among the youth of the laborious classes, if they could not procure that gratification here they would emigrate.

VI. *Expense*.—This, in the first instance, we would leave to every parish to raise by loans and rates, as it chose.

VII. *Immediate National Advantages*.—An immediate advantage would result to the population in remote parts of the country, from having a learned and intelligent man, a library, a museum, a botanic garden, and a course of lectures intelligible to all classes, established among them. Even the labour required to build the proper school-rooms would produce some immediate effect; and we may observe that government ought to remit the duties on all the materials used in the construction of these buildings, which would encourage the erection of ample and substantial edifices. On all books and other articles purchased for the school, during the first year after its erection, all duties should in like manner be remitted.

But the grand advantage to the country would not be fully experienced before another generation, when it may fairly be presumed that the entire mass of society would be reformed. In the mean time, in the advances to

\* Drawing is taught in all the Lancasterian schools in France, and is found almost as useful to most mechanics, carpenters, smiths, masons, &c., as writing. The great use of natural history and comparative anatomy is, that it humanises and softens the heart. If boys were acquainted with the wonderful structure of insects, and of other animals low in the scale, they would not be found sticking pins into flies, or tormenting cats; nor, when men, would they treat those noble domestic animals, the horse and the ox, with cruelty. Would any naturalist break the tail-bone of the ox, joint by joint, as is now sometimes done in Smithfield, to urge the animal forward? To instruct youth in natural history is the true way of effecting the objects of Mr. Martin of Galway's bill for preventing cruelty to animals. A knowledge of the anatomy of the human frame, which might be readily obtained at an easy expense in every parish school in the empire, by means of the admirable models lately invented, would, by showing the fearful manner in which we are made, induce even the most robust to be more careful of his health. A very slight knowledge of some of the first principles of chemistry, attraction and combination for instance, would be of the greatest use to every class of society, even to cooks; and we would have all taught something of agriculture and gardening, because, we think, in a more perfect state of society than that which now exists, almost every family, and especially all those who do not live in large cities, will possess a house of their own and a small portion of the earth's surface.

this state, various cooperating ameliorations would be introduced, till society gradually, and without those violent revolutions which must otherwise inevitably take place, attained a form more conducive to general happiness than that which now exists.

VIII. *Objections.*—These of course will be innumerable, but we shall merely indicate the answers to such as we consider will be reckoned the greatest:—

1. *Teaching all Ranks the same Things.*—This on the face of it seems unreasonable, if not absurd, and we admit it would be so, if it could be proved that any degree of instruction could be given to the children of the poor that would prevent them from earning their daily bread when they became men and women, or that would not in some way or other contribute to their happiness. It must never be forgotten, that with respect to the individual, “all knowledge is pleasure as well as power,” and that with respect to society, the effect can only be obtained by operating on individuals. If a high degree of education would not prevent the poor from working for their bread, we maintain that it would give them more enjoyment while so working; because they would feel themselves, in all things but property, on an equality with the rich; and we maintain also that an instructed poor man will be better able to gain his bread than an ignorant one, on the principle of “knowledge being power.” With respect to personal accomplishments, independently altogether of knowledge, every one will allow that they tend to humanise the feelings and soften the manners in the higher ranks. Why should they not also have the same effect in the lower? The idea of this degree of education and accomplishment raising people above their condition in society, and unfitting them for the most humble and laborious offices, was the great outcry a few years ago; but it is already become obsolete and hardly worth answering. When all are highly educated, education will then cease to be a distinction. No man whether learned or ignorant labours but from necessity, or to attain some greater good. No unambitious man or woman, surrounded by plenty of every thing, ever did or ever will labour. Men do not labour because they are ignorant, but because they have wants to be supplied. As long as these wants continue, therefore, they will labour, whatever may be their state of ignorance or of knowledge, their rudeness or politeness. So far from it being the interest of the higher ranks to keep the poor in ignorance, their true interest, nay, even the preservation of their property depends upon educating them to the utmost. If they remain without education, they will multiply in such numbers, as to eat up the rent of the lands in poor rates; if their minds be raised to the level of those of men of property and rank, they will still multiply, but they will be restrained by elevated sentiments, and a more enlightened self-love, from acts tending to their own degradation.

Education and polished manners will never unfit a man or woman for any station in society, when they cease to be distinctions; and experience has shown that in so far as individuals of the very lowest classes have been educated above those with whom they were surrounded, they have fulfilled the duties of their station better. Many examples might be given; but it is only necessary to refer to the difference in the character of the disturbances in the manufacturing districts at the present day, and their character in former years.

The nature of society is such that there always will be a lowest class, and different degrees between that class and the highest; nature has formed these differences in our physical and intellectual capacities, and by no effort of man will they ever be overcome. But as they are aggravated by wealth when joined to knowledge, and by poverty when joined to ignorance, so the introduction equally among the rich and poor of the equalising principle of knowledge, will reconcile the one class to the other; not only by approximating them, but by showing the poor in what the difference between them and the rich consists; what may be referred to skill, and what to



chance; what may be overcome, and what is inevitable. It will be an immeasurable advance in the happiness of the lower classes, to know that in the rank of mind they are on a level with the higher classes, or even nearly so. When men once know exactly what they are, they will know what they have a right to expect, and how to realise and maintain these rights.

So far from knowledge and refinement of manners unfitting men and women for being servants, and for filling the very humblest situations in life, it is a fact not to be disguised, that all cultivation of this kind tends to tame, humanise, and domesticate; and in consequence of this quality in education, and the great difference which exists in the natural capacities of individuals, our conviction is, that if all were highly and equally educated till the age of puberty, there would be a greater difference in the qualifications and capacities of men and women for employment than at present, and, in consequence, a greater number of persons fit only to become docile domestic servants, and common out-of-door labourers, than at present. As a proof that this theory is correct, we may refer to the effect of high and equal education among those classes of society where it obtains. Of 500 country gentlemen, and 500 country ladies, who have all gone through the same education, are there not a number who, if they had had their bread to gain in the world, would not have succeeded in trade or mechanics? What could these have done but become servants? At all events, let none suppose that people labour hard, or are servants, because they are ignorant; it is because they cannot help it.

2. *Teaching no particular Religion.*—This will not hinder parents from teaching their children whatever religion they choose. As children of all sects and parties are to be taught in these schools, it would evidently be wrong to infuse into them the peculiar tenets of any. This principle, indeed, is recognised by the School Society of Ireland (p. 84.), and by various other domestic and foreign institutions. Natural theology we would certainly teach them, and this is the firmest foundation for true religion. Morality would be taught on the principle of utility; because its rewards and punishments, though confined but to this life, are certain and immediate, and admit of neither doubt nor escape.

3. *Forcing Parents to send their Children to School.*—This, it will be said, is contrary to the spirit of liberty which prevails in this country. We admit that it has this appearance, but we deny that it is so much so in reality as several other existing laws. All civilisation is founded more or less on an infringement of liberty; and the infringement we propose, as compared with others, may be called one of the most salutary that ever were made. It has been mentioned to us that it would be less obnoxious to pass a law, rendering it illegal, after a certain year, to employ any person who could not prove that he had been at school till the age of puberty, or who had not a certificate indicating that he had attained a certain degree of school education; but though we should prefer this law to none at all on the subject, yet we think the preventive system of legislation greatly to be preferred. We know that this system has worked well for thirty years in Germany; and we know also, that the comparative absence of crime in the great cities on the Continent, is very much owing to the exercise of this system in the police. At the same time, let it be recollected that our object, in recommending an obligatory law, is merely to give an impulse to the scheme at its commencement, and that we do not consider it an essential part of our system, but only an essential part of its commencement.

Such is a mutilated outline of our plan, which will be found more at length in a separate tract, a few of which we have distributed among our friends. We ardently desire that the government of the country would take this subject into consideration; but as we can form some idea of the difficulties which any minister who attempted to introduce our plan would have to contend with, our chief reliance is on the public press. The actual pro-

gress which has been made in general education in the South of Germany, and the influence which this has had in raising Bavaria, the most backward and priest-ridden state in that empire, to the first rank in intelligence and prosperity, is but little known either in France or Britain. When it is, it will then be seen how very far we are behind. We hope something, also, from the example of France\*, which is making extraordinary exertions in general education. The best security for the progress of any one country is the progress of the countries by which it is surrounded. It is but reasonable in us to desire that the plan should have a fair chance of working its way among thinking people, and that the labouring classes, being thus able to form some idea of the immense importance attached by others to the education of their children, might be induced to take the subject into consideration for themselves.

But how, it may be asked, can the poor take the subject of education into consideration when they are without bread? This is certainly an afflicting question; but we shall not answer it further in this place, than to state that our plan provides that where parents cannot pay for education, payment shall be made by the vestries as in Germany. (*Mag. Nat. Hist.*, vol. i. p. 485.) If the children are without food and clothes, these also must, even in the existing state of things, be supplied by the parish. Thus, if we are not providing the poor with bread, we are at least taking none from them, while we are laying the foundation of prosperity to their offspring.

Considerable improvement might no doubt be made in the parochial management of the poor of this country; and the hired servants and labourers of occupiers of land might be rendered much more comfortable at very little expense or trouble, if vestries and landed proprietors could take a more enlightened view of their own interest: but the general question of bettering the condition of the labouring classes on a great scale, can only be considered as similar questions in political economy. If the labouring classes are suffering from want of employment, it is because the supply of labourers is greater than the demand; because in labourers, as in every thing else brought to market, there will always be an alternating superabundance and scarcity. This seems a harsh mode of treating the subject; but, we are afraid, it is the only mode that does not promise much more than it can perform. Even under a high and equal education system, the same alternation must unavoidably take place to a certain extent; but the difference in its effects would be this, that, in times of superabundance, voluntary emigration would be immediately resorted to till the balance were restored. If all were highly educated, or even so far educated at school in their early years as to be able to work out their own education after the age of puberty by reading, human existence, even in its lowest form, would be of a far higher and more refined kind than at present. Whoever lived at all, would live well and be happier; because he would have more wants, and more means of supplying them. Thoroughly and effectually create the wants and desires, and the means of gratification will as certainly follow as effect follows cause. An educated population would never submit to live on potatoes and lodge in mud hovels, as in Ireland; or on bread made from chestnuts or Indian corn, and lodge in the open air or in sheds without windows, as in some parts of Italy. If such a population could not find bread and meat and comfortable dwellings in one country, they would find them in another; or they would go to another, where they could create them. Such, in fact, are the nature and progress of civilisation in as far as it has hitherto gone.

The extraordinary effects produced in Britain by the recent and rapid improvements in machinery, have produced a corresponding extraordinary

---

\* See Lasteyrie's *Journal d'Éducation*, in 8vo numbers, monthly, and *Bulletin de la Société pour l'Enseignement Élémentaire*, also monthly.

glut of unemployed population, which it is unquestionably the duty of the government to attend to in some way or other. There is abundance of employment for this population, in the high garden cultivation of lands now under the plough; in the cultivation of waste lands; and in the execution of great national works, roads, canals, drainages, &c. But what would be the consequence of such a general stimulus to production? Unless the children of the people so employed were highly educated, so as to produce voluntary emigration among them whenever it became necessary, the evil would in a very few years be greatly increased. We confess, however, that we should wish to see the superfluous population so employed, and their children so educated, rather than that they should be compelled to emigrate. With the high degree of education to their offspring of which we have given an outline, we would take our chance of the results; and more especially as before any great addition could be made to the population, a reduction of the national debt, free trade in every thing and especially in corn, free and greatly facilitated intercourse with every other country, an increased population in these countries, and in consequence an increasing demand for our manufactures, must have taken place.

---

#### ART. XI. *Cultivation of Waste Lands.*

IN *The News*, one of the most spirited of the London Sunday newspapers, the leading article for October 4, argues the advantage that would result from a general enclosure act, and selling on long credit, or letting at very low rents, the enclosed land, in moderate portions, to the superfluous population. It seems there are upwards of 8 millions of acres of waste lands in the Scotch and English counties; or more probably, according to the writer, 10 millions of acres, and 4 millions in Ireland. Yorkshire alone contains 600,000 waste acres, and 100,000 unemployed and half-starved artisans and labourers.

To encourage the cultivation of these lands, for which there is, without doubt, abundance of capital in England, the writer proposes that all the lands so brought into cultivation, with the erections on them, and the materials used in forming these erections, should be left untaxed and untithed for 20 years. Unquestionably this degree of encouragement would soon effect the culture of the lands, and as the writer is aware, it would also reduce the rental of lands in cultivation at least one half. This he says, and we entirely agree with him, "would be a *great good in itself*: as, in the lowering of prices, it would advance the *pecuniary* capacity of the country to increase its consumption of agricultural produce (an inadequate proportion of which promotes disease and imbecility), and of our home manufactures; while it only took away from the rich the glitter and gewgaw of high life, now become so excessively artificial as to cease in its resemblance to any thing originally and substantially *English*. It is their excessive wealth which has created that eternal craving for foreign indulgences in our aristocracy, and which leads them to *reside* abroad, more than the desire of knowledge and the study of European life, which were the original inducements to travel. The rentals of land must *come down*: if they do not fall from one cause, they will soon *tumble* from another. The unnational and antisocial plan of emigration, encouraged by the great landowners, will never meet the difficulty they seek to remove, viz. the growing pauperism of the country: for, as far as it now operates, it is injurious rather than beneficial, inducing the removal of *industry and capital*, more than of poverty and idleness; it is even taking away from the country, to the direct injury of the landowner himself, the *marketable demand for farms*."

“In proportion as any country possesses extensively and finely cultivated land, it holds the *basis* of all real wealth. The abundance of wholesome food for the people is the best security of their allegiance and their content. Comfort is the greatest *anti-radical* principle in Europe. You may trace its operation on all the *rats* of distinguished life. Let the powers that be duly consider the admirable properties of this specific, which never fails them among the *comparatively great*; and weigh well the advantages of administering a *larger proportion* of it to the middle and lower classes. They would soon find their account in such a policy.”

“A general enclosure act, under the advantages which we have named, would give *seventy thousand* additional yeomen and farmers to the state; there would be a general break up of unprofitable speculations in commerce; and men of capital would take their own workmen from the unprofitable loom to the remunerative plough.”

The fact noticed in the above communication, that the emigration to other countries, which is at present going on, is one of “industry and capital” instead of “poverty and idleness,” is of some importance; but, as it appears to us, nothing like so great as the writer seems to imagine. Till the price of transport be so reduced as to come within the means of all, or till experience has rendered emigration unattended with difficulty, in even the humblest labourer, the good which will result from it will certainly be much less than it otherwise would be; but we must not forget to take into account the demand which the capital thus carried abroad will create there for British manufactures. It might even, we think, be argued, that this capital will do more good to Britain, when employed in her colonies, than when employed at home, more particularly if commerce, and especially that in corn, were free, so as to render our manufactures sufficiently cheap to meet the competition of other countries, now manufacturing as well as we, and rapidly accumulating capital.

It is not very likely that the landlords of the country will voluntarily consent to a measure, which, if brought fully into operation, will reduce their rentals one half; but they may possibly be compelled to do it. In the mean time the poor now out of employment would be benefited by passing a general enclosure act, and taking all tithes and taxes for 20 years from portions of land not exceeding 5 acres, and dwelling-houses and offices not exceeding five rooms, and a two-stalled cow-house with the usual appendages. This would at once bring a very considerable capital into activity, and the produce of the soil, being chiefly consumed by the occupiers and their families, would not have much effect in lowering the rentals of lands now in cultivation. The objection to the plan by political economists will be, that the cottagers so settled, by bringing up large families, will greatly aggravate the existing evil at some future day; but in answer to this we would say, raise the taste of the children of these cottagers by a high degree of education, and if this will not prevent the evil, it is certain it will do all to alleviate it which human government can do. An overflowing educated population must, at all events, be less dangerous than an overflowing ignorant population.

But the principal object that we have in view, in noticing this suggestion for a general enclosure act, is, to propose that if any such act should be passed there should be a clause in it providing for breathing places round all towns and villages, of extent in proportion to their population; another for allotting workhouse gardens to parishes, also in proportion to their population; and a third for gardens to Parochial Institutions. Were the common to be enclosed not situated near the town, village, or workhouse, the allotments ought still to be made; because opportunities of exchanging such allotments for others more conveniently situated to the village, the workhouse, or the Parochial Institution, might afterwards occur.

ART. XII. *The Condition of the Labouring Classes.*

IN the *Quarterly Review* for July there is an article on this subject, attributed to Dr. Southey, pregnant with interest and feeling. We shall give some extracts, which we shall introduce by observing that if the reviewer's remedies were applied, without at the same time applying a very high degree of education, the effect in twenty years would be to aggravate the disease to a fearful extent. Joining Dr. Southey's plans of amelioration with our plan of high and equal education, the combination will amount, as near as possible, to what the late excellent Mr. Stevenson, author of the *History of Discovery and Commerce*, has recommended, in the different articles on *Slaney* and *Allen* in this Magazine. (See, in particular, Vol. II. p. 183.) Even if it were contended that a high degree of education will not be so effectual in keeping the population within proper limits, as "sin and sorrow," to use the words of a clever writer, still we contend that there will be this difference between an educated and uneducated superfluous population, that while the latter will remain at home to starve, and commit crime, the former will go abroad to push their fortunes, and thus extend commerce and civilisation in every part of the world. Mr. Marshal observes of the poor of Ireland, that those who have any education emigrate and thrive, while those who have none stay at home and get hanged. It is certain that both Scotland and Switzerland would be overstocked with labourers did these not emigrate; and their doing so can only be attributed to their education. There is probably no country in the world where the labouring population superabounds to the same extent as in England, and yet there is no country from which so few labourers emigrate. This may possibly arise from various causes; but that the greatest cause is ignorance is evident from this, that the few who do emigrate are men who can read and have read. Previously to forming the idea of emigrating to another country, it is necessary to know that such a country exists, where it is situated, what advantages it holds out, and something of its history. The man who can neither read nor write is not likely to know any of these things; or, if he takes them upon hearsay, he is less likely to act on them, and, however great his sufferings, will "rather bear those ills he has, than fly to others that he knows not of."

From the Conquest to the accession of Henry VII. the population was purely agricultural. The peasantry worked hard, and fared scantily enough, but they were never in absolute want of food or dependent upon charity; the whole body was poor, but it contained no paupers. In the course of the fourteenth century, the demand for wool to supply the markets of the Netherlands and the infant manufactures of our own country, by rendering sheep-farming more profitable than aration, converted great part of the country into sheep-walks. The misery and suffering which this change of system inflicted upon the peasantry ejected from their little holdings, have been depicted in glowing language by Sir Thomas More, in his *Utopia*, who states that even the abbots, "holy men, God wot," pursued the same system, leaving no ground for tillage, and throwing every thing into sheep-pastures.

The system of English poor-laws was commenced under Elizabeth; they were very effectual in accomplishing the purposes for which they were enacted; and until the commencement of the last century, "the parochial funds of this country were expended solely upon orphans and destitute children, and upon aged and infirm persons totally unable to work; but never upon able-bodied labourers in want of employment."

In the beginning of the eighteenth century it was discovered that the division and enclosure of the common field lands and wastes would render such property more profitable, by facilitating the introduction of an improved system of tillage. The first enclosure act was passed in 1709; and

4000 enclosure acts since passed have subjected about 5000 parishes (a moiety of the whole territory of England) to the operation of these measures. The change has been a woeful one for our peasantry; a complete severance has been effected between them and the soil; "the little farmers and cotters of the country have been converted into day-labourers, depending entirely upon daily earnings, which may, and frequently in point of fact do, fail them. They have now no land upon the produce of which they can fall as a reserve whenever the demand for labour happens to be slack. This revolution is unquestionably the true cause of the heavy and increasing burthens now pressing upon the parishes in the form of poor-rates. Independently of all reasoning founded upon general principles, this is a truth capable of being substantiated by a mass of evidence, so clear, and so well authenticated, as to leave no reason for doubt. In almost every instance, the increase of poor-rates has kept pace with the progress of enclosure."

Turning to Scotland, the reviewer shows that the same system of consolidating farms led to such a band of mendicants as threatened the peace of the Lothians in the time of the celebrated Andrew Fletcher of Saltoun, who proposed to reduce the offenders to a state of personal slavery; that at present the landlords in many parts are almost annually called upon to make large advances for the maintenance of the poor; and that though they may struggle to put off, as long as they can, the day when a regular poor-rate shall be found indispensable, yet that they can no more prevent this result, than they can prevent the waters of the Tay from making their way to the ocean.

After showing the enormity of the sufferings and degradation of the poor, in various parts both of England and Scotland; that nothing but the poor-rates prevent an open rupture between the labourers and the farmers; that the better-informed among the poor are "striving politically to learn the cause of their altered state;" and that they only suffer in silence, because they have not the means of making their voices heard; the reviewer glances at the effect of consolidation among the Romans. The limited farms of the early Romans were afterwards generally consolidated; and the defence of the empire, instead of being effected by voluntary recruits drawn from the class of cultivators, was intrusted to hireling legions, and Rome fell. "The fabric of British power may be safe against any foreign attack; it may not, perhaps, fall under the assaults of a host of savage barbarians emerging from their steppes and forests; but is it equally secure against internal commotions? In such an emergency, we are really afraid that in many districts of this country it would be unsafe to expect much assistance from the loyal feelings of the agricultural peasantry; there seems to be but too much reason to fear that they might be as ready to abet, as to resist, any outbreak of violence. There remains, we shall be told, a great and gallant standing army. It should not be forgotten, however, that every standing army must be raised and recruited among the labouring classes, and that, in the long run, feelings and opinions generally and permanently adopted among these can hardly fail to spread among bands necessarily composed of their sons and brothers."

We have proved in detail (Vol. II. p. 51.) that the money wages of labourers in the present day are not equal, in the purchase of the necessaries of life, to what they were two centuries ago; and that while every other class of the community is advanced in food, dress, comforts, and luxuries, the poor alone have stood still. The reviewer draws a touching picture of their sufferings in different counties in England, and clearly and distinctly points out, from the recorded experience of Lord Brownlow, Lord Winchelsea, Sir T. Burnard, Mr. Sabatier, and others, the great advantage to the cottager of having a large garden or a field of two or three acres attached to his cottage.

“ There is no better way,” says Mr. Sabatier, “ to encourage the poor, than by inducing them to employ all their waste time in cultivating a small piece of land, and to make use of all their dirt and rubbish to manure it ; to do which effectually, it must be contiguous to the cottage. The object should be, to employ the wife and children at times when they would otherwise be idle. A cottager, who works for daily wages, has now and then an hour or two to spare in the long days ; and, by weather partly wet and partly fine, at all seasons. These, if he had an allotment of land, he might be induced to employ : it is, in short, that kind of work which Dr. Franklin advises all persons to keep by them, because it may be taken up and laid down at any time ; when this is not the case, these scraps of time are spent in lounging about, or else at the alehouse.” (*A Treatise on Poverty, its Consequences, &c.*)

“ But what is the remedy ? ” says the reviewer. “ Mortgage the poor-rates, and raise funds to remove the excess of population to Canada. This might, perhaps, answer for a very few years ; but the vacuum, we fear, would soon be filled up ; the number removed would be replaced ; and, at no distant period, a second removal, and consequently, a second mortgage, would become necessary. This succession of removals and mortgages would require, we fear, to be repeated, until at last no surplus revenue would remain to mortgage : the rent of the land would thus be annihilated. Check the increase of population ! as well might an attempt be made to stop up the current of the Thames ; the puny efforts of men can do but little to counteract the effects of one of the strongest and most powerful of Nature’s laws. . . .

“ The manufacturers of this country no longer offer a resource for the superabundant hands not absorbed by agriculture. The only alternative, therefore, seems to be the application of this increasing force to the cultivation of their native soil. If we can neither remove nor diminish the population of a district, let us attempt what is still better than either — to augment the produce. In this way one thing is certain, *that no harm can be done* ; and we observe with satisfaction the growing strength of an impression, that some great effort must be made to render the land of this country an available source of productive employment to the labouring population. Convinced by what he saw elsewhere, as well as by practical experiments on his own property, of the beneficial tendency of the system of attaching small allotments of land to cottages, the late Lord Brownlow determined to adopt it generally on every part of his extensive estates ; he eventually allotted between 5 and 6 acres of land to each of his cottagers, in number about 500. The occupiers pay for these allotments the same rent as the neighbouring farmers pay for land of the same quality ; and this has made them so comfortable and independent, that the whole body does not contain an individual who would not resent the mention of parish assistance as a disgrace and an insult. The present Bishop of Bath and Wells divided a considerable portion of the glebe land belonging to a benefice which he formerly held in Cambridgeshire, among a certain number of the more industrious labourers of the parish. So well satisfied was the reverend prelate with the result of this parochial arrangement, that when he removed to Wells he introduced the same system on a portion of his episcopal demesne in the vicinity of that city ; nor has that failed in Somersetshire which succeeded in Cambridgeshire. The moment the lease of any of his farms fell in, it was the uniform practice of the late Duke of Northumberland (which is continued by his successor) to have the farm carefully examined. Every cottage was put into complete repair ; every garden was put in order, and from 3 to 5 acres of land were then taken from the farm, and attached to each cottage ; and it was not until these arrangements had been effected, that the residue was let as a farm. It has never been found that any of these labourers, or their families, are found to go to their parishes for relief.

Upon the English estates of the Marquess of Stafford, the character of the numerous cottagers is an object of great solicitude; without any interference with the manner in which a man may choose to occupy himself, their regular and decent behaviour is made the subject of care and attention; and the steward has strict directions to watch carefully over them, and, where it may be possible, to promote their improvement. Whenever a potato-garden can with advantage be added to their cottage, that accommodation is afforded them. In the vicinity of Trentham the cottages are of the best sort; and these, with their gardens, are kept in the nicest order. To almost every one of them is attached land for the maintenance of one or two cows. It is a circumstance worthy of remark, observes Mr. Loch (*Lord Stafford's Improvements*, 1820), that, of all the labourers who possess a cow, none receives relief from the poor-rates, except one widow at Trentham, who has a large family; and, even in this instance, the relief she receives is in a less ratio than any person labouring under similar difficulties would seem to require. The Earl of Beverly, Lord Carrington, Lord Stanhope, Sir John Rushout (now Lord Northwick), Mr. Burdon of Castle Eden, Mr. Babington of Rothley Temple, near Leicester, Sir John Swinburne: we could easily name many other landed proprietors, and also many incumbents of parishes in their glebes, who have adopted similar means of improving the condition of their labourers; and disappointment has rarely, if ever, attended the experiment. Their rents have been punctually paid; their conduct respectful and orderly; their industry unremitting; no allowance from the parish on account of children, or of time lost from want of work. Even in the most trying years, times of scarcity or agricultural distress, very few of the labourers enjoying these advantages have been found to apply for parochial relief. They are uniformly found to be most steady and trustworthy workmen, and are, therefore, the last to be thrown out of employment by agricultural reverses; and the produce of their allotment being mostly green crops is less exposed to casualties from the seasons than the corn crops of the farmer."

It is impossible not to dwell with pleasure on the foregoing picture, and to revere in the landlords sentiments productive of so much good; but we must be allowed to say that the picture is deficient, from the total absence of any appearance of schools. It would be of considerable importance, both morally and politically, to know the precise state in which the children of the families, thus rendered comfortable on these different estates, are with respect to education. Is there a sufficient number of schools within their reach? Do the parents send their children thither? For what length of time? And what do they learn? Or do the parents employ the children chiefly in assisting them to cultivate their gardens? To make the most of school education, as a check upon population, and as a stimulus to emigration when the population is superfluous, it is not only necessary that there should be a sufficient number of schools, but that it should be obligatory on parents to keep their children at school till the age of puberty; not to forbid their assisting their parents in their gardens out of school hours, but to render them the fitter subjects either for staying at home, or emigrating, and what we have chiefly in view at present, to enhance the difficulties and expense of bringing up children. If a high and equal education could once be rendered as essential to the bringing up of the children of the labouring classes respectably, as it is among the middling classes, it cannot be doubted that it would operate as a very powerful check. It would raise wages, and prevent early marriages. At present the little that the labouring classes think on the subject at all may be presumed to be on the wrong side; the doctrine "increase and multiply" is held to be of the highest authority, and, unfortunately, it is the interest both of clergymen and medical men to support this opinion. We would therefore wish to know, whether, and to what extent, any thing has been done for the minds of



the human beings rendered comfortable on these gentlemen's estates; and we repeat, that much as human nature is indebted to them for their benevolence, yet still without a high degree of education their improvement is incomplete, because it does not provide for its own continuance. What is to become of the multitude of children that will be reared up in these comfortable cottages? They must either be supplied with cottages in their turn, or made citizens of the world by education. By educating these children, so as to give them the capability of emigrating, these benevolent landlords will not only have the satisfaction of having produced much present comfort, but of furthering the intentions of nature in spreading civilisation over every portion of the habitable globe, and thus approximating the consummation of that felicity which we must believe to be ultimately intended for the whole of human nature even in this world, since by a part of this world we see it already attained.

The reviewer next gives instances of parishes having let land to labourers who had previously been burthensome to the parish, but who afterwards required no assistance. The great produce from cultivating a piece of land of only 3 acres, in what is called the Flemish manner, or field-gardening husbandry, is stated from some communications to the Board of Agriculture by Sir Henry Vavaseur. An allotment of arable soil is very properly stated to be preferable to one of meadow land. We cordially agree in desiring "vehemently, to see the day when every cottager shall be allowed to occupy, at a fair rent, an allotment of land of sufficient extent — not to convert him into a petty farmer — not to withdraw him from his regular labour, but to employ him, and more especially his family, during their leisure time."

With respect to the portion of land necessary for this purpose, we think it may vary in extent from the fourth of an acre to 5 acres, according to a variety of circumstances of a local nature. A fourth of an acre may be the minimum for a labourer who has no cow; and 5 acres will not be too much for a labourer who has, perhaps, a little capital, and who may produce, with the assistance of his wife, milk and vegetables for sale. Cottagers who are mechanics may, in some situations, find 10, 20, or 30 acres, a desirable acquisition; and in such cases, as in all where the quantity required exceeds an acre or two, the landlord has only to consider what is best for his own interest, always taking that term in an enlightened sense, and looking to permanent as well as temporary advantage. With a high and equal degree of education, we see no reason why this mode of distributing land among the lowest classes in England should not be as productive of general and particular good, as the same mode of distribution is among the labouring classes in some states of Germany, and in Sweden, Norway, and Switzerland. The good produced in these countries is not great; the condition of the labouring classes in them is one of poverty, with regard to money, clothes, and luxuries, but not of starvation and hopeless misery. Every family, with scarcely an exception, amongst the lower classes in Bavaria, Wurtemberg, and Baden, possesses a house and more or less land, and, as we have elsewhere (*Mag. Nat. Hist.*, vol. i. p. 482.) stated, though exceedingly poor in point of money, and coarsely clad, yet they are enlightened, very free from crime, and totally without paupers. The condition of the farm servants in the south of Scotland and north of England, where every married man has a house and garden, a certain quantity of potatoes, wheat, and oats, land for flax, often the keep of a cow, and so many days' labour of a horse and cart to carry home his fuel, is an inferior degree of the same comfort which exists in Wurtemberg and Bavaria. The condition of these agricultural labourers is greatly superior to that of their brethren in the greater part of England; because, whatever may be the price of bread corn, potatoes, and the produce of a cow and a pig, they have always the same quantity of these articles. The possession of land not only affords a labourer or mechanic an opportunity of employing every moment of his leisure time, and of saving what would be spent in idleness or in the alehouse; but it renders him, by the sense

of importance which it induces, more frugal and economical when in full employment. The first step to the improvement of a man is, to let him have something which he can call his own; something which he can add to and improve, with the feeling that he is doing good to his family, and acting in such a way as to be generally approved of. Poverty is the parent of immorality and crime. No improvement in the condition, either of individuals or of nations, takes place till property exists; and of all the different kinds of property known to civilised society, none exercises so important an influence on the individual, as a portion of the earth's surface, however small; a dwelling surrounded by land; a small house and a large garden. This taste is implanted in human nature for the wisest purposes; since it is only in such dwellings that healthy children can be produced and matured. Under these impressions we do not hesitate, with the reviewer, most ardently to desire, that every labourer had a cottage, and land more or less. We desire it even without the establishment of national schools, for the immediate good it would produce, and because we anticipate that, before the production of much evil, schools of some sort will, by some means or other, be established every where, and emigration has become as common as the exportation of manufactures.

To realise such a state of things is the difficulty. Land-agents and rent-collectors of every kind are said to be against multiplying cottages and gardens; because "it is much less troublesome to collect 100*l.* from one farmer than 10*l.* apiece from 10 cottagers." It is, therefore, for the independent and benevolent proprietor to make a commencement, however opposed by his agents; and it will be "policy no less than humanity and philosophy to do so."

"No alteration which the legislature can make in the poor laws — no improvement which can be introduced into their administration — nothing short of giving the labourer a field for the application of his industry, can prove available. Except, perhaps, by an enactment enabling the landowner to detach small cottage allotments from farms now under lease, we are not aware that the interference of the legislature could much assist in carrying this mode of ameliorating the condition of the peasantry into effect. If the landowners do not utterly forget the obligations and duties which their situation imposes upon them — nay, if they take a correct view of their own true interests, they will not hesitate. They are not called upon to give any thing; it is not suggested that they should parcel out their land among a host of small occupiers: all that is required of them is, that the labourers actually wanted for the cultivation of their property should be allowed the privilege of hiring, at a fair rent, a small allotment of land, to be cultivated at their leisure hours; and of establishing, by that means, at their own doors, a *savings' bank*, in which every hour that can be spared, either by themselves or their families, from more profitable employment, may be saved and laid out in a productive manner."

Neither the interference of the legislature between the employer and the employed, nor the giving of any thing by the former to the latter, will be productive of any other than a momentary and partial good. Whatever is done must be effected on the general principles of free agency and self-interest. If any thing be attempted on other principles, it will neither become general nor be of lasting duration. A correct view of a landlord's, or even a farmer's, true interest will, we agree with the reviewer, lead to rendering the labourers and servants of every description, actually wanted for the cultivation of his property, as comfortable as possible; and the most effectual mode of accomplishing this, with the married servants, is that of allowing them a comfortable cottage, and as much land as will completely occupy their leisure hours, at a moderate rent. This is so obvious to common sense, that it may be safely recommended to all landlords and farmers: many have all along acted on it; and, of those who had

so acted, we never heard of one who gave it up. While there may be great doubts as to the policy of granting as much land as will just enable a family to live, there can be none as to either the general policy, or individual prudence, of grants to servants and labourers of the description above contemplated. If every landlord in the country were to act on it, a great proportion of the existing misery would be immediately reduced.

“A very beneficial law has been recently enacted, enabling parish officers to purchase or hire any quantity of land not exceeding twenty acres, with the view of letting it out in allotments to the labouring parishioners. The judicious application of the authority thus vested in overseers cannot fail to produce the best effects. A number of cottage endowments may be thus created, and placed beyond the reach either of the cupidity or the caprice of individual proprietors. In one point, however, it seems to us that this excellent act is susceptible of improvement. The quantity which it places at the disposal of parochial officers is much too limited to meet the necessities of large parishes. The overseers should, we think, be authorised, under proper restrictions, to purchase or hire a quantity of land, for the purpose of establishing these small cottage-farms, bearing some defined proportion to the extent of cultivated land contained in each parish.”

We have great doubts as to the permanent benefit of any thing that can be done by parishes, or, indeed, we may say, that can be done by any party, out of the natural course of things. We do not see the point at which any parish is to stop, or could with justice stop, after it had begun to let out small allotments to labourers. At the same time, we admit that the poor-rates may become so excessive, in some parishes, as to render the measure contemplated the best one that could be adopted, in order to save, for a time, some rent to the landlord. If adopted generally, we think it would not be difficult to show that it would end in rendering the poor the lords of the soil. But if it were adopted generally, in connection with a high degree of education, what would be the probable result? Either it would make parents prudent as to the number of children they produced; or it would fit these children for emigration, and thus, instead of burthening the country, create in other countries a demand for its manufactures.

It is remarkable that only once, in the course of this review, does the reviewer mention the subject of education. “Incredible exertions,” he says, “have been made to spread more extensively, among the English peasantry, the advantages of education, in the hope that the knowledge of what is right would wean them from the practice of what is wrong. But while we sow the wind, we must content ourselves with reaping the whirlwind: we endeavour to sweeten the stream, and make no attempt to cleanse the source.”

The general opinion of men of a certain manner of thinking is, that the use of education to the poor is to “wean them from the practice of what is wrong.” This is a part of our object also: but the grand efficient purpose which we have in view, in recommending universal and high education, is to render a man better able to support his family; to render that family more comfortable by creating a greater number of wants, and supplying them; to raise the dignity of the poor as intellectual beings; to enable them to ascertain their precise position in society; to maintain their rights as men and as citizens, against the encroachments of the rich; and to render their opinion influential in the control of local and general government.

The reviewer concludes by stating, that he has confined his attention “to the condition of those labourers who are regularly employed in the operations of husbandry: the disposal and employment of that surplus population, both agricultural and manufacturing, for whose labour there is no effective demand, forms a wholly distinct question.” We thence conclude that this question will be entered into in an early number of the review; and we sincerely desire that it may be done, because, at all events, good will arise from discussion.

In the mean time, whether any thing be done by government in the way of establishing a national system of education or not, landlords of every description cannot err in increasing the comforts of their hired servants and day labourers; by rendering their cottages more healthy, commodious, and neat, and by adding to them a large garden, in no case less than a fourth of an acre. We shall, in our next Number, discuss the subject of improving rural dwellings, commence a series of plans for improved labourers' cottages and gardens, and show how such gardens ought to be cultivated, and what they are calculated to produce.

---

ART. XIII. *Hints for Prize Questions, submitted to Provincial Horticultural Societies.*

THE report of the committee of the Newcastle Botanical and Horticultural Society has been sent us by the secretaries, with a request that we would furnish them with some hints for prizes. We are much gratified to observe that an excellent garden-library has been established by the Society, and more especially to learn from the report, that "the taste for reading, already engendered by it, has exceeded their most ardent expectations, and they can with confidence state, that the books in it are in constant and active circulation among those of the members for whose use they were more especially intended, the practical gardeners." Most of the books, it is gratifying to observe, are presentations; and one gentleman, Mr. Charnley, has nobly given fifty volumes of standard works. Mr. Falla, jun., one of the secretaries, and one of the most enlightened of the nursery gardeners of the north, seems to have vied with Mr. Charnley in the liberality of his donations.

As to prizes, the following is a copy of the rough sketch which we sent, and to which we would wish to direct the attention of other country societies:—

"What quantity of garden ground does it require to supply all requisite culinary vegetables, including potatoes, to a labourer's family, and to his live stock; the former consisting of two grown persons and four children, and the latter at an average of one pig, three rabbits, three hens, and three ducks? Name all the articles, and give a calendarial treatise on their culture, and on the management of the whole garden throughout the year, specifying the number of hours' labour of one man for every week in the year. Include the mode of cooking the vegetables, so as to make the most of them; how far the potatoes may be mixed with flour to make bread; where and how the manure is to be procured and managed, &c.

"All the above circumstances being the same, but two goats for milk being added to the live stock, what additional ground, and what arrangements and management would be requisite?"

"All the above circumstances, &c., as at first, but a cow added, what addition of ground and what arrangements, &c.

"All the circumstances, &c., but a cow, horse, and cart added, what, &c.

"Take each of these cases separately, and consider what additional quantity of ground, and what arrangement, management, implements, hand-mills, or machines, &c., would be requisite to supply the family with bread-corn; what are the best corns to cultivate for this purpose, and what proportion of each; and whether Indian corn might be included? Describe the mills, and mode of grinding and preparing the corn as flour, &c.

"Handsome premiums should be given for the first, second, and third answers to the above questions.

"We are far behind the French, as to the use of the kidneybean, and especially the dried seeds of certain climbing varieties; and much inferior to

the Germans in every thing relating to the varieties of the cabbage family, their culture, and especially their cooking. The same as to winter salading. It would be useful to encourage the annual importation of cabbage-seeds from Germany, especially the borecoles. A good deal is to be done in spreading a taste for succory and other winter salading, as suggested in Vols. II. and III. by a correspondent abroad."

It would be a grand object to ascertain, all over the island, what portion of land would keep a family in culinary vegetables, pork, and eggs; in culinary vegetables, pork, eggs, and milk; in culinary vegetables, pork, eggs, milk, and bread corn; and the best modes of culture and management in every case, including therein the number of hours' work of a man every week in the year. To whatever first premium the Newcastle, or any other country society, may offer for the best treatise on each of these three subjects, we shall, with their permission, add a copy of our *Encyclopædia of Plants*, and to the second premium a copy of our *Hortus Britannicus*.

We also offer a copy of the *Encyc. of Plants*, and of the *Hort. Brit.*, to the person who may send us the best answer in detail to the whole of these three questions as to cottage gardens, provided the same be received by us before the 1st of Feb. next; and copies of the *Hort. Brit.* to the papers ranking second, third, and fourth in merit. The papers to be clearly and plainly written, with a number, mark, or motto, and without either real name or address. The awards we shall announce on the cover of the Magazine, and the candidate can then come forward with his name, and claim his prize.

---

#### ART. XIV. *Workhouse Gardens and Gardeners.*

ONE of the greatest evils in the management of the poor of this country is the payment of able-bodied men and women, or, at least, of men and women who can work, without requiring or obtaining any useful labour from them. In many parishes, the parish poor are set to work at labours of no real use to society; such as carrying or wheeling stones from one place to another, digging pits and filling them up again, &c. &c.; which cannot but be felt by the humblest labourer as an utter degradation of his nature.

In some parishes the labours are of a useful description; but persons who have been accustomed to work at mechanical trades within doors, or who have been servants, perhaps housekeepers, can never do any good at such occupations as breaking stones, mending, watering, or sweeping roads, &c.; on the contrary, they must be disheartened, and so broken down, both in body and mind, as to produce very little benefit to their employers, and to injure their own health.

Why should not every parish be obliged to have a parish garden proportionate to the size of the parish workhouse; say one acre for every four persons which the workhouse is calculated to maintain? The workhouses of large towns might have their gardens in the country, and if it were situated at a great distance, the paupers might be carried thither in the morning and back in the evening in vans. The great advantage of garden work is its agreeableness to almost all men and women whatever, and whether they have been brought up in the town or country. The produce of these gardens would, in great part, be consumed by the poor themselves, and the remainder might be sold. By growing potatoes, wheat, perhaps Indian corn, peas, and kidneybeans of the kind used in France and America in soups, and by feeding pigs with the refuse, almost the entire subsistence of the poor would be home-made.

A good large garden, and a good gardener as a manager, would always supply abundance of work, which would be both suitable and agreeable to every description of paupers, male and female, old and young; and when

able-bodied men applied for allowances, or work, they could at once be set to digging or trenching by the job, or by measurement, which would be much better than employment by the day. Almost every thing would depend on getting a very superior gardener, and contriving his remuneration in such a way, as to make it depend on the produce and profits of the garden. As scarcely any single parishes in the country could afford to maintain such a gardener, half a dozen or a dozen parishes might join and employ a gardener in common, and this man, by keeping a horse, might visit each workhouse garden two or three times a week. Each garden might have its pauper foreman and forewoman, and the labours, from the least to the greatest, should, as much as possible, be let against time, or at certain rates; and out of every job some small proportion, if it were only a pipe of home-grown tobacco (or the remuneration might be in numbers of a certain value per dozen), should go to the private pocket of the pauper. Now and then, when superior-minded men have directed their attention to the management of the poor, or of prisoners, they have effected astonishing ameliorations. A case which presents itself to our minds at this moment is that of the workhouse of Hagenau (p. 67.), where 600 female prisoners, condemned to labour for limited periods, by the admirable management of the present governor, actually pay the expenses of the establishment, and put something in their own pockets. Let a source of agreeable and productive labour, such as large gardens, be found for the inmates of our workhouses, and let efficient gardeners be set over them, and we have no doubt the poor in many parishes would nearly or wholly support themselves. But if they did not support themselves, it would surely be a powerful check on the able-bodied idle poor, to know that it was utterly impossible for them to get any relief without a return in labour. Much might be effected in reforming the workhouse system if it were once fairly set about.

But very little can be expected to be done in this way, or in any other tending to reformation, while the parish vestries in the country are composed of men ignorant of general principles on any subject, and governed by the most erroneous ideas of their own interest. The landed proprietors, and the enlightened class of a parish, find it impossible to have any thing to do with such men; they are outnumbered and sometimes bullied by them into absurd measures, and they in consequence seldom look near the vestry, unless compelled to do so by some extraordinary pressure of the rates. Few about large towns have any idea of the absurdities that are committed by vestries in remote parishes in the country; and this will continue to be the case till the men composing these vestries are generally enlightened by reading. As this can never take place with the present generation, any radical improvement must depend on the degree of education given to their offspring. School education, in short, applied to all classes, to such an extent as to produce a reading population, like that of Germany and Sweden, is the only source that can be relied on, either for introducing or perpetuating any grand or general improvement in the condition of any part of society.

It is this general ignorance in the country, and even in the parliament, which renders it necessary to promulgate such an endless number of laws. A people enlightened, justly represented in their legislative assembly, truly free in their commercial intercourse among themselves and with other nations, free as to their choice of opinions, and, above all, free in regard to the press, would not require a multitude of new laws every year. But in an old, corrupted, diseased country like Britain, this is unavoidable, till its constitution be renovated by a new generation of men who have been highly enlightened in their youth, and who shall be neither too rich nor too poor for public business. In the mean time, as this law-enacting system must go on for want of something better, we do not see any great harm that would result from passing an act rendering it legal to have workhouse gardens and gardeners, as well as workhouses.

ART. XV. *Retrospective Criticism.*

*MR. KNIGHT'S Pines.*—Sir, You call upon me (p. 567.), and justly, to send you my opinion of T. A. Knight, Esq.'s method of cultivating the pine-apple. There is no gentleman in the kingdom that I respect more than the worthy president of the Horticultural Society; and I am extremely concerned that you should use such severe language in the pages of your Magazine towards one whom we have greater reason to honour and applaud than to censure; and I am well assured that the practical gardener has not a more sincere friend than Mr. Knight.

With regard to those words used by him when he first publicly noticed his method of cultivating the pine-apple, and which have so frequently been brought up in a censurable way by many gardeners, I am convinced that Mr. Knight never meant them as a slight upon practical gardeners; and that if he had suspected that only a small portion of them, and those of the lowest grade, would have felt themselves hurt at the expression, he would have omitted it. He never meant it in any other light than that of illustrating the simplicity of his method of culture over the usual way; still intelligence and rigid attention are obviously of the utmost importance. Mr. Knight may be said literally to live in his garden, and therefore he does not require a professed gardener; as he sees and orders every thing himself, and will continue to do so as long as he is able to walk.

I have had opportunities of seeing Mr. Knight's method of cultivating the pine-apple several times in the year, from the time that he first adopted it to the present time; and, from first to last, the extraordinary luxuriance in the appearance of his pine plants has surpassed any that I have ever seen cultivated in the usual way. The plants have more the sturdy appearance of the American Aloe than that of the *Yucca gloriosa*; and not the thin lank look that the pine plant assumes as it is generally cultivated; and I have grown them myself upon a stage, in a common wooden frame, with wooden lights, so as to astonish every gardener who saw them; and from small suckers, planted at Candlemas, I produced plants by November, superior to those of two years' growth in the usual way of culture. Had I had a house with a curvilinear roof, I should certainly prefer the method for growing my plants, to any other; but as that is not the case, and as fuel is expensive, and tanners' bark and oak leaves close at hand, as I am at present circumstanced, the old method is the best.

Although I grow my plants so very fine, and have seen Mr. Knight's as I have described, yet I have been disappointed on seeing the fruit of such plants. What I have seen of Mr. Knight's this season have been much finer than any previous; and I am confident, that if the plan were more generally adopted by some of those gardeners eminent in their profession, so that they may have a constant judicious management under their eye, pines may be grown with fruit equally luxuriant as I have ever seen on any plants.

Mr. Knight has never, in my hearing, spoken of his method as being superior to the old; he has only recommended it where tan and leaves are not conveniently to be had, and where fuel is not a material object; and that a hot-house, of a given dimension, will contain many more plants than when confined to a pit in the usual method.

What I here remark is my candid opinion, nor do I dissemble in any one expression with a view of favour, or lest I should hurt his feelings. If I did not think that he merited our warmest esteem and applause, I should not give it to him; and I trust, ere long, to be gratified by reading of him in your pages as he justly merits.

Mr. Knight's son-in-law, Mr. Stackhouse of Acton Scott, near Church Stratton, Salop, has built a larger curvilinear pine-house than his, and they are under the superintendance of two very steady and persevering young

men, who were both pupils of mine. They only commenced this last spring, after I sent the last young man as foreman to the other, who is the acting steward, and cannot pay such close attention himself as pines require, by whatever method they are cultivated. I went over to see them about Midsummer, and I was astonished at the wonderful progress and sturdiness of the plants. They keep the house at an extraordinary high temperature through the day, and the plants comparatively dry, but the air in the house is kept like a vapour bath.

I shall feel happy in sending you the state of the plants both at Downton Castle and at Acton Scott, as soon as I can make it convenient to pay a visit to these places.

I am surprised to find, by the last Number of your Magazine (p. 465.), that you had never heard that Mr. Knight's pine plants looked well. I am persuaded that no one who had ever seen his plants could say any thing against the appearance of them, unless prejudice blinded his eyes. I am, Sir, &c. — *John Mearns. Shobden Court, near Leominster, September, 1829.*

*Mr. Knight's Pines.* — As I promised to acquaint you of the present state of Mr. Knight's pines as soon as I could ride over to Downton Castle; I now inform you that I have been there. I went over a few days ago and took a friend, a practical gardener and excellent pine-grower, formerly a pupil of my friend Mr. M'Murtrie's, at Shugborough, along with me. We had a good deal of argument upon the subject of pine-growing, upon our way thither; and as we had both but recently visited Mr. M'Murtrie, and seen his pines and those of the Marquess of Stafford, Lord Bagot, &c., and he had never seen Mr. Knight's, although but eight or nine miles from him, for the last three or four years, you may suppose that he would not think much of the method till he had seen it: however he was much pleased, and not a little astonished when he saw the plants, and also the fruit, and I have to say from him, that, under certain circumstances, he is become as much a convert to the system as any of us: and I am likewise permitted to say that Mr. Corbett, Mr. Knight's acting steward, who was previously gardener, and an excellent pine-grower, has long been as great a convert as myself, and intends to make an attempt at it ere long, near some of our great coal-works. My friend, Mr. Andrew Begbie, had changed his tone before he left Downton Castle, and was anticipating all the way home the great prospect of success that was likely to accrue from Mr. Knight's method in the neighbourhood of such a place as Musselborough, where coals, glass, bricks, and timber could be had at hand and cheap; and at so convenient a distance from Edinburgh. Yours, &c. — *John Mearns. Shobden Court, near Leominster, Oct. 10. 1829.*

*Mr. Knight's Pines.* — Sir, I observe in one of your previous Numbers of the Gardener's Magazine, that you would be much obliged to any of your readers that visited Downton Castle, if they would send you some account of what they saw there. But you appear to show as a cause why they do not, "that gardeners having so great a personal respect for T. A. Knight, Esq., from his obvious goodness, and that peculiar sort of winning simplicity and ingenuousness which pervades his character, they will not incur the risk of hurting his feelings;" which I consider to be as much as to say, that his pines are so very bad that they dare not report them, lest they should get Mr. Knight's displeasure. However, I dare run the risk of informing you and your readers, that I visited Downton Castle on the 26th of August last, and that I was very much deceived in T. A. Knight, Esq.'s pines; so much so, that I think I shall become a zealous convert. I expected to find them poor, stunted, and bad-looking; but, on the contrary, I found them stout, healthy, and the finest-looking plants that ever I saw in my life, of the kinds which he grows. Fruit from 3 lbs. to 5 lbs. weight, of the Montserrat kind. Therefore, let his mode of growing the pine be what it will, I think that he might (at the present time) challenge any pine-grower



in the kingdom with the black kinds. Sir, &c. — *John Pearson. Kinlet Gardens, near Bewdley, Sept. 22. 1829.*

*Mr. Knight on the Culture of the Potato, &c.* — Sir, In the last Number of your Gardener's Magazine (p. 294.), you have expressed a wish to know the length and breadth of the ground which my crops of potatoes occupied; upon which I calculated, in the account sent by me to the Horticultural Society of London, the produce per acre: and as I consider the subject to be one of very great national importance, I send you the following statement. The public will, however, I believe, give me credit for knowing how to make such an experiment correctly, and for integrity in stating truly the result of it: but I have the evidence of two competent judges, who saw the potatoes taken up and weighed, and the ground minutely measured; and who are ready to attest on oath their conviction that the crops, extraordinary as they are stated to have been, exceeded the published account considerably. The account published by you must have appeared, as you very obviously wished it to appear, incredible to your readers; for you have suppressed every fact and inference which led me to send the account to the Horticultural Society, and upon the evidence of which I accounted for the immensity of the produce; and you have represented that communication, which I consider much the most useful that I ever addressed to that Society, and one of the most useful ever published by it, to be perfectly nugatory, and discreditable to me as the writer, and to the Committee of that Society as the publishers of it. I received the first intelligence that you had done so, from a gentleman residing some hundred miles distant from me; and whom I had never seen. If this charge is unfounded (I do not accuse you of intentional misrepresentation), you can refute it by publishing my paper: and it is a very short one; and this I call upon you to do.

The large, or Lankman's, potato grew in a plantation which was about seventy yards long, and about twenty yards wide. I fixed upon the central row, because it was the central row only; and without any previous examination of it, and having caused twenty yards at one end to be measured off, and a stake driven in the ground at the end of that distance, I took the produce of the next succeeding twenty yards, and allowed something more than the full extent of the ground occupied by the selected portion of the crop. Not less than half a peck of potatoes appeared to have been drawn out and injured, as I have stated, within the twenty yards above mentioned; and as that quantity was more than equivalent to twenty bushels per acre, I thought it proper, as I wished on this, as on all other occasions, to convey minutely correct information to the public, to mention the circumstance.

The rows of the small ash-leaved kidney potato were about 12 ft. long; and those grew in good soil, but without manure. One of these rows, the central one, as in the preceding case, and what appeared to me not to be a favourable one, was selected. The terminal plants, having had more than their due share of light, were taken away, and the remaining produce, upon a perfectly fair calculation and correct admeasurement of the ground, indicated, as I have stated, a produce per acre of 665 bushels of 82 lbs. each. My gardener requested to have the produce of another, and apparently a more favourable, row ascertained; and that indicated a produce per acre of 695 bushels and 5 pecks.

As you have asserted that there was nothing new in my mode of management, except that of collecting a shallow soil into high ridges, I beg to ask you, whether any person except myself ever pointed out the great advantages of planting potatoes, of every variety, large enough and near enough to each other to cause the whole surface of the ground to be covered, under the conflicting influence of gravitation and of light, without the plants in any one row being overhung or shaded by those of contiguous

rows; and whether any gardener of any country is prepared to prove, that he ever saw as large, or even half as large, a produce afforded by the dwarfish ash-leaved kidney potato, as that above stated; or who will engage to cause as large a produce to be afforded by any other mode of culture than that pointed out by me. I could put many more questions to you, which, I think, you would find it difficult to answer: but, as I conclude you will lay my paper before the public (as I have called upon you to do), I think the foregoing sufficient. You may perhaps say, as you did respecting my pine-apple plants, that you have seen a gardener and a nurseryman who had seen my crops of potatoes, and insinuate that they could contradict my statement, only that they do not choose to give their names: but such evidence is not calculated to convince any person, nor to injure any character (I believe I could here use a past tense) except your own. I remain, Sir, your obedient servant,—*T. A. Knight. Downton, Sept. 10. 1829.*

The following is a copy of our answer to the above communication:—

T. A. Knight, Esq.

*Bayswater, Sept. 15. 1829.*

Sir, I have received your communication of September 10. which I am sorry is too late for the October Number of the Gardener's Magazine, but it will appear in the December Number, together with the whole of your paper on the potato, as you required.

As I put the question, to which your communication is an answer, myself, I think it would render your answer more clear, if you would state what breadth you allowed to your row of 20 yards. You say, that you "allowed something more than the full extent of the ground occupied by the selected portion of the crop;" but if you would state in figures what that "extent of ground" was, it would perhaps prevent me from falling into any mistake in replying to your communication. I am, Sir, your most obedient servant,—*J. C. Loudon.*

The following reply to this letter was received, marked private; but having written to Mr. Knight and obtained his permission to publish it, we now do so:—

J. C. Loudon, Esq.

*Downton, October 16. 1829.*

Sir, I should have answered your question sooner, but that I waited with the hope of being first enabled to see, and to state, the produce of a small plantation of potatoes, which still remain unfit to be got up, on account of the excessive wetness and coldness of the season.

The crop of potatoes, which I stated to have been proportionate to five hundred and thirty-nine bushels per acre, was planted with a plough. My orders were for the rows to be placed accurately at four feet distance from each other, conceiving that to be a proper distance for that variety of potato. I measured accurately, when the potatoes were taken up, the width of the intervals upon each side of the selected row, and having taken half the width of those united, I am quite certain that my calculation was correct. But if I obtained, as I did, and as I can obtain next season, a produce proportionate to six hundred and sixty-five bushels per acre, from a small and generally supposed unproductive small variety of potato, it is not, surely, very important that I should prove that I obtained a much smaller produce from a large and very productive variety. I did not suggest any possible cause why the produce of the smaller variety was not greater than I stated it to be; and, therefore, I think (and I have good reason to know that others think) that your sneers and personality might have been spared, as I certainly have never done any thing to call forth either.

The public are not (and I am sure that they have no reason to be) inclined to believe that I am actuated by any interested or impure motives; and whether your character, or rather that of the work of which you call

yourself Conductor, or my character, will suffer, is a question deserving your most serious consideration. The supposed motives of some persons, who are *supposed* to have an interest in your publication, are suspected, by some persons, not to be the purest possible. I shall have occasion to address myself again to the Horticultural Society, upon the subject both of potatoes and pine-apples; and if you choose to persist in your present course, I shall show you that I have the power to bear you down by unanswerable facts.

You have called upon me to name some of the gardeners who have become converts to my opinions and practice respecting the culture of pine-apples; and therefore, though I would not, as I conclude you well knew, descend to name them in your Magazine, I now do so in a private letter, confining myself *wholly to strangers, whom I had never before seen, and over whom I cannot have any influence*, and I give the names of all such persons who have visited my garden, during the last summer and autumn. Mr. Boughton, an eminent nurseryman of Worcester. Mr. Stroud, who has long been in the service, and now travels for, Mr. Miller of Bristol. Both Mr. Boughton and Mr. Miller cultivate pine-apples for sale. The gardeners of — Childe, Esq., of Kinlett, Salop, and of — Hopton, Esq., of Cannonfrome, Herefordshire; both these gentlemen are entire strangers to me. — Mr. Bennett, gardener to Sir Harford Jones Bridges of Boltibrook, near Presteigne, Radnorshire; and as you have called upon Mr. Mearns, I would mention him: but I have been informed that he has written to you, certainly not owing to any desire or instigation upon my part. Any one or all of these would, I believe, say, if required to speak, that they never saw pine-apple plants finer, or so fine, of the same age, and confined to the same narrow limits; nor fruit, under the above-mentioned circumstances, more perfect. I have already told you that Mr. Knight of the Botanic Garden, King's Road, had seen my houses. I remain, Sir, your obedient servant, — *T. A. Knight.*

With respect to the pine-apple we are now, what we never were before, perfectly convinced that Mr. Knight's pine-apples look exceedingly well; we have no doubt in our own minds, from the various evidence contained in our present Number, that they look as well as those grown by any of the ordinary modes. We do not conceive that we owe any apology to Mr. Knight, or to our readers, for not having been convinced sooner; no man is to be convinced without evidence; the truth is, we never before met with a single individual who had seen them, who did not report very differently. The nurserymen we alluded to are perfectly well known: if, from the insinuation of Mr. Knight (p. 719.), any reader should doubt our word in this matter, on proper application we shall give him the names of the individuals. We repeat that we are perfectly satisfied that Mr. Knight's pines look as well as can possibly be desired, which is one point gained; the next will be to determine the eligibility of his mode of culture, which we shall leave to be done entirely by others, only taking care to mark the results, and lay them before our readers as they occur.

In regard to the potato experiment, we refer to our correspondent, an East Lothian Farmer, one of the most enlightened and intelligent in Scotland (p. 608.), and merely state that we think Mr. Knight ought to have stated, in his communication to the Society, what he has now stated, as to the quantity of ground estimated from. Unless this be done, we appeal to every practical man whether a satisfactory conclusion can be drawn from the experiment. But, as unfortunately an appearance of bad feeling has some way or other got into this correspondence, though we can say with truth that nothing of the kind exists in our heart, we now put a stop to this appearance by printing Mr. Knight's communication at length, in parallel columns, with our own abridgement of it. — *Cond.*

*On the Culture of the Potato.* By T. A. Knight, Esq. &c.; as given in the *Horticultural Transactions*, vol. vii. p. 405.

Whatever may have been the amount of the advantages, or injury, which the British empire has sustained by the very widely extended culture of the potato, it is obvious that, under present existing circumstances, it must continue to be very extensively cultivated; for though it is a calamity to have a numerous population who are compelled by poverty to live chiefly upon potatoes, it would certainly be a much greater calamity to have the same population without their having potatoes to eat.

Under this view of the subject, I have been led to endeavour to ascertain, by a course of experiments, the mode of culture by which the largest and most regular produce of potatoes, and of the best quality, may be obtained from the least extent and value of ground; and having succeeded best by deviating rather widely from the ordinary rules of culture, I send the following account of the results of my experiments. These were made upon different varieties of potatoes; but as the results were in all cases nearly the same, I think that I shall most readily cause the practice I recommend to be understood by describing minutely the treatment of a single variety only, which I received from the Horticultural Society, under the name of Lankman's potato.

The soil in which I proposed to plant being very shallow, and lying upon a rock, I collected it with a plough into high ridges of 4 ft. wide, to give it an artificial depth. A deep furrow was then made along the centre and highest part of each ridge: and in the bottom of this, whole potatoes, the lightest of which did not weigh less than 4 oz., were deposited, at only 6 in. distance from the centre of one to the centre of another. Manure, in the ordinary quantity, was then introduced, and mould was added, sufficient to cover the potatoes rather more deeply than is generally done.

The stems of potatoes, as of other plants, rise perpendicularly under the influence of their unerring guide, gravitation, so long as they continue to be concealed beneath the soil; but as soon as they rise above it, they are, to a considerable extent, under the control of another agent, light. Each inclines in whatever direction it receives the greatest quantity of that fluid, and consequently each avoids, and appears to shun, the shade of every contiguous plant. The old tubers being large, and under the mode of culture recommended rather deeply buried in the ground, the young plants in the early part of the summer never suffer from want of moisture; and being abundantly nourished, they soon extend themselves in every direction till they meet those of the contiguous rows, which they do not overshadow on account of the width of the intervals.

The stems being abundantly fed, owing to the size of the old tubers, rise from the ground with great strength and luxuriance, support well their foliage, and a larger breadth of this is thus, I think, exposed to the light during the whole season, than under any other mode of culture which I have seen; and as the plants acquire a very large size early in the summer, the tubers, of even very late varieties, arrive at a state of perfect maturity early in the autumn.

Having found my crops of potatoes to be in the last three years, during which alone I have accurately adopted the mode of culture above described, much greater than they had ever previously been, as well as of excellent quality, I was led to ascertain the amount in weight which an acre of ground, such as I have described, the soil of which was naturally poor and shallow, would produce. A colony of rabbits had, however, in the last year, done a good deal of damage, and pheasants had eaten many of the tubers which the rabbits had exposed to view; but the remaining produce per acre exceeded 539 bushels of 82 lbs. each, 2 lbs. being allowed in every bushel on account of a very small quantity of earth which adhered to them.

The preceding experiments were made with a large and productive variety of potato only; but I am much inclined to think that I have raised, and

*On the Culture of the Potato.* By T. A. Knight, Esq. &c.; as given in the *Gardener's Magazine*, vol. v. p. 292.

"I have been led to endeavour to ascertain, by a course of experiments, the mode of culture by which the largest and most regular produce of potatoes, and of the best quality, may be obtained from the least extent and value of ground; and having succeeded best by deviating rather widely from the ordinary rules of culture, I send the following account of the results of my experiments."

The soil was shallow on a rock, it was collected with a plough into high ridges 4 ft. wide, and whole potatoes were then planted 6 in. apart, in a deep furrow made along the centre and highest part of each ridge: manure was introduced over the potatoes, and mould was added so as to cover rather deeply. As usual with Mr. Knight's experiments, at least as related in these *Transactions*, something occurred to render the result less complete than it otherwise would have been. "A colony of rabbits" did a good deal of damage, and "pheasants" had eaten many of the tubers which the rabbits had exposed to view; but the remaining produce per acre exceeded 539 bushels of 82 lbs. each, 2 lbs. being allowed in every bushel on account of a very small quantity of earth which adhered to them.

The mode of culture is nearly that which is practised on a large scale by the farmers in Scotland, only they do not generally require to raise the soil on account of its poverty or shallowness, but sometimes they do on account of a wet bottom. When sets are put in every third furrow, the dung is frequently put over them; when in the furrows of ridges, most frequently under them, but sometimes also over them. Mr. Knight's experiment, therefore, has no claim to novelty; the produce, however, certainly appears extraordinary, but to us, at least, not so, when we remark the way in which it was ascertained. It does not appear that an acre of ground was planted, and the produce measured, but "having found my crops of potatoes to be in the last three years, during which I alone have accurately adopted the mode of culture above described, much greater than they had ever previously been, as well as of excellent quality, I was led to ascertain the amount in weight which an acre of ground, such as I have described, the soil of which was naturally poor and shallow, would produce."

Every farmer knows that nothing can be more fallacious than to draw conclusions, with reference to acres, from results that have taken place on, perhaps, a few square yards. A good crop of the yam in East Lothian seldom exceeds 40 bushels per English acre. Mr. Knight is "much inclined to think that he has raised, and shall raise in the present year, 1828, nearly as large a produce per acre of the small early ash-leaved kidney." In a postscript, dated March, 1829, he states "somewhat contrary to my expectations, the produce of the small early potato exceeded very considerably that of the large one above mentioned; being per acre 665 bushels of 82 pounds." (*See Gard. Mag.*, vol. iv. p. 147.)

We shall be particularly obliged to Mr. Knight, if he will state, not merely the contents of the surface, but the length and breadth from which the above calculation, and that relating to the crop of 539 bushels, were made; also, to a cer-

shall raise in the present year, 1828, nearly as large a produce per acre of a very well known small early variety, the Ashleaved Kidney Potato. Of this variety I selected in the present spring the largest tubers which I could cause to be produced in the last year; and I have planted them nearly in contact with each other in the rows, and with intervals, on account of the shortness of their stems, of only 2 ft. between the rows. The plants at present display an unusual degree of strength and vigour of growth, arising from the very large size (for that variety) of the planted tubers; and as large a breadth of foliage is exposed to the light by the small, as could be exposed by a large, variety; and as I have always found the amount of the produce, under any given external circumstance, to be regulated by the extent of foliage which was exposed to light; I think it probable that I shall obtain as large, or very nearly as large, a crop from the small variety in the present year as I obtained from the large variety in the last. I have uniformly found, that to obtain crops of potatoes of great weight and excellence, the period of planting should never be later than the beginning of March.

P. S. — March 23. 1829. Somewhat contrary to my expectations, the produce of the small early potato exceeded very considerably that of the large one above mentioned; being per acre 665 bushels of 82 pounds. It is usually calculated by farmers that eighty pounds of potatoes, though eaten raw, after they have begun to germinate, will afford two pounds of pork; and I doubt much if the haulm, and the whole of the manure made by the hogs, were restored to the ground, whether it would be in any degree impoverished. I am not satisfied that it would not be enriched, — an important subject for consideration in a country of which the produce is at present unequal to support its inhabitants, and which produce is, I confidently believe and fear, growing gradually less, whilst the number of its inhabitants is rapidly increasing.

*Whitmore Lodge.* — In speaking (p. 564.) of the high order in which we found this place, we inadvertently omitted to do justice to the gardener, Mr. William Dalby, who is not only skilful and diligent in his profession, but, as his master writes, conducts himself “entirely to my satisfaction, and a more diligent, industrious, young man has never been in my service.” We have sent him Vol. I. *Mag. Nat. Hist.*, as at once a mark of our approbation, and an expression of our regret at having for a moment seemed to forget him. — *Cond.*

*Ashtead Park.* — There are a few things in your notice of this place a little calculated to lead to misapprehension: — 1. the grass-rake is *not my invention*; 2. the sketch from the flower-garden is the *centre piece only*, not the whole; 3. the garden ground here is not good but *bad* for growing carrots, although it grows them tolerably well for summer use; 4. I do not so much disapprove of *cropping* fruit-tree borders, as of *digging* them, which is in some measure implied in the word *cropping*; but it is the digging which is the direct and immediate cause of the mischief. — *John Hislop. Ashtead Park, Oct. 15. 1829.*

Such mistakes are unavoidable in the hurried glances which we are often obliged to take; we were not much above a quarter of an hour at Ashtead, and during the whole time it rained. The great thing is to correct these mistakes as soon as we are informed of them, which we always have done, without a single exception, and always shall do. No one that is eager to make advances of any kind, or in any way, can expect to do so without committing errors: but the advance being made remains a permanent good, while the error is corrected and forgotten. — *Cond.*

*Effect of Inoculation on the Russian Transparent Crab.* — In p. 354. you give some minutes of the Caledonian Horticultural Society: among these is a communication from Captain Smith, of Dysart, describing the effect of inoculating the Russian transparent crab with buds of the Ganges apple; by which union the fruit of the latter assumes the transparent property of the former. How can this be accounted for? Has any similar effect ever been noticed by any of your correspondents? It is completely in the teeth of all our previous knowledge on the subject. — *J. M. Chelsea, August, 1829.*

*Sweet's Hortus Britannicus.* — Seeing you wish to make your Magazine a vehicle of public utility and improvement, I take the liberty of suggesting, through this medium, to Mr. Robert Sweet, that it would be a most important and valuable addition to his *Hortus Britannicus*, if, in the next edition, he would add a column in which might be given, after the name and description of each plant, a reference to one nurseryman or more (or amateur cultivators, if no nurserymen possess the species), in whose collection it is to

tain friend near Haddington, to let us know the heaviest crop of potatoes he has ever heard of having been grown in Scotland; and Mr. Fraser would much oblige us by similar information with regard to Ireland.

be found. The amateur would cheerfully furnish the reference, *pour la gloire*, the nurseryman, it may be expected, would add it for the purposes of trade. Such information would, I conceive, much increase the value of the work to individuals who are often much at a loss to know where they can buy any plant that is new or uncommon, and would readily pay an additional price for such a directory; and at the same time it would be worth while for the nurseryman thus to advertise his rarer plants at the cost of a small gratuity to Mr. Sweet for the insertion. In order to provide for the case of such plants as are to be found in several gardens, the information might be condensed by using letters or Arabic figures of reference, several of which would be comprised within the space of one line of the column, and which might either refer to notes at the bottom of the page, or to a table of the names of nurserymen to be placed at the end of the book. This last would be the shortest and cheapest mode, inasmuch as thereby the same letter or figure, though it should recur five hundred times in the course of the work, would refer to one and the same name, not requiring the name to be printed more than once in the whole book: this mode of reference has many years been used with much accommodation in the *Annual Law List*, for reference from the names of country attorneys to those of their town agents. I subjoin an example of what I mean.

Clématis.

Reference.

1. erecta Dec. | Virgin's Bower | Austria | 1597 | 6-8 | H. 2. | Jacq. aust. 3. 6. 291. | α 6 γ δ ε  
 (α Lee, 6 Loddiges, γ Miller, δ Young, ε Milne and Co.)

For plants which are become fully established, and to be met with in every nursery, it would suffice to say *passim*, which might be abbreviated to *p*.

Whether Mr. Sweet shall adopt this suggestion or not, I sincerely hope he will soon publish a single entire Index Generum to his whole *Hortus Britannicus*. He owes this to his purchasers; the present divided index, of which the part that refers to his second volume comes first, and the part that refers to his first volume comes after, occasions very great and very unnecessary trouble to his purchasers, and is a blot on his character for diligence. Had I discovered this defect before I had bought the work, I would never have purchased it till an improved edition should appear; and if ever he shall publish another edition, with a consolidated index, he owes it to the purchasers of his first edition to give them, at least, an opportunity of purchasing his improved Index Generum separately, and to print an extra number of copies for that purpose. — *Causidicus*. Feb. 4. 1829.

*Music and Dancing among the Laborious Classes*. — Sir, Until very lately intellectual darkness has clouded the minds of the majority of the people of England. I am, perhaps, as desirous as yourself to see this moral night vanish before the bright star of improvement, and the cold mist of ignorance yield to the genial rays of intellectual refinement. But, I think, in their ardent endeavours to promote this march of intellect, some people are running into an opposite extreme, likely to counteract the main object of their desires, by encouraging the pursuit of music and dancing among the lower orders of society.

These light amusements have an evident tendency to promote levity and dissipation, two of the greatest banes to mental improvement. They possess such a fascinating influence over the mind, and so perfectly do they harmonise with the thoughtless gaiety of youth, that it can be no matter of surprise if a young man pursue them, to the neglect of more important subjects, particularly when the opportunity of attaining a knowledge of them is laid within his grasp; and that, too, stamped with the recommendation of those to whom he is accustomed to look for sage counsel and advice.

The greatest care is requisite, lest we aim at the shadow, while the substance eludes our grasp.

I consider the solid improvement of the mind, derived from attentive reading and study, of far greater importance and permanent satisfaction,

than the momentary gratifications of the senses in the frivolous amusements above alluded to. These pursuits must needs occupy much precious time, and where can the labourer find leisure sufficient for these things? He cannot compass every thing. The more useful subjects, then, should be selected, and the whole of his time and attention applied to them.

As the amelioration of all classes of the community seems to be your sincere desire, and the welfare of gardeners the grand aim of your truly valuable Magazine, permit me to add one remark more; that religion is the only rock and foundation on which we can build our hopes of real and lasting happiness. The temporal pleasures of this world are but sportive bubbles, playing in the sunbeam of prosperity, but doomed to be extinct with the first blast of adversity. When all other earthly comforts fail, when a man is ready to sink under the oppressive weight of his afflictions, even then religion can support him, and enable him to rise superior to all the miseries of this precarious world. "Her ways are ways of pleasantness, and all her paths are paths of peace."

"True Happiness had no localities,  
No tones provincial, no peculiar garb;  
Where Duty went, she went, with Justice went,  
And went with Meekness, Charity, and Love."

Yours, truly, — P. R. May 20.

*The Reform of Horticultural Societies.* — I am particularly anxious that you should take into your serious consideration the reform of Horticultural Societies. Let the competitors, at all events, be classed, who can compete with nursery gardeners, (see Vol. IV. p. 288. and p. 221.?) How can the gardener of a small family and confined premises stand any chance against the great curators of Horticultural Peers? And pray what *public* good is *actually* conferred by the competition as now arranged? Benefit must be obtained to the nation, if no prize were given except to the competitor who gave with the article exhibited an account in writing (correct "on the honour of a gardener") of the mode of cultivation he has used. Let all excellent things, not so *described*, be placed on the honourable list, in a folio register, as they deserve; but still let the *means possessed by such individual gardeners* be taken into the account in awarding every prize. Seedlings of every kind deserve encouragement, and vegetables and fruit *brought to market*. If you understand me and agree with me, pray put these ideas into a proper form for a future Number; or I will write more at length on the subject, if you wish it. From an original subscriber. — W. April 24. 1829. We shall be glad to hear from W. on the above, or on any other subject. — *Cond.*

*Humane Mouse-Trap.* — Sir, I have observed, in your valuable Magazine (p. 109.), an article bearing the name of a humane mouse-trap, and which is certainly far more so than the one so described in Vol. II. p. 278. (which I should have taken the liberty to have objected to, had it not been more ably done by your worthy correspondent Agrestis); but the one in question, with the most submissive respect to the worthy author of it, I cannot forbear condemning as too cruel for practice. Your worthy correspondent, Sir, seem not to be aware that the *Mūs sylvaticus* of Linnæus, or garden mouse, can swim remarkably well, and must therefore, in the kind of trap which he proposes, suffer a most lingering and painful death; swimming round and putting its little paws up the sides of the jar with the hope of escaping, and the despair of so doing, the poor little animal will continue to struggle, till overcome with fatigue, it must at last resign itself to its fate. As humanity is a prominent feature in the mind of every truly enlightened man, I am persuaded that gardeners will not make use of either on that account; for, as all animals, even the most noxious, as we are pleased to call them, acknowledge one universal Parent, they have all a right, by the laws of nature, to their being, as far as consistency

allows; and whenever it becomes necessary to deprive them of it for whatever cause, it is our duty to do it by the quickest means, and that which gives the least possible pain, in our power. The sort of traps I make use of, I consider so very simple and well known, that I should never have ventured to have intruded a description of them on your notice had not the above-mentioned articles appeared.

I take the heaviest bricks I can find, and place one flat, and sunk a little, so as to be nearly even with the surface of the ground, on each side of which I thrust down into the ground a small stick sharpened at the lower end, and cut flat and split at top. I then take a large pea or small bean, and make a hole through it with a small bradawl or garden nail, through which I put a piece of brown thread, putting one end of it through the split of each stick and twisting it round, so that the bait is suspended over the centre of the brick; then I take another brick and place it on the lower one, so that it rests supported by the thread. The mouse coming to the bait, and finding it fixed, bites the thread in two with the view of taking away the bait, when the upper brick immediately falls on its head and crushes it to death instantly. It is beat completely flat, and feels very little or no pain. The process is so very simple and easy that a child may attend to the traps every morning after they are once set, and the trouble of first setting them is comparatively so small that I really should consider him as deserving to lose his crops who would not bestow it. I am Sir, yours, &c. — *D. French. Harlow, Essex, March 30. 1829.*

*Iron Hot-houses, and No. XX. of the Gardener's Magazine.* — Dear Sir, I feel truly sorry that my scribbling should give offence to any of your correspondents, and particularly that my favourite iron-framed houses should prove so hot as to cause blisters on the very thin skin of a favourite of my own. It is a pity that his nerves are so delicate as to make him start at what he calls nothing but *the shadow of a man*. I cannot with propriety “doff my habit” at present, though I can assure you that I am not at all ashamed of my name, but am afraid that my name may sometime or other be ashamed of my scribbling. You perceive I am only just trying my hand at authorship, and, though it be rather in a clandestine way, I hope there is nothing criminal in it, more than in the manner in which I learned many other things; budding and grafting, for instance. I used to steal out at over hours, under hedges, into the woods and shrubberies, and put all kinds of grafts and buds into all kinds of stocks, some kinds ridiculous enough to be sure. Such as took, I exultingly showed to my companions; and such as missed, I said nothing at all about. So with my writings: if they take with the public, I can claim them if I choose; if not, you must stand father to them yourself.

Agronome feels very proud of being the favourite of *Seventeen* (see the cover of No. XII.): he presumes that the writer is some beautiful lady of that age, who has fallen in love with his old, withered, and weather-beaten physiognomy, and that her papa very prudently disapproves of the connection. There needs be no alarm on that score, as Agronome is engaged; and the only consolation he can give to his fair favourite is, that if he should happen to live another seventeen years longer, he engages to treat of at least seventeen dozen of subjects, some of which he hopes will be “exactly to her taste.”

But the chief reason for my intruding upon the public is, that I begin to get rather old, and having had rather more than an ordinary share of experience in gardening, &c., I think it rather a pity that I should die and nobody be the wiser. I shall, therefore, commence criticising the last Number of the *Gardener's Magazine*; and, oh Sir, I am highly delighted with your tour to and through the Continent. I wish I could give as good an account of my tour through the north country, but it is out of my line. I, however, do not approve of your ornamented mil-stones; I think a



labourer's cottage would be much preferable, with a sign over the door of "small beer at a penny per pint sold here:" next mile, good porter at 2d. per pint; and a third, British wine at 4d. per pint, &c. Further on there might be fruit and other eatables sold. Each house might also have the picture of some famous wine-bibber, gluttonous man, or friend of publicans, porter swiller, or small beer drinker, over the door. And, dear Sir, I should have liked much to have been with you at Tôtes; but how could you be so wicked as to encourage the monkey to break the Sabbath day? I almost think I see the hearty old dame in the midst of her half-year's wash. If such were the custom in England, we could submit to the miseries of the washing day better than we do generally. And the garden — oh Sir, the garden is beautiful. I wonder what he of the Bear and Spear would have thought or said about it.

And now, Sir, for Miss *Variegata*: she hits my opinion to nothing. A museum should be kept in a room in the parish workhouse, and the garden attached to the house, and kept in repair by the paupers and invalids, under a scientific and amateur governor. I think a public orangery would be no great speculation in England: there are plenty of club-rooms, smoking-rooms, reading-rooms, &c., established in large towns, which may be decked out with oranges, myrtles, or geraniums, &c., at the pleasure of the landlord. Mr. Joseph Thompson's observations are very good, and I hope will lead to some further enquiries respecting the physiology of plants; but he is evidently on the wrong side of the question. There is clearly an ascending as well as a descending sap in every vegetable, not to speak of the bleeding of late cut vines. How comes it that a plant that is dying for want of water, immediately pricks up its leaves as soon as water is applied to its roots. If the branches, fronds, buds, and leaves are caterers for the roots, instead of the roots being caterers for the branches, how come some oaks, at seven years old, with a head like a besom and a root like a carrot, to be only a yard high, and an inch in diameter in the stem? Such oaks I always cut off by the surface. Mr. Mitchel may have his caterers and me mine, and see whether he will cater roots as soon as I will cater branches. Mr. Thompson is like a young surgeon; he has observed veins in the human body, but his pocket microscope has not been sufficient to detect the arteries. Robert Byers, Esq., may heat his houses with hot water, or hot steam, or hot air, if he chooses; but I shall never like any thing so well as *hot bricks*. I wish I had a hot-house adjoining his, with only a wall betwixt us: should he build his furnace and boiler on my side, I venture to say that I could grow as many pines and grapes with his waste or overplus heat as he could with his hot water; and the cost of his apparatus would build me an excellent Dutch pit. A friend of mine has a range of houses built to be heated by steam, at a vast expense. The family are gone abroad for a few years, and he rents the gardens till their return. He tells me that he could not be troubled with the steam, but built a fire flue in it. His houses this moment are full of pines well swelled off, most of them from 4 to 7 lbs. weight (not Providences). I think it would do T. A. Knight, Esq., good to see them; and the gardener would be as glad to show them, and sell them too, if Mr. Knight wished to treat his friends with good pines. The gardener wants customers, as

" He dwells unnoticed and alone,  
Beside the springs of Dove;  
A lad whom there are none to praise,  
And very few to love."

He need not be ashamed of his name; it is Mr. George Lennox, gardener to Jesse Watts Russell, Esq., Ilum Hall, near Ashborne, Derbyshire. Mr. Lennox has grown the Providence pine to above 15½ lbs. avoirdupois. It is a pity that Mr. Knight should think that such pines are not worth growing

Mr. Anderson's number tally is all very well, but there is nothing new in it, and you have figured and described far better long ago. A. Z., the Landscape-Gardener, is excellent; I could not have written a better article myself. The Oswestry conservatory looks very well on paper, but it will not grow plants very well, and it is evidently a bold speculation, and catch-penny advertisement. Mr. Spinosa's gorse fences are truly an abomination; they take up too much good land, for the land must be very good where gorse will grow sufficiently strong for a fence against large cattle. None of your gorse-fed horses for me. I do not approve even of *thorn* fences on some lands. In the dividing of pastures, where there are cattle on each side, I am always obliged to make two good fences to guard a bad one. I have many miles of such fences under my care, most of which have already cost above a shilling per yard, and are not good fences yet; whereas a row of strong, say poplars, planted a foot apart, will, in the course of a few years, become a *wooden wall*, so close that a hare shall not creep through, and so high that a partridge or pheasant cannot fly over. The *Calceolària*, the *Hydránga*, and even the flower-stand of Mrs. Fox, are all quite old to me. The sweet potato culture is new to me: I think it a valuable communication, as well as a very valuable vegetable. The process of destroying wasps at Sweeney Hall is too complicated: a horseman's pistol, charged and wadded with squib materials, and fired into the hole, which must be closed up immediately, is quite sufficient; or they may be dug up and puddled with water. Such nests as hang in sheds or on trees are readily taken in a bucket of water. For such as hang in thick hedges, and cannot be well got at, the pistol should be charged and filled to the muzzle with peas; stand at a proper distance (three yards), fire straight, and you will blow them all to —. Mr. Parkes should not wait till his fruit is eaten before he kills the wasps, nor even till the fruit is ripe. He should hang the phial glasses on the wall in good time, half filled with sugar and vinegar; the outside of the glass should be well anointed, particularly about the mouth, with honey, sugar, and water; they should be regularly emptied and renewed, as they get full of blue flies, as well as wasps. The ground wasps are a smaller species than the hanging ones.

It is very pleasant to see how many fine fruits are cultivated at Sydney, but, as I never intend going there, the catalogue is not very interesting. The *Transactions of the Horticultural Society* are rather insipid, except the management of the vine at Thomery, which is very good indeed. I cannot think why Mr. Knight calls a bark-bed an "irregular and ungovernable heat." I can regulate and govern a bark-bed at a twentieth part of the trouble attending a coal fire, but I suppose it is his hobby. I am not at all disposed to profit by his suggestions; yet I must thank him for the invitation, and he may look at my pines in return. The new publications on gardening and botany are all out of my line. I like Mr. Robinson's designs of cottages, &c., better than you seem to do, but am not such a good judge as you. The literary notices are generally good, but I am sick of polyanthus and auricula shows. I have no objection to the gardener's newspaper proposed by Mr. Burnard, if it comes in a parcel once a month, unstamped. Yours, &c. — *Agronome*. June, 1829.

*Plan for a New Garden.* — Your correspondent, Mr. Green, jun. Stepney, (Vol. III. p. 495.) has satisfactorily pointed out that my plan for a new garden was not a good one, and I feel convinced of it in the soil I tried. I have since relinquished the idea of forming a garden on the spot. The plan, I think, is more likely to be useful in drier soils, and still more so in drier climates, than the West Highlands, and such as are of no great depth. — *W. M. Argyleshire*, Nov. 6. 1829.

*The Flower-Garden at Dropmore* (Vol. III. p. 258.) I think on a good principle, so as to have the gardens in beauty by the succession of summer and winter flowers intermixed, at the same time that each set reigns in its

season; but the plan of the flower-garden itself is somewhat objectionable, more particularly the centre (1), and its appendages (15 15 15 15). Your own remarks on the plan of the Welford Hall grounds, I think in some degree applicable here (Vol. IV. p. 91.). It is very difficult to judge correctly from ground plans, of the effects produced by the different modes of laying out and disposing the patches and dug-borders of a flower parterre. The more frequent introduction of such plans, I doubt not, will be of great advantage to the profession of practical gardeners, who may be enabled to pick up something from even the worst plan, if it should only be to correct one of his own blunders. From the exposed situation of my grounds, I have been obliged to introduce a greater number of hedges than is, perhaps, justifiable in good practice, and over these have raised high banks, on which I plant shrubbery, and in front of them also; so that it will have the effect of giving depth to a narrow belt. I had another object also; by increasing the quantity of fine soil, I expect the shrubs will come away more freely. Walls of compressed earth, as noticed in your First Volume. p. 355., might probably have been easier and more quickly substituted. I should like to know what sort of soil or mixture is best for such walls, and the proportions. I shall be obliged if any information on this head can be given in an early Number; and also of the cost of the Bramah press recommended? — *W. M. Argyleshire, Nov. 6. 1828.*

*Prize Gooseberries for 1828.* — In your Magazine (Vol. IV.) J. C. informs us, that, by consulting the gooseberry records, it will be found that the heaviest berries, at the commencement, seldom exceeded 10 dwts.; and, as he has not informed your readers what the heaviest are called, I shall select a few from each class of the heaviest this year: — Roaring Lion, 29 dwts.; Sir John, 25 dwts. 2 grs.; Huntsman, 24 dwts.; Squire Hammond, 23 dwts. 20 grs.; Statesman, 22 dwts.; Top Sawyer, 22 dwts. 17 grs. All the above are red. Yellow: Gunner, 24 dwts. 5 grs.; Sovereign, 22 dwts. 17 grs.; Nelson's Waves, 22 dwts. 8 grs.; Hawk, 21 dwts. 8 grs.; Husbandman, 21 dwts. 6 grs.; Rockwood, 21 dwts. 5 grs. Green: Lord Crew, 23 dwts.; Providence, 20 dwts. 7 grs.; Angler, 20 dwts. 1 gr.; Green Willow, 19 dwts. 20 grs.; Elijah, 18 dwts. 21 grs.; Peover's Pecker, 19 dwts. 10 grs.; Bonny Lass, 21 dwts. 10 grs.; Thrasher, 20 dwts. 12 grs.; Lady of the Manor, 20 dwts. 9 grs. The heaviest berry now on record is the Roaring Lion, grown in the year 1826, by J. Bratherton; it was 31 dwts. 16 grs. There are twenty-four new seedlings sold out this year. — *M. Saul. Sullyard Street, Lancaster, Dec. 6. 1828.*

---

#### ART. XVI. *Queries and Answers.*

*CORRECTIONS and Additions for the Encyclopædia of Gardening.* — Agreeably to your invitation (p. 238.), I send you the following, and remain, Sir, &c. — *B. April, 1829.*

Berkeley Castle, near Berkeley, Colonel Berkeley. The kitchen-garden and forcing department are well managed by Mr. M'Intosh.

Spring Park, near Nailsworth, Lord Ducie. Beautifully-disposed pleasure-grounds, and a good kitchen-garden, kept with great neatness by Mr. Napier.

Kingscote Park, near Horsley, Colonel Kingscote. A fine place; the pleasure-grounds extensive, and within the last five years, greatly improved under the direction of Mr. Page, nurseryman and landscape-gardener, of Southampton. The whole kept in the neatest order by Mr. Boyce, author of several articles in the Gardener's Magazine.

*Number of Men requisite to keep a Kitchen-Garden and Pleasure-Ground, &c.* — Sir, I see that some of your correspondents (p. 108.) have been so

kind as to make some observations on the queries I asked (Vol. IV. p. 447.), respecting the number of men requisite to keep a gentleman's kitchen and pleasure garden, &c., in good order. They complain that I have given no regular data, therefore, I have taken the pains to explain every circumstance attending my present case and circumstances. As to situation I should think this a very bad one. The garden is nearly sixty years old, and the soil is from 3 in. to 6 ft. deep. It is a nasty sour soil, very bad to work in during very wet or very dry weather; a better soil in appearance for vegetables could not be, but it is so very late. I am taking away both trees and soil from time to time, adding all new in the wall borders, and am double-digging the remaining part of the garden. I have had two men and a boy for a month working hard on about a chain's length of ground before it was fit for tillage, clearing away stones, &c., from old buildings which had been thrown down and covered over. We found some stones so very large, about 6 in. deep under some asparagus beds, that I was obliged to get a horse to draw them out. Bad as this may appear, the garden has passed through the hands of several professional English and Scotch gardeners.

My garden is on the side of a hill, declining so much that it falls  $1\frac{1}{2}$  in. at every foot, and leads down to a wood of immensely high timber. The garden is about 150 yards from the top to the bottom. We have to wash all the vegetables and salading, and to carry them into the house; and I have also the care of 3 acres of orcharding to plant, prune, and graft, &c. I have to gather and store up all the fruit for kitchen and parlour use, and to take in desserts and flowers for table, &c. I have to clean the snow from the top of the house when any falls, and it takes all hands from the garden to store ice and snow for summer use which requires a week; and you must be aware that it takes a great deal of time to get it up for the use of the house, as they use a great quantity: and then the cook must have *one* from the garden to assist in getting up the ice creams, &c., and she must have one man three hours every day for other house work; and the butler or footman or some one will come and say, "My employer says one of your men is to go and take this letter somewhere or other." At the same time they were deceiving me. Then there is hay time and harvest, when all hands must go to assist the bailiff, with many other jobs too tedious to mention. I have no glass at all, but my trees are infested with canker, mildew, insects, &c.; for my employer wishes me to grow all the seeds I can, which are taken up to the top of the garden and then up nineteen perpendicular stairs into a fifteen feet room which is all the place I have fit for that use. Then I and all my assistants have to go a mile and a half every night and morning, and leave the garden exposed to every thing.

With respect to the pleasure-gardens there is as much mowing as two men can do in one day every fortnight with cleaning away the grass. There are also the rolling, and clipping round the flower knots which are cut in the turf, including all the turf clipping 530 yards, 200 yards of edgings of various flowers, 200 yards of dwarf box edging, 250 yards of thrift edging, 460 yards of gravel walks (gravel is a very scarce article here), and 780 yards of sand walks. All the walks are 5 ft. in width, and there are flower borders to the principal, and all is expected to be kept clean.

I hope some of your most practical correspondents will handle this to the best of their knowledge for the advantage of gardeners and their employers. I forgot to mention the shrubberies also, besides a vast quantity of plantation, and fishing waters, though there are a bailiff and gamekeeper kept. The walls are from 6 to 30 ft. high. — *A Shipston Correspondent.*  
*March 21. 1829.*

*The Poor Widows, and a Proposal for a Gardeners' Fund.* — Sir, I have taken the liberty to enclose one shilling, sixpence of which I wish to be

given to each of the widows of the poor gardeners you have mentioned, Mr. Davidson and Mr. M'Leish. I am sorry I cannot afford to send more; but having a large family, and being in narrow circumstances, I must, Sir, beg your acceptance of this trifle for them. I should be happy to see a fund established for the relief of gardeners' widows and sick and infirm and superannuated gardeners. I am persuaded that the thing might be practicable. Perhaps, Sir, you will give it your consideration. I am, Sir, yours, &c. — *D. French. Harlow, Essex, March 30. 1829.*

*Hedges made of Whins.* — I was much interested by a short paper in one of the late Numbers of your very valuable Gardener's Magazine, on the subject of fences made of whins (furze). Having frequently observed on commons, the impenetrable face this plant presents where it is cropped by sheep, I have thought it might be made useful in forming hedges, provided it was kept cropped by shears or some other instrument. Without this process furze would soon become naked, and would be extremely mischievous by scattering its seeds on the adjacent lands. Having expended much in raising thorn hedges, I should be obliged if your correspondent would inform me through your publication, what is the best plan of raising and preserving in fences the common whin. I am sure any particulars you can present to the public on the subject of hedges, must be highly valuable to the land-owner, and will always add to the interest with which your work is read by your obedient servant, — *E. D. April 14. 1829.*

*Ants on Peach Trees*, in answer to G. M. of Atherstone. (p. 259.) — Ants in this case are not the cause but the effect of injury. Before the ants become troublesome the trees are infested with the Aphis, *pucceron*, which produce what is commonly called honey-dew, and which is their excrement, to which the ants resort for food. To destroy the Aphis I frequently syringe the trees with water mixed with a strong decoction of potato haulm and elder leaves, which I have found to be most effectual. I have often used, as a bait for the ants, the refuse part of melons, sent from the table of the family; when this is not to be had, turnips cut and rubbed over with honey; by which I have taken thousands. I am, Sir, &c. — *W. Boyce. April 15. 1829.*

*Effect of the Sea Air on Peach and Nectarine Trees planted contiguous to it.* — Sir, The effect prevails to a greater distance than any one would imagine, particularly when the trees are not sheltered from the south-west wind. An east aspect answers well, but a south one is invariably hurtful. In the year 1812, I was at a garden in the east part of Sussex, from which the sea was visible at the distance of sixteen miles. A south-west wind prevailed during the May of that season which killed the young wood; the trees, however, made fresh wood, but the season was too far advanced to mature it, and the trees all died away. I was, also, last year in an extensive garden ten miles from the sea where a part of a south wall planted with peach trees was exposed to the south-west wind then prevailing, which entirely destroyed the trees; those on the east aspect, however, were preserved in a good state. I have seen no other kind of fruit tree injured by it.

I have had a peach-house for two years, in which the trees have thrown off their buds instead of expanding them: I conjectured it was occasioned by the wood being over ripe and too hard. The subsequent season I shortened none of the wood, intending all the greenest wood to remain; but, although in both seasons I took care to keep a good degree of humidity in the house, I have not been able to obviate the same occurrence.

I have three other peach-houses, two heated by steam, and the other merely covered with glass.

The first-mentioned house is heated by fire; but I cannot attribute it to that, as I have been careful to keep the air moist. This house being found earlier than the others, I uncovered it earlier, as I always do when the

fruit is off. I have been told by a friend that it is the effect of the sea air after uncovering, but I can scarcely think it. I shall feel obliged to your readers if they can assign any other cause. If I live and continue here another season, I shall not uncover so early, and if desired I will communicate the result. I am, Sir, &c. — *J. D. P.* Feb. 16. 1829.

We shall be happy to hear from our correspondent on this or on any other subject. — *Cond.*

*Canker in Apple Trees*, in answer to W. G. W. (p. 111.) — Sir, I would advise W. G. W., after taking out all the cankered wood, to use the following composition: — Take fresh cow-dung, quicklime, and wood ashes, of each an equal quantity: to them add a little sulphur, with a sufficient quantity of urine to make it of the consistence of paint; and, having mixed the whole well together, then, with a painter's brush, wash the trees well, taking care not to miss any of the parts which are infested. I have tried it on several trees in my orchard, and have found it to answer perfectly. I am, Sir, &c. — *An Amateur.*

*Apple Trees for an Orchard.* — Sir, In reply to your correspondent, J. S. L. (p. 111.), I can strongly recommend the following apples: — The Nonesuch and the Newtown Pippin as autumnal fruit, and the Pome-roy, Brandy-apple, and the Ashmead's Kernel, all of which are good in the winter and spring. The last three apples are, I believe, natives of Gloucestershire, and are to be had at the Gloucester nurseries. There are no finer apples than these. — *C. Lawrence.* Cirencester, March 12. 1829.

*The Frankincense Pine (Pinus Tæda).* — Has any of your readers seen this pine with suckers, as I have heard it said that it throws up these when cut over by the surface. — *J. D. C.*

*The Coccus ovatus.* — Sir, In Vol. IV. p. 189. a reader wishes to know what will kill the *Coccus ovatus*. I beg to inform him that I had some choice apple trees against a wall, which were much troubled with them, when I thought of the following simple remedy: — I unnailed the branches and poured boiling water (though I would recommend soap-suds in preference) on the trees, and thus effectually killed the insects which were under the shreds. I doubt whether it would not injure the buds of peaches, nectarines, and apricots. I have not tried it for the American bug, but I think it would succeed. In cases of canker I find it best to head down and scrape and clean the stock well, and then dress it well with soap-suds and sulphur. I am Sir, &c. — *J. Haythorn.* Wollaton, Jan. 7. 1829.

*Cabbage Plants bitten off.* — If a Surrey reader (Vol. III. p. 381.) will, in a morning, remove the soil an inch or two deep round the stems of his cabbage plants which have been bitten off the preceding night, he will almost invariably find the enemy in the shape of a dark muddy-green caterpillar or grub, varying in length from 1 in. to 1½ in. This plan, if followed up, will certainly tend materially to lessen the evil he complains of, and prevent an immense increase the following season. I do not apprehend that wire worms attack the *Brássica* tribe. Perhaps some of your readers will favour us with an entomological description of the before-mentioned caterpillar. I am Sir, &c. — *A Florist.* Feb. 8. 1828.

*Heaths and Ferns.* — I am glad to see two papers in a late Number on Heaths and Ferns, and would be glad if any of your correspondents would inform me of any nursery in which these tribes are cultivated to a considerable extent, as I want a supply of each. Mr. Housman gives a list of ferns, which he says are to be had at "the Liverpool Garden." The Liverpool Garden is, undoubtedly, the Botanic Garden, though I presume he does not refer to that, as I conceive nothing is sold there. [On the contrary, we believe ferns and other herbaceous plants are sold.] I am quite at a loss to account for the great difference in prices at various nurseries. I was furnished with a list of ferns and the prices per plant, some weeks ago, by a nurseryman, being from 5s. to 7s. each, which ap-

peared to me most extravagant. I applied to Mr. Miller of Bristol, whose collection was very small, but consisted of the same species which were named in the former list: his prices were 1s. and 1s. 6d. per plant. Horticulture is now so much encouraged that nurserymen and florists would consult their own interests by keeping down their prices as much as possible, and thereby very much extending their market to a large class of customers, who are become *re infecta*, but are afraid to enter upon that which really ought, at the present time, to be a cheap gratification. Yours, &c. — C. Lawrence. Cirencester, March 12. 1829.

*Growth of Broccoli, Sea-kale, and Celery.* — I wish some of your correspondents, who have been particularly successful in the management and growth of broccoli, sea-kale, and celery, would furnish the details of their operations through your Magazine; the value and utility of which would, I think, be enhanced by a more liberal supply of practical directions from those who have chanced to be successful in raising productions in common domestic use. — *Id.*

*Plan for watering Cucumber Hills.* — Sir, My plan is nothing more than a watering-pot pipe with a funnel at the top, I have a stick to fit in easy, and thrust both down to the dung in any part of the bed, then withdraw the stick and pour in water. Would it not be to the interest of the nurseryman and horticulturist, to try the plan on the orange, camellia, &c., in pots, the soil of which is often moist above but dry below. — J. Haythorn. Wollaton, Jan. 7. 1829.

*Characters of the principal Gooseberries.* — Your correspondent who favoured us, in your Number for December 1828, with some remarks on gooseberries, would confer a general benefit on your readers in the West of England, who are little informed on this subject, if he would enable you to publish an enumeration of the characters of the principal kinds, distinguishing those which are conspicuous for earliness, lateness, high flavour, copious bearing, sweetness, acidity, beauty, fitness to be gathered in an early stage of growth, size of the plant, rapid growth and strength of the plant, fitness for preserving, beauty of the fruit, favourite soil and aspect, and any other remarkable or useful qualities which any of the varieties may possess. I am, Sir, &c. — *Causilicus.* Jan. 18. 1829.

*Pots without Apertures to prevent the Escape of Water.* — Mr. Knight states in a paper in Vol. VII. Part II. of *Hort. Trans.*, “Whenever I have adopted the practice of plunging the pots into the ground, or into the soil of a larger pit, I have almost invariably used pots without any apertures, to prevent the escape of water and of the roots. Gardeners are generally very strongly prejudiced against pots of this construction; but, whenever plants are kept constantly under glass, I have found that they may be used with advantage; and by properly covering the mould with tiles, I have not found any difficulty in preventing during summer, the ingress of too much water, when the pots have been placed in the open air.” I should be glad to know if any of your readers have adopted or tried this very singular practice of Mr. Knight, and what has been their success? Had it been recommended by any other man than the President of the Horticultural Society, I should have considered the writer of unsound mind, or a rogue wishing to entrap some one into the death of a number of plants. — *A Common Gardener.* Feb. 6. 1829.

*The Tottenham Park Muscat Grape.* — Sir, If any of your readers, who may have what is called the Tottenham Park Muscat vine, and have fruited it, will give their opinion whether it is a new variety of the White Muscat of Alexandria, or whether it is not owing to the particular situation it is planted in at Tottenham Park, it will be no doubt satisfactory to others as well as to myself.

I understand it is planted within the hot-house at Tottenham Park, by the back flue, which may cause it to ripen its fruit better than those

planted outside ordinarily do, and which is the case in that place. I fruited it last season, but could not perceive any difference whatever from the other White Muscats in the same hot-house, and under the same treatment.

If any of your correspondents who have fruited it can give a better account of it, it will reconcile those, perhaps, who have been induced to give two guineas a plant, for what is feared *by some* to be neither more nor less than the old White Muscat of Alexandria. I am, Sir, &c.—*W. W. Feb. 20. 1829.*

*Zante Currant Grape.*—Sir, I shall be obliged to you, or any of your correspondents, who will inform me, through the medium of your Magazine, of the best method of treating the Zante Currant grape, so as to make it fruitful. I have had plants of it for several years, but have not succeeded in getting them to produce. I am, Sir, &c.—*C. L. May 9. 1829.*

*Vines trained down from the Rafters.*—Sir, In reply to the querist (p. 110.), touching the growth of vines, when trained down from the rafters, I

have to state, for his information, that the vines are planted *outside the house*, and when introduced, are trained upon wires immediately under the rafter, and under each other, or in the same plane with it; say about 1 ft. asunder (*fig. 172*) by which he will perceive that neither of these great

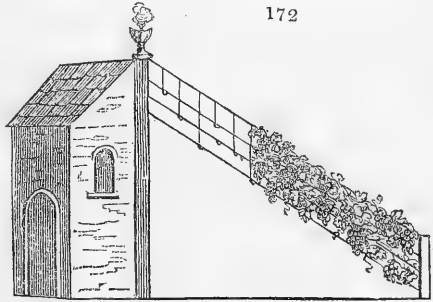

requisites, light and heat, is thereby obstructed. By this method of training, the back wall becomes an object of great importance, as it may be entirely covered by a continuation of training on a trellis, and enjoys all the benefits of light and heat that could be derived, if there were no other training admitted in the house. I am, Sir, &c.—*John Haycroft.*

*Vines for a Green-house.*—Sir, In a green-house intended chiefly for geraniums, the health of which is entirely studied, I am about to put six vines, and as of course the house must not be heated to a higher degree than the geraniums require, I shall feel much obliged by any of your experienced practical readers mentioning in your next Magazine, whether the following vines will succeed in such a situation:—White Frontignac, Grizzly Frontignac, Early White Teneriffe, Black Hamburgh, Royal Muscadine, and West's St. Peter. I shall also feel much obliged by their mentioning the names of any other vines you can particularly recommend for such a green-house. I am, &c.—*A Constant Reader. Sept. 16. 1829.*

*Mr. Squib's Mode of pruning the Vine.*—A subscriber in Salem, Massachusetts, is desirous of a more detailed account of this method, with its advantages and disadvantages; and we should be much obliged to Mr. Squib, or any other gardener who has practised this method, to supply it. What is said of the method, in the page above referred to, is sufficient for an experienced vine-dresser, but not, perhaps, for a beginner.—*Cond.*

*Sisymbrium indicum.*—Can you give me an account of *Sisymbrium indicum*, from the Isle of France, an Indian cress said not to suffer from the hardest winter; how to cultivate it; and where seeds may be procured?—*W. J. Bridport, May 25. 1829.*

*Mr. Whitlaw's Hemp.*—Sir, In some one of the periodicals I lately met with a description of a new hemp-plant, said to be introduced by Mr. Whitlaw, and grown in his garden at Bayswater. Would you, or any of your correspondents, furnish me with the mode of culture of this plant, and how



seeds of it may be obtained, I should feel obliged. Large quantities of hemp are manufactured in this place; and could the growth of an article superior to the common kind produced in this neighbourhood be introduced, it might prove of essential benefit to the labouring classes of the town and its vicinity. — *W. J. Bridport, May 23. 1829.*

*Cider.* — Sir, Can any of your correspondents inform me of any book containing practical directions for making cider, according to the most approved method? Yours, &c. — *Rusticus.*

Our correspondent may refer to Croker's *Art of making and managing Cider*, London, 8vo, 3d edit. 1827. — *Cond.*

*Tulipa Sibthorpiana*, enquired for by D. Falconar, Esq., of Carlowrie, (Vol. IV. p. 446.) is in the collection of Robert Barclay, Esq., of Bury Hill. — *Perceval Hunter. Epping Forest, Essex, March 18. 1829.*

*Trèfle farouche.* — Many thanks will be due to the person who will instruct the British farmer how to turn this beautiful and early plant to any practical use in this country. I tried it several years myself without profit. I have sown it as late as the 6th of June, among spring wheat, but it flowered and ripened its seed before the 29th of September. It is strictly annual, and if it once forms its seed it dies. I therefore conclude, that if it be sown among spring corn, it will rise with the corn, blossom the first summer, and spoil or endanger the barley or oat crop. In Roussillon, where it is principally cultivated, it is sown as a secondary crop on the wheat stubbles, upon one ploughing given immediately after wheat harvest; and in that fine climate, with the aid of irrigation, which is extended to nearly all the arable land there, this species yields a copious crop, to be cut in May, or for soiling in October, when it is ready to blossom. Receiving this check, the plant endures through the winter, and comes into blossom the following May, when it yields a full hay crop, and is then ploughed up to be succeeded by spring corn; but in England, when I have sown it immediately after harvest, I have never found our autumns warm enough to force a growth fit to come to the scythe before winter, though the plant yielded a hay crop early in the following summer: and, therefore, the question occurs, whether it will pay the farmer to break up his wheat stubbles for the sake of growing this crop, which he cannot get off early enough to enable him properly to prepare for a succeeding crop of spring corn in the same season, as he may do after stubble turnips. No farmer has strength enough to break up and sow all his stubbles instantly, as his corn crops are harvested. If the tillage occupies much time, the sun deserts him, and the stubble crops do not answer expectation; and for the little that he can plough up in good time, winter vetches and stubble turnips will, probably, answer his purpose better than *Trèfle farouche*. It is not impossible, that by sowing the *Trèfle farouche* by itself in July, a green crop might be obtained for feeding or soiling in October, to be succeeded by a hay crop in May; but in July no spring corn remains to be sown with it. What farmer will give up a whole year's culture to a green crop in autumn, and a hay crop in the following spring, without corn? It is, therefore, improbable that this crop will, in our cold climate, be of very extensive utility. Will some farmer try the experiment of sowing it together with lammas wheat in July, feeding down both in autumn, mowing off the hay in May, and leaving the wheat to rise and perfect itself afterwards? It is to be feared the wheat plant would be too much exhausted by the autumnal feeding and spring mowing, to yield a good crop of grain after this severe operation. The *Trèfle farouche* is a plant of singular beauty; but, from the deficiency of ligneous matter, the hay it makes must weigh very light, and for the same reason it must be more suitable for sheep than for horses.

*Trifolium Molinèri.* A plant extremely resembling the *Trèfle farouche* in habits, except that the blossom is of a paler colour, especially at the apex,

the plant some what more bulky, and the habit altogether more hardy, is the *Trifolium Molinèri*, which has been collected growing wild about Paris, and which, not impossibly, may be the Roussillon, or farouche trefoil, accidentally naturalised in that part of France. The seed of either may be had from your excellent friend, M. Vilmorin, Quai de la Magisserie, Paris, on whom I have, in many years' experience, found the strongest reason to depend, for the accuracy of the seeds which he sends out. I should be sorry to deter any agriculturist from an experiment with the *Trèfle farouche*, which may turn out beneficially, and I hope no farmer will consider these observations as having any other view than to point out where the principal difficulties lie, and to stimulate the exertion of his ingenuity to overcome or avoid them. I am, Sir, &c. — *Causidicus*. Feb. 4. 1829.

ART. XVII. *Horticultural Society and Garden.*<sup>3</sup>

SEPT. 1. 1829. — *Exhibited*. A collection of Seedling Double Georginas, from Mr. John Young, C.M.H.S. A collection of various flowers, from Robert Barclay, Esq. F.H.S.; also, from the same, Washington Plums, and specimens of a Plum unnamed, which proved to be the Imperial Diadem. A collection of Plums, Apples, and Pears, from Mr. Thomas Gibbs, F.H.S. Moorpark Apricots, and Purple-Fruited Passion Flower, from Mr. John George Fuller, F.H.S. Specimens of the Sanguinole Pear, from Andrew Arcedeckne, Esq. F.H.S.

*Also, from the Garden of the Society*. Flowers: Double Georginas, Seedling Georginas, Anemone-flowered Georginas, and Dwarf Georginas, *Verbena Melindres*, pulchella, and *Aublètia*, *Senècio élegans* fl. pl., *Eschscholtzia californica*, *Agératum mexicànum*, *Centaurèa americàna*, *Clàrkia pulchèlla*, *Hibiscus atricànus*, *Heliánthus lenticulàris*, *Giliapulchèlla*, *Ænothèra vimínea*, *Lindleyàna*, *quadrivùlnera*, *decumbens*, and *odoràta*; *Anthemis arábica*, *Trachymène cærùlea*, *Argemòne grandiflòra*, China-asters, Mule Pinks, China Pinks, French Marigolds, *Coreópsis tinctoria* and *Atkinsòni*, *Galárdia aristàta*, *Dònia villòsa*, and *Eccremocàrpus scàber*. — Fruit: *Gaulthèria Shállon*, and *E'mpetrum scòticum*; eight sorts of Pears, and Fourteen sorts of Apples.

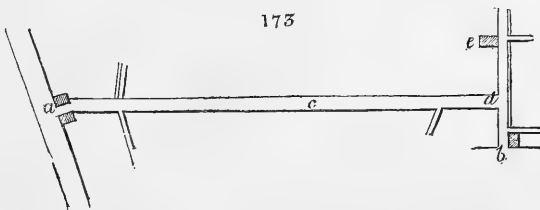

Chiswick Garden, Oct. 19. — The principal entrance (*fig. 173. a*)\* being now completed, visitors are no longer admitted by the back door which opens on Turnham Green (*b*). The archway, containing the door and a

\* The sketch is made entirely from memory, and has no pretensions to accuracy, which is not required for the present purpose.

ledge for the porter, is good; but, unfortunately, the straight broad walk (*c*) which proceeds from it, and is seen through the open iron-work, is at an oblique angle; what is worse, this broad walk, the main walk of the garden, may be said to lead to nothing; since it terminates in front of a wall in a low iron wicket (*d*); even the council-room (*e*) would have made a termination. But if the original plan of the garden (*Enc. of Gard.*, p. 1060.) be referred to, it will be seen that this council-room is a subsequent thought, and what else than incongruity can be expected from such a mode of proceeding? Taking this garden altogether, as a piece of design, it would be utterly beneath criticism if it did not belong to a public body.

In the fruit-room we observed an excellent collection of French and Flemish pears, and in this particular the Society is rendering a real service to horticulture. Indeed, we do not think it would be too much to say, that this service, when completed, will be worth all their other services put together. Perhaps it may be rather dearly purchased; but it is not always that a grain of wheat is found in a bushel of chaff. The true character of every thing and every body is certain of coming to light sooner or later; and those who think that we are unduly prejudiced against the measures of the Council of the Horticultural Society, and the plan of the Chiswick garden, will one day have their eyes opened. If we could see any thing like grand and masterly measures, we should feel delighted in praising them.—*Cond.*

---

#### ART. XVIII. *The London Nurseries.*

*THE Brentford Nursery, Mr. Ronalds and Sons, Oct. 27.* — Mr. Ronalds has, for many years, paid great attention to the culture and improvement of the apple, and has collected above 500 sorts, all of which have borne fruit for several years. The quantity of fruit grown on his specimen trees this season is estimated at upwards of 800 bushels; and it will easily be conceived, from this circumstance, that the trees are of such a size and age, and Mr. Ronalds's experience respecting their individual character and habits of such an extent, as to enable him to determine fully, and with confidence, the merits of every variety. For several years he has studied them at all seasons with this view, and kept notes; and his descriptions of the different varieties, of the hardness or delicacy of the tree, its blossoms, leaves, fruit, time of ripening, keeping, &c. &c., are copious and voluminous. Many of the fruits also have been drawn by one of his daughters, Miss Elizabeth Ronalds, in a style surpassed by no artist whatever, and only equalled by the late Mr. Hooker and by Mrs. Pope. We have strongly urged Mr. Ronalds to publish a selection of engravings and descriptions; the former in folio plates, with from eight to twenty apples on a plate, something on the principle recommended in this Magazine (Vol. III. p. 325.); and we hope he will do so, because we do not know any one who could perform such a service so well. The Horticultural Society may, in the course of several years, describe the fruit in their interminable work; but who has had experience of the full-grown trees like Mr. Ronalds? and of what fruit is it so desirable, as speedily as possible, to disseminate all that is useful to be known? The apple is the poor man's fruit.

We saw specimens of nearly 280 sorts of Mr. Ronalds's collection, arranged and labelled in his fruit-room; the other sorts completing the collection being summer apples, had, of course, decayed. The largeness of some, and the beautiful shapes and fine colouring of others, excited admiration. It is gratifying to think that such beautiful and useful objects may be grown with ease in every poor man's garden, and in all our hedge rows, and by the road sides, as in Germany and France, delighting the eyes of all, and

gladdening the hearts of those to whom they belong. The culture of no fruit deserves to be more encouraged than that of the apple, and from Mr. Ronalds's knowledge of the trees, he will be able to indicate such as are adapted for producing least shade on the crops below, such as are best fitted for cold and exposed situations, and a variety of other useful particulars now imperfectly understood.

Mr. Ronalds's successful exertions afford another proof of what we have all along stated, that if the labours which the Horticultural Society have undertaken to perform in their own garden had been given out to the nurserymen, to market-gardeners, and to gentlemen's gardeners around the metropolis, they would have been much more speedily and effectually performed. The Society might still have received things in their garden from all quarters, giving them out to the individuals who had undertaken to perform specific divisions of labour. The saving thus effected by the Society would have enabled them to publish the fruits at once, and in a good style, as well as to give handsome premiums and high honours to the different co-operators. Nothing could have been more gratifying, more honourable, or more advantageous, in a business point of view, to the nurseryman, than this kind of arrangement. One nursery ever after would have been the fountain-head for apples, another for pears, another for grapes, and so on. All the country nurseries would have had their stock plants from these nurseries; and all the Fellows of the Society, instead of seven royal 4to volumes, price 59*l.* 15*s.* 6*d.*, containing about as much information as seven of our Magazines, price 1*l.* 4*s.* 6*d.*, would have had coloured engravings of all the best varieties of European fruits. From this standard work they would have given their orders, which, as far as means can be adapted to ends, would have been at every nursery correctly executed. The mind of the society, however, did not rise higher than that of an individual gardener; it set to work itself, and therefore it must now go on with its labours. — *Cond.*

*The Haverstock Nursery, Hampstead Road, Oct. 31.* — We have been much gratified by a call at this nursery, which we regret not to have before examined. Mr. Money, the proprietor, has one of the most extensive and correctly named collections of vines in the trade, and he has at least three sorts, which, we are sure, we shall be doing a real service to grape-growers to make extensively known. We had, through the kindness of our good friend, Mr. Oldaker, described a grape, called by him "West's St. Peter," in our First Number. (Vol. I. p. 56.) In that paper, Mr. Oldaker mentions "another St. Peter grape," and it would appear from Mr. Money, that there is a third St. Peter, because the one grown by him is very different from either of the two described or mentioned by Mr. Oldaker.

*Money's West's Black St. Peter* "was raised from seed about the year 1775, by Mr. Daniel West, in his own nursery ground, situated on the north side of the New Road, opposite Fitzroy Square, in the parish of St. Pancras. Mr. West had the highest opinion of this grape, as to all the qualities requisite to constitute a first rate sort; but the demand for grapes at that period being very trifling, this variety never became sufficiently known\* during Mr. West's life time; and after his death, Mr. Green, who got possession of his grounds, though sensible of the high merit of this grape, suffered the plant to ramble about in a state almost wild, and there being little demand, only a few plants were scattered about the neighbourhood. Mr. Green let the ground to a musical reed maker, and his daughter, who was his head gardener and paid very little attention to the vine, let things fall into a state of neglect, so that in a few years the ground fell into the hands

---

\* One person has been named to us who sold it under the name of Raisin de Carmes, at 10*s.* 6*d.* a cutting, with two eyes. — *Cond.*

of a Mr. Lawrence, who destroyed the original plant, and planted a young one in a very poor green-house, which, though very badly managed, produced exceedingly fine fruit." Mr. Money adds, "the lobes of the leaves

174

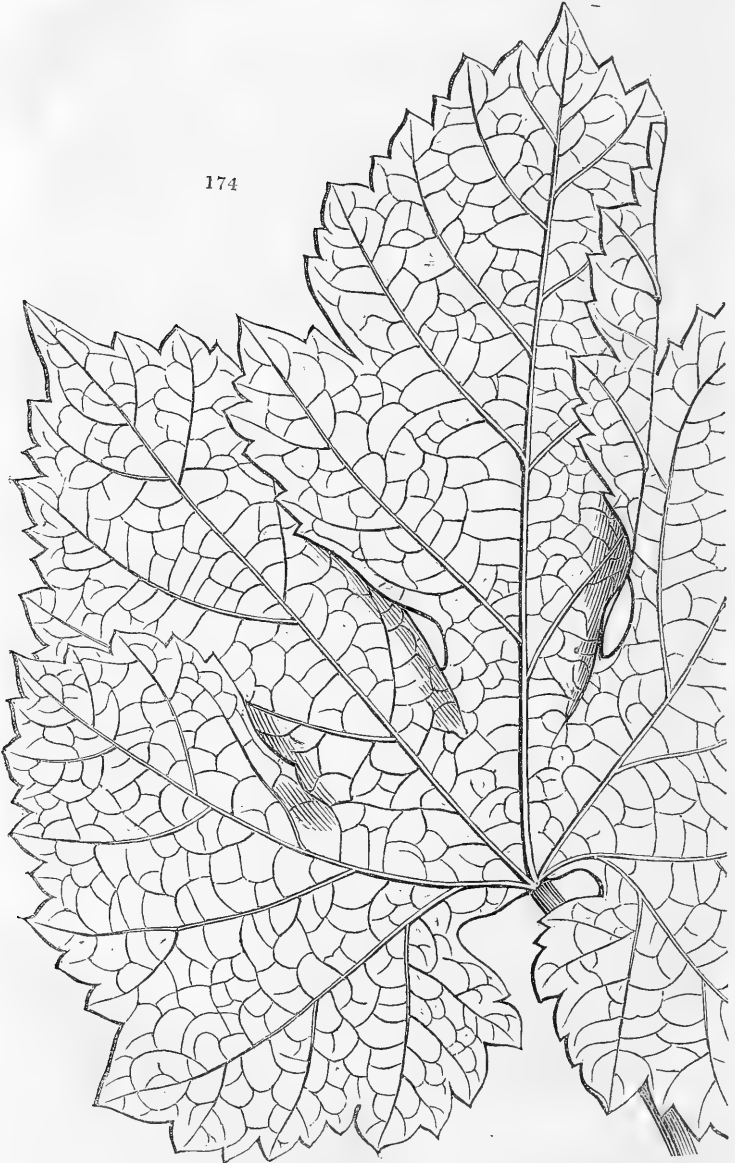

of this grape are not downy; but they overlap each other in a particular way (*fig. 174.*), by which it is known from all others. The berry is large,

oval (*fig. 175.*), dark, but not of the deepest black, very thin skinned, and each berry has only one seed. The size of the bunches is from  $\frac{3}{4}$  lb. to  $1\frac{1}{2}$  lb. The plant grows freely in a proper grape soil, and it will ripen against a south wall. I have been a grape-grower more than forty years, and have 150 sorts in my possession, most of which I fruit, and all of which I propagate; but I know of none, except the Muscat, so valuable as West's Black St. Peter."

Till the nomenclature of grapes is settled by competent authority, we propose to distinguish this variety of St. Peter from the two mentioned by Mr. Oldaker, by the name of Money's West's Black St. Peter. Mr. Oldaker's favourite grape may be called Oldaker's West's St. Peter.

Mr. Money has raised an Early Black and an Early White Muscat, both from seeds, which, if we do not deceive ourselves, will be real treasures to gardening, as they are likely to ripen in ordinary years against an open wall. We tasted some berries taken from the bunches of both, which, even in this singularly unfavourable season, were soft and very highly flavoured, though two other varieties of Muscat, on the same wall, were not even fully grown. A black Muscat, with a flavour equal to the white one, has hitherto, we believe, been a desideratum in horticulture; but a hardy Muscat is what few gardeners ventured to hope for. Mr. Money has an excellent variety of the Golden Muscat; and we never saw or tasted finer berries of the Black Tripoli, or saw leaves of a deeper colour than those of the Claret Grape in the open air. These leaves are worth growing as ornaments for the dessert; they are of the deepest purple red, and as thick as cartridge paper. There are here many sorts of grapes trained under the span roofs of the green-houses, in order to prove the sorts; and as Mr. Money scarcely propagates any other fruits, growing principally green-house plants and flowers, we believe he is remarkably correct in his names. Three vine plants were transplanted at from 12 to 14 years; the roots were 10 ft. long, the thick main stem still longer; the younger wood was headed close in, and the new shoots bore a crop the second year. It is commonly said that old vines will not transplant so as to give any advantage over young ones; but this, and various other instances that have lately come under our observation, convince us, that, provided abundance of roots is taken up with the plants, time is gained.

It is a nice point in the management of wall trees to know to what extent leaves may be taken off for the purpose of colouring the fruit and ripening the wood. The rationale of Mr. Money's practice is as follows:—When there is abundance of heat, and a sufficient portion of the season to elapse for every desirable purpose as to the fruit of the present year, and wood of the year following, it is of little consequence whether any leaves be taken off or not; but when the weather is cold, and the season far advanced, by thinning out leaves, the motion of the sap is checked, and a sort of withering or artificial ripening is produced both in the fruit and wood. The fruit, however, under this management, will neither attain so large a size, nor so high a flavour; nor will the buds for the following season be so plump, or the wood quite so large; but the wood will be sufficiently dry and firm to resist the frost, and the buds will grow, perhaps, about as well as seeds or bulbs gathered or taken up before they are ripe.

Apple trees canker here when they get down into the subsoil, which, as in other nurseries and gardens where the surface is dug, they are certain of doing; to prevent this, Mr. Money has moved a collection of 100 sorts twice, and below each plant has placed a pavement, or impervious layer of

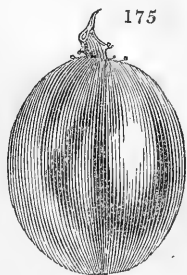

brick-bats and Roman cement. The plants are dwarfs, look healthy, and bear well. We observed a beautifully curled blue-green variety of German Greens, evidently nearly allied to the Woburn Kail; they have stood two years without running to flower, but they have produced side shoots or suckers which have been taken off and planted; the variety is perhaps of too slow growth, and the leaves not sufficiently tender to give it much value as a culinary or cottage plant, but it is certainly highly ornamental. Mr. Money propagates the mistletoe, and intends having a number of plants on standard crabs for sale; he places the berry on a rough part of the bark of a young shoot, causing it to adhere by its own glutinous pulp, and sometimes he ties a bit of thin muslin over it to prevent the birds from carrying it off. An improvement on the common watering-pot by him deserves notice; instead of the common rose, the pierced surface of which points outwards, he uses a rose of an oval shape, the pierced surface of which points upwards. (*fig. 176.*) The advantage of this form is, that the shower never falls on the ground or the plant with more than its own weight; and no carelessness on the part of the operator can ever wash away the soil from newly planted things or recently sown seeds, as is frequently done by the common pots. These pots have also the throat of the spout (*a*) made much larger than usual, which increases the delivery at the rose, especially when the pot is nearly empty. These watering-pots are made by Thompson, Oxford Street, and may be asked for under the name of *Money's inverted rose watering-pot.*

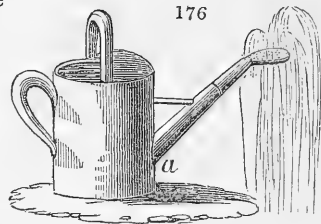

The principal article raised in the Haverstock nursery is the pelargonium, for which purpose Mr. Money has built a number of houses and pits; and, aware of the great importance to plants of soft and pure water, he has formed gutters to all these houses, pits, and frames, and led all the water to tanks, of which there are fifteen built, at an expense exceeding 500*l.* Almost all the houses are span-roofed, and almost all the gutters are formed in the wall plates by sunk grooves, formed in a direction from the inner to the outer edge (*fig. 177.*), by which, and by placing the wall plate not on a

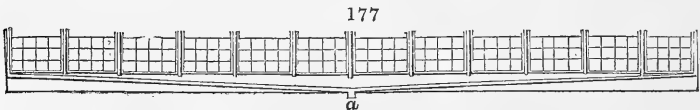

flat but on a bevelled surface, so as it may incline outwards, or its outer edge be lower than its inner one (*fig. 178.*), the collected water has a considerable current to the conducting pipe. (*fig. 177 a*)

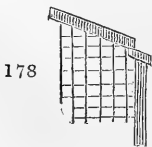

There can hardly be a cheaper or more secure description of gutter. Specimen plants of all the principal sorts of grapes are trained on wire trellises under the span roofs of these houses; but, as they are kept open all the summer, grapes do not ripen in them so well as in houses fronting the south, with back walls for absorbing the heat in the day time and giving it out at night. We shall conclude this notice by stating what was told us by Mr. Money of his former and present customers. Twenty years ago his pelargoniums were sold at considerably higher prices than at present, to families of property or regular gentry, who called in their carriages, and looked out the plants; now and for some years past, they are sold in greater numbers, and at much lower prices, to hawkers and basket-women. — *Cond.*

ART. XIX. Covent Garden Market.

		From		To				From		To				
		£	s.	d.	£	s.	d.	£	s.	d.	£	s.	d.	
<i>The Cabbage Tribe.</i>														
Cabbages, per dozen		0	0	9	0	1	0	Savory, per dozen bunches	0	0	0	0	2	0
White	-	0	0	9	0	1	0	Basil, dry, per doz. bunches	0	0	0	0	2	0
Red	-	0	2	0	0	3	0	Rosemary, per doz. bunches	0	0	0	0	6	0
Plants, or Coleworts	-	0	2	6	0	3	0	Lavender, dry, per doz. bun.	0	0	0	0	2	0
Savoy, per dozen	-	0	0	9	0	1	6	Tansy, dry, per doz bunches	0	0	0	0	1	0
Cauliflowers, per dozen	-	0	1	6	0	2	6	<i>Stalks and Fruits for Tarts, Pickling, &amp;c.</i>						
Broccoli, per bunch								Vegetable Marrow, per doz.	0	1	0	0	1	3
White	-	0	1	0	0	1	3	Large Pompons, each	0	2	0	0	7	0
Cape	-	0	0	6	0	0	9	Gourds, per dozen	0	1	0	0	1	6
<i>Tubers and Roots.</i>														
Potatoes,	per ton	3	10	0	4	10	0	Tomatoes, per half sieve	0	6	0	0	8	0
	per cwt.	0	3	0	0	5	0	Capsicums, per hundred						
	per bush.	0	1	6	0	2	6	Green	0	5	0	0	0	0
Kidney, per bushel	-	0	2	0	0	3	0	Red	0	0	0	0	8	0
Scotch, per bushel	-	0	1	6	0	2	0	<i>Edible Fungi and Fuci.</i>						
Jerusalem Artichokes, per half sieve	-	0	1	6	0	0	0	Mushrooms, per pottle	0	1	0	0	1	6
Turnips, White, per bunch	-	0	0	1	0	0	1½	Morels, dry, per pound	0	0	0	0	14	0
Carrots, per bunch								Truffles, per pound						
Orange	-	0	0	3	0	0	4	English	0	4	0	0	0	0
Altringham	-	0	0	6	0	0	8	Foreign, dry	0	0	0	0	14	0
Surrey	-	0	0	5	0	0	6	<i>Fruits.</i>						
Parsneps, per dozen	-	0	0	9	0	1	0	Apples, Dessert, per bushel	0	5	0	0	8	0
Red Beet, per dozen	-	0	1	0	0	1	6	Golden Pippins	0	7	0	0	10	0
Scorzoner, per bundle	-	0	0	0	0	1	3	Fearn's Pippins	0	4	6	0	6	0
Salsify, per bunch	-	0	0	0	0	1	3	Pearmains	0	4	0	0	5	0
Horseradish, per bundle	-	0	1	6	0	6	0	Ribstons	0	5	0	0	7	0
Radishes								Flower of Kent	0	5	0	0	7	0
Red, per dozen hands (24 to 30 each)	-	0	0	6	0	0	0	Hollandbury	0	4	0	0	6	0
White Turnip, per bunch	-	0	1	0	0	1	3	Apples, Baking, per bushel	0	2	6	0	4	0
<i>The Spinach Tribe.</i>														
Spinach,	per sieve	0	2	0	0	2	6	Pears, Dessert, per half sieve						
	per half sieve	0	1	0	0	1	3	Golden Beurrée	0	4	0	0	5	0
Sorrel, per half sieve	-	0	0	0	0	1	0	Autumn Bergamot	0	2	6	0	4	0
<i>The Onion Tribe.</i>														
Onions								Doyenné	0	3	6	0	5	0
Old, per bushel	-	0	3	6	0	4	0	Swan's Egg, fine	0	3	0	0	3	6
Pickling, per half sieve	-	0	2	6	0	4	0	Pears, Baking, per half sieve	0	2	0	0	2	6
Spanish, per dozen	-	0	2	0	0	4	0	Cadillac	0	1	6	0	2	0
Leeks, per dozen bunches	-	0	1	6	0	0	0	Chaumontel	0	1	6	0	2	6
Garlic, per pound	-	0	0	6	0	0	10	Quinces, per half sieve	0	1	6	0	2	0
Shallots, per pound	-	0	1	0	0	1	6	Medlars, per half sieve	0	3	0	0	4	0
<i>Asparaginous Plants, Salads, &amp;c.</i>														
Lettuce, per score								Peaches, per dozen	0	6	0	0	8	0
Cos	-	0	0	9	0	1	3	Plums, Dessert, per punnet	0	0	0	0	2	6
Cabbage	-	0	0	9	0	1	0	Barberries, per half sieve	0	5	0	0	7	0
Endive, per score	-	0	0	9	0	1	6	Elderberries, picked, per bushel	0	0	0	0	10	0
Celery, per bundle (12 to 15)	-	0	0	9	0	1	6	Cranberries, per gallon	0	2	6	0	4	0
Small Salads, per ½ sieve	-	0	2	0	0	0	0	Walnuts, per bushel	0	5	0	0	8	0
Watercress, per dozen small bunches	-	0	0	4	0	0	6	Chestnuts, per peck	0	4	0	0	8	0
Burnet, per bunch,	-	0	0	2	0	0	0	French	0	4	0	0	8	0
<i>Pot and Sweet Herbs.</i>														
Parsley, per half sieve	-	0	1	0	0	0	0	Spanish	0	0	0	0	12	0
Tarragon, p. doz. bunches	-	0	0	0	0	5	0	Filberts, English, per 100 lbs.	1	10	0	2	10	0
Furslain, per punnet	-	0	1	0	0	0	0	Nuts, Spanish, per peck	0	4	0	0	0	0
Fennel, per dozen bunches	-	0	0	0	0	2	0	Pine-apples, per pound	0	0	6	0	10	0
Thyme, per dozen bunches	-	0	0	0	0	2	0	Grapes, per pound						
Sage, per dozen bunches	-	0	0	0	0	2	0	Hot-house	0	1	6	0	3	6
Mint, per dozen bunches	-	0	0	0	0	2	6	From the open wall	0	0	4	0	0	8
Peppermint, dry, per dozen bunches	-	0	0	0	0	1	0	Dutch	0	1	6	0	2	0
Marjoram, per doz. bunches	-	0	0	0	0	2	0	Malaga	0	1	0	0	0	0
								For Wine, per bushel	0	10	0	0	12	0
								Spanish Melons, each	0	2	0	0	3	6
								Oranges, per dozen	0	1	0	0	2	0
								per hundred	0	5	0	0	14	0
								Lemons, per dozen	0	0	9	0	2	0
								per hundred	0	7	0	0	14	0
								Olives, per gallon	0	0	0	1	10	0
								Sweet Almonds, per pound	0	2	9	0	3	0
								Brazil Nuts, per bushel	0	0	0	0	16	0
								Garden Snails, per quart	0	0	0	0	6	0

Observations. — The dry weather of the last month has been favourable to the late crops, but the prevalence of rain throughout the summer has chilled the soil so much that vegetation has made but slow progress, consequently our supplies have not been as yet so abundant as they generally are at this season. From this cause rather better prices for most articles have been obtained, which it is likely may continue throughout the winter,



as from the above cause and from the probability of early frosts, it is not to be expected that vegetation can now make very rapid progress. Turnips are at present in abundance and of good quality; the late crops do not promise so well, consequently it is expected they will be in more demand and bring better prices. Coleworts are at present not very abundant, nor are they likely to increase much in bulk before Christmas; it is likely therefore their present price will be supported. Broccolies are not as yet plentiful, but at the same time not much looked for or expected, except the Cape variety or Grange's cauliflower, which begins to make its appearance; but from the breadth planted, should the weather be moderate, a considerable quantity may be expected and prices in consequence moderate. Carrots do not promise well; and although our supplies from Bedfordshire of the Altringham variety have hitherto been good, the promise from Surrey is not great, as wet weather is unfavourable to the growth of that root. Savoys are not yet very plentiful, but I have no doubt will soon be abundant. Potatoes are in heavy supply, and at present none but of the best quality will realise the prices quoted, although better prices are confidently expected by the growers and dealers; and should bread maintain its present rate, I have no doubt these expectations will be realised. Onions, of which a great breadth has been harvested in much better condition than the early part of the season promised, are in fair supply at reasonable prices; but it is probable, from the extreme humidity of the summer and autumn, they will not keep well in the loft, and may become much scarcer and dearer by the spring. — *G. C. Nov. 5. 1829.*

## ART. XX. Provincial Horticultural Societies.

### ESSEX.

*Colchester and East Essex Horticultural Society.* — The Second Annual Show of this Society was held in Colchester, August 5. Dr. Maclean, Mr. Burgess, and Mr. Smith were chosen as judges, and awarded the prizes as follows: —

*Flowers.* Carnations. Stand: 1. Mr. Sally, gardener to H. N. Jarrett, Esq., Bromley Lodge; 2. Mr. Goodwin, Manningtree. Seedling: a fine scarlet flake, named Sally's Miss Penrice, Mr. Sally. Picotees. Seedling: 1. Mr. Sally; 2. Mr. Goodwin. A fine stand of seedling picotees from the Rev. — Green's, Lawford; a prize was given to one flower named Gillingwater's Miss King. — *Fruit.* Pine, Enville, Mr. Smith, gardener to Wm. Hawkins, Esq., Colchester. Melon: 1. Mr. Riach, gardener to R. Cox, Esq. Lawford; 2. Mr. Sally. Grapes, Mr. Smith. Gooseberries. Fewest to the pound: 1. Mr. Smith; 2. Mr. Riach. Best-flavoured, Mr. Riach. Currants: red, Mr. Gillingwater; white, Mr. Smith. Plums, Mr. Girling, Colchester. Cherries, Mr. Girling. — *Culinary Vegetables.* Onions, Mr. Sally. Cape Lettuce, Mr. Sally. Cucumbers, Mr. Girling.

Mr. Smith, gardener to W. Hawkins, Esq., produced a fine Queen pine, which measured 15 in. in circumference, and weighed 3 lb. 10 oz. It was allowed, by all the growers present, to be the finest ever seen from a plant of its age, only seventeen months having elapsed since the sucker was planted. Mr. Sally produced a stand of seedling georginas, of very superior shape and colour. Mr. Appleby of Boxtead sent two vegetable marrows, which were much admired. Three Cape lettuces, grown by Mr. Burgess of Brightlingsea, attracted the notice of the visitors by their extraordinary size. Many very respectable members were elected. (*Suffolk Chronicle, Aug. 8.*)

### CAMBRIDGESHIRE.

*Cambridge Horticultural Society.* — This Society had a splendid Show of fruits, flowers, &c., on Sept. 17. The Rev. G. A. Browne was called to the chair, and the award was as follows: —

*Flowers.* Georginas. Six best double, one of a sort: 1. (medal) Lord Farnborough, Royal William, Imperiosa, Royal Lilac, Inwood's New White, Donna Maria, Mr. Widnall; 2. Douglas's Seedling, Nutter's Seedling, Donna Maria, Imperiosa, Colville's Perfecta, Brewer's Cambridge Surprise (seedling), Mr. Robert Nutter. Three best, one of a sort: Lady Grantham, Seedling, Præcellentissima, Mr. Widnall. Best: Achilles, Mr. Widnall. Seedling, Mr. Widnall. *Lobelia fulgens*, in a pot, Mr. Searle. *Fuchsia*, in a pot, Mr. Widnall. Plant in a pot (*Nerium splendens*), Mr. Searle. — *Fruit.* Pine: 1. and 2. (medal) Black Jamaica, Mr. Dall. Grapes. Black, cluster not less than 1½ lb.: 1. Black Hamburg, Mr. Gimson; 2. Black Mogul, Mr. Searle. White, cluster not less than 1½ lb.: 1. White Hamburg, Mr. Dall; 2. White Frontignac, Mr. Catling. Out-door. Best bunch: White Muscadine, Mr. Palmer, Ely. Best pot: 1. Black Hamburg, Mr. Dall; 2. Royal Muscadine (white), Mr. Robert Nutter. Peaches. Best six, three of a sort: Rendesham Mignonne, The Master of Sidney. Best three of any sort: Royal George, Mr. Huggins, gardener to the Rev. Mr. Millar of Ely. Best: Noblesse, Mr. Wilson, gardener to Lord De la Warr. Nectarines. Best six, three of a sort: Newington Brignon, The Master of Sidney. Best three of any sort: Old Newington, Mr. Searle. Cherries. Morello: Best lb. containing fewest (45), Mr. Robert Green. Plums. Best plate, two sorts, six of a sort: Green Gage and Coe's Seedling, Mr. Challis. Best plate, not less than six: Caledonian, Mr. Haylock. Figs. Not less than six: Brown and Black, Mr. Dall. Gooseberries, best plate: Red Raspberry, Mr. Wilson, gardener to Lord De la Warr. Currants, best plate: 1. White, Mr. Dall; 2. Red, Mr. Wilson,

gardener to Lord De la Warr. Melon, not less than 2lb.: 1. Silver Rock, Mr. Dall; 2. Scarlet Flesh, Mr. Searle. Mulberries: best plate, Mr. Catling. Apples, table, best dish: 1. Carrée Pippin, Mr. G. Stittle; 2. Kingsland Pippin, Mr. French, gardener to the Rev. Mr. Jenyns. Pears, table, best dish: 1. Bergamot, Mr. French; 2. Mr. Ripsher. Filberts, best lb., Mr. Chalis. Nuts, best lb., Mr. Wilson, gardener to Lord De la Warr. — *Culinary Vegetables*. Celery, six best heads, G. Jenyns, Esq., Wilbraham.

*Treasurer's Prize*. Bouquet, Mr. Gimson. — *Cottagers' Prizes*. Apples: Ribston Pippin, William Smith, Trumpington. Onions, White Spanish, Robert Freeman, Abington. Parsneps, James Bullen, Wimpole. Georginas, William Perry, Hildersham. China-asters, three, James Tuck, Windmill Cottage, Harston. — *Extra-Prizes*. Cottagers' Apples, Hawthorden, Thomas Chapman, Wimpole. Cottagers' Onions, James Tuck, Harston. Cottagers' Georginas, Joseph Beales, Cherryhinton. Cottagers' Bouquet, James Tuck, Harston. Cottagers' Lettuces, Silesian, Harris Marshall, Trumpington. Cottagers' Currants, Red, Harris Marshall, Trumpington. Onions, White Spanish, Mr. Palmer, Ely. Apples: Torbay Pippin, The Master of Sidney; and Alexander, Mr. Biggs. Lettuces, White Cos, Mr. Palmer. Apricots, Moorpark, Mr. Huggins. African Marigolds, Mr. Wilson, Lord De la Warr's gardener. French Marigolds, Mr. Palmer. China-asters, Mr. Huggins and Mr. Brewer.

The annual dinner took place immediately after the show.

After dinner, forty-two prizemen of the year received their prizes, which amounted to two medals, and 108*l.* 9*s.* in money. An honorary medal was also presented to Mr. Charles Baron of Saffron Walden, for his valuable services as a judge. The London Horticultural Society's annual honorary medal was also presented to Mr. Samuel Widnall. (*Huntingdon Gazette*, Sept. 19.)

## SUFFOLK.

*Ipswich Horticultural Society*. — The Third Meeting for the present year was held on Aug. 3., and most respectably attended; the show of fruits and flowers, considering the season, was allowed to be very good. The judges appointed to award the respective prizes were, Dr. Maclean of Colchester; Thos. Allen, Esq., Crane Hall, Ipswich; and Mr. Bray of Barham; who adjudged as follows: —

*Flowers*. Bouquet of Border Flowers: 1. Mr. Jeffery; 2. Mr. Lovely. Plant in bloom in a pot: 1. *Maurandya Barclayana*, Mr. Jeffery; 2. *Coreopsis*, Mr. Lovely. Georginas: Seedlings, Mr. Jeffery. — *Fruit*. Grapes: White, Sweetwater, Mr. Chapman, gardener to Charles Berners, Esq.; Black, Frankenthal, Mr. Bird, Ipswich. Melon: Scarlet Flesh, Mr. Newman, gardener to T. B. Western, Esq.; Green Flesh, Rev. I. S. Matthews, Hitcham. Apricot: 1. R. Pettward, Esq., Finborough Hall; 2. Mr. Allen, gardener to Mileson Edgar, Esq. Plums, Black Morocco, Mr. Milborn. Cherries: Table, Mr. J. Smith, gardener to Dykes Alexander, Esq.; Morello, Mr. Chapman. Gooseberries. Red: 1. Roaring Lion, 23 dwts. 6 grs. Mr. Woollard; 2. Roaring Lion, 19 dwts. 10 grs., Mr. Dunning. Yellow: 1. Gunner, 18 dwts. 2 grs., Mr. Woollard; 2. Viper, 16 dwts. 3 grs., Mr. Lovely. Green: 1. Angler, 17 dwts. 1 gr., Mr. Woollard; 2. Independent, 15 dwts. 2. and 3. Bonny Lass, 14 dwts. 15 grs., Mr. Newman. Best plate, fewest to the pound: 1. (14) Mr. Woollard; 2. (20) Mr. Milborn. Best plate for flavour, Red Champagne, Mr. Barney, Currants. White, best lb.: 1. (19 bunches) New White Dutch, Mr. Woollard; 2. (28 bunches) Mr. Burn. Red, best lb. (34 bunches), Mr. Woollard. Raspberries: 1. Antwerp, Mr. Lovely; 2. Antwerp, Mr. Milbourn. (*Suffolk Chronicle*, Aug. 8.)

The Fourth Meeting of the above Society for the present year was held on Sept. 15. The judges appointed to award the respective prizes were Thomas Allen, Esq., Dr. Beck, and Mr. Burgess, for the fruits and vegetables; and Mr. Hunt and Mr. Baldiston for the flowers. Prizemen were awarded as follows: —

*Flowers*. Double Georginas: 1. Mr. Sally; 2. Mr. Buchanan. Seedling, Mr. Jeffries. Flower in bloom in a pot: 1. Mr. J. Smith; 2. Mr. Felgate. Bouquet of border flowers: 1. Mr. Jeffries; 2. Mr. Lovely. — *Fruit*. Grapes: White, Muscadine, Mr. Jelly, gardener to Miss Lloyd; Black, Hamburg, Mr. Jelly, gardener to Miss Lloyd. Melon: 1. New Scarlet Flesh, Mr. Milborn; 2. Old Scarlet Flesh, Mr. Sally, gardener to H. N. Jarrett, Esq. Peaches: 1. French Mignonne, W. Rodwell, Esq.; 2. Grimwood's Royal George, Mr. J. Smith, gardener to Dykes Alexander, Esq. Nectarines: 1. Early Newington, Mr. Sally; 2. Elruge, Mr. Barney. Apricots: 1. Moorpark, Mr. J. Smith; 2. Moorpark, Mr. Bird. Plums: 1. Goliath, Mr. Sally; 2. Green Gage, Mr. Potter. Pears: 1. Jargonelle, Mr. Milborn; 2. Jargonelle, Mr. J. Smith. Apples: Table, Kerry Pippin, Mr. Sally; Kitchen, Hawthorden, Mr. Jackson. Cherries, Morello, Mr. Jelly. Raspberries, Mr. Milborn. Nuts, Cosford, Mr. Burn, gardener to Lord Rivers. Figs, Mr. Burn. — *Culinary Vegetables*. Cape Broccoli: White, Mr. Barney; Purple, Mr. Lovely. Endive, Mr. Allen. Red Cabbage, Rev. J. S. Matthews.

Amongst the Georginas exhibited by Mr. Sally and Mr. Buchanan were some splendid specimens. A beautiful seedling geranium, reared by Mr. Crawley, was also exhibited, which was named the *Crawleyana*; and we could not help noticing the excellent state of preservation of the dish of cherries produced by Mr. Jelly. (*Ipswich Journal*, Sept. 19.)

*Ipswich Carnation Show*. — At this Show, held on August 6., the judges were, Mr. Sheming, Woodbridge; Mr. Keymer, Colchester; and Mr. Shreeve of Ipswich; who decided as follows: — 1. Ives's Prince Leopold, Smalley's Foxhunter, Ne Plus Ultra, Fletcher's Duchess, Pearson's Madame Mara, and Hufton's La Belle Alliance, Mr. Lee; 2. Strong's Victorious, Foxhunter, Rainbow, La Belle Alliance, Fletcher's Duchess, and Madame Mara, Mr. Jessup; 3. Davey's Duchess, Turner's Duke of Devonshire, Strong's Victorious, Fletcher's Duchess, and two Scarlet Flake Seedlings, Mr. Hunt. Picotee prize, Mr. Goodwin. Crimson Bizard Seedling, Mr. Woollard, afterwards named Woollard's Mr. Peel. Scarlet Flake Seedling, Mr. Woollard, afterwards named Woollard's Miss Anstruther. (*Suffolk Chronicle*, Aug. 8.)

*Wickham-market Flower Show*. — The Annual Show of Carnations and Picotees, held at Wickham Crown, on August 3., was respectably attended, and there were many fine flowers shown. The prizes were adjudged by Mr. E. Cadman, Mr. J. Cadman, and Mr. Williams, as follows: —

Pan of four blooms: 1. Foxhunter, Lacy's Water, La Belle Alliance, and Madame Mara, Mr. William Barker, Hemingstone; 2. Foxhunter, Rainbow, Fletcher's Duchess, and Madame Mara, Mr. William Barker, Wickham; 3. Strong's Vittoria, Ives's Prince Leopold, Hannibal, and Fletcher's Duchess, Mr. Jessup, Helmingham. Picotees, Will Stukely, and Barker's Sportsman, Mr. Tyler, Wickham. Seedling Carnation, Mr. Barker, Wickham, afterwards named Barker's Mrs. Amys. Seedling Picotee, Mr. Jessup, Helmingham, afterwards named Jessup's Bang-up. (*Suffolk Chronicle*, Aug. 8.)

## BERKSHIRE.

*The Wallingford Ranunculus Show* was held on June 10, when the prizes were awarded as follows:—

First Class, Dark and Dark Purple: 1. Metius, Mr. W. S. Clarke; 2. and 3. Naxàra, Mr. Costar; 4. Viriat, Mr. E. Wells. Second Class, Striped: 1. Mèlange, Mr. W. S. Clarke; 2. Oeillet Parfait, Mr. Birkett; 3. Tamaire, Mr. W. S. Clarke; 4. Favourite Mignonne, Mr. Woodbridge. Third Class, Crimson Red and Rose: 1. Henrietta, Mr. Costar; 2. Gunn's Crimson, Mr. W. S. Clarke; 3. Papius, Mr. Atkinson; 4. Rose Velona, Mr. Birkett. Fourth Class, Edged: 1. Grand Berger, Mr. Costar; 2. Grand Berger, and 3. Doctor Franklin, Mr. Clarke; 4. Horatio, Mr. E. Wells. Fifth Class, Spotted: 1. Arbrisscau, Mr. Costar; 2. Arbrisscau, Mr. W. S. Clarke; 3. Fabius, Mr. W. S. Clarke; 4. Agamemnon, Mr. Birkett. Sixth Class, Yellow and Straw: 1. Adrian, Mr. W. S. Clarke; 2. Golconda, Mr. Woodbridge; 3. Beroth, Mr. E. Wells. Seventh Class, Mottled: 1. Thompson's Queen, Mr. W. S. Clarke; 2. Benjamin, and 3. Isodorus, Mr. Woodbridge. Stand of nine blooms: 1. Mr. W. S. Clarke; 2. Rev. Jos. Tyso; 3. Mr. Costar; 4. Mr. E. Wells; 5. Mr. Woodbridge; 6. Mr. Birkett; 7. Mr. Atkinson. Steward's prizes, Grand Berger, Mr. Costar.—*J. T.*

## GLOUCESTERSHIRE.

*Gloucester Horticultural Society.*—The Fourth Public Show for the season took place on July 31, and was eminently attractive. The display both of flowers and fruits was brilliant in the extreme, and far exceeded any former exhibition. The assemblage of carnations and piceotes was particularly admired, and the richness and variety of the georginas left nothing to be wished for in that splendid tribe. Other choice flowers were also contributed in great numbers. The abundance of luxurious fruits of all descriptions was such as to gratify the eye, and provoke the taste of the most fastidious. The evening's sale of fruits was very productive. The number of specimens entered in the Society's books amounted to upwards of 1220. (*The Bristol Mirror*, Aug. 8.)

*Gloucester and Cotswold Horticultural Association.*—The Second and last Exhibition of this Institution for the present year was held in September. The display of fruits, particularly, far surpassed our expectation, and affords us every reason to hope that this Institution, which is quite in its infancy, will next year become one of the principal attractions of this neighbourhood. (*Bath Journal*.)

## WORCESTERSHIRE.

*The Worcestershire Horticultural Society* held their last Meeting for the present year in Worcester, on August 28. Among the fruits we particularly noticed a pine from the garden of the Marchioness of Downshire, which weighed 10 lbs. 11 oz.; also a bunch of grapes from the garden of J. Taylor, Esq. The peaches, nectarines, and apricots were likewise particularly fine. There were also exhibited two new specimens of the new silver beet, and a new esculent vegetable lately imported from Hungary, called Kohl-rabi. We are sorry to say that indisposition prevented the attendance of Sir C. S. Smith, Bart. The prizes were awarded as follows:—

*Plants.* Green-house: *Calceolaria corymbosa*; 2. *Elichrysium proliferum*, and 3. *Lechenaúlia formosa*, Mr. Tapp; 4. *Pelargonium ardens*, Rev. T. Waters. Cockscomb, Sir H. Wakeman, Bart.—*Flowers.* Georginas, Crimson: 1. Seedling, Mr. Beach; 2. Denin's Seedling, 3. Sanguinea, and 4. Wells's Victory, Mr. Tapp. Purple: 1. Wood's Favourite, Mr. Tapp; 2. Seedling, R. Nuttall, Esq.; 3. Langley's Favourite, and 4. Triumphant, Mr. Tapp. Scarlet: 1. Superb, 2. Coccinea, 3. Unknown, and 4. Unknown, Mr. Tapp. Sulphur: 1. Yellow Sulphurea, and 2. Dwarf Yellow, Mr. Tapp; 3. Unknown, J. Taylor, Esq.; 4. Sulphurea superba, Mr. Beach. Light: 1. Unknown, Mr. Tapp; 2. Quilled Lilac, Mr. Beach; 3. Seedling, J. Taylor, Esq.; 4. Unknown, Mr. Tapp.—*Fruit.* Pine, Mr. Wood. Melon, R. Griffiths, Esq. Peaches, J. Taylor, Esq. Nectarines, Mr. Wood. Apricots, Mr. Berkeley. Grapes: Black Hamburgh, Mr. Beach; White Muscat, J. Taylor, Esq. Cherries, Mr. Wood. Plums, Mr. Hunt. Figs, Mr. Wood. Apples: Dessert, R. Allies, Esq.; Culinary, Mr. Wood. Pears: Dessert, Mrs. Berkeley; Seedling, E. Isaac, Esq.—*Culinary Vegetables.* Carrots, Rev. G. St. John. Onions, Mr. Wood. Celery: White, Sir H. Wakeman, Bart.; Red, Sir H. Wakeman, Bart. New Silver Beet, Mr. Wood. (*Worcester Journal*, Sept. 3.)

*Vale of Evesham Horticultural Society.*—The last Show for the season was held on the 24th of September, at which the display of fruits was so abundant, that additional tables were required, one of which was entirely appropriated to seedlings. Mr. Boulby of Springfield House, Warwickshire, sent three different sorts of apples from Ireland, and a seedling of his own, with a report of their qualities, which was read to the Society, and accompanied with the obliging offer of furnishing such of the members of the Society as wished it with grafts at the proper season. Besides the productions which obtained prizes, we noticed among the numerous articles that were exhibited:—A green pumpkin (*Cucurbita Pepo Linn.*, *Cucurbita indica rotunda Dalechamp*) of 70 lbs. weight, from Mr. Fulton; six uncommonly large roots of red celery from Mr. Brown; specimens of water cresses (*Nasturtium officinale Hort. Kew.*), raised in strong soil, without water being applied to them, by Mr. Mayfield. The President, E. Rudge, Esq., exhibited, amongst various other productions, the musk-plant (*Mimulus moschatus*), raised from seeds sent last year from the Colombia river, in North America. The very strong animal smell of musk which this curious plant so powerfully and remarkably possesses forms one of those numerous links in nature, which connect the animal with the vegetable kingdom. Also from the same, six specimens, of uncommon size, of the Duke of Wellington's apple, which, from its beautiful scarlet colour, and as a culinary in point of flavour, is unrivalled. The prizes were awarded as follows:—

*Plants.* Stove or Green-house: 1. *Begonia capensis*, Mr. Smith; 2. *Calceolaria integrifolia*, N. Hartland, Esq.; 3. *Poliánthes tuberosa*, E. Rudge, Esq. Hardy or Tender Annuals: 1. Mr. Ball; 2. Mr. Smith; 3. John Taylor, Esq. Perennials: 1. Mr. Smith; 2. Mr. Fleetwood. Cockscombs: 1. Mr. Fulton; 2. Sir Charles Throckmorton, Bart.—*Flowers.* Georginas. Scarlet: 1. and 2. John Taylor, Esq. Crimson: 1. Mr. Gregory; 2. Mr. Smith. Purple: 1. Sir Charles Throckmorton, Bart.; 2. Mr. Goodall. Sulphur: 1. Mr. Hunt; 2. Mr. Fulton. Light: 1. John Taylor, Esq.; 2. Mr. Smith. White: 1. and 2. John Taylor, Esq.—*Fruit.* Cherries: Morello, Mr. Gregory. Damsons: 1. Seedling, Mr. Tovey; 2. Mr. Edwin. Apples: 1. Seedling, Rev. Mr. Bonaker; 2. Seedling, Mr. Hignell; 3. Blenheim Orange, Mr. Cheek. Pears: Dessert, Maria Louisa, Mr. Ball; 2. Seedling, and 3. Grey Bury (culinary), Mr. Hunt. Out-door Grapes:

1. Black, Mr. Barnes; 2. White, Mr. Charles. — *Culinary Vegetables.* Peas, John Taylor, Esq. Onions: 1. Sir Charles Throckmorton, Bart.; 2. John Taylor, Esq.; 3. Mrs. Charles. Beet Root, Rev. Mr. Parker. Celery: 1. Red, six stalks, weight 26 lbs., Mr. Brown; 2. White, Mr. Hunt. *Extra-Prizes.* Two kinds of Seedling Apples, Pitaston Orange Nectarine, and Seedling Apricot of the Moorpark Standard, Mr. Hunt. White Grapes, Muscat, Mr. Fulton. Black Prince Grapes, John Taylor, Esq. (*Worcester Herald*, October 10.)

## HEREFORDSHIRE.

*Hereford Horticultural Society.* — The last Meeting of this Society for the present season took place on Sept. 29., and on no former occasion have we witnessed so brilliant a display of apples. A seedling apple, raised by Mr. Cranston, and several others, were deservedly admired. A bundle of celery from the garden of R. J. Powell, Esq., attracted general admiration, both as to the size and perfection of the roots. In addition to the usual prizes given at this and similar institutions, the Hereford Society awards the following premiums, and the Committee have it in contemplation to extend its operations next year in a way that cannot fail to give satisfaction: — A prize of five sovereigns will be given to the subscribing gardener of any member of the Society who shall bring written testimonials from his master or mistress, at the last meeting in the year 1830, of his having lived in his service at least five years, and of his having, during that period, been distinguished for honesty, sobriety, industry, general good conduct, and attention to, and knowledge of, his business; should two or more gardeners be considered equally meritorious, the preference will be given to him who has lived longest in his place. This prize will be offered every five years, but the same individual is not to be entitled to it more than once. A sovereign will be given to the subscribing gardener of that member of the Society to whom the greatest number of prizes shall be awarded in the course of each year. Half a sovereign will be given to the subscribing gardener who shall rear the earliest cucumber in each season, the day on which it was cut, and its weight, to be attested in writing, by the subscribing master or mistress, at the first meeting in 1830, and every succeeding year. Should two or more cucumbers be cut in the same week the greatest weight will take the prize. Five shillings will be given, under the same regulations, for the earliest (after the 1st of January) and heaviest dish of sea-kale, to consist of four heads. Premiums were awarded as follows: —

*Plants.* Green-house: Erica, G. C. Cooke, Esq. Stove: *Panocratum mexicanum*, G. C. Cooke, Esq. — *Flowers.* Georginas. Scarlet: 1. Diadem, Mr. Cranston; 2. Scarlet Turban, Mr. Nott; 3. Princess Victorine, Sir J. G. Cotterell. Purple: 1. Lord Farnborough, Mr. Nott; 2. Isabella, Mrs. W. Pateshall; 3. Purple Velvet, Mr. Godsall. Crimson: 1. Ariconium, Sir J. G. Cotterell; 2. Beauté Suprême, Mrs. W. Pateshall; 3. G. fulgida, Mr. Godsall. Light: 1. Quilled Lilac, Sir J. G. Cotterell; 2. Acteon Mr. Nott; 3. Mont Blanc, Mrs. W. Pateshall. China-asters. Purple-striped: 1. Mrs. H. Morgan; 2. Mr. Cranston; 3. Mrs. Gordon. Red-striped: 1. Mrs. Gordon; 2. Mrs. H. Morgan. Self, Mr. Cranston. — *Fruit.* Melon: Paris Melon, Sir J. G. Cotterell. Apples. Early Dessert: 1. Ribston Pippin, R. J. Powell, Esq.; 2. Summer Queening, Mrs. J. Phillipp; 3. Longueville, Mr. Cranston. Late Dessert: 1. Nonpareil, and 2. Brandy, Mr. Cranston; 3. Grange, and 4. Pome du Roi, Mrs. J. Phillipp. Culinary: 1. Hawthornden, Sir J. G. Cotterell; 2. Blenheim Orange, Mrs. Downes; 3. French Codlin, J. S. Gowland, Esq. 4. Russian Emperor, Mr. Cranston. Cider: 1. Foxwhelp, 2. Woodcock, and 3. Dymock Red, Sir J. G. Cotterell. Pears. Early Dessert: 1. Bon Chrétien, T. H. Symons, Esq.; 2. Gansell's Bergamot, C. G. Cooke, Esq.; 3. Brown Beurrée, Sir J. G. Cotterell. Late Dessert: 1. Crassane, Mrs. Downes; 2. Swan's Egg, Mrs. J. Phillipp. Perry: Seedling, Mr. Cranston. Grapes: 1. Muscadine, Mrs. Gordon; 2. T. C. Bridges, Esq. Peaches: 1. Royal George, R. J. Powell; 2. Bellegarde, Sir J. G. Cotterell. Nectarines: 1. Sir J. G. Cotterell; 2. Elrue, R. J. Powell, Esq. Strawberries: Alpine, Mrs. Downes. — *Culinary Vegetables.* Celery: R. J. Powell, Esq. (*Hereford Journal*, October 7.)

*Ross Horticultural Society.* — The Twenty-fifth Public Exhibition of this Society took place on Sept. 30. Previously to the opening of the show-room, the General Annual Meeting was held, the Rev. Canon Underwood in the chair; when the committee, treasurer, and secretary were re-elected for the ensuing year. On which occasion a vote of thanks was passed to William Hooper, Esq. the honorary secretary, for his exertions in the cause of this Society, and the Committee stated they had great satisfaction in reporting the public estimation of the liberal and unremitting exertions of Mr. Hooper to the concerns and interests of the Society, testified by the present of a gold snuff-box, raised by the contributions of 210 subscribers, at 5s. each, and in directing that a minute of the circumstance be entered on the books of the Society, as a memorial of his kind and efficient services, and their sense of them. The number of specimens ticketed and entered into the Society's books amounted to 1047. The prizes were awarded as under: —

*Flowers.* Georginas. Scarlet and Orange: 1. Scarlet Turban, H. Rosser, Esq.; 2. Morning Star, and 3. Duke of Hamilton, Mrs. Westfaling; 4. Apollo, Mr. J. C. Wheeler; 5. Cocinea superbe, Mr. Reynolds. Red and Crimson: 1. and 2. Seedlings, Mrs. Westfaling; 3. Young's Triumphant, Mr. J. C. Wheeler; 4. Seedling, Mrs. Westfaling; 5. Princess Elizabeth, W. Hooper, Esq. Purple and Lilac: 1. G. indiana, and 2. Royal Lilac, Mr. J. C. Wheeler; 3. Superbissima, K. Evans, Esq.; 4. Bold Forester, H. Rosser, Esq.; 5. Seedling, Mrs. Westfaling. White and Sulphur: 1. Mountain of Snow, Mr. J. C. Wheeler; 2. Clifton Yellow, Mrs. J. Rudge; 3. Mont Blanc, Mrs. Westfaling; 4. Wells's Dwarf Yellow, H. Rosser, Esq.; 5. Double White, Mr. C. Frere. Buff and Yellow: 1. Grisdelin Superb, and 2. Bronze, Mrs. Westfaling; 3. Belvidere, Mr. J. C. Wheeler; 4. Camelliaeflora, Mr. Reynolds; 5. Prince of Orange, W. Hooper, Esq. Rose and Carmine: 1. Duchess of Wellington, H. Rosser, Esq.; 2. G. conspicua, Mr. J. C. Wheeler; 3. Seedling, and 4. Princess Victoria, Mrs. Westfaling; 5. Purpurea grandiflora, Mr. J. C. Wheeler. Morone and Puce: 1. Black Turban, and 2. Venustum, Mr. J. C. Wheeler; 3. Coronation, Mrs. Westfaling; 4. Diadem, H. Rosser, Esq.; 5. Douglas's Achilles, Mrs. Westfaling. — *Fruit.* Apples. Early Dessert: 1. Ribston Pippin, Mrs. Platt; 2. Queen's Pippin, T. Rudge, Esq.; 3. Margil, Mr. Reynolds; 4. Gun's Mills Russet, H. Rosser, Esq.; 5. Golden Pippin, J. S. Collins, Esq. Late Dessert: 1. Wheeler's Extreme, Mr. J. C. Wheeler; 2. Brandy, J. F. Willis, Esq.; 3. Golden Rennet, Mrs. Platt; 4. Court de Wick, C. Biss, Esq.; 5. Pearmain, Mrs. Platt. Culinary: 1. Blenheim Orange, Rev. L. Robertson; 2. Campbell's Kernel, J. F. Willis, Esq.; 3. Orange Prunella, C. Biss, Esq.; 4. Hawthornden, Mr. Crump; 5. Goose, W. Hooper, Esq. Cider: 1. Hagloe Crab, and 2. Foxwhelp, Mrs. Platt; 3. Knight's Downton Pippin, Mr. Crump; 4. Yellow Stire, Mrs. Platt; 5. Ansel, Mr. Crump. Pears. Dessert: 1. Bergamot, Mr. Paines; 2. Bon Chrétien, T. H. Symons, Esq.; 3. Brown Beurrée, Mr. C. Frere; 4. Gansell's Bergamot, Mr. Reynolds; 5. Swan's Egg, J. F. Willis, Esq. Perry: 1. Sack, Mrs. Platt; 2. Red Longdon, and

3. Blakeney Red, Mr. Crump; 4. Barland, and 5. Moorcroft, Mr. Reynolds. Out-door Grapes: 1. Sweetwater, T. Rudge, Esq.; 2. Muscadine, and 3. Royal Muscadine, C. Biss, Esq.; 4. Muscatel, E. Jones, Esq.; 5. Black Cluster, Miss Harvey. — *Culinary Vegetables*. Celery: 1. and 2. John Cooke, Esq.; 3. K. Evans, Esq.; 4. John Cooke, Esq.; 5. K. Evans, Esq. Autumn Broccoli: 1. K. Evans, Esq.; 2. and 3. Mr. Crump; 4. and 5. K. Evans, Esq. (*Hereford Journal*, October 7.)

#### LEICESTERSHIRE.

The *Bury Horticultural Society* held their Fourth Meeting on Sept. 8. The show was admirable; the first objects of attraction were the Georginas, the profusion and variety of which beautiful description of flowers presented a most superb appearance. Amongst the finest were the Donna Maria, Achilles, Douglas's 12, Dennis's Invincible, Fúlgida supérba, and the admired Anemone-flowered variety raised at Cork. The seedlings were very good. There were also some incomparable China-asters. Of the fruit, the Persian Melon was most worthy remark, and there were two new South American species. The Seedling Grape (white), raised from a raisin, is a very excellent one. The Peaches, Apricots, Caledonian Plums, and Morello Cherries were very fine, and the show of Apples was grand, especially the Mars Hill by the Rev. H. Hasted, Hawthorndean by the Rev. C. Dewhurst, and seedlings of great merit by Mr. Hodson and several cottagers. The display of honey obtained without destroying the bees was very gratifying, including a box of 25 lbs. by a cottager, obtained from a swarm of this year, a glass of the purest nectar shown by Mr. Payne, and many other boxes and glasses. The Red Celery was of extraordinary size. The following was the award of the judges, Mr. Chandler of Vauxhall, and Mr. Dennis of Chelsea, for flowers; Messrs. Lines and Sharp, for fruit and vegetables: —

*Flowers*. Georginas: Six, 1. and 2. Mr. Buchanan; Seedling, Mr. Barrett. Plant in a pot, Mr. Wright. Plant in a pot (extra-prize), *Gloxinia hirsuta*, R. Bevan, Esq. Bouquet: Tender, Mr. Hammond; Hardy, Mr. Lord. Glass of Honey, Mr. Payne; Box of Honey, Rev. C. Dewhurst. — *Fruit*. Peaches: 1. Mr. Barrett; 2. Mr. Musk. Nectarines: 1. Mr. Musk; 2. Rev. G. J. Haggitt. Melon: 1. Persian, Mr. Hammond; 2. Winter, Mr. C. Johnson. Pine: 1. Mr. C. Johnson; 2. Mr. Wright, Ampton. Grapes: 1. White Out-door, Mr. C. Adams, Barton; 2. Black forced, Mr. C. Johnson; 3. Seedling, from a raisin, Mr. R. Taylor, Bury. Figs, Brown Ischia, Sir J. Affleck. Pears, Mr. Corsbie, West Stow. Plums, Green Gages, Mr. Barrett. Cherries, Morello, Mr. Sparrow, Shropham. Apples: 1. Dessert, Kerry Pippin, Rev. B. T. Norgate; 2. Kitchen, Hawthorndean, Rev. Mr. Dewhurst; 3. Seedling, Mr. Barrett. Filberts, Mr. Hammond. — *Culinary Vegetables*. Celery: 1. Red, Mr. J. H. Payne; 2. White, Mr. Hammond. Onions: 1. Mr. Barrett; 2. Red, Mr. C. Middleditch. Peas, Charles Bloomfield, Esq. Tomatoes, Rev. B. T. Norgate.

*Cottagers' Prizes*. Potatoes, Last, Rougham. Cabbages, Steed. Onions, Jermyn, Timworth. Green Gages, Fenner, Fornham. Apples, Tooley, Whelnetnam; Seedling, Smith, Bury. Box of Honey, Reach, Bury. (*Bury and Norwich Post*, September 9.)

#### YORKSHIRE.

*Yorkshire Horticultural Society*. — The First September Meeting of this Society took place on September 2, at Wakefield. The chair was taken at two o'clock, by the Rev. S. Sharp, vicar of Wakefield, when the prizes were adjudged as follows: —

*Flowers*. Georginas. Purple: 1. Thomas Carnall, gardener to P. Walton, Esq., of Walton; 2. and 3. Mr. William Barratt. Scarlet: 1. and 2. Mr. William Thorp of Halifax, nurseryman; 3. Thomas Carnall. Light: 1. Thomas Carnall; 2. Mr. William Barratt; 3. Robert Hinsley of Hensall, near Snaith. Crimson: 1. Mr. William Carrat; 2. Thomas Carnall; 3. Robert Hinsley. Single Georginas: 1. Mrs. Dealtry of Lofthouse Hall; 2. Robert Hinsley. Light: 1. Joseph Marshall of Carr Lane, near Leeds; 2. William Clark of Rudley. Bouquet. Exotic, Thomas Appleby. Hardy, William Clark. Carnations. Scarlet Bizard: 1. John Gill of East Moor; 2. William Hardman of Wakefield. Pink Bizard: 1. and 2. John Hives. Scarlet Flake: 1. and 2. John Smith, gardener to the Rev. Lamplugh Hird of Low Moor. Pink Flake: 1. and 2. John Smith. Purple Flake: 1. William Hardman; 2. William Newsome of Dewsbury Bank. Picotees. Red-laced: 1. John Smith; 2. John Gill. Purple-laced: 1. and 2. John Smith. Rarest Exotic in Pot (a *Pitcairnia chilensis*), William Baines, gardener to Jeremiah Rawson, Esq. — *Fruit*. Pine: 1. William Ashton, gardener to Benjamin Gaskell, Esq. of Thornes House, near Wakefield; 2. John Plant, gardener to John Hardy, Esq. of Heath Hall. Largest, John Cork of Grange Ash. Grapes, White: 1. James Brown, gardener to John Hebblethwaite, Esq. of Woodhouse Lane, Leeds; 2. William Ashton; 3. John Ives, gardener to Mrs. Rawson of Stony Royd, near Halifax. Black: 1. Joseph Moore, gardener to T. B. Pease, Esq. of Chapel Allerton, near Leeds; 2. Thomas Appleby, gardener to the Rev. J. A. Rhodes of Horsforth Hall; 3. William Ashton. Melon: 1. John Southward, gardener to Edward Armitage, Esq. of Cookridge Hall; 2. James Brown. Peaches: 1. William Ashton; 2. Job Boothroyd, gardener to Kennet Dawson, Esq., of Frickley Hall, near Doncaster. Nectarines: 1. William Ashton; 2. Job Boothroyd. Apricots: 1. William Ashton; 2. William Partridge, gardener to the Rev. Henry Torre, of Thornhill. Cherries: William Caladine, gardener to J. F. Carr, Esq. of Carr Lodge, Horbury. Figs, James Cooper, gardener to John Lee, Esq., St. John's, Wakefield. Plums: 1. John Plant; 2. and 3. William Ashton; 4. George Yanwith, gardener to Sir Edward Dodsworth, Bart., of Newland Hall. Currants, Mr. J. Hatfield of Wakefield. Pears: 1. William Ashton; 2. Job Boothroyd. Greatest variety of sorts (140 in number), Mr. William Barratt of Wakefield, nurseryman. Apples. Eating: 1. Job Boothroyd; 2. John Markwell, gardener to A. Peterson, Esq., of Wakefield; 3. William Ashton. Greatest quantity of sorts (93 in number), Mr. W. Barratt. Baking: 1. Mr. Robinson of Wakefield; 2. John Markwell; 3. James Cooper; 4. William Ashton. A dish of Apples, grafted in March last, upon branches sent from the Horticultural Society in London, Mr. William Barratt. Best Seedling Apples, William Clark of Rodley. A dish of Siberian Golden Crabs, Mr. Joshua Scott of Wakefield. — *Culinary Vegetables*. Peas, Samuel Currie, gardener to Joshua Ingham, Esq., of Blake Hall, Mirfield. Potatoes, William Newsome. Cauliflowers, Thomas Green of Newton, market-gardener. Red Cabbage, Mr. William Barratt. Celery, Samuel Currie. Endive, Thomas Carnall. Winter Onions, William Hardman. Spring Onions, Thomas Carnall. Broccoli, Samuel Currie. Vegetable Marrow: 1. George Yanwith; 2. Samuel Currie.

A prize was awarded to Thomas Appleby, for a fine specimen of the Granadilla, the fruit of the Passiflora, or Passion Flower. Joseph Marshall of Carr Lane produced the branch of an apple tree, bearing both fruit and flowers. William Ashton produced a dish of May Duke

Cherries, which had been exhibited in the months of May, June, July, August, and September. (*Yorkshire Gazette*, September 5.)

The Second September Meeting of the above Society was held on September 23. There were two collections of Georginas, from S. W. Nicoll, Esq., of Fulford, most tastefully arranged; one from Messrs. Backhouse, containing 85 varieties of the double Georginas; and one of seedlings, containing 35 varieties, from Mr. Parker, which were much admired. A twin Georgina, furnished by Mr. Parker, was also considered a great curiosity. It was a crimson one, with a yellow one growing from the middle. The following stove plants were furnished by John Smith, Esq. Hungate:—*Hedýchium máximum*, *H. coronarium*, *Thunbérghia alata*, *Cucúligo sumatrána*, *Caladidum oddrum*, *Ficus elástica*, *Cactus stellata*, *Kämpferia rotúnda*, and *Cyperus alternifolius*, with the *Corræa speciosa*, and *Acrostichum alciórne*, green-house plants; and a fine Chasselas Vine in pot, bearing 20 bunches of grapes. We noticed in the room a sample of woollen net, for the protection of fruit trees, very superior to any before exhibited. It was manufactured in the workhouse at Darlington, and was shown by Messrs. Backhouse. The doors were opened about half-past one o'clock; about two o'clock Francis Cholmeley, Esq., of Bransby, was called to the chair. The prizes were then distributed as follows:—

*Plants.* Green-house: *Tecoma capensis* in flower, to Henry Baines, gardener to Messrs. Backhouse. Stove: 1. *Hedýchium máximum*, and, 2. *Cucúligo sumatrána*, James Hodson, gardener to John Smith, Esq., Hungate. These were most beautiful plants, and looked remarkably healthy.—*Flowers.* Georginas, Double: 1. 2. and 3. Robert Hinsley of Ebsall, near Snaith. Single: 1. C. Hague of Dale Street, York; 2. A. Parker of York; 3. Robert Hinsley. Semi-double: 1. Superb French White, a most beautiful flower, Thomas Deuxberry; 2. Veitch's Triumphant, John Raby; 3. Robert Hinsley. Bouquets. Exotic: 1. Thomas Appleby; 2. H. Baines. Hardy: 1. Thomas Holdsworth, gardener to Messrs. Riggs; 2. T. Sharples, gardener to T. Price, Esq.—*Fruit.* Apples. 1. and 2. Downton Pippin, William Amos, gardener to James Walker, Esq. of Sandhutton; 3. Knight's Golden Pippin, M. Clark; 4. Ribston Pippin, William Morris; 5. Seedling from a Ribston Pippin, John Smith, gardener, York; 6. Dish of the Cornish Pippin, Andrew Young, gardener to Constable Maxwell, Esq., of Everingham; 7. Filbbasket, Thomas Smithies, gardener to Sir W. Miner of Nun Appleton; 8. Hinsley's Seedlings, R. Hinsley; 9. Knight's Spring Grove Codling, Mr. Clark; 10. Hawthornden, Thomas Mason. Plums: 1. Green Gages, Thomas Mason; 2. Magnum Bonums, James Burnett, gardener to Colonel Baines of Bell Hall. Currants: White Dutch, James Burnett. Pears: 1. York Burgundy, grown against a wall, Thomas Deuxberry; 2. York Burgundy, John Butters, gardener to the Hon. Alexander Macdonald; 3. Scotch Burgundy, William Morris. The Chairman called the attention of the company to two species of pears which were exhibited, the White Doyenne, by Messrs. Backhouse, and the Williams's Bon Chrétien; both remarkably fine fruit, and the trees good bearers on standards. Nectarines: 1. Elruge, Thomas Deuxberry; 2. Brugnon, Thomas Mason. Peaches: 1. White Noblesse, and 2. Red Magdalen, Thomas Mason. Pine, Montserrat, Thomas Foster. Largest Pine, uncut, John Kirk, gardener to Sir John L. Kaye, Denby Grange, near Wakefield. It was a superb specimen of the White Providence kind, weighing 6lb. 3qrs. For the Pines raised in pots without heat, Joseph Benson, gardener to Colonel Croft of Stillington. Melon, Windsor Prize, Thomas Deuxberry. The Chairman called the attention of the company to the two pines in pots, which had been raised without fire. Grapes, Black: 1. and 2. Black Hamburg, J. Moor, gardener to V. B. Pease, Esq., of Chapel Allerton. White: 1. Tokay Grape, Thomas Mason; 2. Muscat of Alexandria, Thomas Appleby.—*Culinary Vegetables.* Cucumbers: 1. Thomas Walker, gardener to the Rev. D. R. Currier; 2. Thomas Foster, gardener to the Hon. and Rev. W. H. Dawnay of Benningborough. Cauliflower (Malta), Thomas Abbot of Knaresborough. There was no competition, therefore the prize was not adjudged, but a present was made to Mr. Abbot. Broccoli, Mark Clarke, gardener to Messrs. Backhouse of York. Peas, the Cimiter, Thomas Appleby, gardener to the Rev. J. A. Rhodes of Horsforth Hall. Cabbage, White, to James Rutledge of Elvington. This was a most superb specimen of the drum-head species. Savoys, Mark Clarke. Red Cabbage, Richard Hodgson of Bisphorpe. John Lamb of Great Ouseburn also produced a red cabbage, which was so nearly equal to the former, that a prize was awarded it. Celery, Red, Thomas Deuxberry, gardener to H. Preston, Esq., of Moreby; White, Thomas Abbot of Knaresborough. Onions, Thomas Mason, gardener to R. J. Thompson, Esq., of Kirby Hall. Carrots, Parsneps, and Beet-root, Thomas Deuxberry.

The Prizes having been distributed, the Chairman begged to call the attention of the company to some beautiful heaths, sent by Miss Nelson of Bootham; and also to a very fine standard vine, in pot, with twenty bunches of grapes upon it, sent by John Smith, Esq., of Hungate. Thanks were then voted to the Rev. W. H. Dixon of Bisphorpe, J. Smith, Esq., Thomas Price, Esq., Miss Nelson, and Messrs. Backhouse, for their presents of flowers, for decorating the room.

Judges of Fruit: Dr. Belcombe, William Oldfield, Esq., John Hutton, Esq., and John Barkley, gardener to William Thompson, Esq., Kirk Hammerton.—Judges of Flowers: The Rev. W. Hincks, Mr. F. Eulmer, jun. and Mr. H. Mills.—Judges of Culinary Vegetables: The Rev. Dr. R. Currier, Thomas Price, Esq., and Martin Abershaw, gardener to B. Horner, Esq., Fulford Grange. (*Yorkshire Gazette*, September 26.)

*Ripon Horticultural Society.*—The Fourth and final Meeting for the season was held at the Town Hall, in Ripon, on September 11. Col. Dalton of Steningford Hall again honoured the Meeting with his services in the chair, and announced the adjudication of the prizes as follows:—

*Flowers.* Georginas. Double. Purple: 1. Langby's Purple, Mr. May; 2. Mr. Abbott. Scarlet and Crimson: 1. Alexandrina Victoria, Mr. May; 2. Princess Victoria, Mr. Weatherald, Mickle. Yellow and Buff: 1. Mr. Weatherald; 2. Mr. J. Binns. Lilac and White: 1. Amiable Rosette, Mr. James Metcalf, gardener to Henry Wormald, Esq., Sawley Hall; 2. Mr. Abbott. Single. Purple: 1. and 2. Mr. T. Grayson, Bondgate, near Ripon. Scarlet and Crimson: 1. Black-eyed Susan, Mr. James Metcalf; 2. Victory, Mr. W. Banning, gardener, Pickhill. Lilac and White: 1. Mr. T. Harrison; 2. Mr. Wm. Banning. Bouquet, Hardy, Mr. May; Exotic, Mr. May.—*Fruits.* Pines: 1. Montserrat, Mr. Cuthbertson, gardener to Mrs. Lawrence of Studley Park; 2. Mr. Thomas Mason, gardener to R. J. Thompson, Esq., Kirby Hall. Grapes, Black: 1. Black Hamburg, Mr. Cuthbertson; 2. Black Hamburg, Mr. P. Dauriss, gardener to Mark Milbanke, Esq.; 3. Black Hamburg, Mr. A. Kirkpatrick, gardener to Col. Serjeantson of Camp Hill, near Bedale. White: 1. Muscat, Mr. Cuthbertson; 2. Muscat, Mr. Kirkpatrick; 3. Mr. Cuthbertson. Figs, Red, Mr. P. Dauriss. Nuts: 1 and 2. Mr. Adam Sybald, gardener to George Knoles, Esq., of Lucan House. Peaches: 1. and 2. Mr. T. Mason; 3. Mr. C. Whytall. Nectarines: 1. Brugnon, and 2. Elruge, Mr. T. Mason; 3. Mr. C. Whytall. Apricots: 1. John Hill, Esq.; 2. Moorpark, Mr. T. Mason; 3. Moorpark, Mr. P. Dauriss. Plums: 1. Mr. T. Mason; 2. Mr. A. Sybald;

3. Mr. Cuthbertson. Pears : 1. Jargonelle, Mr. T. Harrison, Ripon ; 2. Jargonelle, Mr. P. Douriss ; 3. Summer Portugal, Mr. May. Apples. Eating : 1. Ribston Pippin, Mr. Elias Hilyard, gardener to Sir Thomas Frankland, Bart., of Thirkleby ; 2. Downton Pippin, Mr. C. Whytall. Baking : 1. Keswick Codlin, and 2. King's Apple, Mr. Abbott, Knaresborough. Melons : 1. Mr. Robert Campbell, gardener to the Hon. T. O. Powlett ; 2. Mr. Abbott. — *Culinary Vegetables.* Tomatoes. Yellow : 1. Mr. C. Whytall, gardener to Thomas Mason, Esq. of Copt Hewick ; 2. Mr. A. Kirkpatrick. Red, Mr. T. Mason. Celery : 1. Mr. Abbott ; 2. Mr. Kirkpatrick. Onions : 1. Tripoli, Mr. T. Mason ; 2. Mr. Abbott. Broccoli, Mr. Abbott.

Judges : for Flowers, Mr. Hill, Mr. Knowles, and Mr. Campbell ; for Fruits and Vegetables, Mr. Morton, Mr. Peter Neesh, and Mr. Sam. Winn.

Prizes were also awarded to Mr. May, Mr. Cuthbertson, and Mr. Thos. Grayson, for their respective contributions, for decorating the room during the season ; to Mr. Smith of Green Royd, for a fine bouquet of sweet-scented China roses ; to T. Dickens, Esq., for two very rare and splendid exotics, the *Crassula falcata* and *Chirònia lychnoïdes*, both which were much admired by the amateurs, being so seldom seen in bloom, and rarely, even then, in such perfection as was these ; to Mr. Cuthbertson, for a superior collection of cockscombs, namely, *Celsia cristata coccinea*, *Celsia cristata lutea*, *Celsia cristata pyramidalis*, much admired for their size and brilliancy of colour ; to Mr. May, for *Gloxinia speciosa* var. *albiflora*, *Fuchsia conica*, *Fuchsia gracilis*, *Thunbergia alata*, *Thunbergia fragrans*, *Rosa salicifolia*, *Mimulus luteus* var. *rivularis*, &c. &c. The exhibition of georginas was of a very superior order, and well competed. (*Yorkshire Gazette*, Sept. 26.)

*York Florists' Society.* — On Aug. 11., the Ancient Society of York Florists held their Annual Show of Carnations, Picotees, &c. The prizes were adjudged as follows : —

*Carnations.* Bizards. Scarlet : 1. Davey's Sovereign, and 2. Number Sixty-one, Mr. Parker ; 3. Ely's Mayor of Ripon, Mr. W. Hardman ; 4. Number Sixty-two, and 5. Number Six, Mr. Parker. Pink : 1. Cartwright's Rainbow, 2. Number Fifty-one, 3. Gregory's Alfred, and 4. Number Fifty-two, Mr. W. Hardman ; 5. Gregory's Alfred, Mr. Parker. Flakes. Scarlet : 1. Lacey's Queen, Mr. W. Hardman ; 2, 3, and 4. Wilson's Seedling, Mr. Wilson ; 5. Number Fifty-eight, Mr. W. Hardman. Purple : 1. Hufton's Mrs. Godfrey, and 2. Number Twenty-seven, Mr. W. Hardman ; 3. Number Twenty-seven, 4. and 5. Seedling, Mr. Wilson. Rose : 1. Clegg's Smiling Beauty, Mr. W. Hardman ; 2. Clegg's Smiling Beauty, Mr. Parker ; 3. Number Fifty-three, Mr. W. Hardman ; 4. and 5. Number Sixty-three, Mr. Parker. Selfs : 1. and 2. Seedling, Mr. Wilson ; 3. Number Eighty-four, and 4. Number Fifty-five, Mr. W. Hardman ; 5. Number Seventy, Mr. Parker. — *Picotees.* Red and White : 1. Wilson's Duke of Wellington, Mr. Wilson ; 2. Pearson's England's Defiance, Mr. W. Hardman ; 3. Lee's Will Stukely, Mr. Parker ; 4. Lee's Will Stukely, Mr. W. Hardman ; 5. Wilson's Bonaparte, Mr. Wilson. Purple and White : 1. Wilson's Ulysses, 2, 3, 4, and 5. Wilson's Seedling, Mr. Wilson. Yellow and Buff : 1. Charlton's Yellow Picotee, 2. Dobson's Seedling, 3. Number Fifty-nine, 4. Maid de Magdeburg, and 5. Number Sixty, Mr. W. Hardman. Best Bouquet, Mr. Parker. — *Gooseberries :* Heaviest, Mr. Parker ; fewest in a pound, Mr. Parker. (*Yorkshire Gazette*, Aug. 22.)

*Ripon Florists' Society.* — The members of this Society held their Third and Final Meeting this year, in Ripon, on Aug. 15., when the specimens exhibited were numerous, and of a very superior description. The prizes were awarded as follows : —

*Carnations.* Bizards. Scarlet : 1. Wild's Perfection, and 2. Ely's Mayor of Ripon, Mr. Cuthbertson ; 3. Mayor of Ripon, Mr. G. Grayson ; 4. Mayor of Ripon, and 5. Doctor Syntax, Mr. May ; Wild's Perfection, Mr. J. Binn. Pink : 1. Bang Europe, Mr. May ; 2. Ivc's Prince Leopold, Mr. Cuthbertson ; 3. Ivc's Prince Leopold, Mr. Mufham ; 4. Gregory's King Alfred, Mr. J. Binn ; 5. Hall's Morning Star, Mr. Clarke ; 6. Ivc's Prince Leopold, Mr. J. Binn. Flakes. Purple : 1. Turner's Princess Charlotte, and 2. Smith's Number One hundred and eighty-seven, Mr. Cuthbertson ; 3. Pike's Nonpareil, Mr. J. Binn ; 4. Turner's Princess Charlotte, Mr. Sweeting ; 5. Bate's Wellington, Mr. Clarke ; 6. James's Queen, Mr. T. Harrison. Scarlet : 1. Cartwright's Commander, Mr. May ; 2. Pearson's Madame Mara, Mr. G. Grayson ; 3. Harley's Wonderful, and 4. Pearson's Madame Mara, Mr. Clarke ; 5. Unknown, Mr. May ; 6. Pearson's Madame Mara, Mr. Sweeting. Pink : 1. Seedling, Mrs. Lawrence, 2. Tate's Miss Nanny, and 3. Yates's Supreme, Mr. Cuthbertson ; 4. Tate's Waterloo, Mr. Sweeting ; 5. Plant's Lady Byron, Mr. Mufham ; 6. Unknown, Mr. Sweeting. — *Picotees.* Purple : 1. Lee's Cleopatra, Mr. May ; 2. Hufton's Miss Emma, Mr. Clarke ; 3. Ely's Lady Grantham, Mr. G. Grayson ; 4. Hufton's Miss Emma, and 5. Milkmaid, Mr. Moore ; 6. Complete, Mr. Sweeting. Scarlet : 1. Ely's Complete, and 2. Marshall's Miss Bramilin, Mr. Cuthbertson ; 3. Will Stukely, Mr. T. Harrison ; 4. Will Stukely, Mr. Cuthbertson ; 5. Will Stukely, Mr. Mufham ; 6. Marshall's Miss Bramilin, Mr. Sweeting. Yellow : 1. Hird's Miss Harriett, Mr. J. Binns ; 2. Highland's Grenadier, Mr. May ; 3. Fair Maid of the Alps, Mr. Mufham ; 4. Highland's Phoenix, 5. Highland's Turtle Dove, and 6. Highland's Excellent, Mr. May. (*Yorkshire Gazette*, Aug. 22.)

*Bedale Florists' Society.* — The members of this Society held a Meeting in Bedale, on Aug. 15., when the prizes were adjudged as follows : —

*Carnations.* Bizards. Scarlet : 1. Plant's Lord Nelson, 2. Foxhunter, and 3. Seedling, Mr. Hewson. Pink and Purple : 1. Doctor Syntax, and 2. Plummer's Lord Denby, Mr. Spence ; 3. Gregory's Alfred, Mr. Hewson. Flakes. Scarlet : 1. Madame Mara, Mr. Sanderson ; 2. Thornicroft's Blucher, Mr. Whitton ; 3. Seedling, Mr. Hewson. Purple : 1. Seedling (the Rector of Bedale), Mr. Hewson ; 2. Harley's Diana, Mr. Sanderson ; 3. Wood's Commander, Mr. Spence. Rose : 1. Waterhouse's Rose Imperial, Mr. Hewson ; 2. Plant's Lady Hood, and 3. Duchess of Devonshire, Mr. Whitton. — *Picotees.* Scarlet : 1. Will Stukely, Mr. Whitton ; 2. Will Stukely, Mr. Hewson ; 3. Alpha, Mr. Hird. Purple : 1. Telford's Major Healey, Mr. Hewson ; 2. Cleopatra, and 3. Seedling, Mr. Sanderson. Yellow : 1. Sultana, Mr. Caven ; 2. Sultana, Mr. Whitton ; 3. Fair Maid of the Alps, Mr. Caven. (*Yorkshire Gazette*, Aug. 22.)

#### NORTHUMBERLAND AND DURHAM.

*The Botanical and Horticultural Society of Durham, Northumberland, and Newcastle upon Tyne* held a Meeting in Newcastle, on Sept. 11., when prizes were awarded as follows : —

For the best-flavoured pine (Anson's Seedling), the gold medal to Ralph Naters, Esq., Sandford House. This fruit was selected out of eight fine pines of various sorts, sent by the same gentleman. Red-fleshed melon, the silver medal ; dish of best-flavoured gooseberries, the silver medal ; and seedling apple, the silver medal ; to Mr. Joseph Clarke, gardener to Mrs. Bewicke, Close House. Six peaches, the silver medal, to Mr. Robert Turnbull, gardener to the Rev. J. S. Ogle, Kirkley Hall. Dish of nectarines, the silver medal ; and dish of plums, the silver medal ;

to Mr. T. Watson, gardener to James Kirsopp, Esq., Spital. Green-fleshed melon, the silver medal, to Mr. John M'Queen gardener to S. W. Parker, Esq., Scot's House. Six apricots, and exotic plant in flower (*Amaryllis gigantea*), silver medals to Mr. John Ward, gardener to C. J. Clavering Esq., Axwell Park. Dish of mulberries, and bouquet of flowers, silver medals to Mr. Thomas Cook, gardener to T. W. Beaumont, Esq., Bywell Hall. Double carnation, Sandham's Lady Kay; double picotee, Rosalie de Rohan; and seedling picotee, Victory; silver medals to Mr. James Scott, gardener to Edward Charlton, Esq., Sandoe. Seedling carnation, named North Tyne Hero, a silver medal to Mr. Thomas Grey, Humshaugh. Twelve georginas, of sorts named, the silver medal to Mr. Adam Hogg, at Messrs. Falla and Co., Gateshead nursery. A collection of extremely beautiful seedling picotees and carnations were sent to the Meeting by Mr. Robert Telford, gardener to F. Hartley, Esq., Middleton Lodge, Yorkshire, and attracted great admiration. The Committee awarded Mr. Telford a silver medal for these very superior flowers. As a proof of the great interest this Society has excited in the country, there were no less than thirty competitors for the various prizes.

A Branch Meeting of the same Society was held on September 9., in Durham, when the following prizes were awarded:—

Green-fleshed melon, red-fleshed melon, six apricots, six peaches, and twelve georginas, silver medals to Mr. T. Cooke, gardener to T. W. Beaumont, Esq., Bywell Hall. Six nectarines, the silver medal to Mr. N. Billau, gardener to the Rev. Joseph Cooke, Newton Hall. Dish of plums, the silver medal to Mr. John Avery, gardener to T. W. Salvin, Esq., Croxdale Hall. Dish of best-flavoured gooseberries, the silver medal to John Gregson, Esq., Durham. Dish of mulberries, the silver medal to Mr. Watson, gardener to Jas. Kirsopp, Esq., Spital. Seedling carnation, the silver medal to Mr. Jas. Scott, gardener to Edward Charlton, Esq., Sandoe. Carnation and picotee, silver medals to Mr. John M'Leish, gardener to A. J. Creswell Baker, Esq., Creswell. Bouquet of flowers, the silver medal to Mr. John Avery, gardener to T. W. Salvin, Esq., Croxdale. Some fine specimens of hemp plants, manufactured hemp, and Cobbett's corn, were exhibited by Mr. Hopton, from the garden of the prison in Durham. The Committee afterwards examined this crop of hemp, consisting of two acres, the estimated produce of which is 20 bolls of seeds, one quarter of a ton of hemp per acre, worth 30*l*. Some fine roots of Italian or turnip-rooted beet, a new variety, were sent by Mr. Alex. Reid of Etal, and were much admired. The exhibition was most numerous and respectfully attended. Some fine bunches of grapes, of various sorts, grown against a hot wall at Croxdale, were also exhibited, and attracted great attention. (*Newcastle Courant*, Sept. 12.)

#### SOMERSETSHIRE.

*Bristol Horticultural Society.*—The Third Exhibition of the above Society took place on Sept. 16. We were particularly struck with some remarkably fine pines, grown by Mr. Burn, gardener to the Marquess of Aylesbury, and some rich and delicious grapes by J. Wickham, Esq., and the Rev. T. Coney of Bruton. There were also upwards of 30 sets of fine peaches and nectarines, from Mr. Miller's experimental garden at Arno's Vale, besides a beautiful collection of seedling and anemone-flowered georginas from the same, and eighteen sorts of fine double China-asters from Hamburg, produced by Mr. Miller. A very fine specimen of Cobbett's corn, with sugar extracted from it, was much admired. Prizes were awarded as follows by the censors, Messrs. Fedden, Masey, Rootsey, Edwards, and Breese:—

*Plants.* Hardy: 1. *Gloxinia maculata*, J. S. Harford, Esq.; 2. *Erica stricta*, Mr. Maule. Green-house: 1. *Sálvia splendens*, Mrs. Hurle; 2. *Hoya carnosa*, Mr. Verney. Stove: 1. *Crinum amabile*, Mr. Burn; 2. *Allamanda cathartica*, T. Daniel, Esq. Herbaceous: 1. *Dracocéphalum speciosum*, Mr. Lee; 2. *Aconitum variegatum*, Mrs. Hurle. Ericas: *E. Bowieana*, and 2. *E. elata*, Mr. Maule. — *Flowers.* Georginas. Double Tall: 1. Mr. Wheeler, Warminster; 2. Mr. Lee; 3. W. P. Taunton, Esq.; 4. and 5. Mr. Maule; 6. Mr. Lee. Double Dwarfs: 1, 2, 3, 4, and 5. Mr. Lee; 6. Mr. Maule. Seedlings: 1. Mr. Lee; 2. Mr. Young, Taunton; 3. Col. Houlton. — *Fruit.* Pine-apples: 1. Black Jamaica, 2. Russian Globe, and 3. Cockscorb, Mr. Burn, Tottenham Park; 4. Black Jamaica, and 5. Black St. Vincent. Mr. Verney. Apples, Early Dessert: 1. Mr. G. W. Hall; 2. Kerry Pippin, Mr. D. Stanton. Late Dessert: 1. Mr. G. W. Hall; 2. Golden Pippin, J. W. Ricketts, Esq. Culinary: 1. Hawthornden, Mrs. Gregory; 2. Emperor Alexander, Captain Mitchell, Stoke. Cider: 1. Royal Kentish Pippin, Mr. Pittard; 2. Quarrenden, W. W. Davies, Esq., Cote. Seedlings: 1. Seedling Nonpareil, W. Oliver, Esq., Taunton; 2. Seedling, Mrs. Gregory. Pears. Dessert: 1. Chaumontelle, Col. Houlton, Farley Castle; 2. Gansell's Bergamot, Miss Powell, Henbury; 3. Jargonelle, Christopher George, Esq.; 4. Orange Vert, Mrs. Gregory; 5. Golden Beurrée, J. W. Ricketts, Esq.; 6. Portbury, Miss Bright; 7. Crassane, Col. Houlton; 8. Ambrosia, Mr. Pittard; 9. Autumn Bergamot, and 10. Summer Bergamot, Miss Bright. Peaches: 1. Royal George, Mrs. Gregory; 2. Royal Kensington, Mrs. Hurle, Brington; 3. Orange, Captain Parish, Timsbury; 4. Vanguard, Mr. Pittard; 5. Royal George, Mrs. Gregory. Nectarines: 1. Roman, Mrs. Hurle; 2. Tawny, Mr. Pittard; 3. Elruge, Mr. Mossman, Leigh; 4. Newington, Mrs. Gregory; 5. Roman, Colonel Houlton. Melons: 1. Cantaloup, Mr. Maule; 2. Nettle Cantaloup, H. Meyers, Esq., Lawrence Weston; 3. Green-stalked, Mr. Verney; 4. Melksham, Mr. Maule. Filberts: 1. Alfred George, Esq.; 2. Mrs. H. Vaughan, Cote. Grapes. Hot-house: 1. White Syrian, Mrs. Harford; 2. Black Damascus, Mr. Verney; 3. Black Hamburg, J. Wickham, Esq., Batcomb, near Bruton; 4. Medley, and 5. St. Peter's, J. W. Ricketts, Esq. Out-doors: 1. White Muscadine, Mr. Cartwright; 2. Hardy Black, Miss F. Player; 3. Muscadine, Mrs. Sheriffe; 4. White Grape, Mrs. Gregory. — *Culinary Vegetables.* Celery. White: 1. Mr. Maynard; 2. Mr. Sealy. Red, H. Meyers, Esq. Broccoli: 1. Cape, Mr. Maynard; 2. Mr. Sealy.

*Fruits and Vegetables possessing superior Merit.* Seedling Apples, Mr. Pittard; Brown Naples Fig, Mrs. John Cave; Morello Cherries, Mr. Mossman; Seedling Nonpareils, W. Oliver, Esq.; Apple, large, Rev. Mr. Phelps, Meare, near Glastonbury; Catshead Apple, Mrs. Cartwright; New Seedling Grapes, W. P. Jacques, Esq.; Cobbett's Corn and Sugar, Mr. Rankin; Mexican Potatoes, Mr. Fewster. — *Cottagers' Prizes.* Potatoes: Ash-leaf Kidneys, Jos. Warry and Betty Royal. Onions: Betty Royal; underground, Thos. Phillips. (*Bristol Gazette*, Sept. 17.)

#### DEVONSHIRE.

*Devon and Exeter Horticultural Society.*—At the September Meeting of this Society the supply of rare and curious exotic plants was greater than at the July exhibition: among them the Screw Pine, the Tamarind Tree, the Cotton Plant, the *Musa coccinea* or Scarlet Plantain which was exhibited in flower, *Strelitzia regina*, *Dracæna terminalis*, *Caladium bicolor*, the Fan-leaved



Palm, *Allamanda cathartica*, *Vallöta purpurea*, *Crinum americanum*, *Thunbergia alata* and *grandiflora*, *Pittosporum Tobira*, and a beautiful collection of heaths were most conspicuous. The above beautiful specimens were supplied from the stoves of Mr. Milford. The Rev. Finney Belfield, Mrs. Johnes of Hill's Court, Mr. Pontey, Messrs. Pince and Co., and Mr. C. Slater, all of whom contributed liberally to the splendour of the exhibition, as did Sir Stafford Northcote, Sir T. Ackland, Mr. Cholwich, and many other subscribers. The great attraction, however, in the flower department was formed by the collections of georginas, exhibited by Mr. Veitch of Killerton, Messrs. Pince and Co., Mr. Dymond, Mr. C. Slater, and Mr. Young of Taunton. Messrs. Pince and Co. also exhibited the best collection of hardy perennials, among which we particularly remarked the *Philox reflexa* in fine flower. Among the fruit we notice, as curious, the Brazilian Pines exhibited by Mr. Pontey, and we must not omit to mention the Sweetwater Grapes exhibited by Mr. Saunders, gardener to C. Hoare, Esq., of Luscombe, grown in the open air, which were in the highest perfection. The pears (26 distinct varieties) exhibited by the Rev. F. Belfield were greatly admired, as well as the apples (47 distinct varieties) exhibited by Messrs. Pince and Co., who also produced the best collection of dessert apples: a dish of six pears, of the Swan's Egg sort, exhibited by Mr. Nicholls, gardener at Winslade, attracted great attention from their extraordinary size and beauty, as well as a dish of fine pears, grown by Mr. Lambell of Bovey, from grafts inserted on the White Thorn. The prizes announced for Honey led to the exhibition of the Polish Log Hive, full of fine honey-comb, by Mr. Read, gardener to Mrs. Walrond of Monrath House, who also contributed a fine bell-glass full of virgin combs taken without injury to the bees. Mr. Milford also exhibited a swarm of bees in a glass hive, which they had nearly filled with their useful labours, and where they still were in active employment. — The Judges were, Colonel Wright of Lymptstone, Mr. Saunders, gardener to C. Hoare, Esq., of Luscombe, and Mr. Cragg, gardener to Sir T. Ackland, Bart.: all of whom contributed liberally to the exhibition, particularly Mr. Saunders, whose exhibition of grapes, nectarines, peaches, lemons, pines, and tomatoes, was of first-rate excellence. Colonel Wright also exhibited some fine citrons and lemons, and a good collection of apples. Prizes were awarded as follows: —

*Plants.* Tender Exotic: 1. *Allamanda cathartica*, J. Newcombe, Esq.; 2. *Thunbergia grandiflora* and *alata*, Mr. C. Booth, gardener at Mrs. Johnes's, Hill's Court. Bulbous-rooted tender Exotic: 1. *Crinum americanum*, J. Milford, Esq.; 2. *Vallöta purpurea*, Rev. F. Belfield. Exotic that has survived two winters in the open ground without protection: 1. *Erythrina crista galli*, Rev. F. Belfield; 2. *Pittosporum Tobira*, Mr. C. Booth. Bouquet of tender Annuals, Mr. Reed, gardener to Mrs. Walrond. Best specimens of hardy Perennials, Messrs. Pince and Co. — *Flowers.* Georginas: Crimson or Morone of sorts, Scarlet and Purple, Mr. Veitch, Nursery, Killerton; Lilac, Messrs. Pince and Co.; other Light Shades, Mr. Dymond; Dwarf of sorts, Mr. Veitch; Anemone-flowered of sorts, Messrs. Pince and Co., Bouquet, Mr. Veitch. — *Fruit.* Pine-apple: 1. Mr. Herman Saunders, gardener to E. P. Bastard, Esq., of Kitley (this fruit was of high flavour, and produced from a sucker in 11 months only); 2. Mr. Wooster, foreman to Mr. Veitch of Killerton. Grapes, White: 1. Mr. James Law, gardener to Edward Divett, Esq., Bystock; 2. Mr. Hall of Powderham. Black: 1. Mr. James Davey of Exeter; 2. Mr. Hall of Powderham; Best and high-flavoured, Sir S. H. Northcote, Bart. (the cultivation of these grapes reflected great credit on Mr. Edmonds, Sir Stafford's gardener). Melon: 1. and 2. Mr. C. Slater, nurseryman, Exeter. Specimen of the Citrus tribe, raised without fire or dung-heat: 1. (Seville oranges), and 2. the Kitley Shaddock, Mr. Herman Saunders, gardener to E. P. Bastard, Esq. Exotic Fruit: 1. *Psidium Cattleianum*, and 2. *Psidium pomiferum*, J. Milford, Esq. Mr. Milford also exhibited the fruit of the plantain, unripe, in the state in which it is dressed in the West Indies; and the exhibition of these fruits, as well as the general appearance of his stove-plants, entitles Mr. Henry Daglish, his gardener, to high encomium. Peaches, Mr. May, gardener to Sir Lawrence Palk, Bart. Nectarines, Mr. May, gardener to Sir Lawrence Palk, Bart. Apricots, J. B. Burn, Esq., Shobrook. Plums, J. Sweetland, Esq., Teignmouth. Figs, The Right Hon. Lord Clifford. Pears: collection named, two of each sort (26 varieties), the Rev. F. Belfield; Dish of 12 (Gansell's Bergamot), Mr. Hall, Powderham. Apples, dessert: collection named, two of each sort (47 varieties), and dish of 12, Messrs. Pince and Co. Quinces, Mr. Waldron, St. Thomas. Mulberries, John Hart, Esq., Hill's Court. Nuts, Mr. Herman Saunders. Dish of Fruit of any kind from a Cottager's Garden, John Lambell of Povey. This fruit, as we have before noticed, was produced from grafts inserted on the white thorn. — *Culinary Vegetables.* Celery, Mr. Williamson, gardener to S. T. Kekewich, Esq., Peamore. Broccoli, The Rev. Henry Thorp, Topsham. Carrots (Altringham), Whittaker, Esq., Ide. Peas (Cimeter), Messrs. Pince and Co. Artichokes, Sir Stafford Northcote, Bart. Cucumbers, J. Newcombe, Esq., Starcross (whose gardener, Mr. Billingsley, greatly distinguished himself at the July Exhibition, having received a prize for every article he exhibited). Endive, blanched, Mr. C. Slater. Red Beet, G. Whittaker, Esq. Culinary Vegetable from a Cottager's Garden (Cabbage): 1. Mr. Westcott of Topsham, exhibited by the Rev. H. Thorp; 2. Savoy, Mr. Palmer.

*Honey.* Box or butt of honey, obtained from one hive without destroying the bees, Mr. Reed, gardener to Mrs. Walrond. The judges also recommended that rewards be given for the under-mentioned articles, they not having gained prizes: — Brazilian Pines, Mr. Pontey of Plymouth; Black Hamburg Grapes, Mr. Williams, gardener to the Right Hon. Lord Clifford; Granadilla, James Law, gardener at Mr. Divett's; Nectarines, J. Sweetland, Esq.; Dessert Apples of the growth of 1828, in excellent preservation, W. Guscott, gardener to the Miss Putts of Gittisham; Seedling Apples, W. Elstone, Mrs. Patch's gardener, at Topsham (this fruit was of superb size, and was reported to be excellent). Raspberries, Mr. James Townsend, nurseryman, Exeter; Curled Parsley, Mr. Williamson of Peamore. (*Woolmer's Exeter Gazette*, Sept. 26.)

## ART. XXI. Obituary.

*DIED*, Sept. 4., at Nurseryville, near Comber, Mr. John Hervey, nurseryman, in the 45d year of his age. Mr. Hervey has fallen a victim to hydrophobia, and the circumstances which attended this terrific malady have

created a feeling of intense sorrow, amidst a very large circle of friends and acquaintances. "It is, however, in a public light that we must view the deprivation society has sustained in the loss of this worthy and intelligent man. His example and his taste as a botanist had spread a spirit of improvement over the whole province of Ulster; and the beautiful grounds of Nurseryville were the resort of almost every scientific person who visited this part of Ireland. Nor did his active and enquiring mind rest contented with bringing to a state of the highest perfection the more mechanical parts of those interesting pursuits in which he had been engaged for the major part of his life; he examined, with the study and the investigation of a man of science, into the most abstruse parts of botanical pursuits. His acquaintance with this branch of knowledge was allowed to be very considerable. He also corresponded with the first naturalists of the present time; and considered no expense too costly in storing his mind with every useful information, or in enriching his gardens with the rarest and most valuable plants. His taste and skill were the boast of his country; his hospitality was proverbial, both among friends and strangers; and his melancholy death will be a great public loss, and will long leave behind it feelings of deep sorrow, in the bosom of every man who enjoyed his society or his friendship." Mr. Harvey occasionally corresponded with both our Magazines, and none of his friends more sincerely regret his loss than we do. Every accident of this sort ought to teach us to make the most of life, by employing or enjoying every moment; and to be always ready, in respect to worldly affairs, to leave it, by ordinary or extraordinary disease, at the shortest notice. "The remains of Mr. Hervey were removed from Nurseryville to the family burying-ground at Annahilt. The multitude of persons who filled up the long train of the funeral pageant, — persons of the first respectability, and of different religious and political opinions, — best bespoke the universal esteem in which he was held. It was an esteem that sprang from a firm conviction of his worth; and this, like wealth honestly earned, will wear long and well." It may afford a useful lesson to our readers, to mark the steady fortitude and vigilant exercise of duty with which Mr. Hervey met his approaching end; knowing it to be an inevitable result, and knowing also that it would be attended by dreadful previous suffering. He received a scratch on the cheek, and was bit in the arm by a dog in June, and as soon as possible afterwards had a portion of the flesh of the arm cut out, and a course of medicine prescribed. It is uncertain whether or not he attended to the medical prescription with sufficient rigidity; but on the 2d of Sept. he first discovered himself to be labouring under the influence of hydrophobia, by experiencing a spasmodic affection, when he attempted to put some water into his mouth. "He was in Belfast on business on the 1st inst., and dined with one of his friends, without any thing remarkable being observed in his manner, except, it is now said, a restlessness and a dulness of spirits. Soon after his arrival at home, however, he found himself unwell, and continued so until morning, when he rose to take a glass of water, and found that he could not bear to look at it. From that moment he knew all was over, and that not a hope remained; notwithstanding which, such was his nerve, that he retired to bed, without alarming the family, until his aunt came to call him to breakfast, and even then he did not communicate to her the awful certainty of his approaching end, but sent into Comber for two of his particular friends, under pretext of business, to whom he communicated his fatal discovery and situation. Dr. Purdon was immediately sent for, and did his utmost to alleviate his distress; but all was in vain, no human aid could then avert the sad fate which awaited him. Although perfectly aware of his own situation, he remained firm and collected, frequently expressing his hope that the Almighty would endue him with firmness to meet his fate as a man and a Christian, and giving occasional instructions for his friends' govern-

ment, after his demise, until within a few hours of his death." (*Belfast Chronicle*, Sept. 7.)

About a week after we had prepared the above account, we saw in the *Scotsman* an account of Mr. Harvey's case, which enters much more into detail than that in the newspaper which was sent us. A more fearful relation we never read, and we should not harrow up the feelings of our readers by the following concluding paragraph, were it not for the purpose of appending some remarks. "He struggled dreadfully, and appeared to wish to get himself out of the bed. He screamed with the most appalling agony, and called for Dr. O'Neill to cut his jugular vein. He besought his friends about him to put an end to his horrible torment, if they had the smallest spark of pity remaining in them. Some of his labourers came in, and assisted in holding him down. So intolerable was the dreadful agony of the sufferer, that he threatened to bite those who held him, if they did not kill him or let him up. Fearing that the courage of the men might fail, Mr. Miller called on them to remain firm, if they valued their existence. Hearing this, the tortured sufferer exclaimed, 'Miller, you savage, I will never forgive you.' He continued beseeching those about him, alternately, to put an end to his pain; when, finding all ineffectual, he cried out, 'If ever the soul be allowed to haunt those who have done them wrong, I will return and torment you all.' He then ceased shouting, but three or four times he was heard to say, in an under tone, 'severe, terrible,' in a manner that showed he was perfectly sensible, though the agony in the height of the paroxysm was too great for even a man in his senses to bear. At 20 minutes to 4, squeezing the hand of one of his friends, and breathing his name, he expired. The self-possession, the firmness, the disinterestedness, and the amiable kindness evinced by Mr. Hervey, during his unparalleled sufferings, though only indicative of his general character, are sufficient to excite our astonishment at the fortitude and magnanimity which a noble spirit can display." (*Scotsman*, Oct. 10. 1829.)

As a general principle, it can never be laid down as a part of the duty of a physician to do any thing with a view to shorten life; but, in such a case as that of Mr. Hervey, we certainly think his friends would have been justified in administering hydrocyanic acid. We think we should have done so, had we been in the place of Mr. Miller. On mentioning this dreadful case to Professor Thomson of the London University, he informed us that, from past experience, he had little doubt of being able to cure hydrophobia, if ever a case should again come before him. He referred us to the *Medico-Chirurgical Transactions*, vol. vii. p. 299. in which is given by him a case of hydrophobia, with the appearance of the body on dissection, and remarks on the nature and treatment of the disease. On dissection, the spine was found to be the part chiefly diseased, there being great turgidity of the blood-vessels, and depositions on the coats of the spinal marrow. The following is the proposed method of cure: repeated cuppings all along the course of the spine; early administration of large (15 grs.) doses of calomel, then prussic acid; and, when the excitement is abated, powerful tonics. It is highly consolatory to think that there is even a prospect of curing this dreadful malady; and we have no doubt but it, and several others at present considered incurable, will, with the progress of medical science, be ultimately subdued. The first step towards the curing of any disease is to ascertain on what part of the system it operates, and if every one who dies of this malady were dissected by such men as Dr. Thomson, it could not fail to be discovered. A correspondent of the *Morning Chronicle*, speaking of Mr. Hervey's case, suggests the idea of neutralising the canine poison by administering to the dog or man under its influence the Wourali poison, which, he says, acts as a sedative. — *Cond.*

---

# INDEX

TO

## BOOKS REVIEWED AND NOTICED.

### THE GENERAL SUBJECT.

**ARCANA** of Science, noticed, 202.  
 Associate, not., 388.  
 Bidaud de la Mendicité, de ses Causes et des Moyens de la détruire en France, not., 206.  
 Bishop's Causal Botany, 455.  
 Brard's Minéralogie, &c., 206.  
 Castle's Introduction to Botany, 542.  
 Cline's Observations on Breeding, &c., 201.  
 Cooperator, not., 388.  
 Curtis's Botanical Magazine, &c. for September, reviewed, 149; October, 149; November, 150; December, 151; January, 151; February, 152; March, 299; April, 300; May, 301; June, 445; July and August, 518; September, 519.  
 Domestic Gardener's Manual, rev., 190.  
 Edinburgh Journal of Nat. and Geog. Science, announced, 455.  
 Edwards's Botanical Register, rev., Sept. 153; Oct. and Nov., 154; Dec., 155; Jan., 156; Feb., 157; March, 302; April, 302; May, 303; June, 445; July, 519; Aug., 520; Sept., 522.  
 Elsner's Veredelten Schafzucht, 207.  
 Felton's Gleanings on Gardens, &c., rev., 193.  
 Fleming's British Farmer's Magazine, rev., Nov. and Feb., 172; May, 531.  
 Flora Médica, not., 172; for April, 315.  
 Fowler's Thermosiphon, rev., 453.  
 George's Cause of the Dry Rot discovered, &c. rev., 196.  
 Harding's Farmer's Account Book, not., 201.  
 Haworth's English Poor, not., 541.  
 Hazzi's Neuester Katechismus des Feklbaues, &c., 207.  
 Hogg's Queen's Wake, 318.  
 Hooker's Botanical Miscellany, &c., rev., 303.  
 Johnson's History of English Gardening, about to appear, 207.  
 Jones's Flora Devoniensis, 542.  
 Kachler's Encyclopædic Dictionary of Plants at Vienna, 210.  
 Kennedy's Cultivation of Waste Lands, rev., 540.  
 Kennedy and Granger's Tenancy of Land in Great Britain, not., 200.  
 Lambert's Rural Affairs of Ireland, rev., 540.  
 Lawrence's Horse, &c., rev., 540.  
 Lawson's Treatise on Smut in Grain, &c., to appear, 207.  
 Legarre's Southern Agriculturist, &c. not., 323.  
 Letter to Thos. A. Knight, Esq., &c. 534.  
 Loddiges' Botanical Cabinet, rev., Sept. 158; Oct., Nov., Dec., and Jan., 159; Feb., 160; March, 309; April and May, 310; June, 446; July, 523.  
 Loudon's Encyclopadias of Gardening and Agriculture, errors in, 238.  
 Loudon's Encyc. of Plants, rev., 452.  
 Loudon's Hortus Britannicus, query and answer on, 109.  
 Major's Treatise on Insects, rev., 192.  
 Martin Doyle's Hints, &c., 318.  
 Maund's Botanic Garden, rev., from Aug. 1828 to Feb. 1829, 165; March, April, and May, 311; June and July, 449; Aug. and Sept., 525.  
 Moggridge's Address to the Glamorgan and Monmouthshire Hort. Soc., rev., 195.  
 Parattonnerres, &c., 206.  
 Parmentiers Espèces de Lait, 206.  
 Pécelet's Traité de la Chaleur, &c. not., 322.  
 Phillips's Personal Tour, &c., not., 201.  
 Phillips's Flora Histórica, 542.  
 Pomological Magazine, rev., Sept., Oct., Nov., 169; Dec. and Jan., 170; Feb., 171; March, 315; April and May, 316; June, 449; July, 452; Aug. and Sept. 530.  
 Quarterly Journal of Agriculture, &c. rev., 173; No. V., 533.

Remusat's Conseils de Morale, &c., 206.  
 Richardot's Système d'Appareils, &c. 206.  
 Risso's Productions de l'Europe Méridionale, &c., 206.  
 Soulange Bodin's Annales de l'Institut. Horticole de Fromont, noticed, 322.  
 Sowerby's Supplement to English Botany, No. I. for July, 526.  
 Stanhope's Letter to the Owners of Sheep Farms, 201.  
 Stephens's Practical Irrigator, rev., 317.  
 Stephenson and Churchill's Medical Botany, rev., Sept. 166; Oct. 167; Nov., Dec., and Jan., 168; Feb. and March, 312; April, 313; May, 314; June and July, 527; August, 528; Sept. 529.  
 Strickland's Poor Laws, not., 201.  
 Sweet's Cistinea, rev., Sept., Nov., and Jan., 165; March, 448; May, 449; July, 525.  
 Sweet's Florist's Guide and Cultivator's Directory, rev. from Sept. 1828, to Feb. 1829, 165; March, April, and May, 311; June and July, 449; Aug., 526; Sept., 527.  
 Sweet's Geraniaceæ, rev., from July, 1828, to Feb. 1829, 164; March, April, and May, 311; June, 448; Aug. and Sept., 525.  
 Tovey's Earnest Address, not., 201.  
 Trimmer's Improvement of British Fine Wool, &c., 201.  
 Wagner's Merinos Schafzucht, 207.  
 Walker's Flora Oxon., to be published, 323.  
 Wallich's Plantæ Asiaticæ Rariores, to be published by subscription, 207.  
 Widowson's Present State of Van Dieman's Land, rev., 199.  
 Wright's Catalogue of Books, 201.

### GARDEN ARCHITECTURE.

Daniel's View of the Palais Royal, not., 200.  
 Robinson's Designs for Ornamental Farm Buildings, rev., 319.  
 Wetten's Designs for Villas, rev., 541.

### FLORICULTURE.

Flower Shows, Lists of, to be published, 323.  
 Jacquin's Essai sur la Culture, la Nomenclature, et la Classification des Dâhlia (now Georgina), rev., 205.  
 Lindley's Synopsis of the British Flora, &c., 201.  
 Loiseau Deslongchamps's Flore de la France; Hist. des Muriers, &c., 206.  
 Prevost's Catalogue du Genre Rosier, 455.  
 Rédouté's Choix des plus belles Fleurs, &c. 206.  
 Sweet's British Flower-Garden, rev., Sept., 160; Oct., 161; Nov., 162; Dec. and Jan., 168; Feb., 164; March and April, 310; May, 311; June, 446; July, 523; Aug. and Sept., 524.  
 Tarade's Culture des Rosiers écusonnés sur Eglantiers, not., 205.  
 Vallet's Catalogue des Roses, not., 505.  
 Vibert's Essai sur les Roses, liv. 1 and 2; and Nomenclature des Roses, &c., 206.

### HORTICULTURE.

Annales de la Soc. d'Hort. de Paris, &c. Liv. X. and XI., rev., 202.  
 Ellis's Discourse on Subjects relating to Horticulture, rev., 450.  
 Gooseberry-Grower's Register, &c. 202.  
 Main's Abercrombie's every Man his own Gardener, nct, 316.  
 Memoirs of the Caledonian Horticultural Society, Vol. IV. Part II., rev., 443.  
 McIntosh's Practical Gardener, rev., 180.  
 Transactions of the Hort. Soc. of London, Vol. VII. Part II., rev., 145; Vol. VII. Part III., 285, 516.  
 Verhandlungen des Vereins, &c., Vol. V. Part I., not., 207.

# GENERAL INDEX.

- ABBE'** Boismont, curious facts respecting, 645.  
 Abbeys, with respect to landscape-gardening, 33.  
 Aberdeenshire Horticultural Society, meeting of, March 10., 215; May 28., 462; June 23., 463.  
 "A Blooming Bulb," plagiarism by, by Mr. R. Sweet, 105.  
 Abury, the seat of Mr. Drummond, remarks on, 10.  
 Acclimating exotic plants, 331.  
 Achira, notice respecting the, 332.  
 Advantages, national, of universal education, 700.  
*Agapanthus umbellatus*, 215.  
*Agave americana*, remarkable one, 81.  
 Agricultural Society of Rouen, 501.  
 Agricultural Societies, value of, 178.  
 Agricultural Societies in North America, 550.  
 Agriculture, practical schools of, 337.  
 Agronomie, liberties taken by, by W. M'Murtrie, 98; on the Scotch Pine, 159; general remarks on the Gardener's Magazine, &c., by, 725.  
 Air, mixtures in, 175; heated, on introducing into cucumber frames and pits, 435; fresh, importance of to health, 589.  
 Aitken, Mr. W., on forming artificial seas in ornamental landscape, and on a new sluice for regulating the rise and fall of the tide in such seas, 137.  
 Albany, gooseberry in, 658.  
 Alpine plants and seeds, for sale or exchange, 332.  
*Alstromeria psittacina*, 612.  
 America, North, on the climate of the eastern and middle states of, with reference to horticulture, by Mr. William Wilson of New York, 409.  
 Analysis of soils, 404.  
 Anatomy of plants, study of, aided by nitric acid, 68.  
 Ancient York Florists' Society, show of, May 4., 357; June 3., 485; July 7., 631.  
 Anderson, Mr. D., on a method of facilitating the growth of thorn hedges on high and exposed situations, 42.  
 Anderson, Mr. William, 'F.L.S. H.S., &c., notice of a durable number tally of earthenware, 263; on breaking stones in gravel walks, 459.  
 Annat, plan of the kitchen-garden at, by Mr. Arch. Gorrie, C.M.H.S., 28.  
*Anona cherimolia*, fruited in the botanic garden at Metz, 68.  
 Ants on peach trees, query respecting, 239; answer by Mr. W. Boyce, 730.  
 Apple, the Courtpendu, 315; the Fearn's Pippin, 315; the Golden Reinette, 316; the Canadian Reinette, 449; the Martin Nonpareil, 450; the Wormsley Pippin, 450; the Skyehouse Russet, 529; the Beachamwell Seedling, 529; the Dutch Mignonne, 530; the Barcelona Pearmain, 530; the Old Nonpareil and the Scarlet Nonpareil, 530; the Ross Nonpareil, and the Forman's Crew, 530; account of some varieties of, &c., by Sir George Stuart Mackenzie, Bart. F.H.S., 285.  
 Apples, collection of, at Mr. Ronalds's Nursery, 736; to preserve till late in the year, 363.  
 Apples and pears, select list of, required, 111.  
 Apple trees fit for an orchard, query on, 111; for an orchard, recommended by Mr. C. Lawrence, 731.  
 Approach to a country mansion, 37.  
 Aracacha plant in Colombia, 549.  
 Arboretum in the garden of the Horticultural Society, plan of, and remarks on, 344; of the Rouen botanic garden, 497.  
*Arbutus hybrida*, in the Fulham nursery, 660.  
 Architect's house, 120.  
 Architecture, on the Continent, 6; to communicate a taste for, 700.  
 Argovia, education in, 657.  
 Arundel Castle, 585; suggestions for improving, 587.  
 Ascot Place, 568.  
 Ashtead Park, 595; criticism respecting, by Mr. John Hislop, 722.  
 Asparagus, gigantic, 552.  
*Aspidistra lurida*, figured and described, 523.  
 Atherstone Self-supporting Dispensary, 660.  
 Atmosphere, Essay on, 174.  
 Austin, Mr. James, obituary of, 240.  
 Australia, observations concerning, 550.  
 Ayrshire Green-house Lodge Society, competition of April 18th, 335.  
 Ayton, Mr., his paper on false philosophy in agriculture, 531.  
 Azaleas at Waterton's Nursery, 613.  
 Bagshot Park, 382, 570.  
 Baldock Society for promoting Horticultural Science, meeting of, May 4. 473.  
 Balm of Gilead firs in Kinnell Park, 103.  
 Baltimore pippin, query on, 109.  
 Barley-choppers, figured and described, 673.  
 Baths, the new marine, at Dieppe, 242; to heat by the thermosiphon, 454.  
 Bavaria, rise and progress of gardening in, 384.  
 Beal, Mr. James, gardener at Ascot Place, 569.  
 Beddington Park, 118.  
 Beds for asparagus at Syon, excellence of, 504.  
 Bell, Mr. P., reaping machine invented by, 600.  
 Bees, suggestion respecting, 611; produce of, at Brechin, 83.  
 Beet-root, sugar from the, 325.  
 Bennet, Mr., C.M.H.S., notice of a machine for transplanting large trees, 422.  
 Berlin, some account of the public orangeries or winter-gardens of, by M. G. A. Fintelmann of Potsdam, 251.  
 Bern, gymnasium at, 657.  
 Berquier, M., his gardens, &c., in Rouen, 371.  
 Billardièra mutabilis, 82.  
 Birch, a weeping, hint for producing, 672.  
 Bischof's, M. method of cultivating the mulberry in the government mulberry plantation at Nymphenburg, with a list of the different species and varieties grown there, 424.  
 Blackdown House, 579.  
 Blaikie, Thomas, Esq., state of vegetation in Paris for June, 456.  
 Blenheim House, 551.  
 Bogs, draining of, 338.  
 Boismont, the Abbé, curious facts respecting, 645.  
*Bonatea speciosa*, figured and described, 518.  
*Borassus flabelliformis*, figured and described, 77.  
 Boring for water in Paris, 326.  
 Bosc, M. le Chevalier, obituary of, 112.  
 Botanic Garden of Lisbon, some account of, by W. Churchill, Esq. R.M., 412; Rouen, 497; in the Apothecaries' Island, change respecting, 73; of Liverpool, remarks on, 383.  
 Botanical and Horticultural Societies: Devon and Exeter, July 30th, 638.  
 Durham, Northumberland, and Newcastle-upon-Tyne, meeting of Nov. 14th, 89; Feb. 20th, 221; April 10th, 357; May 8th, 358; June 5th; June 9th, and July 3d, 488; July 10th, 633; Sept. 11th, 743, 749.  
 Hexham, meeting of June 3d, 221, 489.  
 Manchester, 90.

- Botany, importance of the study of, for every class of cultivators, 15; not to be considered the object of the Horticultural Society, 536; on the introduction of, into the system of education in village schools, 390; among the common people in Paris, 546.
- Bouquet of crocuses, bad management of, in the *Horticultural Transactions*, 517.
- Bowers, Mr., gardener at Westdean House, 815.
- Boyce's, Mr. W., answer to the query respecting ants on peach trees, 730.
- Branches of fruit trees, naked, upon a mode of covering with new wood, by Samuel Spyttee Street, Esq., 516.
- Bread without yeast, 668.
- Breakfast-room, elegant specimen of a, 565.
- Breathing-places for the metropolis, &c., on fixed principles, hints for, 686.
- Breech, produce of bees at, 83.
- Bree, the Rev. W. T., on the leaf of a hybrid rhubarb plant, 81.
- Bregazzi's bark-bed thermometer, improvement in, 213; self-registering one, 213.
- Brentford nursery, call at, 736.
- Bretton Hall, 680; general remarks on, 683.
- Brighton Cooperative Society, some account of, 387; gardens of, 118.
- Broccoli Cape and Navet, query respecting, 611; query on the growth of, by Mr. C. Lawrence, 732.
- Brown's gas engine, remark concerning, by William Johns, M.D. F.L.S., 607.
- Brunsvigia toxicaria, query respecting, 111; Josephine's, notice respecting, by Robert Sweet, 332.
- Brussels botanic garden, 327.
- Budding à l'œil poussant, et à l'œil dormant, described, 378.
- Burleigh House, 673.
- Burnard, J. P. Esq., a commercial horticultural society, 349.
- Bury Hill, 593.
- Burying grounds, on the laying out and planting of, by John H. Moggridge, Esq., 26.
- Business room, well furnished, 565.
- Byers, R. W. Esq., on some recent improvements in the method of heating by hot water, 20; a plan for a strawberry-wall, 437; further improvements in the mode of heating hot-houses by, 260.
- Cabbage plants bitten off, remedy against, 731.
- Calceolaria corymbosa, an improved mode of cultivating, by Mr. James Rollins, 272.
- Caldicott, Abraham, Esq., F.H.S.; description of a hot-house, combining a pinery, vinery, succession pit, a winter green-house, all heated by one fire, 418.
- Caledonian Gardeners' Society, meeting of, Jan. 27, 215.
- Calla aethiopica, remarks on, by Mr. John Ferme, 664.
- Calls at gardens, by the Conductor, 557.
- Calvert, Mr., account of his nursery in Rouen, 374.
- Cambridge botanic garden, 305.
- Cameron, Mr., gardener at Bury Hill, 593.
- Canal projected for uniting the Danube and the Rhine, 685.
- Canker in an orchard, query on, 111; in apple trees, remedy for, 731; prevented, 739.
- Capacities of individuals, various, 695.
- Caraccas, new plants from, by Mr. D. Fenning, 661.
- Cárica Papaya, figured and described, 300.
- Carlowie garden, rare plants flowered in, by Mr. David Falconar, 664.
- Carnation show of Ipswich, Aug. 6, 743.
- Carriages, steam, and their influence on improvement, 684.
- Caterpillar, the common, 204; on preserving plants from, 179.
- Caterpillars on gooseberry bushes, an easy method of destroying, by Mr. Richard Williams, 294.
- Cauliflowers, large, 552.
- Cedars proved to grow straight, 569.
- Celeriac, recipe for dressing the roots of, by J. Elles, 364.
- Celery, answer to query on the diseases in, by Mr. Robert Errington, 107; maggots in, 238.
- Cellar, good contrivance in a, 564.
- Central Horticultural Society of Paris, meeting of, Dec. 17. and Jan. 7., 67.
- Ceylon, cinnamon department in, 74.
- Chandos, Duke of, reflections on, 557.
- Channer, Mr. Francis, obituary of, 496.
- Character, moral, value of a good one, 210.
- Characters of gardeners, mode of showing, 102.
- Château de Queville, description of, 641; du Taily, 643; du Maillaieraie, 643; de Radepont, 647.
- Cheiránthus incanus, query respecting, 110.
- Chelsea botanic garden, 308.
- Cherry, the Elton, 530.
- Chimneys, smoky, 238.
- China closet, complete, 565.
- Chiswick garden, calls at, 343. 380. 735.
- Chlidánthus fragrans, query respecting, 111.
- Choco, timber trees of the province of, by W. Hamilton, Esq. M.D., 44.
- Churchill, W., Esq. R.M., some account of the botanic garden at Lisbon, 412.
- Cider, query how to make, and answer to, 734.
- Cinnamon tree, figured, 74.
- Cinnamon department in Ceylon, 74.
- Clapton nursery, 379.
- Claremont, the seat of Prince Leopold, 381.
- Clover, flesh-coloured, 80.
- Coal, soil poisoned by, 177.
- Coal and iron in France, 326.
- Cobbett not the first who raised the Indian corn, by J. Murray, 106.
- Cobbett's corn, query respecting, 111.
- Coccus ovatus, remedy for, by Mr. J. Haythorn, 731.
- Cockchaffer, Mr. Calvert's mode of preventing the ravages of, 375.
- Cockscomb, correction respecting the size of Mr. Howes's, 98.
- Cockscombs at Petworth House, 578.
- Cocos nucifera, 77.
- Colne, the poor in, 659.
- Colosseum in the Regent's Park, remarks on, 222. 671.
- Colville's nursery, visit to, 839.
- Comfrey, stalks and roots of, eaten, 546.
- Commercial Horticultural Society proposed, 349.
- Commodities, prices of, 650.
- Conservatory, description of an ornamental one in the Grecian style of architecture, to be disposed of, by Mr. Roberts, 268.
- Continent, architecture of the, 6; manners of the, 7.
- Cookery, best modes of, 667.
- Cooperative Practical Societies, as a means of ameliorating the condition of the laborious classes, with some account of the one at Brighton, 387.
- Corn, object to be observed in harvesting, 599.
- Cottages, ornamental, in landscape-gardening, 36.
- Country seats, in landscape-gardening, 35.
- Coutie, M., director of the botanic garden at Metz, 68.
- Covent Garden market, prices for January 17, 85; prices for beginning of March, 219; for the first and second week of May, 341; for June, 472; for September, 616; for November, 741; general observations, 742.
- Cow cabbage, figure and description of, by John Murray, Esq., 65.
- Cow cabbage, or Cesarean cole, on the culture of by Mr. Bernard Saunders, 440.
- Cowslip, extraordinary, 82.
- Cowslips, real double, answer to query on, by S. B. Ward, 238.
- Crinum amabile, 37.
- Crocuses, spring, the most remarkable cultivated in the garden of the Horticultural Society, by Jos. Sabine, Esq. F.R.S., 516.
- Cucumber, large one, 81; snake, 552.
- Cucumbers and melons, query on stopping in early forcing, 110.

- Cucumber-growers, challenge to, 92.  
 Cultivation of waste lands, 704.  
 Culture of fruit trees, a branch of education, 457.  
 Cummings, Mr., the gardener at Selwood Park, 570.  
 Curvilinear hot-house principle, whether it might not have been applied at Sion Gardens, 513.  
*Cycas revoluta*, 552.  
*Cyclamen europæum*, in full bloom, 613; *repandicum*, 613.  
 Dahlias (now Georginas), on the cultivation of, 142; double, query respecting, 239.  
 Daisy-rake, figured, 674.  
 Daisy-knife, figured and described, 595.  
 Dall, Mr. James, on the destruction of the mealy bug and scale on pine plants, 430; on the destruction of wasps, 428.  
 Dalley, Mr., maker of ornamental flower-pots, &c., 459.  
*Dammara orientalis* Lamb., 214.  
 Dancing, for the laborious classes, remarks on, 250; dancing and music among the labouring classes, critical remarks on, 722.  
 Davidson, Mr. Charles, obituary of, 112.  
 Davy Inn florist show, May 9, 358.  
 Day Lily as a forage plant, by Mr. J. Elles, 441.  
 Deas, Mr., gardener at Arundel Castle, 586; his house, 588.  
 Deepdene, views and description of, 590; only fault of, 593.  
 Denbighs, 595.  
 Denby House, 576.  
 Denmark, horticultural observations for, by M. Jens Peter Petersen, 547.  
 Détonnemare's nursery in Rouen, 376.  
 Development, human, principle of, 543.  
 Diabolic machine so called, for removing trees in boxes, figured and described, 377, 499.  
 Dieppe, 122; nursery of, 123; view of the country, agriculture, &c., between it and Rouen, 244, 245.  
 Dining-room, well contrived, 565.  
 Discussions, professional, 676.  
 Division of duties, 564.  
 Don, Mr. G., A.L.S., prosecution of, 534.  
 Donald, Mr., F.A.S., his nursery at Goldworth noticed, 572; his plan for drying corn, 598.  
 Donald and Westland's nursery, 589.  
 Downe's self-acting water-closet, 545.  
 Draining by steam, 660.  
 Drama, the, as a means of improving the laborious, 250.  
 Drawing-room, well arranged, 565.  
 Drawing, use of, 700.  
 Dressing-room, well provided, 565.  
 Dropmore, remarks on, 383, 727.  
 Drying of botanical specimens, hints with regard to, 391.  
 Dublin, a horticultural society in, 551.  
 Dubreuil, M., the director of the Rouen garden, 497; his wife, and son, 497.  
 Dung, heat of, transmitted by pipes, 670.  
 Echeveria from M. Echeveria, a skilful botanical painter, 519.  
 Edgeware road, improvements lately made in the, 558.  
 Edinburgh green market, June 26. and July 10, 461, 552, 662.  
 Education and amusement of the lower classes, remarks on, by William Spence, Esq. F.L.S., 125.  
 Education, general, remarks on, 223, 658; in Germany, 70; in Wurtemberg, 8; in Ireland, 338; in India, 549; in the Ionian Islands, 549; in Madagascar, 549; in the canton of Geneva, 656; in Savoy, 656; in Argovia, 657; plan for a national establishment for, 692; degree of, to be imparted, 693; universal national advantages of, 700; objections to, 701.  
 Eichthal, the Baron, 69.  
 Elles, Mr. J., recipe for dressing the roots of celeriac, 364; on the day lily as a forage plant, 441.  
 Elm, the Scotch, 677.  
 Elysium in Spain, 71.  
 Emigration, 174.  
 Enclosure act, 706.  
 Encyclopædia of gardening, corrections and additions for, 728.  
 Engravings and paintings as a means of instruction, 225.  
 Entrance or approach to a country mansion, &c. 37.  
 Entrance-hall, well arranged, 565.  
 Epson nursery, 470, 597; new or rare plants flowered there during March and April, 340; May and June, 470; during July and August, 613.  
 Errata in the paper on ornamental gardening, 97.  
 Errington, Mr. Robert, answer to query on the diseases in celery, 107; correction of the article on flowering mignonette during winter and spring, 97.  
 Errors by the Conductor, pointed out by Mr. John Damper Parks, 97.  
 Esrom Lake, 72.  
 Estates, models of, 213.  
 Existence, a mode of, for gardeners, 669.  
 Eulophia (from *eulophos*, well crested) streptopétala, figured and described, 518.  
 Exotics, attempts to acclimate, 331.  
 Exton Hall, 673.  
 Evil in the management of the Horticultural Society pointed out, 536.  
 Evils in Ireland, remedies for, 663.  
 Falconar, David, Esq., query on *Iridea*, 611; rare plants flowered in his garden at Carlourie, 664.  
 Falkirk school of arts, library of the, 556.  
 Farms, system of consolidating, effects of, in Scotland, 707.  
 Fanning, Mr. D., new plants introduced by, from the Caraccas, 661.  
 Fences in North America, critique respecting, by A. Gordon, 232.  
 Fenn, Mr. George, jun., cast-iron gardening pins with eyes, 460.  
 Ferme, John, Esq. curious instance of retarding gooseberries, 337; reference to a fuller account of the venerable orange-tree, 338; spots on leaves accounted for, 664; remarks on *Calla aethiópica*, 664.  
 Ferme ornée, in landscape-gardening, 35.  
 Ferns, cultivation of, by Mr. James Housman, 49; list of British, 51; list of exotic, 52.  
 Fête, anniversary of the Horticultural Society, 343, 467.  
 Fifeshire, education in, 662.  
 Figures, human, sketch of, 676.  
 Filbert, the frizzled, 316.  
 Fine arts, as a source of moral improvement, 668.  
 Fintelman, M. G. A., some account of the public orangeries, or winter gardens of Berlin, 251; on the culture of the *Hydrangea hortensis*, as practised in the Potsdam gardens, 273.  
 Firs, Balm of Gilead, in Kinnell Park, 103.  
 Flax-breaking machine, 326.  
 Fleetwood, Mr. Thomas, on the cultivation of the hyacinth, 426.  
 Fleming, Dr., strictures on Dr. Fleming's remarkable law of vegetable life, by Mr. Patrick Shirreff, 532.  
 Flitwick, the village of, 559.  
 Flitwick House, 559.  
 Flood, Mrs., of the Norfolk Arms, 585.  
 Floral Society of Ashton-under-Lyne, June 29., 493; of Stockport, June 30., 493.  
 Floral and Horticultural Societies:  
 Bolton, meeting of April 29., 361; June 1., 493; May 29., 494; Aug. 12., 636.  
 Bury, June 3., 476; June 30., 477.  
 Hull, meeting of Feb. 11., 220; July 7., 631.  
 Bedale, Aug. 15., 748.  
 Bedlington, meeting of May 11., 359; June 1., 487.  
 Cambridge, May 25., 475.  
 Dunfermline, June 2., 464: show of June 19;

- 556; two articles in the constitution of the, by D. Inglis, 618.
- Gateshead, June 1, 489.
- King Street, Newcastle, show of May 8., 359.
- Liverpool, show of April 30., 359; May 28., 492; July 31., 634.
- Manchester, 90; Aug. 3., 653; April 24., 361; May 29., and June 26., 490.
- Morpeth, show of May 7., 359; June 4., 489.
- Ripon, Aug. 15., 743.
- Stamfordham, June 1., 489.
- Wakefield, June 1., 487.
- York, May 26., 487; Aug. 11., 743.
- Flower-gardens, improvement of, by Mr. George M'Leish, 48.
- Flower Show of Wickham-market, Aug. 3., 743.
- Flower-stand, description of one designed and constructed for the Honourable Mrs. Fox, of St. Anne's Hill, by Mr. H. Tucker, 274.
- Flowers, baskets of, in regular groups, 566, 567.
- Flues, passage of hot air and smoke through, 208.
- Flue-stones hollowed at top, 679.
- Food of the lower classes, 657.
- Food, necessity of variety in, 667.
- Forcing flowers, more extensive in Germany than in England, 380.
- Forcing range at Sion, fine appearance of, 505; description of, 506; materials of which they are constructed, 509; manufacturers of, 513.
- Forest, pine, at Hagenau, 67.
- Forest trees, plan for transplanting, in parks, by Sir Charles Miles Lambert Monck, Bart. F.H.S., 174; on the natural succession of, in North America, 421.
- Forrest, Mr., F.L.S., improvements at Syon garden under the superintendance of, 502; his experience and abilities, 512.
- Fowler's patent thermosiphon, 453; remark concerning, by William Johns, M.D. F.L.S., 607.
- France, coal and iron in, 326; cultivation of maize in, 547.
- France and Germany, notes and reflections made during a tour through part of, in the autumn of 1828, by the Conductor, I. 113. 241. 369. 497. 641.
- Frankfort, public garden at, 203.
- Frankenville, residence of, 646.
- Fraser, Mr. Charles, C. M. H. S., catalogue of fruits cultivated in the government botanic garden at Sydney in New South Wales, 280.
- Fraser, Mr. John, on the culture of the double yellow rose, 142.
- Fraser, Mr., landscape-gardener, 84.
- Fredensborg, gardens of, 71.
- Fredericksborg, 73.
- Fremont le Jeune, account of his nursery in Rouen, 373.
- French, Mr. D., critical remarks respecting the humane mouse-trap, 724; contribution for the poor widows, and proposal for a gardeners' fund, 729.
- Frogmore, 383.
- Fruit, keeping, 184.
- Fruit, on the ripening of, by artificial heat, after being taken from the tree, by James Howison, Esq., 444.
- Fruit-border, on the improvement of a, by W. B. Rose, 144.
- Fruit, possibility of enlarging the size and hastening the maturity of, by Mr. Wm. Halcomb, 609.
- Fruits, catalogue of those cultivated in the government botanic garden at Sydney, in New South Wales, by Mr. Charles Fraser, C. M. H.S., 289.
- Fruit trees, query on an insect in, 237.
- Fruit trees, culture of, a branch of education, 457.
- Fűcsia micropńyila, in full bloom, 613.
- Fűcsia helmintochńrtos, figured and described, 313.
- Fulham nursery, visit to, 339.
- Fuller's seed-box for pheasants, 589.
- Gale, J., Esq., remarks on some gardens and country residences in Surrey, 9.
- Gardener's Magazine, rejection of, by the Horticultural Society, 86.
- Gardeners, neglected by the provincial horticultural societies, by Mr. James Rollins, 101; ought themselves to see that their houses are suitable, 562; fund for, proposed, by Mr. D. French, 729.
- Garden Memorandums, &c., 671.
- Garden and pleasure-ground, query on keeping in order, further data respecting, 728.
- Garden of the Horticultural Society at Chiswick, 380; a bad sample of English gardens, 536; queries concerning, 537.
- Gardens, public, as a means of educating the laborious classes, 249; about London, and in other parts of England, remarks on, by M. Jacob Rinz, jun., 379; for the poor, 55; parish, suggested 74.
- Gardens and gardeners of workhouses, suggestions respecting, 714.
- Garden engine and pump, Siebes' rotatory, 545.
- Gardening, rise and progress of in Bavaria, with a description of the Royal Nurseries at Munich and Weyhenstephan, by Mr. William Hinkert, 384; style of, in Portugal, very artificial, 413.
- Garden library, establishing in Denmark, by M. Jens Peter Petersen, C.M.H.S., 548.
- Geneva, education in the canton of, 656.
- Georginas, new varieties of, 613.
- Geraniums, fine show of at Bayswater, 460.
- Germany, general education in, 79; girls' schools in, 84.
- Germany and France, notes and reflections made during a tour through part of, in the autumn of 1828, by the Conductor, I. 113. 241. 369. 497. 641.
- Gűm chilońse, a new seedling variety of, 612.
- Girls' schools in Germany, 84.
- Glasses for catching flies, 679.
- Glazebrook, Thomas Kirkland, Esq., figure and description of a plant of the *Sűbal* Black-bűrnűia, now in the gardens of Hale Hall, Lancashire, 52.
- Goat, recommended as a milk-giving animal, 532.
- Godalming subscription school, 574.
- Goldworth nursery, 382. 572.
- Gorrie, Mr. Arch., C.M.H.S., plan of the kitchen garden at Annat, 28; an account of Scotch pears, 285.
- Gossier, the Abbű, account of his villa in Rouen, 500.
- Goodwood, 583.
- Gourd, huge one, 83.
- Gooseberry, on training, by Mr. William Wilson, 62.
- Gooseberries, curious instance of retarding, by John Ferme, 337.
- Gooseberry shows: Kirkgate, Aug. 6th, 627. Newark, Aug. 6th, 627. Radcliffe, Aug. 29th, 637.
- Gooseberries, prize, of 1828, record of, by M. Saul, 728; characters of the principal kinds described, 732.
- Gorse hedges, some observations on the rearing of, 270.
- Grafting of the mulberry in Germany, figured and described, 425.
- Grange, Mr. James, obituary of, 240.
- Grange conservatory, remarks on, 382.
- Grano marzuolo, 70.
- Grantham, 673.
- Grape, Muscat, of Tottenham Park, query respecting, 732; the Zante currant, query respecting, 733; the Money's West's Black St. Peter, 737.
- Grapes, on preserving, 96.
- Grapes and peaches, large crop of, in the same house, by John Merrick, gardener, 81.
- Gravel walks, on breaking stones in, 459.
- Gravel, want of, at Bretton Hall, 683.
- Grass rake, figure of one invented by Mr. Hislop, 597.



- Greenshields, Mr. William, upon pruning and managing dwarf standard apple and pear trees in a garden, 146.
- Grindstone, improved frame for a, 674.
- Groom, Mr. Henry, F.H.S., on a method of obtaining late flowers of ranunculuses, 293.
- Grotto at Ascot Place, 568.
- Grounds, plans for laying out, required, 234.
- Guard for trees, figured, 674.
- Guard for the face, while breaking stones, 678.
- Guildford Castle, 573.
- Gurré, a place in the neighbourhood of Elsinore, 71.
- Gymnasium at Bern, 657.
- Habránthus, from *habros* soft and delicate, *anthos*, a flower, 324.
- Hagenau, pine forest at, 67.
- Halcomb, William, Esq., on the possibility of enlarging the size and hastening the maturity of fruit, 609.
- Hamilton, W., Esq. M.D., on the timber trees abounding in the province of Choco, 44; on vines within the tropics, 98.
- Hampton Court, forcing-houses at, 381.
- Hargate garden vases, 589.
- Harrison, Mr., gardener, 577.
- Harvesting corn, objects to be attended to in, 599.
- Hatfield House, 672.
- Haverstock nursery, call at, 737.
- Haycroft, Mr. John, answer to the query on vines trained down from the rafters, 733.
- Haythorn's, Mr. J., remedy for the *Coccus ovatus*, 731.
- Hayward, Joseph, Esq., on the necessity and advantage of enquiring scientifically into the practices and results of horticulture, 394.
- Head gardeners, conduct of, towards journey-men, 101.
- Heaths, Cape, propagation of, 47.
- Heaths and ferns, prices of, by Mr. C. Lawrence, 731.
- Heating by steam diffused through a bed of stones, 450.
- Hedges of whins, query respecting, 730.
- Henderson, Mr., foreman to Mr. Calvert at Rouen, 371.
- Hepp, Madame, garden of, 69.
- Herbarium of M. Schleicher to be disposed of, 457.
- Hertford, the Marquess of, description of his villa residence in the Regent's Park, 464.
- Hertz, M. W., on vegetable physiology with a view to vegetable culture, 132.
- Hervey, Mr. John, obituary of, 750.
- Hinkert, Mr. William, historical notices of the rise and progress of gardening in Bavaria; with a description of the Royal Nurseries at Munich and Weyhenstephan, 384.
- Hints for breathing places for the metropolis, &c., on fixed principles, 686; for a plan for saving the manure lost in the common sewers of London, &c. 690; for prize questions, submitted to provincial horticultural societies, 713.
- Hislop, Mr., description and figure of his short grass rake, 597; criticism respecting Ashlead Park, 722.
- Hiver, Mr. Robert, on rendering pear trees, &c. fruitful, 60.
- Hoes, various, 654; excellence of the, 654.
- Holböhl, M., obituary of, 640.
- Holm Bush Lodge, 118.
- Honfleur melon, culture of, 241.
- Horne Tooke, 194.
- Horticultural chemistry, outlines of, by G. W. Johnson, Esq., II. 127. 404.
- Horticultural Association of Cirencester and Cotswold, September exhibition, 744.
- Horticultural Societies:
  - Aberdeenshire, meeting of Nov. 6th, 82; new members admitted, 83; shows of May 5th, 336; July 15th, 556.
  - Ayrshire, June 23d, 461.
  - Ayr and Kilmarnock, meetings of April 28th, and May 23d, 462.
  - Bedale, meeting of June 26th, 632.
  - Bury, meetings of Nov. 18th, 91; April 21st, 351; July 28th, 621; Sept. 8th, 746.
  - Bristol, meetings of June 23d, 478; Aug. 4th, 622; Sept. 16th, 747.
  - Caledonian, meetings of December 13th, Feb. 8th, and March 8th, 334; July 2d, 461; prizes awarded on July 2d, 552; meeting of Sept. 3d, 553; chairman's address, 554; Oct. 1st, 665.
  - Cambridgeshire, show of March 6th, 350; April 16th, 351; May 22d, 474; June 19th, 475; July 24th, 66; Sept. 17th, 742.
  - Chichester, meeting of Aug. 3d, 618.
  - Colchester and East Essex, meeting of Aug. 5th, 742.
  - Devon and Exeter, regulations of, &c. 494; meeting of September, 749.
  - Devonport, show of April 23d, 363.
  - Glamorgan and Monmouthshire, rules of, 92; meetings of April 1st, 363; July 1st, 639.
  - Gloucester, meetings of May 1, 352; May 29, 477; June 26th, 478; July 31st, 744.
  - Hereford, meetings of May 23, 482; June 26, 482; July 27th, 625; Sept. 29th, 745.
  - Herefordshire, meeting of May-day, 354.
  - Huntingdon, show of April 22d, 349.
  - Huntingdonshire, meeting of July 29th, 619.
  - Ipswich, meetings of Aug. 3d., 743; Sept. 15th, 743.
  - London, meetings of Oct. 21st, 85; Nov. 4th, and June 3d, 86; Nov. 18th, 216; Dec. 2d, 16th, Jan. 6th, 20th, and Feb. 3d., 217; Feb. 17th, March 3d and 17th, 218; April 7th and 21st, and May 5th., 342; May 19th, 343; June 2d and 16th, 466; July 7th, 467; fête at Chiswick, 467. 611; Aug. 18th, 612; Sept. 1st, 735; complaints against the, 468. 534. 536; remarks on the garden of the, 307. 380. 735.
  - Montrose, show of April 29th, 335; June 23d, 463.
  - Paris, meeting of, Dec. 17th, and Jan. 7th, 67.
  - Ripon, June 27th, 632; Sept. 11th, 747.
  - Ross, show of April 29th, 354; May 27th, 483; June 24th, 484; July 22d, 625; Sept. 30th, 745.
  - Vale of Evesham, show of Oct. 10th, 90; April 23d, 353; May 21st, 481; June 18th, 624; Sept. 24th, 744.
  - Windsor, challenge from, 92; show of June 26th, 477; July 22d, 622.
  - Worcester, show of April 27th, 353; May 1st, 352; May 26th, 479; June 17th, 481; Aug. 28th, 744.
  - Yorkshire, meeting of May 6th, 356; July 1st, 627; Aug. 5th, 630; Sept. 2d, 746; Sept. 23, 747.
- Horticultural Societies, reform of, 724; provincial, hints for prize questions, submitted to, 713.
- Horticulture, on the necessity and advantage of enquiring scientifically into practices and results of, by Joseph Hayward, Esq., 394; on the climate of the eastern and middle States of North America with reference to, by Mr. William Wilson, 409.
- Hot-beds, Mr. Knight's improvements in the construction of, 105.
- Hot water, system of heating by, in Germany, 457; recent improvements in heating by, by R. W. Rogers, 28. 260; as applied to heating hot-houses, 189. 212; heating hot-beds by, 213; query respecting heating by, 240; heating by, improvement in, by Mr. Weekes, 544.
- Hot-house, description of one combining a pinery, vinery, succession-pit, and winter green-house, all heated by one fire, by Abraham Caldicott, Esq. F.H.S., 418; metallic, remarks on, by Mr. George M'Leish, 416.
- House of Assembly in Jamaica, premiums offered by, in Dec. 1823, 212.
- Housman, Mr. James, on the cultivation of ferns, 49.

- Howison, James, Esq., on the ripening of fruit by artificial heat, after being taken from the tree, 444.
- Hyaacinth, on the cultivation of the, by Mr. Thomas Fleetwood, 426.
- Hyaacinths, query on growing in moist sand, 239; in pots, list of, 330.
- Hybrids between the turnip and wild mustard, query respecting, 611.
- Hyde Park and Kensington Gardens, 329.
- Hyde Park, improvement proposed respecting, 459.
- Hydrangea, gigantic, 82.
- Hydrangea hortensis, on the culture of, as practised in the Potsdam gardens, by M. G. A. Fintelmann, 273.
- Hypogymna dispar, 324.
- Hunter, Perceval, Esq., answer to query respecting *Tulipa Sibthorpiana*, 734.
- Hunting box, in landscape-gardening, 36.
- Hull, botanic garden of, 221.
- Human development, principle of, 543.
- Impostor, horticultural, at Sheffield, 215; from Paris, 459.
- Improvement of the people mentally, remarks on, 224.
- Independent Society of Florists at Heworth, June 6th, 489.
- India, education in, 549.
- Indian corn, 106, 617; from New York, 211.
- Infant schools, 225, 694.
- Inglis, Mr. D.; two articles in the constitution of the Dumfermline Florists' Society, 618.
- Inns ought, as much as possible, to create an allusion to home, 558; of England and the Continent compared, 673.
- Inoculation on the Russian transparent crab, queries respecting, 722.
- Insect in fruit trees, query on, 237; destructive one, 480.
- Insects injurious in horticulture, 324.
- Involucrum, application of the term, 543.
- Ionian Islands, Lancasterian schools in, 549.
- Ireland, increase of schools in, 84; agriculture of, 179; education in, 338; evils in, remedies for, 666.
- Irídeæ, query respecting, by Mr. David Falconar, 611.
- Irrit and coal in France, 326.
- Islay, hot-house in, lately erected, 663.
- Jagersborg Park, 72.
- Jamaica Society for the encouragement of Arts and Agriculture, proceedings of, Nov. 11th, 77; April 14th, 458.
- Jet d'eau at Mr. Knight's nursery, 338.
- Johns, William, Esq. M.D. F.L.S., remarks concerning Fowler's therosiphon, and Brown's gas engine, 607.
- Journeymen, conduct of some master gardeners to their, 18; conduct of head gardeners to, 101.
- Kennedy, L., Esq., his opinion on benefiting the poor, 540.
- Kensington gardens, remarks concerning, 329.
- Kew gardens, 380.
- Kings, British, their example not of much consequence in gardening affairs, 563.
- King, Lord, estate of, 10.
- Kinnell Park, Balm of Gilead firs in, 103.
- Kitchen, well contrived, 564.
- Kitchen-garden, &c., answer to query on keeping in order, 108.
- Knapp Hill nursery, 571.
- Knight, Thomas Andrew, Esq. F.R.S. &c., considered as a cultivator, 87; on the culture of the potato, 294; on the cultivation of the pine apple, 296; correction of erroneous statements respecting his communications to the Horticultural Society, 364; defended, 465; observations on his experiments on the potato, 609; remarks respecting his pines, by Mr. Mearns, 716, 717; by Mr. Pearson, 717; statements respecting his culture of the potato, 718 to 722.
- Knight's exotic nursery, visit to, 338.
- Knowledge, general, importance of, 601.
- Labels for fruit rooms, &c., 683.
- Labour, division of, 564.
- Labourer, definition of the word, 69.
- Labouring classes, condition of the, 706.
- Laborious classes, criticism respecting music and dancing among, 723.
- La Fayette, General, his agricultural improvements at La Grange, 208.
- La Grange, agricultural improvements at, 268.
- Landin, residence of, 644.
- Landscape-gardening as a part of the study and business of practical gardeners, 30; concluded, 264.
- Lang, Mr. Joseph, on the culture of the pineapple without pots, in the royal kitchen-gardens at Nymphenburg, 427.
- Latch for gates, an improved, 683.
- Lawrence, Mr. C., good apple trees for an orchard, 731; prices of heaths and ferns, 731; growth of broccoli, &c., 732.
- Laws, numerous, the result of ignorance, 715.
- Lea House, near Godalming, 574.
- Leaves, spots on, accounted for, by John Ferme, Esq., 664.
- Leaves, rationale for stripping off wall trees, 739.
- Leek, grown in great perfection in Rouen, 371.
- Lemons and oranges, 213.
- Levers, bent, improved principle of, in agricultural implements, explained, 655.
- Liberality of Messrs. Young of Epsom, 598.
- Libraries, provincial horticultural, 94; remarks on the East Lothian itinerating ones, by Samuel Brown, 95; agricultural, 228.
- Life, vegetable, remarkable law of, 176.
- Lilac, the hybrid, where raised, 498.
- Lime-burning, 176.
- Lindgaard, Peter, Esq. C.M.H.S., on straw or reed mats as a covering for hot-houses and hot-beds, 414.
- Lindley, Professor, his introductory lecture on botany, 328.
- Lisbon botanic garden, some account of, by W. Churchill, Esq., Royal Marines, 412.
- Lysimachia longifolia, figured and described, 310.
- Liverpool botanic garden, remarks on, 383.
- Loddiges's establishment, 308, 379.
- London University, and the lecture on botany delivered there, 328.
- London nurseries, 220; in July, 469.
- Longleat, garden at, figured, 194.
- Loudon's Howe and Loudon's Brae, 663.
- Lupinus, new species of, 613.
- Machine for breaking flax, 326; for moving large orange trees, figured and described, 377; for transplanting large trees, notice of one, by Mr. Bennet, C.M.H.S., 422.
- Mackenzie, Sir George Stuart, Bart. F.R.S. &c., on a simplified method of marking numbers on tallies, 145; an account of some varieties of apple, &c., 285; on the cultivation of the strawberry, 286.
- Madagascar, general education in, 549.
- Magnolia sinuata, query respecting, 239.
- Mahogany, first discovery of its beauty, 304; season for cutting, 304.
- Mailleraie, Château du, 643; village of, 644.
- Maize, 179; cultivation of, in France, 547; see Indian corn.
- Malcolm's nursery, call at, 339.
- Malartie, M. la Comtesse, description of her mansion, &c., 247.
- Mammoth gourd, 679.
- Manners on the Continent, 7.
- Manor house, in landscape-gardening, 36; old, figured, 675.
- Mansions castellated, with respect to landscape-gardening, 33.
- Manure, liquid, in Switzerland, 548; in Holland, &c., 549.
- Manure lost in the common sewers, hints for a plan for saving, &c., 690.
- Márica Northiana, flowered by Mr. Robert Reid, 661.
- Mary-la-bonne nursery, call at, 339.

- Master gardeners, conduct of some, to their journeymen, 18.
- Masters and servants, 649.
- Mats of straw or reed as a covering for hot-houses and hot-beds, by Peter Lindegaard, Esq. C. M. H. S., 414.
- Maupoil's nursery in Dolo, 458.
- Mausoleum, the, seen from Greasborough, 679.
- Mealy bug and white scale on pine plants, on destroying, by Mr. W. M. Murtrie, C. M. H. S., 57; by Mr. James Dall, 430.
- Mearns, Mr. John, F. H. S., remarks on Mr. Knight's pines, 716, 717.
- Measure for filling sacks, figured, 674.
- Melons and pine-apples produced by steam, 83.
- Melons at Petworth House, 578.
- Menagery, the king's, 568.
- Méridien à détonation, 642.
- Metallic hot-houses, remarks on, by Mr. George M'Leish, 416.
- Methley's fire-places, 238.
- Merrick, John, gardener, on a large crop of grapes and peaches in the same house, 81.
- Metzger, M., upon the influence of rocks on the prosperity of vine plants, and on the quality of their produce, 436.
- Mexico, vegetation in, 658.
- Mezereon as a conservatory plant, 239.
- Miasmata in a conservatory, correction of, by John Murray, Esq., 65.
- Michel Grove, near Arundel, 588.
- Midhurst Cottage, 581.
- Mignonette, correction in the article on flowering it during winter and spring, by Mr. Robert Errington, 97.
- Mildew curable, 107.
- Milton Bryant Rectory, 564.
- Mills, Miss Elizabeth, teacher in the school at Godalming, 574.
- M'Leish, Mr. Alexander, obituary of, 112; Mr. George, observations on the improvement of flower-gardens, 48; remarks on metallic hot-houses, 416.
- Models of estates, 213.
- Mogridge, John H., Esq., on the laying out and planting of burying grounds, 26.
- Mole cricket, new process for destroying, 203; figured, 203.
- Monck, Sir Charles Miles Lambert, a plan for transplanting large forest trees in parks, 147.
- Money, Mr., F. H. S., his excellent grape, an account of his practices, and improved watering pot, &c., 737 to 740.
- Monolifera, *fero*, to bear, and *monile*, a bracelet, criticisms on this etymology, 104.
- Morrey, Mr. Arthur, gardener at Stroud House, 575.
- Moss soil, crops on, 83.
- Mould, Mr. F., on introducing heated air into cucumber frames and pits, 433.
- Mouse-trap, humane one, by Mr. James Rollins, 109; critical remarks respecting the, by Mr. D. French, 725.
- Mulberry, certain and expeditious method of raising, 63; the United States, 78; method of cultivating the, in the government mulberry plantations at Nymphenburg, with a list of the species and varieties grown there, by M. Bischof, 424; plantation near Cork, abandoned, 667.
- Munich, landscape-gardening at, 210; university of, 326; Royal Nursery at, description of, 385.
- M'Murtrie, Mr. W., F. H. S., on destroying the mealy bug and white scale on pine plants, 57; on the liberties taken by Agronomie, 98; critique respecting the Anson or Otaheite Pine, 607.
- Mushrooms, on raising, and on the forcing of rhubarb stalks in the open air, by Mr. James Stuart, 443.
- Murray, John, Esq., F. L. S. A. S. &c., figure and description of the cow-cabbage, 64; on the correction of miasmata in a conservatory, 65; on planting an onion near a rose to increase its odour, 66; Cobbett not the first who raised the Indian corn, 106; on the everlasting potato 107.
- Museums, parochial, as a means of educating the feelings of the laborious classes, 248.
- Music, as a means of educating the laborious classes, 250.
- Music and dancing among labourers, critical remarks on, 723.
- Mutisia ilicifolia, figured and described, 304.
- Myrtle, sweet, gigantic one, 83.
- Names, botanic, rules for pronouncing, 232; systematic, use of, 650.
- Natural history, use of, 700.
- Natural system of plants, a great advantage of, 497.
- Navet and Cape Broccoli, query on the time of sowing, 611.
- Neatness, English gardener superior to the French in, 502.
- Nectarine, the Violet, 315; Elruge, largest in England, 582.
- Nepenthes distillatoria, 337.
- Nitre, as a manure, 176.
- Northumberland, Duke of, some account of his improvements in the garden at Syon, 502.
- Nuremberg, soil in the neighbourhood of, 69.
- Nurseries of London, 220, 379.
- Oak, query on the cultivation of, 239.
- Oak coppice, insects on, query respecting, by Mr. John Owen, 610.
- Obituary of Mr. C. Davidson, Mr. A. M'Leish, and M. Bosc, 112; of Thos. Tredgold, Esq., Mr. Jas. Grange, Mr. Jas. Astin, Thos. Weare, Esq., and W. Stevenson, Esq., 240; of Mr. Francis Channer, 496; of M. Holböll, 640; and of Mr. John Hervey, 750.
- Objections to a national education establishment, 701.
- Occupation, benefit derived from, 543.
- Onion planted near a rose to increase its odour, by John Murray, Esq., 66.
- Onslow, Lord, seat of at Clondon, 11.
- Oranges and lemons, 213.
- Orange tree, venerable, reference to a fuller account, 338.
- Orange trees, successful mode of propagating in Rouen, 375.
- Oriental garden at Brighton, 119.
- Otaheite pine, origin of corrected, 103; introduction of, by Mr. C. F. Webster, 466.
- Owen, Mr. John, query on some insects infesting an oak coppice, 610.
- Oxford, botanical garden at, 306.
- Oxnead Hall, figured, 193.
- Pain's Hill, vineyard at, 9.
- Paintings and engravings as a means of instruction, 225.
- Palace, royal, with reference to landscape-gardening, 32; episcopal, with reference to landscape-gardening, 33.
- Palermo, botanic garden at, 657.
- Palmyra of Jaffna, figured and described, 77.
- Parents, obligation of, to send their children to school, 698; answer to the objections to, 702.
- Paris, state of the season at, 326; state of vegetation in, for June, 456, 457; botany among the common people in, 546.
- Parish gardens, suggested, 714.
- Parochial institutions; or outline of a plan for a national education establishment, 692.
- Parks, Mr. John Damper, F. H. S., errors by the Conductor pointed out, 97; on the proper management of plants during their voyage from China to England, 293, 572.
- Parker, Thos. N., Esq., on the destruction of wasps, 277.
- Parks, English, remark on, 381.
- Parson's flower-garden at Brighton, 121.
- Passé, meaning of the term as applied to fruits, 68.
- Patents, infringements on, by rich manufacturers, 545.
- Paving, improved plan of, figured and described, 79.
- Peach, the Royal, 316.

- Peaches and grapes, large crop of, in the same house, by John Merrick, gardener, 81.
- Pear, the Gilgill, 315; the Princess of Orange, 316; the Seckle, the Grey Douyenne, the Napoleon, and the Duchess of Angoulême, 316; the Easter Beurrée, 450; the Beurrée d'Aremberg, 529; the Beurrée Rance, 530.
- Pears, Scotch, an account of, by Mr. A. Gorrie, C.M.H.S., 285.
- Pears and apples, select list of required, 111.
- Pear trees, &c., on rendering fruitful, by operating on the borders, and by natural training, by Mr. Robert Hiver, 60.
- Pearson, Mr. John, remarks on Mr. Knight's pines, 717.
- Pentstemon, new species of, 613.
- Pentstemon atropurpurea, figured and described, 310.
- Penny, Mr., A. L. S., 598.
- Perry, Mr. John, on the introduction of the *Verbena Melindris*, 106.
- Perry, J., Esq., view of Midhurst cottage, 581.
- Perry, the Misses, 575.
- Pestalozzi's system of education, 225.
- Petersen, M. Jens Peter, C.M.C.H.S., horticultural observations, 547; garden library establishing by, 548.
- Petworth House, 576.
- Philosophy, false, in agriculture, pointed out, by Mr. Ayton, 531.
- Phlox, answer to query on the genus, 109.
- Phorrmium ténax, 84.
- Physiological botany, account of some experiments in, undertaken with a view to ascertain the probable cause of failure in early forced grapes, by Mr. Joseph Thompson, 253; an essay in continuation of, 257.
- Pike, Mr. Henry, an effectual mode of destroying slugs among cauliflowers and cabbages, 143.
- Pin de Bordeaux, 642.
- Pine, the Frankincense, query respecting, 731.
- Pine, Anson or Otaheite, critique respecting, by W. M'Murtrie, 231; introduction of, by Mr. C. F. Webster, 466; critique respecting, by Mr. W. M'Murtrie, 607.
- Pine-apple, on the cultivation of the, by Thomas Andrew Knight, Esq. F.R.S. &c. President, 296; on the culture of without pots, in the royal kitchen-gardens at Nymphenburg, by Mr. Joseph Lang, 427.
- Pine-apples grown in common dung hot-beds, 464.
- Pine-apples and melons produced by steam, 83.
- Pine plants, on the destruction of the mealy bug and scale on, by Mr. James Dall, 430.
- Pines of Mr. Knight, remarks respecting, by Mr. Mearns, 716, 717; by Mr. Pearson, 717.
- Pinol, the name of a variety of grape, 69.
- Pinus spectabilis* of Nepal, 215.
- Pinus Cembra*, figured and described, 231.
- Pinus Pinea*, figured and described, 230.
- Pipes for hot-water, price of, corrected, 107.
- Plants, on discovering the anatomy of, by nitric acid, 68; on the proper management of, during their voyage from China to England, by Mr. John Dampier Parks, F.H.S., 293; for rock-work, 239; exotic, attempts to acclimate, 331; alpine, for sale or exchange, 332; new, flowered in the Epsom nursery during July and August, 613; green-house, trials of in the open air, 669; systematic arrangements of, plans for hinted, 670; in pots, objectionable in the country 672.
- Plough, 179; Mr. Finlayson's skeleton, 651; Wilkie's, for diminishing friction, 652; the pressing, figured and described, 677.
- Pomological Magazine, critique on its appellation, 103.
- Pomona Britannica* of Brookshaw, query respecting, 111.
- Poor, labouring, on bettering the condition of, 79; gardens for, the 551.
- Poor laws, system of, 706.
- Poore, Sir Edward, Bart. F.H.S., observations on the cultivation of stove plants, 293.
- Portuguese style of gardening very artificial, 413.
- Potato, on the culture of, by Thomas Andrew Knight, Esq. F. R. S. &c. President, 294; statement respecting the culture of, by Mr. Knight, 718 to 722; on the everlasting, by J. Murray, Esq., 107.
- Pots without holes in the bottom, query respecting, 732.
- Potsdam, weather, &c., at, 210.
- Prejudice, tendency of gardeners to, 15.
- Preston Institution for the Diffusion of Knowledge, 659.
- Prevost, M., fils, account of his garden, &c., in Rouen, 372.
- Prize questions, hints for, 713.
- Prince, Mr., of the Linnean botanic garden near New York, fruit trees received from, 211.
- Priorities, with respect to landscape-gardening, 33.
- Professions, the result of ignorance, 647.
- Prosperity, conservative tendency of, 543.
- Pugh, Mr., his villa in Rouen, 499.
- Questions for prizes, hints for, 713.
- Queville, Château de, description of, 641.
- Racine, M., fils, his method of cultivating the Honfleur melon, 141; account of his nursery, 123.
- Radeport, Château de, 647.
- Railing, handsome Gothic, 680.
- Railways, introduction of, contemplated, 686.
- Raja Pakse, description and figure of, 75.
- Ranunculuses, on a method of obtaining late flowers of, by Mr. Henry Groom, F.H.S., 293.
- Ranunculus show of Wallingford, June 10., 744.
- Reaping machine, by Mr. Peter Bell, 600.
- Reid, Mr. Robert, flowered *Márica Northiana*, 661.
- Reider, M., 69.
- Renard's market-garden in Rouen, 372.
- Rhubarb leaf, large one, 81.
- Rhubarb plant, leaf of a hybrid one, by the Rev. W. T. Bree, 81.
- Rhubarb stalks, on forcing, in the open air, 444.
- Rice paper, some account of, 309.
- Ridges of roofs covered with stone, 677.
- Rinz, M. Jacob, jun., remarks on various gardens about London, and in other parts of England, visited in April and May, 1829.
- Ripening of fruit by artificial heat, after being taken from the tree, by James Howison, Esq., 444.
- Rivière, T. R., Esq., on a winter garden, 23.
- Roads, on planting with fruit trees, 115; improvements suggested for, 116; of England and the Continent compared, 113.
- Rocks, influence of, on the prosperity of vine plants, and upon the quality of their produce, by M. Metzger, 436.
- Rockwork, plants for, 239.
- Roberts, Mr., description of an ornamental conservatory, in the Grecian style of architecture, to be disposed of, 268.
- Robertson, Mr. John, F.H.S., an account of the manner of training the vine upon open walls, at Thomery, near Fontainebleau, 286.
- Rogers's flower-garden at Brighton, 121.
- Rollins, Mr. James, on the neglect of practical gardeners by the provincial horticultural societies, 101; on an improved mode of cultivating the *Calceolaria corymbosa*, 272; personal notice respecting 213.
- Ronalds, Miss Elizabeth, her beautiful drawings of fruit, 736.
- Ronalds, Mr., F.H.S., his nursery and collection of apples, 736.
- Roots, plants cultivated for their, 176.
- Rose, double yellow, on the culture of, by Mr. John Fraser, 142.
- Roses, standard, cast-iron stakes for, 332.
- Rouen, remarks on the approach to, 370; botanic garden of, 497; the principal public garden of, 498; Agricultural Society of, 501.
- Rouvroy, M. de, figure' and description of his kitchen garden, 204.
- Sabal Blackburnia*, figure and description of a

- plant of, now in the gardens at Hale Hall, Lancashire, by Thomas Kirkland Glazebrook, Esq., 52.
- Sabine, Joseph, Esq. F.R.S., the most remarkable of the spring crocuses in the garden of the Horticultural Society, 516.
- Sacks of corn, iron frame for weighing, figured, 674.
- Saffron in England, 460.
- Salubrity of high and dry situations, 547.
- Sálvia splendens*, new variety of, figured, 577.
- Sandpit Gate in Windsor Forest, 568.
- Saul, Mr., record of the prize gooseberries of 1828, 728.
- Saunders, Mr. Bernard, on the culture of the cow cabbage, or Cesarean cole, 440.
- Savoureux, M., his nursery and flower-garden, &c., in Rouen, 378.
- Savoy, education in, 656.
- Scarthing Moor, inn at, 675.
- Schleicher, M., his herbarium to be disposed of, 457.
- Schools in Ireland, increase of, 84.
- Schools of Agriculture, practical, 337.
- Schools, Gaelic, in the Highlands and Islands of Scotland, 338.
- Schools, maritime, in Sweden, 548.
- Schools, to be established universally, suggestions for, 696; obligations of the local police respecting, 699.
- Schultes's botanical visit to England, 305.
- Scotch pine, on the, by Agronome, 139.
- Scotch pine and larch, premiums offered for raising from foreign seeds, 336.
- Scraper to the pressing plough, figured and described, 677.
- Sea air, effects of, query respecting, 730.
- Seas, artificial, on forming in ornamental landscape, 137.
- Seat, garden, made of straw, 594.
- Seats for gardens, convenient, 682.
- Seats, country, with respect to landscape-gardening, 35.
- Seeds, genuine agricultural, on the propagation of, 179; American, received from New York, 212; alpine, for sale or exchange, 332; of rhubarb and sea-kale, for the Horticultural Society of Pennsylvania, 550.
- Selwood Park, 570.
- Sepulchre, a metropolitan, 214.
- Servants and masters, 649.
- Shades for the forcing-pits at Syon, figured and described, 510.
- Sheaves of corn, mode of setting up, figured and described, 458.
- Shed, pleasing effect of one, 676.
- Sheffield, horticultural impostor at, 215.
- Shetland Isles, gardening in, 663.
- Shirreff, Mr. Patrick, strictures on Dr. Fleming's remarkable law of vegetable life, 532.
- Show places, suggestion respecting the payments given at, 561.
- Shrubs, transplanting in full growth, 208; covering for, of wicker-work, 681; American, treatment of, in the Goldworth nursery, by Mr. Donald, F.H.S., 143.
- Sicily, hedges in, 658.
- Siebe's rotatory garden engine and pump, 545.
- Silesia, education in, 326.
- Silk, growth and manufacture of, 658.
- Siphon, circulation of, hot water in, exemplified, 453.
- Sisymbrium indicum*, query respecting, 733.
- Skerrat, Mr. John, gardener at Milton Bryant Rectory, 564.
- Slugs, an effectual mode of destroying among cauliflowers and cabbages, by Mr. Henry Pike, 143; on destroying by lime water in preference to chopped straw, by Mr. W. P. Vaughan, 440.
- Sluice, on a new one for regulating the rise and fall of the tide in artificial seas, 137.
- Smith, the late Mr. William, biography of, 495.
- Snag-pruning of trees, 664.
- Societies, practical cooperative, as a means of ameliorating the condition of the laborious classes, 387.
- Soils, analysis of, 404; very tenacious, ploughing and digging, 651.
- Song of the Hungarian gardener, 326.
- Soude, the, figured and described, 655.
- Spade-forks, two-pronged, 134.
- Spades, varieties of, for peculiar soils, 652.
- Spain, elysium in, 71.
- Spence, William, Esq. F.L.S., &c. remarks on the education and amusement of the lower classes, 125.
- Spinage, New Zealand, 80. 680.
- Spring Grove, 564.
- Squib, Mr., query on his mode of pruning the vine, 733.
- Stachys palústris*, an esculent vegetable, 546.
- Staircase, well arranged, 565.
- Stakes of cast iron for standard roses, 332.
- Stamford, 673.
- Standard apple and pear trees, dwarf, upon pruning and managing by Mr. William Green-shields, 146.
- St. Anne's Hill, remarks on, 382.
- Steam, heating by, 188; diffused through a bed of stones as a means of heating pine pits, 450; applied to tillage, remarks on, by Mr. James Wilkie, 655; draining by, 660.
- Steam carriages, and their influence on improvement, 684.
- Stephenson, William, Esq., obituary of, 240.
- Stone, artificial, 82.
- Stones, steam diffused through a bed of, as a means of heating pine pits, 450; on breaking in gravel walks, by Mr. W. Anderson, 459; machine for breaking, 678.
- Stone pine, critique respecting, 230.
- Stove, handsome domical, 680.
- Stove plants, observations on the cultivation of, by Sir Edward Poore, Bart. F.H.S., 293.
- Strawberry, on the cultivation of, by Sir George Steuart Mackenzie, Bart. F.H.S., 286; the Keen's seedling, 530; Wilmot's superb, query respecting, and answer, 610; large, 552.
- Strawberry beds, 183.
- Strawberry wall, a plan for a, by Robert Byers, Esq., 437.
- Strawberries, two new ones, 216; grown in Mr. Knight's manner, 680.
- Straw garden seat, 594.
- Street, Samuel Spyvee, Esq., upon a mode of covering the naked branches of fruit trees with new wood, 516.
- Strelitzia regina*, query respecting, 239.
- Strong, B. W., Esq., on the culture of the sweet potato, as practised in the neighbourhood of New York, 275.
- Stroud house, 574.
- Stuart, Mr. James, on the raising of mushroom, and on the forcing of rhubarb stalks in the open air, 443.
- Succession, natural, of forest trees in North America, 421.
- Sugar in Florida, 78.
- Sugar from the beet root, 325.
- Surrey, on some gardens and country residences in, by J. Gale, Esq., 9.
- Swan river, new settlement on the, 327.
- Sweden, maritime schools in, 548.
- Sweet, Mr. R., F.L.S. &c., plagiarism, by the author of the article signed "A Blooming Bulb," 105; and, a Blooming Bulb, remarks on, by T. S. Alcock, 229; notice respecting *Brunsvigia Josephinæ*, 332.
- Sweet potato, on the culture of, by B. W. Strong, Esq., 275.
- Sweet's Hortus Britannicus*, critical suggestions respecting, 722.
- Switzerland, liquid manure in, 548.
- Syon, some account of the improvements in the garden at, 502.
- Systematic names, use of, 650.
- Tailly, Château du, 643.
- Talipot tree, 76; use of the leaves, 77.
- Tally, notice of a durable one of earthenware,

- by Mr. William Anderson, F.L.S. H.S. &c., 263.
- Tallies, a simplified method of marking numbers on, by Sir George Stewart Mackenzie, Bart. F.H.S., 145.
- Taste in furniture, &c., 569.
- Teachers, suggestions respecting, 627.
- Thermometer, improvement in Bregazzi's bark bed one, 213; self-registering one, 213.
- Thermosiphon of Mr. Fowler, 453; remark concerning, by William Johns, M.D. F.L.S., 607.
- Thompson, Mr. Joseph, an account of some experiments in physiological botany, undertaken with a view to ascertain the probable cause of failure in early forced grapes, 253; an essay in continuation of, 237.
- Thorn hedges, on a method of facilitating the growth of, on high and exposed situations, by Mr. D. Anderson, 42.
- Tiles, draining, 677.
- Timber, to render unflammable, 69.
- Time, on the judicious division and employment of, especially addressed to young gardeners, 135.
- Tobacco, growth of, 216.
- Tôtes, remarks made at, 247.
- Tour through part of France and Germany, notes and reflections made during a, in the autumn of 1828, by the Conductor, 1. 113. 241. 369. 497. 641.
- Toward, Mr., his dwelling-house at Bagshot Park condemned, 571.
- Training fruit trees *en pyramide*, observations on, 373.
- Travelling, benefit to be derived from, 2.
- Tredgold, Thomas, Esq., obituary of, 240.
- Tree cabbage, 460.
- Trees, beautiful, in landscape-gardening, 265; picturesque, 266.
- Trêfle farouche, queries respecting, 734.
- Trellises, 582.
- Trellis-work, a handsome arcade of, 682.
- Trianon nursery, belonging to Mr. Calvert, in Rouen, account of, 374.
- Trifolium *Molinèri*, 734.
- Tuberoses, very double Italian, query respecting, 239.
- Tucker, Mr. H., description of a flower-stand, designed and constructed for the Honourable Mrs. Fox, of St. Anne's Hill, 274.
- Tùtipa Sibthorpiàna*, answer to query respecting by Perceval Hunter, Esq., 734.
- Turnip, large one, 83.
- Union Florists of, Bishopswearmouth and its vicinity show of, for May, 359; June 8th, 489; June 29th, 493.
- Union Florists of Sunderland, show of June 7th, 490.
- Uva passa, origin of the term, 68.
- Vallais, the, 657.
- Vallet, M., his nursery in Rouen, 376; diable for removing orange boxes, 499;
- Vases for gardens, 661; lead, for containing flower-pots, 683.
- Vaughan, Mr. W. P., on destroying slugs by lime water in preference to chopped straw, 440.
- Vegetable physiology, with a view to vegetable culture, by M. W. Hertz, 132.
- Vegetable and Florists' Society of Howdon Dock, show of May 9th, 358.
- Vegetables, on condensing and preserving, 95; culinary, to make tender, 667.
- Verbena chamædryfolia*, 612.
- Verbena Melinèris*, by whom introduced, by John Perry, 106; critique respecting, 229.
- Verjuice, to prepare for bottling and keeping, 668.
- Vestries of parishes, obligations of, respecting schools, 699.
- Villa, account of a small one near Quevilly, 501; design for, with a plan and elevation, 541; rural, in landscape-gardening, 36.
- Villas, town, 36; of England, Scotland, and France compared, 646.
- Village of Mailletraie, 644.
- Village library at Carcolston, 95.
- Village libraries, East Lothian itinerating juvenile, 226.
- Vine, an account of the manner of training the, upon open walls, at Thomery, near Fontainebleau, by Mr. John Robertson, F.H.S., 286; black cluster, 665. See Grape.
- Vine plants, upon the influence of rocks on the prosperity of, and upon the quality of their produce, 436.
- Vines in the open air, 96; within the tropics, by W. Hamilton, Esq. M.D., 98; query on, when trained down from the rafters, 110; query on training down from the rafters, 239; trained from the rafters, answer to the query respecting, by Mr. John Haycroft, 733; for a green-house, query respecting, 733.
- Violet, Russian, query respecting, 611.
- Wages of gardeners, discussion on, 100.
- Walker, —, Esq., late proprietor of Michel Grove, circumstance respecting, 588.
- Walton, remarks on, 381.
- Warsaw, letter from, 458.
- Wasps, on the destruction of, by T. N. Parker, Esq., 277; the most effectual mode of destroying, 332; on the destruction of, by Mr. James Dall, 438.
- Waste lands, cultivation of, 704.
- Water, soft, plan for collecting, 740.
- Water-closet, Downe's self-acting, 545.
- Water-melon, sugar made from, 658.
- Waterman's nursery, remarks on, 382. 571.
- Watering pot, improved, 740.
- Watering, system of, at Syon, 504.
- Weare, Thomas, Esq., obituary of, 240.
- Weather, prognostics of, 78.
- Webster's, Mr. C. F., introduction of the Otahite pine, 466.
- Weeding under and above the economic point explained, 372.
- Weekes, Mr., improvement in heating by hot water, 544.
- Wells, Artesian (*i. e.* invented in the county of Artois), 551.
- Wentworth House, 679.
- West, Counsellor, remark on his hot-house near Dublin, 338.
- Westdean House, 581.
- Westland, Mr., nurseryman, 589.
- Weyhenstephan, royal central fruit tree nursery at, 386.
- Wheat, insect which attacks the ear of, 177.
- Whin, as a hedge plant, 43.
- Whin hedges, query respecting, 730.
- White Knights, remarks on, 383.
- Whitlaw, Mr., query as to his hemp, 733.
- Whitmore Lodge, 564, 722.
- Whitton House, near Hounslow, 94.
- Whitton Park, near Hounslow, 94.
- Wick House, 93.
- Wilkie's plough for diminishing friction, 652; his wheel plough, improvements on, 653; his brake or cultivator, 653, improvements in, 654.
- Windsor Castle, improvements at, 604.
- Williams, Mr. Richard, an account of an easy method of destroying caterpillars on gooseberry bushes, 294.
- Wilson, Mr. William, on training the gooseberry, 62.
- Wilson, Mr. William, of New York, on the climate of the eastern and middle States of North America, with reference to horticulture, 409.
- Wines, superior gooseberry and currant, French method of making, 364.
- Wingfield Spa in Windsor Forest, 567.
- Winter, Mr. Joseph, answer to queries, on, 109.
- Winter garden described, by T. R. Rivère, Esq., 23.
- Wire-worm, query respecting a remedy for the, and answer, 610.
- Woburn Abbey, iron hot-houses at, 213; notice of, 560; beauties of, 561; defects of, 562.
- Wood-lice, answer to query on destroying, 238.

Woods, Mr., gardener at Deepdene, 591.  
*Woodwardia radicans*, critique respecting, 233.  
 Workhouse gardens and gardeners, suggestions respecting, 714.

Wurtemberg and its environs, 69; state of education in, 8.  
 Yaldwin, Mrs., of Blackdown House, 580.  
 Young's nursery at Epsom, 597.

---

## CALENDARIAL INDEX.

*January.* — Manufacture straw or reed Mats in weather unfit for working out of doors, 414; prepare for destroying the insects on Pine plants, 430.

*February.* — Strike Cape Heaths, 47; plant the Sweet Potato (*Convolvulus Batatas*), 275; plant Ranunculuses for blooming in May, 293.

*March.* — Strike Cape Heaths, 47; plant Georginas, 142; sow the Honfleur Melon, 241; plant the Sweet Potato (*Convolvulus Batatas*), 275; select and plant Cuttings and Vines, 288; plant Ranunculuses for blooming in June, 293; turn Pine-apples out of the pots, agreeably to the wild mode of culture, 427; direct attention to the collecting of Wasps, 438.

*April.* — Strike Cape Heaths, 47; sow the seeds of *Ulex europæus* for hedges, 270; plant the Sweet Potato (*Convolvulus Batatas*), 275; plant Ranunculuses for blooming in July, 293; graft Mulberries in the flute manner, 425; direct attention to the collecting of Wasps, 438.

*May.* — Strike Cape Heaths, 47; sow the seeds of *Ulex europæus* for hedges, 270; plant Ranunculuses for blooming in August, 293; sow Mulberry seeds, 424; direct attention to the collecting of Wasps, 438.

*June.* — Strike Cape Heaths, 47; strike cuttings of *Calceolaria corymbosa*, 272; direct attention to the collecting of Wasps, 438.

*July.* — Strike Cape Heaths, 47; plant Ranunculuses to bloom in September or October, 293; shorten the shoots of the Rose Acacia, so as to produce flowers in the autumn, 376.

*August.* — Plant Ranunculuses for blooming in November, 293; form and plant a Strawberry Wall, 437; sow the Cow Cabbage on the 20th inst., 440.

*September.* — Take up and pot rooted cuttings of *Hydrangea hortensis*, 273; plant Ranunculuses in frames for blooming in December and January, 293; plant Hyacinths, 426.

*October.* — Plant Ranunculuses in frames for blooming in February, 293; gather Hawthorn-den Apples intended to be kept through the winter, 444.

*November.* — Plant Ranunculuses in frames for blooming in March and April, 293.

*December.* — Manufacture straw or reed Mats in weather unfit for working out of doors, 414; plant Ranunculuses in frames for blooming in April and May, 293.

END OF THE FIFTH VOLUME.







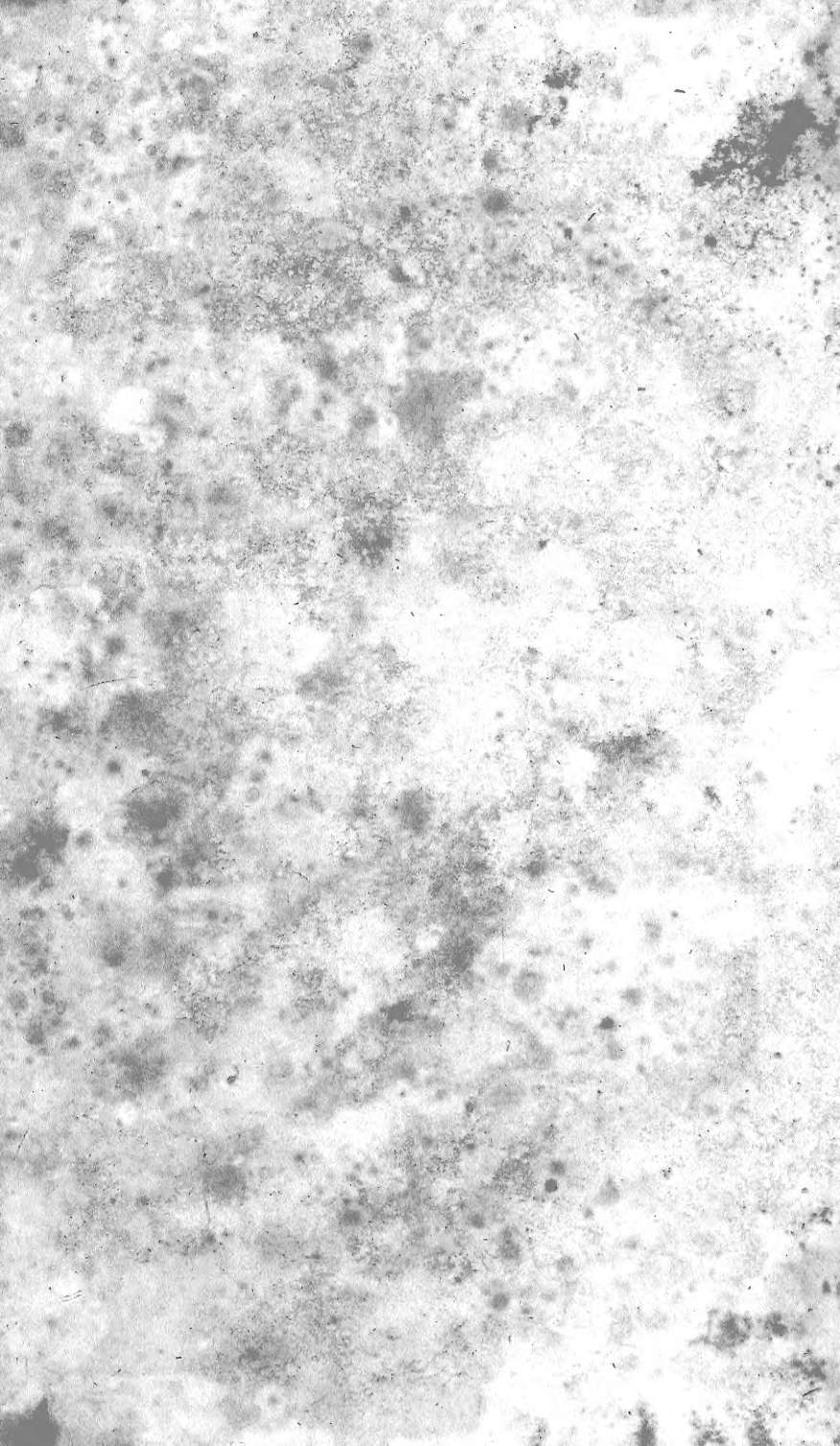



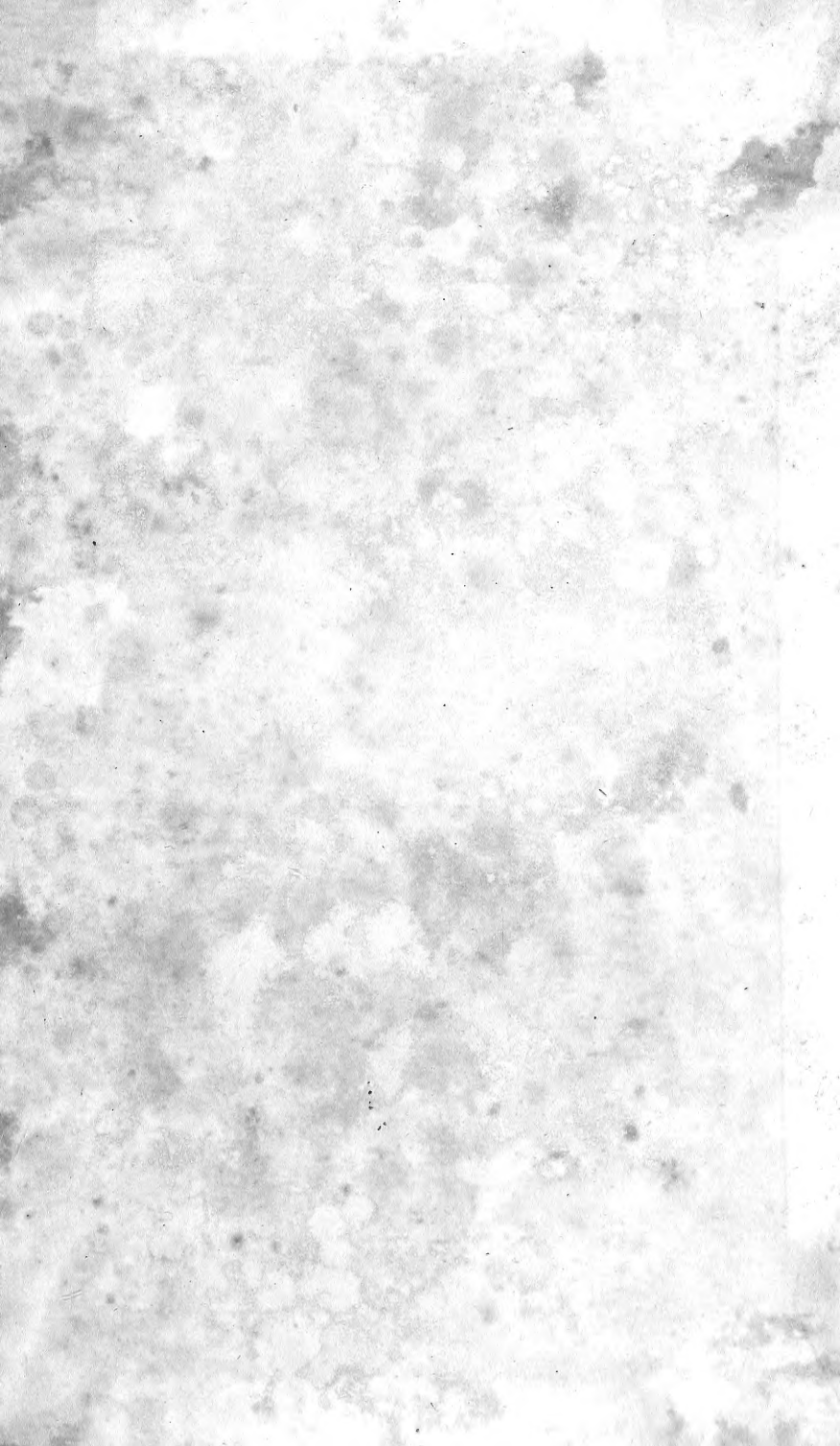

SMITHSONIAN INSTITUTION LIBRARIES



3 9088 01527 8567

