

312066 0326 7434 8

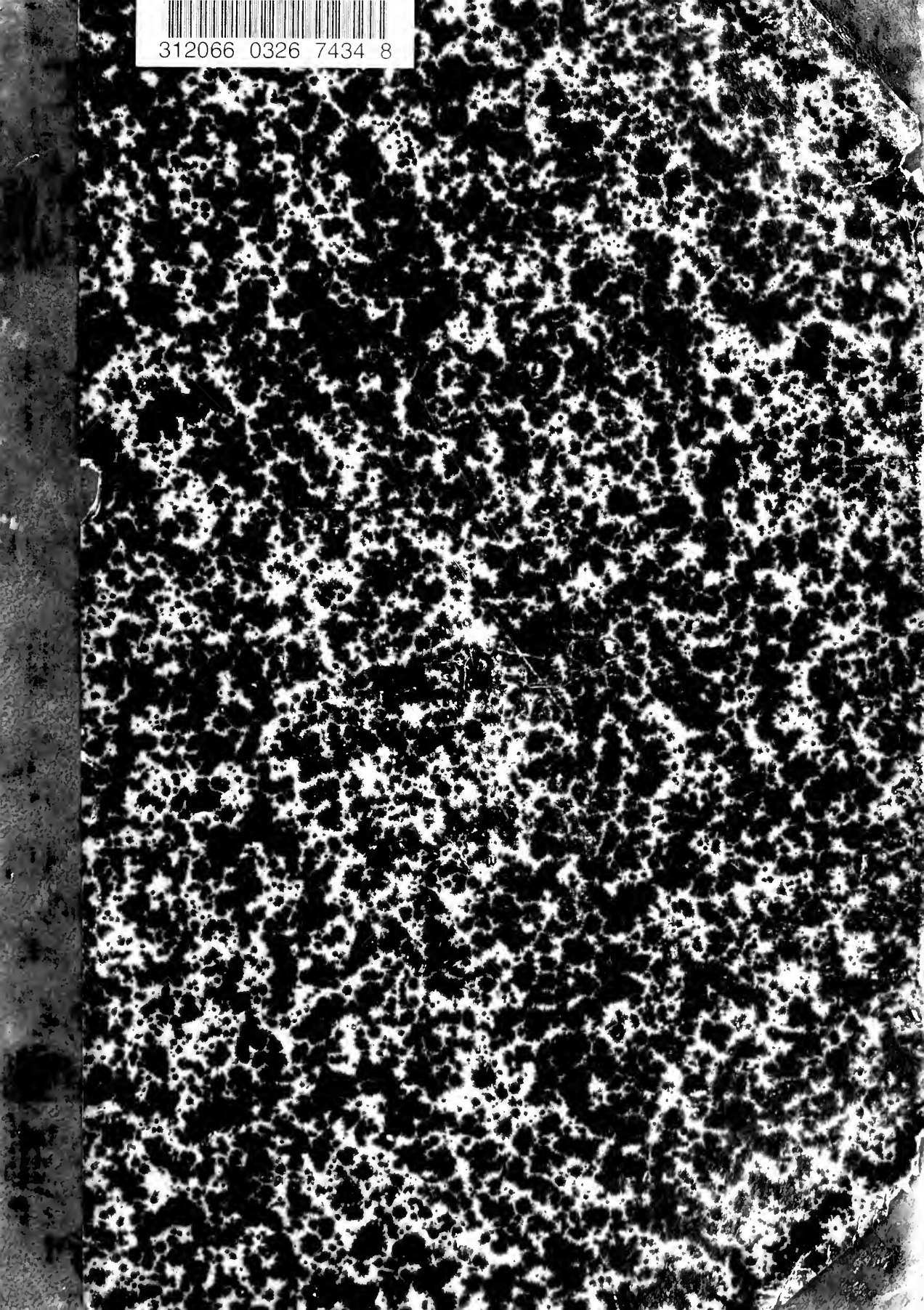

LIBRARY

OF THE



MASSACHUSETTS  
AGRICULTURAL  
COLLEGE

NO. 4260 DATE Jan 1885

SOURCE Alumni fund

**Per**

v. 13

SHAPEI

This book may be kept out

## TWO WEEKS

only, and is subject to a fine of TWO CENTS a day thereafter. It will be due on the day indicated below.







# The Gardener's Monthly,

AND

HORTICULTURAL ADVERTISER.

DEVOTED TO HORTICULTURE, ARBORICULTURE, BOTANY AND RURAL AFFAIRS.

EDITED BY THOMAS MEEHAN,

FORMERLY HEAD GARDENER TO CALEB COPE, ESQ., AT SPRINGBROOK, AND AT THE BARFRAM BOTANIC GARDEN, NEAR PHILADELPHIA; GRADUATE OF THE ROYAL BOTANIC GARDENS, KEW, (LONDON,) ENGLAND,  
MEMBER OF THE ACADEMY OF NATURAL SCIENCES. AUTHOR OF "THE AMERICAN HAND-BOOK OF ORNAMENTAL TREES," &c.

VOLUME XIII, 1871.

TERMS.—Two Dollars per Annum, Invariably in Advance.



PHILADELPHIA:  
BRINCKLOE & MAROT, PUBLISHERS,

No. 23 NORTH SIXTH STREET.

1871.

Per  
5769  
13



# The Gardener's Monthly.

DEVOTED TO

*Horticulture, Arboriculture, Botany and Rural Affairs.*

EDITED BY THOMAS MEEHAN.

*Old Series, Vol. XIII.      JANUARY, 1871.      New Series, Vol. IV. No. 1.*

## HINTS FOR JANUARY.

### FLOWER GARDEN AND PLEASURE GROUND.

This is the head under which we give monthly hints for a certain department of gardening, but as to *flower* gardens we can of course say little at this season. Not so, however, with the pleasure ground, which indeed every garden should be,—for here, to our mind, we derive as much enjoyment as in any season of the year. In no season can we so well appreciate the beauty which the spray of deciduous trees afford. The Larch, for instance, beautiful as it ever is, whether when pushing forth its brilliant crimson flowers in spring, or bending later in the season beneath a burden of green foliage, is still another thing in winter when its cone-covered branchlets swing in the storm. The Beech, the Sassafras, the Tupelo, the Oak,—indeed almost all trees have distinctive and peculiarly striking features, which can never be so well admired as when a crisp carpet of snow covers the ground, and there is just cold enough to make one's cheeks ruddy, and give elasticity to our steps. And as for Evergreens,—winter is their grand festival time. We plant them for winter in a great measure. We have green enough in summer time; it is not that we want them to be ever green,—but that they furnish their color for the painting of nature's winter scenes.

But the varying forms of evergreen, as exemplified in the Pine, the Spruce, and the Fir,—or in the Rhododendron, Box or Yew, are not by any means the chief sources of winter garden pleasures. To us there is nothing more beautiful than all trees when covered with frost crystals, or even when bending lightly under the

icicles which a half rainy, half frosty morning breeds. Their forms and attitudes are then as various as their natural specific differences, and many a time we have looked at the sweet picture, wondering why the warm sun should need to ever come again and make it all a dream. I am quite sure that all who have a heart to enjoy the delightful phases of each season's garden scenes, will find much to feed their souls with at this season of the year. They will note well the various beautiful features they see everywhere about them,—and will, when the spring season comes around, plant to produce the best effects for another season. It may be well to remark here that one of the great pleasures of gardening is the creation of beauty. It is very nice to have handsome flowers or beautiful trees,—but even the "heathen" has these. Any one who walks the woods or the wilds, has trees and flowers for the journey. It is the combination of these, so as to make effects never seen in a state of nature, that gives the charm to gardening, and makes it really an art. It is well enough to plant to give us shade—to screen disagreeable objects—to make our places look larger—to break the force of strong wind currents—to have a fine botanical collection—to possess some rare gems which the uttermost ends of the earth have been ransacked to find,—but to plant so that a joyous thrill shall leap within us every time we behold the fairy scene, is not often thought of, yet very easy to do. It is part of our mission to suggest these things, and to urge thinking about them now. We want to learn our readers how to bud, and graft, and reap, and sow,—but what is the use of all

the material after we get it together, if we make no joyous use of it?

Turning now to more practical matters, we would say that before any walk is located, be sure it is absolutely required. A pretty outline should be subservient to this. Utility is the essence of beauty in a garden walk. With these general hints on first cost and maintenance, we can only give, this month, the more practical advice to get ready for regular work.

The manure heap is one of those items that can receive attention at this season to advantage. Without a good pile of rich compost, very little success can be hoped for in any kind of gardening affairs. Leaves and litter of every description should be collected whenever possible, and stored in suitable places, where they will not be offensive by their littersy appearance. For flowers, generally leaf mould from the woods is very acceptable—not the half-rotted leaves that are immediately on the surface, but such as have been powdered by age, and amongst which the roots of the trees have already penetrated, and rendered of a spongy consistence. We like all manures to be thoroughly decomposed before using, if the garden soil is already light and friable; and to this purpose the manure heap should be occasionally turned over and lightened, to assist fermentation. This, also, is aided by watering the heap with a solution of potash, and which also gives additional value to the manure.

It is a very good practice to cover lawns with manure at this season. Two good results flow from this course: the frost is prevented from penetrating so deeply, and the ground being warmed much sooner in spring, is green and cheerful some time before unprotected lawns, and then the grass itself is strengthened, and its color brightened by the operation. But stable manure has the objection of introducing many coarse kinds of weeds, that would not otherwise exist on the lawn; and so where the grass grows poorly, and strength and luxuriousness are desired, guano and the phosphates are preferred. Many use bone dust, ashes, etc.; but the mowers are apt to feel somewhat indignant, in mowing time, through this material taking the edge off their scythes.

Manure for flower beds, borders, etc., may be hauled convenient to where it is likely to be wanted in spring. Many spread it on at once—but if the soil is frozen very thick, it prevents

the early thawing of the soil in the spring, and so no time is gained.

Evergreens set out last fall in windy or exposed situations, will be benefited by a shelter of cedar branches, corn stalks, or mats set against them. Whether hardy or tender, all will be benefited thereby.

---

#### GREENHOUSE AND PLANT CABINETS.

The season of the year has arrived when this department of gardening is more attractive than any other. It is one that calls for a great part of a gardener's skill—indeed intelligent gardeners can seldom be found willing to accept a situation where there is "no glass."

The best kind of earth to use is the surface soil, containing the spongy mass of surface roots, from a wood; the first two inches of an old pasture field; the turfy spongy mass called peat from sandy bogs or swamps; a little well decayed hot-bed manure; some sharp sand; are now about the only "elements" that the most skillful gardener cares to have beside him; and many a good gardener has to find himself minus of some of these, and be satisfied.

The soil for potting should be used rather dry; that is it should be in such a condition that it will rather crumble when pressed, than adhere closer together. Large pots—those over four inches, should have a drainage. This is made by breaking up broken pots to the size of beans, putting them in the bottom a quarter or half an inch deep, and putting about an eighth of an inch of old moss or any similar rough material over the mass of "corks" to keep out the earth from amongst it. Little benefit arises from draining pots below four inch, the moisture filtering through the porous pots quite fast enough; and the few pieces of "drainage" often thrown in with the soil placed right over, is of little or no use.

Fergeries are now so deservedly popular, that we must have a word to say for them at times, though their management is so simple there is little one can say. It is probably their ease of management, and the great results obtained for the little outlay of care that has rendered them so popular. It should not, however, be forgotten that the case in which they are enclosed is not to keep out the air, but to keep in the moisture, as ferns will not thrive in the dry atmosphere of heated rooms. A few minutes' airing every day will, therefore, be of great benefit to

them. Decayed wood, (not pine), mixed with about half its bulk of fibrous soil of any kind, and a very small proportion (say a tenth of the bulk) of well-rotted stable manure, makes a good compost. Most kinds particularly like well-drained pots. This is usually effected by filling a third of the pots in which the ferns are to grow with old pots broken in pieces of about half an inch square, on which a thin layer of moss is placed, before filling the pots, to keep out the soil from choking the drainage.

Daphnes like a cool, humid atmosphere, and are very impatient of heat. The best we ever saw were grown by a farmer's wife, who had an old spring-house converted into a greenhouse to preserve her oranges, oleanders and daphnes over the winter. The natural heat from the spring was quite sufficient to keep out frost, and it was surprising how charmingly the plants throve in this, to a gardener, rough-looking plant-case.

Where the air is dry, if rooms or greenhouses, frequent syringings are of much benefit to plants. Besides, cleanliness keeps down insects and checks diseases in plants as in animals. Most old fashioned lady gardeners (and may we ever bless them for the many lessons they have taught us!) take every opportunity to set their window-plants out of doors whenever a warm shower happens to occur. In winter a rain at a temperature of 40° or 45°, which often occurs, might be called a "warm shower." Cold water does not have half the injurious effect on plants that cold air has. When plants get accidentally frozen, the best remedy in the world is to dip them at once in cold water and set them in the shade to thaw.

It is better to keep in heat in cold weather by covering, where possible, than to allow it to escape, calculating to make it good by fire-heat, which is, at best, but a necessary evil. Where bloom is in demand, nothing less than 55° will accomplish the object; though much above that is not desirable, except for tropical hot-house plants. Where these plants are obliged to be wintered in a common greenhouse, they should be kept rather dry, and not be encouraged much to grow, or they may rot away.

After Cyclamens have done blooming, it is usual, at this season, to dry them off; but we do best with them by keeping them growing till spring, then turning them out in the open border, and repot in August for winter-flowering.

Mignonette is much improved by occasional waterings with liquid manure.

In managing other plants, where there are several plants or varieties of one species, and command of different temperatures, it is a common plan to bring some forward a few weeks earlier than others in the higher heat, thus lengthening the season of bloom. This applies particularly to camellias and azaleas; the former are, however, not so easily forced as the latter, being liable to drop their buds, unless care be taken to regulate the increased temperature gradually.

There is a plan of making some plants bloom very early, that is not generally known, namely, by pruning them. There are two classes of flowering plants,—one perfects its buds on the wood of the past season's growth; the other flowers on the new growth of the present season. Whenever you want the latter class to flower, all that is necessary is to prune the plant in closely and induce a new growth. This is frequently practiced with roses to get a fine fall bloom, but it is not often done with house-plants, though the principle and advantages of the practice are, in both instances, the same. Watering of pot-plants should be always done as early in the morning as possible, and the water be as warm or warmer than the temperature of the house.

Window plants suffer much at this season from the high and dry temperature at which it is necessary for human comfort to keep our dwellings. Air can seldom be admitted from the lowness of the external temperature. Saucers of water under the plants do much to remedy the aridity under which room plants suffer. In such cases, however, so much water must not be given to plants as to those without saucers. The water is drawn up into the soil by attraction; and though the surface will appear dry, they will be wet enough just beneath.

The more freely a plant is growing, the more water will it require; and the more it grows, the more sun and light will it need. In all cases, those which seem to grow the fastest, should be placed nearest the light. The best aspect for room plants is the south-east. They seem like animals in their affection for the morning sun. The first morning ray is worth a dozen in the evening. Should any of our fair readers find her plants, by some unlucky calculation, frozen in the morning, do not remove them at once to a warm place, but dip them in cold water, and set them in a dark spot, where they will barely escape freezing. Sunlight will only help the frost's destructive powers.

## COMMUNICATIONS.

## BEAUTIFUL FRUIT.

BY "DELAWARE COUNTY."

I suppose, Mr. Editor, you know all about the old Scotchman who was opposed to his son marrying a poor girl. "You know, Sandy," he said, "it is as easy to get a good girl, and a pretty girl, and one who has got money, and to love her, too, as to get one who has none." I don't know how this may be, being a bachelor, and never having been in love, but it seems like common sense, and I believe in it. If I were about to marry, I should try it; that is, if I were a student of girlhood with a view to wedlock, for in truth, I am a marrying man. I am wedded to Pomology, and those various branches of gardening which have occupied my whole heart so far to the exclusion of all else.

At any rate, I believe the Scotchman's maxim is true in Pomology. I would say it is as easy to get a good fruit with beauty, as a good fruit with a villainous look. I have a contempt for the man, or—for I am independent of the sex—woman either, who hands me a sort of green pumpkinoid affair, with the apology, "Don't mind its looks. you will find it first-rate flavor." There is no reason at all why the miserable looking things we see should be handed about and praised and rated No. 1 in the fruit catalogues, merely because under their harsh and austere looks a little sugar, cinnamon and honey, should get mixed with the watery juice. Look at some Pears, for instance. What could any one see in a Chancellor, a Des Nonnes, a Winter Nelis, a Glout Morceau, Bleeker's Meadow; a Lodge, Duchesse, Tottleben, Fulton, Leon le Clere, Merriam, Monarch, Jones, Vicar, St. Germain, Hosenhenk, Selleck, Rutter, Moyamensing, Philadelphia, and similar things which occur to me as I write? Even a Belle Luerative I regard as a libel on the Pear's good name. I don't want the old objection made to me that it is better to have a good eating fruit, with a poor form or skin, than it is to have the one without the other. I want both in one. I want my table to look well, as well as to be well, and I agree with the Scotchman as aforesaid,—that it is as easy to have both together, as to have one alone. Some of our pretty fruits are, to be sure, mere passing flashes—not good to the core. No,

one would tolerate the Beurre de Montgerons, the Zoar Beauties, Marie Louise, Kingessings and Brandywines, Bilboa Beauties, and so on. But there are others which, like the Seckel, Bartlett, Clairgeau, Bosc, Tyson, Washington, and Beurre d'Anjou, are pretty and good, and well worth any one's having.

Mr. Editor, I wish to protest against the insult to Pomona, in the naming and disseminating these ugly looking things. I believe the Pomological Society have, or once had, rules for naming and describing fruits. Why cannot they place "Beauty" as their article No. one? If a fruit presented for their consideration has a hog-gish look, at once let it go to the hogs. If it has this first essential, then handle, weigh, smell, cut and taste,—inquire about its vigor, its hardiness, its productiveness, and its other virtues, and set it down accordingly. Many of our fruit growers already have a horrid sense of disgust at an ugly tree. They will go through a thousand trees in a nursery to get a handsome one. A crooked one they cannot bear, and yet they pretend to go into ecstasies over a so called fruit that has no more claim to admiration than a sun ripened potato. Verily, man is a curious animal, but his tastes are more curious still.

Yet I do not deem the cause hopeless. So at this season I ask a corner in your magazine for my protest. This is the season when schedule committees of exhibitions sit. They could help in this good work if they would. For instance, let them offer some premiums for the best looking fruit,—this to be the first quality, and then flavor and other points to rule. Of course there would be some difficulty. A little discretion would have to be left to the committee. Some beautiful looking fruit might be but as whited sepulchres,—all loathsomness within, and in such cases one not quite so pretty, with excellent other properties, would commend itself to the judge's decision; but there would be no difficulty in this, that those fruits which had no beauty of form or color, should be absolutely ruled out of competition in such a class as contemplated here. I do not know how the proposition strikes you, but I do want to see the idea of *beautiful fruit* something more than a mere phrase.

## ENGLISH WATER CRESS.

BY MR. C. W. HALL,

*Gardener to Captain Cooper, Sunnyside, Baltimore.*

Permit me to recommend through your valuable *Monthly* the most wholesome and most productive of all salads grown in winter and spring, and yet the cultivation of it is little known, and almost entirely neglected by those who do know. This Water Cress is a native of Great Britain, and is found wild in the small streams more or less through the whole country, and is cultivated on a large scale around London. Although this Cress is considered amphibious, it thrives better in an ordinary hot-bed, from October until April, than it will at any season growing in its natural element, exposed to the climate. I find three sash ample for a moderate family from October until April, and requires no re-planting. I whitewash the glass, and give very little air except when raining, which saves watering, which it requires at least once a week. A full crop can be cut every three weeks. I generally cut one-third of a sash each time, so always get a succession. About the first of April a quantity of plants should be transferred to some cool, wet place, where they will live during summer and be ready for the hot bed in the fall.

[We are very much obliged to Mr. Hall for this valuable hint. It will be news to the great body of gardeners that the Water Cress can be grown in this way; and no doubt it will be found that the quality is improved by this mode of culture. In some parts of the United States the Water Cress has been naturalized in ditches and running streams,—about Philadelphia especially it has become rather common. But it is found that the plant is much more “peppery” when grown in an American climate than in the shadier one of Great Britain—hence many who have rejoiced at the prospect of enjoying this great English luxury here have soon lost the taste. We think it quite likely that the shade of the sashes as employed by Mr. Hall would give a more tender and delicate flavor to it, and if so, there is a prospect of its getting as great a popularity on our tables as it enjoys in England.—ED.]

## CIDER.

BY W. H. W., NEW WINDSOR, CONN.

Under the above name, great quantities of fluids are sold and drank daily, much of which

is quite unwholesome, and shows its effects on the human system in various ways. No wonder that so many think and claim that cider is an unhealthy drink, observing the results from drinking the beverage so freely sold as cider.

*Cider is the expressed juice of apples without any admixture, pure as pressed from the apple, having passed the vinous fermentation under favorable circumstances. The manufacture of good and pure cider is a simple process, requiring no very great amount of labor or extraordinary skill, yet it is one wherein very many fail who make the attempt. Why they fail, I leave for others to judge, or say.*

The great abundance of apples the past season has caused considerable inquiry concerning the mode of making cider, and preparing it so that it will keep good and palatable the longest time. I think, from experience, that if the following processes are strictly followed there will be little difficulty in making and preserving cider for almost an indefinite period of time, and it will be good too:

First, we must have apples ripe and sound, I care not how knarly or uneven the surface, as the best part of the juice comes from near the surface. An apple that is bruised has commenced a decaying process, the juice has commenced to deteriorate, and such juice cannot make the best of cider, if far along in the change. The warmer the weather the more rapid the decaying process.

Gather the apples, clean, free from leaves or any other foreign matter, put them in piles, not very deep, or they will heat too much, let them lie, in cool weather, four to eight days before grinding, etc. Grind or mash them fine, without crushing the seed, in a wood mill-fluted cylinders—without any metal of any kind to come in contact with the apples, pomace or juice. As the apples are crushed let the pomace fall into a suitable vat of capacity for a middling sized cheese; grind it full and stir to mix it well before commencing to “lay up cheese.” Let the press bed and follower be wood,—oak or chestnut,—also the vat or tub to catch the juice; let there be no metal to come in contact with the juice at any time, especially any that will oxydize or corrode. The press bed should have a channel cut, an inch deep, around the outer edges with a projecting lip at one side to carry the juice off and conduct it to the tub, Lay up the cheese, in cakes, with rye straw cut in two

lengths, between to bind the cheese, and also to facilitate extracting the juice. Lay on sufficient pomace to form a cake four inches thick; have a board four inches wide, long as the press is wide; set this on edge one side, and draw the pomace to it, pressing it firm; go around in like manner, on the four sides; fill up the centre level; now spread on a thin layer of straw, but out two inches all around, a little scattered over the middle; lay up the whole cheese in like manner, finishing with straw on top; put on follower and press gently, be in no hurry, see that no pomace falls out to obstruct the flow of the juice in the channel on the press. Increase the pressure gradually as long as there is a good flow; remove the follower and cut off about three inches of the outside of the cheese, pick it in pieces, and lay on top, evening all around; apply pressure again as long as juice flows. It will often pay to cut again and press for vinegar.

The apple juice will need be dipped from the tub, filtered through straw and flannel into *good, sound, sweet and clean* casks. Chestnut makes the best cider and vinegar casks; rum and brandy casks make good casks for cider, if they are fresh and clean. The middle running of the cheese makes the best cider and should be saved by itself. The great secret of good cider is to remove all pomace, etc., and then to place the cider at once in a cool cellar, never allow it to be disturbed while fermenting. As soon as it has ceased its most violent ferment, and thrown off all foreign matter, which it does in a few days, insert the bung tight with a syphon tube, one end in the bung and the shorter leg dipped in a cup of water, to exclude all access of air to the cider, while it admits the escape of the carbonic acid gas. When the cider has about ceased fermentation, which may be known by only an occasional bubble escaping from the tube, remove the bung and put in another air-tight, and do not disturb again till the following April, when it should be drawn into bottles and corked tight. No racking off is necessary, as it only causes the cider to absorb oxygen of the air, causing it to acidify.

To make cider keep the best, the latest ripening apples are the best, and then made in November, or after cold weather comes. There is a great difference in apples in making cider; some will make cider with a heavy "body," rich and good, while others will make it thin, watery and flavorless. A great difference will be found in apples of the same variety grown in different soils and different locations. Crab or

natural fruit I have always found superior for making good cider to grafted or finer fruit.

---

#### NOTE ON GROWING VIOLETS.

BY S., STOCKBRIDGE, MASS.

While renewing my subscription to your valuable magazine, I offer, if you think worth publishing, the following in respect to growing the Violet. It has ever been one of my favorite window flowers. In former years when brought into the house from the cold pits to flower, they were placed at once in the sitting-room window, where we had a regular temperature of about sixty degrees; but the stalks were always slender, and the flowers rather small. Thinking it was too hot, I kept them other years in a cooler room, where the heat might perhaps not range over between 45 and 55, and the result has been much healthier looking plants and finer foliage. Besides this, they were not much behind what I have had in warmer places in other years. I am sure they want very little heat to do well. Another fact.—I have learned that a manure water made of rotten wood is a capital fertilizer for them. Once I thought as shady places were the natural places where Violets grow, rotten wood would be a good thing in the soil, but they sometimes get sick in it; but the liquid of steeped wood does not seem to have this effect; on the other hand, a lively green is the result. We never water them except when they show signs of drying; in our room this is about twice a week. This may not be new, but it is true.

[And therefore the more acceptable. It is just the sort of any article we like. We wish "subscription time" came twice a year.—ED.]

---

#### DISEASE IN PEARS.

BY W. P. P., ONARGO, ILLS.

In the note under the above head in the November number of the *Monthly*, I studiously avoided advancing any theory as to the cause or origin of the disease that had made its appearance among my pear trees. As there are probably many thousands of pear trees now in the grounds, gardens and orchards of the country, in a condition similar to that of those described in the aforesaid note, I have thought it might be well to give a more detailed history of the trees since they came into my possession, and as far as is known, previous to that period, in the hope that light may be elicited in regard to the origin

of the disease, and that remedies and preventives may be suggested.

The trees in question were grown in a nursery in central New York, and were shipped to me soon after the occurrence of the severe cold weather that prevailed throughout the country about the 15th of October, 1869. A large proportion of the trees had made a growth during the summer, of from four to five feet; and in color, thrift and general appearance they resembled much the succulent water-sprouts that often put out from an apple tree after a severe pruning. A portion of the trees were set out in the fall, and the remainder were heeled in and set out in the spring. The trees were in the main of the following varieties, to wit: Seekel, Lawrence, Bartlett, Sheldon, Belle Lucrative, Doyenne Boussock, Beurre Clairgeau and Howell, all standards.

#### CONDITION OF THE TREES THE FOLLOWING SPRING.

On the opening of spring a ring of bark about one inch wide peeled off around many of the trees just at the surface of the wound. The bark also of many of the trees had a pinched and shriveled appearance. In a large proportion of the trees the pith or heart of the wood of the previous summer's growth was black.

#### CONDUCT OF THE TREES DURING THE SUMMER OF 1870.

About one-third of the trees in which the black heart made its appearance only in the tips of the branches, have made a moderate growth, and I have some hopes that I may be able to make fair trees of them. But a large proportion of them have simply put forth their leaves and remained stationary throughout the summer. Quite a number have put up a vigorous sucker just below where the ring of bark peeled off. About one-sixth of the two hundred trees have died. The outside bark on the south side of many of the trees that still have life in them, has crumpled up and peeled off, and the wood under this crumpled bark is in a condition of only semi-vitality. The provoking cases are those that will neither grow nor die, nor put up a sucker. For the most part, however, I vote all such as good as dead, and dig them up and throw them away. One more statement and I have done with the history of the trees. A portion of the trees were well heeled in during the winter of 1869. Nearly the entire tree was covered with earth. In the spring they came out looking plump, fresh

and fair. The condition of those trees is now, however, much the same as that of those that were set out in the fall.

#### THEORY AS TO THE ORIGIN OF THE DISEASE.

These trees were undoubtedly stimulated to an unnatural growth in the nursery. A young tree in California or southern Illinois, may make a growth of four and five feet in a season and mature its wood, but not so in central New York. The severe October freeze of 1869 found these trees in a succulent and immature condition. Their wood of the summer's growth was about as readily frozen as the apples then upon the trees. For the same reason the stems of thousands of Osage Hedge plants in central Illinois, six and eight feet high, were killed down to the ground. For a like reason the new wood of many of the young and thrifty apple orchards of the country, and especially on the rich prairies of Illinois, had died during the summer just past. I do not call this malady the "Frozen sap blight or the frozen wood blight," nor do I give it any other name. In the case of the pear trees it is believed that the wood and sap of the trees were simply frozen before the wood was matured, and that they were thus more or less disorganized; and that the degree of injury thus sustained by the different varieties of trees was just in proportion to the degree of *immaturity of their new wood* at the time this freezing took place. The Howell sustained the least injury, while the Bartletts, the Boussocks and the Beurre Clairgeaus were damaged the most. These three last varieties had also made the largest growth of new wood of any of the lot.

Item 1. Had these trees all been set out in the fall, there would have been room for the inference that they were damaged during the winter. But such was not the case, and hence the inference can not be made. The winter was moreover very mild, and trees that could not endure such a winter must have been immature and worthless.

Item 2. The black heart of these trees is confined to the new wood, the heart of the old wood of the previous year's growth being of the natural color and appearance. But while this is true of the heart, the new wood that was put into the stem of the trees during the summer of 1869, was apparently about as succulent and immature as the new growth at the top.

Item 3. I do not find on the surface of the

bark of these trees the "black blotches" of which mention is made in the comments upon my note in the November number.

Query. Is it probable that the new stem that is putting up from some of these trees from near the ground, can ever make a healthy tree? Can the roots of such trees be in a perfectly healthy condition?

---

### GARDENING FOR THE YOUNG.

BY JAMES LAMONT, PITTSBURGH, PA.

How is it that we have no millionaires in our profession? Often I have thought, and I have come to the conclusion that it is because we have not taught the young and rising generation the arts of gardening. There is not demand enough for our wares. Look how the dry-goods men decoy both old and young into the love of dress. Therefore they have millionaires amongst them.

See how quick even a candy shop rises from a few shelves to a well filled "store;" and the small window has to give way to a large and beautiful one, filled with the best, and made showy with French plate-glass. Then follows plenty of work to the dentists, and doctors, and druggists,—some of these are millionaires.

Have we one young lady in America that could take a bouquet, and dissect it, and name all the flowers in it? I think we have not one; but we have plenty that can tell us all the names of dry-goods and candies.

Mr Editor, by your teachings you have done wonders for horticulture among the old; and I think you might do as much among the young. The young must be taught, and when they are old they will not depart from the way they were started in.

I wonder if it would do for a lesson, for Mr. Greeley to offer a prize of one hundred dollars to all the young ladies in the State of New York, at their next floral exhibition, to have a bouquet, made for that purpose, and the young lady who could take it in her hands, and name all the flowers in it, to give her the bouquet and the hundred dollars. I think this would do more for horticulture than the Greeley prize for the best grape. We all knew the Concord was king, but we do not know who would be queen among the flowers and bouquets.

Had Mr. Osgood been a lover of horticulture, he certainly would have given a wood-cut of a green-house for the edification of our

children here. I must confess it is scriptural for it says, "the first shall be last, and the last shall be first." So we must be contented with our lot. We would rather know about the flowers first and green-house after.

It is evident that the people who are lucky enough to take up the hint afforded by the fig leaves and Adam's needle, as a profession are the luckiest so far as cash goes.

Have we not great evidence of the *needle* and *leaves* in all our large cities, in all the show windows,—some of them, truly it is beautiful to look at, but I am sure a nice sized green house, filled with the new varieties of *Azaleas*, and all in full bloom, is the loveliest show one could see.

Mr. Editor, for over twenty years you have been teaching the people of these United States all the branches of horticulture, and you have done it well. But I think we have too much orthodox and not enough of orthodoxy, and I think if you would take this in hand, I am sure you could help it very much.

I hope this will not find its way into the scrap basket; but I must conclude, for fear I am intruding on your columns. I think there is a good deal of roguery in all trades but ours, and we must have a good solid head of cabbage, or the cooks would condemn it and us, whether we have flowers or no. The useful before the beautiful, you might say,—but let us have even utility clothed in beauty at least.

---

### RHODODENDRONS IN NATURE.

BY EDWARD, BALTIMORE, MD.

Can you or any of your numerous correspondents account for the following facts: Some two weeks since I was travelling on the Philadelphia and Erie railroad through the Allegheny Mountains, where the Rhododendron is at home, but for 150 miles I did not see a single plant growing in the vicinity of the white pine, except in one case, and then the pine was as yellow as a peach with that disease. Its home seems to be with the hemlock, though some were growing amongst other varieties of pines, but not so vigorous as with the hemlock. In last June number you have a chapter on the culture of the Rhododendron, the mode of growing them, etc.; but to see them in their natural state would surprise those who think so much extra care necessary; for there you see them growing in every conceivable way, soil, shade and full sun; stiff



clay, solid rock, sand and every variety of soil you can name. There was one thing I particularly noticed, which was, those which were in the full sun were the best color, and healthiest plants, and ten to one more flower buds on them. I learnt to plant the Rhododendron in the sun and as you remark, not too dry a situation.

Should any lover of Rhododendron wish for a rare treat, let him take a trip from Sunbury, in Northumberland county, to Warren, in Warren county, as I did, the 2d of last July; my word for it, he never will regret it. It eclipsed anything I have seen since I used to visit Waterer's exhibition, in London; with this difference, his were artificial, but this was natural. Picture to yourself 150 miles of flower garden, in one full blaze of beauty, such as art never could accomplish. But it must be seen to be appreciated.

[We never heard before that there was anything antagonistic between the white pine and the Rhododendron. The writer's impression is that he has seen the pine and Rhododendron together in their native localities—that is with young pine, for *nothing* will live *under* a forest of dense white pine. But we are not sure about this—only certainly they exist in the same region of country and not very far from these trees.—Ed.]

## ESSAY ON HORTICULTURE.

BY JACOB STAUFFER.

*Read before the Lancaster County (Pa.) Agricultural Society.*

MR. PRESIDENT AND GENTLEMEN: We all know that the word Horticulture is compounded from the Latin *hortus*, a garden, and *colo*, I cultivate—the culture of the kitchen garden and orchard. Consequently the subject would properly confine my remarks to all kinds of roots, herbs, flowers and fruit used in cookery; that is, culinary vegetables and fruits. This might be called gardening.

Floriculture, which includes the culture of ornamental and curious flowers, shrubs and trees. Arboriculture, which implies the culture of trees and shrubs, used for various purposes in the arts and general economy; and may also be embraced as separate and apart from agriculture, a name also from the Latin *ager*, a field, and *colo*, I till or cultivate. This properly includes all the field crops, and the rearing and

managing of domestic animals on a large scale, and constitutes the farm or farming.

I will, however, endeavor to glance rather at the history and peculiarities of the kitchen garden, and things connected therewith, that I may deem to be new to some of you at least, and either of interest or instruction, without entering into a minute description of the plants referred to.

In order to make a beginning, I will introduce the natural order of plants known as the "cruciferae," or the "mustard family." The flowers are composed of four leaves or petals, with claws or prolonged ends, forming a cross, hence the name "cruciferae." They have six stamens, four long, and two shorter, called "tetradynamons." Fruit, a pod or capsule, two celled by a partition; when the pod is elongated it is called a "silique," when short and broad, a "silicle." This family includes our cabbages, turnip, water cress, etc.

It may be new to some that, botanically, the mustard ranks in the same genus with the cabbage; *brassica*, which is the ancient Latin name of cabbage.

*Brassica oleracea*—Our cabbage. The original is a sea-coast plant of Europe, with thick and hard stem, and pretty large, pale, yellow flowers; the leaves collected into a head through cultivation, which blanches the inner leaves and renders them so desirable for the table. The variety called *broccoli* is a state in which the stems divides into short, fleshy branches, bearing clusters of abortive flower-buds; the name is from the Italian and French, and means "sprouts;" it is only a variety of the "cauliflower;" French, *chou-fleur*. Webster says from the Italian, *cauliflor*, also *caulis*, a stem and flower; have the nourishing matter mainly concentrated in short, imperfect flower branches, collected in a flat head. The variety "kohlrabi" has the nourishing matter accumulated in the stem, which forms a turnip-like enlargement above ground, beneath the cluster of leaves. The "kale" or *crambe*, which is the Latin name for cabbage; the *Crambe maritima* is the wild British plant, which yields sea-kale under the hands of the gardener, and furnishes one of the most delicate esculent vegetables; the parts used being the blanched leaf-stalks, with more or less of the young stem, all in a succulent, crisp condition.

Before I continue the list of these remarkable

germs and its varieties, I will glance at some historical notes.

The close-headed variety, which is now more peculiarly called cabbage, was for many years imported into England from Holland. Sir Anthony Ashley first introduced its cultivation, and made the English independent of their neighbors for a supply. This planter of cabbages likewise rendered his name known by other deeds less creditable to his character. It is related that he had a command at Cales (Cadiz), where he got much by rapine, especially from a lady who entrusted her jewels to his honor; whence the jest on him (like on Butler about the spoons, whether true or false). The saying is that he, Sir Ashley, got more by "Cales" than by "Cab" and cabbage. As tailors are said to be fond of "cabbage" (my worthy friend S. S. will excuse me) may not this circumstance have given rise to the accusation of "cabbaging," when cloth entrusted to them was appropriated to their own use.

It is recorded that cabbage was first introduced into the North of Scotland by the soldiers of Cromwell. Scotland is more peculiarly the "land of Kale." Old Scotch songs point to the fact. The poet says:

"There's cauld Kale in Aberdeen,  
An' castock's in Stra' bogie."

These castocks are the cabbage stems, having the fibrous parts peeled off, and the remainder softened by boiling. Sauer Kraut, that excellent preparation of the Germans, is merely fermented cabbage. The history is lengthy and the varieties of cabbage numerous, which I cannot take time to record, unless I meant to devote two hours to cabbage alone; but will hasten to other varieties of this genus of Brassica.

*Brassica campestris*, of the Old World, like the "kale," but with brighter flowers: these are represented in cultivation by the var. *Colza* or *Rape* with small annual root, cultivated for the oil of the seed. This is the parent of the turnip *B. napus*, yielding the nourishing napiform white root. The variety Rutabaga or Swedish Turnip has a long and yellowish root. Then comes the Brassica, *Sinipatrum* or *Sinapis arvensis*, the "charlock, a troublesome weed of cultivation in grain-fields, a rough-leaved annual." The white mustard or *Sinapis alba* is also a Brassica as well as the black mustard, *Sinapis nigra*.

My object in bringing this wonderful genus to

your notice is to show the diversity of the varieties, apparently so different, and yet in reality, in the flower and fruit, by which plants are classified, they are inseparable and necessarily form one genus. This shows how cultivation has made the single talent, that God has bestowed upon us, five, yea ten-fold, in its yield and utility to man, who is thus a co-laborer with the Creating power, as man should be, to promote the natural and spiritual kingdom, by his diligence and close attention to the means placed to his hands.

I must pass over several kinds of Cress, Scurvy Grass. The Radish, *Raphanus sativus*, a native of China. The Horse radish, *Cochlearia armoracia*, which is now called by its older name, "*Nasturium armoracia*." The pungency is in the root. The water-cress, "*Nasturtium officinale*," has the pungency in the leaves. The mustard in the seed, showing a diversity of location in the unity of the principle.

Being on Root Plants, the Beet suggests itself: Grafting the Beets. Ex President Dr. Allen Maclean, of Colchester, grafted the White Silesian on Red Beet, and Red on White, when as thick as a straw, unite by mere junction of cellular matter; each class of cells secretes its own matter and color.

*Beta vulgaris*, the common Beet, from south Europe, is cultivated in many varieties. The Mangel Wurzel, or scarcity root, is a mere variety used for feeding cattle. The beet was known as an esculent root in the time of Pliny, who has given an accurate description of it in his work. One kind, called the great white or sweet beet, is esteemed for the foot stalks and mid-ribs of the leaves, which are stewed and eaten under the name of Swiss chard.

Sugar is manufactured from a variety of this beet, which has a red skin, but is white internally. The beet belongs to the natural order of Chenopodiacea, or goose-foot family, as does the "Spinach," *Spinacea oleracea*, which later comes from the Orient. The blight and pig weed come here.

Among the plants that have their flowers and seed in an umbel, the natural order umbelliferae cultivated, is the Carrot, *Daucus carota*. These have run wild and become a pernicious weed. It is, however, suspected that the garden carrot differs since the attempt to cultivate the wild has proved unsuccessful. This may arise, however, from the fact that the long continued culture and coming from a warmer climate makes

the difference. Dioscorides describes it as growing wild as well as being cultivated for an esculent root. The central portion of the root being naturally woody, cultivation in light, mellow soil, mixed with sand made friable by being well mixed to prevent the root from splitting or growing forked, and to increase the outer portion, or so to speak, the bark, and diminish the central portion or woody fibres.

The carrot is used in cookery—but it is affirmed that for stock, especially for horses, for preserving and restoring the wind, it is administered in Suffolk, England, as a secret specific for the complaint of wind-broken horses. Cows fed on carrots increase the quantity of milk. They are highly recommended for calves, sheep, and swine. In the short space of ten days, says an eminent writer, a lean hog was fattened by these roots, having consumed during that period 196 pounds. Its fat proved very white, fat and firm, and did not waste in the dressing.

The parsnip, "*Pastinaca sativa*," runs wild also in low meadows, and then rather *poisonous*. The word *pastinaca*, from "*pastus*," nourishment, is one of the names given to the *daucus* of the Greeks.

The skerret, *Sium sisarum*, is a perennial tap root, like the two former introduced from China, and little known among us. Our sium lineare, or water parsnip, growing in water or wet places, of which both root and herbage are poisonous.

The parsley, *Petroselinum sativum*, or properly *carum* *Petroselinum* variety, curled-leaved; the foliage is used in cookery. The caraway, "*Carum carui*," yields the caraway seed, Fennel *anethum foeniculum*. The garden celery, *Apium graveolens*, and variety "*Rapaceum* turnip rooted celery," as also the coriander, *Coriandrum sativum*, all belong to the umbelliferous plants; besides others used medicinally, and not enumerated.

In the order *compositæ*, we find the artichoke, "*Cynara scolymus*." The receptacles of the young flower heads are fleshy, and edible when cooked. This must not be confounded with the Jerusalem artichoke, which belongs to the sunflower genus, and is the *Helianthus tuberosus*, the tubers of which are pickled and edible.

In the privy-purse expenses of Henry VIII, of England, in reference to the first named artichoke, is this entry: "Paid to a servant of Maister Tresorer, in reward for bringing *archecokks* to the King's grace to Yorke Place, 4s. and

4d." A treatise was written in the reign of Mary on it.

Our salad or lettuce (*Lactuca sativa*) belongs to this family. Turner mentioned the lettuce as being in 1652 well known. In the privy-purse expenses of Henry VIII, in 1530, it is stated that the gardener at York Place received a reward for bringing "lettuze" and cherries to Hampton Court. We have a wild lettuce—the *lactuca canadensis*, but this does not form in heads or dense leaves. What a series of years under cultivation would effect is not known, nor likely to be tried, so long as better sorts are to be had.

The endive, "*Cichorium endivia*;" the blanched leaves are used. Succory, chicory or wild endive, *cicorium entybus*, is cultivated in England and Britain. The root is used as a substitute for coffee, or mixed with the exotic berry. The *Cichorium intybus*, so common along roadsides, and a pernicious weed, has a deep root, and is used as a substitute for coffee by many persons in this country.

The rhubarb family—"Rheum"—belongs to the order *polygonææ*. But alas! what shall I say of the order *leguminosææ*, including the pea, bean, kidney bean, Vetch, lentel, &c., with numerous varieties obtained through long culture.

The *solanacææ*, or night shade family; embraces the potato, *Solanum tuberosum*. The tomato, *Lycopersicum esculentum*. The cayenne or red pepper, "*Capsicum annum*," and the *C. cerasiforme* has an ornamental cherry-like fruit, either bright red or yellow, of peppery taste. This differs from the Jerusalem cherry, "*Solanum pseudo-capsicum*," a shrubby house plant from Madeira, cultivated for the ornamental bright red berries, resembling cherries.

The strawberry-tomato, "*Physalis alkekengi*," or ground cherry closed, within the bladder-like inflated calyx in fruiting, with a red berry, edible; is an introduced species, but differs little from our native species, *P. Pennsylvanica* and *P. viscosa*, which are also edible. This family embraces the tobacco, many medicinal plants and ornamental flowers.

Before leaving this family I would notice the potato more fully. Loudon wrote, many years ago, that "the varieties of the potato are innumerable," they differ in their leaves and bulk of haulm: in the color of the skin of the tubers; in the color of the interior, in time of ripening; in being farinaceous, glutinous or watery; in cooking readily or tediously, etc., etc.; and final-

ly, in the soil which they prefer. The manner of raising new varieties and their culture are treated at great length. Among other things he says: "It is ascertained beyond a doubt that sets taken from the top or watery end of the potato, planted at the same time with sets taken at the root or mealy end, will ripen their tubers a fortnight sooner. It is ascertained, also, and accounted for on the same general principle, that the plants raised from unripe tubers are both vigorous and more early than such as are raised from tubers perfectly ripe. Sets should always be cut some days before planting, that the wounds may dry up; but no harm will result from performing this operation several weeks or months beforehand, provided the sets are not exposed too much to the drought so as to deprive them of their natural moisture."

After enlarging on the various modes of culture, he says: "Pinching off the whole of the potato blossoms is a part of after-culture not unworthy the attention of the farmer. This may, at first sight, appear indifferent. But when we consider that the seed is the essential part of every plant, to perfect which the ultimate efforts of nature are always directed, it will be allowed that an important part of the nourishment of every vegetable must be devoted to this purpose, since the weight of the potato apples grown by a single plant is considerable. Apples may be produced instead of tubers in early potatoes; hence more tubers will be produced in late ones by preventing the growth of the apple."

He mentions the mode of after-culture in Devonshire, England, which is somewhat singular, and deserves to be noticed; it may be new to you, as it was to me. He says: "The sets are there generally cut with three eyes, and deposited at the depth of three inches with the spade or dibber; when the first shoot is three inches high, prepare a harrow with thorns interwoven between the lines, and harrow the ground over till all the weeds are destroyed, and not a shoot of the potatoes left. It may seem strange that such an apparent destruction of a crop should cause an increase; but it may be affirmed as an incontestable fact, that by this means the produce becomes more abundant; the reason appears to be this: although these eyes are left to a piece of potato, one always vegetates before the others, and the first shoot is always single, that being broken off, there is for the present a cessation of vegetation. The other eyes then begin to vegetate, and there appear fresh shoots from

the broken eye, so that the vegetation is trebled, the earth made loose, and the lateral shoots more freely expanded. If these hints are observed, the produce of potatoes, it is said, will exceed a fifth of the crop obtained by the usual mode of cultivation."

Much more useful information for sprouting in order to raise early crops: it is common among the corn raised, after a crop of potatoes, to find plants that sprung from tubers preserved there all winter in consequence of having been buried by the plow deeper than the frost could reach, is evidence that they may be planted very early in spring.

Before closing the subject of the potato, I would state an opinion that presented itself to my mind in the study of the potato disease so prevalent—which is, that by excess of culture, or using tubers for sets that were large and thoroughly ripe, there was not enough vegetating principle left to yield a healthy plant, and premature rotting was the consequence. Apart from insect devastation, those intended for seed should be taken up before fully matured, as in that case a latent energy will be left in the tuber; this I am aware may seem exceptionable, as all other seeds seem to require to be thoroughly ripe; but a potato is not, strictly speaking, a seed; it is rather a seed-root, and this makes a difference.

The Sweet Potato belongs to the natural order of convolvulaceæ, which includes the morning-glory: the *Batata edulis*, a native of India. It is remarkable that this belongs to the same genus as the "*Batata Jalapa*," which is a Mexican purgative species—the Jalap of the drug store. The sweet potato is also known as the "*Ipomœa batatas*," and the root yielding the Jalap as "*Exogonium purga*," but is generically the same in the estimation of some authors. Dr. Gray includes it among the *Ipomœa* Morning-glory family, among which are many ornamental flowers. The Cypress vine is the *Quamoclit vulgaris*, formerly included among the *Ipomœa*—the cucurbita, cucumber, pumpkin, squash, &c., verbal.

The order *Lilacæ*, containing so many different genera and species of pretty flowers, also embraces the Onion, Leek, Garlic, Shallot, Chives, &c.

The onion, "*Allium cepa*," and its numerous varieties. The garden garlic, "*A. sativum*." The garden leek, "*A. porrum*." The Shallot, "*A. oescalonicum*." The chives, "*A. schœnopr-*

sum.' The asparagus is a sub family. The *A. officinalis*, cultivated for its esculent spring shoots. The liliacæ is a very extensive order, grouped in families: Trillium, Melanthium, bell-wort, asparagus, lily proper, as types; each family has numerous genera, and these each again numerous species. As I have said so much about culinary vegetables, I may be allowed to be a little flowery, and simply refer to the cultivated genera of the lily family proper: first, the orange red and southern red, wild species of sandy soil; the wild species in moist meadows and bogs: the Canada, American, Turk's cap, and Carolina. Among the introduced is the bulblit, bearing in the axils of the scattered leaves, and the tiger, bulblit bearing, with its cottony stem; the turban, flowers small, somewhat bearded inside, from Europe; the Turk's cap or martagon; the Japan; the golden banded; the common white; the Japan white, and the long-flowered white, also from Japan—all beautiful flowers; and the lilies, the crown imperial—*Petilium imperiale*, is the fritillaria, from the Latin fritillus, a dice box, from the shape of the flower 'F. imperialis.' The guinea-henflower, mostly solitary, purplish, tassellated with blue and purple, or whitish, is the *F. meleagris*. The common and the sweet tulips, of all colors, single and double. The dog-tooth violets, growing wild; *Erythronium*, including the "adder's tongue," yellow and a white species. The Star of Bethlehem, called ornithogalum—the name in Greek means "bird's milk," a current expression for some marvelous thing. On the first of April I have heard of boys being sent for "pigeon's milk." Why the plant was so named, I do not pretend to know.

The hyacinth, dedicated to the favorite of Apollo hyacinthus. The "Agapanthus," which in the Greek means "amiable flower." The Funkia, named after a German botanist, Funk, is a white day lily. The *F. ovata* has blue or violet flowers. The "day lily" also refers to two species of "Hemerocallis," which in the Greek means "beauty of a day," as the flowers speedily wither. The *H. fulva*, a familiar species, with tawny orange flowers; *H. flava*, fls. light yellow. The curious flower tritoma, as the Greek signifies, thrice cut. The *T. uvaria*, from Cape of Good Hope a specimen was given me by H. L. Zahm, the name of which I could not find nor make out till after a long search. Then comes the yucca, "Adam's Needle," or common bear grass, tall and beautiful plants. The

*Yucca aloifolia*, or Spanish bayonet or daggers, I saw in flower for the first time last summer in the garden of C. B. Grubb, Esq., of this city. He had it about nine years growing, but it never bore flowers till last summer—truly a beautiful plant, with its pyramid of white flowers; terminating a bushy stem, with the leaves all elevated about ten feet from the ground, and pointing nearly vertically above, gradually declining to horizontal; then more depressed till almost vertical again, in regular order, forming a singular top of rigid leaves tipped with a spine strong enough to kill with, while above these spreading leaves is a large, dense pyramid of flowers, a very interesting ornamental tree; but like the century plant, it takes too long to flower, and it is said that after it has flowered it loses its pretty form, and flowers "no more." An excellent closing sentence.

---

#### NOTE ON POTATOES.

BY J. M.

Great difference may be observed in the raising of Potatoes. In planting my sets, last spring, of Early Goodrich, I was compelled, from scarcity, to use some very small ones, and some made from what is called a second growth. The yield was very poor, and the quality inferior. Very many of them were knotty, and showed a disposition to make many additional growths, lessening the value of the crop very much. My slight experience will lead me to the selection of sets made from Potatoes of fair size, and cut into one or two eyes. It is no matter if they are cut small so that the cut is from a good sized Potato.

The soil should be ploughed or dug very deep for their culture. Some sets planted in a lot of ground much poorer than a lot opposite, produced a better crop, though planted later. The cause, I think, being in the former having been ploughed deeper.

---

#### THE LOMBARDY POPLAR TREE.

BY CHRONICLER.

*Populus dilatata* is a native of Italy, and by being distributed first from nurseries in Lombardy, it got its common name, "Lombardy Poplar." It has been grown as an ornamental tree throughout Europe, for the past six score of years, and is still a deserving favorite there. It is one of the fastest and tallest growing trees we have in cultivation, and flourishes in a great variety of

soils and situations. It thrives well upon the Isle of Malta and the Island of Orkney; and after being properly set out, it requires no further care. In habit, it is erect, lean, stiff and very lofty, with a comely transparent foliage. During the first twenty-five years of its growth, it forms a very ornamental tree, and retains its beauty for ten to twenty years longer, according to circumstances; after that, it rapidly declines, and becomes an eye sore among other trees. Improvers may set out a few young trees every ten years to keep up the species and maintain the fullness and beauty of their arboretums, and eradicate the old trees when they fail. The young trees should not be set near to buildings, nor near roads, as their surface roots are half above the ground, and make the surface around them very rough and uneven.

During the past ten years, the Lombardy Poplar has been extensively set out as street shade trees in cities and towns, and seems admirably suited for the purpose; being of rapid growth, and by the annual pruning it gets there, it forms a round headed and bushy tree, and free, so far, from insect ravages.

In the early quarter of the present century, our wealthy citizens were smitten with a sort of mania, by the healthy, rapid growth and simple growth of the Lombardy Poplar tree, and set it out plentifully as embellishments to pleasure grounds, and long lines of it were set on river fronts and alongside principal roads leading out of cities and towns. They all grew handsomely in their early years, but were not time proof. So now, wherever we go, we see the ghosts of those early planted trees standing like shadows of death to bring discredit upon our arboriculture. We earnestly beseech all patriotic citizens, who love the beauties of modern rural improvements, to have those old, unsightly trees uprooted, and plant young trees of the same species upon other spots of their pleasure grounds. To let those leafless and half leafless emblems of death stand longer, will bring us national disgrace, and a slur upon our boasted civilization.

[We have recently seen it stated in an English periodical, that the Lombardy Poplar is subject to a disease in the United States, which is carrying them off. This is surely a misinformation. As our correspondent well says, they soon arrive at maturity, and then decaying branches die away, and give an unsightly look. But for a quarter of a century at least, young trees keep up as healthy an appearance as any tree can

have. In the West, they are being largely planted as street trees and wind breaks on farms. Some towns in Illinois have little else but the Lombardy Poplar in them.—ED.]

●●●●●

### BEAUTIES OF AMERICAN FOREST CLUMPS OF DECIDUOUS TREES IN SPRING.

BY WALTER ELDER, LANDSCAPE GARDENER,  
PHILADELPHIA.

They are in winter like "desolated wastes."

"Yet soon reviving plants and flowers

Anew shall deck the plain.

The woods shall hear the voice of spring

And flourish green again."

Early in April before any of the trees expand their foliage, the *Judas Tree* garnishes the skirts of the clumps with its deep, rosy blossoms, like a glowing fire to warm up a wintry desert; and before its blooms fade, the *Dogwood* puts forth, and illuminates with its large blossoms of spotless white. The famous *Timber Cherry tree*, of gigantic stature, accompanies the *Dogwood*, also with blossoms of white. The *Sheepberry* follows in rotation, with hawthorn like blossoms of white in profusion. Next comes the *White Locust* with blooms, both gorgeous and grand, and delightfully perfumed. The *Tulip tree* so lofty and wide, expands its large tulip like blooms of yellow; a masterpiece picture magnificently grand. The *Wild Cherry* next puts forth neat spikelets, with florets of white. Then the *Catalpa* tree is clothed in gorgeous profusion, with blossoms of rich waxy white. The *Elder* and *Sumach* accompany each other, with blooms in large clusters, of yellowish green and sweet scented white. The *Magnolia glauca*, so famous for beauty and fragrance, displays its glory in June. Then comes the noble *American Linden* with florets of yellow so sweetly perfumed. Our native *Chestnut*, magnificent, comely and grand, brings up the "vanguard," with spikelets of blooms of yellow and green, in great abundance.

Among under shrubs, the *Azaleas* of various species and colors, bloom in April and May. The *Kalmias* are also of various species and shades, from pink to deep rosy red, and come on in time to succeed the *Azaleas*; the beauties of both are almost indescribable. The humble *Bramble* (Blackberry) is also very showy with its white blossoms.

The surface of the ground is also clothed with dwarf, showy, herbaceous flowers, which are the *Violets*, both white and blue. *Anemones* of

white, and *Hepaticas* of blue. *Fritillarias*, white and pale yellow; and along with them are *Trilliums* of various species and colors. The *Epigæa repens* creeps upon the ground with its white waxy blooms of Hyacinth perfumes. There are many other species of beauty, but too numerous to mention. Oh! that we could induce our people to teach the rudiments of botany to our youth in our common schools, then they would admire the beauties of vegetation in all their travels, and exult in their praises of the great *Architect*, who first commanded the ground to bring forth "the grass, the herb and the fruit tree."

### NOTES FROM CONTINENTAL JOURNALS.

BY THE EDITOR.

**DISEASES OF PLANTS.**—We think we in America suffer some from Plant diseases, but Linden's *Illustration Horticole*, published in Belgium, says: "The number of maladies which ravage cultivated plants is truly disheartening." "There is the grape oidium, the potato disease, the Verbena rust, the China Aster trouble, mildew of all kinds, the Phylloxera, and many others forming a vast army which is daily reinforced by new recruits." Perhaps our lot in America after all is not so bad as we often think it is. We did not know before that the Verbena rust prevailed in Belgium,—we suppose it is an introduction from thence to our shores. They now complain that there is serious trouble with their Aucubas, from a disease which baffles all treatment.

**PLUM INSECTS.**—In France the plums and cherries are being damaged to an alarming extent, by a small insect (*Hyponomenue padella*). Oil floated on water, and applied with a syringe, is the most popular remedy.

**IRISES.**—The Continental Journals report that the collection of Iris grown by M. Max Lichtlin, whose articles in past numbers of the *Gardener's Monthly*, on Lilies, have interested so many of our readers, is one of the finest in the world. M. Duchartre is getting out a descriptive catalogue of them.

M. UNGER, an Austrian, and one of the rising botanist of Europe, was recently assassinated at Vienna. He had barely reached middle age. It is surmized that a prejudice, that his science was opposed to established truths, was the cause

of the violence offered him. He was as outspoken in what he believed truth, as Huxley, in England.

**THE BOTANIC GARDEN** at Brussels, in Belgium, has been purchased by the government for the benefit of the people, as the Kew Garden is in England. *L'Illustration Horticole* says, that the names of the commission entrusted with the matter is a guarantee that science as well as the community will profit by the change.

**EGYPTIAN AGRICULTURE.**—A new work entitled the *Egyptian Agriculturist*, was started at Cairo, in Egypt, on the 1st of June. This looks like returning toward its ancient glory, when there was "corn in Egypt," though other lands failed.

A NEW GERMAN *Horticultural Journal* has been started in Hanover, at Ringelhiem. It has a French title, *Reveu Horticole*, the same as one already in existence in Paris. It has the peculiarity of being published in three languages—English, French and German.

**CHANGING THE COLORS OF FLOWERS.**—The *Mirror of Science* says, that a case is known of a yellow primrose, which, when planted in a rich soil, had the flowers changed to a brilliant purple. It also says, that charcoal adds great brilliancy to the colors of Dahlias, Roses and Petunias; carbonate of soda reddens pink hyacinths, and phosphate of soda changes the colors of many plants.

**POLYMNIA EDULIS.**—Last year we noticed the introduction of this new vegetable to the United States, and that seeds were for sale by Thorburn and other leading seed men. If any of our readers succeeded in raising any, we should be glad of their experience for the readers of the *Monthly*. It continues to attract much attention in Europe, where it was introduced from Bolivia.

**DACTYLANTHUS TAYLORI.**—This is a wonderfully curious plant, from New Zealand; and is there a parasite on the branches of *Pittosporum tataka*. It forms in appearance a large warty excrescence, without any leaves, but has very sweet white flowers, which are sometimes tinted with rose. The odor is represented as being like a well ripened melon. No very clear descriptions have been seen by us, but we suppose it may be a Lorantheaceous plant, which abound in that quarter of the world, and to which order our mistletoe belongs.

## EDITORIAL.

## TRAVELLING RECOLLECTIONS.

As long as we can recollect, Syracuse, N. Y., has always been a point we wished to reach. Its extensive nurseries, its wonderfully healthy trees, and the great reputation of Brown Smith for intelligence and business integrity, made a call on the firm now known as Smith, Clark & Powell, a necessary part of our ride through New York State. We found the firm still young, notwithstanding the length of time the business has been going on. Mr. Powell is son-in-law to Mr. Smith, and will be a worthy successor when the hand of time shall tell more heavily on the senior than it has yet done.

Syracuse is a remarkably pretty town, deriving its chief commercial importance from its salt springs. Salt manufacture is carried on to an enormous extent, and adds largely to the wealth of the place. A very curious study for the naturalist is the salt plants of this region; that is plants which are usually only found by the sea shore, and are usually denominated in works on botany as marine. When the first settlers came to Syracuse, there was but one small salt spring known, and that not flowing freely. The Indians, it is said, used this spring. It is most probable that the water from this little spring did not cover many yards, and the marine plants one would expect to be very few if any. Now, since wells have been sunk, and the water pumped to the surface, of course salt streams flow every where. These salt water plants now abound. We had not time to note how many species could be found there; but it seemed as if one might find as many as there is in any average locality by the sea side. But it is not set down in the works that species can originate in different places, and yet be of the same kinds. That is *spontaneous generation*, and it will not do,—or it is not in accordance with another modern view, that species are the result of circumstances, the one species outgrowing from something else. The circumstances are never exactly the same in two distant localities, therefore, all individuals of one species must be emigrants from one central point. It is hard to believe all these maritime plants of Syracuse emigrants,—harder yet to suppose they are spontaneously generated,—and yet if not here at the foundation of the town, how did they come?

But to more horticultural recollections, It is pleasant to note that Syracuse is fast becoming a horticultural town. Unlike many places we saw in New York State, there was a very large amount of gardening amongst the wealthier classes, and many of them exhibit admirable taste. The town gardens of the following gentlemen were amongst some that are particularly worthy of mention: Hon. E. W. Leavenworth, Hon. Allen Munroe, Messrs. John Greenway, Frank Hiscock, J. W. Barker, N. S. Geddes, Harvey Stuart Geddes, — Thompson, George M. Kennedy, Hon. George Comstock, Hon. C. B. Sedgwick, — Fowler, D. P. Wood. This last had a particularly pretty place. It seems to be about six acres, and was laid out, if we recollect Mr. Wood right, by Mr Hastings, of Connecticut. The surface is made beautifully undulating, and the directions of the walks combining utility with elegance, in a very unusual degree. Excellent use is made of arbors, weeping trees, masses of shrubbery and single specimens. Even the common hop was turned into an object of beauty by being made to run over an octagonal wire frame, and then led on to wires connecting over head, forming at once an arbor, and growing the hop at the same time.

On the ground, a little distance from the house, and on a slightly elevated spot, showing well as an object of great beauty, is a block of plant and fruit houses. Peaches and grapes were chiefly grown in the main wings,—the smaller one was tastefully arranged, for the plant department. Usually a place planted for effect affords little scope to the lover of rare trees and plants. Here the two tastes were happily blended. The number of rare trees and shrubs was remarkably large—a specimen of *Virgilia lutea*, a more properly *Cladastus tinctoria* was particularly fine. Mr. Wood is quite an enthusiast in rare trees, and takes as much pride in them as in the general beauties of the place. It is rarely that we enjoy so much pleasure as our visit here afforded us.

Quite near to Mr. Wood's is the residence of Dr. Boynton, who, to a very high fame as a geologist and man of science, unites a great love of fruit culture. In pear culture, the name of Dr. Boynton is particularly well known. Some of the finest pears ever exhibited at the Pomological Society's meetings, were undoubtedly those



from Dr. Boynton, which were exhibited in Philadelphia at one of its past meetings. We did not expect much here, because it was generally conceded that his fruit trees were "gone to the dogs," as remarked by a speaker at one of our horticultural meetings. It was, therefore, with extra pleasure that we noted that they were on a very prosperous return from the said canine excursion. There were indeed traces of a severe struggle—many of the trees had passed away altogether, and a few were still stunted and sick, but the majority had recovered, and those which were fully in bearing had the most lovely fruit, and the most healthy, vigorous leaves and branches it was ever our good fortune to see. The story of this orchard, its troubles, and its recovery is not without its moral,—both to that class which advocate the "Luciferian," as well as to those who adhere to the "Nebuchadnezzarian" manner of culture. Dr. Boynton was at one time a zealous advocate of clean surface treatment,—and perhaps rather disposed to persecute those who did not adhere to the laws of the pomological prophets of the past times. His phosphates and peculiar manures had an undoubted effect; but in spite of some theories about the injury of over manuring fruit trees, there is no doubt that they are benefited by high feeding, if the food is given them in a proper manner. Then another advantage was, that the trees had all been set on terraces made for them on a hill side—not deep terraces, which often hold so much moisture as to defeat the ends for which they were formed, but shallow lines but a few feet at the deepest point. Until the roots extended, so as to get pretty well in the way of the cultivator, all went right. The growth of the trees was all one could wish, as they generally are under such circumstances. Gradually, however, they began to suffer, and every year more and more, until one year, about seven years ago, if we recollect right, after the usual heavy summer cultivating, the trees had evidently received a severe shock. The leaves were red long before the proper time for them to fall in autumn, and the next winter and summer many had an immense number of dead branches amongst them. The doctor was disheartened, and about this time Mrs. Boynton dying, and other matters lessening his zeal, the whole orchard was abandoned to utter neglect. Canada thistles, wild carrots and other coarse weeds grew up about them in every direction, and came up, grew and died away just as they

came, without any interference from the owner. But a few years ago he noticed that under this neglect they were gradually mending. His interest was renewed. He cut the dead and half sick branches away. In many cases they were cut down to just above where they were budded, and the result is marvellous. He cares nothing more for clean surface. He top dresses, using considerably of salt, in spring; and all or nearly all pruning is done by hand as growth is going on. He is very anxious to always have a good, vigorous growth, continually renewing itself from near the ground, if possible. Hence if he sees a strong shoot coming out from the trunk, instead of pulling that shoot out as most people would do, he encourages it to grow more and more; and this is how he does it: He pulls or breaks off all the strong shoots on the branch above it, leaving, however, all the leaves possible which are necessary to ripen the fruit on it, and after a year or so when this sprout is strong enough to bear its own fruit the part above it is cut off. This shoot itself is to go away if it is at all probable a better one can be got out from below it at any time. He thinks, and we are half inclined to agree with him, that by this species of renewal system, any old sickly trees can be rejuvenated and recovered, as these certainly have been. On the southwestern side of the orchard is what was once a carefully pruned and trained vineyard. The annual expense of "culture" of this was some hundreds of dollars. Under the present system grapes were particularly abundant, and of excellent maturity and quality. Certainly we think that some little attention more than what they now received, would have been better for them,—but here was the self-evident fact that they were much better, even under a totally let alone system, than they were under the generally received plans, while there was the advantage of no expense. The apple and the plum were equally luxuriant. We think that for productiveness and quality combined we never saw a better tree of the Pinate apple. We are, by the way, astonished that this good variety does not rate higher as a very early variety.

Now we do not wish to be understood that this orchard should be held up as a model to copy after. We should not like to have an orchard in which we had to beat the thorns and thistles away before we could get near the tree to gather the fruit. We are too fond of beauty. It would suit us even to sacrifice a little of the health of the tree for the sake of appearances

But we do hold that the Dr. Boynton's experience here illustrates the true principle on which an orchard should be managed, if we would have the best results in health and productiveness, namely, the best possible encouragement of the fibrous feeding roots at the surface, with the least loss of food to the tree. This last point Dr. B. still thinks an unsettled problem. He does not think grass altogether the best thing. Of all vegetable matter he thinks so far the wild carrot is the best. When it comes up in spring, its leaves spread many inches flat on the ground on each side, and smother out every particle of vegetation but its own. Its own roots go deep down, and bring up its food from some depth, leaving considerable of the surface food, for the fibrous roots of the pear. Hence there is the greatest possible surface covered with darkness, and a cooling vegetation, whilst there is the least possible quantity of roots to dispute on the food question with the pear tree. Then the immense amount of decaying vegetable matter left by the decaying mass of carrot stalk, which he would suffer to lie as it fell, helps to increase rather than to decrease the fertility of the soil. He thought that under some such a system as this, the soil might annually be kept up in fertility, without the addition of much top dressing, and with a perpetual health and vigor in the trees. Of course these are mere ideas, as we did not understand Dr. Boynton that he should actually sow his orchard in carrots; but we were much struck with the view of true philosophy with which he discussed these things, and have no doubt our readers will profit by them. Altogether our visit to Dr. Boynton was one of the pleasantest experiences of our visit to this interesting town.

But we must not forget a call on Mr. W. Day, an English gardener, who has been very successful in establishing himself as a florist. He is famous in the place for the superior native grapes he raised. Truly they were marvels of beauty. They were trained on rather tall horizontal trellises. They were, we believe, in the second year of their bearing. It is said that Mr. Day has often been pressed to communicate to his friends and visitors the secret of his wonderful success in producing such fine bunches, but always has declined to satisfy this natural curiosity. On the present occasion, however, feeling honored by a representative of the *Gardener's Monthly* being so much interested in them, he communicated to us in a whisper what the mys-

tery was: "I lets 'em alone." He didn't know of anything else he did. His soil was one through which water passed rapidly away. He "laid in" all strong young wood he could get room for, cutting away the small useless spray,—and perhaps cutting off a few bunches at the end of a bearing shoot, when there was perhaps too many to mature properly—only this, and nothing more. It was not a great secret,—yet judging by what we hear and see all round, it is one which with many seems very hard to understand. As we said of Dr. Boynton's orchard, we don't know that we should follow it exactly. We are too much enraptured with a little art,—but it is only the principle we would illustrate. Mr. Day's varieties were the Delaware, Israella and Iona, and Hartford Prolific, besides another, a seedling of that town raised, if we remember right, by a Mr. Latham, which was as good, but seemed much earlier than Hartford Prolific.

Grapes do very well about Syracuse as a general rule. Across the way from Mr. Day's were some very fine vines trained on upright stakes. Here we saw the Allen's Hybrid, finer than we ever saw it in the open air before. We feel like taking back an opinion that we have given before in our magazine, that this is not a true hybrid. Of course Mr. Allen applied the pollen of two species, and raised this as the result, but our idea was that the cross impregnation was not real. The pollen did not "take" as one might say, though supposed to have done so. But here in these vines, there were much less of the characteristics of the foreign—more of the native than we had ever seen before. We begin to feel that we know nothing at all about the *species* of grapes, and shall leave the classification of varieties—that is the referring the varieties of our native grapes to their original species,—to those who know more about the matter than we do. We had, as we thought, tolerably clear ideas about this ten years ago; but we have lost confidence in our own wisdom now.

But the great centre of Horticultural attraction is the Syracuse nurseries. These contain over 500 acres, and are chiefly devoted to fruit trees, of which the pear and apple are grown in immense quantities. Some varieties—the Bartlett and Seckel pears for instance—are grown by the acre. The soil and climate here seem especially adapted to fruit trees, for we have never seen nursery stock healthier, and very few in fact so healthy as those we saw here. The extent of the business done by this firm may be

appreciated in no way better perhaps than by the fact that they use one thousand of those large eight or nine feet packing boxes a year for the transportation of their trees. No doubt much of the fertility of the soil is due to the presence of saline particles in the soil or atmosphere; but in addition to this Mr. Smith tells us he employs salt freely in many cases as a manure, and finds it of particular benefit to the plum and peach. He had often recommended it to distant customers, but finding a general impression that his advice was given because "possibly he was interested in some salt works," he had not said much about it of late years. His first discovery of the great benefit of the use of salt was in the treatment of the larvæ of the cockchafer or May bug, that terrible scourge of many a nursery. He found them in large numbers devouring the roots of the peach trees—and drawing a drill on each side of the row, put in a little salt. The grubs left in disgust. He expected some injury to the trees, but they grew as never trees grew before,—and he has since profited by the lesson.

A feature of the nursery of which Mr. S. is justly proud, is a hedge of Honey Locust, along the turnpike road, bounding his nursery. It is strange that such examples as is before the public, showing how cheap a live hedge is—how beautiful they are—how easy they are managed—how really protective is their character instead of the "get over me if you please" look of a post and rail fence—should have so little effect. It would seem as if the whole world delighted to spend money for the fun of it, and have nothing to show for the money spent. The Honey Locust is an admirable plant for cold climates, and is far better than any other plant where the soil is rather poor or thin. There is one advantage in the Honey Locust which no other plant has. The Osage Orange, for instance, has thorns on its young growth, and that is the end of them,—but thorns come out of the old wood and continue to come out year after year,—branching and growing simply as thorns, and nothing will ever dare to go through a hedge of this plant even though there should be a tolerably large gap invitingly open.

Across many parts of the nursery, breaking off the cold winds from the rough quarter, are hedges of Norway Spruce. These are left to grow up rather larger than usual, but this we think rather an advantage where land is abun-

dant. We would rather let them grow up to be trees, thinning them out as they approached each other, until at last we should have timber of valuable size for use. Land is, however, not so very cheap now at Syracuse. It always goes up in the vicinity of an active, enterprising nursery firm. At Geddes, a small suburb of Syracuse, land worth only \$200 per acre four years ago, when these gentlemen bought some for their nursery purposes, sells for \$400 now.

The trees about the beautiful residence of the senior member of the firm shows how rich is the soil of Syracuse. The Horse-chestnut is particularly a good measurer of a soil's fertility. Here they grow with an unsurpassed freshness, as also does the Mountain Ash—a specimen of the English variety—or rather Scotch, for it is not a native of England, is the largest we know of—perhaps one of the largest in the Union.

Not by any means the lightest of the attractions of Syracuse to a horticulturist, is Oakwood Cemetery—a tract of about 100 acres very well laid out with walks and drives through the prettily rolling ground, covered rather thickly in many places with a natural timber of red and white oak and hickory. These have of course been thinned out considerably to allow of burial purposes,—and in many of the more open spaces evergreens of the more common nursery form planted. The Norway Spruce is of course employed, but it is kept cut down to form a thick bush in many cases, which, if continued, will keep it from growing too large to be an annoyance. There is here one of the prettiest pieces of natural scenery we have ever seen of a perfectly rural character. The main road winds around, in one place, the base of a rather steep hill, clothed thickly with the deciduous trees before said. The under-brush, however, had all been taken out, and its place completely occupied with mosses, ferns and herbaceous plants like Solidagos, Asters and others which are at home in such a shaded situation. Natural as the effect was, it was yet like no natural woods one generally sees. The woods were well kept, and the grass neatly mown, and what good landscape gardeners would call an easy blending of nature and art, was never better secured than as we saw it here. Still, art has not been content to yield quietly the palm to nature, for there is a magnificent reception vault, the cost of which is said to have been about \$10,000.

## SCRAPS AND QUERIES.

USE FOR TREE TRIMMINGS.—What to do with the clippings of trees need never be a question. The rough twisted and gnarled pieces make excellent rustic work, which always gives a garden much interest. The worst of this kind of mechanism is, that if exposed to all weathers it soon rots, and it does not seem worth the labor it takes to put it together. So only that should be made up with the bark on, which can be placed under cover in winter. Where rustic work is to be left out at all seasons, it should be built of pieces with the bark removed. This, to be sure, detracts from its interest. The bark, rough and shaggy, is one of the charms of rustic work. But this effect may in a measure be re-

stored to the denuded branches, by painting with various shades to simulate differing barks as much as possible. All this is for ugly and twisted pieces. But neat artistic things of many designs can be made of straight pieces. To make a long settee, for instance, the kneed pieces make the back and legs, and a seat is made of rough pine boards. Then various figures which can be made of straight pieces, such as diamonds, squares, octagons, or any fancy forms whatever, are chalked on the frame, and the straight pieces are sawed to the lengths required, split, planed with a knife, and nailed on—the whole when finished, varnished. Even tree roots may be made into very nice garden

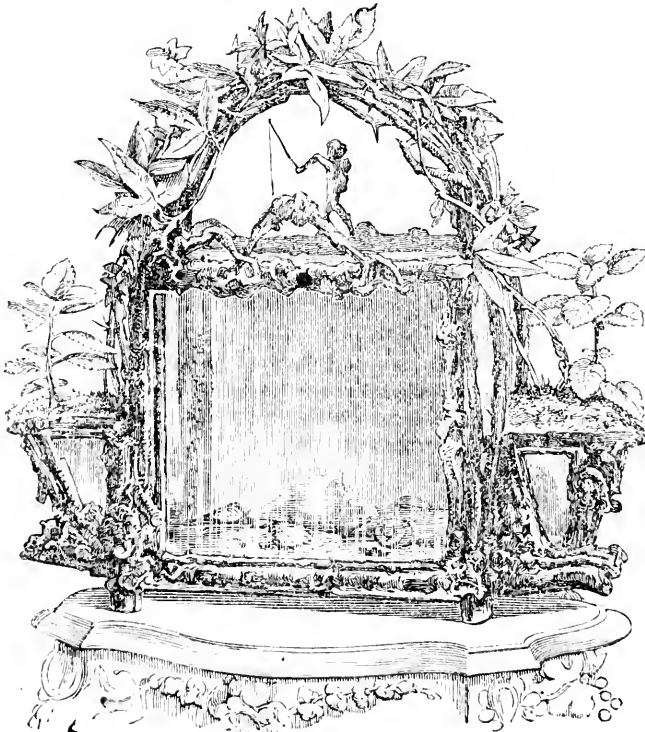

ornaments. We saw a combined aquarium and plant vase recently made entirely of roots of Bramble and wood laurel, of which we have made the sketch we give herewith. Even the little fisherman standing on the edge is a naturally formed root, the which if any such had been discovered in ancient times, would assuredly

have been supposed to portend some great disaster to the human race, as so many similar things in plants have done. On the two sides of the aquarium are the two vases, formed by a hexagon of boards, two of the sides having mirrors, and the rest faced by the little pieces of roots aforesaid.

Now, the straightened brush wood, or trimming, can be turned to other useful purposes. Of course everybody knows how nice it is to have plenty of rough stakes to tie up things to; but after all this remains the small twiggy stuff, which is usually burned. But recollect what we have before said in the *Gardener's Monthly* about its value in growing *Rhododendrons*. You have to dig out the ground, say two feet deep; put in a layer a few inches of this small trash, then a few inches of the soil thrown on it, more brush, more soil, until the hole is full, and you have the best *Rhododendron* bed in the world.

MR. S. MILLER, formerly of Lebanon, this State, is now associate editor of the *Western Gardener*.

DEATH OF A NURSERYMAN.—Mr. Wills, a well known and respected Nurseryman of Bloomington, Illinois, is among the recently deceased.

THE TROPHY TOMATO seems to bear out a very good reputation, after a year's trial. We hear it well spoken of all round.

VITALITY OF EVERGREEN SEEDS.—A Canadian correspondent says: "I had some evergreen seeds tried for me by a friend in his greenhouse two years since. The pans were laid aside with the seeds as it was thought they would not grow. More than a year after, they all came up in *full trim*."

[These were probably such as Holly, or Juniper, or Yew. They will remain several years sometimes in the soil before they grow,—but such evergreens as Pines and Spruce soon die in the ground,—generally, if they do not sprout within two months, they will never come. This, too, is remarkable, as out of the ground, in a place that is not very hot or dry, their vitality remains for several years.]

CASTOR OIL POMACE.—*W. H. G., St. Louis, Mo.*, says: "There is now offered in our market as a fertilizer the pomace of the castor bean, or the residuum after the oil has been expressed. It is claimed for it that if spread upon a lawn the moles will leave the premises; also that a small portion of it spread about the roots of cabbage, egg or tomato plants, in the spring, will drive off the cut-worm. Will you please let me

know what truth there is in this, and what value it possesses, if any, over ordinary barn-yard manure. All in this neighborhood last year lost almost their entire potato crop from the ravages of a yellow striped bug. I have thought of sprinkling this over the ground next spring after planting my potatoes, if you think it advisable. Would it do any good to spread it under peach and apple trees to drive off the borer and curculio. If valuable, any amount of this pomace can be had here at a low price."

[We have had no experience with this article, and can lay our hand on nothing that gives any information about it. We know that, as a general rule, all oily matters are very offensive to insects; and if there is any left in the Pomace, it is very likely to have the effect claimed for it, and will be of much value as a manure.]

ST. LOUIS TOWER GROVE PARK.—We see it stated that this is going on to very nearly completion. \$200,000 was the sum appropriated for the purpose, and the total cost will be within this sum. This is a very unusual thing in works of this description, and is highly creditable to all concerned.

VIBURNUM Plicatum.—This beautiful plant, so named by Thunberg, is now getting pretty well known. It is found, however, not to be a good species; but the sterile form of another kind, also named by Thunberg, namely, *Viburnum tomentosum*. It is a native of Japan.

WOODS OF CHINA.—Southern China was once, in all probability, a densely wooded country; but the populousness of the country has demanded every strip of ground for cultivation. Almost all the arboreal vegetation of China is confined to the grounds around the temples. *Liquidambar formosana* exists near Canton, but only in the shape of sprouts; as soon as they push up to be half an inch in diameter they are again cut down for *fire wood*.

COLFAX STRAWBERRY.—We saw some beds of this last year, without a single berry, and the owners were denouncing it in high terms. It is a pistillate, and must have another near it to fertilize. In this respect it is like Hovey's Seedling, and others of that class. Where it has had this opportunity, we have seen it with very heavy crops, and every way satisfactory.

PEAK'S EMPEROR Strawberry is very much like *Agriculturist*. Mr. Purdy, of Palmyra, says it does well on the sandy soil of South Bend, while the *Agriculturist* does not. It seems better suited to this than the *Agriculturist*. In the sands of New Jersey, however, the *Agriculturist* does very well.

THE SNOW CACTUS.—An exchange says: "Along the Sierra Nevada, close to the line of snow, a plant grows of sizes varying from an inch to two inches in thickness, and height to the dimensions of the largest cabbages. It is known as the snow cactus, and depends for moisture upon the melted snow. It has been recently proposed to treat the plant as a table vegetable, and it is said that, boiled and served up as asparagus, this cactus is found equally succulent and satisfactory."

We suppose this is the new cactus recently named by Dr. Engelman *Echinocactus Simpsoni*. We are fortunate enough to possess a living plant of this species, and it is truly beautiful, — round as a globe, and completely covered with snowy-white spines. Its hardiness will be a great point in its favor. It has the appearance of a *mammillaria*, but Dr. Engelman is sure, from an examination of its flower and fruit, that it is an *Echinocactus*.

NAMES OF PLANTS.—*E. H. C., Shepherds-town, Pa.*: "Enclosed I send you a small evergreen vine and branch of a small tree and shrub, with bright red berries, for name. The small evergreen vine with red berries grows mostly in partly shaded situations, banks of streams, &c. The other is always found in low, wet places, margins of streams, &c. Please give names through *Gardener's Monthly*, and oblige."

[The red-berried shrub is a kind of Holly, only that the leaves are deciduous. It is the *Prinos verticillatus*. We often wonder it is not more often seen under culture. Its red berries give much beauty to a winter scene. There are three kinds—one with male flowers, which never bears berries, the other female, which require the other kind to be planted near by to get berries; the other with perfect flowers.

The creeping plant with the berries is the *Mitchella repens*, in Pennsylvania called Teaberry; but the Teaberry of New Jersey is *Gaultheria procumbens*.]

PATENT LAWS AND SEEDLING FRUITS.—We have the following note from Mr. Haskell:

"It has been often suggested, during the last few years, that the originators and discoverers of new and valuable fruits and plants ought to have protection for their productions similar to that which the law provides for authors and inventors. The justice of such protection is generally conceded; but it is often said that the patent and copy-right laws cannot be thus applied.

To meet this objection, a Bill has been prepared, the provisions of which are all taken from the patent and copy-right law passed at the last session of Congress, with only such modifications and changes as are necessary to adapt its provisions to a new subject-matter.

A copy of such proposed bill is sent herewith, to which your attention is respectfully requested. If you think this or any similar law for the protection of Horticulturists desirable and just, it is hoped you and your neighbors who concur in that opinion, will petition Congress therefor."

We believe as strongly as any one, that the originator or discoverer of a new fruit, or flower, should be as fully rewarded for it, as he who studies out a new principle in the arts, or stumbles over any other good thing. Our objection to the proposed plant laws is not here. But it is that there is no way to define a new plant or fruit so clearly that the officers of the patent office can judge by the record, whether it is new or not, and there would, as we think, be no end of litigation. Lawyers would thrive on it much more than the originators of new fruits. Take Romeyn's Seedling Strawberry, for instance. The "Patentee" of *Triomphe de Gand* would assert that it was identically the same as his, and that to call another Romeyn Seedling was an infringement of his "right" in the sale,—but the latter would prove that he raised it from seed, if even it was the same. What then could be done? This is only one case of hundreds that would arise. We should be glad to know from the friends of the bill what they would do.

"GROUND PINE."—*S. & Co., Quincy, Ill.* "Enclosed please find sprigs of an evergreen. If it is not asking too much, please inform us its name, where plants can be had, and how propagated."

[ "Ground Pine"—*Lycopodium complanatum*. This is the material so largely used in Philadel-

phia, New York, Boston and Baltimore at Christmas times for decorations. It has never been tried under cultivation, but in view of its growing scarcity, it is quite likely it might be found profitable by those who have dense shady woods under which it grows. It is found more or less in almost every State of the Union, but most abundantly in New Jersey. Rooted plants could no doubt be easily furnished by New Jersey Nurserymen.]

MILDEW.—A. S. G. Mansfield, O., asks for a remedy for mildew on Roses. The best remedy for mildew is that for which the premium was awarded to the discoverer of the cure for the vine mildew, or *Oidium Tuckeri* of Europe. A little fresh lime is put into a tub or barrel ready for slacking, and a small quantity of powdered sulphur put on it. Water is then added, and the lime slaked with the sulphur. It stands till all settles and the water is clear. This yellowish water is then syringed over the diseased part, and it certainly checks the progress of the disease. The vine mildew of Europe, as has been before noticed in our columns, has never made its appearance in our country yet; but we have found that this remedy is as good against our form, which is little less destructive than the *Oidium* of the Old World. It does not seem to kill insects, but we have noticed that where this water is occasionally syringed over greenhouse plants, insects are not near as numerous or active as in ordinary cases. It is a good thing to always have about in a plant establishment.

LATE BLOOMING APPLES.—We have from time to time furnished lists of late blooming apples, which are useful, inasmuch as such kinds are more liable to escape injury from late frosts. Nothing has yet been done for the Pear. Mr. Parker Earle has commenced this useful work, by noting in the *Journal of Horticulture* that the Lawrence is more likely to open earlier than the Bartlett, and thus the latter escape when the former is injured.

SALTING ASPARAGUS.—G. T., Geneva, Kane Co. Ill., asks: "Is it necessary to use salt on Asparagus beds?" Where the soil is of a light or sandy nature, salt is an excellent manure, applied so as to be about one-eighth of an inch thick over the bed in Spring, just before growth

commences. But in heavy, clayey soil, salt is an injury.

PEARS AT BOSTON.—The *Journal of Horticulture* notices that at the annual exhibition at Boston, there were 99 contributors of Pears. Of varieties, Duchess and Bartlett were the most numerous, there being 65 plates of the former, and 46 of the latter,—the Seckel, however, had 45. Of others, the most numerous dishes were in the order as named. It serves to show which are the most popular varieties there. Beurre d'Anjou, Urbaniste, Beurre Diel, Sheldon, Lawrence, Belle Lucrative, Winter Nelis, Beurre Clairgeau, Beurre Bose, Andrews, Swann's Orange, Beurre Superfin, Vicar of Winkfield, Beurre Hardy, Doyenne Boussock, Howell, Marie Louise, Doyenne du Comice, De Tongres, Dana's Hovey, Beurre Langelier, Merriam, St. Michael Archange, Buffum.

Of grapes, the highest number of dishes were of Delaware.

DOUBLE PHILADELPHUS.—M. Carrière of the *Revue Horticole* has some original notions about describing plants. We not long since noted, that although he knew Messrs. Ellwanger & Barry raised "Tom Thumb" from our American Arborvitæ, *Thuja occidentalis*, he described it as a new *Retinospora*! Recently he has taken the double Mock Orange of our gardens—well known also in German gardens,—and catalogued as *Philadelphus coronarius fl. pl.*,—and re-named it *Philadelphus primuleiflorus*. This naming things over again is an unmitigated nuisance, leading purchasers to buy over and over again what they already have. In American gardening this Philadelphus has not proved very valuable, owing to a tendency to go back to the single state. By the way, it is a matter of surprise that the old *Philadelphus coronarius* is not more grown. It is the only one that is decidedly sweet; and is alone worthy of all the genus to the appellation of "mock orange."

COAL GAS AND THE ROOTS OF TREES.—The *Gardener's Chronicle* says that a Dr. Poselger has "shown by repeated experiments" that coal gas escaping from pipes under ground near the roots of trees will not injure them. We should like Dr. Poselger to come to Philadelphia, and try its gas. We rather think his experiments would take another turn.

**PICEA PICHTA**—Dr. Moore, in a recent number of the Proceedings of the Royal Dublin Society, says that any English tourist fond of arboriculture, on arriving in Russia is particularly struck with the grand appearance of the Siberian Silver Fir, which he says grows there to the height of 70 or 80 feet.

**PURPLE-LEAVED POPLARS.**—Dr. Moore says, in Russia, in spring, one of the most beautiful plants of the season is a purple leaved Poplar, which he thinks is not known to arboriculture outside of that country.

**ASPARAGUS IN SOUP**—Dr. Moore says, that in Russia, Asparagus is the most popular of all vegetables. It is especially a favorite for soups. The white part, and not the green, is the part chiefly used for this purpose.

**THE YELLOW LOCUST.**—A native of the United States, is now cultivated almost all over the world; but it thrives better in Prussia than anywhere else, not excepting its own native country. Berlin travelers speak with enthusiasm of its great beauty there. It is very popular among the Germans, and they have scores of garden varieties.

**THE RADISHES OF RUSSIA** are not quite like ours in general cultivation. They are more purple. It is the custom in Russia to eat Radishes before dinner proper, in order to sharpen the appetite.

**HYBRIDIZING.**—European writers seem to use this term at random. Mr. Adair, in a scientific paper before the Royal Dublin Society, says the Peach shows what hybridization will do—as hybridization is understood to be a crossing of different species together, it would be worth knowing what two species originally produced the peach. It is generally supposed to be a mere development by selection from the Almond, without the intervention of any other species whatever.

**ACCLIMATIZATION.**—It is strange how men of science, usually so careful of their facts, sometimes take up with the merest surmise on which to build up a theory. Thus Mr. Adair, in a paper

on acclimatization in the Royal Dublin Society, says that the Tomato would not at one time ripen in the gardens of North America, where it is cultivated for its fruit,—but now it does, and is extensively used in consequence. We suppose once no one thought of forwarding the plants in hot-beds, and now they do, and that makes all the difference.

**PROPAGATING BOUYARDIAS.**—*A. P. S., Phoenixville, Pa.*—These are raised from roots cut into pieces about half an inch long, buried in soil about one-quarter of an inch,—and the pot of roots put into heat of about 60 degrees.

**HARDINESS OF DEODAR CEDAR.**—*M., Harrisburg, O.*, inquires about the hardiness of Deodar and Cedar of Lebanon. About Philadelphia, most of those exposed have been killed,—but it has been found by experience that where they have the protection of other trees from cold winds they do very well. There is a very fine Deodar Cedar on the grounds of Mrs. G. W. Carpenter, at Germantown, and Cedar of Lebanon at Laurel Hill, both thus sheltered.

**COL. HARRIS** starts the new year in the *Rural New Yorker*. His energy, uprightness and intelligence has endeared him to agriculturists and horticulturists,—and he has our best wishes wherever he goes.

**PROPAGATING IRISH JUNIPERS.**—*A. P. S., Phoenixville, Pa.*—It makes no difference how old the shoots of Irish Juniper or Siberian Arborvitæ are for propagating purposes. They will root at any age. Usually, however, propagators use only well ripened one year old wood,—that is to say, wood on which the bark has just turned brown. It is not essential that they have heat, so that they are protected from frost,—but heat makes them root quicker, and one saves a year by it. Sometimes "fungus" gets in among a lot of cuttings, and destroys large numbers before they root, and it thus is another advantage of heat that it roots them sooner, and gets them out of the way of this enemy.



## BOOKS, CATALOGUES, &amp; C.

LANCASTER COUNTY FARMER.—*Lancaster, Pa.*

We have before noticed this excellent monthly magazine. Its articles generally are very original, and are written by practical men who unite great intelligence with their work. The Editors are ever alive to good matter. The essay of Mr. Stauffer on Horticulture, first appeared in this paper. We should like to know that the *Farmer* had a "big" subscription list,—perhaps it has. It at least well deserves it.

WESTERN FARMER.—*Madison, Wis.*

There are few papers we read with more pleasure than this. It is the only agricultural paper published in Wisconsin,—but it covers the whole ground so well, that there is no room for any more. The editors are industrious and not afraid of work; and hence the paper is a perfect encyclopedia of a full week's news.

HORACE GREELEY'S ESSAYS, "*What I Know of Farming.*"

Which have been published in *The Tribune* every week during 1870, are to be printed in book form, and a copy will be sent, post-paid, to each subscriber who sends \$10 for the DAILY, \$4 for the SEMI-WEEKLY, or \$2 for the WEEKLY TRIBUNE, and requests the book at the time of subscribing. This will enable old subscribers to

secure the Essays for preservation, on renewing their subscriptions, and new subscribers will, of course, be glad to obtain them, free of cost.

PROCEEDINGS OF THE FRUIT GROWERS' SOCIETY OF PA.

We do not think that any publication of this kind will surpass in interest the present issue. Beautiful lithographs of insects have been given which are engraved in the highest style of art. The essays of the President, Josiah Hoopes, and of the Entomologist, Prof. S. S. Rathvon, have long been looked for. The copious extracts of Mr. Hoopes' address, in which he enters so minutely into the fungoid diseases of fruit trees, which have appeared in so many of our Agricultural papers, have only whetted public interest to see the whole. Usually the proceedings are for the use of members only—one dollar per annum constituting one a member—but in this case, the Publishing Committee has decided to sell to outside parties for 50 cents per copy. This can be sent to Alexander Harris, Secretary, Lancaster, Pa., or to Brinckloe & Marot, the Printers, Philadelphia. We hope the efforts of the Publishing Committee to give a wide publicity to the Proceedings, will meet with the success which the volume undoubtedly deserves.

## NEW AND RARE FRUITS.

FORTUNE'S DOUBLE-FLOWERING PEACHES.—The two double-flowering peaches known as "Fortune's," though by no means the least important amongst the many valuable plants introduced by the great explorer of the far east, have certainly obtained less attention than most others which are known in connection with his honorable name. These peaches are remarkably ornamental when in flower, and not surpassed by any early-flowering trees known in the effect they produce when freely planted along the front lines of shrubberies. Mr. Gibson, of Battersea Park, has so shrewd an eye for good things that he embraced an early opportunity of adorning the shrubberies there with these two trees, and in their season of flowering they con-

stitute conspicuously beautiful features of plantations that are in other respects richly and plentifully furnished. During the past season they have produced an abundance of fruit, which, we are glad to say, is by no means despicable, though not to be compared with such peaches as are grown for the dessert. The fruit of the double red is obliquely conical, with a profound suture, the skin greenish yellow on the shaded side, soft rosy red on the side next the sun. The flesh of this fruit is dry, mildly sweet, and pleasant, freely parting from the stone. It is, in fact, an eatable peach, but as such scarcely to be desired; the peculiar dryness of the flesh, however, suggests that it might be turned to account to make an excellent preserve. The fruit

of the double white is smaller, nearly round, with a shallow suture, the color pale green inclining to white, resembling, in fact, an immature and unripe Noblesse. The flesh is slightly juicy, and decidedly sub-acid. The white variety does not ripen so perfectly in this climate as the red, and can scarcely be described as eatable; yet, no doubt, if these trees were planted for ornament, means would be found of utilizing the fruit of both sorts, and we cannot doubt that they might be made the base of a compote that would be valued in the household.—S. H., in *Gardener's Magazine*.

A NEW GRAPE.—I send you a bunch of a new grape, and would like your opinion of it. It took the prize at the Essex County Fair last week—is a splendid grape, vigorous grower, and a very prolific bearer.—J. T. DONOHOO, *Port Henry, N. Y., Oct. 10.*

[A dark black grape with double shoulders and of excellent quality. If it should always come as good as the specimen received, we think it will be an useful addition to the list of grapes.—ED.]

SPECKLED APPLE.—This beautiful fruit, brought prominently to notice by Mr. Lorin Blodgett, is again coming into our market, from western New York. They generally come here without any name, though some have supposed them to be the Fall Orange. They are, however, we believe, quite distinct from this.

FREE MASON PEACH.—I sent to the express office this morning a small box, containing three specimens of the "Free Mason" peach. (as first brought to notice, and named by Rev. R. W. Todd, of this county,) addressed to you at Germantown, Pa. The aforementioned gentleman has favored me with a history of this valuable market peach, in which is stated, that from a small quantity of seed, sowed from an Early Rareripec variety, by his father, (since deceased) trees were raised, from which was planted a small orchard about one hundred trees.) In this were varieties, good and worthless, early and late, yellow, white and red, cling and freestone. All from the seed of the Rareripec. Among this lot of trees, was the original "Free Mason tree." It truly and evidently is a very fine and valuable fruit of its kind. In 1868, having then but a single tree in bearing of the kind, it was the only tree, of an orchard of 1000, that produced

fruit, on the farm of Mr. Todd. Ripening three days later than the Smoek, is another strong point of merit in its favor. The tree is very vigorous, and somewhat spreading in its habit, leaves serrated without glands.

Living in the centre of the greatest peach growing district in the world—where, too, the interest, in reliable market varieties, as exhibited by the many extensive cultivators, determines justly the merits in that relative of all, we are thereby afforded opportunity to decide with certainty as to the character and value of new varieties, in comparison with the old and well-tried. A large majority of the people in the metropolis of the "Keystone," and New York, who consume the fine peaches shipped there from the peninsula, have little idea, in respect to the magnitude of the peach growing business here. And methinks that if the efficient and courteous editor of my favorite journal of horticulture (*The Gardener's Monthly*) was to take a trip through this section, while the car-loads of kind old mother nature's juicy and luscious productions are daily being gathered from the loaded boughs of thousands of trees, and have his palate moistened with the rich juice of a "Golden Drop," or the spicy sweetness of a "Stump the World," freshly plucked from the tree, he would yield agreement in the opinion, that though Pennsylvania and the north can raise heavier crops of wheat and corn, they are far, far back in the rear in point of truly excellent peaches; that is when put in comparison with this favored peninsula. *Try it, Mr. Meehan, if you and we live till next year, we would be VERY glad to see you here.*

And would it be selfish pride for me to here state the truth, that Caroline County, Md., bids fair to lead all her thriving sisters on the shore, in this relation? The natural adaptability of her soil to the peach, (both tree and fruit), and her facilities for prompt and speedy shipment, of the productions of her *very rapidly* increasing orchards, both by land and water, gives to her "the long end of the stick." There are numerous facts relative to the orchard culture of the peach, that are daily developing themselves, under my observation, which, should leisure time present itself, I will perhaps try to classify, and send you. With very high regard, I am sincerely yours.—J. W. KERR, *Denton, Md., September 13, 1870.*

[Unfortunately this fruit did not reach us, but

we have heard such good accounts of it from others, that we have no doubt it warrants the enthusiasm Mr. Kerr exhibits in writing about it.—ED.]

**THE WEALTHY APPLE.**—I believe that you gave some account, some months ago, of the Wealthy apple, a seedling raised by Peter M. Gideon, of Excelsior, Minnesota, a few miles west of Minneapolis. He also had another seedling, which he thought about equal to the Wealthy, called Molly. It is a large red apple, very fair and handsome; its quality is "best." We class apples "good," "very good," "best." I think its quality will not stand high in the first class, but too good to go in the second class. It had a very beautiful shade of light red through the flesh of the apple, and very distinct streaks of red towards the core.

Such being the character of the Wealthy—it's tree and fruit—it cannot fail to be of very great value to a large portion of our whole continent, in the latitude of St. Paul, and a long distance south of that, and how far north it will stand the climate remains for trial.

I omitted to mention in the proper place, that the apple appeared to be at its proper stage of maturity when I cut it, on the first day of October. It had been picked some days, and bruised a little by its long carriage in the mail. It is probably a mid-autumn apple. And even here, in latitude  $44\frac{1}{2}$ , it may take the place of our very excellent and popular variety, the Maiden's Blush, which is rather tender for this latitude.—SUEL FOSTER, in *Western Farmer*.

**THE OUACHITA GRAPE.**—The *Southern Standard*, published at Arkadelphia, Ark., says: "It is not generally known that we have growing wild in the woods of the Ouachita, one of the best wine grapes in the world. It is known as the "Ouachita Grape," and is of large size, and delicious flavor. Several years ago it was introduced into France by layers from this country, and is now the most popular grape in France, their finest wines being made from it. It is not subject to diseases as other varieties of grapes, is much hardier and does not require as much cultivation. Mr. Wm. A. Brown exhibited to us a specimen of this grape a few days since, which he has been cultivating, which demonstrates its susceptibility of improvement, it being large and luscious as the best varieties of what is generally known as the English grape."

**NEW GRAPE FROM ELLWANGER & BARRY.**—We send you a bunch of our new seedling grape. We think it is now the sixth year fruited, and it has been uniformly of high character. Many bunches weigh a pound.

[This is a bunch of remarkable beauty. It has two shoulders, and thus makes a symmetrical bunch. The berries are about the size of Diana, with the color of a well ripened Catawba, and are remarkable for tapering very suddenly to a small narrow point at the junction with the pedicel or stalk. We counted *one hundred and sixty* perfect berries on the bunch. The skin was thick and the flesh pulpy, but sweet and good. The leaves are coarse and strong.

We do not think it will take rank with the best we have in quality; but its beauty and evident vigor will we think ensure for it as wide spread popularity as the Concord, Hartford, and other good kinds of that class.—ED.]

**PRESIDENT WILDER STRAWBERRY.**—A few days before starting to California, Col. Wilder very kindly presented us with a dozen plants of this variety. This is the first opportunity we have had of seeing the plants since we saw them a couple of years ago on his own ground. Notwithstanding the extraordinary hot and dry weather to which they have been subjected, their vigor and health is remarkable. To be sure "we don't grow strawberries for their leaves;" but vigor and health of foliage under a trying ordeal, we regard as a good augury of success.

**THE JANIE WYLIE GRAPE.**—In 1860, I procured pollen, by mail, from Lyon's Grapery, Columbia, S. C., of mixed foreign varieties, with which I fertilized a number of native varieties, and, among other, several blooms of Clinton. From the seed thus impregnated, I raised three Clinton and foreign hybrid plants in 1861, one of which was Clinton Hybrid, No. 1, since named by Mr. H. W. Ravenal, Janie Wylie.

The formula of its parentage is—F. Clinton (*Cordifolia*). M. Foreign (*Vitis Vinifera*).

It was planted in most unfavorable soil—a tenacious yellow black jack clay—which cracks widely in dry weather, and is sobbed with water in wet weather. In this soil it grew until 1864, when it showed its first fruit. In 1865, owing to the destruction of my fence by soldiers, it was broken down and almost destroyed by cattle;

but still it survived, and has borne ever since. Until recently I had no other vine of this variety except one grafted on a strong Isabella stock. This flourished and bore for two years and then died. I have now two vigorous young vines in a better locality, which have borne this season for the first time, one of which bore the bunch represented in the painting sent you.

Owing to various circumstances, which I will not take space to detail, it has never been fairly tested anywhere. A few plants have been distributed, but sufficient time has not elapsed to get a report of their bearing. In the part of my lot where the old vine grows, about one-fourth of an acre of hybrid seedlings were planted at the same time with this hybrid, but owing to bad soil and drainage, the greater part are entirely dead, whilst this vine has survived with scarcely a sign of mildew or disease.

The vine is a pretty vigorous grower; wood, short jointed; foliage resembling the foreign, except that the leaves are thicker and heavier, and not inclined to mildew or scorch; bunch very large, shouldered; berry very large, some of the largest ones globular, (and an inch in diameter,) but mostly oblong; color, dark purple; flesh, crisp and solid.

The fruit hangs well on the vine. During the incessant rains this season about the time of ripening, where too much shaded, it inclined, for the first time, to rot. It has proved much more reliable with me than Herbemont, or Catawba, and has been pronounced by Parsons, Berckmans and Ravenal of excellent quality.

Upon the whole, we think it may prove quite an acquisition, particularly at the South. It

will, probably, be too tender for the North without laying down and covering during the winter. I only raised two other Clinton Hybrids during 1861, the fruit of both of which has proved worthless.

But I have many new Clinton Hybrids just coming into bearing, which are of the most promising character. All my Clinton Hybrids set their fruit well. Bad setting of fruit renders many hybrids of the finest qualities in other respects worthless.

A. P. WYLIE, M. D., in *Carolina Farmer*.

A NEW CRAB APPLE—MACKIE'S BEAUTY. —Matthew Mackie, Clyde, Wayne Co., N. Y., sends me a seedling from the small Siberian crab, which I have never seen equalled in size or beauty, except by the Astrachan crab—a variety I had and fruited years since, but of late fail to find in any catalogue. This crab of Mr. Mackie's is truly beautiful. It is roundish oblong, oblate in form. Specimens grown in the sun are of a deep, rich red, with a blue bloom, and scattering light dots and marbled lines. In the shade, the color is of a pinkish red, with a gray bloom. The stem is long, moderately slender, set in a broad, deep, open cavity. The calyx is closed, with long or half-long segments clasped, as it were, by the lower ribs or furrows of the basin, which is broad and moderately deep. The flesh is white, tinged in its lines with faint yellow; is crisp, only moderately juicy, and a pleasant, mild subacid—better than many a well recognized apple. The core is medium, or small, with flattened, obtuse, pyramidal seeds.—P. R. ELLIOTT, in *Rural New Yorker*.

## NEW AND RARE PLANTS.

THE JAPANESE HYDRANGEAS have long been familiar in gardens as ornamental shrubs, the old-fashioned H. Hortensia being one of the most popular of decorative plants. H. Japonica, too, is a handsome species, but the comparative paucity of its neuter flowers renders it less ornamental than H. Hortensia. We had before us a few weeks since specimens of two others of recent introduction, which are subjects of great beauty, namely:

HYDRANGEA OTAKSA and HYDRANGEA PANICULATA GRANDIFLORA. The former is ad-

mirably figured in SIEBOLD and ZUCCARINI'S *Loues et Descriptions Hydrangearum*, forming a portion of the *Flora Japonica*. It is a bold shrub, with obovate serrated leaves, cuneate at the base and shortly cuspidate at the apex, and bears great globose cymes of pale or sky-blue flowers, which are all, or nearly all, radiant with five (or sometimes four) roundish, obovate, entire sepals. In the work just noted the cymes are said to measure 8 to 12 inches across, and in the sample referred to—the ramified termination of a natural shoot—the compound flower-head

measured just 42 inches in circumference. It is a grand ornamental plant, very nearly related to *H. Hortensia*, and, like it, having the whole head composed of radiant or neuter flowers. The flowers themselves are somewhat smaller than those of the common *Hydrangea*, being  $1\frac{1}{4}$  inch in diameter, but they are more numerous, and of a more elegant form, and more pleasing color, the fine pale blue, which, moreover, pervades all the ramifications of the panicle, being, it would seem, natural to them, since they are so described by Siebold, and the specimens sent us entirely confirm his statement. *Otaksa* is the native Japanese name. It is a plant of great beauty, and will prove to be one of marked utility, about equalling the other Japanese *Hydrangeas* in respect to hardiness. The *Hydrangea paniculata grandiflora* is another remarkably ornamental plant, but of a totally different character, approaching in its inflorescence nearer to the *H. quercifolia* of North America. *H. paniculata* itself is a branching shrub, with ovate, or ovate-oblong acute leaves, and the flowers in small cymes, disposed so as to form a pyramidal panicle, but mostly fertile and inconspicuous, with a few large, white, sterile or radiant flowers on the outer part of the panicle. *H. paniculata grandiflora* differs in having a much larger proportion of radiant flowers, the whole of the small, colorless, fertile flowers of the type becoming enlarged and converted into white petaloid blossoms, so that instead of bearing a sparse inflorescence, each branch produces a dense panicle of white flowers of about a foot in depth and two feet in circumference. As a hardy, deciduous flowering shrub, blooming in August, it has few equals, while it entirely supplants the old *H. paniculata*. For the opportunity of noticing these choice novelties we are indebted to Mr.

Anthony Waterer, of the Knapp Hill nurseries. —*Gardener's Chronicle*.

RARE MAPLES IN EUROPE.—The *London Journal of Horticulture* say: We find a series of *Acers* of which we have heard from time to time during several years past, all the several names, of which appear to be condensed into the new specific designation *ornamentum*. These *Acers* are related to a type which may be said to have only a hypothetical existence; we may call it—using established technology—

*ACER POLYMORPHUM*, and under that head we group a lot of beautiful trees with deeply-lobed palmate leaves, some of them delicately lacinated and almost fern like in their divisions, all of them displaying splendid tints of golden green or bronzy purple, or brilliant crimson or carmine. Many of our readers will remember a purple-leaved maple called

*ACER JAPONICA*, which nobody could propagate, and of which there is scarcely to be found any authentic record. It is highly probable that if a tree of the so-called *A. japonicum* could be found, it would prove to be one of the polymorphum section, an old friend under a new name. At all events, these maples, varieties of *A. polymorphum*, are deserving of a place in every garden where beautiful-leaved trees are appreciated; and no doubt we shall soon see them planted out in groups in the promenade gardens, in the same way as the ghostly variegated *negundo* has been employed, but to produce the different effect of a brilliant display of color. Some new forms of

*ACER PSEUDO-PLATANUS* have been introduced with the palmate maples, one of which, named *Frederici Guillelmi* is notable for its brilliant colors, the leaves being streaked and splashed with tones of rich brown, red, rose and creamy white.

## DOMESTIC INTELLIGENCE.

EFFECTS OF CHANGES.—If any one were to write a treatise on the laws of life, and include change amongst them, he would be very likely be laughed at. Yet how much do we owe to it! A sick person, after every effort of medicine and kind attention fails, is ordered to travel, and he gets cured. So also of plants. We may grow them on the same soil, year after year and they fail to produce a crop, though we are as

careful as possible to return to the soil the elements supposed to be taken away.

We know what chemists tell us. They say that though we do not know it, there is still something lost which we have not altogether restored. But the practical farmer, though he cannot controvert this, hardly believes it, as there are so many things which scarcely come out right under the explanation. For instance,

he grows a certain variety of potato year after year, until it fails to produce the same good crops it once did. He sends a few hundred of miles for new seed of the same variety, and it will at once, and without adding anything to the soil, produce as good crops as it ever did. We have heard agriculturists deny the possibility of this, but we think that most practical farmers know that this is really the case. Yet surely the same variety of potatoes require only the self same elements. There has been no other difference but the change.

So also in the matter of manure. People sometimes find benefit from phosphates, or guano, or some other commercial fertilizer. But in a few years it turns out to be no better than brick dust; but any other kind of manure will have a wonderful effect. We knew a friend once who used to raise enormous crops in his vegetable garden, which was annually manured from his horse stable. It failed at last. Even weeds seemed to despise it. He changed from horse to cow manure, and again wonderful crops rewarded him. Chemically there was not much difference in the manure. The change was more than all.

It is well to remember this as a general principle. Nature loves change. There is a seeming contradiction, for we speak of the certainty of nature's laws. But those who know her best, know that she has laws which seem contradictory. The same elements that make fire, largely make water, which is the enemy of fire; and some of her most harmless elements will often unite to make the deadliest poisons. At any rate, constant as she generally is, we know she sometimes likes a change.—*Forney's Press.*

MAMMOTH PEACHES.—Mr. W. F. Howell, of Lexington, sent us a box of Peaches, recently, which astonished us. The peaches would average fully one half pound each in weight. We considered them rather large until presented with some by Mr. D. L. Shead, of this city. The latter were of the same variety—late Crawfords—and twelve of them weighed just seven pounds. They measured from  $9\frac{1}{2}$  to  $10\frac{1}{2}$  inches in circumference. We doubt if that can be beat.—*San Jose (Cal.) Mercury.*

KNOX NURSERIES, at Pittsburg, has passed to R. Cummings & Co. Mr. K. has done a valuable work in showing how much can be done

with small fruits, when managed with judgment and good sense. It was a great work for him to do, for we think that when once a man is placed on the grandfather's list, it is time for him to take the world easy. But it seemed necessary for him to set young men an honorable example, and we have no doubt those who succeed him will profit by it. They have commenced very well. Their descriptive and illustrated catalogue of fruits will interest any one at all horticulturally inclined.

RICE PAPER PLANT.—The beautiful Paper Plant or tree, *Tung-tsau* of the Chinese. This grows wild in the forests of Formosa, and often attains a height of thirty feet. It grows much like the palm, with a slender trunk and corrugated bark. At its top it is crowned with large leaves, and above these, on slender stems, is a profusion of clusters of small, but delicate yellow flowers. In the flowering season, the tree is very pretty. But its value consists not in its ornamental qualities. Like the elder (*Sambucus*.) it has a large pith; this, in a full-grown tree, is not less than two inches in diameter. This is driven out by a punch, after the tree has been cut into sections, and then put into hollow bamboos, where it dries straight. After this it is removed, and by a machine, something like that by which leather is split, is by a spiral motion cut into sheets about four feet long. These are then pressed until they become firm and smooth, after which they are cut into sheets of the desired size.

This makes a very good paper, and is extensively used in eastern countries. It has the peculiar quality of swelling when it is wetted, and then of retaining its enlarged size. This makes it very desirable for fancy work, such as taking the impress of leaves and flowers; also for drawings, as the moistened surface rises and gives the effect of relief.

This paper has been in use for a long time by the Chinese, though they make other kinds of different materials. Some is made of bark, which they macerate and then work into a thin pulp, that is allowed to settle upon a fine sieve placed in the bottom of the trough. This is then brought up and dried, and beaten with mallets until it is firm and smooth. I have often seen the natives at work at this, and a very usable paper they make. By putting coloring matter in the pulp, it can be made of any shade they desire.

Paper of some kind has been long in use, but probably at the first the skins of animals were generally used.

We are told that the early Arabs made their inscriptions on the shoulder-blades of their sheep.

The papyrus was early used in Egypt for paper, and continued in use for a long time after the Christian era. This paper was prepared by separating the different layers of the bark, and then, by pressing several of them together, with each alternate one laid crosswise. This is said to have made a strong and durable paper.

But this gradually gave way, and some form of vegetable pulp was used in its stead, and this will probably be used in all coming ages by the civilized world. Doubtless most would be as-

tonished to see how well the world got along before the days of paper mills, and how neatly paper was prepared for public and private use.

The budhist priests of the East still write their sacred literature on sections of the leaf of the sacred palm. I have often seen them reading from these books, and have a part of one now in my possession. They are neat in appearance, and not inconvenient.

Modern invention has done much for the world, but not as much as one at first would naturally suppose.—*Ohio Farmer.*

HUTCHINSON PEACH.—Fruit of medium size and quality, much like old Red Rareripec; said to have borne regularly for forty years in the vicinity of Reading, Mass.

## HORTICULTURAL NOTICES.

### FRUIT GROWERS' SOCIETY OF PENNA.

As announced in our last, the winter meeting of this society is to be held this year at Chambersburg, Pa., and promises to be one of the most interesting ever held. It will begin on the 18th of January. The Cumberland Valley R. R. will reduce their fare for the occasion. It is so very seldom that eastern roads will make this concession in such cases, that it is worthy of particular praise. In the West the roads always do the handsome thing, which, considering that most of those who attend these meetings do so in a great measure for the public good, is just as it should be. It may be added that to get the benefit of the reduced rates, parties must apply at the ticket office at Harrisburg for the Fruit Growers' excursion ticket. The meeting of friends is always in itself pleasant,—it is hoped that the interchange of ideas will be also profitable to all.

In addition to this liberality, the citizens of Chambersburg, propose to entertain as many members as possible at their private homes.

### PENNSYLVANIA HORTICULTURAL SOCIETY.

A few years ago the Pennsylvania Society suffered terribly from the burning of their grand hall. Every year afterwards it took all they could collect to extemporize a place for the annual exhibitions. However they built one for

themselves; but still they could not raise enough to reward contributors for their generous support to it. Every year, however, the revenues of the society has been increasing, and the society feel encouraged to offer for next year something commensurate with the liberality extended to them. We understand that it is in contemplation to appropriate over *thirteen or fourteen hundred* dollars for this purpose,—a larger sum it is believed than has ever before been offered in one year in the United States. Several premiums of from \$25 to \$30 are amongst them,—and we understand there will be some of \$50, and silver watches suitably engraved for successful competitors.

Although this Society was established for the encouragement of Horticulture in Pennsylvania alone, with a liberality which does them honor, the competition is entirely *free to the whole United States.*

In order to give every chance to exhibitors to grow especially for competition, the schedule committee is now engaged in preparing one, which we believe will be ready early in February. It can be had of A. W. Harrison, Secretary. If we might make a suggestion to the Society, it would be to advertise the whole schedule in the *Gardener's Monthly.* It would save much time to their hard worked secretary in mailing, require a less number of copies to be printed,—and let the whole world of horticulturists, ex-

hibitors or not, see exactly what the Society is doing.

### ILLINOIS STATE HORTICULTURAL SOCIETY.

The great number of intelligent horticulturists in the State of Illinois, always renders their annual meetings particularly instructive. As we go to press we find some account of the recent meeting at Galena, in the *Chicago Tribune*, from the pen of the Hon. M. L. Dunlap.

President Flagg delivered the annual address. From reports of committees we gather that the fruit crop was light, except grapes, which were better than usual. The pear blight has been severe "but no cause can be assigned for it."

Robert Douglass read a paper favoring shelter of evergreens for orchards, which seemed to meet the approval of members. Half hardy varieties live well under the shelter of the more hardy ones. On transplanting Mr. Douglass gave some very excellent advice; he would prefer the spring season, before the swelling of the buds, and in planting pack the earth on the roots very solid. In case the soil is a little dry, it should have water poured into the hole so as to form a puddle; after filling up with earth, it is to be rammed down firmly. He observed that this was not very scientific, yet it was good for the trees. This is a point that should not be neglected in the planting of evergreens.

Dr. Warder lectured on *variations*. The Russian apples were discussed, and opinion favored the value of many of them.

C. V. Riley, Entomologist of Missouri, read a paper on snout beetles, embracing only the plum, quince and apple curculios. The number of insects that prey upon the plants of culture are almost like the sands of the seashore. These attack the plant in all stages of its growth as well as in all its conditions.

The plum curculio is the most destructive of any member of this family of insects.\* He stated that it is single brooded, and passes its winter in the beetle state, under rubbish, and never under ground. Mr. R. presented a bottle with several of these insects, all alive, and ready to feed on the apple.

Another habit of this insect is that it flies, feeds and lays its eggs at night; in short, is a nocturnal insect. The Michigan method of capturing this insect under the chips was commented upon, and shown to be neither new or very useful, unless it be resorted to early in the season.

He described two insects that feed on the larvae of this curculio, from which he had hopes of great good.

*Apple Curculio*.—This insect differs from the former; it is smaller, and never infests the stone fruits, and, like the former, is a native American insect.

*Quince Curculio*, Mr. R. stated, was very injurious to the quince and pear—very common at the East.

Arthur Bryant showed the profitableness of timber when planted on farms.

Dr. Viele, of Rock Island, showed the immense advantage of birds to the husbandman.

Prof. Turner showed that horticultural education had made a great gain during the past few years. An university education was not as necessary now as in the past to distinguish a man in the social position or the industrial pursuits of life. Parker Earle spoke on pears; Mr. Dunlap says, one of the best and most instructive ever he heard on the subject.

Mr. Talbot, of Burlington, and Shaw, of Lewiston, spoke of pear orchards productively successful about them when not treated to surface stirring.

A. M. Brown read a paper on this transporting fruit. Close packing, to avoid injury from railroad friction, is deemed essential. Close packages, such as barrels, are best for the pear. In case they are fully ripe, wrap in paper or soft grass. Grapes should be exposed to the sun some hours before putting into boxes of from three to five pounds.

Dr. Spalding would place the grape directly from the vine into the boxes. In this way the bloom is preserved, and the fruit presents a better appearance. The boxes are placed in the shade for the day, in order to allow them to throw off the extra moisture, and then closed up for shipment. In all cases of harvesting the grape crop, the weather must be dry.

The wine question raised an exciting discussion. It was thought horticulture ought not to favor anything that tended to drunkenness. The pure wine men denied that it did. Mr. Dunlap says, the discussion was very earnest; but in good temper, just as such discussions ought to be. Mr. Manning, of Boston, made an address on the effects of fruit culture, which was highly appreciated.

Arthur Bryant was elected next President,—and the next place of meeting, Jacksonville.



ded  
fine  
best  
able  
arly  
ong  
and  
ap-  
rub  
able  
not  
The  
this  
sira-  
h of  
gnus  
tion  
com-  
ce is  
wers  
ly as  
urea  
as it  
seen  
dry  
oil it  
use  
The  
and-  
on—  
awn  
d its  
very  
ition  
nica  
sira-

hib  
 doi  
 I  
 2  
 in f  
 nu:  
 go  
 me:  
 the  
 I  
 Fro  
 fru  
 bet  
 sev  
 I  
 of c  
 the  
 live  
 one  
 sor  
 spr  
 and  
 sol  
 hav  
 pu:  
 rar:  
 wa  
 tre  
 gle  
 I  
 sia  
 the  
 C  
 pap  
 plu  
 of  
 are  
 att  
 we  
 2  
 an;  
 the  
 in  
 un  
 sev  
 fee  
 )  
 fee  
 not  
 tur  
 me  
 vel  
 sea



B. V. R. FLAN  
 REFRVILLE MOOSH

W. J. B. 1874. B. A. 1874.

PURE WHITE

# The Gardener's Monthly.

DEVOTED TO

*Horticulture, Arboriculture, Botany and Rural Affairs.*

EDITED BY THOMAS MEEHAN.

---

*Old Series, Vol. XIII. FEBRUARY, 1871. New Series, Vol. IV. No. 2.*

---

## HINTS FOR FEBRUARY.

### FLOWER GARDEN AND PLEASURE GROUND.

In most parts of the Union planting does not commence till March; but as in many sections it is getting in order, we may as well make a few suggestions here as in the next month. And first, as regards selections of trees and shrubs. We are very glad so much more attention is given now than formerly to the matter of variety; not only for the many more pretty combinations which can be made, but also for the pleasure which so many forms of stately trees and beautiful flower bushes give. We are particularly pleased that shrubs are so increasingly popular.

If we have any truly beautiful natural landscape scenery pointed out to us, and analyze the materials that go to make it up, we shall find shrubbery, or "bushes," as we should then term it, going far towards making the place so charming, unless, indeed, it is a distant view; when, of course, masses of vegetation in which trees are undistinguished from shrubs, play a more important part. Not a wall is built, or a fence set up, but bushes and shrubbery of various kinds spring up, and take from the view the roughness of the outlines. This observation will furnish a good guide as to the proper position and uses of shrubbery. There are now fine collections of shrubbery in most nurseries to select from. Of those which are beautiful and can be readily and cheaply obtained, we may name Dwarf Horse Chestnut, flowering in June. The different Dogwoods, particularly *Cornus florida*, *C. sanguinea*, *C. mascula*, *C. alba*, and particularly the variegated English. The Hawthorns are very pretty

when in a cool soil, and situation partially shaded from the sun in summer. There are many fine double varieties of the English which do best when grafted on American stocks. The Double White and Double Red and Pink are particularly desirable. The Laburnum is a rather strong growing shrub, also wanting a cool soil and situation. When the season, as the last, happens favorably, it is the most ornamental shrub we have. The Sea Buckthorn is very desirable for its pretty silvery foliage; but it should not be set on a lawn, as it suckers somewhat. The shrubby border is the place for it. Of this silver-leaved class the Oleasters are very desirable. The yellow is not hardy, probably north of New York; but the small-leaved (*Æleagnus parvifolia*) is perfectly so. It has in addition very sweet flowers and pretty berries to recommend it. The Silver Bell or Snow drop tree is also a large shrub; but its early white flowers give it a claim on most shrubberies, especially as it blooms quite young. The magnolias *purpurea* and *glauca* are very desirable. The latter, as it grows in swamps when wild, is not often seen cultivated, as it is supposed it will not do in dry soil. This is a mistake. In a deep rich soil it thrives amazingly. It requires a free use of the pruning-knife on transplanting. The European Bird Cherry is one of the handsomest strong-growing shrubs of its season—June. For a single specimen on a lawn it is not well excelled. Its habit is good, and its flowering abundant. Its berries are also very enticing to birds, which form no mean addition to the pleasures of a garden. The *Pyrus japonica* every one knows. The white variety is desira-

ble, though it is more pink than white. The Mist tree is indispensable, from its striking peculiarity of flowering. The White Fringe, with leaves like the lilac, and large pendent clusters of white flowers, no less so. There are several Willows which, as shrubs, we would on no account be without, for their flowers large and sweet, so early that the first sun that thaws the March snow, brings them out also. The Goat Willow, and the Villars Willow—male varieties of course—are especially to be mentioned. The Indian Cherry (*Amelanchier*), following the Willow in flowering, and very beautiful; and the Double Pink, and Double White Dwarf Almond, are also early and pretty. The Yellow, White, and Crimson Azaleas are magnificent, but so scarce in nurseries we are almost afraid to have them in this list. The different Berberries can be scarcely spared for their pretty red berries in fall. The Sweet Shrub or Virginia Calycanthus, is one of the sweetest of all flowering shrubs, though its color is dull. The Bladder Senna is very desirable for its love of our summer heat, flowering profusely during July and August. The Meze-reon is particularly sweet and attractive, blooming very early, but like the azalea, rather scarce in nurseries. The Deutzias are well known—*scabra* and *gracilis* are the two best. The Burning bushes are beautiful in the fall; the Mississippi Purple (*atropurpurea*), and the European are two most desirable. The Golden Bell and early Spiræas, as *prunifolia*, *Blumeana* and *Reevesii*, every one wants, as well as the *Wiegelia rosea*. The public taste is divided on the *Althea*, yet there are few gardens without some one variety or other. The variegated-leaved is scarce, but as desirable as any shrub grown. The Oak-leaved Hydrangea makes a very striking object in a collection; and the common garden Hydrangea indispensable for dense shade. For flowering in August, and for dwarf compact habit, *Hypericum Kalmianum*, or the *H. prolificum*, is perhaps unrivalled. A rather scarce, but particularly pretty native shrub is *Itea Virginica*, which, like the *Magnolia glauca*, a swamp plant, cultivates well in dry ground. The *Jasminum nudiflorum* should be trained to a stiff stake, and get a pruning with the shears twice a year; it then grows very compact, and will support itself after the stake rots away. Then, it makes one of the prettiest shrubby bushes imaginable. As an oriental looking plant, the common Privet is good; indeed, its pure white flowers, fragrant as they are, and jet black ber-

ries, always attract attention. It is a plant also that will thrive in the most gravelly soils. The Upright Honeysuckles are perhaps the most common in gardens; the Tartarian deservedly so, few things are prettier. The Fly Honeysuckle also is desirable, for though the flowers are not quite as showy as the Tartarian, the habit is more graceful. Then the Mock Oranges or Philadelphia, though all white flowering, afford, by their diversity of habit, many good shrubs. The sweet one, (*P. coronarius*), one of the oldest and best, is least common. The Large-flowered and Gordon's upright are the two next best. The Tree Peonies, though rather expensive, every one wants. The Red and White Snowberry make a good show in winter by their interesting fruit. As for the Lilacs, we need scarcely recommend them. Common as they are no garden is complete without them. The Persian is a very distinct one from the common kinds. There are many new varieties, but they are but shades of old colors. The Tamarix is not often seen, but a great favorite of ours. In the class of *Viburnums* the Snow ball is well-known; also the high bush or false Cranberry; the Black Haw and the Wayfaring tree are the best.

Amongst large sized trees of the evergreen class, that are almost indispensable in grounds of any size, are the White or Weymouth Pine, Austrian Pine, Scotch Pine, all well known; but there are a few others which are scarcer, but which when common enough to be cheap, will be quite as much appreciated as these. Amongst these are the Bhotan or Himalayan Pine, *Pinus excelsa*. This has been unpopular because of a few fine specimens having been killed by some insects or fungus, it is not clear which; but we know some specimens thirty feet high, and believe they are no more subject to disease than the White Pine. *Pinus Australis*; the long-leaved Pine of the South, is hardy in Philadelphia, but it has to get strongly rooted before it grows fast, and has to reach age before it branches much; we cannot speak of its value in ornamental gardening. *Pinus maritima* is somewhat like it in its long leaves, but is the most rapid of all pines. It is not pretty when young; but makes a very striking appearance with age on large lawns. It is just hardy in Philadelphia, but we suppose would be too much injured to be popular north of this generally. *Pinus mitis* and *Pinus rigida*, are two very pretty native Pines of large growth, equal in beauty to any foreign kinds, but so rarely grown in nurseries

that we are afraid to name them here, as we do not know where the planter could obtain them. *Pinus pyrenaica*, is much like the Austrian, but has longer and finer foliage, and the wood is reddish instead of a grey brown, as in the common Black Austrian. Amongst the spruces the best known and most essential is the Norway. Then we may use the White Spruce, and, in Northern regions, the Black Spruce. We believe it does no good south of this point. The Hemlock Spruce is very desirable so far south as North Carolina, below that it dwindles away. Amongst the rarer ones are *A. Menziesii*, and south of Philadelphia, *A. Douglasii*. Of the fir tribe the Silver is extremely desirable, and the Balsam Fir in northern regions, or in low rich soils, but not wet. Amongst the rarer ones very desirable is the Siberian, the Nordmann, and the Cephalonian Silvers—the last the tenderest we believe—the *nobilis* and *grandis* will also prove very hardy and desirable, although we have seen no very large specimens. We think we may class the *Cryptomeria japonica* amongst the larger class of Evergreens which is hardy and desirable, and then close our list, no very extensive one. Of Evergreens which make only a medium sized tree, we also have Pines, Spruces, and Firs; of the former, the Cembran Pine is indispensable; and if we could find them in our nurseries, we would like to add *Pinus inops* and *Pinus Banksiana*. Of Spruces we have no common ones of medium height, but a rather rare one, *Abies orientalis* ought to be in every small garden where choice and good things are desirable. When we get to the smaller size evergreens or dwarfs, we have a great variety amongst Junipers, Arborvites, Yews. Of this class however are three which deserve especial mention, because we think that any one who will make them common enough to plant cheaply everywhere, will be public benefactors. We mean Lawson's Cypress, Nootka Sound Arborvite, and the *Libocedrus decurrens*, all hardy and very beautiful evergreens of medium growth.

For a collection of desirable trees, not particularly scarce, but which could be had in most nurseries, we would select the Norway, Red, Sycamore and Sugar Maples; English Horse Chestnut, where the soil is not too hot or dry; English White Birch; English Hornbeam, a rather small tree; Judas tree, either English or American; European Beech, also the blood-leaved variety; European Ash, including the weeping variety and flowering Ash (*ornus*; Euro-

pean Larch, and the American to make a pretty tree when mature; the Sweet Gum; Magnolia tripetala; Mimosa tree (*Jalibrissin*), south of Philadelphia; Paulownia for those who like sweet or showy flowers regardless of an ugly growth; Oriental Plane for grandeur and rapid growth, and of the Oaks, the English, Scarlet, Mossycup and Swamp White are the best. The deciduous Cypress, American Linden, and where the Elm-worm is not troublesome, the American Elm.

### FRUIT GARDEN.

Pruning of fruit trees, when required, should be proceeded with at favorable opportunities. We write *when required*, for in our climate, more injury is done by the knife than by the neglect to use it. Gooseberries, for instance, are usually ruined by pruning. In Europe, it is customary to thin out the centre well to "let in the sun and air." Here it is the sun and air that ruin them, by inviting mildew; and so the more shoots, the better. Our country farmers are the best gooseberry growers, where weeds run riot, and grass and gooseberries affect a close companionship. Wherever, in fact, the gooseberry can find a cool corner, well shaded from the sun, and with a soil, which, never wet, nor yet by any means dry, there will gooseberries be produced unto you. The English kinds mildew so universally, as to be almost gone out of cultivation south of the St. Lawrence. Nor, indeed, is it to be so much regretted, since the improved seedlings of large size and fine quality, raised from the hardier American species, are becoming known, and their merits appreciated by growers.

The rule, in pruning grape-vines, is to shorten the shoots in proportion to their strength; but, if the advice we have given in former summer hints has been attended to, there will be little disproportion in this matter, as summer pinching of the strong shoots has equalized the strength of the vine. Those who are following any particular system will, of course prune according to the rules comprising such system. As a general rule, we can only say, excellent grapes can be had by any system of pruning; for the only object of pruning in any case is to get strong shoots to push where they may be desired, or to increase, with the increased vigor of the shoot, which pruning supposes will follow the act, increased size in the fruit it bears.

All fruit trees like a rather dry, rich soil. On

a cold, clayey bottom, diseases are usually frequent. Do not plant deep; cut off tap roots, and do all you can to encourage surface fibres. Surface manuring is the best way of doing this after the tree is planted. Do not allow anything to grow vigorously around your trees the first year of planting, nor allow the soil to become hard or dry. Let trees branch low, and prune a little at transplanting.

The Strawberry, where it has been covered during the winter, should be uncovered as early as possible in spring, that the warm spring suns may exert all their influence on producing an early crop. As soon as growth commences, a sowing of guano has been found to be of great benefit to the crop of fruit.

Raspberries and Blackberries may be planted towards the end of the month; they should be cut down to within a foot of the ground at planting; they will of course, not then bear the next season after planting. But this is a benefit; no fruit tree should be allowed to bear the same season.

As to the best varieties of fruits to plant, that is a question which a work, intended as ours is for the whole United States, cannot answer. We are continually publishing fruit lists adapted to the different sections in the body of our work, and to them we refer.

---

#### VEGETABLE GARDEN.

The work for February will, for the most part, consist of preparations for future operations, and particularly for dealing with the manure question. All those kinds that are grown for their leaves or stems, require an abundance of nitrogenous manures, and it is useless to attempt vegetable gardening without it. To this class belong cabbage, lettuce, spinach, etc. The other class which is grown principally for its seeds or pods, as beans, peas, etc., do not require much manure of this character, in fact, they are injured by it. It causes too great a growth of stem and leaf, and the earliness—a great aim in vegetable growing—is injuriously affected. Mineral manures, as wood ashes, bone-dust, etc., are much better for them. For vegetables requiring rich stable manure, it is best that they have it well rotted and decayed. Nothing has yet been found so well fitted for the purpose as old hot-bed dung; though to the smell no trace of “ammonia” remains in it.

One of the most interesting parts of a vegetable garden is a hot-bed for starting seeds early. The end of the month will be time enough for those who have not command of a large supply of stable manure, as the very low temperature we often get at the end of the month, soon absorbs all the heat the hot-bed possessed. It is in any event best to put up the beds in the warmest and most sheltered spots we can find, and to keep cold winds from the manure, by covering it with branches of trees, or mats; and the glass should always be covered with mats at night. Tomatoes, egg-plants, peppers and cucumbers, are the first seeds to be sown this way. Cooler frames can be got ready for cauliflower, lettuce, beets, celery and Early York cabbage, a little of which may be sown about the end of the month for the earliest crops. The Cauliflower is a particularly valued vegetable, and no expense spared to get them in perfection will be regretted when one's efforts are successful.

Those who have hot-beds will now sow Tomatoes, Egg-plants, Peppers, and other vegetables that can be forwarded by this means; and those who have not, will sow them in boxes or pans, and forward them in windows. Every garden ought to have at least a few hot-bed sashes to forward early vegetables; for if they have no means of applying artificial heat to them, the sash will of itself forward some things considerably.

Many parties like to have Turnips sown in spring. The only way to succeed with them is to sow as early as possible, and on a very rich piece of ground, where they may grow speedily. If they do not swell before the hot weather comes, they will certainly run to seed.

About the middle or end of the month, or still later at the North—say the middle of March—Celery and late Cabbage may be sown. Here we usually sow the second week in March.

All gardens should have beds of herbs. They are always looked for in the fall, and nearly always forgotten in spring. Now is the time to plant Thyme, Sage, Mint, Balm, and other perennial herbs, and Parsley and other seeds of hardy kinds may be sown. When we say *now*, it is of course understood to mean where the frost has evidently broken up for the season. Our readers in less favored climes will not forget it when it does.

## GREENHOUSES.

This is the season when many things will require re-potting. Many have a set time and season to do this; but some things require re-potting at various seasons. The best time is just before they are about to make a new growth. Camellias, Azaleas, and many plants, for instance, start at this season. It is not necessary to repot so often as some think, especially if bloom, and not very large specimens, is chiefly wanted. If the pot is very full of roots, and the plant growing weak, it may need re-potting.

In potting, see that some provision is made for allowing the water to readily escape, by putting broken crocks over the hole. Use soil rather dry, and ram it firmly about the old ball. Prefer pots only a little larger, to very large shifts, as less liable to accidents. Trim the plants in a little, if unshapely, to encourage the new growth where wanted.

Many who have but small houses and wish to have a variety, are troubled with valued plants becoming to large. To keep them low, as soon as the plant has matured its growth, cut it down as low as may be desired. As soon as it shows signs of breaking forth into a new growth, turn

it out of the pot; shake or tear away the old ball of roots, and put it into a small pot as it can be got into, and when it grows again, and fills the pot with roots, re-pot again as before.

Sometimes the plants get "sick," which is known by unhealthy, yellow leaves. This is usually by over-watering, generating a gas, or, as gardeners term it, a "sourness," destructive to the roots. The remedy is to cut the plant back a little, shake out the soil, and put the plant in a small pot with new soil, and place the plant in a house only moderately warm, and which is naturally moist, so that the plant can live for a while without requiring much water. It will generally recover.

Every one interested in plant growing must be continually on the watch for small insects, which destroy more plants than many are aware of. The little Black Thrip is very troublesome to Azaleas; the green fly to all soft-wooded plants; the scale to Camellias, Oleanders, Cactuses, and the mealy bug to almost all hot-house plants. Continual syringings with warm, greasy water, in which sulphur has been mixed, is the best remedy. Tobacco smoke is still the most approved mode of destroying green fly and thrip.

## COMMUNICATIONS.

## A FLOWER SHOW IN THE YEAR 1830.

BY MR. W. T. HARBING, PHILA.

Some forty years ago, when a novice in the profession I had selected to follow, I was placed under the instructions of an uncle, who was celebrated in his day as a skillful landscape gardener, and successful nurseryman. "Fair Flora," with whose charms I was early smitten, had wooed and won my youthful heart, and "for better, for worse," we have since been united for so many long years. It has been said "the course of true love never did run smooth;" probably not, as most of us are aware who have crossed the stream. Yet through all the vicissitudes of life which the writer has since experienced, he can truly say, his affections have never been estranged from his first love.

"Far the heart that has truly loved never forgets,

But will fondly love on to life's close;

As the sunflower turns to her God when he sets,  
The same look which he gave when he rose."

But I am wandering from the subject, and what I wanted to say when I began this, is not what I have been saying, as my intentions were to describe a Flower Show which took place long ago. In those days there were no "Grand Horticultural Exhibitions," like the last September one, held in this city; which was, indeed, a grand affair. In those days they were simply called "Flower Shows," where prizes were awarded to the growers who showed the best.

Early in May, 1830, I, in company with a relative, went to Crigglestone, to the Annual Show of Tulips, Ranunculuses, Polyanthus, and Auriculas; also fruits and vegetables. Of the two judges, my instructor was one, who awarded the premiums to the successful exhibitors and whose decisions were as binding as the laws of ancient Media and Persia. Gravely they seemed to discharge a serious and

important duty, "without either fear or favor." A singing match between canary birds and meadow larks was announced to take place in the room, after the show was over, as an interlude while supper was preparing, which was to conclude the day's doings. The rector of the parish presided as chairman; just such a man I should think as would compare well with "The Vicar of Wakefield."

Good and benevolent old man, I think I see him now, in his old style habiliments; knee breeches, black silk stockings, and silver-buckled shoes.

He addressed the members of the society and visitors present, and in his remarks alluded to the antiquity of gardening, and the first gardener, Adam, who lost his situation from a strange propensity he had for eating unwholesome fruit; and during the time he was out of the business he tried his hand at tailoring, which was something new to him, and so unlike the gentle art he formerly followed, that after making himself a garment, he returned to his former occupation, with this difference: that at first he was gardening for pleasure, but afterwards for profit. I thought then, what a lucky thing it was for me to have chosen so desirable a calling, as to live among fruits and flowers like our prototype. He also spoke of the humanizing effect the love of horticulture had upon society, and remarked that wherever it attained to a high standard of perfection, it proved the people to be refined, peaceful and good. A list of the successful competitors having been handed to the chairman, their names were called out, and the premiums announced somewhat as follows:

"To John Goodman, who has exhibited the best collection of Tulips, five shillings and a strong pruning knife; which knife should admonish him to cut a becoming figure through life, in the position God had called him to."

George Digwell was the winner of a similar sum, for the best display of Ranunculuses, and a new spade, which implement was to remind him of the words addressed to the "father of gardening," "in the sweat of thy face shalt thou eat bread." Notwithstanding it has been so said, honesty and patient labor would surely meet with its due reward.

Richard Smoothraker was the recipient of four shillings, a rake, reel and line, for the best twelve Polyanthus exhibited. One of the three implements, the rake, should call to his mind the

evil results of "The Rake's Progress," a course of folly he hoped he would endeavor to shun; and that when cultivating the soil, to remember that although it had been decreed that "thorns also and thistles shall it bring forth," yet with industry well applied, both fruits and flowers would flourish in place of weeds; a fact so plain that all present could see.

The reel and line were fit emblems to point out how to make "The crooked straight, and the rough places plain," as, no doubt, he would find frequent opportunities for so doing.

Thomas Potwell obtained the highest premium offered, namely, ten shillings and a copy of "Abercrombie's Gardener's Callendar," for the best twenty-four varieties of Auriculas, which embraced white-edged, alpinas, green-edged and selfs, as they were then designated.

It was there I first saw the famous and beautiful Auricula, Colonel Taylor, which was never excelled by any other kind of its class, and always maintained its price, five pounds per plant.

I much regret having lost sight of such really beautiful flowers for so many years. Although frail and naturally delicate, they may be cultivated with success when properly managed.

Fruits and flowers were well represented, for which suitable premiums were given, and similar remarks made by the chairman, who, after invoking a blessing upon all present, mingled with the pleasant company. "The merry larks" and canary birds, were next called for. The little cantatrices were "famed in song," prima donnas in feathers. Several mysterious looking bundles, covered with dark colored cloth, were brought in and placed upon the tables, which afterwards proved to be cages containing the birds.

All the time I was wondering how they could be induced to sing for a wager or premium, but was soon made aware, for "when the cloth was opened the birds began to sing," they having been kept in darkness for some time previous, and when suddenly exposed to the light began such a warbling, piping and singing, as was truly astonishing.

The canaries followed suit, after removing the larks, and such a thrilling, ear-splitting chorus was given, which, for the time, was almost deafening. Whether it was the loudest or sweetest singer that won the five shillings and a brass wire cage, I do not now remember. Well, after flowers and music came supper, the grand finale of the occasion. The venerable and worthy



rector took a seat at the head of the table. On his right hand was seated one of the judges, while *viz-a-viz* from the opposite end looked up the associate judge, and Boniface, the jolly host of the "Red Dragon" Inn, where the show was held. O, mighty roast beef of Old England, and strong October ale; with what a gusto it seemed to be relished by all, as it disappeared from view! A more jovial or happy party, never met to discuss the merits of beef and ale, than had assembled there. Song and sentiment followed after the inner man had been comforted, which was equally shared and enjoyed, with the happy old rector as well as the merry laymen. Such was the first Flower Show I attended, little thinking then of the grand gala days of Chiswick and Regent Park, where we exhibited in after years.

How changed are the times since then, and how varied has been the writer's experience!

The good old rector has left us, and gone to a higher life; to bliss unchanging, and the goodly company over which he presided, are one by one passing away, and resigning their situations for more exalted positions in the mystical Elen, where all good gardeners go.

#### REMARKS ON THE DAPHNE CNEORUM.

BY MR. ANTOINE WINTER, WEST GROVE, PA.

This little plant is hardy, and retains its foliage during winter. It is a perpetual bloomer. The flowers are of a pink color, and very fragrant. Its best season for bloom is in the month of April and late in the fall, when other flowers are nearly all gone. No good garden should be without a few plants of it.

It can be propagated several ways. In the bed it can be layered, or the large plants may be divided. But the best plants by far are those grown from cuttings. There are several ways of doing this. The best plants that I ever raised were cuttings made from plants in the open ground, in November. They were planted in sand on a table with some bottom heat, then I potted them as soon as they were rooted, and planted them in the open ground in the month of May. In November they bloomed, and had roots enough to fill a six-inch flower pot. In my experience I found that a good sandy loam is the best soil for this plant. When grown from cuttings, they are easily transplanted. I have often moved them in spring, when they were in full bloom, and it would not even affect the flowers.

The plant can also be propagated from green wood, the cuttings being taken off, and the plants forced in the green-house during winter. This I consider the surest way of rooting them. When potted and planted with care, they will make good plants by fall.

#### ON THE RAISING OF NEW VARIETIES OF POTATOES FROM THE SEED-BALL.

BY MR. GEO. SUCH, SOUTH AMBOY, N. J.

No doubt since the excitement about the Early Rose and other new seedling potatoes, many persons have been inclined to try their luck at producing new varieties. It is also doubtless a fact that they have generally been deterred from making the trial from the supposition that it would be a long and tedious operation to begin with a small seed, no larger than a pin's head, and grow it on till full sized potatoes resulted.

The directions usually given for raising these seedlings certainly tend to encourage this idea; and Mr. Patterson, to whom the English are indebted as the originator of many good potatoes, gives it as his opinion that the production of new varieties from seed, is attended with so much labor and expense that it should be undertaken by the British Government, and not by individuals.

But the supposed difficulties could hardly be more absurdly exaggerated than they are in a late number of a well-known English horticultural journal. The article on the subject is long and most elaborate—specific directions being given for the exact proportion of each kind of enriching material to be used in the seed-bed; also suggestions as to the shape of the bed, the sort of cotton covering it should have over it; the composition of a wash to be used on the cotton,—in fact, details almost without number—the upshot of the whole being, that if the writer's directions are followed with care for two years, some potatoes may be had large enough to pass judgment on.

I cannot, of course, say decidedly that no one will be found bold and self-sacrificing enough to submit himself to this two years' discipline; but I am inclined to the opinion that if the experiment should be made, it will be in the garden of a Lunatic Asylum, where one of the occupants has a piece of ground set aside for his amusement.

Now, the simple fact is that it is an easy mat-

ter to get a tolerably good crop of potatoes within five or six months from the time the small seeds are sown. I have now in my cellar more than two hundred varieties of potatoes—very many of full size—all of which were produced from seed taken from the potato-ball a year ago. All who have seen these potatoes, differing, as they do, in shape, color, and in various other ways, have been so much interested that I cannot refrain from detailing to your readers the very simple means by which such gratifying results can be obtained.

I bought the potato seed from a seedsman. It was said to be "Early Rose, fertilized with white peach-blow and other varieties," which, from the appearance of the seedlings, is probable. The seed was planted about the end of March, just as tomato seed is planted. It germinated readily, and the little seedlings were soon pricked out into pans. In fact, the plants were treated precisely as tomato plants, except that they were moved to a cooler position than the tomatoes required.

Toward the end of May, the potato plants were set out in rows, just as potatoes are usually planted, plenty of room being left between the rows. Only this difference was made—very important, however, I think—the potato plants were not set on the level of the ground, but four or five inches below it, like celery in trenches.

They soon struck root vigorously into the good soil prepared for them, and grew rapidly—the soil being gradually filled in, as fast as the strength of the stalk seemed to admit of.

By the end of June the trench was all filled in to the level, and after that only one slight earthing up was given. In August the potato vines were as large and flourishing as if grown from sets. In this month, too, the first of the potatoes were dug, and from that time others matured, some varieties being early, and some late, until the last of October.

Every variety has been kept separate. Many show decided evidence of Early Rose parentage, as they vary in color from the very slightest flush of pink to nearly the redness of a scarlet radish. Several have the dark and distinct appearance of the old-fashioned "Blue Mercer." Among the whites some are extremely promising. Nearly all show distinct characteristics; in some the eyes being deep set, and in others hardly to be noticed. One variety was particularly remarkable, as all in the hill were about the same size, smooth in skin, and shaped exactly like a hand.

As regards flavor, those that we tried were very satisfactory. Some were really excellent, many very good, and but few abominable; none, I think, so bad as the Cusco.

### EVERGREENS FOR WINTER.

BY WALTER ELDER, LANDSCAPE GARDENER,  
PHILADELPHIA.

We are now in the "dead of winter," as the phrase goes, but nature is neither dead nor asleep; although deciduous vegetation has gone to rest, to recuperate its exhausted vitality, so as to come forth again in spring, with great vigor and beauty, to adorn the earth with foliage and blossoms afresh.

The evergreen trees and shrubbery are still in life, and decorate the general landscape and ornament private grounds, far more beautifully than they did in summer. In hedges and groups, or singly set, they are all beautiful; and now having the whole field to themselves, their verdant hues shine with greater lustre, and we admire them the more. We have a very numerous and diversified list of evergreens in culture, to make embellishments with, and very many new species and varieties are yearly introduced by our enterprising nurserymen—some of them make a tour among the nurseries of Europe every year, and bring home every new and valuable plant they can purchase, so as to keep our arboretum in the front rank. Henry A. Dreer made a tour in 1869, and Robert Buist made a tour in 1870, (both of Philadelphia.) We have seen their importations, and highly admire them. Other nurserymen throughout the union also make tours, and appoint agents to send every plant, choice and new. The catalogues of nurserymen for 1871, will give details of late importations—improvers should get and study them.

Let us contrast a few of the species and varieties we have in cultivation. Some of the Pines, Piceas, Spruces, etc., attain nearly a hundred feet in height. Some of the large Arborvites, Cupressus, Cedars, Libocedrus, etc., grow less in height, but form large massy columns of glossy foliage. Some lesser Arborvites, Biota, Juniperus, Yew, Boxwood-tree, Evergreen Privet, Thujaopsis, Euonymus japonica, etc., make stately shrubbery. Then the dwarf Arborvites, Cephalotus, Cotoneaster, Kalmia latifolia, Retinospora and Rhododendron, of species and varieties, Mahonia, dwarf Boxwoods and creep-

ing Junipers, are classed as dwarf shrubbery. Of their hues, Boxtree, Yew and some Pines and Piccas, are very dark. Some of the Junipers, Cedrus deodara, etc., are of light lively hues. Biotas are pale grass green; then there is a numerous class of various Genera, with variegated leaves; some have mixtures of green and white, others have yellow and green variegations, others again are splashed with white and yellow over their greens; some are tinged with yellow, and look as if gilded with gold. What a beautiful picture the evergreens make in winter, when they are judiciously arranged upon a fine lawn, and all in sight of each other! the contrast of their various statures, forms foliage and hues of verdure; makes rich food for the intellect—a *real rural feast*.

Our wealthy citizens, who intend to make arboral decorations at some future time, should take notice of the evergreen trees and shrubbery on the way of their walks and rides in winter, and note down such species as they may most admire, and let them read and study the "Book of Evergreens," by Josiah Hoopes, Esq., and the "Hand Book of Ornamental Trees," by Thomas Meehan, Esq., then they will observe the beauties of trees and shrubs wherever they go, both in summer and winter.

#### DISCOVERIES OF ANCIENT BONES AT WAUKEGAN, ILLINOIS.

BY MR. R. DOUGLAS.

You know that I am a believer in scientific men, especially when they treat on *bones*; and that I did not doubt our friend, Dr. Warder, when he picked up the bone on my grounds and said it was a horse's bone; nay, when he picked up a second, and called it an ox's bone. I did not doubt, but only asked him how he knew it; and when he turned it over and showed me where the butcher had sawed off the roast, I did not go back to examine whether there was a ring-bone or spavin on the horse's leg-bone, by which he might have distinguished it, but took it for granted that scientific men (especially directly after attending a meeting of the American Association, in Chicago) knew whereof they affirmed by other modes than those resorted to by ordinary mortals; and for this firm belief in scientific men's opinion on old bones, as you will yet remember, I was rewarded with a good joke at my expense in the Philadelphia *Press*.

I bore the joke bravely, supposing that science

would never again disturb my *old bones*; but I was mistaken. They have been ground through the Chicago papers several times within the past three or four months. They have been boiled in glue at Chicago, and sent labelled to Washington, but these are not the bones used by yourself and the doctor to get the joke on me. They are the bones of an Elk (or Moose) that our men dug out of a bed of peat.

You seemed so much interested in all that appertained to the Indians and the first settlement of the country, by white men, when you were out here, that I incline to think the following facts may amuse you; I will, therefore, try to give you the details seriously, although it is better worth a laugh than the bones you saw here:

We have a peat bed or muck hole in a corner of one of our nurseries, from which our men dig muck in summer for composting, throwing it up in ridges to be dried by the sun before hauling it out in winter. We usually dig as deep as the water will allow. Three or four years since, being a very dry summer, we were able to dig to the bottom, six or seven feet, when we discovered what appeared to be the bottom of a lake, showing clear sand, gravel and small shells, exactly like the shores of the lakes, so common in this county. Imbedded in this gravel we found a boulder, and around it were charred sticks, looking to all appearances like the remains of a camp fire, and near to it we found several poles that had evidently been pointed at the thickest end with an instrument not very sharp, proving, at least to my satisfaction, that Indians had camped there, and that the sharpened saplings were their tent poles cut with a stone hatchet.

While digging last summer, about three rods from the spot named, we found the bones of the Elk,—the horns, a jaw-bone, a leg, etc., and would have got them all, but the water prevented. They are the bones of a good-sized Elk, but I think I have seen larger.

A neighbor asked for them to take to Chicago, thinking them a great curiosity. I advised him not to trouble himself, as the Elk was recently in this locality, and is yet to be found at no great distance; that an old Elk could easily get mired in that slough, even as it was when I first knew it, twenty-five years ago; that the Indians might have killed it there, or possibly it had died of old age. He took them, however, and judge of my surprise, on reading in the Chicago papers, that this is a different species from any

ever found on this continent, that it is identical with, or very closely resembling the Irish Elk, and that it is much larger than the American. Then in a few weeks we read of it again as belonging to a pre-Adamite race, etc.

Now, if these writers had examined the bones, on the ground where they were found, as you and the Doctor did, they might have come to the conclusion that the pre-Adamite, Darwinian and Erinian, theories would apply to them about as consistently as to the horse and ox bones above spoken of.

The slough of which this muck hole forms a part, is about a mile long by a half mile in width, the adjoining land rising gradually, from five to fifteen feet above the level of the muck deposit. It is undulating, several points jutting out into the slough, forming small bays. The bones of the Elk, and traces of Indians, lie between two of these points.

Across the outlet to the slough, or former lake, the remains of a very strong Beaver dam could be seen for several years after I came here to reside, and after a great deal of digging and plowing and leveling, it is not obliterated yet. I think this had a good deal to do with the change in the deposit in the bed of the then lake, for it is plain to be seen that the surplus water found another channel on the east side of where the bones were found, while the channel dammed by the Beavers is on the west side, and in digging we find in some places rank vegetable matter pressed solid but not decayed, lying under three or four feet of clear muck with little or no fibre—indeed within the past few years we have had freshets, carrying haycocks nearly a mile and depositing them near the same spot, and also filling up ditches, four feet wide, with a deposit of muck brought from over a mile up stream. Now it is easy to be seen how his Elkship might have been caught on an island, (there are several in the slough) and carried down stream and swamped, much easier than to see how he could have lain there for ages on ages, or even to have swam over from Ireland. Now I have told you how this Elk may have got there, taking a common-sense view of the matter, but I cannot tell how the Indians managed to camp on the bottom of the lake; can you?

P. S.—Nine P. M. and down to zero. We have had three days of very cold weather, and no let up yet.

[This letter was not intended for more than

the editor's personal enjoyment,—but so many of our readers take an interest in every branch of natural history, that we could not resist the temptation to publish Mr. Douglass' pleasant epistle. In regard to traces of Indians, we have often seen and heard of pieces of wood dug up from wells in Ills., which were supposed to have been sharpened by stone hatchets, but which we preferred to believe were peron by beavers. We have seen specimens certainly done by Beavers, which any one would believe to be done by stone hatchets, if not aware of the Beavers' great skill in this matter. As to fire—well, fire existed before the Indians,—but even granting the Beaver, it shows that some extinct species like this Elk existed down to modern times, and are not perhaps quite so ancient as supposed. We should like, for some of our Philadelphia palæontologists, to have a chance at some of these bones. Send some to Professors Leidy or Cope, Philadelphia Academy of Natural Science.—Ed.]

#### WELL RIPENED TOMATOES.

BY L. B., PHILA.

I venture to send you a basket of tomatoes, illustrating the capacity of this fruit for keeping beyond the season, when the grocer's boy reports, in his emphatic phrase, that "*tomatoes is done*," and refuses to bring you more from the market. I have had no difficulty, in former years, in securing the keeping of two or three bushels until near Christmas, and this year I have been more successful than usual; cutting most of them from the vines Nov. 7th, and the last Nov. 16th, after which date they would no longer grow out of doors, even in this unequalled season.

The secret of being able to preserve them is to train them off the ground. I will not insist that they shall be trained on a wall, as my preference is, but in some manner train them up, and give them light as well as heat. I did not spade up five square feet of ground for tomatoes this year, giving them room only in nooks and corners, on walls and on grape vines, yet I had a larger crop than ever before, and cut some eight or ten baskets of green and half ripened ones on the dates named above. Of these I have lost perhaps three per cent. by decay, not more; and I think have enough left to see good specimens of my own in hand when Bermudas are first shown in our market.

Canned fruit does much to relieve us in the winter, but I, of course, find it very pleasant to be able to extend the use of fresh tomatoes from July to January, with no cost beyond a little care, and I venture to assure any one who will plant against the south or east side of a wall, and will fertilize highly, that he can also gather an abundant crop from August 1st to November, and can keep what he last gathers at least a month longer.

[Never on any Christmas day did we enjoy tomatoes as delicious as these. We are pleased that L. B. keeps this plan of *perfecting* tomatoes before the public. As we have before said, it *may not* be the most profitable way for a market gardener,—but for all those with whom quality is worth paying for by a little extra pains, there is no way of raising tomatoes like this—ED.]

#### BUD VARIATIONS.

BY MR. CHARLES ARNOLD, PARIS, ONTARIO,  
CANADA.

I send you by mail two specimens of fruit, and wish you to give your opinion of them as to whether they are apples or pears.

You will observe by the accompanying letter from Dr. Lawrence, that they grew upon the branch of a pear tree. When the Doctor first showed me the fruit, I thought there must have been some mistake as to their origin, and said, that even if true as to their growing upon a pear branch, the case was so extraordinary, that to make it public, would be at the risk of our reputation for veracity. The Doctor, however, is very positive; therefore, after some further conversation with Mrs. Lawrence, we took the fruit to C. Whitlow, Esq., Mayor of the town and President of the Horticultural Society, and after calling together several other members of our society, with the Secretary, Mr. Henry Hart, we proceeded to examine and taste the fruit. All parties present were of opinion, that the fruit much more resembled apples than pears, both in flavor and appearance. Some fancied they could perceive quite a pear flavor, but all were unanimously of opinion that there was no trace of R. I. Greenings in the flavor.

The readers of the *Monthly* will doubtless ask, are the statements of Dr. Lawrence correct? I will only say, that no one who is acquainted with the Doctor or his wife, will for a moment doubt their veracity. This year seems to have been remarkable for the production of sports in

cereals and fruits, in this section of country. Several varieties of my cross-bred wheat have shown a disposition to sport in every direction. One gentleman in this vicinity has a Spitzenberg apple that was grafted in the root long, long ago, and for many years it has borne genuine Spitzenberg fruit; but this year one branch of this old tree produced fruit that had no resemblance to the fruit of former years. This last mentioned case, is no doubt an instance of bud variation. It will be observed that the pear tree of Dr. Lawrence was full of blossoms in the spring, but that the fruit did not set. This would seem to indicate that some portion of the flower was defective. If then we venture to assume that this fruit did grow upon a pear branch, may we not conjecture that the defect in the pear blossom, was remedied by the perfection and superabundance of the same material in the apple? We all know that if we plant a few grains of dark purple corn, and near by we plant white sweet-corn, that we will find in the fall both varieties of corn in the same ear. These two varieties of corn are as unlike each other, as apples are unlike pears. Therefore it may not be amiss for all of us, who have been in the habit of treating such statements as those now made by Dr. Lawrence, as absurdities, or as facts existing only in the disordered imaginations of a few, to ask, are such phenomena possible under certain circumstances, although, perhaps, very rare and improbable?

The following is the letter of Dr. Lawrence referred to:

PARIS, 21st Dec., 1870.

CHAS. ARNOLD, Esq.—*My Dear Sir*:—The two specimens of fruit, which I handed you a day or two ago, were picked from a small pear tree. (dwarf.) I have reason to think a Tyson, on or about the 10th of October ult., by myself in company with my wife. The tree had been full of flourish in spring, but I had not seen any fruit on it till that day, when we were picking apples from a Rhode Island Greening, which grew near it—to my astonishment I saw what appeared to be two apples on the pear tree. They had a very slight resemblance to the Greening, but yet were not the same. I immediately suspected that it might be a twig of the Greening mixed with the pear branches. I therefore got my wife to hold them quite separate, and convinced myself that they grew on the pear tree when I removed them. I would have

called the attention of yourself or some other of our fruit growers to the phenomenon, but I did not think it anything extraordinary, considering it a case of hybridizing, having heard so much of it lately, and not myself have given the subject any consideration. I am, my dear sir, yours very truly,

JOHN LAWRENCE.

[This is a highly valuable communication. There is no mistake here, for on opening the specimen sent the seeds furnished undisputed evidence that the fruit *is a pear*, and not an apple. Then the insertion of the stem is not the insertion of an apple. In the apple we know that the stem gradually fits in the cavity, until it is tightly clasped,—that is, the basin is funnel shaped, the funnel scarcely having any outlet at the point as one would say,—but in this specimen the basin is rather bell-shaped, just as one could imagine it would be if a pear had its stem *pushed in*, the pulp and skin going with it. In the seed and the stem cavity or basin, there is not the slightest relationship to the apple. The curious part of the affair is, that the pulp is undoubtedly that of an apple. The apples were rotten when they got here, we could not judge of the perfect flesh,—but there is one character by which the decayed pulp of an apple can be always distinguished from that of a pear. *Apple pulp is fibrous—pear pulp is granulated.* We carefully washed this pulp, and there was not the slightest trace of the gritty masses which characterize pear pulp. It was *apple pulp* most undoubtedly.

We regard this, therefore, as one of the most wonderful discoveries in all our experience. We hold, as our readers know, rather advanced views of the important part played by bud variations in the origin of species—what importance this new item will have in this discussion remains to be seen.—ED.]

#### NEW FOREIGN GRAPES.

BY MR. JAMES TAPLIN, MANAGER TO GEORGE SUCH, ESQ., SOUTH AMBOY, N. J.

A few remarks on the new varieties of English grapes may be possibly acceptable to some of your readers, and also answer the numerous inquiries we receive as to the qualities of varieties as yet but little known in this country.

The Royal Ascot cannot be called a very new variety in England—there it is generally well spoken of. I had the pleasure of tasting it from the

original seedling vine, and then considered it a valuable grape, and since its extra free-bearing qualities have been proved, it has increased in favor. I am not prepared to call it a perpetual bearer, but it will show bunches at every eye, or in some cases four or more from a small side shoot and also from the laterals. It is one of the most prolific varieties for pot culture I have seen. This season we had a few small plants left over, which we considered too weak for sale. They were left in an old cold frame, with only watering each plant, and they not only showed fruit, but ripened nice bunches. It is a beautiful black grape—very juicy and refreshing—very thin-skinned, but not liable to crack from that cause, but will rot if allowed to get wet from any cause after it is ripe. That is the only fault I have heard complained about in English gardening periodicals.

“Mrs. Pince’s Black Muscat” This is another excellent variety which, previous to being sold to the public, was not done justice to by the growers, who looked at the number of bunches grown in a certain space in preference to fine show grapes. A fact which I mentioned to Messrs. Pince on receipt of some fruit for my opinion. I advised them to place some plants in the hands of Mr. Meridith, the noted grape grower, near Liverpool. The next time I visited Mr. Meridith he had the fruit in perfection; it looked like a totally different variety. It is a fine black grape with a full muscat flavor. It requires a hot graperly to bring out the full flavor. Vine freely growing and fruiting. Fruit keeps well.

“Golden Champion.” Without doubt the handsomest of all the white grapes—large bunch and immense berries. Mr. Thompson the raiser of it sent me berries of it when ripe, which were certainly the largest grapes I ever saw, but those were not perfectly ripe, but I should judge them equal to Black Hamburgh. The growth of vine is short-jointed, like the Champion Hamburgh, from which I believe it was a seedling.

“Dutchess of Baeleuch.” Another of Mr. Thompson’s seedlings, and named after his employer. It is one of the finest flavored grapes grown; in fact it has taken the prize in open class, wherever shown for flavor. It is a long bunch of small berries where I have seen it, but some growers in Scotland are said to exhibit it with quite large berries.

Madresfield Court Muscat. This is a splendid

grape. Mr. Cox, the raiser, when visiting me at Chatsworth, told me he had a grape that would beat Mrs. Pince, and on receipt of some fruit some time after, it certainly did, at least in appearance, for these had been grown for quality; but since seeing Mrs. Pince well grown, I have arrived at the conclusion that they are both excellent varieties, which would give satisfaction to the most fastidious taste if well grown in a warm grapery.

Frankenthal. Although not a new variety, this does not appear to be generally known in this country—growers generally planting the old Black Hamburgh in their cold graperies. The above is a fine variety of the Black Hamburgh; in fact the variety is exclusively grown by English exhibitors for competition.

## FUNGI AND ITS STRUCTURE.

BY JOSIAH HOOPES.

*From an Essay Read Before the Penna. Fruit Growers' Society.*

Gentlemen, we will now pass to another source of disease in our fruit trees, and one which is making terrible depredations in most sections of our country,—it is no less than that of *Fungi*, the lowest forms of vegetation.

The minute parasitic species are so insidious in their approach, so infinitesimal in size, and increase with such fearful rapidity, that they prove no mean enemy indeed to contend against.

And now some remarks on their general structure and mode of propagation.

Of the larger species, including *Puff-balls* of various kinds, *Mushrooms* both edible and poisonous; the delicious *Truffle* (*Tuber cibarium*) and the highly nutritious *Morrel* (*Morchella esculenta*), I shall have nothing to say, although exceedingly interesting in their structure and classification. I merely propose to inquire into the microscopic members of the family,—those parasites which cause the pomologist so much vexation and loss in various ways. Our notification of their existence, is mainly visible in the form of *Mould*, *rust*, *mildew*, *smut*, etc., and wherever these are detected, disease will surely follow. The reproductive fragments of fungoid plants, known as spores, are not unlike the seeds of flowering plants, inasmuch as they germinate and produce a new generation after their kind. They are unlike, because the spores contains no embryo as in the higher orders. As the manner of reproduction in these crypto-

gramic plants is not altogether fully known, my remarks on this subject will have to be somewhat speculative, although founded on scientific facts. It is often questioned among horticulturists, how the spores of one season can contaminate or find its way to the young plant of a succeeding season's growth. The prevailing theory is as follows: When we closely examine the spores, we find they are not unfrequently larger than the stomates or breathing pores in the cuticle of the leaf, which it is destined to destroy; thus admittance in this direction is rendered impossible. The next plausible suggestion is, can they not penetrate into the roots? But here, another barrier is interposed, the spores being as large as the root cells. We now call to our aid a mycological fact, which will assist us in our inquiries: Spores undergo a primary change before forming young plants, as after falling to the ground, and coming in contact with moisture, they throw out slender hair-like fibres, which enter the apertures in the roots, and thus work their way into the tree itself. Or, as is sometimes the case, changed into a fluid state, become absorbed, and thus enter into the vessels of the plants. Some species are reproduced in the same manner on the external portions of trees.

It has also been surmised on reliable grounds, that seeds of plants not unfrequently become inoculated with the poisonous virus, and during germination and growth, carry with them the destroying power, which, not until maturity shows its baneful presence. The first process of development of fungi, is from the spore or seed-like fragment, to the *mycelium*; the latter corresponding to the roots of plants. This is in the form, either of fine silky threads, or, more or less closely compacted cells. Says Berkeley, the eminent English Mycologist, "there can be neither a perfectly free mycelium, nor free organs of reproduction, except in aquatic aerial species, which are of very rare occurrence; even if floating, there will be something in the shape of roots, and the spores will always spring directly from the threads at the expense of the endochrome."

By some naturalist, Fungi have been considered capable of spontaneous generation; but I firmly believe this view to be diametrically opposed to those beautiful and unchanging laws that Nature has so plainly shown in all the higher orders of creation, and which are, at the same time, so essential to vitality.

“That Fungi,” according to Berkeley, “should spring up everywhere under fitting conditions, is readily explained by the enormous quantity of fruit which they produce.”

“Multitudes of spores find at once a proper nidus, and throw out their mycelium, which in some cases, may exist for years without producing fruit, and in other instances, is essentially perennial, yielding an annual crop for almost an indefinite period.” “Other spores are wafted about in the air, where they may remain for a greater or less period, till, obeying the natural laws of gravity, they descend in some distant region.” It is said the Trade winds carry spores of Fungi thousands of miles before they are deposited.

The reproduction and dissemination of most fungoid plants, depends very materially upon the condition of the atmosphere; hence we find that many of the diseases caused by their presence, have been attributed to atmospheric changes. The terrible Potato disease is the result of a very destructive mould, which, during warm and moist weather, luxuriates in a wonderfully rapid manner; but, on the contrary, soon perishes, should a drought set in. It has been proven that this disease is caused by a mould, but it is not necessary for me to enter into its history at this time. Some species of Fungi, however, grow as readily during a dry season, as if it were rainy, but as a rule, they are far more numerous in wet weather. “A moist autumn, after a genial summer, is most conducive to their growth, but cold wet summers seldom are productive.” Again, quoting from Berkeley, “The localities they effect, are as various as their forms.”

Wherever there is moisture combined with a proper degree of temperature, together with organic matter, Fungi are capable of existence. The spores of the *Penicillium*, which infested the bread some years ago in Paris, to such an alarming extent, were capable of sustaining a heat equal to that of boiling water, without losing their power of germination, and it is certain that they can bear many degrees of frost without injury. Some species at least are to be found in a growing state, wherever the soil is actually free from frost, and many seem to flourish most vigorously at a low temperature. Sweden with its various soil, large mixed forests, and warm summer temperature, seems to produce more species than any part of the known world; and next perhaps in order is the United States, as

far as South Carolina, where they absolutely swarm.” As a general rule, they decrease in numbers as we approach the colder regions, and increase toward the temperate. In Torrid climates they are prevalent, but much less frequent than further north. Several species of fungoid plants present two distinct and dissimilar states, before arriving at maturity, and what were formerly considered different plants, are at present known to be one and the same. This is termed *dimorphism*. An excellent illustration of this change, is presented in the Fungus familiarly known as the Barberry Mildew, and at the same time affords a useful hint to the practical observer. English farmers for many years have contended that this disease was contagious, and liable to be introduced into their wheat fields from the Barberry, when growing in near proximity. The Cryptogamic botanists endeavored to prove, that the mildews affecting each, were two entirely distinct plants, nowise related, and therefore the contagion was simply impossible, and the farmers were voted by unanimous consent, ignorant and superstitious. Unfortunately for the assertions of the scientific gentlemen, what were formerly considered two distinct plants, are now *known* to be only forms of one and the same species, and able to disseminate the disease from Barberry to Wheat. This same character is often illustrated on the leaf of the Rose: the under side being covered with a complete net work of mildew, whilst above are seen numerous spherical yellow bodies, producing spores. Both states belong to the same plant. The mildew is merely a primary condition, which afterward develops into beaded bodies bearing spores. Fungi, when in the form of mildew or mould, although but in the earlier stages of growth, produce disease and death by appropriating the juices of the plant upon which they are found, as in the case of all parasites. They also impede a free circulation, by distending the respiratory organs in the epidermis, known as the stomata. In regard to the very small size of the seed-like bodies produced by Fungi, an English Mycologist has recorded, that “a single spore of the *Polyperus caesus*, measures one 10,000th of an inch in extreme length, and in width, one 20,000th of an inch, thus taking the inconceivable number of 200,000,000 of spores to cover one inch superficial.” M. C. Cook, in his interesting little work on Fungi, says: “On the *Goatsbread* (*Tragopogon pratensis*) the leaves have the appearance as if sprinkled



with gold-dust, and each speck of dust is a little cup containing spores, or more properly *protospores*. Each of these bodies is doubtless capable of reproducing its species, and if we compute 2000 cluster-cups as occurring on each leaf, and we have found half as many more on an ordinary sized leaf, and suppose each cup to contain 250,000 spores, which again is below the actual number, then we shall have not less than 500,000,000 of reproductive bodies, on one leaf of the Goatsbread, to furnish a crop of parasites for the plants of the succeeding year. We must reckon by millions, and our figures and faculties fail in appreciating the myriads of spores which compose the orange-dust produced upon one infected cluster of plants of *Tragopogon*. "Nor is this all, for our number represents only the actual protospores which are contained within the peridea; each of these on germination, may produce not only one, but many vegetative spores, which are exceedingly minute, and individually may be regarded as embryos of a fresh crop of cluster cups." Most of you are acquainted with the sooty patches on wheat. It has been computed that 8,000,000 spores of this fungus, would merely cover one square inch of surface. "For every ear of diseased wheat," says Cook, "10,000,000 spores have been distributed for a future crop." A curious feature in Fungi is, that they exhale carbonic acid, and absorb oxygen, thus being diametrically opposed to *Flowering or Phænogamous Plants*; and rendering them useless in keeping up the balance between animal and vegetable life. To this cause is attributed the absence in their cells, of *chlorophyll*,—the green coloring matter seen in the higher orders of vegetation.

#### FUNGOID DISEASES.

We will now pass to the consideration of the disease caused by the presence of Fungi; but, in so doing, I will merely select such as have proven the most injurious. The Grape appears to offer a fair field for these pests, for we find different species luxuriating upon it, at every period of the vine's growth, and in various ways preying upon the fruit with remorseless avidity. Commencing with the terrible Grape disease, that ravaged the vineyards of all Europe, and which was entirely unknown previous to the 1845. We are informed that it was at first attributed to numerous foreign agencies, until the true cause was discovered by Berkeley. Finding it belonged to the old genus *Oidium*, he gave

it the specific name of *Tuckeri*, in honor of the gentleman by whom it was first brought to notice. The presence of this Fungus is first detected by the appearance of the vine, which changes to a yellowish hue, soon a white stud-like substance is noticed, and the little parasite then emits a musty odor, and spreads with almost inconceivable rapidity. In the later stages, when the Fungus is about developing its fruit and discharging its spores, dark-colored spots take the place of the mildew,—the leaves curl up, and the grapes split open, or dry up in most instances. The very valuable paper on this subject by a French Vineyardist,—H. H. Mares—has lately been incorporated in Flagg's work on European Vineyards, which is well worth a careful perusal. In regard to the species of mildew affecting our hardy grapes, I am afraid I cannot give you any very definite information, but I am decidedly of the opinion, that they are all quite distinct from the *Oidium Tuckeri* of Europe, although nearly related to it. Of the many varieties of grapes grown in the Northern States, those of foreign parentage, are the most susceptible of mildew and rot, so that by our glass structures we are enabled to produce an atmosphere, uncongential to the growth of these cryptogams. Dr. Engelmann, of St. Louis, describes two forms of our Grape disease under the names of "Brown rot," and "Black rot," both of which I have detected in this State. For a full description of these, I will refer you to the "Trans. of the Acad. of Science, of St. Louis," vol. 2, p. 165, 1863. Prof. Silliman also refers to the same, in the *Horticulturist*, vol. 18, No. 10. During the past summer, my attention was called to a curious disease in the viney belonging to our worthy Secretary at Germantown. I procured a few specimens of the fruit of a Black Hamburg, and placing a portion of the diseased skin under a microscope, I soon found unmistakable signs of Fungus, which, upon examination, presented two very distinct forms. One, which I presume to be nothing more than the Mycelium, was very like the usual grape mildew in general character. The other, and more dangerous form, was of a nature to create suspicion in the minds of every grape grower, for it answered in many particulars the greatly to be dreaded *Oidium* of Europe. The small rust-like spots and patches, were not unlike the *puff-ball* family, on long stems,—those most advanced, splitting open, and discharging their myriads of dust-like spores. This last form I take to be the culmination of the disease, and was similar to many species of our worst parasites.

## EDITORIAL.

## TRAVELING RECOLLECTIONS.

THE early morning of a fine summer's day at the end of August, found us in the midst of Geneva, New York.

Much has been said and written in praise of the Geneva of the old world; but if its beauties are half so attractive as its American namesake, it must be a pretty place indeed. There is no doubt but that the accumulations of art, which give ripeness to the scenery of the old world, add much to the interest of the famous places there. There may be a softness in the skies, a dreaminess in the air, ghostly whisperings from the dead past in every breath that stirs about one; but in these young places there is a virgin beauty peculiarly their own,—a living, acting force of growing strength, far more enticing to those who would be heroes in life's battles, than in any place other parts of the world can offer. After seeing the beauty of Seneca Lake and its pretty little village of Geneva, we can appreciate the sentiment of an eminent Philadelphian, who after a two year's tour in Europe, remarked that an American who could not live in his own country, was not fit to die.

But we have a good friend tugging at our coat sleeve, whispering to "stop this nonsense, and tell us something about the horticulture of the place." So, standing on the platform, we shut our eyes to the lovely beauty of the lake scenery, and turning in the opposite direction, find at once two capital subjects for our editorial pencil, in the shape of Messrs. Willard, of Graves, Selover, Willard & Co., and T. W. Smith. The latter gentleman was on his way West, on some foraging expedition, in which kind of business he is, as is well known, so eminently successful, for he has been one of the most prosperous of the many hundred nursery firms in the United States. But he gracefully yielded to the magnetic influence of Willard's buggy, and afforded us a chance to pick a good many valuable ideas out of him, of which our readers will reap the benefit all in due time.

A half hour's drive up the beautiful Washington street, brings us to the nurseries of Graves, Selover, Willard & Co. A handsome office, with which all who get their catalogues are familiar, welcomes the visitor at the entrance. It is sit-

uated on an eminence, and from a turret on the top, a magnificent view of the surrounding country is obtained. On the east, a lake; on the west, another; on the south, the beautifully cultivated farms for which this section of the country is so famous, and of which those of Messrs. Seldon and John Johnson are types; and on the north, the two thousand acres of nursery land, of which Geneva boasts.

The village, we should suppose, does not contain over two thousand inhabitants, and so far as we could see, carries on little business but that of the nursery trade, boarding visitors, and furnishing homes for retired fortunes, which come to close the autumn of their days in this lovely spot.

Of course, one of our first efforts was to solve the problem what had made Geneva come to be one of the leading centres of the nursery trade. We had always heard fabulous stories about the "soil," in order to account for it. And truly the soil was good; but we found that not half the story had been told. Just as good soil and plenty of it can be found in almost any part of the Union; but this spot was fortunate in having half a dozen good men settle on it a quarter of a century or so ago, who loved their business, who never allowed their love for it to be distracted by other loves, and who, remaining true to it, have been rewarded by that prosperity which true love always brings forth.

The Smith Bros. and the Maxwells have made Geneva what it is; and even Graves, who, though not amongst the oldest in Geneva, must come in for a fair share of the praise, for though not exactly of Geneva, is the oldest nurseryman of that section of the country.

We have said that the land is good; but hard manual labor is spent to get it into good nursery condition. It is a happy mixture of gravel, sand and clay, which contains all the elements of fertility, but holds water very near to its surface. Hence most of it has to be under-drained with tile, at some expense, before trees can be planted on it. Yet, with all this, it did not appear to us that trees suffered to grow up to orchard purposes throve by any means amazingly. Wherever we go we get some fun poked at us, for being supposed to advocate "neglecting trees in

grass." If there should be a half-starved specimen of a fruit tree anywhere, with its owner out at the knees, or with the remains of his old felt hat smashed over his shaggy brows, staring at us along our route, it is sure to be particularly pointed out to us as the "results of Meehan's system of fruit growing."

But our friends here were more considerate. They took us to an apple orchard to show the good results of clean surface culture. We had heard of this orchard before; but the trees were young, not over twelve years of age, and had not time, in our opinion, to show the merits of any system, for it is only when trees are about bearing abundantly that constitutional vigor tells. At any rate, we did not note anything very remarkable about these trees, except the handsome deep green of their foliage, which certainly was typical of good health, but the growth was not very vigorous. It struck us as not having averaged over a foot a year during the past six or eight years. We did not, however, lay this to the charge of any system, but took it as an indication that there was nothing so very far ahead of other places in the soil of Geneva, and it was therefore the men themselves whom we had to thank for the marvelous results we saw.

The leading items in the nurseries here are fruit trees, and especially the Standard Pear. These seem to be propagated much in the old way, but in apples, a very large number of growers had returned to the old practice of summer budding, instead of, or rather in addition to winter root-grafting. The idea seemed to be not that the plants were any better budded than root-grafted, but that a stronger and straighter stem could be had in this way, than from root-grafted trees, and they were therefore more saleable. The plants used for budding were not, however, as the catalogues say, "too small to graft, but good enough for budding." The very best stocks are used, as would be for root-grafts. One would suppose that this would not be so profitable as root-grafts; but the general way in which the plan was being followed by new beginners, showed that there was "something in it."

The most extensive nurseries here are those of the Maxwells, Smith, and Graves, Selover & Willard. But these deal considerably in ornamental things, while the scores of others, whose names are familiar to the public, keep chiefly to fruits. The Maxwells, particularly, are very

enterprising, and add to their collection everything new. The new Golden Arborvitæ, not yet sent out, was being largely propagated, but will not yet be ready for sale for a year or two. Gladiolus, Roses, and similar things were grown by the acre. At Graves, Selover & Willard's, the ornamental stock was particularly interesting, not only for the amount under nursery culture, but for the many fine specimen plants which they are getting up about the ground.

Very reluctantly we took our leave from so much horticultural enjoyment, and so many good friends, and took the steamer down the celebrated Seneca Lake, for the little town of Watkins, which bristles at its head. It is said that this lake never freezes over; but some residents along the shores whom we found on board, spoke of having walked across sometimes during their lives. Still it seldom does so, and its almost fathomless depth makes the foundation of many a long story. The banks on each side were frequently clothed with healthy fruit trees, of which the grape appeared to thrive in wondrous luxuriance. Arriving at Watkins, we had a warm recollection of our first Tompkins county King Apples, which we ate at the hands of our friend, Colonel Frost, who did so much to make this excellent variety widely known; and we, of course, stepped aside for an hour or two, to see what other good things he had to put in our way. We found him still in the harness, pushing along his nursery business in his old energetic and successful way; and yet devoting much of his time, as a good citizen should, to the general welfare of his fellow citizens at large. His capacious and hospitable dwelling is quite an ornament to the little town, and the ground in front of the house, with its little fountain, evergreens, walks, and flower-beds, have a very cheerful look to the passer-by. The colonel and his good wife entertained us with such fascinating stories about the beauties of Watkins' Glen, that in spite of the twittings of our conscience, for having been too long away from our editorial stool, we could do no less than hold over for another day. Any one who has seen this beautiful spot need not be told how heartily we thanked our kind host and hostess for persuading us to stay. Everybody should of course see Niagara, the falls of Minnehaha, and the pictured rocks of Minnesota—the grand bluffs of the Illinois and the Missouri, Harper's Ferry, and the beautiful scenery of the Virginia mountains, and the

drives of the Wissahickon and Fairmount Park. All these, and other places as celebrated, will always be worth a traveler's attention. Yet we doubt whether any one can say they have seen the beauties of the American continent, until they have seen Watkins' Glen. Here is a rift in a mountain, only a few hundred feet wide at the best, and often but a few score, and yet, with its walls from one hundred to perhaps three hundred feet high. A stream, which has formed this chasm, flows over its bosom, now forming a small lake, now a rapid, now a whirlpool, now a rushing cascade, and now eddying around in caves and chambers of wondrous architectural beauty. A "mountain house" for summer boarders has been established here, and the proprietor has spent considerable money and ingenuity in enabling visitors to explore this enchanting spot. After wandering along some narrow ledge of rock, until it becomes impossible for art to do any more for a foot-hold, a bridge or stairway to some ledge on the other side is skilfully thrown across, until again we have to cross to the other, back again. In this way we managed to proceed several miles, until both art and nature gave out, and we had reluctantly to retrace our steps, with the poor satisfaction in regard to the unseen beauties beyond, of having trod our foot as high up the ravine as any other man ever did.

While we were there, the geologists were fighting terrific battles over the origin of the chasm. Paper bombs of awful power, in the shape of pamphlets and newspaper articles, abounded, and it seemed to us that some body would undoubtedly get hurt; yet, to our unprofessional eye, the matter seemed simple enough. Here was an immense deposit of lower silurian rock, which had been, at one time, the bottom of a still water lake, but subsequently thrown up, as many similar deposits in other places had been. The sand and mud which formed this rock, had been deposited, in the ancient times, in annual or periodical layers of from a quarter of one, to one or two inches thick. These layers are harder or softer, according as their mechanical composition—more sand or more clay—composed them; and, of course, the softest wears away the easiest, making the bays and inlets, we now see, under the dominion of modern elements. But the present stream, say the geologists, even when at its highest volume of water, could never make the chasm as wide as it now is. But to us frost would do all this. The freezing water in

the innumerable crevices throws out the loose pieces, which fall on a thaw, and are little by little carried away by the rapid water flowing at the base.

There is one great attraction which Watkins' Glen possesses, almost alone, and which will ever attract the lover of nature to it—the natural history of the place. While at Niagara, one has to be satisfied with stunted arborvites, and wild raspberries, perchance a few asters, Penguiculas, and Buffalo berries, as the vegetation of the place. Here we have a remarkably varied and interesting flora, and the other branches of study offered as rich material; and though there is mineral water here as supremely nasty as any to be found at Saratoga, that species of society which makes it unfashionable for people to enjoy themselves naturally, as rational beings should do, has not yet been established, so that for years to come we expect Watkins' Glen will be the resort of people whom the sensible portion of the community love to meet.

Watkins' Glen has also another advantage. It is on the line of the Northern Central Railroad, between Harrisburg and Canandaigua, one of the most beautiful railroad routes in the world, and one which many a traveler, who has time on his hands for pleasure, goes miles out of his way—which he might save over shorter routes—expressly to enjoy.

#### BOUVARDIA VREELANDI.

(See *Frontispiece.*)

Almost every gardener of the past generation is familiar with a plant known to many of them as *Houstonia coccinea*, and to most as *Bouvardia triphylla*. The former name was given to it by Andrews, in the *Repository of Botany*, and the latter by Salisbury, a more recent writer. But it had been previously named by Humboldt and Bonpland, who were the discoverers of the plant in Mexico, *Bouvardia Jacquinii*, by which name it is known in herbariums and botanical works, though few gardeners ever heard it so called. It is yet one of our handsomest fall blooming plants, and an old plant grown for many years in a tub, and set out on a lawn, is possibly one of the handsomest ornaments one could have in a garden.

But it was about twenty five years ago that the *Bouvardia* first became popular as a winter flower, through the introduction of *B. leiantha*. This is now so well known, and is so indispensable to professional florists, that near large towns,

greenhouses are often entirely filled with it. Its beautiful crimson flowers are particularly striking in combination with white camellias, and then the blossoms are produced in succession so easily, that it may be said to be always being cut, and yet always in bloom. It was often said that if one could only get a good white one, with all the good points of *leiantha*, a florist's fortune could be made.

Eventually *Bouvardia longiflora*, a white species, was introduced, but its almost solitary flowers on the ends of the branches did not suit the ends of the bouquet maker, but it served a good purpose in making a parent, for hybridization; and the European improver, soon produced a race of intermediates, of which, perhaps, the variety called "Hogarth" is the best known and most useful.

It has been left to art to do, what all Mexico has not so far been able to furnish—a good white, equal in all respects to *B. leiantha*; and of this we furnish to-day an illustration.

*B. Vreelandi* is all one can wish, and no doubt another year will find it in every collection in the land. An account of its origin has already appeared in our magazine.

In regard to the culture of Bouvardias, it is about as simple as anything can be. Few plants are more easily grown. No special directions need be given for potting, and as for flowering, a heat of over sixty degrees will bring them on rapidly. Usually, they are very hard to propagate. This is best done by little pieces of roots, made into lengths of about half an inch, and the pots containing them plunged into heat of about sixty or seventy degrees.

Most of the hybrids hitherto raised have so much of the character of the original *B. longiflora*, that they do not flower very freely—or at best have not many flowers open at a time; but in the case of this new variety of Mr. Vreeland's we have seen beds which had over two hundred expanded blossoms at once on a single panicle, more, indeed, than we believe we have in *B. leiantha*.

#### HOT-WATER BOILERS.

It is not so common as it was once, to hear scientific education decried. It is now found that exact knowledge—which, after all, is what science really amounts to—is far more profitable than the mere smatterings of what is generally called education. But yet, how little

of exact knowledge exists in horticulture is painfully evident in every thing about us. But, perhaps, in nothing is the immense loss which we suffer for want of true science more apparent than in the usual experience with hot-water boilers, and hot-water apparatus in general.

We go into some establishment which has the houses heated by hot water, and it is a rare chance if we are not to hear complaints about the apparatus. Something does not work right. A hot-water man has been consulted, and he advises a new boiler—such-and-such an improved one will do all the work easily and well. Another thinks there is not enough pipe, or too small pipes, or too level pipes, or something another of this character. But if we question why any of these things are suggested, we find that they know nothing of the principles of the circulation of hot water. Strange as it may seem, we find men who make a business of fitting up hot-water boilers—men who are noted as improvers—geniuses—who mistake entirely the law on which success depends. They tell you that *hot water ascends*, and all the machinery is arranged with this one thing in their mind. Now, water does ascend, but not in the way all these men understand it. When Pat. Murphy up the ladder treads, with a pile of mortar in his hod, he does ascend—he is the motive power. The mortar in Murphy's hod also ascends, but the ascent of the mortar and the ascent of Murphy are two very different affairs. There is no motive power in the mortar; Murphy's ascent is an active principle—the mortar's ascent is a purely passive one. Hot-water ascends as the mortar does, and in no other way. It is a purely passive action; but no one that we have met with ever imagines that this is the case—has the slightest suspicion that there is a Murphy behind it.

Now the active power in hot-water circulation is *cold water*. Water when warmed does not ascend because it is the warmest, but that the colder water pushes it up; not because warm water is the lightest, but because cold water is the heaviest. It is a simple act of gravitation. The cold water displaces the lighter bulk.

But, says the boiler man—and we have heard it argued scores of times in this way—what difference does this nice distinction make? If the hot water flows out, the cold must come in to take its place. Just so, but the trouble is starting with the idea that hot water is the motive power of the circulation, little or no considera-

tion is given to the cold-water force. Examine any case we may, where any complaint is made that things don't work right, and we see at once that there is something of value in the distinction. We would most likely find that the boiler has been so set that the *return pipe gets heated nearly as much as the flow*, and the full flow of cold water is thereby checked. It is almost impossible to get water to "circulate" freely under such circumstances. Hundreds of boilers are torn out or changed for others, or pipes set up or pulled down, when there has been nothing at all the matter but a simple warming of the return pipe.

Now, what is the result of application of this simple principle? Simply that water can be made to go along a level, or up or down, or any way, if only care be taken to get a good volume of cold water behind it. Take care in setting the boiler to have the place of entrance of the cold water as far away from the fire, and as carefully guarded from the heat as possible. It is very well to seek for the best boilers and the most approved size or style of pipes, but all these are of no use without cold water. In short, we would lay down this maxim for all young gardeners to get by heart: *Look after the cold-water pipes and the flow will take care of itself.*

## SCRAPS AND QUERIES.

THE PROMISES OF THE MONTHLY.—We seldom like to refer to the good things our friends say of us,—as we do not want any one for readers unless they themselves are fit to judge whether the magazine is worth reading or not,—but we have been tempted to let the following letter, written by a professor in Cornell University speak for itself:

"I am reminded by the non-reception of your January number, that my subscription has expired, and that for a continuance, the necessary yearly remittance must be made, which please find enclosed. On looking over my list of publications there are several that can be dispensed with,—chiefly those promising largely, but performing little—those that have borrowed both illustrations and matter, too frequent without credit, and are filled with cuts and descriptions of fruits and flowers, with which every school boy in gardening is familiar. We have in this section of country, far away from horticultural exhibitions, fine gardens and greenhouses, and are dependent on horticultural magazines for information.

On my list are two journals that give it to us, and do not make any particular parade about it either,—*The Gardener's Monthly* and Shirley Hibberd's *Gardener's Magazine*. Both are independent, and give their own *practical* experience, that all may profit.

The very modest promises of the *Gardener's Monthly* to its readers, for 1871, are sufficient; for those of 1870 were kept. Without larger pre-

tensions of being better than ever, it is content to rest its future success on its record of the past."

THE GERMAN REVUE HORTICOLE.—In our last we gave notice of a new German Horticultural magazine, printed in English, French and German. The idea was an excellent one. When we made that note we did not know that it could be had in this country, but we see by an advertisement in this number, that Mr. Raoux, can obtain it.

HOW LEAVES ARE FORMED.—A correspondent sends us the following quotation, which he says he finds amongst some manuscript which has come into his possession, and asks us who is the author. We are not sure; but it reads like Herbert Spencer:

"Every leaf of a Phanerogamous plant begins as a cellular out-growth, the base of which embraces a portion of the stem proportioned to the space which will form the insertion of the leaf at a later period. Thus the leaves, whose sheath envelopes the axis on all sides (*Platanus occidentalis*) commences by an annular out-growth surrounding this axis. This is likewise the case with certain opposite and sheathed leaves, which appear simultaneously under the form of a singular annular out-growth (*Galium*). The highest powers of the microscope show nothing in this out-growth but a homogenous structure, which

is called the *primordial leaf*. From this primordial leaf, are developed all the parts which make up the adult leaf. These parts appear in succession. Those first-formed, which are called plants of the first order, spring directly from the primordial leaf; and those of the second order spring from the first, and so on in succession. Parts of the same order form themselves, sometimes from below upwards,—sometimes from above downwards. Moreover, the formation of plants of the same order may take place in the same direction, or in an opposite one to those of the order preceding. The primordial leaf can produce appendages, not only on the lateral margins, (stipule) etc., but also on its posterior surface (facing the axis, the anterior faces the observer). Ordinarily the appendages of the posterior surface grow after those of the side.

Such is a brief resume of the five researches of Steinpeil, Trecul, Negali, Schacht and Eichler.

Stipules are appendages of the primordial leaf, and not the products direct of the stem.

The successive development of parts of the leaf, often in a basifugal direction, lead to its being likened to a branch of limited growth. Such a definition would be inconvenient, as it takes no account of the fact that many leaves do not appear to possess appendages except on their lateral margins, and that these appendages often grow from above downwards, while the leaves of a branch are always developed from below upwards.

A leaf is a branch with the posterior surface atrophied.

Primordial leaves are primordial off-shoots of the terminal cone, the auxiliary branches of which represent subsequent off-shoots. Each primordial off-shoot, or primordial leaf, can, in its turn, produce other off-shoots, primary, secondary, tertiary, etc. Sometimes throughout its circumference, (*Acer pseudo platanus*,) sometimes on one side only (as in most leaves).

ROAD MAKING, ETC.—*A Subscriber, Yonkers.*—Will you please state through the *Monthly* the title of an American work which gives estimates of the cost of road-making, ditching, draining, paving and moving of soil by hand and team, and of all those various operations, which occur in the laying out of places, and greatly oblige an old subscriber.

[What you want is scattered through many works. Mahan's *Civil Engineering* will help you for the general principles of mechanical

work. French's *Farm Drainage* will do more. On the cost of moving soil, we know of no other work to which to refer you.]

ARNOLD'S GRAPES.—These have given great satisfaction in the northern parts of our country. Further south the reports are not so encouraging. A Maryland correspondent planted most of them last year, and does not find any as good as Clinton. No. 16 he thinks was the best.

PRUNING PEAR TREES.—*F. Octorora, Md.*, says, "I am a little at a loss between the advice of some to prune, and of others not to prune at all. I have some very fine Duchess Pears, now six years in bearing. They have not grown as much the two past years as before, and the fruit is failing in quality. I was told that a good pruning, which they never have had, would help them; what say you?" [Those of our readers who have followed us closer, will, we think, not find that we recommend "not to prune." Our opinion is, that a thorough surface manuring, a thinning out of weak and inferior branches, and possibly a shortening of the stronger ones, would be a benefit to you.]

AFTER THE PIRATES.—We find that there is a wide spread movement amongst the nursery and seed trade, to protect themselves from the fangs of those reptiles who have so long preyed on them—in many cases bringing honest, hard-working firms to the verge of bankruptcy by their enormous losses. It is indeed time that the Norrisses and Colies and similar well-known "firms," should find the length of their ropes, and if anything can be done to aid in so goodly a consummation the whole fraternity will be blessed.

The programme, as we have seen it, is a friendly interchange of "experience." A high court in Pennsylvania has recently decided, that such a "confidential" communication of experience between mutual friends is "privileged" and within the law, and does not constitute a libel. The greatest care is to be exercised to prevent anything like malice to operate in preparing the "black list."

In spite of all this, those having the matter in charge, must use great care. It is often hard to judge of the merits of a disputed case. Both parties often think they are badly treated. We would recommend that no one be placed on the

list, on the testimony of anything less than half a dozen witnesses,—unless the testimony of a single witness is so direct, as to leave no room for doubt as to the swindling nature of the transaction.

After all, the best security is strict business rules. Sell to no stranger without care first to know his means to pay, and disposition to do so. No one whose custom is worth having, objects to this test. Above all do not be too easily tempted by a *show* of good conduct. It is a very common thing to buy twenty or even fifty dollars' worth, and pay well; and then order one or two hundred, which is never settled for,—or trees are ordered, sent C. O. D., and then on arrival fault found with something, and rather than risk getting back perishable goods, the shipper agrees to take anything; or references are given to unknown parties; or to good parties for that matter, the swindling concerns knowing that it is not likely the shipper will seek for the necessary knowledge. We know of a firm, for instance, who was referred to "Peter Henderson." Shipping was almost over, as summer was advancing, and to save time, one hundred dollars' worth of goods were sent. A few days afterwards several hundred dollars more were ordered. Henderson was then referred to, and instead of recommending him, he reported, that he had been actually swindled by him. The balance was saved; but these parties should have sent at first to Mr. Henderson. But even then he might have paid Henderson a small bill in order that he might praise him to others, and thus be made an agent in the transaction. It is a difficult subject, and we wish those who are studying it every success in their labors.

THE VINE MILDEW OF EUROPE.—A friend thinks, contrary to the opinion given in a former number, that the *Oidium Tuckeri*, does exist in this country. We have made arrangements with a friend, skilled in fungoid microscopy, and who is acquainted with the European plant, to examine the matter closely next year,—and we shall be particularly obliged by specimens of what any reader may suppose to be this plant.

PEARS FOR MARKET.—*M., Harrisburg, Pa.*, asks: "What eight Pears would you plant for market, standard?" [So much depends on locality in answering this question. But for central Pennsylvania, we should certainly have some Bartlett, and then Howell, Beurre Clair-

geau, Vicar of Winkfield, Beurre D'Anjou, Buffum, Lawrence, and, though slow to come into bearing, a few Seckels, for when *well-grown*, there is nothing pays better than Seckel pears.

THE COMMISSIONER OF AGRICULTURE.—General Capron takes every opportunity to prove that he is the right man in the right place. No sooner was the San Domingo Commission a certain fact than he urged the President to add naturalists to it. The result was, that Dr. Parry as principal, and Mr. Brummel as assistant, were appointed botanists, and Prof. Blake, geologist. The knowledge gained by science, is always of a permanently useful character. Political information, of course, has its uses, but "all things should work together for good."

FIRE BLIGHT IN PEAR TREES.—We supposed that the old theory, that "fire blight" was caused by anything in the constitution of the tree; was about given up. But we note that Dr. Warder, in a recent address, still thinks that some varieties are more liable to it than others. We were surprised at this, as we think experience has proved, that every variety in some place or other is about equally liable. In this immediate district we may say none are "liable." We have never seen a case in Germantown. Though it has been within four miles of it.

MR. MEEHAN'S NURSERY.—*E. S. B., Galena*, says in a note to Mr. Meehan: "I send subscription through you, in order to suggest whether it would not be a good plan to send your nursery catalogues to every subscriber of the *Monthly*." [We note this for the purpose of saying, that Mr. M. has never seen the subscription books of the *Gardener's Monthly*, and does not know who are subscribers to the *Monthly*, except as he may gather from outside sources, as "any other man" may do. The reason for this is, that when the *Monthly* was first started, many friends of it in the nursery trade furnished lists of their correspondents and customers, most of whom became subscribers. Mr. M. has always felt that it would be dishonorable under such circumstances to profit personally by an act intended solely for the good of horticultural literature. For the same reason we have always declined tempting offers to allow our books to be used for the purpose of mailing catalogues for any firm. Mr. Meehan is paid for his services on the *Monthly*; and in his nursery and seed



business his relations to the *Monthly* are precisely the same as that of any other nursery firm. We are glad of the opportunity to make this explanation, as we find the idea not uncommon, that Mr. Meehan has a proprietary interest in the magazine.

ROBINSON'S PARKS AND GARDENS OF EUROPE.—*G. A. L., Waltham, Mass.*—"Will you be so kind as to inform me where "Robinson's Parks, Promenades and Gardens of Paris," can be procured. Please answer through the *Gardener's Monthly*, if it does not interfere with your rules to notice this publication."

[There is no American edition,—but it can be had through any bookseller, who imports from Europe. Any of your large Boston importers would get it for you.]

DR. HALL'S CURCULIO CATCHER.—We are glad to note that this useful invention, which we saw in such successful operation on the Doctor's grounds at Alton, is now being manufactured by a firm in Ottawa, Illinois, for the general public—we rejoice particularly as we know this means more plums for us all, and we hope the sale will prove a "good plum" to the ingenious inventor of the machine.

SIEVA BEAN.—In our notice of things about Troy, N. Y., we noticed a very early bean having relationship to the Lima; but which the market men who sold it called "Selah," and considered it, in the north a month earlier than the Lima. The southern *Planter and Farmer* thinks it recognizes an old acquaintance, the "Carolina Sieva," extensively grown in the South on account of its earliness and prolificness. It is *hardly* six weeks earlier than the Lima, however.

DR. WYLIE'S HYBRID GRAPES.—A correspondent from Aiken, South Carolina, writes, that so far the hybrids of Dr. Wylie, of Chester, exhibit great promise.

DISEASE OF HOLLYHOCKS.—*B. S., West Philadelphia, Pa.*, inquires, what is the matter with his Hollyhocks. The leaves get spotted during the summer, and appear as if burnt, and the spikes of flowers are poor and weak in consequence. We have before noticed this in our pages. We suppose it results from the attacks

of a minute fungus. The best way is to raise fresh plants occasionally from seed. With care, the varieties usually come true from seed. The improved English varieties are very beautiful, and the seeds are usually offered every spring by our leading seed stores.

GRAPE CULTURE IN VIRGINIA.—An intelligent correspondent of the *Southern Planter and Farmer* referring to some remarks of ours, says: "Is it true, as Mr. Meehan says, that 'we still go on failing day after day under our old systems.' I am inclined to think, Mr. Editor, that grape culture has been and is a great success in all portions of this continent, lying between those parallels of latitude within which the grape has ever been known to flourish. Canada and Maine do not produce grapes abundantly it is true, but they do pretty well in Virginia, and Mr. Husman doubtless thinks they do well in Missouri. One thing is certain—there has not been a failure reported in Virginia during the past five years."

ROCKY MOUNTAIN EVERGREENS.—An Omaha correspondent sends us branches of Coniferae from the Rocky Mountains. It is not easy to name them from branches alone; but we believe the following is near right:

1. *Pinus contorta*. 2. *Abies Menziesii*. 3 appears to be a form of a common white spruce, *Abies alba*. 4. *Abies Engelmanni*. 5. *Pinus flexilis*, or it may be *P. aristata*. 6. *Abies Douglasii*. 7. *Abies Williamsoni*, but it may be *A. Albertiana*; no body seems to know how to distinguish these,—and yet they appear different. The Juniper appears *J. occidentalis*, although it is much like western forms of *J. communis*.

The broad-leaved small evergreen is *arctostaphylos uva-ursi*, and this is one reason why we think the Juniper and the *arctostaphylos* growing together is perhaps but a form of *J. communis*.

We should like another specimen of this Juniper. Our Postmaster was friendly enough to let us examine the specimens a few moments at the post-office; but the whole bundle was "confiscated," in default of our willingness to pay letter postage on it, because there was writing inside—when will our correspondents learn this?

FRUITS IN KENTUCKY.—A correspondent from Calhoun, Ky., says: "While you have, from accounts, plenty of apples and pears on your side

of the mountains, we have very few here. Our apples nearly all fell from the trees during the warm, dry weather of summer. My pears and grapes did as well as usual, but were not much in demand during the summer. I sold all of my best winter pears at 15 cents per lb. They were nearly all winter Nelis, which I consider the most valuable of any other winter pear.

OUR COLORED PLATES.—Few magazines have ever received more kind notices, unsought, than ours. Though not in the habit of parading our friends' good opinion of us, their good feeling is not the less appreciated. But we feel particularly their kind commendations of our colored plates, and quote them occasionally, inasmuch as the editor had no hand in getting them up, he can refer to Messrs. Sinclair's excellent work without feeling that he is helping to "blow his own horn." We copy, therefore, the following from the Philadelphia *Morning Post*, with much pleasure, and particularly because it was very much of an experiment that we introduced them. We were told by numerous friends that they "could not be done creditably in this country," and we had better not try. But the *Post* says:

"In addition to the usual excellent table of contents, this number presents an admirable colored engraving of the "Martha" grape, one of the best specimens of the art we have seen in any magazine."

PASSIFLORA ARBOREA (*Bot. Mag.*, t. 5864).—"Though displaying none of the beauty of the commoner cultivated Passion-flowers, and wanting their scendant habit, copious festoons of leaves, and elegant tendrils, the subject of the present plate is still a very interesting one, from its erect habit and large foliage, in which respect it stands almost alone amongst its 120 congeners." It grows from one to twelve feet high, "bearing few but beautifully smooth dark-green pendulous leaves, one to three feet long, and looking like a green umbrella stuck in the ground." The flowers are two or three inches broad, greenish-white.

CATALOGUE OF C. L. ALLEN & Co., NEW YORK.—We often take occasion to notice improvements in catalogues, which are amongst the best methods of spreading information amongst the people. This one has a very interesting feature in addition to its other merits, that it gives with the derivation of the names of the plants, little bits of history which always please. Many names seem to novices hard and meaningless, that are reasonable enough when their derivation is explained. Messrs. Allen are, however, in error in giving for *Polyanthus* the tuberose, the derivation *Poly* many, and *anthos* a flower. But we have corrected this so often in the *Monthly* that we tire of referring to it.

## NEW AND RARE FRUITS.

GRAPE—MORRELL'S SEEDLING—Raised by a gentleman of that name in Germantown, has been placed on our table. It is a blue grape of medium size, sharp and pleasant flavor, not equal to the best grapes now out, but superior to a very great number which have been distributed of late years. It is certainly a better grape than Hartford Prolific or Concord, but not equal to them in earliness.

BURLINGTON GRAPE.—Mr. A. Taylor, of Burlington, Vermont, exhibited a new seedling grape at the State Fair recently held at that place, which seems to be a real acquisition to the small list which are hardy in northern New England, and at the same time of good eating

qualities. This grape, which Mr. Taylor, originated, and which he has named "Burlington, from the place of its origin, is perfectly hardy, being entirely exposed throughout the winter. As a table grape it is fully equal to the "Adirondack," and approaches the "Delaware," while it is much more hardy than the latter. This grape deserves the attention of horticulturists. It is not understood that Mr. Taylor has any vines for sale at present.

"PARKS' CLING"—A NEW PEACH.—The "Parks'" originated in the grounds of Mr. A. L. Parks, at Alton, Ill., from a chance seed. This is a magnificent looking peach, and in point of beauty is not surpassed by any of the earlier

peaches. Specimens were exhibited at the late Fair of the Illinois Agricultural Society that measured eleven inches in circumference. The tree last year, and again this, bore well; leaves with globose glands; fruit of the largest size and heavy, broader than deep; suture deep, extending quite around the fruit, dividing it equally; skin not very downy, light creamy yellow, mostly covered with red; flesh also of a light creamy color, stained with red, but deeper red at the stone; very juicy, but not of the highest flavor; ripens eight to ten days later than the Heath Cling.—*Prairie Farmer*.

**NEW PEAR—BROCKWORTH PARK.**—This is an English seedling, and far in advance of nineteen-twentieths of the continental trash which is year by year forced upon us. It is, indeed, a first-class pear, and the standard is now placed high. It has been awarded a first-class certificate by the Fruit Committee of the Royal Horticultural Society. At the first glance, it greatly resembles the Louise Bonne of Jersey. The fruit is large, pyriform, rather bulged in the centre; skin smooth, pale yellow, slightly flushed and streaked with crimson on the exposed side; eye small, close, segments of the calyx pointed, set in a shallow basin, the end of the fruit being frequently blunt; stalk about an inch long, stoutish, obliquely inserted without any depression; flesh white, delicate, buttery and melting, very juicy, rich and vinous, exceedingly pleasant to eat, greatly resembling in texture the well known Marie Louise. This we welcome as a valuable addition, and congratulate the raiser on his success. We believe it will be sent out by Messrs. J. C. Wheeler & Son, of Gloucester.—*London Journal of Horticulture*.

**FULTON APPLE.**—We received from Mr T. W. Willson, Iowa City, Iowa, by his daughter, Mrs. Coolidge, of Leavenworth, Kansas, a very fine specimen of this handsome apple, for a name, it not being recognized there. The following is the description of the apple sent us, which is fully worthy all we say of it: Fruit large; weight ten ounces; form round, truncated, or flattened, slightly oblique, compressed and faintly ribbed; skin rich, bright deep yellow, with a soft buff blush; dots numerous, small, green and gray; stem short, slender; cavity wide, deep, regular, green; eye large, open; basin wide, abrupt, deep, furrowed, ribbed and leather cracked; core small, slightly

open, regular; carpels wide; seeds large, mostly imperfect, dark brown; flesh yellow, tender, rich, juicy, sprightly, subacid and fragrant; quality very good; use, table, kitchen and market; season, October to February. Tree very thrifty, healthy, upright grower when young, making a handsome, symmetrical tree, very productive when about twelve years old, and then becomes spreading and bending to the ground with its weight of handsome yellow fruit.

The above is a good average specimen, except they are generally more oblate and compressed, dots irregular, indented, and sometimes crimson cheek, and often deeply cracked at the eye. This fruit is worthy of cultivation not only for its size and beauty, but it fills a place in the season when we have but little ripe fruit and very few good varieties to fill its place. The fine specimens raised by Mr. Willson prove that the tree succeeds well in Iowa, at least under his cultivation. It does remarkably well here. We have seen, at Mr. Mackamer's and other places, trees loaded to the ground with fruit, and some specimens raised by Mr. Van Winkle, of Pleasant Ridge, weighing fourteen ounces.—Dr. STAYMAN, in *Pomologist*.

**A SWEET QUINCE.**—T. B. Jenkins, Chambersburg, Pa, sends F. R. Elliott specimens of the quince, of which the flesh is almost sweet and nearly void of astringency. It is new to me, and for the purpose of the sauce of the quince alone, must be of value, and perhaps prove superior to the Japan or Sand pears for such use. But for the purpose of flavoring the apple, for which the quince is often used, I doubt its value as compared with the orange or apple-shaped variety. Mr. Jenkins writes that "the variety was raised from seed some forty years since, and has been bearing regularly ever since. The tree is a good grower and abundant bearer." Description: Fruit of medium size, oblate, somewhat ribbed; color much like the apple-shaped, but when the bloom is rubbed off it is not as bright. The stem is set in a broad, dull brown, rough, knob-like projection, while the calyx has large, long segments, set in a deep basin; the flesh is deep yellow, coarse grained, not very juicy, a little tough, and of a mild subacid character.—*Rural New Yorker*.

## NEW AND RARE PLANTS.

**ANEMONE JAPONICA.**—When passing Kendall's nursery, Queen Elizabeth's Walk, Stoke Newington, a few days since, I observed this noble autumnal flower to be quite a wonder in its way. There stands near the entrance gate a specimen which must be full a yard high and a yard through, and there cannot be fewer than a hundred flowers fully expanded, with perhaps as many more in bud to keep up a succession. The flowers are of a paler tint than the common variety, a sort of very pale pinky rose, most fresh and charming. I make note of this in order to arrest the attention of cultivators of hardy plants, not for the purpose of advertising Kendall's nursery, which is not, so far as I know, managed with any other view than to supply the markets, and is therefore (probably) beyond being benefited by publicity. The autumnal anemones are all blooming earlier than usual, and as I have at least half a dozen varieties, I will venture to say of them that they are the handsomest autumnal hardy plants we have. Mr. Kendall's plant is the largest I have seen, and no doubt has been left undisturbed many years past, that being the way to secure the full development of such a handsome specimen.—**PASSER-BY**, in *Gardener's Weekly*.

**LEPTOSIPHON ROSEUS.**—“If an exception be made in favor of the admirable *Phlox Drummondii*, none of the annual *Phlox*wort are more popular, or so well deserve popularity, as the plants included in the genus *Leptosiphon*. Of dwarf and compact habit, yielding profusely their star-like blossoms of various shades, and of the easiest cultivation in almost any soil, it can scarcely be a matter of surprise that they have from their earliest introduction taken place in the first rank. For twenty years the genus was represented in our gardens only by the well known *L. androsaceus* and *L. densiflorus*, with their white varieties. To these were at length added the charming *L. luteus* and its variety *aureus*, both introduced by Messrs. Veitch, of Chelsea; and another, though it may be hoped not a final addition, may now be chronicled in the *Leptosiphon roseus*, a most charming plant, closely related in habit to the two last named, which it equals, if not exceeds, in beauty and in usefulness.

This elegant and attractive little annual dif-

fers from *L. aureus* almost solely in its color which is a most pleasing tender rose, a shade by no means easy to represent adequately on paper. Like that of its congener, its habit is very dwarf, rarely exceeding 3 or 4 inches, with similarly palmate foliage, the flowers being produced in clusters terminating the stems and branches. The elongated corolla tube, so characteristic of the genus, is fully three times longer than the limb, which is about three-fourths of an inch in diameter. In most of the specimens the rose-color is uniform, but in some there is an approach to a stripe or flake, which, however, in no degree detracts from the appearance of the plant. Well-grown, strong plants will yield their flowers for several weeks in succession. To obtain specimens, however, that will give the maximum number of flowers, it is essential with this, as with the other species, indeed with all other annuals, to sow thinly, or to transplant the seedlings while young to such a distance from each other as will afford full space for development. When the same care and attention that are bestowed on bedding plants are given to the hardy annuals, then, and then only, will their capabilities be discerned.”—*Florist and Pomologist*.

**CORONILLA GLAUCA.**—The flowering of the nerine reminds me of one of its companions in misfortune. This is an old plant of *Coronilla glauca* with a head about as large as an ordinary umbrella. It is in a 32-size pot. In that same pot it has stood for fully seven years without the aid of a particle of fresh soil. When I say it has “stood,” you perceive that I overshoot the mark, for it cannot stand; it has to be held up, being outrageously top-heavy for the size of the pot. How it lives I know not, for it belongs to the company referred to above, a neglected lot that are simply not dead because they won't die, and we cannot spare time to kill them. But why make a note of this? Just for this reason, that the plant not only lives, but thrives and flowers twice a year profusely. Last winter a lot of these unfortunates were packed close together on the floor of a cold lean to, and there the *Coronilla* made himself at home by rooting through and forming a perfect mat of fibres under the pot, and he bloomed so magnificently, that when I went to that house on a

destroying expedition (which was disguised under the designation of "a clear out"), it was simply impossible to wring his neck, he was so beautiful. Since writing thus far I have been out to have a look at him. He stands near a north wall, propped up by a few empty pots to prevent the wind blowing him over, and looks as nearly dead as can be, having, as I guess, had no water for at least a week. Not a word have I said about it, but I would wager "Lombard Street to a chancy orange" (as O'Connell used to do) that in the next spring he will be found stuck in a corner of one of the houses, rooting through as before to suck moisture from a damp tile, with his head gloriously bedight with healthy leafage and brilliant flowers.—*Gardener's Weekly*.

CRATÆGUS CRUS-GALLI (COCKSPUR THORN).—The family of the *Cratægus* embraces amongst its members some of the most ornamental as well as useful of our flowering trees and shrubs, from the beautiful and more choice scarlet, pink and white flowered varieties of the gardens down to the common, but scarcely less beautiful sweet May of our English hedgerows. It is, however, to the particular variety named at the head of this note that I now wish to draw especial attention. It is, in my opinion, one of the most beautiful of the whole family, forming, as it does, so conspicuous and striking an object in

autumn scenery, owing to the bright tints of its leafage at that season of the year. Probably, most readers of the Magazine are acquainted with the rich colors of the foliage of the Virginia Creeper as it is dying off in the autumn. Well, let those, then, who have not seen or not noticed a plant of *C. crus-galli* at this season of the year picture to themselves a tree some 20 feet or more high, clothed with foliage of the same hue and tints as that worn by the leaves of the Virginia Creeper, and they will then be able to form a fair idea of its beauty, as regards its foliage. The claims of this plant, however, for autumn effect do not end with its foliage; it also bears abundantly large clusters of bright red berries, which are retained on the tree (birds permitting) far into the winter, thus prolonging its season of beauty for some time after its foliage is shed. Some large trees here are at this moment (Sept. 27) is really magnificent, and have been so for nearly a fortnight past. To any one about forming new shrubberies, or who may not possess in their present collections any specimens of the Cockspear Thorn, I would strongly recommend the planting of a few specimens in conspicuous positions, amongst plants having dark sombre-colored foliage, and the effect will be grand. I ought, perhaps, to add that where the plants are young the foliage is not so richly colored as it is upon old and well-established specimens.—J. H. MASON, in *Gardener's Weekly*.

## DOMESTIC INTELLIGENCE.

THE ORGANO CACTUS.—The "cactus fence" is an institution peculiar to Mexico. The variety of the plant used for this purpose is called the Organo. It is eight sided, and shoots up straight as an arrow from ten to twenty-five feet in height and five to eight inches in thickness. The fence builders cut the cactus in sections of the right length, stick the cut end into a trench, cover the earth around it to the depth of a foot, and the fence is made. The pieces are set as closely together as possible, and, as they take root and grow for centuries, the fence improves with age instead of going to decay like other fences.—*Daily Paper*.

THE CODLIN MOTH.—The larvæ of the Codlin moth, such as leave the fruit late enough in the season not to transform—that is, become winged—remain over winter in the pupa state, and about the time the trees bloom in the spring they change to winged moths, and a few days afterward the females are ready to begin to lay their eggs. These are deposited low down in the calyx of the young apples or pears, and are hatched by a few days of warm weather. The young worm, as it emerges from the egg, immediately begins to eat its way into the centre of the fruit, which it soon reaches and remains, consuming the interior until it has perfected

itself as a larvæ, when it bores its way out. It then crawls down the branches, or lowers itself to the ground by a web from the mouth, and after crawling about for some time, it goes under cover of some loose substance, where in a few days it surrounds itself with a pupa case, in which it remains until it takes on the winged form.—DR. HULL, in *Prairie Farmer*.

COLOR IN AUTUMNAL FOLIAGE.—Mr. I. Warton, in the *American Journal of Science*, observes: If chlorophyl, the green coloring matter of leaves, should be like many other greens, a compound color, it must have for one of its elements a vegetable blue, capable of being reddened by acids. If the juices of leaves kept in a neutral condition by vital force, or by alkaline matter brought in the sap from the earth, should, when the circulation ceases, become acidified by the atmospheric oxygen, those juices would then be capable of reddening the vegetable blue of the chlorophyl. If, however, the vegetable blue should be thus reddened, it ought to become blue again when exposed to an alkali; or in other words if green leaves should be reddened in the autumn in the manner here suggested, by the action of the oxydizing atmosphere, they ought to return from red to green, if immersed in an alkaline atmosphere. He exposed under a glass receiver, in the light, with a capsule containing ammonia, a variety of autumnal red leaves, and had the gratification to perceive that in most cases the green color was restored, the restored green color remaining from some minutes to hours.

Frost probably plays no other part in causing the autumnal tints, than merely to arrest the circulation by killing the leaves. When a sharp frost occurs early in the fall, while the pulp of the leaves is still full and plump, the red colors come out brilliantly, because there is plenty of the blue substance to be acted upon by the juices then also abundant. When, on the other hand, the leaves die slowly, and are at the same time slowly dried in a late and dry autumn, the pulp becomes so meagre and the cuticle of the leaf so dry and hard, that an abundant production of fine red tints is impossible, and brown, the color of decay, predominates.

THE ROSE—*Some of the Legends Connected Therewith.*—The Catholic "rosary," which the Germans call Rosenkranz, or rose-wreath, suggests that originally the worshippers may have

counted their prayers with roses; at any rate, it seemed certain that for a long time the larger beads were called roses. But this was the case in Germany before the introduction of Christianity. The rose was held to be the favorite flower of the maternal goddess Holda, who, as we have before seen, was often called "Frau Rose," or "Mutter Rose." It was partly transferred, with all other symbols of Holda, to the Madonna, who is frequently called "Marienroschen." Mary, it is said, dries her veil on a rose bush, which thenceforth bears no more roses. But there has been a tendency to associate the white rose particularly with the Virgin Mary, that being chiefly chosen for her fete days, while the warmer and more earthly feelings associated with "Frau Rose" are still represented in the superstitions connected with the red rose. If a white rose blooms in autumn, it denotes an early death; if a red, an early marriage. The red rose, it is held, will not bloom over a grave. In Pozen the rose-apple is carried by the country maiden in her breast to keep her lover true. In Thuringia she who has several lovers may name rose leaves after them and scatter them on water; the leaf that sinks last is that of her truest lover, or predestined husband. Some of the superstitions concerning the rose in Germany are singular; as for instance, the custom found in some places of throwing rose leaves on a coal fire for good luck, and the saying that a rose bush pruned on St. John's Day will bloom again in the autumn. The relation of the flower to blood is widely believed. Thus one may find in France and Italy, as well as Germany, the saying that a drop of one's blood buried under a rose bush will bring rosy cheeks. The rose is also associated with an ancient charm once universal in Germany, still frequent in Swabia and Westphalia, against nose-bleeding, and indeed all kinds of hemorrhages. This formula in Westphalia runs thus: "Abek, Wabek, Fabek: in Christ's garden stand three roses—one for the good God, the other for God's blood, the third for the angel Gabriel: blood, I pray you, cease to flow." In Swabia it is said: "On our Lord Jesus' grave sprang three roses—the first is Hope, the second Patience, the third God's Will: blood, I pray you be still." Sometimes again it is "In God's garden bloom three roses—Blood-drop, Blood-stop and Blood-still," etc. These runes have curious modifications. In St. Louis, Missouri, a German named Stretger last year committed

murder, and afterward suicide. In his room was found the following charm against hemorrhage: "At the grave of Christ bloom three flowers—the first is Jugend, the second is Tugend, the third is Gubel (Uebel); repeat three times and the blood will cease to flow." I have somewhere met with a legend that the thorn-crown of Christ was made from the rose briar, and that the drops of blood that started under it and fell to the ground blossomed to roses. The fable has been recalled to me, though I cannot trace it, by the felicitous lines of the most gifted American poetess (Mrs. Howe):

"Men saw the thorns on Jesus' brow,  
But angels saw the roses."

A similar idea pervades the story of "Dornroschen," known to English readers as "The Sleeping Beauty," or "Rose Bud," who, it will be remembered, sleeps in a palace surrounded

by formidable thorn thickets, in which all who approached perished, save the true prince, to whom the thorns were all roses, through which he passed with ease. There is, by the way, in the same legend, as it originally appears in the Edda of Siemund, a curious remembrance of the original symbolism which connected the rose with silence and sleep. When Sigurd there enters the castle and arouses Brynhilda she tells the story of her trance in these words: "Two kings contended; one high Hialmgunner, and he was old but of mickle might, and Odin had promised him the victory. I felled him in fight, but Odin struck my head with the sleepy thorn, and said I never should again be victorious, and should be hereafter wedded.—From the "Sacred Flora," by M. D. CONWAY, in *Harper's Magazine for December*.

## FOREIGN INTELLIGENCE.

**FRUITING OF THE BLUE LABURNUM.**—What is the Blue Laburnum? you will ask. Well I venture this as a popular name for that glorious old climber or twiner, *Wistaria* or *Glycine sinensis*. The flowers are not blue, and the tree is not a laburnum; nevertheless we want popular names for popular plants, and "blue laburnum" is, to my thinking, not, altogether *outré*. To see fruit on this tree is a rare event, and its occurrence should therefore be chronicled. The past season appears to have wrought up to the utmost pitch of possibility the fruiting powers of all kinds of trees, and at Mr. Noble's Nursery, Bagshot, a *Wistaria* produced and matured two good pods of seed. It happened, too, that the fruiting plant was a seedling raised from seeds brought home by Fortune, which gives to the occurrence additional interest.—S. II., in *Gardener's Weekly*.

**INSECTS.**—It requires a philosophical mind at a time like the present to contemplate the havoc which insects make among our choicest wall-fruits. Though, fortunately, all gardeners are not tormented with hosts of hornets, as we are here in Herts, I doubt not they have enough to do to contend with the many other pests. The question is asked over and over again, "What is to be done to save my peaches and necta-

lines?" Many advise covering with hexagon netting. I think it is patent to all who have tried this, that any protection which is capable of keeping away wasps, blue flies and earwigs, so impedes the circulation of air and light as to cause the fruit to be flavorless. The last plan I have adopted is to hang some old and almost worn out fish netting in front of each tree, fastened securely at a short distance from the foliage, and to paint the meshes carefully over two or three times a week with gas tar. The odor given off by this exceeds that of the ripening fruit, and consequently neutralizes the fragrance emitted from the fruits, and which entices the enemy. Should any wasp approach, the chances are that when entering between the meshes of the nets it will come in contact with the tar, which, from its caustic properties, will give the insect a hint that it is not likely to want again.—*Gardener's Chronicle*.

**AMERICAN POTATOES IN ENGLAND.**—All Bresee's potatoes have been fairly tried with us once more, and now forever and forever have we done with them. The crops raised in our newly-broken pasture land are, in respect to size and numbers, the grandest we have ever seen; for, as good luck would have it, we planted early and in a perfect seed-bed, and they made a free

growth before the drought could tell upon them. If I were to keep any one of them, it would be *Climax*, a large, round, handsome root, as perfect in form as a cricket-ball, and when served on the table white as snow. It is, perhaps, the whitest potato in cultivation. *Early Rose* is handsome and immensely productive; *Prolific* is prolific. In every case the haulm grows like a tree, a few frosty nights in May scarcely injure it; and those who want potatoes may pretty well make sure of obtaining them by planting any of this peculiar strain. We shall discard them henceforth because they are not eatable. If well cooked, they are waxy, and would that they were tasteless; but in truth they exhibit (as a medical critic would say) a mild flavor of earthiness that no one who has been accustomed to eat good potatoes could endure. If badly cooked (as potatoes too often are,) they are wet pasty things, emitting a sickly odor, offensive alike to sight, smell, and taste. It may be that in America these potatoes are better in quality than with us, and it may be, too, that the Americans are not fastidious on the subject of good potatoes, and value quantity above quality. On that matter I can say nothing, for the good reason that I know nothing. But judging these potatoes fairly as candidates for garden culture in Great Britain, I must record my opinion that they are worthless, save and except that they are immensely productive and handsome, and adapted very well for pig and poultry food.—SHIRLEY HIBBERD.

LARGE WISTARIA SINENSIS.—I quite agree with Mr. Thorpe when he says that a few notes on the *Wistaria sinensis* will be interesting, and accordingly send the measurement of a *standard* specimen now growing in my nursery at Kirkdale, Upper Sydenham. It has been in its present position twenty-three years, and was formerly trained over an outhouse. The measurement is as follows: Height of stem, 5 feet 3 inches; height through head, 4 feet; total height 9 feet 3 inches; girth of stem at base, 2 feet 3 inches; diameter of head, which is the shape of an open umbrella, 15 feet. The number of racemes, 5,000. The first flowers expanded this year about the 10th of May, which is rather later than others in the neighborhood, it being on the north side of the house. The magnificence of its appearance when in full flower can be more easily imagined than described.—GEORGE SELBY, in *Gardener's Magazine*.

DIMORPHISM IN GLADIOLUS.—Is it generally known that there are two distinct forms of flower in *Gladiolus gandavensis*? In the one, all the parts are, as it were, upside-down, the stamens, of course, are attached to the outer petals; in one they are .'.—in the other .'. The lower "labellum" is outside in the one case and inside in the other, but that this structure is not a mere turning-upside down of the parts, is proved by these lower segments being ornamentally marked, while the top segments never are. As a rule, one form of flower belongs to one set of spikes, and the other form to another set; the two forms are very seldom seen in company on one spike, although at times there appears to be both forms, because the flowers are often a little pushed aside. The ovary and stigmas are also reversed from the beginning. It gives the spikes quite a different aspect from each other when once noticed, but the characters should be sought for in good, well-grown specimens—not ill-grown ones.—W. G. SMITH, *Gardener's Chronicle*.

SCARLET LABURNUMS.—Having noticed an observation by the editor, at page 270, No. 12, of *The Record*, relating to the flowering of purple *Cytisus* and yellow *Laburnum* on the one plant, I am induced to give you the result of some observations made by me in relation thereto. About seven or eight years ago, I observed an old scarlet laburnum commence to produce purple *Cytisus* blossoms, at the same time that it was bearing scarlet blossoms. The following season the plant bore scarlet and yellow laburnum blossoms, and at the same time purple *Cytisus* blossoms, and continued to do so until the plant was headed down a few years later. The reason for this last operation I intend to explain further on, together with some curious results—at least to me—which followed. Now, in this particular instance, can any one say whether this "sporting" was the result of the influence of the stock or the scion, or was it the tendency which many plants exhibit of returning to the parentage from which they have sprung? that is, if it be true, as I have read, that the scarlet laburnum was the production of the union of the yellow laburnum and purple *Cytisus*.

As I have stated above, it became necessary to head down the scarlet laburnum, owing to the crowding in of two plants on each side of it, which it was determined should stand; and be-



ing anxious to preserve it, I grafted a few yellow laburnums with it. Two of these latter were old plants, one having four arms or boughs. On one of each I put a scion of scarlet laburnum, and the result is, that this year and last, three grafts were scarlet, the other one yellow; but the blossoms of this last were of such unusual proportions that I have been reluctant to remove it. It was about three times the length of the common yellow, and remained longer in bloom. But what was to me the strangest portion of the grafting operation was that which took place on a young and very robust stock of common yellow, and grafted on at the same time as the old ones were done. Last year this graft showed scarlet blossoms; this year it was covered with yellow blossoms, and possessing the fine length of flower mentioned above. Now, if any of your readers have any knowledge of a like occurrence, I shall feel much obliged and interested by their giving me the benefit of it. Before I close this paper, I may remark that the old headed-down laburnum has produced this year the foliage of the purple cytisus and scarlet laburnum.—W. D., in *Gardener's Record*.

**BEST POT PLANTS FOR SUMMER EXHIBITION.**—The following from the report of the Royal Horticultural Society, July exhibition, indicates the most popular plants for exhibition purposes:

“*Stove and Greenhouse Plants.*—Mrs. Cole & Sons also send the best collection of nine stove and greenhouse plants in flower. This consists of excellent specimens of *Ixora coccinea*, *Dipladenia amabilis* in fine bloom, *Aphelexis macrantha purpurea*, *Kalosanthes punicea*, *Dipladenia crassinoda*, *Gompholobium polymorphum splendens*, and fair examples of *Ixora javanica*, *Allamanda grandiflora*, *Dipladenia crassinoda*, and *Phenocoma prolifera Barnesii*. The second prize goes to Mr. F. Perkins, Leamington, who has fine plants of the large-flowered *Allamanda Hendersoni*, *Statice imbricata*, *Vinca rosea*, and others of less note. Messrs. Bell & Thorpe also show in this class, and have a very good plant of *Dipladenia amabilis*, the yellow-flowered *Cassia corymbosa*, and well-bloomed *Statice*. The special prize offered by F. J. Morrell, Esq., for the best specimen stove plant in flower is taken by Mr. Baines, gardener to H. Micholls, Esq., with a specimen of *Allamanda cathartica*, forming a balloon 5 feet by at least 4½ feet across; and the second prize, given by the same gentle-

man, goes to Messrs. Standish & Co., of the Royal Nurseries, Ascot, for *Allamanda Hendersoni*, not large, but in excellent bloom; while the third prize is awarded to the singular-looking *Aristolochia ornithocephala*, from Mr. F. Perkins, nurseryman, Leamington. Messrs. Gill's prizes for the best and second best specimen greenhouse plants go to Mr. Baines, for a very fine plant of *Erica Fairreana*, four feet in diameter; and the second to Mr. A. Wright, gardener to C. H. Crompton Roberts, Esq., Regent's Park, London, for a very good specimen, though rather past its best, of *Kalosanthes Madame Celeste Winans*. In the local class for six stove or greenhouse plants, Mr. G. Harris, who is first, has a very well-grown *Clerodendron Thomsonae*, but its bloom over, a very good *Rondeletia* is also exhibited, and *Aselepias currasavica*, a showy plant, but seldom seen, and in this instance straggling; the others do not require notice. The second prize goes to Mr. J. Walker, for a good pot of *Lilium eximium*, *Caladiums*, and *Coleuses*. The “*Florist and Pomologist*” prize for soft-wooded greenhouse plants was awarded to Messrs. Bell & Thorpe, Stratford-on-Avon, for a collection in which there is *Abutilon Thompsoni* with a few flowers, two *Petunias*, a *Lantana*, *Diplacus grandiflora* in good bloom, and *Lilium auratum*.

**THE SWALLOW'S FLIGHT, THIRTEEN HUNDRED MILES IN TWENTY HOURS.**—On the passage from China, on board Her Majesty's ship *Donegal*, upon the 27th of August last, when in 9 deg. north latitude and 19 deg. west longitude, about 250 miles off Sierra Leone, I observed a flight of six swallows, flying about and resting on the ship. As there had been no strong winds to blow them off the land, concluded they were en route from Africa to America, or *vice versa*. On the 28th I caught one; he was in good condition, and voided a quantity of white natural colored feces, so apparently was not long from land; therefore I inferred that the party were crossing from Africa, that being the nearest coast, and I was confirmed in this opinion from my captive showing no signs of fatigue, such as swallows exhibit after a severe flight. I found the adventurous *voyageur* to be our mutual friend *Hirundo rustica*, whose family is so familiar to English homes.

They continued following and roosting upon the ship for several days and nights, during which time I watched them very narrowly, as I was

very curious to ascertain upon what they fed, there being no flies about the ship. They spent their time in "hawking" over the waves, pretty much the same as they would on shore, but I never saw them touch the surface. On the 3rd of August curiosity got the better of humanity, and I killed one and held a *post mortem* on him. Very different indeed was he from the first one; he smelt like a sea bird, his tail was draggled and covered with greenish yellow feces, his feathers were becoming rough, and he felt clammy and sticky, and a miasma of guano pervaded him.

Upon the 4th of August the remainder of the flight had disappeared, having traversed a distance of 1,022 knots. When they left we were going 10 knots on a strong "north-east trade," and I have no doubt they reached America in 20 hours, as a trip of 1,300 miles is a mere bagatelle to birds able to fly 50 knots an hour easily, with a strong wind behind them. Possibly instinct warned them to stay by the "floating island" until it blew strong enough to waft them across the Atlantic.

I see no reason why at sea they should not be supposed to eat the Queen Fly and Crustacea, which must form the food of the petrel, a bird similar in shape and form and flight to the swallow. Many affirm that they cannot take flies on the water; but as not only myself but others have seen them do it frequently on ponds, that does not hold good, as surely they can do the same on the sea. I certainly did not see them do so in the neighborhood of the ship, but what they did beyond that I cannot say. Messrs. Buckland and Lee, of *Land and Water*, to whom I have forwarded "the intestinal canal," I sincerely trust may throw some light on the subject.

Virgil says:—

"Ant arguta lacus circumvolitavit hirundo"—

"The twittering swallow skims the dimpled lake;" but the brave and dashing way in which these tiny birds navigate the air and make long and rapid passages across the "wide, wide ocean" is worthy of the admiration of a nation of sailors. Apologizing for intruding on your valuable space what may, after all, prove idle conjecture.—CADWALLADER WADDY, in the *Times*.

HOW TO COOK VEGETABLES.—There is one important objection which has often been made, through ignorance of the first rule in cooking vegetables. It is observed that a meal from them is not satisfying. I have found it frequent-

ly happen that the persons who thus objected did not know even how to boil a vegetable. The rule is simple, but must never be forgotten. Every kind of vegetable intended to be served whole should, when put to boil, be placed at once in boiling water; and this applies especially to potatoes and vegetables from which the outer cover has been removed. Now, it often happens that potatoes, &c., are, to save time, placed in cold water and left to boil gradually. It is just this which allows the nutritious matter to escape, and renders the meal unsatisfying. When, on the contrary, the water boils from the moment the vegetable is immersed in it, the albumen is partially coagulated near the surface, and serves to retain the virtue of the vegetable. The reverse is, of course the rule for making soup, or any dish from which the water will not be drained. By placing the vegetables in cold water the albumen is slowly dissolved, and actually mixes with the water—a process most necessary for the production of nutritious soup. It is to be hoped that the poor, who have a special need for the most their money can produce, will learn, in whatever haste they may be, not to boil all the albumen from their potatoes, reserving for their need only the starchy matter. *Food Journal.*

GARDENING NOTES.—If you find people, uninvited, planting their foot in your garden, run the roller lightly over their potatoes—likewise their corn. You will be sure to find them groan; so the process promotes vegetation. We haven't tried the following, but commend the notion to our readers' attention. By boiling your peas before planting them you ought to ensure their produce being ready boiled. Boil a few and plant them. If they don't come up at once, you can soon get them up. With a spade. This is the cheapest mode of forcing. The ordinary marrow may be grown without glass. Spinal marrow requires a frame—in fact, a human frame. It will not do much without it, indeed. Don't mix your mustard before planting. Once mixed it will go to (mustard) pot. Water-cress must of course be cultivated in water. Popping cress will be found to flourish best in fields where cricket is cultivated. Don't grow onions for sale, if you do not wish to be compelled to hawk them about. The influence of these plants is so great that we have seen people who wished to sell them forced to cry in the streets all day.—*Fun.*

# The Gardener's Monthly.

DEVOTED TO

*Horticulture, Arboriculture, Botany and Rural Affairs.*

EDITED BY THOMAS MEEHAN.

*Old Series, Vol. XIII.*

*MARCH, 1871.*

*New Series, Vol. IV. No. 3.*

## HINTS FOR MARCH.

### FLOWER GARDEN AND PLEASURE GROUND.

It is often said by those who have plants to set out, that they give so much more satisfaction than sowing seed. We hardly think so; and then see the thousands who can have some flowers from seeds, who could have no plants in other ways. In going among amateur horticulturists, we scarcely find a place where we are not shown some choice flowers which we are told, with a pardonable air of triumph, was bought of Henderson, or Dreer, or Thorburn, or Bliss, or Vick, or some other of the well-known names familiar to the readers of our advertising columns. During this month of March, and the next April, millions of little packages will have traveled through the mail, and find their resting place on the bosom of mother earth; and here we find we are giving a hint unconsciously, but one which is a capital one to the seed sower, namely, to sow the flower seeds on the surface, and *not beneath* it. Much of the ill luck with them comes from rotting in the ground. A rain comes after sowing, and if the seed has partly swelled, it easily rots by being a few hours under water. To avoid this, sow on the surface, and close the earth over with a trowel. It is even a benefit to make a little mound of a half-inch or so, before sowing. Then it will make no difference if the rain continue for a week, the seeds will always be *above the level*, and never get saturated. Another little thing, often neglected by seed sowers, is to mark the place where the seeds are sown. A little stick set in will always be found useful, as all who have not done so will readily understand. In olden times this was

always attended to, and a little slit made in it, in which the name on the paper was neatly folded and set. Of course a neat label looks prettier, but somehow those people of the olden time, who followed these primitive ways of naming their plants, knew more about them than many of the moderns. Only the hardy Annuals must be sown in March; those which are tender must be reserved until the soil and weather is settled warm. We need not give a list of these, as every seedsman has now these particulars on every package he sends out.

If flowers have been growing in the ground for many years, new soil does wonders. Rich manure makes plants grow, but they do not always flower well with vigorous growth. If new soil cannot be had, a wheelbarrow of manure to about every fifty square feet will be enough. If the garden earth looks grey or yellow, rotten leaves—quite rotten leaves—will improve it. If heavy, add sand. If very sandy, add salt—about half a pint to fifty square feet. If very black or rich from previous year's manurings, use a little lime, about a pint slacked to fifty square feet.

Prune shrubs, roses and vines. Those which flower from young wood, cut in severely to make new growth vigorous. Tea, China, Bourbon and Noisette roses are of this class. What are called annual flowering Roses, as Prairie Queen and so on, requires lots of last year's wood to make a good show of flowers. Hence, with these, thin out weak wood, and leave all the stronger.

To make handsome, shapely specimens of shrubs, cut them now into the forms you want, and keep them so by pulling out all shoots that

grow stronger than the others during the summer season.

Do not transplant extensively till the ground is warm and the buds are about to push. Many things die by exposure to winds for a few weeks before they have warmth to push roots and leaves into growth.

The rule for pruning at transplanting is to cut in proportion to apparent injury to roots. If not much the worse for removal, cut but little of the top away. Properly pruned, a good gardener will not have the worst case of a badly dug tree to die under his hands. In a nursery, where these matters are well understood, trees "never die."

Box edgings lay well now. Make the ground firm and level, plant deep, with tops not more than two inches above ground.

Roll the grass well before the softness of a thaw goes away. It makes all smooth and level.

Graft trees or shrubs where changed sorts are desirable. Any lady can graft. Cleft grafting is the easiest. Split the stock, cut the scion like a wedge, insert it in the split, so that the bark of the stock and scion meets; tie a little bast lark around it, and cover with Trowbridge's Grafting-wax, and all is done: very simple when it is understood, and not hard to understand.

Chrysanthemums are now indispensable for autumn decoration of the flower garden. Now is the time to procure a supply. They do well in any rich garden soil that is not too dry. The Lilliputian, or Pompone class are still popular for conservatory or pot culture, but the large flowering kinds still remain the gems of the open ground.

Hyacinths, Tulips, Lilliums, and other hardy bulbs set out in the fall, and covered through the winter, should be occasionally examined, and when they show signs of active growth, must be uncovered, in this latitude this is not safe until towards the end of the month.

Most things have been pruned, but Roses are always left to "see what damage the winter may do." In the "summer" roses, or those which bloom only once in the season, the rule is to thin out the weak shoots and leave the stronger ones, merely shortening their tops. If pruned severely in the usual shortening style, they will not bloom freely. The hybrid perpetual roses, if wanted for early flowering, should also be served much in the same way; but as their chief value is as fall flowerers, a severe pruning now produces a vigorous autumn growth, bearing large

and luxurious blooms. The Tea, China, Bourbon and Noisette roses which flower best on young wood, should be well cut in.

#### FRUIT GARDEN.

It will often be found that Pear trees blossom freely without producing fruit. At one time, it was thought this failure resulted from late spring frosts. It is now known to result from weakness, a "general debility," a disease of which our best pomologists of the last generation never heard. The best temporary remedy for this is a vigorous pruning. Trees which have this bad habit, should have many of their weaker branches thinned out, leaving the stronger ones, many of which will then bear. But a permanent remedy must be sought in encouraging the surface roots to feed. This is done by heavy top dressings, and not injuring, more than can be helped, the surface roots during the growing season. There are differences of opinion as to whether the soil about fruit trees should be kept stirred, or left entirely under grass or mulch; but there is no difference about the value of not destroying the roots during the growing season.

If Pear or Apple trees are infested with white scales, cut away all the weaker shoots, and wash the bark with a composition of lime and sulphur. Sometimes Pears are affected with a disease, known in nurseries as frozen sap blight. In this case, just as the leaves are pushing, the branches will have spots of siimy black, and the leaves often have this appearance also. The only remedy is to cut back below any of these appearances.

Grape vines in the open air, on arbors and trellises, should have their pruning finished before warm spring days set in, or they will bleed. It does not injure them much, but it looks bad. The pruning must be regulated by the condition of the vine. If the vines are young and the shoots weak, cut them all back, to make a new and vigorous growth. If already a fair quantity of strong shoots of last season's growth exists, cut out the weaker ones, so as to leave enough of stronger ones. The cane system, slightly modified, is best for arbors and trellises in the hands of amateurs generally. This implies a new set of canes every year or two. If, as frequently happens from bad management, all the young and strong-bearing wood exists only at the end of the vines, and these latter have become nothing but long, ropy-looking apologies

for what a vine should be; the whole cane may be buried down in the soil to where the strong shoots spring from, and the young wood of last season trained up from this. The plant will then recover its good appearance quite as well as by cutting down, with the advantage of not sacrificing a year's crop of fruit. Grapes that have become weak from age may be renewed by layering down a branch some feet just under the surface, and then cut back, so that one good eye only be left at the surface of the soil.

Apple trees in orchards are often so thickly matted with branches, that none of the leaves get their full share of light and air. This should never have been permitted, but as it is, a vigorous thinning should be effected, though the axe and saw be called in to effect it. Sprouts will come out thick next summer, after such pruning, but they should be torn out while green.

Peaches, it is said, grow too strong generally, and should not be pruned; but the same rule holds good as with apples. Thin out all weak or crowded shoots. Our experience is that if a Peach tree's constitution is not impaired by bad treatment, it seldom grows too strong for its own good.

Plum and Cherry trees are often injured by the knot. These can often be renovated by a severe pruning. Cutting away all branches on which the swelling came the last season, a new growth will follow, which never has any knots on that season. The spores of the knot fungus, however, find their nests, and the next season grow, and then, if the trees are examined in May, the swelling will appear as soft frothy masses, which, if then taken out by the finger and thumb, usually destroys the crop at once and forever. Horticulture has made great progress the few past years in many of these things; and now, if Entomology shall prove its great value to gardening, by fixing the end of *curculio*, as mycology has, in its way, done us good, America will be the paradise of fruit growers.

In setting out Raspberries and Blackberries, remember the hints we once before gave, not to set out deeper than the plant grew before. A currant or gooseberry set deep, will root from the cane, but a raspberry will not. The new buds have to come up from the roots. Thousands of these plants die every year. In nurseries there are two kinds of plants—plants which are simply suckers, taken off in winter, and plants taken up as they sprout during summer, and set out to grow awhile before fall. These are called

transplanted plants, and are worth much more than others. Transplanted plants seldom die. Both Raspberries and Blackberries should be cut down within six inches or a foot before planting. Transplanted plants may be left longer, and be allowed to bear a little; but if these plants are allowed to produce much the first year after setting out, the suckers for next year are very weak. Little is gained by having fruit the first year.

Strawberries, like Raspberries, are often destroyed by planting deep. Only the fibrous roots should be set under the ground—never the bud. Sometimes the excuse is that the plant will not set firm in the ground without; in this case, make the ground firm by rolling or beating down before planting.

People often complain that their Currants drop their leaves early, in which case they don't mature a very large crop the next season. The Currant is a native of cool regions, and the coolest ground should always be devoted to it. The leaves do not fall early then. In this section the currant borer is the worst insect pest. About this season the larvæ will be found in the pith, and the shoots containing them should be cut off and burned. If the shoots look weak and starved, like on plants, which have some of them very strong and vigorous, it is quite likely they have the larvæ of these borers in the weak ones. This can then be determined by examination.

#### VEGETABLE GARDEN.

In the open ground Peas and Potatoes receive the first attention. Then Beets and Carrots. Then Lettuce, Radish, Spinach, Onions, Leeks and Parsley. Beyond this, unless in more favored latitudes than Pennsylvania, little can be done till the first week in April. There is nothing gained in working soil, until it has become warm and dry.

Those who have no Spinach sown in the fall should do that right away; no amount of stable manure but will be a benefit to it, though guano, in even smallish doses, will kill it. Guano produces excellent Cabbage, mixed with the ground while it is being dug for that crop. Cabbage, by the way, may be put in as soon as the ground is ready; and Potatoes are better in before the beginning of next month, if the ground is not too wet; many plant Cabbage between the Potato rows.

Onions are better put in early, but the ground ought to be dry, and trodden or beaten firm

when the sets are planted; the ground ought not to have rank manure—wood-ashes and pure undunged loam will alone produce an excellent crop.

Where new *Asparagus* beds are to be made, now is the time; the ground should be rather moist than dry, and be trenched two feet deep, mixing in with it a good quantity of stable dung, and, if the ground be inclining to sand, add some salt; the beds should be marked out four feet wide, and the alleys about two feet. If pegs are driven down at the corners of the beds permanently, they will assist operations in future years. Having marked the positions of the beds and procured a stock of two year old plants, place them on the soil nine inches apart in rows one foot asunder, making three rows in each bed; then cover the whole with soil from the alleys and rich compost a couple of inches.

To have Turnips good in spring they must be sown very early; they are hardy, and must be put in as soon as the ground can be caught right.

Parsley delights in a rich gravelly loam, and should be sown very early.

Parsnips, another crop which should receive early attention, also delights in a deep gravelly soil, but detests rank manure.

Lettuce and Radishes continue to sow at intervals.

Herbs of all kinds are best attended to at this season—a good collection is a good thing.

The Carrot will thrive in soil similar to the Beet; lime is an excellent manure for it—we use the long Orange. Celery may be sown about the end of the month, in a bed of very light rich soil, and Tomatoes, Egg Plants and Peppers sown in pots or boxes, and forwarded. It is as bad to be too early with these as too late, as they become stunted.

---

### GREENHOUSE.

This is the season when the most plants will require re-potting previous to their making their new season's growth. The difficulty always is to find the increased room the re-potting requires. Usually room is made by turning out the bedding plants into hot-bed frames, protecting them from frosts at night by mats. Much may be gained also by not increasing the size of pots, as pointed out by a correspondent; but merely changing the soil; where, however, plants are not shortened in previous to the repotting, care

must be exercised in shaking out the soil, or serious results may follow. The ball of roots should be soaked in water, so that the particles of soil may fall away easily from the roots. The soil for potting, too, should be nearly quite dry, and then rammed into the pots about the roots very hard and tight. Immediately after potting, the plant should be well watered, and placed in a close and partially shaded atmosphere till the roots take hold of the new soil again. Where the roots are not much disturbed these precautions are unnecessary. In addition to dry soil for potting it should be fibrous, that is, it should have a good portion of old fine roots through it to give it a spongy texture. It is this which gives the top soil of a pasture such value in the eye of a good gardener for potting purposes, as the innumerable fine roots of the grass through it renders it particularly spongy or "fibrous" as the technical term is.

Look out for a good stock of bedding plants in time; by striking cuttings of such things as grow rapidly and speedily, and sowing seeds of such annuals as may be advanced to advantage.

Fuchsias may now be readily struck from the young growth of the old plants, which will make excellent blooming plants for the next summer season.

Dahlias should now be brought forward. A good plan is to shorten the extremity of the roots, put them in six inch pots, and place in a warm greenhouse. In a few weeks they will sprout, when they should be shaken out, divided with a piece of root to each sprout, and separately potted in 4-inch pots.

Pansies are coming now into flower. They like an airy frame, where they will not be roasted at mid-day nor exposed to drying winds, and yet have a free circulation of air and plenty of light. Planted out in such a frame, and the old shoots cut away as soon as the plant has done flowering, the plants will keep healthy over till the next season. Superior varieties can be raised from seed. Choose those with the roundest petals, best colors, and the first flowers that open, to raise seed from.

Camellias will require rather more water while growing than at other times. Just before they grow is a good season to graft. Cut down the stock, cleft graft in the crown, wax, and plunge in a bottom heat of 70°. A great many kinds may be had on one plant by the bottle system: A shoot about to grow is obtained, and attached to the stock as in inarching, the end of the shoot

being put in a small phial of water suspended beneath it. This plan does best, however, with the young wood in July.

Geraniums, Pelargoniums, Cinerarias, and Chinese Primroses, must be kept as near the glass and light as possible; they do little good in shady places. Keep off the green Aphis—for this on a small scale there is nothing like hot water; on a large scale, tobacco-smoke, in several successive light doses, is still the best remedy.

Azaleas succeed well by grafting with the half-ripe shoots of the present season's growth on plants raised either by seeds or cuttings. Old wood does not take readily.

Auriculas, Carnations, Pinks, and Polyanthus—the prettiest of florist's flowers, must be kept cool, just free from frost, with plenty of air, if the best results are desired.

Chrysanthemums should now be raised from cuttings for fall flowering. They make better blooming plants than off-sets.

New-Holland and Cape plants, such as Epacris, Acacia, Heaths, etc., are now the glory of the greenhouse; hot bursts of sun on them should be avoided, as it lays in them the seeds of "consumption," which frequently carries them off the following summer.

## COMMUNICATIONS.

### PEARS.

*An Address delivered before the Pa. Fruit Growers' Society, at Chambersburg, January 19th, 1871.*

BY E. SATTERTHWAIT, OF MONTGOMERY COUNTY, PENNA.

At the request, or to speak more properly, by command, of our most worthy President, I have prepared some remarks on the subject of Pears and Pear culture, which are submitted, however, with great diffidence, because, as I must confess, I found the task more difficult than I had supposed it would be. I could very easily have written an article on this subject for the general public, that would have been satisfactory, at least to myself, if not to the public. But to produce an essay to be submitted to the criticism of a body of skilled and professional fruit growers, and which must be supposed to be either interesting or instructive to such a company, is a quite different matter. If I have not succeeded in doing this, the only excuse I have to offer is, that the task is not of my own seeking, and that I have done the best I could under the circumstances; having been able to snatch but very little time from the cares of business to devote to the purpose.

It would be very desirable, if it were possible, at these, our annual gatherings, to be able to present, each year, a statement setting forth the progress that has been made from year to year, and the exact state of each important branch of the science which it is our object to promote.

But from the nature of things, this is not possible.

Fruit growing, in common with every other branch of horticulture, does not belong to the exact sciences. We cannot in that, as we may, with many other branches of knowledge, proceed, step by step, to add to our stock of information, and by reasoning from ascertained facts, arrive at certain and infallible conclusions. Here, on the contrary, all is vague and uncertain. Not only are there no well settled principles established; but we find the greatest discrepancy existing amongst the most intelligent observers as to matters of every day observation. Accordingly I find, on taking a survey of the field, an immense mass of crude observations, and conflicting theories, a vast amount of which has the tendency only to confuse and discourage the honest inquirer after truth. To attempt to reconcile these conflicting theories,—to bring order out of chaos,—to sift the few grains of wheat from the many bushels of chaff,—would be a herculean task, which I shall not attempt; but shall confine myself to noting such facts and observations as have occurred to me, that seemed to be practically useful: and I shall endeavor to do this without being biased for or against any disputed theory; but with one single object in view,—to find out the truth.

Taking up the subject in the order in which it is commonly treated, I suppose I must say something in regard to soil and cultivation. On

this branch of the subject I shall be brief, as I have had occasion frequently before this society and elsewhere to express my views on this subject. In regard to the kind of soil and cultivation most suitable for Pears, I have only to say, that the results of my observation and experience are all favorable to "high culture." I mean by that, bountiful manuring, and constant tillage of the soil. In this, as in every other branch of productive industry, I know of no royal road to success. Hence I have no consolation to offer to those who expect to grow good crops of pears in a grass sod. But I do not propose to argue this question. It is one that has been already sufficiently discussed, and can be determined only by actual experiment. As it would seem to be proper, however, to give the results of my own experience, I would state, that I give my trees, as a general rule, a good manuring annually, with stable or barn-yard manure, and cultivate by plowing alternately, to and from the rows of trees with a light plow. My trees that have been so treated, have, thus far, generally produced satisfactory crops. It is proper for me to state, however, that I have but few trees that have been planted more than ten or twelve years, which is not long enough to establish any theory conclusively. And it may be, that older trees will not do with this kind of treatment. All that I can say at present about that is, that the older my trees get, the better they seem to flourish under it.

I would not be understood as contending, that Pears will never do well in a sod; on the contrary, I have seen many old and flourishing pear trees, bearing valuable crops of fruit too, that stood in grass, or in situations where they could not be cultivated. But these have always been in peculiarly favorable situations, often near the farm buildings, where the drainage from the barn-yard or kitchen found its way; sometimes in city yards, where the roots can seek out rich spots of ground under the pavements of gutters, and among sewers and foundation walls; and it must be borne in mind, that the roots of an old tree will run for hundreds of feet, where they find a congenial soil.

Pear trees in such situations will often thrive and bear good crops in spite of the grass; but I have yet to see the first Pear orchard in grass that was either thrifty or productive.

I am well aware that there are those who are considered high authority, who strenuously advocate the system of keeping a pear orchard al-

ways in grass; and when I consider what an easy and common thing it is to slide into the practice of allowing an orchard to become a sod by lack of cultivation, I confess I am not astonished at finding advocates for the practice; but if it was not for the fear of being thought personal, I should be tempted to say, that in many of these cases, "the wish was father to the thought."

However, as I have said, success alone must be the test in this question; and when those who practice on the grass theory, show the best crops of fruit, then I also will "go in" for grass. For of one thing I am positively certain, that the eternal laws of the Creator will not change, not even to suit the theories of the most wise and astute, and no matter how stubbornly they may be insisted on.

A word more in regard to manuring. The pear is unquestionably one of the most hardy, as it is the longest lived of all fruit trees; but it is unreasonable to expect that a tree, standing for generations in one spot, can continue to draw from the same soil, year after year, the ingredients requisite for a large crop of such high-flavored and delicious fruit as a fine variety of pear, unless the soil happen to be of inexhaustible fertility, or has its supply of plant food, in some way, frequently renewed.

It is easy to imagine a tree, (like the pine for instance) that produces no edible fruit, to thrive and continue to grow for centuries in a soil almost destitute of fertility, but the requirements of food-producing plants are different. They require a soil containing more or less of organic matter. Fruit trees I believe require to be fed as much as domestic animals. Everybody knows, for instance, that dairy cows to yield abundantly must be constantly supplied with a liberal amount of nutritious food; and I think this as necessary for pear trees.

I have been speaking now of soils of moderate natural fertility, such as the average soil of Pennsylvania or New Jersey: of course the same amount of manuring will not be necessary in deep alluvial or otherwise unusually fertile soils.

The question is frequently asked, whether a stiff clay soil, or a light sandy soil, is suitable for pears? I cannot answer these questions; but am inclined to the opinion, that almost any soil, that is not too wet, will do, if made sufficiently fertile by manuring.

I have seen it frequently recommended to seed



down an orchard with clover. Probably this might do well if nothing but clover would grow ; but, as every one knows, who has tried the experiment, clover will only live a year or two, and then if the soil is good enough to grow pears at all, a dense sod of other grasses will succeed it. I know of no way of keeping an orchard in clover, but to plow and re-sow at least every other year, and this practice, I apprehend, would be liable to all the objections which are urged against constant tillage. Mulching is also frequently recommended. But I have never known it tried to any extent ; and I suppose, simply for the reason that it is too expensive.

There is one advantage that I must claim for the system of culture which I practice, that has great weight with me, and must be an important consideration wherever ground is very valuable, and that is, that I get large and valuable crops of other products from my pear orchards ;—almost the same, in fact, as if there were no Pear trees there ;—the space in the rows between the trees being filled with currants, gooseberries, raspberries, rhubarb, etc., and the rest of the ground planted with other small fruits, vegetables, and nursery trees. And it is a remarkable fact, that pear trees do not seem to injure other crops growing near them, as apple, cherry and other fruit trees do. Some of my pear trees are now five or six inches in diameter and twenty-five feet high, and yet I cannot perceive that they injure anything growing near them. In fact, I am convinced, that the protection afforded by rows of pear trees, at intervals through the vegetable and nursery grounds, is a decided advantage to many things ; and as my trees get no manure and no labor in cultivation, except what is applied to the other crops, the pears would seem to be almost clear gain.

I find I have forgotten to say anything about the preparation of the soil before planting, and I confess that I do not attach as much importance to this as is generally done by writers on this subject. I have said enough, I think, to show that I consider a highly fertile and well cultivated soil essential ; and I certainly should not advise any one to think of planting a pear orchard in ground that was not in a good state of tillage, such as would be necessary for garden crops ; but I consider that much more depends on the after treatment, than on the original preparation of the soil. And as to deep subsoiling and trenching, I had never found any advan-

tage in it. Soils that are wet, of course must be drained.

I have already spoken of one prolific cause of failure, to wit : starvation ; and I will now proceed to notice such others as have occurred to me : Of diseases of the Pear, properly so called, I know nothing, having had no experience with any, unless the premature shedding of the leaves of trees otherwise apparently healthy, and the consequent failure of the fruit to ripen, be a disease. Whatever this may be, or whatever its cause, it is certainly the most serious drawback to pear growing that I have to contend with. The mischief from this cause varies with the season and with varieties amounting sometimes to a total failure of some varieties, and greater or less injury to most other. As nothing seems to be known of the cause of this malady, it will be very difficult to suggest a remedy ; and perhaps it is useless to speculate upon it ; but as it seems to be a difficulty of so serious a nature, anything that can throw any light upon it would seem to be interesting. And in connection with this, I will mention what has always appeared to me to be very remarkable, and well worthy of the most careful investigation. I allude to the fact, that Pears grown in cities appear to be entirely exempt from this, and every other malady that Pears growing in the country are subject to. There would seem to be some mysterious atmospheric influence in cities which is peculiarly favorable to the growth of pears ; not only rendering the trees exempt from disease, but causing the fruit of every variety to be free from blemish, and of a complexion so brilliant and perfect as to be recognized with difficulty as the same fruit, when compared with the same variety grown only a few miles distant in the country. This influence, whatever it may be, seems to be entirely atmospheric, as no difference in soil or culture, seems to produce the effect mentioned.

In the present state of our knowledge on the subject, the only remedy for this leaf-blight, seems to be, in the selection of such varieties, as appear to be least liable to it. And here I cannot refrain from making a suggestion in regard to a pear, which, from its remarkable vigor and exemption, under all circumstances, from leaf-blight, would seem to be well worth experimenting with. I allude to the Chinese sand pear. And I would like to enquire if any one has ever tried, either by hybridizing with other kinds, or otherwise to obtain from seedlings of this va-

riety and edible fruit, with the very desirable properties of this tree.

Another serious evil that I have encountered, is injury to the trees from severe cold. I have had whole rows of Bartletts, either killed outright or so injured as to require years to recover, from the effects of an unusually severe winter. There is, of course, no remedy for this; but I have reason to hope that as the trees advance in age their liability to injury from this cause will diminish.

In consequence of the injury from cold, I have found a northern exposure not desirable for pears, and for the same reason, I would recommend protection from winter winds in any way possible.

The Apple or Quince borer has become very destructive with me of late, and I have lost many fine pear trees by them; the mischief being mostly done, before I had made the discovery that the borer would attack the wood of the pear. In localities where this insect is troublesome, it will be necessary to take the same precaution with the pear, as with the apple and quince, to guard against its ravages. This, however, is so easily done that no further mischief ought to result from this cause, when once it becomes known that the borer will attack the pear.

The cracking of the fruit of some varieties, worse some seasons than others, is a very serious objection to those varieties subject to it. As no cause or remedy has ever been discovered for this, the only way to avoid it, seems to be, to discard the varieties subject to it. I might say here, however, that I have noticed that the fruit of trees that are unthrifty from any cause, appear to be most liable to crack, and this would seem to be another argument in favor of high-culture.

The pear seems to be less subject to the attacks of insects than other tree fruits, but curculio and other similar insects are sufficiently troublesome to make a remedy very desirable, if such were possible: and I will repeat here the opinion that I have often before urged, that the true remedy for this, and most other insect pests, is to be found in the protection, encouragement and domestication of insectivorous birds, and I earnestly advise attention to this subject. I intend myself experimenting with the European sparrow, and I hope others will also

I have every year many bushels of fine pears

spoiled by wasps, hornets and bees eating into them; but I feel satisfied from experiments that I have made, that these can be almost entirely destroyed, by catching them in wide-mouthed bottles, hung in the trees for the purpose, half filled with vinegar and water.

[To be Continued.]

## RUSTIC TREES.

BY CHRONICLER.

*Platanus occidentalis*, is the American Buttonwood tree. While young, and growing in forest or nursery rows, it forms a straight, regularly branched tree, but when set out singly upon good soil, it frequently throws out a few over-vigorous branches, nearly as large as the main stem above, and thereby becomes an object of deformity. If the ends of the rampant branches are nipped off every three feet of their growths, the main leader will shoot upwards more rapidly, and the other branches will be made to grow equally. The tree will then become a model of perfection—a colossal leafy column, a hundred feet high: an ornamental arboreal giant. The tree is of rapid growth upon various soils and situations, the leaves being pale green, and the bark nearly white; it contrasts beautifully with other trees of darker shades.

*Populus alba*, is called Abele tree, and white-leaved Poplar. It is of quick growth upon various soils and situations; both bark and foliage are pale green. It is seldom that we can get a tree with straight stem; it too, throws out a few rampant, horizontal branches, which it thrusts into the heads of other trees within its reach, and deforms both them and itself; but by nipping off the ends of over-strong branches, every two feet of their growth, the tree assumes a handsome form, and becomes highly ornamental. It throws up many suckers from its roots, which disfigure a fine lawn; they should be pulled up as they appear, for that reason they should be set far off from the roads.

*Paulownia imperialis*, is a rapid growing tree, with very large leaves, and blooms of bright blue in May, which are produced in great profusion, and very fragrant. When ten to twenty feet high, it branches out and makes no leading stem upwards, leaving the heart open and bare; but by nipping off the ends of branches every two feet of their growth, the tree will then send up a strong main leader, and by a continuance of the nipping process, the

tree will become very ornamental, and attain a great size. We can perceive its fragrance a hundred feet off on still evenings.

*Catalpa syringifolia*, takes the same habit as the Paulownia, when left to itself, and can be made handsome by the same practice. It is one of the most showy and profuse blooming trees in existence; grows thirty feet high, upon good soil, and having its branches checked frequently.

*Gleditschia horrida*, commonly called Thorny Acacia. When grown singly, it requires its over-luxuriant branches checked by nipping off their ends. When well trained, it forms one of our most ornamental trees; thrives upon various kinds of soil and in different situations. The leaflets are very small and transparent, clothing the wood admirably. It is well suited for making strong hedge fences; its many strong thorns makes it a sure barrier against trespassers and live stock. It is a blessing that it does not bear oranges, as it would be hard to get at them for the dreadful thorns.

We have chosen these few rugged trees, for our subject this time, to show unskilled improvers how beauty can be evolved from the most awkward looking trees.

## BOTANY AND ITS INFLUENCE ON HORTICULTURE.

BY THOMAS MEEHAN.

*Read before the Wisconsin State Horticultural Society.*

I have received an invitation from your esteemed Secretary to be with you, or at least to prepare an essay for your winter meeting. Nothing would delight me more than to be able to accept, but I am nearly borne down by the weight of work. The alternative I will try at least briefly to do. I am frequently forced to decline even such requests,—but I have so often received kindnesses from Western Horticulturists, far beyond, as I have thought, my ability to requite,—that I gladly avail myself of any opportunity when it is at all possible for me to render a trifle in return.

Your Secretary suggests that a few thoughts “on the necessity of a botanical education to the success and greatest enjoyment of the Horticulturist,” might not be unacceptable. I am not so sure about the necessity to the success of a Horticulturist, as that success is generally understood.

I remember that, when a young man, and in the midst of a very large circle of young men,

all studying horticulture, it was often that we heard the taunt, “What is the use of all your botany? can we not grow cabbage and potatoes as well without all this nonsense, as you can with it?” It was true. And to this day,—and I often think of it,—they are doing nothing but growing potatoes and cabbages, mostly toiling day by day for their daily bread, and hardly knowing to-day what to-morrow's field will bring them forth. The little band of botanical students, however, then with no means nor any desires beyond a thirst for knowledge, are all in positions of honor, trust and profit. One of these poor horticultural students is the present Dr. Berthold Seemann, whose title of L. L. D. has been awarded to him for his distinguished services in Horticultural Science, and whom, as the editor of the leading botanical journal in the world, is probably not unknown to many of you. At the present moment he is in the wilds of Central America, seeking what he may find useful or ornamental to add to the pleasures or comforts of his fellow man. Another of these poor gardeners has charge of a considerable tract of land, used for scientific experiments by the East India Company, at Otacamund in the East Indies—a position of the highest responsibility and usefulness. Another is director of the celebrated gardens of the British government, at Melbourne, in Australia, and so on all of the others. Indeed, whether in professional life, or as mere amateurs in Horticulture, I never knew one who united to mere practical gardening a love of botany, who did not succeed in producing results far beyond his fellows.

I hate egotism, and for fear of fostering it in myself, say little of my own personal career. I depart from this rule now, only in the hope that I may teach from experience. I will then say, that if I have achieved any success in horticulture, it has been all owing to the love of botany which was communicated to me by my honored father, himself an humble working botanist, and at the same time one of the most successful of the practical gardeners of his day. He was one of the pioneers in the wonderful success in the culture of the grape and pine apple under glass, which has of late years made English gardening so famous, that even Italian potentates have borne testimony to the fact, that the fruits of their clear and nature favored skies, could not begin to compare with the artificial products of these island gardeners.

Botany, I know, as often taught, fails to carry

with it any idea of utility. In my wanderings through the Union, during the few weeks of what I call my summer vacation, I often come to some country town, and in reply to inquiry, am directed to some one locally celebrated as a botanist. After introducing myself, it is quite likely he says: "Yes, I studied botany closely once, but I collected all the plants of the place, and as there was nothing more to learn, I have given it up; but here are my specimens."

Poor fellows! they had but really got together the letters of the alphabet. At the point when the real botanist begins to understand the true language of the science, they gave up the ghost,—or rather kept the "skeleton in the house," in the shape of an useless herbarium.

Collecting specimens is an excellent help to a beginner in botany. It educates his eye to see differences, in a way which nothing can better; and by preserving the specimens he is enabled to refer to these differences whenever his memory fails him. Then he learns to combine resemblances into groups—like with like—and thus commences the education of the reasoning faculties, without which no great undertaking ever succeeds. Any aid to reason helps one,—but in our daily undertakings, those things aid most which are in the nearest relationship,—and what is nearer to horticulture than botany? Chemistry, Geology, Entomology all have intimate connection with plant culture,—but the knowledge of the plant itself is the crowning glory of them all.

Powers of reasoning and of judgment on the differences one sees in plants, being once awakened, he will be sure not to stop there. He will want to know the causes of these differences. Then he feels that he must know something of the structure of plants; how they grow and how they feed, and of the laws which control their organization and their functions.

It is well known, that when a man knows the nature of his horse, or the parent the character of his children, he is better able to manage them than without this knowledge. So it is with plants,—the one who understands all about them, is at once prepared to act in an emergency, where one who knows not is entirely in the dark.

It is hard to show to one who knows nothing of botany, how great is the assistance to be derived from its knowledge in his horticultural operations, or how much it will add to his

pleasures. But I will try one or two illustrations.

One not acquainted with botany would hardly suppose there was any close relationship between the Tulip tree and the Magnolia. Now we have in American gardens a beautiful tree,—the Chinese Magnolia—which is clothed with numerous fragrant white flowers, before the leaves are out, or other things much in blossom, in spring. It is in great demand from its surpassing loveliness; but because it does not perfect seeds here, will not root from cuttings, and layers take two years to root, is scarce and dear. Knowing from botany that the Magnolia and Tulip trees are closely allied, I last year tried to graft half a dozen of this Chinese variety on the Tulip. They are so far alive, and the experiment promises to be a complete success. If it should this rare tree will become comparatively common, much lower in price because tulip trees can be more readily obtained than even more closely allied magnolias, and thousands enjoy this beautiful flower who would not perhaps but for this little bit of botanical knowledge as to the affinities of the tulip tree.

And now as to the pleasure which a knowledge of botany confers. During the past year or so cases have occurred where a potato has been found, apparently growing out from and originating in the centre of another one. Leading New York papers have even illustrated this as something wonderful. It would be wonderful if it really occurred; but it is only apparently so, and yet how is this appearance made so plausible. A lady botanist took it in hand. "First," says she, "a potato, by the laws of botany, is but a thickened stem, filled with starchy matter. If it grew above the ground, and lengthened out a little, with less starch, it would be woody, and with its eyes and buds be like any other branch. In this case the centre of the potato represents the pith." Now we know that a bud cannot form and develop within the pith of a tree, *therefore* this inside potato did not originate there. This of course set her to watch for other instances where the development of the mystery could be better traced. She was successful, and found that a young stolon or thread of a potato will strike against, and penetrate another potato already formed, and as you know the potato forms at the end of this thready stolon, the new potato was thus formed inside of its elder fellow. All this resulted from her botanical knowledge

of the nature of pith. Think you no pleasure resulted from this discovery? Scores had passed by this mysterious sepulchre, within which was laid up a treasured bit of knowledge, and saw nothing. For her the stone, which barred the entrance was rolled away, and she was permitted to sit therein, an angel.

The untutored savage, who sees a spirit in every huge rock, or numberless gods in the unusual occurrences of regular natural phenomena, is not more to be pitied than they who with the most beautiful processes of nature as exhibited in plant life, go to their graves as ignorant of them as a still born babe.

But I would not urge its study on the ground of pleasure alone. For me I know it has laid bare the successful practice of horticulture in a way nothing else has or could have done,—and this has brought, if not wealth exactly, yet a comfortable competence, I should certainly not have had without it. But beyond all this is the wonderful pleasure the knowledge itself brings. I can honestly say, that if it were a bare choice, either to go through the world, and die worth millions, or have a knowledge of all the beautiful things about me, with only the bare necessities of life otherwise,—I should not hesitate which side to choose.

In conclusion, let me say that if my poor pen could have the weight equal to my will, every fruit grower, gardener, or tiller of the soil in any shape, should be a student of botany, as one of the surest means of making his practice lucratively successful, as well as adding to some of the dearest pleasures of his life.

#### DRYNESS OF SOIL AN AID TO THE RIPENING OF WOOD.

BY J. M., PHILADELPHIA.

I sent you some notes a few months ago, under the above heading, which you inserted. My object was to show that in the cultivation of grape vines in pots, it was sometimes an object to get them stored away for winter, before, under the usual treatment, the leaves would have been shed. I advocated the withholding partially of water from them, believing there would be no injury, and finding they would shed their leaves earlier. As an illustration, I mentioned the case of some Silver Maples. Three of them were growing in front of my house, and the ground being very dry, had shed the greater part of their leaves, before another tree of the

same kind, growing near a wall, had shed a leaf. The communication, together with your remarks disagreeing partly with what I said, having received some attention, I again refer to the subject. Soon after I wrote the former letter, came on a heavy rain, soaking the parched ground, and the effects of it on the three Maples, with leaves partly shed, was to infuse, as it were, new life into them, and in the end the one near the well, which had not at the previous writing, shed a leaf, was the first to be entirely clear of leaves. The facts to be learned from this seem to be, that the three having a certain amount of duty to perform, could not for a time do it, from lack of water, ultimately obtaining it the few remaining leaves had double duty to perform, which required the presence of the leaves long after the one by the well had dispensed with its foliage. This would seem to imply, that the withholding of water from grape vines, that they may ripen their wood quicker is an injury; but is it so much so as to counter-balance the advantage above as desired?

Would not the wood of Roses, some Evergreens, Paulownias, and plants of like nature, be killed back less in winter, if their place of growth had been a tolerably dry one, not favorable to late growth, rather than a wet situation, fostering late growths; or in other words would partly tender plants winter better after a wet or dry fall?

#### FUNGI AND ITS STRUCTURE.

BY JOSIAH HOOPES.

*From an Essay read before the Penna. Fruit Growers' Society*  
(Concluded)

In passing to the Apple and Pear (for the species of Fungi, that attack them, are almost one and the same), I desire first to call your attention to the very dangerous disease, popularly known as the *fire-blight*. Our observing Secretary, in a paper read before the American Pomological Society, at its eleventh session, minutely described this malady in all its stages; and in fact, was the first to take decisive ground in favor of the fungoid theory. Subsequent research has fully proven to my mind, how true was his reasoning. Certain requirements are undoubtedly necessary,—or rather the little parasitic plant greatly prefers some particular condition in the growth of a tree to locate, for we find it destroying some varieties, to the total exclusion of others. In large blocks of Nursery trees, it

will frequently follow a particular row its whole length, and studiously avoid all others in the near vicinity. Thus we see, as in all other species of fungus, the form under notice, acts in precisely the same manner. Early in the season, this microscopic pest commences its operations, and at the point where it first makes its appearance, a slight discolorization will be apparent; which, rapidly working its way round the tree, in fact completely girdles it, and produces strangulation. As the bark darkens and dies, we need not then examine the locality, for the criminal has performed its mission and departed. Those who suppose the withering leaves and shriveling tender twigs embrace the diseased portion, are wonderfully mistaken. All the functions of the branch above the girdled parts will be found uncontaminated. This particular parasite propagates itself in the following simple manner, according to my observation. The spores falling upon the bark, soon change into little thread-like rootlets (if I may be allowed the term). These soon work their way into the openings of the epidermis, or outside skin of the tree, winding down through the cellular fibre of the bark, and here in the form of mycelium, grow directly on the wood. Occasionally, however, they penetrate the wood-cells, and in that case the disease is always, and quickly fatal. Berkeley asserts, in corroboration of this fact, that "the wonderful power of penetration possessed by Mycelium, may be easily seen in any dark-colored Fungus, by making thin vertical sections through the wood. Not only do the threads penetrate between the cells, but into their cavities themselves, at length completely blocking up their apertures, after traversing them in every direction." But while the little pest is rapidly spreading by means of its root-like formation, it is also developing large numbers of little capsules with their millions of spores, to reproduce its species in other spots. So that the sooner the branch is eradicated and burned, the better it will be for neighboring trees.

A few weeks since, I had an opportunity of examining a twig from a pear tree, which was thickly marked with indentations, closely resembling the result of insect depredations. Under the lens, it showed an occasional remnant of Mycelium; but the plant itself had perfected its growth, burst through the skin of the bark, and disappeared, thus causing the disfigurement mentioned above. As it appears to be an entirely

new form, or at least it works on a new method, I should like to obtain fresh specimens at an earlier season. Meehan, in the paper referred to in speaking of leaf-blight, alludes to the theory of its underground introduction. In this I think he is entirely correct. English Mycologists have asserted, that many species of Fungi, that appear in their perfect state on the external portion of plants, have first intruded themselves into the roots—up through the body,—out the branch,—and become apparent on the leaves; there to flourish, throw out their spores, and perish; leaving always behind them, a devastating mark, after they have passed away. Such I firmly believe to be the nature and habits of the leaf-blight fungus, as in nearly every instance the Mycelium will be found on the roots of such diseased trees or plants. Growers of Pear Seedlings should note this fact, and apply some powerful remedy to the soil, and thus destroy the seeds of growth. Canker and cracking of the fruit, have each been attributed by the aforesaid writer to the presence of fungus, and justly so, according to my own observations during the past year.

The disgusting, sooty patches on the skin of the apple becomes, under the microscope, one of the most enchanting sights—resplendent with all the rainbow tints. At one point, we see a rich golden-yellow; then, merging into a brilliant orange, or a charming shade of red,—the whole, forcibly reminding one of a bright mass of Fungi, consisting of thousands of dots and fibres, radiating in every direction from the outer edge, whilst in the interior, the dense bulk becomes confluent. To the naked eye this immense multitude of miniature plants covered a space no larger than a medium-sized pea. We frequently hear complaints of the Apple, Pear, etc., rotting on the tree. This is not unfrequently the work of an *Oidium*, allied to the origin of the Grape disease of Europe. It commences with a small dot or speck on the skin of the fruit, and as the Mycelium rapidly increases, the decaying portion soon marks its course, until at last the whole fruit is in a manner diseased, and rendered worthless. The terrible pest of the silk growers, that occasionally sweeps off their worms by thousands, is also closely related to the *Oidium*, and can be transferred artificially from one insect to another, thus proving its true character. My own views relative to the disease in the Peach, known as the "Yellows," are, I admit purely speculative at present, but at the

same time founded on personal examination and comparison with not unsimilar affections in other trees. For some years past I have carefully considered the many theories advanced in regard to this mysterious malady, but all proved unsatisfactory to my own experiments. The idea occurred, can it possibly originate from the presence of Fungi? I immediately commenced a series of critical observations on the organic structure of the wood of such unhealthy trees, and although I detected very many suspicious traces of these minute pests, I candidly admit that my labor was not rewarded with success. The *Yellows*, to my mind, present every feature of an organic disease, caused by some poisonous species of cryptogamic plant; as we find like traces of their existence, commencing in the roots, up through the main body of the tree, working their way out the various branches, and finally ending their career externally on the leaves and tender twigs of the present season's growth. During the life of the fungus, it makes scarcely a perceptible sign to the unaided eye of the observer, but after its functions have been performed, and the plant itself has ceased to exist, then the change in its victim becomes apparent. The dissection of various portions of the tree, plainly shows that a poisonous virus has penetrated into every part of its organization. This theory is sustained by many facts; as for instance, orchardists are well aware that a knife used in dissecting one of these diseased trees, will communicate the *Yellows* to a healthy one, by the simple act of pruning. This is an undisputed fact, and is an excellent argument in favor of the transfer of mycelium from one point to another. I feel confident that future and careful investigation, will confirm all that I have advanced in this direction. Some varieties of the *Peach* and its curious sport the *Nectarine*, are liable to mildew; in a few instances, injuring the tree alone, but occasionally destroying the fruit, whilst ignoring the limbs and foliage. This form of fungus is exceedingly partial to particular organizations, and will not spread from its chosen variety to another, whether near or distant therefrom.

The *knot* on *Plums* and *Cherries* is so evidently caused by the presence of Fungi, that it seems scarcely necessary to refer to it at all. But only so late as the past summer, I read in one of our Agricultural magazines, an article by a correspondent, arguing strenuously that the excrescences were caused by insects; "for had he not

seen them in all their various stages disorganizing the cells of the Plum and Cherry?" It is merely necessary to say that the insects in question select these soft spongy excrescences to deposit their eggs, as they would the young fruit, and if the writer of the article in question had commenced his observations sufficiently early in the season, he could readily have satisfied himself that another enemy was already at work. Our worthy honorary member, Dr. Ezra Michener, a cryptogamic botanist of high standing, emphatically asserts in the columns of the "Medical and Surgical Reporter," that this disease is caused in the manner which I have stated. The spotting of the leaf in Plums and Cherries, is caused by a similar species of Fungi to that found on the Apple and Pear, only differing in a few unimportant points, of no particular interest to the fruit-grower.

On the smaller fruits, we have numerous annoying diseases, classed under the general heading of *mildew*; as for instance, the foreign varieties of Gooseberries are often completely disfigured, by a fine, meal like dust or web-like growth, covering every portion of the plant and fruit, and rendering the latter entirely useless. Then again we find the leaves of Currants spotting badly, and Raspberry leaves shriveling and falling off prematurely. A very pernicious species of fungus has occasionally been found on Raspberry leaves, cup-like in character, and of a beautiful orange-color. I judge it belongs to a class of parasitic plants, which ascend from the roots, up through the whole structure of the canes; as we have ample evidence in the numerous weakened shoots usually forced into growth, as the result of its presence. I am informed, however, that it rarely occurs on properly drained soils. On Blackberries, both *high-bush* and *trailing*, in a wild state, I have frequently noticed this pest; but never in cultivation in the eastern portion of our State. I understand in some sections of New Jersey, it is presenting rather a formidable appearance, and increasing rapidly. I should feel obliged for specimens next year, and will gladly give any information in regard to it, that I may possibly discover.

#### REMEDIES.

There are various receipts for destroying these pests; but the most certain and least expensive, is to cut away and burn all diseased portions of the tree or plant, as soon as the malady is detected. Sulphur is perhaps the most powerful

remedy for destroying them, but heat is absolutely essential, as in a volatile state, it will penetrate into the most difficult places. A writer in the *Gardener's Chronicle* says: "The crude sulphur, it should seem, combines with oxygen in a nascent state, and so forms sulphurous acid, which is eminently destructive to mucedinous bodies, as appears from its effect in stopping fermentation. The more finely the sulphur is divided the better, and therefore it is more efficacious when applied in such a form, as to cause a chemical deposit of sulphur, or, as it is called in the old chemistry, a *magisterium* on the leaves." Lime, air-slacked to a powder, is likewise a valuable destructive power, either applied to the diseased spots, or incorporated with the soil. A combination of the above two agents, is occasionally used, and regarded by some, as more serviceable than either separately, for in solution, it forms a hydro-sulphate of lime.

English writers say that a successful agent in destroying smut on wheat, is a strong solution of *Glauber's Salts* applied to the seed, to be followed by a dusting with quick-lime, a short time before planting. Caustic Soda is also beneficial in ridding us of some species; and Carbolic acid has proven useful as well. According to Berkeley, "substances which would prove fatal to many other vegetables, as solution of arsenic, opium and many other poisonous chemical substances, do not prevent the growth of moulds."

#### USES OF FUNGUS.

Before leaving this subject, I wish to add a few words in favor of this class of vegetation. In addition to the many nutritious esculent species which are valued as articles of food, Fungi have another useful office to perform, and may be classed among the most beneficial scavengers of decomposing bodies. The moment vitality ceases in any organized matter, whether animal or vegetable, millions of spores floating in the air, are ready to alight upon it, and assist in its dissolution. Whether Fungi is the cause of disease, or merely a natural consequence of some disarrangement of the organs of a tree or plant, has long been a much disputed point; many scientific gentlemen being arrayed on either side. Of late years, however, the question appears to have been pretty generally settled in favor of the advocates of the former belief. Yet it is an undisputed fact, that these pests will attack a feeble tree or plant, in prefer-

ence to one in a healthy condition, after the manner of all parasites, whether animal or vegetable.

#### THE PEOPLE'S FRUITS.

BY MR. C. ANDREWS, MARENGO, ILLS.

The Early Richmond Cherry is now considerably disseminated, and may fairly stand as a representative of all the other classes of what are termed "iron-clad" fruits, which have of late been attracting so much attention in the northwest. The value of this hardy fruit is attested by the fact that it is being planted extensively even in some districts where the best cherries flourish. As a canning and cooking cherry it is not excelled by any other; and when well ripened, both birds and men accept it as a desirable dessert fruit. It is the cherry for the million everywhere. If either species were to be annihilated, doubtless the Morello would be retained as being of the greatest value to the human family, on account of its intrinsic worth and the greater extent of territory in which it flourishes.

We lately saw it stated that "Sweet Cherries bring two or three times as much as the Early Richmonds," in Chicago. It also appears that they cost two or three times as much; for among the expenses of their cultivation in Southern Illinois, we find the items of "carefully bugging the trees to destroy the curculio, and using proper care to prevent the bark from being ruptured."

The same writer gives figures to show that the Early Richmond Cherry has already "in some districts been planted so extensively, that the fruit brings but little more than the cost of marketing." Now, we aver that this is just the condition of things to be desired in regard to all our fruits. Give us plenty of fruits even if they become so cheap as to bring down the profits of the commercial orchardist. The more fruit grown directly by the consumer, and the cheaper it can be furnished to all classes, the better.

Horticulturists, as a class, are supposed to be public spirited citizens, not a close corporation of craftsmen. Is it not proper to "sink the ship" in our estimation of the public good? The fact that the Early Richmond Cherry has been produced so plentifully in Northern Illinois, as to render them cheap in the Chicago market, is the strongest reason why every farmer or cottager who owns a half acre of land, should plant



this variety. It shows that they will get returns for their outlay, while the sweet cherries cannot be grown here at all.

The same principle holds true of all our other so called "iron clad" fruits—the native plums, the wild crab of the country, and more especially of the improved varieties of that hard and excellent race of apples—the Siberians. The value of fruits grown for home use and for commercial purposes, is two distinct questions. In our section, the question of what to plant for the first is liable to be complicated by the rival interests of the latter. This, we take it, occasioned the comparison of the writer alluded to, between the Sweet and Early Richmond Cherries. Now, we are always glad to see our markets supplied with the best fruits grown in other sections; but we want no monopoly or influence from any quarter to discourage the growing of such fruits as are adapted to our climate, by the masses of our people. Let "rings" of this sort be gotten up in the interests of whisky, or whatever else, but let us have none of them in Horticulture. What becomes of the "humanizing influences of Horticulture," if we are to regard fruit-planting invariably as a mere matter of pecuniary profit to a limited class? The Early Richmond Cherry and the other classes of fruits mentioned above, are of incalculable value to the people of the Northwest, both in a pecuniary and social point of view; and knowing the leading character and influence of your journal as authority in Horticulture, we hope to see its sphere of influence constantly widened, by discussing the questions which belong to the Horticultural necessities of all sections.

### PRUNING WITH REFERENCE TO FRUIT PRODUCTION.

BY MR. WILLIAM SAUNDERS.

Read before the Penna. Fruit Growers' Society, January 20, 1870.

Natural laws are constant and unvaried in their operations. Our knowledge of these laws is derived from accurate observations of causes and effects. Science is the systematized explanation of these observations. The science of pruning fruit trees is, therefore, the explanation, or concentrated evidence of effects produced by manipulation on the branches and other portions of plants, derived from the accumulated knowledge of centuries of observation and experience; and when we consider the lengthened period, during which pruning has been performed—the general intelligence of the operators,

and the countless repetitions of similar processes ending in similar results, it is reasonable to suppose that a sufficient number of facts have been observed to establish a very perfect science.

I do not propose entering into an extended review of modes of pruning; neither do I intend to discuss, what is of far more importance, the principles that science has established for our guidance in performing the operation, but will at once proceed to state that, so far as the production of fruit is concerned on trees that form fruit buds on short spur branches, such as the Apple, Pear, Plum and Cherry, I am convinced of the evil of *shortening in*, as it is technically termed, the young growth or points of shoots, at any season, either summer or winter.

When we wish to form a thickly branched, bushy plant, such as we desire in a hedge, the end is accomplished by frequently pruning or cutting back the growing shoots as they project beyond the ideal limit, thus encouraging lateral twigs or side branches, slender, but numerous, as the object of a close hedge requires; but when the development of numerous lengthy shoots is the aim, as in willows for basket making and similar manufacturing purposes, pruning is performed during winter only, and the more decided or severe the operation, the stronger and better the resulting growths.

Similar treatment to the above, will produce similar results when applied to fruit trees.

I will take the Pear as an example; and certainly no variety of fruit tree has been so tortured under the sanction of both science and ignorance, as this has been. When the tree is submitted to a regular course of winter pruning, together with a regular pinching of young growths during summer, a thicket of slender growths is produced, and, if it is followed up with skilful persistence, may produce that great desideratum, a beautiful pyramidal shaped tree.

On the other hand, when summer pruning in its every shape, is abjured, and thorough, or severe winter cutting the systematic rule, a profusion of upright growths, of more or less luxuriance, are yearly produced, and yearly removed, just as practiced in the culture of willows, excepting that the pear growths are useless, and the willows are valuable.

All who are familiar with pear culture, will recognize these widely different modes of treatment, and the distinct forms so produced; also that they both agree in one important particular, that is, they produce but very little fruit.

Having practised both of these systems to my entire satisfaction or rather dissatisfaction, it occurred to me some twelve years ago, to let the trees alone. I had pruned, pinched and disbudded, until my trees were acknowledged to be as finely formed as any in the country, and they certainly were as perfectly outlined as the most beautiful of Norway Firs. I felt the risk of abandoning an orthodox custom, and of being classed among *negligent cultivators*, but my eyes were opened, I saw that these orthodox managed trees were naked of fruit, and resolved, that however much it might shorten in my reputation, I would not, for the future, shorten in my fruit trees.

To illustrate more particular the plan now pursued, I may state that in the spring of 1863 I planted a collection of 60 varieties of pears, these were set in duplicate, one half being on the quince roots, the other on pear stocks. These have received the same general treatment throughout. When planted they were pruned down very closely, many of them cut so as to resemble a smooth walking cane from two to three feet in length. In the fall of that year, they were cut back in order to establish a proper spread of branches, but with the exception of taking a few scions from some of the varieties, the branches have not been shortened since; some few tall branches have been removed entirely where they have become crowded, and a young shoot encouraged at the point of cutting, which ensures the healthy healing over of the cut and is essential in this mode of management, to take the place of future removals.

During the second and third years' growth, young shoots of three, four and five feet lengths were not uncommon, and it required some firmness to repress the inclination to prune, but the pruning resolution had not been lightly formed and was not to be lightly abandoned; and even the longest of these shoots became thickly studded with fruiting spurs, and in due time furnished with blossoms, and subsequently with fruit.

To show the Society what I mean by a thickly studded system of fruit buds, and the rapidity with which they form when allowed to grow as nature designs, I have here a few branches of various ages which I submit for inspection.

#### GRAPE SEEDLINGS AND HYBRIDS.

BY MR. G. W. CAMPBELL, DELAWARE, OHIO.

Your remarks on the Concord and Martha grapes, in the December number of the *Monthly*, induce me to offer a few words upon the same subject, and to express the belief that we have more reason to hope for real improvement in hardy, native grapes, through seedlings, and crosses upon the Concord than from any other source, the Delaware not excepted.

The Martha seems to have been the first "new departure," from the Concord in the way of a white grape that has come into general notice; but it is by no means the only one. And it is a somewhat singular and remarkable fact, that Concord seedlings exhibit not only an unusual tendency towards improvement, but also to produce a large proportion of *white* grapes. One of the most interesting of these, within my knowledge, is a natural seedling which I have had an opportunity of testing for two years past; in bunch and berry somewhat larger than the Martha grape, in flavor and quality fully its equal, and without apparent foxiness, either in taste or odor. The vine seems admirable, both in hardiness, health of foliage and vigor of growth; and I can really see no reason why this variety should not become one of the most popular and valuable grapes, unless its thin skin, and tender, delicate flesh may unfit it for handling and shipping profitably as a market fruit. It has received from its owner the name of "Lady," and I believe will be found an advance in improvement upon Martha, and worthy of especial attention. I feel less hesitancy in speaking favorably of this variety, as it is not of my own production. I am not permitted to give the owner's name at present, as he has no vines to dispose of, and does not wish to be annoyed by correspondence.

As an indication of the tendency of the Concord to produce white grapes, I will mention, that several years since I grew a lot of hybrids or crosses between Concord and Chasselas Musque, from Concord seed. From this lot I saved seven, whose habits of growth and foliage were satisfactory; and three of these—all which have yet borne—have produced white grapes, and have also proven as perfectly free from foxy odor or taste as their foreign, or male parent. One of these was the grape sent you last fall; and which must be regarded as promising.

I, at one time, regarded the Delaware as probably the most promising variety from which

to raise seedlings, as its unsurpassed quality and perfect hardiness required only the addition of a better and more enduring foliage to render it adapted to the most extensive cultivation. Many years of experimenting, however, produced little but disappointment. Out of hundreds of seedlings, nearly all that showed any improvement in vigor of growth, or health of foliage, produced also grapes of the wildest and most worthless character, resembling very closely the small, acid and seedy varieties of the *aestivalis* as found in our forests.

With me, a majority of Delaware seedlings have been black grapes; a few white, and less still, red. The black ones have been invariably worthless; and none of the red ones equal the parent Delaware. The white ones have been the best; and I am glad to say one of these now promises to be a substantial improvement, in that it is of much stronger habit of growth, with large, thick and heavy foliage, while in flavor and quality of fruit it is certainly equal, and to my taste, even superior to the Delaware. The only lack, so far, is in size. It has borne but two seasons, and only upon the original, or parent vine; the bunches and berries not exceeding in size those of the Delaware under similar conditions. It is not unreasonable to expect an improvement in this respect, as the vines acquire age and strength, and should my hopes in this particular be realized, I shall feel that I have achieved a result for which I have long and patiently labored—a *genuine improvement on the Delaware Grape*.

## EDITORIAL NOTES.

### FOREIGN.

*Horticulture in Berlin*.—Provided the war is over, it is proposed to hold a grand exhibition at the end of June, in Berlin, open to all the world, similar to what was held in Hamburg and St. Petersburg, a few years ago.

*Horticulture in Portugal*.—At a meeting held under the auspices of the Royal Portuguese Agricultural Society, at Lisbon, last autumn, Monsieur Jose Martino Pereira de Lucena Nortrona a Faro, the leading nurseryman of Lisbon, exhibited one hundred and fifty species and varieties of Begonia. This beats Philadelphia collections of this interesting plant.

*Hardy Palms*.—M. Naudin, at Montpellier, in France, has found *Phoenix reclinata* withstands

the severe weather which some times occur at that place, making no less than *thirty-one* species in the open air there. Our Southern nurserymen should take this hint and add to their collections. The following is the full list: *Brahea dulcis*, *Chamæcrops excelsa*, *C. arborea*, *C. Fortuni*, *C. Ghiesbreghtii*, *C. humilis*, *C. palmetto*, *C. macrocarpa*, *C. tomentosa*, *Corypha australis*, *Corypha gebangæ*, *Corypha spinosa*, *Cocos australis*, *C. campestris*, *C. chilensis*, *C. flexuosa*, *C. coronata*, *C. lapida*, *C. Peruviana*, *C. Romanzoffiana*, *Diplothemium maritimum*, *Jubea spectabilis*, *Phoenix dactylifera*, *Farinifera*, *sylvestris*, *tencis and canariensis*; *Rhapis flabelliformis*, *Sabal Adamsoni*, *S. Blackburniana* and *S. palmetto*; *Thrinax parviflora*. These were all out unprotected during the severe winter of 1869-70, when the thermometer descended to 12° (Reaumur.)

*Phylloxera vastatrix*, the insect which is so alarming European vine growers, is said to be an introduction from "des Etats-Unis d'Amerique," but it appears more is laid to its charge than it deserves. Another chap—*Dactylopius longispinis* of Targoni—M. Planchon says, is the cause of the "Black evil" (*Maladie noire*) in the grape vine.

*Classes of Foreign Grapes*.—In Europe these are divided into five classes: The *Chasselas*, the *Muscats*, the *Morillons*, the *Coulards* and the *Gonais*.

*Death of Baron Huegel*.—This gentleman's name is associated with so many plants, that it will be familiar to many of our readers. He was founder of the Imperial Society of Horticulture at Vienna, and was Austrian Ambassador to the Court of Belgium. His death has recently been announced.

*The Senasqua Grape*, raised by Mr. Stephen Underhill, of New York, is receiving notices from horticultural works in Germany.

*Pomology in England*.—This department of horticulture has not had the attention given in the United States, but it is proposed to have an International Fruit Show in Liverpool next autumn.

*Plants as Charity*.—Miss Burdett Coutts, the philanthropist, presented plants as a Christmas gift to the people of the poor house in her district, and it is said nothing could be more highly prized by them than these were.

*New Vegetables*.—These are attracting unusual attention in England. The leading agricultural journals are all filled with portraits of new peas

and snap-short beans, as ours are with outlines of apples.

*Hardiness of Selaginella denticulata.*—This Lycopodium, the commonest and oldest in cultivation of all the kinds in our greenhouses and hanging baskets, has been found quite hardy in England.

*Standard Roses* are still popular in England. These are made by budding the approved kinds on the Dog rose, which is a species very closely allied to the Sweetbrier. This is trained up to a single stem, and budded about four feet from the ground. They form pretty heads, and are a nice bordering to walks in geometrical gardens. They have never been a success in the United States, our dry, hot summers injuring the stems, which soon die.

*New Late Cauliflower*, Veitch's Giant, is highly praised in the English papers.

*A Rival to Coffee* has appeared in the seeds of the *Paullinia sorbilis*, a native of the Amazon region.

*Grapes to King William.*—Mr. Meredith, probably the best grower of foreign grapes in England, referred to in our magazine recently by Mr. Taplin, sent one hundred and thirty pounds to the King of Prussia, at Versailles Palace, and received an autograph letter from the King, saying they were the best he had ever seen.

*The Mannetti Stock*, which became popular in England after it was abandoned here for Rose-grafting, is now experiencing the same fate there.

*The Kew Collection* is the finest living in the world. No modern catalogue exists. The writer of this has one he made for himself in 1845, which is probably the latest one ever made.

*Botany in Africa.*—They have a thriving Botanic garden at Natal. Mr. McKean is the director. They have just started a *Society of Natural History*. Its first publication gives much attention to Botany. A new climbing *Scrophulariaceous* plant, to which our well known *Maurandia Barclayana* belongs, is described in it, under the name of *Battonia Natalensis*.

*Ampelopsis Vietchii* is getting to be better known in Europe under its prior name of *A. tricuspidata*. It is one of the many new plants of Japan introduced by J. Gould Veitch, recently deceased.

*Parks in America.*—A lecturer before one of the English scientific societies says America is now forming public parks about the principal towns, equal if not superior to the best in England or on the continent.

*The Wines of California.*—We see by French sources that attention is excited in Europe to the wines of California. Count Toucher de Careil, who examined particularly the vineyards of Sonoma county, reports that the returns from wine culture are undoubtedly "more certain, and more permanently so, than *placers d'or*. He refers to Dr. Wetherell's analysis, that the white wines of Sonoma yield eight and a half per cent. of alcohol, the red ten, and Hock often fourteen.

*Heat in the Flower of Philodendron.*—This curious plant is well known to lovers of rare plants, both by its curious leaves and by its delicious fruit. A new interest is being found in it in Germany, on account of the discovery of M. Brogniart, that a considerable amount of heat is evolved during the expansion of the flowers. It is not a mere temporary burst of heat, but the temperature is higher for five or six hours about the flower, than in other parts of the atmosphere of the house.

*Ammonia from Mushrooms.*—Dr. Eugene Fournier, in the *Revue Bibliographique de la Societe Botanique* of France, says that Mons El Borscow, of St. Petersburg, has discovered that mushrooms give off ammonia during their growth. It is thrown off from the mycelium or spawn, as well as from the complete mushroom; also, in light as in darkness. The exhalations increase with the development of the plant.

*Cider Makers' Society.*—They have in Flanders a society for the study of cider fruits. The last meeting was held at Ypres, on October 9th.

#### DOMESTIC.

*Horticulture in Iowa.*—Iowa was admitted into the Union in 1846. She has now nearly a quarter of a million of people. The Legislature and people of the State have always fostered every art and science having a bearing on the culture of the soil; but the Legislature does not, any more than in Pennsylvania, aid the Agricultural or Horticultural Societies. In the State Agricultural College, however, they have a Professor of Horticulture and a Professor of Pomology. Professor Bessey fills the chair of Horticulture and Matthews of Pomology.

*Over-production of Fruit.*—Our exchanges are discussing whether this is possible. They all agree that *superior* fruit always sells, and at highly remunerative prices.

*Death of Mr. McMinn.*—This gentleman, formerly of Williamsport, Pa., and well known to

the horticulturists and botanists of Penna., died a few months ago in Virginia, where he settled soon after the war. He was the author of valuable papers relating to agriculture, and especially known as a writer on the grasses of Pennsylvania.

*Grasses in Nebraska.*—It was at one time supposed the ordinary grasses of agriculture would not thrive in Nebraska. Col. Furnas, who has resided there for fifteen years, finds this to be an error. They do as well there as in any part of the Union.

*Primrose "Mrs. John Saul."*—This new variety is becoming very popular. Mr. John Saul, of Washington, is the raiser.

*Orange, or Golden Sweet Apple.* Dr. Housely, of Kansas, thinks one of the most desirable September apples for that State.

*Full Queen Apple.* Dr. Housely decides to be the same as the *Buckingham*.

*White Winter Pearmain Apple* is known in eastern Kansas and western Missouri as the *Campbellite*.

*Pryor's Red Apple.* Dr. Housely finds one of the best winter apples for Kansas.

*Blue Grass,* in Kentucky and Missouri, is the same as June grass, or Green grass in Pennsylvania and the East—that is, botanically, *Poa pratensis*.

*Making Honey.*—Mr. Quinby thinks bees gather honey, according to popular thought, and do not make it out of the sweets they collect, as some believe.

*A Seedless Grape.*—The currant of commerce is but a seedless form of the European grape. A Mr. W. M. Lausfield, of some place in Kansas, is said to have a seedless variety of a native kind.

*Screw-flowered Camellias.*—These are occasionally seen in the usual varieties, but sometimes they are produced from seed, and are characteristic of the variety. In the collection of the Hon. Mr. Macpherson, near Toronto, Canada, the local papers report a beautiful red variety, the "Count Esterhazy," as attracting much attention.

*Australian Ivy.*—This is often called German, or Austrian ivy. It is a species of *Mikania*, and is a native of Australia. We suppose it may have been used as a parlor plant first in Germany.

*The American area of Grapes* has been put at 2,000,000 acres, of which California claims 200,000, or one-tenth of the whole.

*Stamens and Pistils of the Grapevine.*—There are three distinct kinds of flowers on the grapevine. Some time since, Dr. Engelman wrote to us to know if any one had ever seen a purely pistillate grape. He never had. We now think it does not exist. But there are certainly three forms: First, purely staminate, in which there are no trace of ovariums; secondly, small ovaries, with defective stamens, which never produce seeds, though often swelling enough to make small grapes with no seeds; thirdly, hermaphrodite, which we believe alone produces fruit. We suspect all the male flowers throw their efforts away.

*Cost of Wooden Fences.*—In Illinois it costs \$1,000 to fence 160 acres, and \$4,000 more for repairs during the next twenty years—\$5,000 in all, according to M. L. Dunlap.

*The acreage of Central Park, New York,* is 843—136 being water. The cost of land and improvements, \$12,000,000. Up to this time politics have not been heard in its management, but we are very sorry to note that that good time, like so many others, is passing away.

*A Californian Horticultural Society* has been established. Dr. Bolander, of San Francisco, is President. Amongst the active members are R. Turnbull, C. Schuman, El. Reimer, and T. Sniedeman, all of the same place.

*The Eumelan Grape* is not the product of skill, but a chance seedling of Fishkill, New York.

*Rudbeckia hirta* and *R. fulgida*, two coarse-growing weeds, are said to be considerably spreading over the United States. The seeds are distributed with grass and clover. They give "beauty to the landscape," however, which is more than some weeds do; and if the grass is cut as early as it should be, the flowers get their "taking off" before their seeds mature.

*Sprouts of Ailanthus* and other suckering trees are often troublesome. By cutting off the sprouts two or three times during the growing season they may be destroyed. We have noticed this before, but have it again suggested by an exchange.

*Loam.*—This is a technical term used in gardening. All know what is sand and what clay is. Loam is a mixture of both. Light loam has more sand—heavy loam more of clay.

*Hanging Baskets,* to grow plants in, can be made of bark, thin wood, branches, wire, shells, pottery ware, or even of roots hollowed out, such as carrots, turnips, beets, &c., but in all

cases holes must be provided for water to escape. Root baskets are very pretty things. Of course they should be inverted, and then the beet, carrot, or whatever it may be, pushing out its own leaves, unites with the plant grown in the hollow of its own root, to add to the interest.

*Drying Succulent Plants* for herbarium specimens, is often difficult. Dip them momentarily in hot water; let them nearly dry before putting between the paper to press, and afterward run a hot iron over. Too much artificial heat, however, may make them brittle.

*White Wine Vinegar* is made from light colored wine, just as cider vinegar is, or colored dark as cider is—that is it *should be*, for it is often uncertain what any particular brand of vinegar is made from, unless made by oneself.

*Vinegar Making*.—A capital article of cider vinegar is made by setting a barrel of cider in the full sun—on blocks of course—taking out the bung, and in its place inserting an inverted porter bottle. This will admit light, but not insects or vermin, which, though they may not affect the quality, spoil the mental enjoyment of the liquid.

*A Successful Professor of Horticulture*.—Prof. Beal, of Chicago, is lecturer on botany, at Lansing, Michigan. This is one of the earliest and most successful Agricultural Colleges in the United States. It is said that sixty per cent of the students, after leaving, go into horticulture or agriculture, or some kindred pursuit. What a contrast to Pennsylvania. It has an Agricultural College, at an expense of thousands of dollars a year, and about half a dozen students to each professor. But, so far as we know, none of them “follow the soil” after leaving it. But here is the difference: In one case the students are taught to love science—in the other case the result is their despising it.

*The Yellow Corchorus*.—This pretty plant, now nearly banished to old farm houses and other out of the way spots, has recently been illustrated by the *American Agriculturist*, of which honor it is well worthy.

*The Double Blackberry* is another very pretty old thing brought prominently to notice by an illustration in the *American Agriculturist*.

## EDITORIAL.

### TRAVELLING RECOLLECTIONS.

Why people dislike to travel in winter, we could never understand. To us all seasons have an equal interest, and certainly the winter is capable of affording much more pleasure than many people imagine. Moralists have a fashion of likening winter to death. Its “icy hand” is a favorite simile,—and “cold as death” a common phrase; but neither cold, nor ice, nor snow, convey a death scene to us. The delicate pallor of the snowy field, is enlivened by the little rills of water, which, like dark blue veins course over it. We do not miss the birds, the green fields, or the little flowers,—their voices, to be sure, whisper nothing to us,—but seasonable nature tells us of a thousand things. Rocks and stones, —hills and valleys,—earth, sky and water, with their hundreds of forms and circumstances,—and moreover the living people, from all of whom we can learn something, make as much pleasure as any one of us can enjoy at once. This last consideration is especially one of the best fea-

tures of winter traveling. Persons are always more sociable, and every way more communicative, when gathered around the cheerful fire, than when wishing, as Sidney Smith was wont in hot summer to do, that he could get out of his flesh, and sit in his bones, in order to enjoy himself seasonably as a human being should.

Early in February we were on a train which was making its way through the beautiful Cumberland Valley,—one of the choice bits with which Pennsylvania tempts the soul-hunger of those who famish on the husky sameness of many other States. It is her boast that no other belt of similar extent in the Union can show as fertile a soil, combined with as much natural beauty. In former times, so it is said, the Indians reserved this as one great hunting ground. Young trees grew up on it,—but every few years the brush was burned off. This grew again,—and as often as it grew was again burned; and so on through countless generations. This is the way much of the fertility is accounted for; but it is doubtful, we think, that the facts were

quite as represented. At any rate some excellent modern philosophers credit the utter absence of trees on the prairies to the great and repeated prairie fires. Timber, mostly of oak and hickory, is very abundant all through this region, and the belief is that it has all appeared since the advent of the white man. Evergreens are very scarce. To a stranger, the immense quantity of Yellow Locust (*Robinia pseudo-acacia*) is a very interesting sight. It seems here to bid defiance to its great foe in other regions, the locust borer, perhaps through the immense quantity—it is “too much for it.” The wood is used for every purpose but nailing to. This is so hard that after the nail’s expansion by the heat of summer, the wood does not follow the nail’s contract in winter, and thus the hold is loosened and the nail drops out. Another peculiarity of the locust is that the rope-like roots seems to prefer to feed on the subsoil, and hence a crop can be grown almost up to the trunk of the tree without much injury by “robbing of the food” as other trees do. Amidst all the natural beauties and advantages there is, however, one thing which strikes the horticultural stranger painfully. Along the whole route, from Harrisburg to Chambersburg, there is barely any sign that any one knows what horticulture means. The contrast with the line of the Pennsylvania Central Railroad, in this respect is very marked. There we see some little gardening every where from Pittsburg to Philadelphia,—here we believe that ninety-nine hundredths of the inhabitants would look with as much wonder on a Norway Spruce, or even a well-managed osage hedge, as our friend Hoopes did last year on the mammoth Sequoias, or the great surprizes of the Yosemite Valley, as described in his Californian trip in our magazine.

But things are not destined long to be this way. Breaking through this frozen sea, we found open water at Chambersburg. Here was the great polar basin of horticulture,—thawing by its own inherent warmth, the icy circle which bound it, and stretching away towards the gulph waters on its eastern and southern lines.

There is here a very earnest Horticultural Society, which is doing good work. Previous to its organization there was very little horticultural or agricultural literature received here; now we were informed there were many hundreds of which over one hundred were credited

to the *American Agriculturist*, and nearly as many to the *New York Tribune*, which was taken, we were told, solely for the agricultural and horticultural information which it conveyed. The Horticultural Society is indebted chiefly for its success to the great interest taken in it by citizens generally. Some of the chastest horticultural addresses we have ever listened to were delivered here by the Rev. Mr. Davis, of the German Reformed church. As we have often said, much in all these social improvements depends on one man. Here, a quarter of a century or more ago, Mr. Jacob Heyser, a leading citizen of the place, did much to develop horticultural taste, and at various times established nurseries, though actually engaged in other business. He still does considerable in this way, although occupied with an extensive paper mill, which turns out about a thousand tons of paper a year. Mr. B. L. Ryder, near Chambersburg, has also done much. He was the originator of the ‘Nursery Association’ of the place, which is now managed by Mr. T. B. Jenkins, for the gentlemen who now constitute the Association. They have a very handsome office in the town, connected with which is a considerable tract of land, on which they have their greenhouses and other attractive departments. The houses were well filled with flowers, which we were glad to learn, found a ready sale amongst the citizens. The tree nurseries are about a mile out of town, and we found them well filled with thriving nursery stock, of which the apple seemed the great staple. The nurseries do a very large business for so young a firm, and with their admirable location and good soil and climate, will, no doubt, soon rank with the leading firms of the country.

The great fertility of the soil here cannot perhaps be better indicated than by the fact, that though immense quantities of straw are annually sold off the farms here to supply the paper mills, the crops seem to be nearly as good as ever. Heyser’s mill uses about 1500 tons a year. There was a circumstance in regard to the refuse of this paper mill as a manure which is worth recording. In preparing the straw for paper, lime water is used. The straw is thrown into large vats, and jets of steam introduced, by which it is rapidly boiled down. The lime water is then poured in. The straw is afterwards wheeled out into a large square heap like manure. It heats very rapidly, and in the course of a few days goes in as pulp to the cylinders

around which it gathers to form the paper sheets. The thickest and coarsest of this matter forms the refuse, and although nothing but lime and straw, makes a compost of the richest fertilizing nature. Mr. Heyser informed us that crop after crop of the same kind could be raised on the same ground by its aid.

In the fields about here, were immense quantities of the troublesome weed *Camelina sativa*, which, as a "pretty flower," the seed department of the Patent office so extensively distributed through the Union some years ago. We supposed it would be called Patent office weed, Washington weed, or some such designation; but found it called *Shuter* weed,—so we suppose some unfortunate Mr. Shuter will have his name handed down in ignominy to future generations, through being unfortunate enough to be in advance of the government, in the introduction of so vile a thing.

Here, as in most places where no immense wealth has accumulated in the hands of any one family, and many are well off, without being rich in a large city sense, small gardens are numerous, and of a pretty uniform character. Flowers and fruit trees are combined without any thought of a separate system. Pears, apples, cherries, grapes, crowd up to the back doors, or sitting room windows,—but beneath all these are well kept patches of grass, neat flower beds,—or tasteful walks, with roses or perennial flowers bordering on them. Some have evidently wished for more style without the requisite knowledge to carry it out tastefully. There was, for instance, one very handsome building, now used as a seminary for young ladies. The former owner of the building had evidently been educated to the knowledge that architecture was an art demanding genius. The building was as near faultless as the generality of our best ones are. Landscape gardening, however, seemed to have been placed in the hands of some one who could do the work "cheapest and best." The result was seen in some "highly original" ideas. A summer house, for instance, is an idea with which we are accustomed to associate cool and shady thoughts, in some quiet nook, where unseen and alone, a party can have together a pleasant chat. Here we have the structure set between the house and the road,—along the side of the turnpike in fact,—and as if the designer had in his mind, that the extreme of publicity was the essential idea

of an arbor or summer house, the earth had been first elevated into a mound of some ten or twelve feet before building on it. Probably this was a ruse to sell the property; for it has since been bought for a female seminary, in which, judging by advertisements we often see, it is a part of the duties of madame, the principal, to "keep a watchful eye" on the young ladies committed to her care. This certainly was the spot for such a one to secure.

In all these places, small or large, there was something to learn. At Dr. Seusserott's, for instance, we came across a plan for blanching and preserving celery, which has never been in print, and now we think, to those who don't know, it will be, as some publishers would say, "alone worth the price of the magazine for a year." No care is taken to blanch celery as it grows; but before frost it is taken up and put into barrels in this wise: A few inches of slushy mud is put in the bottom of the barrel; the roots of the celery put in the mud, and the tops upright and dry. The plants are crowded in by the help of the spade until the barrels are full. Then the barrel is sunk in the open ground, and when severe weather is likely to set in the top is protected. The affair is then frost-proof; stalks can be taken out as wanted, and the earth heat is sufficient to blanch the stalks beautifully.

As we have said, rare trees and plants are not yet found here to any extent. The Nursery Association, however, is taking up these things, and the taste will soon grow. On the grounds of Mr. Chambers, there, was one of the finest *Sophora japonica* we know of. It was about 20 years old, and had not bloomed yet.

We have left ourselves little room to speak of the surroundings of Chambersburg,—of Mercersburg with its wonderful fruit gardens—one of them of 200 acres, where the pear trees grow with the freedom of willows, and thousands of dollars are invested in fruit with better prospects of success than have followed many such enterprises,—of Hagerstown, with its orange and camellia houses, where growing in the open air, under glass, the trees laden with golden fruit, and lovely flowers rival the magnolia of Carolina or the celebrated groves of Florida. At some other time our thoughts may turn again to these pleasant impressions, when we will note them for the reader.



## ROSE GARDENS.

There are few things sweeter or prettier than roses,—nothing more interesting than a Rose Garden. A small plot devoted exclusively to their culture, can be set apart even in a very small place.

The chief objection, is that unless one have some of the tender kinds, they will not keep in bloom all the year round. For the hardy ones, known as *perpetuals*, do not flower very freely more than once a year. This does not apply to the South, of course, where even a *Devoniensis*—the “Magnolia Rose” of many Northern gardens—though one of the tenderest, lives out in all seasons. Roses in the North, as a general thing are not the ever-blooming “dailies,” or “monthlies,” they are supposed to be; and yet there is some ground for the idea, and quite enough to make us all try to have them, and as much more as we can.

Now, though we say we would have exclusively a place set apart for roses, we mean not to have it distinctively a place for roses; but be-

tween the roses, to have verbenas, or other low-growing annual flowers, which will not interfere with the stronger bushes, for which the garden is designed. This will make it a point of interest for the whole season, and not interfere with the growth or flowering of the Roses.

We thought to call attention to this now, because we have recently seen some plans for Rose gardens, in a horticultural channel of some pretensions, which are not at all adapted to the purpose. Large circular beds, the very worst for the purpose, enter largely into the idea. Everybody wants to cut, or at least handle, or closely examine the flowers, and to get in through the mass of twigs; it is enough to make any lady feel that she is a rose between thorns, as the young men often tell them. Whatever plan is adopted, the beds should for this reason be as narrow as possible. The best walks between the beds is grass kept neatly mown. We give with this a very good design, taken from the *Encyclopedia of Cottage Architecture*.

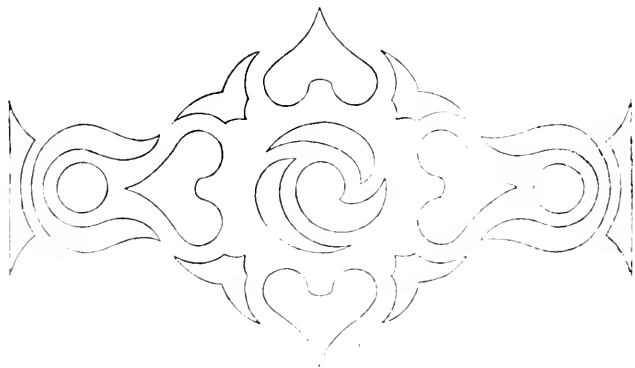

## BOOKS, CATALOGUES, &amp; C.

GRAY'S SCHOOL AND FIELD BOTANY. By ASA GRAY. Ivison, Blakeman, Taylor & Co. New York, 1870.

It is very rare that one who reaches the head of any science is able to descend to the average intellect, and make the most abstruse subjects plain to the commonest understandings. Prof. Lindley, in England, had much of this rare power,—and in our own country Prof. Asa Gray in a remarkable case of this kind. Any one conversant with the history of Botany is satisfied, that without Prof. Asa Gray, this interesting

study—the amiable science—would be far behind what it is now,—and this not so much for his own mastery of the subject, as for his wonderful capacity for teaching it understandingly.

All who have read Prof. Gray's former works will feel the force of these remarks, and yet they will be particularly struck with the clearness of the present work. A child capable of reading well, would get a good idea of Botany by reading this book; while the most advanced botanist will find pleasure and profit from its perusal.

It gives an account of the growth of the plant from the seed, through all its phases, of stem, leaves and fruit,—of how one organ is morphologized or changed into other organs,—of how plants grow, and in what way the various tissues are formed,—and of plant-life in general. Then there are directions for collecting plants, and for forming them into herbariums,—a glossary of all the “hard” words used by systematists,—and finally, a description of all the leading plants, whether wild or cultivated, which the student is likely to meet with east of the Mississippi river. It is hard to understand how Botany could be made more pleasing, or its study made easier by any other work than this. It seems all that is wanted, and we could wish no better for the success of scientific horticulture, than for everybody to possess a copy.

Dr. Gray has now passed the meridian of life—his three-score has been reached. It is difficult to understand what more he can do in this especial field of Elementary Botany, to make it clearer or plainer; but the hundreds, who will become botanists by the reading of this little book, will heartily wish that he may yet live many years, so that they can thank him for the great pleasures which only those who have been fortunate enough to be led into the study knows how heartily they enjoy.

Transactions of Worcester County (Mass.) Horticultural Soc'y.

We are always pleased to receive this annual document, giving the doings of the year of one of the most prosperous societies in the country.

During the past ten years there has been an average increase of 40 new members, and the roll embraces over 800. Amongst the grapes we note that the variety *Fedora*, recently noticed in our pages, is called by the committee, a “beautiful white grape, reputed hardy.”

Amongst the exhibitors of plants, Olm Brothers, of Springfield, figured largely.

In pears there is great competition, and we should judge their culture is a great success thereabouts. There were 242 contributors of 4441 articles at the annual exhibition last year. The library is increasing largely in size, and the demand for loans very active—544 volumes being taken out last year. The Secretary's notes on Raspberries are interesting. The Philadelphia has been discarded, simply because the finer foreign varieties can be grown to perfection. Brinckle's Orange is the most prolific. A

letter of Charles Downing is quoted, which says, with him the B. Orange is “the highest flavored and most productive of any,” we presume of the foreign kinds.

Grape success has been unexampled. Roger's Seedlings, and Iona, seem to be the favorites.

The pear and apple crop was wonderful,—the Secretary intimating his opinion that the absence of rain, while in blossom, had much to do with this success.

The report closes with a parting shot at the unfortunate robin, which seems to be to the Bay State what the curculio is to us.

*The California Horticulturist.*

We have to hand the first three numbers of a new magazine to be devoted to horticulture, published at San Francisco. The editor's name is not announced, but we suppose it is managed by Mr. F. A. Miller, who has quite an excellent reputation as a landscape gardener. With his talent and intelligence, the *California Horticulturist* ought to be a great success.

Catalogue of a Japan Nursery.

And only one month getting here! both circumstances seem strange. All who want Japan plants should write to Mr. C. Kramer, Yokohama, Japan, care of W. H. Smith, Esq., for his catalogue.

Catalogue of Grasses.

Many of our nursery and seedsmen are adding features to their catalogues, which give them the value of regular works published at high prices. We have from time to time referred to some of these as they came before us. We now have before us the catalogue of Messrs. J. M. Thorburn & Co., of New York, in which there is an excellent description of grasses. This will make the catalogue extensively sought for.

#### CATALOGUES.

As usual at this season, our tables are loaded with catalogues of the nursery and seed trade. We are pleased to notice the marked improvement in typographical accuracy and general beauty of most of them. They far excel the average catalogues of the Old World. Many are profusely and expensively illustrated, and give information worth the price of many volumes.

We do not give addresses in full of these, as

our space is limited, and especially as they all advertise in our columns. Amongst the best are the following, received :

Allen & Johnson, general nursery stock ; Graves, Selover, Willard & Co., general ; B. K. Bliss, seeds ; R. Buist, Sr., general nursery stock ; P. J. Berckmans, nursery ; Bird & Co., nursery ; R. Douglas & Son, wholesale evergreens ; Dingee & Conard, nursery ; Evans & Co, nursery ; Ellwanger & Barry, general nursery ; Dr. John E. Ennis & Co., general nursery ; Frost & Co., general nursery ; E. C. Frost, general nursery ; Gould Bros. ; J. H. Gregory, seeds ; Harden, Cole & Co., trees, etc ; Joseph Clark & Co., grape vines, small fruits ; Peter Henderson, new and rare plants ; Bennett & Davidson, new and rare plants, etc. ; J. M. Thorburn & Co., trade list of seeds, and retail list ; R. Buist, Sr., rare plants, etc. ; Henderson & Fleming, vegetable and flower seeds ; W. H. Lyman, new plants ; W. P. Robinson, general stock ; J. Wentz, general wholesale ; J. Knox's Successors, fruits, etc. ; Brown & Templin, fruits, etc. ; A. F. Chatfield, orchids ; Olm

Brothers, flower seeds, etc. ; J. W. Manning, fruits, evergreens, roses ; Otto & Achelis, wholesale ; Pellet & Conover, seeds ; C. L. Allen & Co., seeds, plants, etc. ; Hargis & Sommer, wholesale nursery ; S. S. Jackson, general nursery ; Louis Ritze, general list ; Charles Black, fruits ; Hoopes Bros. & Thomas, general list ; J. M. Jordan, trees, fruits, etc ; Miller & Hayes, roses, plants and trees ; Hubbard & Davis, plants, roses, etc. ; F. K. Phoenix, wholesale, etc. ; L. C. Baumann, roses, etc. ; Wm. Grassie, plants, etc. ; Sulzer & Bro, general fruits, trees ; George Such, orchids and rare plants ; Smith, Clark & Powell, general nursery ; W. C. Strong, nursery and Florist ; James Vick, seeds ; T. G. Yeomans, nursery ; D. Landreth & Son, vegetable seeds ; Collins, Wetherill & Co., seeds ; Thos. J. Pullen, fruits ; H. A. Dreer, seeds, and nursery ; E. Moody & Son, nursery ; Gould Bros., wholesale trade list ; Wood & Hall, trade list ; Storrs, Harris & Co., American Chestnuts ; Hovey & Co., seeds and plants ; Washburn & Co., seeds ; Joseph Breck & Co., seeds ; Feast & Sons, rare plants.

## SCRAPS AND QUERIES.

**PICEA FRAZERI.**—It is singular that this beautiful tree does not get more into cultivation. Very few persons can distinguish it from the common Balsam Fir ; but it is very distinct. We have seldom seen it so well defined as in some specimens received from Mr. J. M. Nelson, gathered in Huntingdon county, Pa. In the common Balsam Fir the leaves are inclined to be what botanists call spatulate, or thicker at the upper end than the lower ; but in these the leaves taper at both ends. The habit of the tree, also, is spreading, much as in the European Silver Fir. Mr. Nelson says the lower branches which trail on the ground, root, as the Yew does.

**SEEDLING GERANIUMS.**—We have received from Mr. Philip Shæfler, gardener to Jay Cooke, Esq., specimens of nine Seedling Geraniums, some of which are fully equal to many of the popular named kinds. It is very difficult to get Seedling Geraniums distinct from the many varieties in cultivation. We should hardly look for one in a thousand. One of these, however,

strikes us as being worthy of separate mention. It is labelled "Mr. Cooke, Jr." The truss is large, the flowers of good size, and the petals tolerably well formed. There are many like this of the full scarlet class ; but this is a rosy pink, not a usual shade in these large bunched varieties.

**WRITING FOR COPIES OF THE MONTHLY.**—Every spring we receive innumerable letters from friends, offering to write for us if we will send the Magazine in exchange. Many of these are from friends whose writings we highly value. *But we have no list of the kind.* The vast amount of voluntary matter we receive, renders it out of the question. We did it the first year or two, but it seemed to us great injustice to send the Magazine to those correspondents who asked for it, and not to those who did not, and it was too much to send to all. We have endeavored, as the most just plan, to give *much more than the two dollars' worth* in our Magazine, and to trust to the consciences of those who are able to return the overplus in hints and other pen contributions.

VARIETIES OF ASPARAGUS.—*J. E. H. Man-  
alapan, N. J.*, says, "I wish to have your opinion  
in regard to Asparagus; whether there is so  
much difference in kinds, or is it in cultivation?  
Some writers say it is in the variety; others say  
it is in culture, while others say it sports. If so,  
the plants from one pound of seed, (of any sort)  
there will be likely to be many varieties. I  
want to set a patch for market next spring, and  
wish to set the best. If there is much difference,  
the price is nothing; if not, it will make quite  
an item. Mr. Dreer says his Mammoth is equal  
to the "so-called Conover's Colossal." He asks  
\$6 per thousand. Mr. Bliss says there is a very  
great difference in favor of C. Colossal. He asks  
\$25 per thousand; but I can buy it much cheaper.  
or what would be cheaper yet, buy the seed and  
wait. If the Grant or Mammoth is as good, it  
is better to get the roots, as America is fast, and  
cannot wait without extra pay."

[There is no more reason why Asparagus  
varieties should not come true from seed, than  
corn, or wheat, or beans. All these have been  
raised from one common stock, and yet they  
come true. Our opinion is that Asparagus vari-  
eties, when the variation has become fixed, will  
repeat themselves tolerably true from seed.]

A NEW HICKORY.—*J. L.* writes: "In a  
Cyclopedia recently published in this city, under  
the caption 'Hickory,' it is stated with regard  
to one of the species, that 'it is also known as  
the *Kisky Thomas nut*.' We suspect that a  
*period* after the first word, and a *tall* syllable to  
terminate the last, would bring the features of  
this old friend of our boyhood into better shape."

PRUNING EVERGREENS.—"Subscriber," *Pitts-  
burgh*, says: "The Park Commissioners of our  
sister city of Allegheny, are now planting a  
large number of Austrian Pine trees throughout  
their City Park. The trees are very large, but  
vigorous and fine-looking—fully fifteen years old.  
The proportion of top to root is about same as  
enclosed rough sketch. The writer, being igno-  
rant in such matters, would like to have your  
opinion, through the columns of the *Monthly*,  
about planting, without pruning, such large  
trees. It is customary to prune, when trans-  
planting, deciduous trees. Why not Evergreens?"

[The evaporation from such a large mass of  
foliage will be much against the success of the  
experiment, and very much benefit would result

from pruning them. We should cut away one  
half the branches. This, however, must be done  
judiciously. It must be remembered that Pine  
"needles" are not leaves, but branchlets acting  
in the place of leaves; and are not reproduced  
as readily as true leaves on regular flower-bear-  
ing plants. Hence, Pines suffer more from the  
loss of this substitute for foliage than other  
things with true leaves do. If the tree be cut  
too much to curtail evaporation, it may suffer  
for want of enough leafy matter. Great judg-  
ment is necessary.

OIL FOR INSECTS.—*F., Wabworth, N. Y.*,  
writes: "I wish to inquire, through the  
*Gardener's Monthly* or otherwise, whether oil  
—animal, vegetable or coal oil—are known to  
be injurious when applied to the body or branches  
of trees; and if not, whether there may not be,  
in some of these oils, the best protection against  
a large part of the insects which are so injurious  
to fruits of various kinds."

[Some oils have been found injurious to the  
bark of trees; others not. Again, the same oil  
has been found an injury in some stages of  
growth, and not at others. No doubt, if accurate  
experiments were made, and oils graded so as to  
guard against these exceptions, something might  
result of great benefit to horticulturists, as oils  
in general are destructive to insect life.]

THE CODLING MOTH.—A correspondent, re-  
ferring to a quotation from Dr. Hull in our last,  
says the larvæ of this insect never remain over  
winter in the pupa state. Also, where Dr. Hull  
says, "it surrounds itself with a pupa case." it  
should more correctly read, "It transforms to a  
pupa, and surrounds itself with a cocoon."

WILLOW TREES.—*J. P. S., Frankford, Pa.*,  
writes: "A road, crossing my property, will  
take down a willow tree some twenty years old,  
which we value very highly. Is there any way  
to transplant this without any great expense?"

[You can do this without *transplanting* at all,  
in the common sense of the term. Willow  
*branches* of any age or size will grow as enttings,  
as well without as with roots. For this, we  
have to head back all the branches, leaving only  
the main stem. In this case, we should cut off  
the tree close to the ground, and then cut away  
from the top all excepting the main stem; plant  
this heavy piece so as to be two feet under

ground, and it will grow as well as if you were to spend much money in transplanting root and top in the usual way.]

**TRANSPLANTING AN OSAGE ORANGE HEDGE.**—*J. P. S., Frankford, Pa.*, says: "I have an Osage Orange Hedge, now ten years old, which I value very much. The line of road along which it is planted is somewhat undulating. The road is now being graded, and in the hollow part the earth will come up nearly to the top of the hedge. Could I, in any way, lift these plants without destroying their value as a hedge?"

[You cannot lift them, but you can, what is much better, cut notches or tongues upward in each main branch. Cut into the pith, that is, half way through. Do this in several places, all the way up as high as the earth is likely to be filled in. Roots will then come out from them, and be near the surface just the same as if they were seedling plants. You can then let the new growth grow up as high as you require, and it would soon form a hedge as high as desired.]

**TRIAL OF A SEEDSMAN.**—A case of much interest to seedsmen was tried, a few weeks ago, before Judge Hare, in the District Court of Philadelphia. A Mr. Kessler sued Mr. Dreer in damages somewhere about \$1500, for the loss of his cabbage crop. In the fall of 1868, he bought seed of Early York Cabbage of Mr. Dreer. The next season the cabbage yielded only soft heads, and Mr. Kessler's conclusion was that it was not Early York Cabbage. On this ground action was brought. Mr. Dreer might have settled the matter, to avoid trouble, but he preferred to vindicate his honor as a seedsman before a jury. It was clearly proved in evidence that the softness was owing to culture and season, and the verdict was in favor of Mr. Dreer.

**HOOPES' TRIP TO CALIFORNIA.**—*J. G. Elmira, N. Y.*, writes: Josiah Hoopes' account of his trip to California, and what he saw, is alone, worth a year's subscription to the *Monthly*; but on reading his account of the Yosemite Valley, was quite anxious to hear how the Merced river got out of said valley, but of which he does not inform us. Please have the goodness to have him inform your readers how said river gets out of the valley, for if it has to pass over that rocky band of 4,000 feet, there certainly ought to be quite a deep lake in said valley.

**IN FLORIDA.**—Messrs. Ellwanger & Barry, and numerous other Horticulturists, are wintering this year in Florida.

**APPLE INSECTS**—*T. G. Y., Walworth, N. Y.*: We will endeavor soon to give the paper you suggest.

**BOTANICAL.**—"At the last meeting of the American Philosophical Society, Mr. Thomas Mehan, editor of the *Gardener's Monthly*, and agricultural editor of the *Weekly Press*, was elected a member of that time honored institution as a tribute to his botanical researches."—*Philadelphia Daily Paper*.

**CREDIT TO THE RURAL CAROLINIAN.**—"The *Gardener's Monthly* copies Dr. Wylie's article on "The Janie Wylie Grape," and gives credit to *The Carolina Farmer*. The article appeared originally in *The Rural Carolinian*."

**OUR COLORED PLATES.**—No one has had more experience with the Martha Grape than Mr. Campbell, of Delaware, O. He "knows" what a good representation of it should be. The following note from him is therefore very agreeable to the publishers:

"The chromo of the Martha is truly a 'distinguished success' I think it is the best and most truthful grape plate I have ever seen published in this country, and your publishers may justly feel proud of it."

**AMERICAN POMOLOGICAL SOCIETY.**—The next meeting will be held at Richmond, Virginia, on September 6th, 7th and 8th. The horticulturists of that section are making efforts to render the occasion worthy of themselves, and we hope they, in time, will be seconded by our friends everywhere.

**DENDROBIUM NOBILE.**—In our notice of Mr. Geo. Such's place last year, we referred to a magnificent plant of *Dendrobium nobile* in his collection, and suggested that Mr. Newett,—who perhaps might claim the honor, if his modesty would allow him, of being the "orchidea king" of this country,—should look to his crown. This seemed to put him on his mettle. His plant has *seven hundred and fifty-seven flowers*. Now let us hear from South Amboy.

## NEW AND RARE PLANTS.

CENTAUREA CLEMENTEI. — The beautiful 'Silvery-leaved' Centaureas have proved admirably adapted to our climate. *C. ragusina* was the first of great merit. Then, last year we had *C. gymnocarpa*, with leaves much finer divided. We have now another, with foliage of still greater elegance. We hope to see it introduced next season.



NEW CRIMSON FLOWERED MIGNONETTE. — Recently we gave an account of a new Mignonette. Any improvement of this popular flower always interests. We now give an illustration of another. The anthers are of a dark crimson instead of a brown, as in the common

variety. Our illustration is from an European source, but we note that it is already offered for sale in this country.



## DOMESTIC INTELLIGENCE.

**PRODUCTIVE PEAR ORCHARD.**—Many of our readers will remember the fine collection of pears exhibited at the State Fairs and Horticultural shows in years past, by John Morse, of Cayuga, N. Y., and the first premiums which he was in the practice of carrying off. His young trees have now become more mature, and his fine orchards of some three thousand standard pears are now bearing full crops. A few days since, in company with several horticultural gentlemen of Geneva, we had the pleasure of visiting his grounds. His fruit farm is three miles north of the Cayuga station on the Central road, on the banks of the Seneca river. A few of his trees have been planted nearly forty years, but the most, from twelve to eighteen years. An orchard of about five hundred trees, planted eighteen years ago, was bending under heavy crops. The Bartletts were most conspicuous, and the fruit was all that the trees could hold. The proprietor thought it would have been better, both for the specimens and for the trees, if they could have been thinned early in the season. The Virgalicus had been worked over to the Beurre Bosc, which, for market value, stands next to the Bartlett, if not its equal. The tender character of the tree has been obviated, at least in some degree, by being worked standard height on the Virgalieu. These trees were bearing heavy crops of large and handsome pears. Some of the Bosc trees had been grafted in the nursery rows near the ground, but they were not so fine as the others, the growth of this sort being somewhat crooked and feeble. The Doyenne Boussock, although a free, hardy grower and good bearer, and which Mr. Morse formerly regarded as one of the best sorts, has not proved profitable for market, as the pears do not sell well in New York, and he intends to work them over. The Autumn Paradise, an excellent pear, is not profitable, and will be changed to other sorts. The Winter Nelis is largely planted. Many trees of the Anjou have been recently grafted. Another orchard, about twelve years planted, contains over two thousand trees; many of them were heavily loaded.

These orchards afford a strong contrast to most of the trees in this region, in their profuse crops the present season, while pear trees generally bear very scantily. Mr. Morse has found of late years that he gets more pears and better

ones by keeping the ground cultivated instead of allowing it to run to grass. The corn crop proves one of the best for this purpose, as it represses the growth of weeds, and in this respect is better than potatoes. Buckwheat is likewise regarded as well suited to these orchards, as the ground may be kept mellow and clean during the first part of the season, before the grain is sown. When gathering time arrives, such of the buckwheat as happens to be in the way is trodden under foot, where it mulches the ground, and the rest is cut and threshed.

Lime has been found decidedly beneficial, being first slacked into powder and then spread broadcast over the ground, at the rate of over a hundred bushels per acre. The time of year for applying is not important. The trees thus treated had a perceptibly better growth and bore better than the others.

Nearly all the trees are standards, but some dwarfs were growing on a low, rich, alluvial spot, among which we saw trees of the Duchesse d'Angouleme fourteen feet high, and of corresponding spread of branches, bearing each several bushels of fine pears. They had not been cut back, and appeared scarcely to need it, although the fruit would probably have been larger and the trees of better form, if the operation had been performed as needed. Possibly they would have been less productive.

We did not learn what annual revenue had been received from this pear orchard of nearly three thousand trees; but if one-half the trees should bear each year, and yield a bushel each, which must be below the actual product, and the net receipts amount to only three dollars a bushel, the returns would be from three to four thousand dollars. Mr. Morse said his pear trees yielded him five times as much as his apple trees, and he has certainly established the truth that, under his good management and fine locality, "*pear orchards will pay.*"—*Country Gentleman.*

**CALIFORNIA EVERGREENS.**—The *Abies Douglassii* extends from Mexico to Alaska along the Rocky Mountains, west to the Pacific and east to the "1000 mile tree," on the Pacific railroad, which is a Douglass Spruce or Fir, though the "guide book" calls it a Pine. This tree is described as straight; but it has the habit of

being what botanists denote *ascending*. It never rises perpendicular from the ground, but grows obliquely for ten or twelve feet, (as seen in trees one foot and more in diameter) and then becomes perpendicular. In using many hundred trees, it was always necessary to reject a portion of the butt when a long, straight stick was wanted. This peculiarity is most obvious where the timber is somewhat scattered; but never wanting in dense forests, so far as my observations extended during three years spent for the most part amid forests of this tree. The branches in dense forests are slender, and scattered along the main shaft near the top; but in open places are much larger, and the tree assumes a form more or less ovate.

The Douglass Spruce should be called the Douglass Fir, as it has more affinity with the firs than the spruces. It has numerous balsam blisters on the bark of young trees as the other firs, and its cones have *bracts* like some of the American firs, as *Picea nobilis*. The bark, branches and general appearance of this tree are so much like the hemlock, that a casual observer would think them the same.

The lumbermen, mill wrights and carpenters, who cut and work this timber, call it Red Fir. The wood contains a large amount of pitch. In other respects, it resembles the hemlock more than any other eastern wood.

In Prof. Newberry's excellent report, (Vol. VI. of the P. R. R. Reports,) the fine portraits of *Abies Williamsonii* and *Abies Douglassii* have evidently been exchanged, as the figure labelled Williamson's Spruce is a perfect figure of the Douglass' Spruce, growing in open forests; but the figure labelled Douglass' Spruce is very different from any tree of that species I ever saw.

The *Abies Menziesii* usually grows in places more wet and shaded than the Red Fir, and ranges higher up the mountains. The wood is said to be like the Red Fir; but it is much whiter, softer, lighter and not so strong, and much less durable. It contains no pitch, save in some small lenticular cavities in a semi-fluid state. The Red Fir is more durable than the Pitch Pine; while the Menzie's Spruce decays nearly as quick as the Balsam Fir.

Prof. Newberry, in Vol. VI of the P. R. R. Reports, gives a very good portrait of this tree; but it often assumes the form of the figure given as the Douglass Fir.

The wood of this Spruce, save in very old trees,

is very white,\* and receives a very fine finish with a marked satin or pearly lustre. No coniferous tree of the American forests furnishes any more beautiful finishing lumber than this—save, perhaps, the *Pinus contorta*. The wood of this pine is harder, about as white, and receives a fine polish with a satin lustre which, with its numerous bird's eye markings, make it very beautiful.—G. C. S., in *Colman's Rural World*.

\*It is called "White Spruce" or "White Pine" in the mountains.

**THICK GRASS A PROTECTION AGAINST DROUTH.**—One of our best farmers makes it a business always to have a thick close set of grass—this, for one thing, to guard against the drouth which becomes so frequent; and he succeeds. His land is drained, either naturally or otherwise, and this helps. It is well cultivated, pulverized, and rich when put in, so that it is sure to "catch," and equally sure to grow. The first crop is clover; then timothy, which is sown with the clover; and other grasses come in, and they form a thick mat. To do this they are aided by plaster and ashes, and manure rotting in heaps on the farm. Hence there is a thick sod, a dense growth, affording a great amount of pasture and good tender feed. The drouth never overcomes this growth; it is, in all the lots devoted to it, green, and affords fresh cropping; but it is never permitted to be cropped too close. It is this thick turf, soft as a cushion, that defies the sun. A little rain greens it up at once; it is not evaporated as on a barren soil. The ground is less hard, porous and somewhat moist. The thick grass prevents the ground from being heated, not coming in contact with the sun as in the case with thin set herbage. Grass itself is cool; it keeps the earth cool; hence less evaporation. The winter receives this turf with much grass upon it, much feed. But the spring finds it in resurrection, early, and early to be turned on, springy, yet firm. Better have half or a third of the land, and have it like this, than to have the stock starving over large areas. The drouths will come, almost yearly, either early or late, or in the middle of the season; seldom that we have no drouth at all. And in a rainy time this turf is a good protection against the tread or cattle, so that it is good all round—good for drouth, good for rain, good for feed, and most excellently good to turn down for grain.—F. G., in *Country Gentleman*.



## FOREIGN INTELLIGENCE.

## INTRODUCTION OF THE POTATO IN FRANCE.

--There has been an extremely interesting conversation at a recent meeting of the Societe Centrale d'Agriculture upon Parmentier and his share in introducing the Irish potatoes into general use. I hope some notice of this conversation will not seem out of place here, especially as the bibliography of this question was touched. Marshal Vaillant opened the conversation by mentioning that one of his friends had discovered a treatise dated 1749, which contained some curious details about the potato, and indicated the various methods of preparing it for food. It is consequently an error to say Parmentier was the first person who introduced the potato; for he merely propagated it. M. Boussingault shared Marshal Vaillant's opinion upon this subject; Parmentier had not done as much to introduce the potato as was commonly believed. It was while returning from the siege of Mayence. Parmentier discovered the potato in the fields. M. Boussingault, referring to a previous discussion, added: Maize is a native of South America, but has never been found in a wild state, and has always lived under man's protection. M. Chevreul, President of the Societe, said Duhamel du Monceau is the first person who mentioned the potato; M. Boussingault is right in saying Parmentier's share in the introduction of the potato has been exaggerated, and that he first saw it in Germany as he returned from the siege of Mayence. M. Renou, Professor of Natural History at the Ecole Centrale of Angers, told him (M. Chevreul) how his friend Parmentier had studied the cultivation of the potato in Germany. Upon Parmentier's return to France he exerted himself to bring by every means of publicity the potato into use, to recommend it as an article of food, and to propagate it. Justice should be done Parmentier in this matter; but Parmentier believed the potato was equal to wheat in nutritive properties, because he had not comprehended the importance of gluten (which Beccaria had discovered in wheat flour in 1727) in nutrition. Marshal Vaillant said manufacturers could not use potatoes to powder with. M. Chevreul replied, the coarseness and transparency of the grains of potato starch prevent its being used for this purpose, but that this very coarseness of its grains enables it to be used instead of powdered charcoal to powder the

moulds in which bronze is cast. M. Huzard referred to a bishop's charge of the seventeenth century, in which the cultivation of the potato was recommended to the whole diocese. M. Payne confessed Parmentier's merit did not lie in the introduction of the potato, but in its propagation by ingenious means, and successful attempts to overcome the prejudices of his day which opposed the general use of this vegetable as an article of human food. In the "Grande Encyclopedia," which was commenced in 1750, it is stated, at the close of the article *Pommes de terre*, which was published in 1765, that potatoes are eaten in various ways by peasants of different provinces, but they were coarse food and extremely indigestible. All Parmentier really did was to make this vegetable popular by a curious stratagem. He planted a field of potatoes, and had it guarded by gendarmes, spreading the report that it was an exceedingly valuable article of food, to attract public attention to it. In a short time he ordered the gendarmes to relax their watch. Some peasants stole a few potatoes; others imitated them; and at last the whole crop was disseminated among the inhabitants of the neighboring villages, and the good qualities of this article of food were sufficiently well proved to efface all traces of old prejudices. Parmentier likewise introduced the potato to the tables of the wealthier classes. One day he appeared in Louis XVI.'s presence with a nosegay of the modest flower of the *Solanum tuberosum*. The king questioned him about it, and he easily persuaded his majesty to introduce its cultivation upon the royal estate. The courtiers soon imitated the royal example, and the neglected plant was carefully cultivated. It is consequently incontestable Parmentier made the potato popular not only among the poor, but among the wealthy classes. The potato was introduced into Germany in 1710; it was then confined to gardens; it was introduced slowly to farms, and nothing less than the famines of 1771 and 1772 were necessary to overcome the prejudices which militated against its general use. M. Pepin said there were few varieties of potatoes at the beginning of this century, and these were cultivated almost exclusively for animals. It was only in 1818 or 1820 potatoes appeared on the tables of the wealthy. Several members combated this assertion, and declared potatoes

were to be seen on the tables of the rich long before the dates indicated by M. Pepin.—Correspondence of *Publishers' Circular*.

**CULTIVATION OF TREE-CARNATIONS.**—It requires a considerable amount of care and judgment to grow these delightfully-fragrant flowers satisfactorily. The cuttings should be struck in February, March and April. Take cuttings of two or three joints in length, remove the lowest leaves only, put them into pots or pans in sand alone, and place the pots in a brisk moist heat—like that afforded by a melon or cucumber frame, for instance. When well furnished with roots, put them into thumb-pots, and then shift from thumb-pots to three-inch size, and so on, always observing that they should not be shifted till they really need it, nor be allowed to become pot-bound for want of a shift. As soon as they have recovered from the first shift, nip out the growing points, and then stop no more. Continue to shift as required till the middle of July, when they may be in either eight or ten-inch pots, as both are good sizes in which to flower them. After the plants are established in the thumb-pots, they should be grown with as little artificial heat as possible, and after they have had their last shift put them out of doors in an open situation, and stand the pots upon a bed of coal-ashes not less than six inches in thickness. When the pots are well filled with roots, water with *very weak* liquid manure. The pots must be drained efficiently, and the compost should consist of good turfy loam quite free from wire-worm, with about a third of its bulk of old cow-manure, and a liberal proportion of sharp silver-sand. House from the 21st of September to the 7th of October, regulating the exact date by the time they are wanted in flower and by the weather. Keep them near the glass in a cool airy house for a fortnight; then transfer them to a warm greenhouse, where they will begin to bloom towards the end of November, and, by judicious management, continue in flower throughout the winter.—*Gardeners' Weekly*.

**CAN GARDENERS CLAIM A MONTH'S NOTICE.**—The plaintiff in this case, which was recently tried in the Tunbridge Wells County Court, is a gardener, and an action was brought to recover the sum of £3 6s., three weeks' wages. Plaintiff said he was engaged by the defendant as gardener and farm bailiff at the rate of 22s per week, on the understanding that a month's

notice should be given on either side. After remaining in the employ about 16 months, and having been generally paid by the week, he received notice to quit, signed by the defendant's mother. He lived with his wife and family in the lodge on the grounds. The son of the defendant said he gave notice to the defendant to leave his mother's employ personally, and handed him a week's wages in advance. (The notice to quit was in three places dated 1869, and his honor said it could not be held a good one.) The defendant was also called, and she denied that any words had passed between the plaintiff and herself as to notice being given on either side. She engaged him in the ordinary way, at so much per week. His honor said a gardener with a family living in a lodge could not be disposed of so readily as a cook or housemaid, or a single man, as they could get into lodgings directly. The law was in favor of the yearly hiring in this case. Payment by the week was merely the mode, as such persons required their money as early as they could get it, and he was strongly of opinion that a man who brought his wife and children into a lodge on the premises really came under the ordinary meaning of a domestic servant. In that case he was entitled to a month's warning. He was inclined to think that gardeners hired generally, without any special agreement being entered into, were entitled to a month's warning, and therefore he should give a verdict for the plaintiff for the full amount claimed.—*English Gardeners' Weekly*.

**LOVE OF FLOWERS IN NEW YORK.**—The passionate love of flowers the New Yorkers have borrowed from the French. Flowers enter very largely into all the solemnities, fetes, and events of New York life. The gentleman who wishes to testify his devotions to a young lady does so by daily offerings of magnificent flowers. Statesmen, orators, opera-dancers, divines, are alike accustomed to receive these floral tributes. The bride is married beneath a magnificent floral bell; the coffin is decorated with exquisite crosses, crowns and wreaths of flowers. The Rev. H. Ward Beecher preaches with a floral basket by his side. Mr. George Francis Train has equally floral tributes, which he waves in the course of his denunciation of British influence and the old fogies of the Bible. On the occasion of a benefit-night to a favorite actress lately, a basket of choice flowers was brought on to the stage, as an offering from some of her admirers, which had to be carried by four men.—*Belgravia*.

# The Gardener's Monthly.

DEVOTED TO

*Horticulture, Arboriculture, Botany and Rural Affairs.*

EDITED BY THOMAS MEEHAN.

---

Old Series, Vol. XIII.

APRIL, 1871.

New Series, Vol. IV. No. 4.

---

## HINTS FOR APRIL.

### FLOWER GARDEN AND PLEASURE GROUND.

Some one has said that men are but children of a larger growth. Possibly the writer of that wise saying had been visiting Philadelphia, and been amongst the gardens there. The child thinks the little conical bits of green which the toy maker calls trees, just the thing trees should be; and the children of a larger growth, in the Philadelphia gardens, have their trees clipped and shaved, just as these toy trees of infancy are made for them. Mr. Robinson, in one of his English letters, says he saw very little real gardening in America, excepting Germantown as one of the places creditable to the art. We are sure he forgot the outrageously clipped trees when he wrote this paragraph. Now we like a little trimming on some trees. It often helps to restore a certain degree of uniformity which is pleasing. But this regularity of form and thickness of foliage, is only pleasing when it looks natural.

Where evergreens can be benefited by pruning, April is a very good month to attempt it. If a tree is thin in foliage at the base, the top of the tree, leader and all, must be cut away. It makes no difference what the kind is, all will make new leaders after being cut back, if properly attended to. We make this remark because there is a prevalent idea that Pines will not stand this cutting. Of course the trimming should be done in a conical manner, so as to conform to the conical style of the evergreen tree. Sometimes an evergreen, especially a Pine, will rather turn up some of the ends of its

side branches than push out another leader; when this is the case, cut these away, and a real leader will form the second year.

Evergreen hedges should be trimmed now, cutting them conically, so as to give light to the lowermost branches.

There is so much to be done in April, that the briefest hints must suffice. First, of course, we must prepare the ground for planting. Soil loosened two feet deep dries out less in summer than soil one foot deep. Rich soil grows a tree larger in one year than a poor soil will in three. Under-drained soil is cooler in summer than soil not under-drained. The feeding roots of trees come near the surface; therefore plant no deeper than necessary to keep the tree in the soil. If there be danger of its blowing over, stake it, but don't plant deep. One stake set an angle is as good as two set perpendicular. Straw or mat set round the tree keeps the bark from rubbing. Large stones placed around a transplanted tree are often better than a stake. They keep the soil moist, admit the air, and encourage surface roots. Shorten the shoots at transplanting. This induces growth, and growth produces roots; and with new roots your tree is safe for another season. Unpruned trees produce leaves, but little growth, and less new roots.

Place broad-leaved evergreens where they will get no sun in winter, yet away from where the roots of trees will make the ground dry in summer. Deep soil, but shallow planting, is all important for them. In transplanting, take care of the roots. Good roots are of more importance than good "balls." Balls of earth are useful in

keeping fibres moist ; but don't sacrifice the best fibres five or six feet from the tree for the few fibres in the ball at the base. When roots are rather dry, after filling a portion of soil, pour in water freely. After all has settled away, fill in lightly the balance of the soil, and let it rest for a few days. This is as a remedy, not as a rule ; for watering this way cools the soil, ultimately hardens it, and in other respects works to the injury of the transplanted tree.

Unless inside of a round ring, or circular walk, don't plant trees or shrubs in formal clumps. They are abominations in the eyes of persons of taste. Meaningless irregularities form the opposite extreme. Remember, "art is nature better understood."

In your flower-beds, if the plants sickened last year, change the soil. Renovated earth is renewed health to consumptive flowers. Sow Annuals as soon as the ground is warm. Too early sowing and deep covering, rots seeds very often. This is frequently the cause of one's seeds being "bad." Prepare flowers in their winter quarters for the summer campaign, by gradually inuring them to the air before setting out finally. Set out when all danger of frost is over. Don't set out a plant with a dry ball ; but water well while in the pot an hour or so before.

In arranging flowers in beds, aim at varying from last year. And to obtain this everchanging and pleasing variety, annuals are the very things for the purpose. But they must have good soil and careful attention, or the seed will be sure to furnish a good excuse for neglect or bad practice in many instances. Very fine seeds may be sown quite on the surface, and a little moss, dried and powdered, spread thinly over the seeds. The common cause of failure is deep sowing. The nearer the surface, the better, provided they do not ever become dry—which is as fatal as deep planting. It is a happy practice that can just hit the middle way. Climbing annuals are particularly interesting. Tuberoses are best planted out as soon all danger of frost is over, in a rich, moist, warm, sandy soil, if perfection is desired. Roots that flowered last year will not flower again for two seasons.

#### FRUIT GARDEN.

Fruit trees that have proved undesirable from any cause, may be re-grafted with more favored kinds. This is an advantage with some varieties—it takes an age, for instance, to get the

Seckel Pear into bearing condition from a nursery raised tree ; but by grafting it on one that has already "arrived at years of discretion," the advantage of placing a young head on old shoulders, in this way is soon made manifest.

Grafting can be continued till the buds of the trees are nearly pushed into leaf. Sometimes, from a pressure of other work, some valuable scions have been left on hand too late to work. It may be interesting to know, that if such scions are put into the ground much the same as if they were cuttings, they will keep good for six weeks or two months, by which time the bark will run freely, when the scions may be treated as buds, and will succeed just as well as buds taken from young summer shoots.

Those who have vineries will have them, at this time of the year, in various stages of growth. The "extra early" houses will have their fruit ripe ; but we suppose most of our readers whom these hints are likely to benefit, will have the crop about coloring as their earliest efforts. It is the critical period, as if any check be experienced by the roots, they will not color well. Hence, great care must be taken to keep the foliage healthy. Sudden bursts of sun on tender foliage, or red spider, are the chief points to guard against. The roots in the outside borders also, if the borders have been covered with litter through winter, should be aided by having the covering removed. If, however, any of the litter has decayed, it should be left as a covering to the roots. The outside grape border should never be disturbed by digging. Hundreds of graperies are ruined by this "surface culture." No grape grower of any excellence digs up his vinery borders that we know. The importance of keeping grape roots at the surface is now so well understood, that it is very common for good grape growers to uncover and lift their roots occasionally ; and to do this and yet get a first-class crop of grapes the same season, is considered by the English journals an eminent achievement. With reference to the coloring of grapes, most good gardeners use the syringe very sparingly, and admit more dry air during this process than at any other period of grape growth.

Other houses of early vines, started later, have the berries about setting, as soon as which is accomplished, thinning out of the berries with a slender nosed seissors should be forthwith proceeded with. The bunches should not be handled in the operation, as it predisposes the berries to rust.

In late houses, where there is no artificial heat, grapes are often injured by the houses being kept too close. The temperature rises under warm suns, and the buds burst only to be sadly affected by our cold March and April nights. Many try to remedy this by flues; but the best way is to keep on all the air possible to keep down the temperature of the house, and where practicable, the canes may be laid down along the front of the house out of the sun's reach.

### VEGETABLE GARDEN.

South of Philadelphia, the more tender kinds of garden vegetables may now be sown, beans, corn, cucumbers, squashes, etc., that it is not prudent to plant in this latitude before the first of May; and tomatoes, egg plants, etc., may also be set out in those favored places. Cucumbers, squashes, and such vegetables can be got forward as well as tomatoes, egg-plants, etc., by being sown in a frame or hotbed, and potted off into three inch pots. They will be nice plants by the first week in May. Rotten wood suits cucumbers and the squash tribe exceedingly well as a manure. Tomatoes and egg-plants that are desired very early are best potted, soon after they come up, into small pots. They can then be turned out into the open air without any check to their roots. Of course, they should be gradually inured to the open air—not suddenly transferred from a warm and moist air to a very dry one.

Bean poles may be planted preparatory to sowing the Lima Bean in May. Where bean poles are scarce, two or three hoop-poles, set into the ground one foot from each other, and tied together at the top, make as good a pole, and perhaps better.

Dwarf beans should have very warm and deep soil,—sow them only 2 inches apart. The Valentine is yet the best early, take it all in all.

Peas should be sown every two weeks for a succession,—do not make the soil very rich for them.

Lettuce, for a second crop of salad, should be sown about the end of the month. The Drum-head cabbage is usually sown for a summer crop; but the old kinds of Cos lettuce would, no doubt, be found very valuable in rich soils.

Early York Cabbage for early use should be set out early this month. It is an excellent plan to make the holes with a dibble first, where the cabbage is to be set; then fill up the holes with manure-water; and, after the water has soaked away, set in the plants. It is rather more laborious than the old way; but the cabbage grows so fast afterwards that it pays pretty well.

It is not a good plan to cut all the asparagus as soon as they appear. A few sprouts should always be left to grow from each, to strengthen the plants.

Celery, with most families, is an important crop, and should be sown about this period. A very rich moist spot, that will be shaded from the mid-day April sun, should be chosen; or a box in a frame by those who have the conveniences.

Few things mark a well-kept garden better than an abundance of all kinds of herbs. Now is the time to make the beds. Sage, Thyme and Lavender, grows from slips, which may be set in now precisely as if an edging of box were to be made of them. They grow very easily. Basil and Sweet Marjoram must be sown in a rich warm border.

Salsafy and Scorzonera like a damp rich soil.

## COMMUNICATIONS.

### COLOR IN AUTUMN FOLIAGE.

BY PROF. ALBERT N. PRENTISS, CORNELL UNIVERSITY, ITHACA, N. Y.

In the *Gardener's Monthly* for February, page 60, some very interesting statements are made in regard to the color of autumn leaves, based upon the observations and experiments of Mr.

Warton as related in the *American Journal of Science*. That the oxidation of the chlorophyll is the principal cause of the varied tints of autumnal foliage, I think there can be no doubt; but the subsequent remarks in regard to the action of frost do not agree with my own observation. The statement is there made, that when a

sharp frost occurs early in the fall, while the pulp of the leaves is still full and plump, the red colors come out most brilliantly. I do not agree with this opinion, but think that our most brilliant autumnal tints occur in those seasons when frosts hold off until very late—never when vegetation is arrested suddenly. The maturing of the leaf is a ripening power, which reaches its greatest perfection in rather warm and dry autumns, especially when there is a considerable proportion of that beautiful weather known as Indian summer. Fruits of all kinds ripens most perfectly during similar seasons.

The richest color I have ever observed in leaves, were in some seedling maples, growing in rich open woods, the colors being developed before the appearance of frost. In the soft maple, I have sometimes observed a single branch take on the most brilliant crimson, while the remainder of the tree was still green. Apparently some injury to the branch had caused it to ripen its leaves in advance of its neighbors. Next to the soft maple, the sassafras of our northern woods takes on the most brilliant color. During several years, I noticed in a grove of these trees that the lower branches colored earlier than those higher up. Gradually the change in color progressed upwards until the whole seemed almost like a mass of flame. In some seasons, when an early frost has killed the upper leaves of small trees, they turned brown without exhibiting the bright colors, while the lower ones, protected from the frost by those above them, are left to ripen during the succeeding warm days, and subsequently took on the usually vivid hues. Even in the tropics the foliage of some of the few deciduous trees, properly so called, becomes quite richly colored during the process of ripening. Some of the Palms display rich, if not brilliant colors in the ripened foliage. I call to mind especially the foliage of the Assai, that most graceful of all the Palms of the Amazon valley, on which I have observed the lower and ripened leaves to be of the softest and richest brown, passing imperceptibly into bronze, thus presenting a striking and beautiful contrast to the mass of green foliage. For the most part, however, it is the young and tender foliage of tropical plants, especially of exogens, which presents the brightest colors, as though it needed exposure to sun and air before the chlorophyll could assume the exact chemical composition most favorable to plant growth.

In our northern deciduous trees, the fall of the leaf is provided for by a joint formed at the junction of the base of the petiole and the surface of the stem on which it rests; this joint does not exist at the time the leaves unfold from the bud, but is formed during the season's growth. If now an early frost arrests vegetation before this joint has been completely formed, we might expect that the leaves would not fall at the usual time, and this is actually what occurs. A few years ago, in this vicinity, a severe frost occurred at an unusually early date; the leaves being thus killed became brown, or in many instances retained their green color more or less perfectly, and remained for a long time attached to the tree. In some instances apparently the entire foliage remained upon the tree until the succeeding spring. None of the usually bright colors were observed.

Prof. W. W. Daniells, of Wisconsin University, Madison, says, that on the 20th of October, 1869, the thermometer sank to 12° in that vicinity. This severe and sudden freezing had a very injurious effect upon orchards, nurseries and vineyards; freezing the plants so suddenly while the season's growth was still incomplete, that in many cases the leaves, perfectly green, dried as if heated in an oven, and remained on the trees all winter.

It very frequently occurs that small trees at the edge of a forest, and second growth trees generally, retain their foliage for some time, not unfrequently until spring, when it appears to be pushed off by the expanding buds. This may be attributed to the vigor of growth of such trees, which continues until late in the season, and thus prevents the perfect ripening of the leaves. Very often the leaves are for some time retained on the lower branches of certain trees, while those of the upper branches have fallen off. As the sap in many plants tends most strongly to the upper parts, these become more perfectly ripened, and the leaves fall at the usual time; while the leaves on the lower branches are less perfectly matured, and are retained more or less firmly according to the degree of ripening. It would, therefore, seem possible that a lack of sufficient nourishment, as in the latter case, where certain parts of a plant receive less than their due share, would present the most perfect maturation of the leaves; while on the other hand, an overstimulus to growth, as is sometimes seen in highly manured orchards, especially dur-

ing warm and wet falls, would produce a similar effect. Of course the greater or less exposure to wind will have an influence upon the fall of the leaf; but this cannot be a determining cause, as the branches most protected, and small trees quite thoroughly protected, very often retain the greatest number of leaves.

### BEDDING GERANIUMS.

BY MR. J. TAPLIN, MANAGER TO GEO. SUCH, ESQ., SOUTH AMBOY, N. J.

From seeing fine masses of Geraniums in flower out-of-doors for a number of years in England, I was disappointed to find that few varieties made even a tolerable appearance in this country, the sun spoiling both flowers and foliage. I was pleased to see a few varieties doing well in the neighborhood of both Boston and Philadelphia. On inquiry, I found these sorts were American seedlings, evidently raised from some of the old varieties which were grown before the present strain of fine shape and large sized flowers were raised. When I found that some few varieties did well, I concluded that there was no reason why some of the fine European sorts should not do well also; to test which, I planted a number of plants of all the varieties we grow, and of which we are continually receiving fresh varieties from Europe. These plants were planted in the full sun without any extra preparation of the ground, and never watered or mulched, and I find we have five varieties of rose and pink colors, about twenty distinct varieties of scarlet, five various shades of salmon, and one fine pure white, which grow and flower fine all through the summer until cut with the frost. The above are all fine large and good shaped flowers, worth growing as pot plants, their hardiness adds very much to their value.

I do not admire the taste, or rather want of it, which requires Scarlet Geraniums and yellow Calceolarias to be planted by the hundred thousands, which is done in some English gardens. My friend, Mr. Wm. Robinson, calls it the thunder and lightning style. But a few good beds of fine Geraniums are indispensable in a garden of any pretensions, and not out of place in the smallest flower plot.

### ASPARAGUS AND MUSHROOMS.

BY MR. JOHN JAY SMITH, GERMANTOWN, PHILA.

Why is it that these two delicious articles for the table are either so dear or so rare? is a ques-

tion often asked. I fear the cultivation of neither is understood. Lately coming into the possession of a large farm in Montgomery county, almost within stone's throw of Philadelphia, I found on it an acre, more or less, of Asparagus, but it was, according to my preconceived and book knowledge, good for little and probably nothing. It was overgrown with the worst kind and most persistent of grasses, including the couch—the farm having been rented to a careless fellow—and I expected nothing less than to plough up the whole, and try to get rid of the nuisance. In this frame of mind, came on the Asparagus season of 1870, when, behold! I had the most delicious crop—so declared by all who partook of it—that they had ever tasted; abundant and most succulent and flavorsome. I gave it away by bushels daily, and had an over-supply besides. Now how is this? We learn from books that it must be planted so and so; stones must be placed to keep the roots from roaming, no grass or weeds, plenty of manure, and hogsheads of salt. The two latter are no doubt very useful, as I proved on a small corner, where the product was larger, but no more toothsome, as I thought on one year's trial.

Soon after the cutting season, it became necessary to make a deep road through the bed. We cut down five feet in some parts, and everywhere the Asparagus roots were to be seen, often four feet deep and more. Here was the secret: the covering of grass on the top seemed to have no influence whatever, the roots strayed and rejoiced in their liberty, and derived nourishment from great depths. I was willing to believe a discovery had been made. Now how does this tally with Mr. Editor's theory, that surface stirring is so all important? [Which Editor?—ED. G. M.] Let him answer. And now for

MUSHROOMS. I find, like my own case, very few are able to get Mushrooms from their own greenhouses, or to buy them, except where nature provides for a few short day's supply. Tell us why? Every gardener your engage says he knows the secret—that they can be grown anywhere and everywhere, in cellars and outhouses, and under the slats of the walks of the greenhouse; and in all these situations have I seen them; but the sight was the exception, and I have come to the conclusion that gardeners either don't like to gratify their employers, or don't like the trouble. To say I have spent many dollars for spawn—very many—would be to say the truth; but I never had more than a tureen full

of the fruits all told. A lady near Baltimore, some years ago, did find a gardener who understood the culture, and undertook to pay the cost of a fine greenhouse and large garden by selling mushrooms. She did so, and showed me her accounts, with a profit on the right side. Now we have in our great cities fruit stores selling, in winter, readily, long cucumbers at 75 cents each,—and by the way I priced Vicar of Winkfield pears there in January, and the modest price was 75 cents a piece,—they were large and fine. Now let somebody who don't mind a little trouble, engage in raising Mush-rooms, which it is easy enough to do. I will take at once, product to the value of two dollars a week, and be thankful.

### DOUBLE GLAZING.

BY MR. W. C. STRONG, BRIGHTON, MASS.

If my recollection is correct, you have quoted me as having found the double glazing of green-houses to be a saving of coal in one year equivalent to the extra cost of glass. This is putting the case twice as strongly as I ventured to do it, and as my experience will permit; and indeed no uniform rule can be given for all positions and every kind of structures. High and exposed positions would be more benefited by double glass than low and protected houses. Still it is very apparent that a second covering of glass will insure a great saving of coal in all houses, and the only questions are, whether the saving is sufficient to warrant the extra cost, and also whether attendant evils are more than counter-balanced by benefits. You state your experience, Mr. Editor, to be confined to hot-beds. Of course such a trial must be considered as made under most unfavorable circumstances. Hot bed sashes are almost invariably so flat that the sun's rays strike very obliquely. The rule is well known, that as the angle of the rays with the glass becomes more acute the deflection rapidly increases. This is a sufficient reason why frames with sash of single glass even are so unsatisfactory for growth when the sun runs low. It is because the sun rides high in March, equally as because of the higher temperature, that frames then warm up. For any such flat surface it is unquestionably best to give the least possible obstruction to light and heat, securing protection by outside cover ings. And for roofs facing east and west, it is to be presumed that a second covering of glass would deflect and obstruct the sun's rays too seriously, except for plants requiring a partial

shade. But there are houses where the sun's direct rays are not wanted, such as Camellia-houses, propagating houses and the like. For these I have no hesitation in re-affirming that double glazing is a very great economy. For roofs looking southerly and of ordinary pitch, my opinion is that there is a decided gain, sufficient to warrant the cost. The advantages are as follows: First, a very great saving of coal and consequently an ease and certainty in management of the house; and secondly, an increase in the humidity and a softening of the fierce glare of the sun, which is better than any shading can be.

On the other side, what are the objections? Snow does not melt and slide from the roof as readily as upon a single roof. This is not a serious objection. Dust is liable to accumulate on the under sheet, so that in the course of time the house might become too much darkened. This evil can be remedied by cleaning the glass, which would not be an expensive process, since the under glass is made to slide and could easily be removed. And indeed I have never found the obstruction of light any objection whatever where I have used two thicknesses. Our houses are large and light, so that the softening of the glare is a positive benefit. My experiments have been conducted, as the great majority of experiments are in this country, where a multiplicity of cares and various interests prevent careful comparisons. Yet I have been so impressed with the economy and advantages of double glazing, that we have had all our new structures, amounting to an acre of roof, constructed for double glazing. Only a part is as yet supplied with the inner sheet, but it is our intention to add it as we need. It may be of service to give a section of the sash bar which indicates the simple mode of construction.

The groove *b* in  which the under glass is to slide, is made *a* one-sixteenth of an inch deeper than the rabbet *a*, which is *b* of usual form for glazing. The work being done at the mill, the groove does not, in the slightest increase the cost of the work, as it is done with the same run as the rabbet; hence the only extra cost of double glazing is in the cost of thin glass and the labor of sliding it in from the top of the bar. This can be done from time to time after the house is in use. It occurs to me to add, that possibly a heavier sash bar might be required for double



glazing than would otherwise be used, and in that case the extra cost of stock would require to be taken into account.

### HOT-WATER BOILERS.

BY MR. JOHN ELLIS, WHITE PLAINS, N. Y.

With your permission, I propose to reason a little on the theory advanced by you in the February issue of the *Gardener's Monthly*, relating to the circulation of hot-water, its motive power, and the causes of imperfection in structures where this medium is employed. Should I differ in opinion from you in some points that I may advance, it originates from the fact that I see the matter in question in a different light, and also that I feel a great interest, as well as many of your readers, in getting at the positive truth. If I understand you correctly, Mr. Editor, your theory is that circulation through the pipes and from a boiler is solely dependent on the specific gravitation of the water, or the difference between the heated water and cold. All the authorities I have read on this subject entertain the same theory, including the English author Hood, who, I think, has written the most practical work. To open this question clearly, I take the ground that "cold water" is not the "active power in circulation." Let us now see where the "Pat Murphy" is, and whether the passive mortar ascending in the hod, and that ascending in the boiler are both on the same plan of passivity. I think that it is perfectly legitimate to say that the first particle of water that moves in a boiler in which there is fire, is that particle that has absorbed heat, and a particle of water cannot absorb heat without expanding, and where expansion occurs, is the *evidence of power and force*. What does this power and force in expansion do? Press against the non-expanded, and compel it to move up and down in all directions, until its *positive* power and heat becomes absorbed or given off. Now is there not some difference between the passive mortar going up the ladder in the hod on the shoulder of Pat Murphy and the heated particle ascending in the boiler? Can we say truthfully that the particle of water after receiving *power and force* from the agency of heat, is as passive as the sleepy mortar in Pat Murphy's hod? If water has the property to expand by the absorption of heat and thereby manifest a positive power and force, are these properties after being created, (I use this term figuratively) and brought into existence in the conditions found, to be of an illegitimate use?

If cold water were the motive power, these forces in question certainly could be of no use; the first thing in nature without a use.

"Hot-water ascends as the mortar does, and in no other way." This statement seems to me to entirely ignore the principles and properties of the real positive motive power heat, and gives all power to cold water. This seems to be qualified in the statement, "water, when warmed, does not ascend because it is the warmest, but that the cold water pushes it up." Now if I interpret this quotation correctly, in other words it means this; warm water has no inherent properties that will cause particles to ascend, but they are pushed up by some power inherent to cold. Now what is this power that pushes up cold water? We see from the statement that it has to be *pushed* up; that it is *pushed* up, is our belief, and that this pushing force is produced by and from heated particles of expanded water *behind* it.

Again, it is further stated that "water can be made to go along a level, or up or down, or any way, if only care be taken to get a good volume of cold water behind it." Now let us examine the "up and down" principle for a moment and see how this is. To illustrate, suppose a boiler to be set up in the garret of a house, and the flow pipe carried directly down into the cellar, and from there, by what is termed the return pipe, back, and up to the bottom of the boiler; how is it possible for the water to circulate on the theory alone of specific gravity, when it is self evident that the column of water in the so-called return pipe is so much heavier than that contained in the other? It certainly appears evident to my reasoning faculties, that if circulation is dependent alone on the pushing force of cold water, it would push both ways,—push up at the flow pipe warm water, as well as at the boiler warm water, for there is no law under the theory to prevent it, and if so, there would be a *statu quo* in the circulation. Now the common sense of this is, that if a body of water in a return pipe, the upper portion being cold and of course so much the heavier than the flow pipe, it must take some force to push it up into the boiler, for it seems evident that it cannot get there on the theory of specific gravitation. In the demonstration of this theory, we must look directly to first cause, and in the figurative illustration of Pat Murphy carrying up the mortar in the hod, you have shown the first cause in that particular case; but the simile is

not a just comparison as to the moving agency of water. Let us look a little more steadily at *first cause* in the boiler; the particles of water first heated, are those resting immediately on the iron surface presented to the hottest fire, they then move up. Was there any cold water under these particles to cause the upward movement, or did they move up through the agency of heat expanding them, and thereby giving them the power and force to pass up and through to the top of the boiler, where the specific gravitation of *all* the particles of water *at the top of the boiler, as well as that at the bottom of it*, including the end of return pipe, presented a *surrounding heavier weight*? We must not forget that, when the *first* particle of heated water moves up from the heated iron surface of a boiler, it has much weight against it at the top of the boiler as it has at the bottom of it, or at the point where the return pipe or pipes enter it. If we look calmly at this fact, we think it will become self-evident to any rational understanding that these particles of water first heated are the *first particles that do move*; and that they move themselves, in and of their own power, dependent on a property of their nature—absorbing heat and then becoming forcibly expanded by it. If then, the first particles of water move through, having a power to do so, (power by expansion) the following particles come under the same natural law, and instead of being a passive element, like the passive substance going up the ladder on the shoulders of a man; it really is the positive motive power causing circulation. If it were a truth, that the colder the water at the return pipe entering the boiler the better the circulation, what would be the use in trying to improve the heating capacity of boilers? The intention or design of improvements in boilers by their makers, is to heat a given number of feet of pipe in a shorter space of time than other boilers in use, and this fact can only be determined by ascertaining the amount of time it takes to bring the return pipe at the boiler to nearly the same temperature as the flow pipe at the top of the boiler, length of pipe and bore being the same in various boilers to be tested. Now if all our boilers in use, after driving their fires for half a day, had no better effect than the finding of the return pipe at the boilers *cold*, who could determine the superiority of one boiler from another; or where would be the use in trying for improvement if it be necessary to perfect circulation,

that the return pipe at the boiler must be cold? Rapid circulation is what we want through the boiler and pipes, and my experience in the matter has taught me that the *colder* the return pipe at the boiler is, the *slower* is the circulation, and *vice versa*.

I have endeavored to show in this article, that *cold* water is not the motive power in circulation, but on the contrary, that it is the expansive power that circulates water; and on these two questions rests the theory of construction of boilers with the practical results manifested of heat given off from a given surface of pipe; or in other words, one man purposes to heat one hundred thousand cubic feet of air in a glass structure with a boiler and a given number of feet of pipes, whose return pipe at the boiler shall be cold. Man the second, with his boiler and the same length of pipe, but possesses the power of heating the return pipe at the boiler to nearly the same temperature as the flow pipe, heats the body of air to a much higher temperature in a given time, whereas man the first could not effect the same result were he to fire up a whole year.

This is the difference that would result from the application of the two theories. Cold water, motive power of circulation, and Expansion the motive power of circulation.

Having, we fear encroached already too much on your valuable space, we are led to cry, halt! for the present, and say a little more next month on other points of the same subject, if deemed of use.

[We are not convinced by our correspondent's reasoning, but as he proposes to continue the subject in our next, we may think differently after reading his further remarks.—ED.]

---

### PEARS.

*An Address delivered before the P. F. Fruit Growers' Society, at Chambersburg, January 19th, 1871.*

BY E. SATTERTHWAIT, OF MONTGOMERY COUNTY, PENNA.

(Concluded.)

Before proceeding to consider the question of varieties, it would, perhaps, be better to say what I have to say, upon the relative merits of standard and dwarf trees. It will probably be recollected that I, years ago, before this Society, expressed my disbelief in the existence of dwarfs to any extent worth talking about; and I have since seen no reason to change this opinion. I long ago discovered that all my quince-rooted

trees, soon took to themselves pear roots, and abandoned the quince; and though there is probably a difference in soils in regard to it, my belief is that this will always be the case sooner or later, where they are planted as always recommended, with all of the quince stock below ground. Some varieties strike root sooner from the pear than others; the Bartletts, for instance, will root in a year or two. How pears would do, worked on the quince so high as to prevent them from getting pear roots, I do not know. I have never tried it, for the reason that it would be troublesome to save them from being killed by the quince borer, and I never had faith that they would live or thrive very long. A good deal has been said about keeping trees dwarf by root-pruning and other such appliances, but I presume this is not much practised in this country, nor will it be, at least till we get a plentiful supply of Coolies, or some other system of cheap labor. It will be seen from what I have said, that I do not make much account of dwarfs, and in treating of varieties, I would be understood as speaking entirely in reference to trees on pear roots. And here I would remark, that I do not find, in my own experience, the difference that I was led to suppose there would be, in some varieties, when grown on the pear or quince.

I do not wish to be understood from what I have said, as wishing to discourage the planting of quince-rooted pear trees. On the contrary, I think it a very good way of getting standard trees: the habit of bearing they acquire when on the quince, seems to stick to them for some time, and is an advantage, where it is considered more of an object to have a few pears soon, than it is to get trees a few years later large enough to bear a great many.

I have thought these remarks on the subject of dwarfs proper, in order to put planters on their guard against the mistake that I was led into myself, of planting quince-rooted pear trees too close, under the mistaken idea that they would never get large. I give it as my deliberate opinion, though I know it is not generally admitted, that pears on quince stocks will, in a few years, if they live at all, be found to have nothing but pear roots, and then, if the ground is good enough to grow pears, they cannot be kept dwarfed, without a great deal more labor than will be likely to be bestowed on them. So that very close planting, less than fifteen or twenty feet should not be practised, unless it is

done with the intention of thinning out in a few years.

An interesting question here occurs to me, which would seem to have an important bearing upon the relative merits of pear or quince-rooted trees; and that is, whether there is an advantage or otherwise in having the cultivated varieties of pears on their own roots, or on the roots of wildlings, as is the case with all standard trees as they come from the nursery. I am unable to throw any light on this question, and it is one that I have never heard discussed. There is at least one disadvantage in the wild stock, and that is its tendency to sucker, which is often troublesome. It might seem probable that the wild seedlings used for stocks would be more hardy and make more thrifty and longer-lived trees, but I do not know that there is anything in this. I have never yet observed any difference either in vigor or hardihood.

I now come to consider the most important branch of my subject: the selection of varieties. Unfortunately, this question is as difficult as it is important. So much has already been said and written upon this question of varieties, that I should feel like skipping it altogether, if it was not that I believe that very many of the opinions that have been put forth on the subject, have not been derived from observation and experience sufficient for so difficult a question. It is very common to hear the most decided opinions on this subject, urged by those who have had no experience worth mentioning. For my own part, I must confess, that I feel that my experience is entirely too limited to speak upon it with much confidence.

In considering this subject, it must be borne in mind, that varieties vary very much with soil and location, and from this cause alone it is impossible to lay down any positive rule. And then there are few localities where many of the numerous known varieties have as yet been fairly tested. From my own experience, extending over about a dozen years, and with about six hundred varieties, I have come to the conclusion, that the most skilled and experienced have much to learn on this subject. And it seems to me that the proper course in treating of varieties, unless one has had far more experience than I have, is to simply state the results of their own observations, with varieties that they have tested, without recommending any. And this is what I propose to do.

In giving my estimate of a variety, I confess

that I am governed to some extent by its value as a market fruit. I do not consider any apology necessary for this, though I know that it is strongly objected to by some. I will say, however, that as it has always been my practice to attend personally to the sale of my own fruit in the market; I have had the best possible opportunity of judging of the value of the different varieties for this purpose: and though I am aware it is very distasteful to some, to recommend a fruit because of its value as a saleable commodity, yet knowing that there are many situated like myself, who follow fruit growing, in part, for a livelihood, and who might be benefited by my experience, I do not feel at liberty to withhold it. And I will here state what, in my opinion, are the desirable properties in a pear for a market fruit. These are, good color, size and flavor, and above all, it should keep well. I have placed color first, for without this no fruit is of much value for market. A handsomely colored pear of medium quality, is much more valuable for market purposes than one of first quality that has no beauty of color. Size is of great importance in estimating the value of a fruit for market, not only because large fruit sells better than small, but the time spent in handling small sized fruit is a serious drawback. There are many pears of first rate quality in other respects, that seem to rot the moment they are ripe, these are of course worthless for market purposes.

In giving my experience with different varieties, I do not propose to tire your patience by going over a very long list, but shall confine myself to those that are most generally known and recommended, and to such others, as I have found upon trial to be worthy of particular notice.

There are a few varieties of indisputable excellence, that are so well known as to need no comments, and are justly considered indispensable in every collection. These are Bartlett, Seckel, Lawrence, Duchesse d'Angouleme and Beurre d'Anjou. And since they cover the greater part of the pear season, and are found to do well in most situations, the question will naturally be asked, why not stop here? since, to multiply varieties unnecessarily, only makes confusion and trouble. Mr. Quinn, in his "Pear Culture for Profit," names these and one or two others, and argues strongly against increasing the number of varieties. While I admit the force of the objection, I must contend that I have

found advantages in having a much larger number, and this for several reasons. In the first place, we want early pears, ripening before the Bartlett; and as summer pears last but a short time, it takes several varieties to fill up the season. I do not agree with Mr. Quinn, that early pears are of not much account for market. This may be the case, where they have to be sent a long distance; but I have found a number of the early sorts quite profitable. The worst time to sell pears, I find, is just when Bartletts are in season, for it is then that peaches, melons, grapes and other fruits are most abundant.

Another advantage in having a number of varieties, is, that it seems to be the only way to insure a supply every year; for as the most productive are liable to fail in some seasons, by having only a few sorts, you may miss a crop entirely.

Another advantage, I think, I have gained by testing a great many sorts, is, that I have discovered, by that means several varieties, not much known, that I think will prove more valuable to me, than the most of those that are universally recommended. And besides all this, there is a satisfaction in having a number of sorts to suit all tastes; "variety is the spice of life," and there is as much difference in the flavor of pears as there is in their shape and appearance, no two being alike.

I propose now to take up the list in the order of their ripening: commencing with the earliest, and treating first of the leading, well-known varieties:

Doyenne d'Ete—generally does well; it is of a fine color, good quality and productive, but small and sometimes cracks.

Madeleine—fair size and quality and productive, but does not commonly color well, and soon rots.

Beurre Giffard—one of the very finest of early pears, fine size, first-rate quality and productive, and colors beautifully, but sometimes cracks badly.

Osband's Summer—does well, good color, fair quality and productive.

Manning's Elizabeth—rather small, but first-rate in every other respect, very productive and profitable.

Ott's Seedling—variable in quality, sometimes equal to Seckel, fair color, but rather small, a splendid grower.

Dearborn's Seedling—fine color, fair quality and productive, but too small.

Early Catharine—valuable on account of its vigor and productiveness and good quality.

Rostiezer—productive, but of little value for market on account of its poor color and tendency to rot.

Bloodgood—fair color, size and flavor, productive, but a poor grower.

Julienne—has proven one of the most valuable of early pears, a regular and good bearer, fair quality and size, colors most beautifully and keeps well.

Tyson—fine size and color, and of the very best quality, but a very poor bearer.

Kirtland—a beautiful russet color, fair size and quality, productive, and a splendid grower.

Of most of the above named I have had a number of trees in bearing for several years; and will now mention a few others, which promise well so far as can be judged from two or three trees of a kind:

Pendleton's Early York—very early, handsome and good.

Pulsifer—fine color and size, handsome, productive and good.

Jefferson—large and handsome, fair quality.

Muskingum—fine color and size, handsome, productive and good.

Beurre Benoist—A most beautiful and good pear of fair size, would seem to be valuable.

Hull—medium size, fair color, good quality and productive.

The above all ripen before the first of September, and are mostly gone before the market is glutted with peaches, melons, and grapes, and on that account are more valuable than they would be a few weeks later.

We next come to a season comprising the last few days in August, and the first half of September, when varieties of good pears are so numerous, and peaches and other fruit generally so plentiful that none but the very best are of much account. This is the season of the Bartlett, and it must be a very fine fruit indeed that can compete with it; and, as a consequence, there are many good varieties ripening about this time that are hardly worth mentioning, and I will notice only the most prominent, commencing with the earliest, which ripen about the first of September:

Ananas d'Ete—a fine, large and beautifully colored pear, of good quality; valuable.

Andrews—fine size and color, fair quality, but rots too soon.

Cushing—beautiful light lemon color, medium

size, first-rate quality; productive and valuable.

Golden Beurre of Bilboa—a most beautiful and first-rate pear in every respect, but the tree appears to be tender and does not thrive.

Doyenne Boussock—this would be a first-rate pear, but it rots so quickly as to be utterly worthless. [Note.—This is one of Mr. Quinn's select few, one of six, I think].

Beurre d'Amanlis—poor color, medium quality, and rots quickly.

Belle Lucrative—good size, of the best quality, and exceedingly productive, but does not often color well; and on that account not a valuable market fruit.

Bartlett—of course, stands at the head of the list in its season; being first rate in every respect, though its peculiar flavor is not liked by every one; and, with me, the tree has proved more tender than most other varieties.

Steven's Genessee—not satisfactory; tree not thrifty.

Flemish Beauty—a splendid large pear of the very best quality, but does not commonly color well, and rots very quickly; the tree, although a very vigorous grower, one of the worst to shed its leaves prematurely.

Ananas, or Henry IV—an insignificant little green pear of no account.

Washington—a beautiful and first-rate pear, but the tree appears to be tender, and does not thrive well.

Onondaga, or Swan's Orange—a very large and showy pear of medium quality; very productive, but rots badly.

Howell—a very productive and very beautiful pear, of fair quality; a profitable variety.

White Doyenne—always cracks.

Kingsessing—a fine large pear, of excellent quality, but does not often color well; a splendid grower.

Beurre Capiaumont—a very beautiful and productive pear, of poor quality.

Des Nonnes—an exceedingly productive and excellent pear, of medium size; does not often color well.

Marie Louise—a fine, large and very productive pear, of good quality, and sometimes colors beautifully.

I have given my experience in the above-named sorts, because they are amongst the varieties that are most recommended in the books and nursery catalogues; and as I cultivate most of them largely, I have had good opportunity to judge of their merits. I will now mention a few

that ripen about the same time, that are not so common, but which seem to do remarkably well, so far as I can judge from a few trees only of a sort :

Boston, or Pinneo—very fine ; like Golden Beurre, but a more thrifty tree

Clapp's Favorite—I consider this quite an acquisition ; it is a splendid large pear of the best quality, and colors even better than the Bartlett, having a beautiful red cheek ; it has, however, a bad fault, it rots too soon.

Ananas de Courtrai—a fine, large and most beautiful pear, of good quality, and a regular bearer ; would seem to be valuable.

Apothecary—a very large and showy pear.

Gerhard's Butter—a large and very handsome pear, good quality, and productive.

Wredow—a remarkably handsome and good pear, but an unthrifty tree.

Westcott—a handsome, good and very productive pear ; fair quality, medium size.

Beurre de Montgeron, or new Frederick of Wurtemberg—the few trees I have of this variety, have proved the most valuable of any that I have. It is the most beautiful pear I ever saw ; size from medium to large ; quality generally good ; most remarkable for coloring uniformly, with a brilliant red cheek, and remaining this way on the tree for weeks, a most beautiful sight. It has always proved to be a regular and good bearer, and an excellent keeper, after it has colored ; tree thrifty and vigorous. A large dish of this variety that I had on exhibition last fall, at the exhibition of the Pennsylvania Horticultural Society, attracted more attention, and was more admired than any, out of three hundred varieties I had on exhibition. Its season is a little later than the Bartlett.

We next come to a season comprising the latter part of September and the remaining fall months, when pears are far more valuable than they are at the height of the peach and melon season

Seckel—stands at the head of the list at this season, on account of its remarkably high flavor. It unquestionably has no superior in this respect. It is not, however, a very valuable market fruit, on account of its small size and generally poor color, and tendency to rot before ripening.

Louise Bonne de Jersey—has not proved satisfactory ; it bears abundantly, but is often of poor quality, and sometimes cracks.

Buffam—a very productive and profitable va-

riety ; the tree is remarkable for its vigor and beauty of growth, though rather small and not of the highest flavor, its fine color and productiveness make it a valuable fruit for market purposes.

Urbaniste—has generally proved good in every respect.

Duchesse d'Angouleme—does wonderfully well some seasons, but has not proved a regular bearer, probably from being allowed to overbear. [Note.—I think it would pay well to thin out the fruit of this, and perhaps also of many other varieties, when the trees are overloaded].

Beurre Diel—has not proved satisfactory ; it is sometimes first-rate, but generally of a poor color, and sometimes cracks.

Dix—remarkable for being the only sort out of five or six hundred that never bears. I have a number of quite large trees of this variety, one of them more than twenty years old, and nine inches in diameter, and they have never borne a dozen pears.

Napoleon—very productive ; of a good color, but often spoiled by being spotted with a sort of mildew.

Oswego Beurre—productive, but often cracks.

Beurre Superfin—a splendid large pear, of excellent quality, but does not often color well, and rots too soon ; tree a very handsome grower.

Sheldon—generally does well ; productive and good but sometimes cracks.

Beurre Bosc—A very fine, large, handsome, productive and good pear ; one of those sub-acid pears that are preferred by many. It seems to have one fault, however, that I think is common to all dark russet pears, that of rotting badly before ripening.

Paradise d'Automne—very like Beurre Bosc, but smaller, and seems to be no better in any respect.

Beurre d'Anjou—has proved first-rate with me in every respect ; I consider it one of the most valuable of all pears.

Beurre Clairgeau—a very large, showy and productive pear, of poor quality, and very liable to be spotted with mildew, and often drops prematurely from the tree. [Note.—Another one of Mr. Quinn's pet varieties].

Some of the above varieties will sometimes keep half through the winter. They are all from among the sorts in common cultivation, and such as I grow largely. I will now name a few others ripening at the same season, that are not so well known, but have proved valuable

with me. I have not, however, grown many of them extensively :

Doyenne de Fais—exceedingly productive, good quality, valuable for keeping long after it has become yellow.

Doyenne Rose—a beautiful and productive pear, also keeps well after it has colored.

Oswego Incomparable—a fine large and beautiful fruit, keeps well after it has colored ; tree a splendid grower.

St. Michael Archange—a large, handsome and good pear ; tree a most beautiful, erect and vigorous grower.

Baronne de Melo—a very handsome, dark russet pear of good quality and productive.

Philip Goes—very like the preceding.

Beze de Quassoï d'Ete—a beautiful and very productive pear, good size and first-rate quality, appears to be quite a valuable variety.

Surpasse Virgalieu—almost equal to White Doyenne, and does not crack.

Butter—a splendid, large and exceedingly productive pear of first-rate quality, very remarkable for bearing enormous crops from the time the tree is first planted, and the tree all the time making the most vigorous growth. It is also an excellent keeper. I consider this a fruit of great promise.

We come now to winter pears. Not having paid as much attention to the ripening of these as I might have done, I do not remember but a few varieties that I think worth mentioning here. I have quite a number, however, on trial, some of which, I am in hopes, will prove valuable.

Lawrence—without dispute stands at the head of the list of early winter pears, and probably taking all things into account it is the most valuable of all pears. It is not, however, a late keeper, and frequently commences to ripen the first of October. It has done with me exceedingly well.

Winter Nelis—a good early winter pear, does not keep late.

Doyenne d'Alencon—very productive and sometimes very good.

Vicar of Winkfield—very productive and valuable as a market pear for cooking ; has never been anything more than that with me.

Glout Moreceau—sometimes first-rate, does not often do well, a splendid growing tree.

Easter Beurre—productive and sometimes very good, but does not generally ripen well.

I shall not trespass farther on your time, by

extending this list, though I might have mentioned many others that I have on trial, that I consider well worthy of attention, quite a number of them having done better for me than the majority of those on the lists generally recommended for cultivation.

If I had been writing a book instead of only an essay, I should have treated this branch of my subject with more minuteness and at much greater length. But knowing how exceedingly tiresome and uninteresting these dry details must be to all but the very few who, like myself, have made this a specialty, I feel that I owe an apology already for having extended my remarks beyond the limits proper for an occasion like this ; and I shall, therefore, be compelled to omit a number of minor topics, and some of more importance, such as planting, pruning, gathering, ripening and marketing the fruit, all of which would be interesting in a more extended treatise.

Before concluding, however, I desire to reiterate, that it was not intended that the foregoing remarks should be taken for anything more than what they really are, the views and opinions of a single individual. In preparing them I have consulted with no person, and have looked into no books or authorities on the subject ; had I done so, I could have compiled a treatise that would, doubtless, have been entitled to more weight and consideration. But I did not suppose that that was what was required of me. I understood my instructions to be, “to give my views on the subject ;” and what I have done, is, at least, as far as it goes, emphatically just this, “what I know about pears ;” and for that let it be taken.

One word more in conclusion, in regard to the general subject of pomology. At the commencement of my remarks, I hinted at the difficulties there were to contend with in the advancement of this science ; and while it is undeniable that in our attempts to investigate the hidden secrets of nature in this direction, we are met at every step by the most discouraging obstacles ; that those of us who consider ourselves the most practical and the least likely to be carried away by subtle and plausible theories, find ourselves constantly at fault, and often compelled to turn back and take a new departure. But while admitting all this, I do not wish to be understood as taking a discouraging view of the situation. On the contrary, I see much to encourage and stimulate us to future efforts. That pomological

science is making rapid progress, in spite of all obstacles, does not admit of a doubt. (But I should be traveling entirely out of my province to speak of that here.) It is these very difficulties, when viewed in their proper light, that are in reality the greatest stimulus to exertion. It is wisely ordered, that the road to success in every useful and laudable pursuit, is beset with difficulties; if it were not so, there would be little to stimulate to that exertion and industry which develops the higher and nobler qualities of our nature; the ignorant and the slothful would be equally successful with the industrious and the skillful.

Pomology is so far from being a perfect science, that those who have made the greatest progress in it must admit that they are only beginning to see how much there is to learn. There is then every inducement to persevere in the good work, and if we do this properly, and are actuated by motives that are higher than merely selfish considerations, and in that spirit that loves the truth for its own sake, and above everything else, we will surely have our reward; and not only will these meetings continue to be an annual source of agreeable recreation and pleasant social enjoyment, but we will have the far greater satisfaction of beholding our efforts successful in assisting in the advancement of a science which is behind no other in practical usefulness and in the benefits it confers in improving the health and happiness of our race.

#### MALE FLOWERS ON THE EAR OF CORN.

BY PROF. HENRY SHIMER, MT. CARROLL, ILLS.

The Editors of the *American Naturalist*, page 125, in the April number, have mentioned this phenomenon as being so rare that they would like to see specimens. It then occurred to me as not very rare, and that I had frequently observed it from a youth up; and I presume the same is true of everybody who has ever husked corn on a farm. I asked an intelligent farmer if he had ever noticed the corn tassel on the ear, he replied often, and turning to his son of 11 or 12 years standing by, said I guess that boy has noticed it; the boy replied that he had frequently seen it, sometimes so long, holding his hands 6 inches apart.

In August, while we were gathering and drying about an acre of sweet corn, I observed great numbers of spikes of male flowers on the end of the ear, perhaps hundreds of them, comparing well in numbers with the ears on the stami-

nate spike (?) in the same patch. It is usually a single spike of flowers from one to six inches long, being a prolongation of the receptacle or "cob," and may be produced by an arrest in development, or by any cause that weakens the extremity of the cob, so that it transforms its usual habit, and develops male instead of female flowers.

Mr. Meehan, (Proceedings of the Academy of Natural Sciences of Philadelphia, 1870, page 71 and 72,) has shown that in certain docks the male flowers gradually increase with the weakening of axils, until only male flowers were produced at the end of the racemes; and that in coniferous plants female flowers are only born on strong vigorous shoots, and that "these vigorous shoots would in time be crowded and weakened by shade, when they would cease to bear female and produce male flowers only."

If weakness was the cause of this unusual prolific development of abnormal or misplaced organs, what were the weakening causes in this instance? I can observe, four. First, the seed was old—3 or 4 years old. Second, the corn was planted entirely too thick. Third, the season was very dry, unusually dry. Fourth, the cultivation was not entirely perfect, a great deal of fox-tail grass grew among it. The ground was well manured as a counteracting cause.

On the page of the *Naturalist* above alluded to, Mr. D. Milliken believes that after rains in a dry summer, plants make haste to produce new organs, regardless of all order and harmony. But it becomes us ever to bear in mind, that law and order is the rule in every department of nature, and when we behold a departure from the usual course of things, we may also see in that the beauty of Divine law, if we are only wise enough to search it out. In this case, the theory of Mr. Meehan, in my judgement, is more applicable and consistent with the laws of nature than that of Millikin.

From the specimens before me, I sometimes find perfect grains scattered here and there along the spike among the male flowers. The male flowers in other instances are mingled among the grains on the last inch of the well formed ear, the power of development being about equally divided between the male and female forces; and on this ear is a very robust spike of male flowers about two inches long. Sometimes at the end of a spike of male flowers five or six inches long, a small receptacle of imperfect female flowers



appears, but seldom develops grain, or this occurs at the middle of the spike; sometimes the spike of male flowers springs from the side of the ear at the base. More than all this, I sometimes find all the grains of an ear developed into long membranous tubes like the blades of the husk with the edges joined, proving that even the grains are but modified leaves.

Mr. Milliken, I think, might more safely conclude that abortive ears are more frequently produced through lack of fertilization of the pistil on account of isolation; a lateness in the development of the ear, it appearing only after the male flowers had all shed their pollen; than to refer it to any hasty, irregular or ungoverned action on the part of the plant itself.

I herewith enclose you a few short spikes of male flowers that I have broken from the ears, and will gladly send you the ears with the spikes on if I can find a convenient way.

#### MANURES OR PLANT FOOD.

BY MR. JACOB STAUFFER, LANCASTER, PA.

The two important elements in the food of plants, are carbon and nitrogen derived from the atmosphere, the other elements are found in water, oxygen and hydrogen.

The dark substance called *humus*, is the final result of the decomposition of animal and vegetable matters. It forms an important manure or element of plant food, and where abundant, constitutes a rich soil. This humus is rich in carbonic acid and ammonia. These two are the sources of nitrogen and carbon, for the supply of plants, and are produced in immense quantities on the globe, and diffused through the atmosphere.

There is a law of proportions in the combination of one element, with that of another; thus, carbonic acid, a compound, is always composed of 16 parts of oxygen, with 6 of carbon, by weight. Ammonia always contains 3 of hydrogen and 14 of nitrogen. Water, oxygen 8, hydrogen 1. Carbonic acid, ammonia, and water, are believed to constitute the food of plants, containing an excess of oxygen, which is set free to restore the balance necessary for animal life, as the great supporter of respiration.

Thus plants elaborate the various products. Some compounds are rich in carbon and hydrogen, but devoid of nitrogen, such as starch, gum, sugar and the various fatty matters; while others are rich in nitrogen, such as the albumen, fibrine

and casien. These compounds drawn from the atmosphere through the mediation of plants, are for the service of animals by which their corporal frames are built up, so that in one sense, man "*lives upon the air.*" But as Schleiden observes, in connection with this subject, on the combustion so-called in the respiratory process, for the maintenance of the necessary heat: "But from these slow *invisible flames*, there rises a new-born Phoenix, the immortal soul, into regions where our science has no longer any value." I quote this here, since I find modern scientists prone to preach up materiality in such a manner, as if spiritual relations between the creature and creator was a myth and a mental delusion. All is chemical action, say they, and the growth and decay of tree or animal without exception. Man, himself, it is argued by such, is only a developed monkey, in like manner as some of your choice apples were only crab, originally, etc. But to my subject. Humus is considered a most valuable element of soils, being carbon in a state of minute division, and almost indestructible; its important action is to absorb water and retain it for the use of the plants. The carbonic acid and the ammonia from the air, this combination of gaseous matters constitute this humus into a *food bearer*, the store-house to supply the plant as circumstances demand its use.

There are also mineral elements wanted that do not come from the atmosphere, but from the soil; each peculiar class of plants demands certain peculiar accessory food. Liebig (a good authority) tells us that wheat does not flourish on soils that are rich in pure vegetable mould, because this plant needs *Silex* as an element necessary to its healthy constitution, and without which indeed it cannot exist. This substance it does not find in vegetable mould. By burning plants, the organic elements are dissipated by forming gaseous compounds that escape, while the ashes remaining are found composed of lime, silex, soda and potash, salt, bone-earth, gypsum, &c., substances that are not vitalized; each class produces a different composition of uniform mineral constituents, all things equal, so as to determine the specific plant subjected to the ordeal.

It must be remembered that the efficacy of manures lies in the inorganic constituents; and startling as it seems, it is essentially different, whether we convey manure to the field or burn it first and strew the ashes on the soil, since its efficacy is dependent solely on the constitution

of the ashes, if we admit that manure is plant food, though the mechanical effect of some kinds of manure would not be had by their ashes alone.

The feeding of stock for the sake of making barn-yard manure, and its application to the soil, guided by experience, is well enough; but science demands some attention not to rob the soil of some necessary elements which is not returned to it, and which is essential to the perfect development. Large exposed manure heaps lose much by fermenting,—the best or volatile portions are dissipated in the air. Heaped up during summer, the ammonia which wasted from the manure can be chemically fixed or rendered non-volatile, by making a compost of loam, sods, road-scrappings, swamp-muck, etc., and to apply gypsum to the mass whenever they could detect ammonia escaping from it. Some cover their heaps of manure by sheds, and even supply pumps to return the drainings from a well back upon the pile; thus the manure is greatly improved, the woody fibres decomposed, and many seeds of noxious weeds lose their vitality. A compost, half loam and half peat, is thought better, load for load, than fresh yard manure.

We may divide vegetables into four classes, according to Leibig, as one or the other of the important inorganic elements predominates in the ashes.

1st. *Alkali plants*, those that contain double alkaline salts, such as beets, potatoes and the vine.

2d. *Lime plants*, containing lime and magnesia, as clover, peas, beans, etc.

3d. *Siliceous plants*, those containing siliceous, wheat and the grasses.

4th. *Phosphorous plants*, those containing the phosphates, also wheat, corn, rye, oats, etc., in short the cereals and fruits.

With these guides understood and considering all manures as plant food, with the stimulus of heat, light and perhaps electricity, we may have some basis to exercise our judgement upon what may be the most conducive to producing good results.

It will be our duty first to ascertain the chemical character of the whole of the plant to be fed or manured; in other words, the crop to be grown: then whether the soil upon which we intend to sow the seed contains the needed inorganic elements for said crop; if deficient, let it be supplied at once, guarding against excess. It is well also to ascertain whether there may be

an excess of alkaline earth in a caustic state, that may prove injurious to certain plants. Lime is soon neutralized by exposure to the air, hence the needful constituents demanded by the vegetable is a matter of serious consideration. In the application of manures of any of the various kinds, care should be exercised to have these well incorporated, and when mingled with common soil, they can be more regularly distributed, especially such as guano, boiled or ground bones, oil-cake, poudrette, etc.

As to the application of barn manure, whether fresh or green, or well fermented and composted, much depends upon the character of the soil and upon the nature of the crop. For corn, potatoes and other field crops, apply it green and in the spring, especially on clayey soils. For gooseberries, currants, shrubby, etc., as a mulch on the top of the freshly dressed soil, in the fall is better than in the spring of the year. So with grass lands, without regard to the moon's phase—gardens, vineyards and the like, where the soil needs not the disintegrating influence of decaying vegetable fibre, and to avoid introducing weeds. The manure thoroughly fermented and intimately incorporated with the soil and in close proximity to the roots. Manure, during fermentation, loses ammonia, which is great; let it be understood, that the soil is so wonderfully constituted as to absorb and retain all the plant food contained in the manure, and that the rains do, in no wise leach it out, but remains fixed in the soil ready for supplying the roots of plants. This wonderful plan of Divine wisdom, Baron Leibig announces thus: "There is not to be found in chemistry a more wonderful phenomenon, or one which more confounds all human wisdom, than is presented by the soil of a garden or field. By the simplest experiment, any one may satisfy himself that rain water, filtered through a garden or field, does not dissolve out a trace of potash, silicic acid, ammonia or phosphoric acid. The soil does not give up to the water one particle of the food of plants which it contains. The most continuous rain cannot remove from the field, except mechanically, any of the essential constituents of its fertility. The soil not only retains, firmly, all the food of the plants, which is actually in it, but its power to preserve all that may be useful to them extends further. If rain or other water, holding in solution ammonia, potash, phosphoric and silicic acids, be brought in contact with the soil, these

substances disappear almost immediately from the solution; the soil draws them from the water. Only such substances are completely withdrawn by the soil as are indispensable articles of food for plants, all others remain wholly or part in solution.

If a funnel be filled with soil, and a dilute solution of silicate of potash be poured upon it, there will not be found in the filtered water a trace of potash, and, only under certain circumstances, silicic acid. If freshly precipitated phosphate of lime or phosphate of magnesia be dissolved in water saturated with carbonic acid, and filtered in like manure through soil, there will not be found a trace of phosphoric acid in the filtered water. So also with phosphate of lime in diluted sulphuric acid, or of phosphate of magnesia and ammonia in carbonic acid water. The phosphoric acid in each case remains in the soil. Charcoal reacts in a similar manner with many soluble salts—by chemical attraction acting from its surface, in which the constituents of the soil perform their part.

This wonderful property found to exist in the soil, only in reference to such substances required for plant food, is such an evidence of the goodness and wisdom of God, as to excite our adoration. Every reflecting mind must see the value of these interesting facts in an agricultural point of view.

Clay is well known for possessing, in a high degree, the absorbent and purifying properties in earthen closets, and for absorbing the properties of liquid manure; and for arresting the escape of ammoniacal vapors, it is of great value. Thus soil may be saturated, and form the very best manure.

It is a mistake to suppose that all plant food must be reduced to a liquid state, in order that the rootlets (spongioles) should be able to appropriate them. Water is indeed essential as a solvent. But Liebig contends that the roots have the power of taking in these matters without their previous solution, and adds, 'these substances are present in the soil, in a condition fit for absorption by the rootlets of the plants, though not themselves soluble or removable by the rain water, until the soil is saturated with them. It is more than probable that the majority of our cultivated plants receive their nourishment directly from these portions of the soil which are in immediate contact with the root-

let, and that they die when their food is presented to them in solution. The action of *concentrated* manures burning the young plants, seems to support this supposition." The plants themselves, in the absorption of their food, select from the soil those substances which they require, by and through the co-operation of a cause, which resides in the capillary attraction and the rootlets. Plants, as organized living structures, are yet not fully comprehended in their intricate yet simple functions.

In presenting the foregoing, I claim no originality, but deem the facts set forth of such value, that they cannot be repeated too often, nor be too widely spread for the benefit of a large class of intelligent and progressive farmers.

### BOILERS.

BY A. L. PENNOCK, PHILAD'A.

Being a "Boiler man," your article on hot-water boilers particularly attracted my attention; but not agreeing with your conclusions as expressed in the *Monthly*, I give my reasons. So far as I am acquainted, all persons who make a business of putting up hot-water apparatus, understand that the greater weight of the cold water displaces the hot, and causes circulation; and because the circulation is so caused, your maxim, taken literally, "Look after the cold water pipes and the flow will take care of itself;" will not answer. The flow pipes require more care in setting than the return pipes, because they are under less pressure, and in nine cases out of ten, where the water does not circulate properly, the trouble is in the flow.

Last season I put up a boiler heating 3500 feet of 4 inch pipes, which worked admirably, but during the summer, the ground under the flow settled, and on firing up for winter, three of the houses were not heated. We raised the flow, and all went right again. On another occasion, where the pipes dipped under a road, the water stopped circulating, on account of air which a little dirt in the air cock of the flow prevented from escaping. Again, where there was an elevation in the flow, and the water was allowed to get too low, the circulation was stopped, and upon filling up the water, the return pipes acted as flows, and continued to do so for several days, until the fire was put out, when the circulation ceased, and the cold water settled to the lowest part, and on firing up, the water circulated properly again. I could give a number of instances

of trouble from the flow pipes, but have never yet seen difficulty (although such a case could readily be) where the cold water pipes alone were the cause. As you say, "water may be made to go along a level or up or down," and upon that idea my first boilers were constructed; but I have taken them all down. Experience has also taught me that the flow should rise to its ex-

tremity without a depression, and to a great extent the return should follow the same rule. I believe it to be the most satisfactory plan.

I should not have noticed the article in any other magazine, but I consider the *Monthly* the Horticultural Journal of America, and desire that the fullest experience shall be given for the benefit of its large circle of readers.

## EDITORIAL.

### EMBRYONIC INARCHING.

Some years ago, we regarded the idea that two cells of distinct kinds would unite and form a third variety, as a fable. Thus, when Mr. Blodgett represented that his sweet and sour apple resulted from an union of buds in grafting, we dissented. It was not that we doubted that the experiments were made as represented, but that we thought the results obtained were due to other laws than that of cell union; and that the manner in which the two buds were united, in the one budding operation, had nothing to do with the case. It has always been our custom, however, not to feel too sure that our own notions of things are right, and in this spirit, though starting with the idea of this cell union being impossible, we have looked about to see what the wild waves of nature are saying about the question; and gradually we have been brought to believe that this cell union, and consequent production of new forms, is not the absurd thing we once thought it was.

The writer of this has at various times called the attention of scientific institutions to facts which cannot be explained in any other way, than that the appearances were due to Embryonic inarching. This has gradually taken shape, until with similar observations in Europe, both prior and subsequent to his own, we think the point is fully established; and the great point contended for by Mr. Blodgett is gained, namely, the perfect possibility of the fruit production for which he contends.

Some of the remarks of the writer before the Academy of Natural Sciences of Philadelphia, have been the occasion of other valuable notes in addition by the Editor of the London *Gardener's*

*Chronicle* and one of its correspondents. As it will, no doubt, interest a large number of our readers, we give the paragraphs in full:

"In a previous number (p. 104) we reprinted some observations of Mr. Meehan's on the subject of Embryonic Inarching, a point of some interest horticulturally, as certain anomalous "mixed products," as a chemist would call them, have been supposed to have originated in such a manner. In reference to the same subject we have received, through the courtesy of an unknown correspondent, the following extract from the *Friends' Intelligencer*, accompanied by a specimen, on which we shall make some comment further on:

'At the last meeting of the Academy of Natural Sciences, Thomas Meehan exhibited several specimens of the *Maclura aurantiaca*, the common Osage Orange, in which the plants were inarched together in pairs in a remarkable way. He said:—The Osage Orange was extensively grown as a hedge plant, and in digging up the one-year plants these united twins were usually found in the proportion of about one score in ten thousand. Double kernels were common occurrences in many seeds. There were double Peaches and Almonds, but these had their separate seed covering or membrane, consequently the separate embryos produced distinct plants. But these indicated that there had been two separate embryos under one seed covering, and that the radicular portions of this double embryo, having no membrane to separate them, had inarched themselves together while passing to the ground. If this were the true explanation, he thought there was no such case recorded. That it was true seemed probable from the fac-

that all the specimens were united in exactly the same manner, showing that time, place, and the circumstances of the union were uniformly the same. The scars showed that there were four cotyledons and two germs, and that the place of union was midway between the pairs of cotyledons. From the base of the cotyledons, extending the whole length of the radicle, the union existed. The length of this united part was from half an inch to an inch, according to the vigor of the plant. Another lesson, he thought, was afforded by these specimens. Dr. Asa Gray had recently remarked in "Silliman's Journal," that European botanists still believed what American botanists had learned to doubt, that the radicle was a true root rather than a morphologized point of stem. Here was, he believed, an illustration of the American view. These radicles, which had evidently united together under the seed coat, had elongated after protrusion, just as a young shoot, with all its parts formed in the bud, elongates after the bursting of the bud scales. They comprised the half inch, or inch united portions referred to. If these radicular portions of the seed were of the nature of root rather than of stem, we might expect to see lateral fibres push from them as we see do from the true roots which start out below the union. But these parts are as free from rootlets as any portion of the true stems above the cotyledon points, indicating, as has been suggested, that their properties were rather of stem than of root. *S. R. R.*

"The double Almonds and Peaches referred to by Mr. Meehan are of course due to the development of two ovules or two seeds in place of one; but in the case of the Osage Orange, as we understand it, two embryo plants were produced in one and the same ovule. This, though assuredly unusual, is yet easily intelligible, from the fact that under ordinary circumstances there are several germinal vesicles in the same embryo-sac, though usually only one of these vesicles becomes fertilized and developed into a new plant. Plurality of embryos in the same seed has been noticed in several genera, and is indeed frequent in the seeds of the Orange. Several such instances are recorded in Dr. Masters' work on 'Vegetable Teratology,' wherein instances of the adhesion of the double embryos so produced are alluded to, though Mr. Meehan seems to have overlooked them, in particular one case cited by Mr. Thwaites, 'wherein two embryos were contained in one seed of a Fuchsia, and

had become adherent. What is still more remarkable, the two embryos were different, a circumstance attributable to their hybrid origin the seed containing them being the result of the fertilization of *Fuchsia coccinea* (Hort.), *i. e.*, *magellanica*, by the pollen of *F. fulgens*.' This last is a very important fact for horticultural trust as bearing on the question of graft hybridization, Potato grafting, and the like, while it affords confirmation of the much doubted 'Trifacial Orange,' produced as is affirmed by causing the seeds of the Citron, the Orange, and the Lime to adhere together. 'The fruit produced by this tree exhibits three distinct species included in one rind, the division being perfectly visible externally, and the flavor of each compartment as different as if it had grown on a separate tree.' The specimen kindly forwarded us by our correspondent, consists of two seedling plants of the Osage Orange, free above the scars which indicate the position of the cotyledons, and free from the commencement of the root downwards; the caulicles (tigella), which are nearly 2 inches in length, are firmly united together. There is nothing in the specimen before us to indicate when the union took place; it may have done so in the seed itself, or it may have occurred in the early stages of germination from the close contact of two seedling plants."

The Correspondent of the *Chronicle* says:

"EMBRYONIC INARCHING. - This is common in Aurantiaceæ, and something akin to it is common in *Sterculia acuminata*. I also have seen a specimen of *Dolichos* throw two stems from one seed, in 1870. Similarly, in 1868, a seed of *Cocos Romanzoffiana*, and of *Areca rubra*, both yielded plants which are growing in the Botanic Gardens, Kew, at the present time, and which, on examination, you will find originated from one embryo. *T. Croucher, Gr. to F. T. Peacock, Esq., Sudbury House, Hammersmith.*"

There is one paragraph in the extract from the *Proceedings of the Academy of Natural Sciences* which may be misunderstood by some botanists. That in relation to the radicle being a morphologized stem, rather than of the nature of root. Of course roots will come from any stem, and with this idea one might wonder what this proved here. But *Osage Orange* stems do not produce rootlets readily. It has been found an exceedingly slow process to root them by layers. It was in this respect that we noted the in-arched radicles resembled the stems. Though

under the ground, no rootlets came from the in-arched portion, while from the points immediately below the union, fibres pushed freely. As one of America's most venerated botanists has called our attention to this point, we think it may serve a good purpose to point out the application of the remarks at the Academy in the way in which they were intended.

### ABOUT CABBAGES.

A case was recently tried in Philadelphia, in reference to cabbage seed, which suggested to us how very little is known of things which pass before our eyes every day. There is no one but knows a cabbage, yet, how it grows in its native localities,—whether it is annual, biennial or perennial,—or whether it grows wild with or without a head,—how many cabbage growers can tell?

The writer has been fortunate to come across the cabbage in a wild state, in some of his early botanical excursions. These natural locations are usually on chalky cliffs by the sea-side, in various parts of Europe. The flowers are marked in our herbarium specimens as appearing in June. The seeds fall at once when mature, and grow immediately. The plant makes a stem about as thick as one's little finger, at best, but usually stouter by fall. There are no signs of any head, although the leaves have a slightly involute tendency. Early next spring the plant pushes up its flower stems, blooms, seeds and dies. In one sense the plant is but an annual: it lives only twelve months,—from June or July, till the next year at the same time. In the language of botany, it is a biennial, for it is produced in one year, and lives over to the next.

If now the seed is not suffered to fall and grow naturally in July, but is saved by the hand of man till late in the fall, or even till the following spring, the immediate flowering property is checked. Some would say it was not strong enough to flower; but philosophically we hardly know what "strong enough" in this sense means; as *strength* merely is not a law of flowering. However, the fact is, it does not flower, but instead continues to grow, adding great strength and vigor to stem and leaves, and then flowers at the usual time next year. Thus it will be seen that the only reason why a cabbage heads, is *because the natural growing season of the plant has been delayed by man several months after seed ripening.*

We know that it is customary with horticulturists to attribute a wonderful origin to our improved vegetables. We give pyramids of credit to the good old monks of the middle ages, who handed down the cabbage-head to us. But we believe the "knowledge" and "skill" engaged in this matter was not in the past much more than is found to be the case where the "patient efforts" of our would-be patentees of new fruits in these modern times, resolve themselves into the cutting off of a few scions, or the digging up of a few bushes or canes from some plants in old cow pastures or waysides.

Buckman has taken the common wild Parsnip, and in a few generations has produced as good as any grown for hundreds of years; and in this cabbage business, we have strong faith that one could take the seeds of the wild species, as we have described them, sow in October, preserve during the winter from severe cold, and get tolerably good heads the next summer or autumn. Now this is but theory, but there seems to be no other conclusion from the facts we have recorded.

Now, to the practical man, many lessons are taught here. No matter how large or solid his cabbage head might be, if sown in July when the seed ripened, he would get no head next year. If he sow in August, his chances would be a trifle better,—in September it is still improved; but he is hardly safe until the end of this month or even the beginning of October. Nay, the month has less to do with the matter than the season,—for if the October, November and December be open or fine, or the plant stimulated by heat, still the plant will run to seed as naturally as a cauliflower will "button" in a warm winter hot-bed.

### LECTURE ON HORTICULTURE IN CALIFORNIA.

On the 13th of April, the Hon. MARSHALL P. WILDER, President of the National Pomological Society, will deliver a lecture for the benefit of the Pa. Horticultural Society upon the subject of Horticulture, Agriculture and Social Life on the Pacific coast. It will be recollected that Mr. Wilder, Chas. Downing and P. Barry of New York, made a horticultural trip to California last year. In the proposed lecture, Mr. Wilder will embody the result of his observations, which will afford matter of the highest scientific and practical interest.

Mr. Wilder has delivered this lecture before the Mercantile Library Association, at Boston, with the highest commendation.

One Hundred Dollars, from the proceeds of Mr. Wilder's Lecture before the Horticultural Society, will be offered as a Premium for the Best Collection of Fruits, from any State, Society, or individual, comprising Apples, Pears, Peaches, Plums and Grapes, three specimens of each variety, to be shown at the Autumnal Exhibition of the Society, Sept. 12, 1871.

It is proposed to make the Autumnal Exhibition of the Pennsylvania Horticultural Society, in some degree a National Exhibition, as in 1869. The National Pomological Society will meet in Richmond, Va., Sep. 8th and 9th; and the Philadelphia meeting will open on the 12th.

The discussions will be held in Richmond, but the chief exhibition of fruits may be held in Philadelphia, or there may be one exhibition of fruit in Richmond, and another, and the greater one, under the auspices of the Pennsylvania Horticultural Society immediately afterwards. The Horticultural Society has greatly increased its premiums for fruits and flowers, and will make an effort to excel even the exhibition of 1869. We shall soon publish an abstract of the list of premiums.

The monthly exhibition for April, occurs on the 18th of this month. The list of premiums is liberal, and we understand that special prizes will be offered for display of ornamental foliage plants and plants in bloom, professional Florists, which has not heretofore been

done.

The public interest in the Society seems to be increasing, and the members exhibit very commendable enthusiasm in making a fine display at the exhibitions.

#### THE SALWAY PEACH.

[See *Frontispiece*]

A few years ago, the late Mr. Pullen sent us some "first fruits" of the Salway Peach, even then quite new in England, where it originated. It was beautiful to look upon, and withal remarkably good to eat, though an orchard house fruit is by no means to be compared to an out-of-door ripened one.

It is somewhat remarkable, that though peaches grow here so easily, and seedlings appear by the thousands, our best varieties are mainly those brought from the Old World. There are few native varieties that will compete successfully with Grosse Mignonne, George IV, Barrington, Royal George, Bellegarde, Walburton, Chancellor, Newington, Early York, Noblesse, Old Mixon, and perhaps some others.

Our engraving is not taken from one grown in the open air in this country, but from one grown in the climate of England. So far as we know, it has not yet fruited outside of orchard houses in America. Generally we should not go to the trouble of so costly an engraving of an untried fruit; but in view of the great value which other peaches with foreign reputations have proved to us, we feel safe in giving this fine variety prominent notice.

## SCRAPS AND QUERIES.

**MANAGEMENT OF HORTICULTURAL SOCIETIES.**—Alluding to the Pennsylvania Horticultural Society, we recently noted in effect, that it was strange these institutions ignored the services of the horticultural press in making their objects known, and that a few advertisements of what they were doing and wanted to do, would do them more good than the managers have the least comprehension of. Here is the Pennsylvania Society for instance, which spends annually in advertising in "secular" papers and pamphlets, perhaps \$1000, has probably not spent

one cent of this on any horticultural paper. Yet why horticultural publishers should exert themselves to sustain horticultural societies, and horticultural societies do nothing in return for horticultural journals, we cannot understand.

In the remarks referred to, we stated that the Pennsylvania Horticultural Society had offered, probably, a larger sum for premiums than any other Society has done. Now some good friend sends us a marked copy of the schedule of the Massachusetts Horticultural Society, by which we see that \$4750 is the sum of what they offer,

Some of these are very liberal, as witness the following :

For objects originated subsequent to 1860, and which, after full trial, shall be deemed superior in quality and other characteristics to any now extant.

For the	
Best Seedling Pear, after a public trial of five years.....	\$60 00
Best Seedling Apple, after a public trial of five years.....	60 00
Best Seedling Hardy Grape, after a public trial of 3 yrs..	60 00
Best Seedling Cherry, after a public trial of 3 years.....	40 00
Best Seedling Strawberry, after a public trial of 3 years.....	50 00
Best Seedling Raspberry, after a public trial of 3 years..	40 00
Best other Seedling Fruit, after a public trial of 3 yrs.....	40 00
Best Seedling Rose, after a public trial of 3 years.....	40 00
Best Seedling Camellia, after a public trial of 3 years.....	60 00
Best Seedling Azalea indica, after a public trial of 3 yrs.	40 00
Best Seedling Tree Peony, after a public trial of 3 yrs....	40 00
Best Seedling Hardy Rhododendron, after a public trial	
of 3 years.....	40 00
Best Seedling Hardy Azalea, after a public trial of 3 y s.	40 00
Best Seedling Flower, after a public trial of 3 years.....	40 00
Best Seedling Late Potato, after a public trial of 3 years...	30 00
Best Seedling early Potato, after a public trial of 3 yrs....	30 00
Best Seedling Vegetable, after a public trial of 3 yrs.....	30 00

We suppose our good friend sent us this marked copy as a reflection on our ignorance in rating the offers of the Pennsylvania Society so much above Massachusetts, and we accept the rebuke with thankfulness. But yet we submit that if these institutions are really in earnest in wishing the best kind of competition, they should make use of the best agencies for that purpose. This placing of valuable lights under bushels, and then depending on horticultural editors to advise the public individually to lift them and dazzle their eyes by the brilliancy that lies buried beneath, all has its usefulness ; but the better plan would to apply those celebrated measuring utensils to more legitimate uses, and let the luminous institutions speak in a glory of their own.

MR. DOUGLAS' LETTER.—A, *Galena, Ills.*, says: "What an interesting letter from 'our' Douglas, we always learn something from what he says. Why don't you get him to write oftener?"

[Well! that is just the point. We don't know how to get him.]

Some of our most intelligent men write little, for fear they can write nothing not already known. This is a very proper feeling ; but so much is forgotten that has been told, that every one who transgresses in this way is seldom caught, and if caught, readily forgiven.]

PEAR CULTURE.—E H S., *Suspension Bridge, N. Y.*, says: "I wish in your next number you would give us your views on pear culture and

pruning, whether the fall or now is the best for pruning, and whether summer pruning is generally followed. I see by the 'Agricultural Report' that it is condemned, and also disturbing the ground with the plough, further than removing weeds with scythe or hoe. Let us hear from you on this matter. Please state when you take up this matter, what manures you approve of for the pear."

[The essay of Mr. Satterthwait, which is concluded in this number, will no doubt furnish our correspondent with much valuable information. Some of us might perhaps differ from the author on some minor points ; but he speaks from a very successful experience, and we regard the Fruit Growers' Society as fortunate in getting for the world one of the best Pear essays ever seen in print.]

DEATHS OF HORTICULTURISTS.—During the past month we note, with regret, the decease of several distinguished Horticulturists. One of the Messrs. Vilmorins, of Paris, was shot through the head at Le Mans—Henry Vilmorin. The other two were in the army, but escaped. Sanford Howard died at Lansing, Michigan ; he was formerly Editor of *Boston Cultivator*, and one of the earliest friends of the *Gardener's Monthly*.

Mr. Stephen Pierson of Alton, Ills., one of the leading spirits in the excellent Alton Horticultural Society, has also passed away.

LONDON PRIDE.—Miss Kate M., of *Washington, Ohio*, asks where this old plant, *Saxifraga umbrosa*, and the old yellow *Asphodel*, can be had. We have not seen them for many years ; if any of our readers have either or both, we should be obliged for a root.

NAME OF PLANT.—Mary McA., *Bowling Green, Kentucky*. "Enclosed you will find a small plant which you will please examine, and tell me through the *Monthly* what it is. I have been a close observer of plants many years ; this is the first time I ever noticed this plant. It came up in my flower beds voluntarily ; it is very hardy ; the cold spell before Christmas did not injure it in the least ; it began to bloom Feb. 14. It may be a similar case to one before. The 'Leptosiphon alba' had never been seen before 1864, when it first appeared, covering the entire field, which had a crop of Maize the year before."

[*Arabis thaliana*. It is an European species, but is gradually spreading all over the United



States. It is a very pretty thing to examine under the microscope, as the hairs are star shaped, a not very usual circumstance in the cruciferous order, to which this plant belongs.]

NAME OF PLANT.—*C. D. F.*, *Catharine, N. Y.*—“Enclosed find branches of a tree, which grows wild in this part. It is quite ornamental. What is it? The common and botanical name?”

[*Euonymus Americanus*,—very beautiful, and worthy of garden culture.]

VALUE OF SOME PEARS.—*W. H. E.*, *Hamburg, N. Y.*—“I wish to ask for information through your valuable *Monthly*, as to the following varieties of pears: Vicar of Winkfield, Buffum, Doyenne Boussoek, Madeline. These are fine growing trees, not yet bearing. I am told they are not good varieties. If you will please inform a subscriber to the *Monthly*, you will ever be held very kind by a lover of good fruit.”

[These varieties are amongst the most popular. It is not a bad sign they grow so well. Patiently bear with them while they are sowing these wild oats, and they will no doubt reform by and by.]

LATE STRAWBERRY.—*A Morristown, Ind.*, *correspondent* says: “I have a strawberry, that for growth of plant, beats all others on poor soil. It will grow thirty inches across, the plant bearing its fruit on stocks ten to 12 inches long. It is a pistillate, and blooms so late, the Downer, Wilson, etc., cannot act on any but a few of the first blooms on it. It has just passed one of the most trying seasons I have ever known, and come out all right. It has yielded about a quart to the plant. All the berries that get properly fertilized, are of large size and good flavor. I think it would be a good kind to get a cross from, if I knew what to use as the male parent. Will you please tell me in the columns of the *Monthly*.”

[It is not generally known that pollen will retain its vitality in paper, like seeds. For fertilizing purposes, our correspondent could, therefore, preserve the pollen of any of the early kinds, and use them for his purpose when these later blooms came out.]

NEW MUSK MELON.—*Mr. Phoenix* has sent home a few seed of a Musk Melon; he describes it of very superior flavor. It has not the smell

of a Musk Melon, or the appearance of one, being more of a squash look than melon; color chiefly white; an excellent keeper, as good Feb. 1st as the day it was cut from the vine. He considers it a decided acquisition.”

ARRANGEMENT OF A FLOWER BED.—*Mrs. S. E. N.*, *Phelps, Ontario Co., N. Y.* “An oval bed, ten by fourteen feet, being already planted with Hyacinths for spring blooming, has had for two summers past Ricinus, (three varieties) *five plants*, which grew twelve feet high. Also the same number of Japanese Maize with *Caladium esculentum*, and three or four Tuberoses to fill the outside vacancies. It was as ornamental and as much admired as I could wish, but ‘a lady no more wants her flower garden to have the same look every year than she wants her new spring bonnet to last forever’ (*Gardener’s Monthly*, April, 1864); so I, following her example, apply to you as a lady does to her milliner, hoping that you will, if possible, in your next number give me a few suggestions as to what kinds of tall ornamental-leaved plants, and how many to plant.

How would the *Erianthus Ravenna* do for a centre, and other grasses to fill out with. I want something to make a show the first year. Do the seeds of all these grasses in our floral catalogues germinate easily? If you could suggest other things better adapted to the purpose, please do so, and oblige not only myself, but probably many others.

Cannas I have tried often, but do not succeed with the finer kinds, though following closely our catalogue directions.”

[The Cannas require longer summers than your district affords. For a change, substitute *Bocconia japonica* for Ricinus. Its height is about the same, and it has much the same habit. As the Ricinus was found to please, something of the same character would be the best to experiment with. A *very strong* plant of *Erianthus Ravenna* would do. Small plants flower too weakly and too sparsely. Its feathery spikes will not contrast disagreeably with the flowers of *Bocconia*, which are “sprayey” also. *Humea elegans* is also another strong growing plant, with much elegance when in flower; but there is no deep color in it as there is in the leaves of Ricinus. Color can be given, however, by planting among them some of the strong Gladiolus, especially *G. Breuchleyensis* or of *Tritoma uvaria*. We

should still add a few Tuberoses, for none of these groups are perfect without some white, either in leaves or flowers.

Seeds of ornamental grasses usually grow readily; but in Pampas grass, or the Erianthus, it takes two or three years to get a seedling plant strong enough to make a show.]

THUJA GIGANTEA.—*M., West Phila., Pa.*, writes: "When looking at my plants two years ago, you said what I had as *Thuja gigantea* was incorrectly named, and that it was *Libocedrus decurrens*. I was almost sure it was the name I had with it from Parsons & Co., but did not like to contradict you. Last year I imported a few things from Europe, and amongst others, a *Thuja gigantea*, so as to have it correct. I enclose a piece; you will see I was right in the first instance. It is the same as the other. With your love of accuracy, I know you will be glad to be corrected, or I would apologize."

[Of course we desire to be correct, and thank our friend for his good intentions. In this case, however, the English and Parsons are both wrong. See *Gardener's Monthly*, Vol. I., where the whole subject was investigated.]

PRUNING HEMLOCKS AND EVERGREENS.—*J. C. S., Philadelphia.* "Will it do to clip and shape our Hemlocks and Norway Firs in the spring; if so, when is the best time?"

[For specimens on lawns, the best time to prune, to reduce trees to shapeliness, is as soon in spring as danger from very cold winds is over. For hedges, the best time is about three weeks after the buds have pushed.]

SEEDLING APPLE.—*A Subscriber, Cañon, O.*—"Last fall sent you a new seedling Apple, raised by a friend of mine in this county, with a request that it be figured and described in the *Gardener's Monthly*, but I have not seen any account of it. Did you receive it?"

[We have to apologize to our correspondent for the oversight in not noticing it. We remember its receipt, and thought it a very good fruit, but not equal to Benoni, which in general characteristics it very much resembled.

We regard the indiscriminate describing of every good seedling fruit that may come up, as an evil, which, so far as in our power, we set our face against. We have over 2000 named apples

now, and "Downing only knows" when this thing is to stop. Our rule for sometime has been to name and describe only those fruits which we feel tolerably sure are different from and in some respect superior to others existing.]

LAYING OUT A SMALL GARDEN.—*Mrs J. M., Norwich, N. Y.*, writes: "My husband is desirous to obtain some hints or suggestions in regard to laying out our yard and garden. The house is a square stone house; the yard is 200 feet in front, and the same on the south side, with a garden extending on the same side about the same number of feet. The house is a corner house, fronting two streets. Can you give us any directions as to how it should be laid out or direct us to some work on the subject of laying out yards, gardens, &c.?"

[It is difficult to advise without seeing the house, or a ground plan of it. Much depends on where the doors are, as the location of the walks depends on this; and again, the groups of shrubs and the trees will depend on the location of the windows, and indeed of the walks themselves. As a rule, in small places, straight walks look better than curved ones; and trees of medium size or bushes are better than trees that will grow large. If the street lines are of wire, iron, or some other kind of very open fence, an ornamental hedge inside the line looks well. This may be of *Pyrus japonica* if the brilliant blossoms are appreciated; or of Hornbeam if good foliage is preferred; or of Arborvitae or Hemlock Spruce if it is desirable to have something green in the winter. In small places, open spaces of neatly kept lawn are always admired,—the more so as there is so much tendency to plant things about, and at last leave no lawn worth speaking of. Along the boundaries of the lot, borders planted with shrubbery look well, these to be kept always clean from grass. The contrast of the brown earth with the green grass is always pleasing. In front of these borders hardy flowers which bloom early, like Polyanthus, Crocus, Snowdrops, do very well. The borders may be bayed out in some instances, and a clump of larger growing bushes put in the wide part. This will make shady and sunny nooks, and give variety in this way. These, to be sure, are very general hints. They may be summed up thus: First locate the walks with the view to convenience, then aim at the greatest variety of pretty objects—in surface, outlines, lawn, shrubbery, flowers, &c.

There is no very good American work on small places. Kemp's "*How to lay out a small garden*" can be had through any importing bookseller, and with a little modification of the kind of trees mentioned, and other smaller matters made to accommodate our climate, is an invaluable work.]

PINK BLOSSOMS FROM A WHITE GERANIUM.—Mrs. S. S. T., Carbon Cliff, Ills., sends a specimen of geranium, and says: "I enclose a truss of the pink blossoms borne by a cutting from a pure white geranium. The color is not quite as deep as in the more congenial summer time; but you will see it is quite distinct from the pink flush sometimes seen on white varieties. You may remember, I mentioned some months since the singular freak of the branch of a White Zonale Geranium, which being divided into four parts, produced two plants bearing white flowers, and two pink, of which the enclosed is one. It is impossible that I should be mistaken with regard to the identity of these plants, for I had no other cuttings at the time, and none for months before and afterward."

[There is no mistake in our correspondent's observation. We put the truss sent, in water, and some of the flowers, mostly pink, came out of a *pure white*.]

DAHLIAS.—Mrs. S. S. T., Carbon, Cliff, Ills., asks: "May I ask that you will add to the obligations under which I am already to the *Gardener's Monthly*, by giving me some directions for the cultivation and care of the tubers of the Dahlia, and how to raise them from seed?"

[Dahlias are best set out very early in the ground after danger of frost is over. As soon as they are sprouted, take them up and divide, and set out the pieces again separately. They make better plants than when several stems come from one old root. The seed is to be collected in the fall, sown early in spring in hot-beds, and the plants will flower the same year.]

FLOWERING OF WISTARIA SINENSIS.—Mr. R. H. Sherwood, College Wharf, Pa., writes: "In reading an article in the *Monthly* of February, I was quite surprised to see that you consider the fruiting of the *Glycine sinensis* a rarity. We have an old plant that bears fully a half bushel of pods annually. We have also a *G. sinensis alba*, that fruits, but less freely."

[The paragraph referred to, was written, not

by us, but by Mr. Shirley Hibberd, in the *English Gardener's Magazine*; and he was referring to plants growing in England.

Mr. Sherwood's note is interesting, as suggesting whether new varieties may not be raised here of this popular favorite. We should very much like to know from Mr. Sherwood, whether seedlings have flowered with him, and whether they show any tendency to vary.]

PEAR ON OAK ROOTS.—A Delaware county correspondent writes to us about this. He is not by any means a novice, or one easily persuaded unless facts are strong. He says:

"I have been promised grafts from a winter pear growing in this neighborhood, grafted on the root of an *oak tree*. Its growth has far outstripped trees grafted on pear roots, and it bore pears last year weighing twenty ounces.

I do not send this statement to the *Monthly*, for I do not suppose any one will believe it, but if necessary, I can give sufficient proof of the fact."

WIRE FENCES.—We have repeatedly referred to the annoying habit in solid wire fences and trellises of getting loose and "kinky" by the changes in our temperature. Fences of woven wire have been found to be safe against this; but too expensive for general use. Mr. Yeomans made a useful advance by his invention of a lever tightener; and we now have another capital thing in the advertisement of Mr. Philip S. Justice, in our columns this month. We are evidently in the line of cheap and good fences.

NEW FUCHSIA.—Miss A. B. N., Phelps, N. Y., asks us to name the *best* new Fuchsia. So many new ones are good, it is hard to choose the best. But Madame Deproost is good; it has a bicolored corolla. Starlight and Marksman are also two very good varieties. The same lady encloses a Fuchsia for name, the flower of which is scarcely a quarter of an inch long, and leaves to correspond. This is the very old, but nearly lost *Fuchsia reflexa*. There are two species in cultivation, with these minute flowers. This one has the tube of the corolla somewhat tapering; the other one has it as thick at the attachment with the stem, as further down, cylindrical in fact. This is the *F. microphylla*.

**DENDROBIUMS.**—Mr. Such sends a branch of *D. nobile* clothed with magnificent flowers three inches across. Nothing is said about the number on the plant, so that we suppose the palm in this respect is conceded to Mr. Newett,—but we infer that something is to be claimed by South Amboy in the matter of fine flowers at least. With these was a single specimen of the rare *D. macrophyllum giganteum*, in which the flowers are of a brilliant rose, from a plant having seventy six flowers, which is remarkably good; and of *Eucharis grandiflora*, the third set of flowers this season.

**OXALIS LASIANDRA.**—*T. H. H.*, says: The tap roots of *Oxalis lasiandra*, that are broken off when the bulbs are taken up in the fall, make most excellent pickles, and owing to their beautiful pearly translucency, elicit much wonder and admiration when brought to the table. This *Oxalis* is a very pretty border plant of the easiest growth, and I plant a good many of them, as much for the roots as the flowers.

[We do not know this species. Similar use has been made of *Oxalis Deppei*.]

**ERRATA.**—The concluding words in the portion of Mr. E. Satterthwait's essay, published in March number, should be "molasses and vinegar."

**HEATING RAILWAY CARS.**—*B. D. Hingham, Mass.*, says: "Every year the papers have much to say about heating railroad cars. What is there against heating them by hot water as we heat our greenhouse? It seems a very simple thing to do, and I wonder no one has thought of it."

[It has probably been thought of; but the difficulty, no doubt, is that fire has to be kept continually in such a heated car, or else the water continually drawn off and refilled, or the pipes would freeze and burst. Thus it would be dangerous in one way, and troublesome the other.]

**FORNWALDER OR FALLAWATER APPLE.**—*J. S. Penns Grove, Pa.*—"Can you tell me any thing of the "Pollywogger" apple. I bought a barrel from a friend in the lower end of the county under this name. They seem to much resemble the 'Fornwalder,' but are smaller. By the way, what is the correct name of this apple?"

[No doubt it is the same apple, the smaller size being due to bad cultivation. As to the "right" name; there seems no right about any name for it. The *original* seems to have been "Pharrar Walther;" but *Fallawater* is the name in universal use, and we so accept it.]

**HYBRIDS AND VARIETIES.**—*S., Saco, Maine*, inquires: "Will you please define the separate character of hybrids and varieties in plants. I notice some writers seem to use the term indiscriminately."

[We don't know that there is any difference, although there is a sort of conventional idea that there is. In past times it was supposed that when two species intermixed, the progenies were hybrids, and then in many cases sterile; but there is no absolute sterility. The mule at times brings forth young. All we can say is, a cross between nearly related things are called varieties; and they are "hybrids" when the relationship is wide apart.]

**QUINCES.**—*M. R., Burlington, N. J., Alpha.* "Some of us here have an idea that the country about us is especially adapted to the culture of Quinces, and that they ought to pay well. Some few trees bear very heavy crops, but we do not find in any books or essays on fruits in the papers how many could possibly be gathered from an acre. Have they been grown extensively anywhere that you know; and with what results?"

[Mr. N. Ohmer, of Dayton, O., is very successful and his trees yield him about 200 bushels to the acre.]

**PLANTING THE BUFFUM PEAR.**—*Medicus, near Monocacy, Md.*, says: "I am setting out some pears this spring—standards—and propose to set them 20 feet apart; but a friend who is 'posted' on pears says some require more room than others, and that he would vary the distance to suit the kinds. He would put Buffum for instance but 14 feet apart, Lawrence, 18, and Bartlett 20. How would this work?"

[We should put all of one distance. Most of the varieties get about the same in time. Lawrence for instance seems a more slender grower than Bartlett, but there is no difference certainly in the room they ultimately occupy. As for the Buffum, though upright when young, it becomes as round headed as any when of age.]

PITCH OF GREENHOUSE ROOFS.—*G. C. M., Phila*, writes: 'I am thinking about putting up a small greenhouse, say 18 by 25 feet, would you oblige me by letting me know what is the best pitch to give the roof. I thought of one foot in every two, but this hardly seems enough.'

[We are in favor of steep pitches, for many reasons, though there are some disadvantages—45° is steep, that is a foot of rise for every horizontal foot; but we recommend it]

POPULATION OF GENEVA.—In our notes of Geneva, we guessed the population to be about 2000 inhabitants. A correspondent obligingly corrects these figures. It should be about 6000.

WEeping PLUM.—A New York correspondent inquires whether any one has ever seen a Weeping Plum?

SALISBURIA OR GINKO TREE.—*G. G. A* suggests that this tree should be more widely known.

Probably the reason it is not, is that it has been difficult of propagation; but seedlings are now getting common, and doubtless the public will soon get better acquainted with it.

CURIOUS RESULTS OF HYBRIDIZATION OR POLLEN.—*Dr. Wylie of Chester, South Carolina*, who has experimented more ably in grape hybridization than perhaps any man in the country, informs us that there is a great difference in the pollen of grapes under a microscope. The pollen grains of the Scuppernong are nearly globular, and all of one size. All other varieties that he has examined are ovate and double the size of the Scuppernong. In a hybrid of his between the Hamburg as a female parent, and the Scuppernong as the male, *the pollen is small, globular, and large ovate mixed*. We regard this as a scientific discovery of great moment, and one of high practical value.

## BOOKS, CATALOGUES, & C.

### MY TEN ROD FARM.

A correspondent of one of our daily papers says: 'Now, you will say who is "Jane Kingsford?" She is first Mr. Barnard, C. F. Barnard; second an agreeable gentleman and a musician, though not exclusively devoted to the divine art, since he is nearly as much interested in and writes as well upon horticulture as music. He is the author of "My Ten Rod Farm," which he wrote as Mrs. Maria Gilman, whose name appears upon the cover. This inspiring story was one of the greatest successes, under an assumed name, that I ever knew. I do not think it ever occurred to any one, till the secret was divulged, that the struggling but finally successful Mrs. Gilman, who told her story with such simplicity and pathos, was an interesting and prosperous young man. He has also written "Farming by Inches;" uniform with "My Ten Rod Farm."

The *Gardener's Monthly* does not claim to see through mill-stones any further than other people, but it will be recollected, that in reviewing the work on its first appearance it stated, that "whoever is at all familiar with female character

will feel that this book was never written by a woman," and that we objected to it, on the ground that it was "an effort, which always reacted injuriously to make people believe something had really been accomplished which never was done."

### VINELAND WEEKLY.

This good representative of Vineland's interests, has recently added to it an Agricultural Department, under the editorship of Oscar Clute, formerly professor of mathematics in one of the leading colleges in Michigan, and for some time one of the editors of the *Western Rural*. Mr. Clute was always an intelligent and able writer, and his engagement by the *Weekly* is a very politic one.

### L'ILLUSTRATION HORTICOLE.

One of the most interesting of our European exchanges is this monthly magazine, published at Ghent in Belgium, under the direction of Mr. J. Linden. It is beautifully illustrated by four colored engravings of new plants or flowers, and has a

large amount of miscellaneous Horticultural reading. It is issued at five dollars, American gold, per annum, free of postage, we believe, at this price. It is in the French language, and this will make it welcome in many families where practice is required in this tongue,—and with much better effect on young minds than the trashy novels which now so generally serve that purpose. Perhaps it could be had of Mr. Raoux, New York.

## CATALOGUES OF EUROPEAN FIRMS.

These interesting lists are now abundantly supplied to our table, and all highly valued; and we return our best thanks to our correspondents for them. We have before expressed our indebtedness to Mr. Bull for his catalogue of new plants, which comes regularly; and one of new seeds by Messrs. Carter, Dunnett & Beale, of Holburn, London, is also received and read with much interest.

## NEW AND RARE FRUITS.

**SOUR AND SWEET AND SPECKLED APPLES.** Mr. Blodgett sends us, with some excellent fruit. the following note: "After a month of most unlucky detention, I have received a box of my sour and sweet apples from my orchard, intended for the State Pomological Society's meeting. The best mixtures are in the worst state of decay, and in picking out a good dozen to send to Mr. Downing, I find that I got all the *wholly sweet* ones, so that these I send you are not so good as representatives.

An old friend of my father's writes me (from Sugar Grove, near my farm), re-affirming the facts I have stated as to the origin of the speckled and sour and sweet apples; his name is Green Clark, and he says that the first known of the speckled apple was, that he, Green Clark, grafted it into the orchard of his brother, Alanson Clark, in the township of Middlesex, Gates Co. N. Y., and he, Green Clark, brought it to my father's orchard with other new fruits he was grafting. This corresponds with my recollection of my father's statement; which was, that it originated on the farm of a Mr. Westbrook, his residence in Ontario County, N. Y., (Gate and Ontario are adjacent Counties). It was simultaneously given to Alanson Clark, in Ontario County, and to my father in Chataugue Co., by whom it was generally distributed. I believe our friends Downing and Barry will find it difficult to trace an apple *known only in Western New York*, to Holden (or Hogpen), in Mass.

And as to the graft or bud hybrids, time will show that I am right.'

**PYLE APPLE.**—*W. G. B., Glen Mills*, writes: "I send you some specimens of apples from a seedling tree in Thornbury, Delaware County, Pa. It may be called the Pyle Apple, as it grows on the farm of Walter Pyle. For many years it has never failed to bear fruit regularly every year. It does not ripen perfectly till in the winter, but it is a most valuable apple for cooking, long before it becomes suitable for eating otherwise. If the samples I send have not suffered from freezing, you will be able to judge of the quality. It keeps quite sound through the winter and spring.

[These were very handsome apples, with yellow fleshed pulp; not of the highest flavor, but with a sort of "try me again" air, which left a suspicion that under some circumstances it would hold its own with the best.]

**DANA'S HOVEY PEAR.**—We are indebted to our friend, W. L. Schaffer, Esq., the distinguished amateur pomologist, for a specimen of this new pear. It was fully ripe at the beginning of this month, and was the best quality of any autumn pear, as we suppose it is, we have ever tasted so late in the season. It originated in Massachusetts, and we understand promises to be a valuable addition to our list of autumn varieties.—*Germantown Telegraph.*

**OLD ADAM APPLE.**—The Adam Apple we supposed had been in every man's throat for ages,—but here is the Ohio Pomological Society bringing it out as something new. It says in its

report: "An apple presented by Adam Luckhaupt, of Columbus, and named by him *Old Adam*, is remarkable as a long keeper, the fruit of two seasons being exhibited at the Fair. It is of fair quality, and valuable where the fruit crops are subject to failures. The variety was imported from Germany about eight years ago.

**THE ORANGEFIELD RED CURRANT.**—When recently in the neighborhood of Belfast, in company with one of the most distinguished fruit-growers in England, we paid a visit to Orangefield, the residence of J. Blackiston Houston, Esq. Among the many objects of practical interest pointed out by Mr. MacLachlan, the very clever and intelligent gardener, none impressed us more than two bushes of the "*Orangefield Red Currant*," which we found carefully netted, with a view of preserving till the close of the year the myriad bunches of beautiful fruit that from soil to summit clustered on the branches. We never saw anything like them, and our English friend would have about a span-length of branch to carry away with him as a wonder. We were anxious to see this currant, from reading in December of last or preceding year a notice of the reception from Mr. MacLachlan of a sample of its fruit in splendid condition, notwithstanding the occurrence of a week or so of very severe frost at the time. Besides the profusion and excellence of its fruit, its late keeping properties further enhance its value. It appears too, to retain the foliage till very late. Raby Castle and other varieties were growing alongside; but it appeared distinct from any of them. The name given above is only a provisional one, which we venture to give it, as we believe Mr. MacLachlan has not yet met with any one able to identify it. The bunches are short, and in form like those of the grape currant, not a one-sided raceme, as in other varieties. The berries are full size, brilliant in color, and to our taste what a red currant ought to be—sugary and piquant. It is a very strong grower; the wood of some young trees trained to the wall was marvellously robust. In its cultivation Mr. MacLachlan informed us that the growth required at first to be checked by lifting and replanting. When once in full bearing, its wonderful fruitfulness sufficiently checks the production of wood. Indeed, we never saw bushes less burdened with superfluous wood than these closely spurred plants of this variety, which were certainly mar-

vels of fruitfulness. Mr. MacLachlan has propagated it extensively, and has now nursery plots of fine young bushes, which we believe he will send out at the price of ordinary currants. The Orangefield Tomato is, we believe, regarded by gardeners as an acquisition. We regard the Orangefield Red Currant as a greater.—*Irish Farmer's Gazette*.

**NEW PEAR—EARLE'S RUSSETT.**—Since the commencement of this report, a pear has been exhibited at one of the weekly re-unions of the Society, that may well exact a word of notice. A seedling originated by Hon John Milton Earle, to whom this Society has been so long indebted for many and various services, and with whose parentage it is but vaguely identified, under the name of Earle's Russett; its apparently confirmed excellence should render it alike a source of pride to him and of interest to ourselves. Additions to the list of fruits, of approved good quality, are too rare to justify the unhesitating acceptance of every new candidate. It may be said of Earle's Russett, that it has been nursed with care and developed to an almost perfect assurance of decided superiority. Not entirely dissimilar to the Beurre Easter, in flavor, though with more sprightliness than that coy variety, the proof of this pudding also is evolved from the eating. The shrinking modesty of him to whom we owe the origin of this seedling, will, it is hoped, suffice to excuse the loudness of the blare which thus unblushingly trumpets his achievement.—*Transactions of Worcester Co. Hort. Society*.

**HOTTENSTEIN APPLE.**—Under this name of Hottenstein, we have long been familiar with one of the best apples grown. It has somewhat the characteristics of the Northern Spy. Though supposing it to be a native of north-eastern Pennsylvania, we were unable to get at its history.

Recently we discovered its whereabouts, and have been favored with the following memorandum by a correspondent:

"The apple you have reference to, originated in Berks County, Pa. The original tree, a seedling, was owned by a man living in Kutztown, Pa., about 90 or 100 years ago, by name Lippert, after whom the apple was named with us; and it appears that those persons who obtained the grafts from us gave the name of Hottenstein. The apple is an excellent one. The tree with us is about 60 years old, and bears regular crops of large and excellent fruit."

## NEW AND RARE PLANTS.

*SOLANUM CILIATUM*.—A few weeks ago we received from Mr Dreer a fruit of a new *Solanum*, which proves to be the *S. ciliatum* of Lambert. It was about one and a half inches in diameter, globular and of a brilliant scarlet red, with a bloom on it like a plum. As it will no doubt prove a very desirable ornament to our summer gardens, we give the following account of it from the *London Gardener's Chronicle*.

“Among the novelties for the year 1871, we may mention the above named plant, fruits and seeds of which have been imported from Porto Rico, by Messrs Carter & Co., of Holborn, and of which they have succeeded in raising young plants. The great attraction of this species, from a horticultural point of view, will no doubt consist in the exceedingly beautiful berries, which are of a globular shape, depressed at the top, of the size of a Tanguine Orange, and of an intense pure scarlet color, overlaid by a glaucous bloom. Nothing more brilliant can well be imagined.

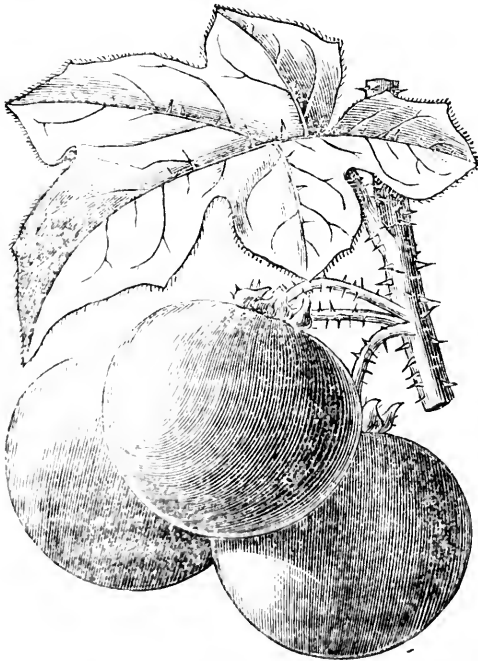

The plant is described as a branched annual (sub-herbaceous), 12 to 18 inches high, generally covered with straight, very sharp, yellowish

prickles, but sometimes destitute of them. The leaves are stalked, oblong, and irregularly lobed. The flowers are solitary or borne in racemes. The calyx is saucer shaped, pentangular, 5-lobed, and increase in size as the fruit ripens. The corolla is three-quarters of an inch in diameter, white, 5-parted, with acute, spreading, or reflexed lobes. The anthers are orange colored, aggregated in a cone-like mass. The ovary is white, sub-globose, furrowed, surmounted by a white style, which is terminated by a green, 2-lobed stigma. The fruit is greenish at first, marked with green lines, and becomes scarlet as it ripens. Some of the flowers, it appears, are sterile, and do not produce fruit.

We have ourselves only seen the fruits and the seedling plants, so that we are not in a position to say anything as to the habit of the plant, but from the great beauty of the fruit we imagine that the plant will prove to be a great acquisition. Probably, like most of the annual *Solanums*, it will be found a plant of very easy culture, requiring to be kept growing on briskly, in good soil, and to be kept free from insects, the red-spider especially.

*SPIREA JAPONICA* (*syn.* *HOTEIA JAPONICA*) *AUREA VARIEGATA*—This an extremely beautiful variety, one of the most popular plants in cultivation. It differs from the green leaved plant, with which all are familiar, in its elegant leafage, being traced with golden veins, and borne on rosy tinted stems. For this valuable novelty we are indebted to Messrs. E. G. Henderson & Son.—*Gard. Chronicle*.

*CROTON CORNUTUM*.—An interesting member of the large group of new *Crotons* introduced by Messrs Veitch & Son. It is characterized by a peculiar extension of the midrib, which forms a horn-like process at the apex of the leaf. It is a compact growing variety, with leaves which vary slightly in form, and are richly spotted and blotched with yellow.—*Gard. Chronicle*.

At page 296 of last year's *Gar. Weekly* will be found a classification of all the known varieties of *Croton variegatum*, accompanied with figures of five of the newest, namely, *irregularis*, *interruptum*, *acubifolium*, *Hillium* and *maximum*.



## FOREIGN INTELLIGENCE.

A MUSHROOM CAVE.—A correspondent of the *London Journal of Horticulture* thus describes a visit to a French mushroom cave :

We first found out Madame Froment, whose son kindly accompanied us, and we were in due course conducted to one of these openings, having first provided ourselves with candles, etc. To those who have descended coal mines or such other subterranean retreats, and who, like Lieutenant Warren in his exploration of Jerusalem, are said to delight in groping, it is nothing ; but to staid and sober people like myself, who affect the upper air and level ground whose backs do not bend so easily as they used, and whose heads are none of the steadiest for such work, the descent is an ordeal of no common nature. You looked down a large opening of about 70 or 80 feet in depth, and by an ingenious contrivance had to swing yourself on to a very rickety-looking swing ladder, which had to be repaired before we could venture on it ; but I was committed to it, and so down we went. When we reached the bottom we were very soon *in medias res*. Galleries stretched on all sides, and into these we soon dived. As we wound along, the owner narrated to us sundry funny adventures he had had with visitors, amongst others of a certain Lord Mayor from the Emerald Isle, whose copious rotundity was considerably in his way in some of the passages, and who puffed, fumed and steamed through them. Our conductor, besides being thoroughly used to it, being a thin spare man, could thread his way along easily where his more corpulent companion found considerable difficulty. All along these passages were long, narrow beds of varying heights and sizes, but all small, and entirely different from anything we are used to in mushroom culture. On these beds, which were covered with a peculiar calcareous soil, were mushrooms of all sizes, from tiny little pins' heads up to good-sized teacups, some as white as driven snow, others with a faint tinge of buff. On we went. Sometimes we had the greatest possible difficulty to get along, so very low was the ceiling ; and now and then we came upon an opening where a larger portion of the stone had been obtained, and here the beds were sometimes four, five and six deep, but all of the same form—slightly rounded and low. The *championiste* would every now and then stop, bid

us admire some fine cluster of his productions, and expatiate on their beauty. Some idea of the extent to which this culture is carried on, may be gathered from the fact that this one man had ten miles of these beds in this subterranean garden, from which all through the year immense quantities are daily sent into Paris

A STRONG CEMENT FOR IRON.—To four or five parts of clay, thoroughly dried and pulverized, add two parts of iron-filings free from oxide, one part of peroxide of manganese, one-half of sea salt, and one-half of borax. Mingle thoroughly, and render as fine as possible ; then reduce to a thick paste with the necessary quantity of water, mixing thoroughly well. It must be used immediately. After application it should be exposed to warmth, gradually increasing almost to white heat. This cement is very hard and presents complete resistance alike to red heat and boiling water. Another cement is to mix equal parts of sifted peroxide of manganese and well-pulverized zinc white ; add a sufficient quantity of commercial soluble glass to form a thin paste. This mixture, when used immediately, forms a cement quite equal in hardness and resistance to that obtained by the first method.

NERINE UNULATA.—Is it customary for this plant to flower as a piece of mine has done this season ? An old clump in a pot has been standing out with a lot of other plants that we might as well have destroyed for all the care that has been bestowed upon it, and the Nerine is now a mass of flowers, and very healthy and bright in leafage. I have removed it to the greenhouse to save it from injury by frost ; though if it had not flowered it would probably have been left to perish. I seem to remember that this particular pot of bulbs belongs to a lot of plants that have been treated with contempt for two or three years, and probably our neglect of it has promoted a perfect maturation favorable to flowering. If so, we shall have to describe the cultivation of Nerine undulata in these few words : The best way to grow this pretty amaryllid is to forget that you possess it, until reminded by its flowering that your riches exceed your knowledge.—S. II, in *Gardener's Weekly*.

## HORTICULTURAL NOTICES.

## PENNSYLVANIA HORTICULTURAL SOCIETY.

The February meeting was one of the most successful monthly exhibitions held for a good many years. Instead of confining it to the Foyer, as has been customary, the large hall heretofore kept for the annual displays was thrown open, and some thousands must have visited the building during the evening. The society is also gradually increasing the amount of its premiums, so that the working gardeners and florists are encouraged to exhibit, and the public induced to see—two very essential elements of great success. Hundreds of persons will have the taste for horticulture implanted in them by these displays; and thus the society accomplishes one of its grand objects.

Amongst the objects that struck every one's attention in the hall, was a magnificent specimen of *Azalea Phœnecia*, in the collection of Mr. Robert Buist. This plant was a somewhat conical globe, about 3 feet high by 2½ feet in diameter,—though one of the oldest, its vigorous growth, and free flowering habit renders it a favorite in collections. The flowers of the modern kinds are rounder in outline. In this respect the *Kinghornii*, rosy crimson kind, was in striking contrast with *Phœnecia*. Mr. Buist had a seedling white with well-defined carmine stripes, which promises well. There were many collections of *Cinerarias* exhibited, but none which attracted so much attention as Mr. Dreer's; they had more novelty in the density of their flowers than any before exhibited. They appeared so regularly on the surface as if they had been set on a wire frame. One of them was a sort of spreading dwarf, about one foot high, and two feet in diameter. Mr. T. J. Mackenzie's collection of *Cumellias*, was, as they always are, of the most superior character. A very nice lot also came from Mr. John Sherwood. To our mind there were few things more worthy of credit on the tables, than the *Hyacinths* in pots, exhibited by Mr. Alex. Newett, gardener to H. P. McKean, Esq. Usually these plants are so grown that they are either nearly all leaves with the flower down in among them; or else with tall lank stems without much foliage. These were in excellent proportion; the leaves being about six inches in length, of a healthy green,

and self-supporting; while the spikes were about fifteen inches, and about one-third forming the truss of flowers. The whole was so perfect a specimen of good culture that we doubt whether it could possibly be excelled. Mr. Newett had also some very fine pots of the rare "Queen of Violets." They are lighter than the Neapolitan in color, and are said to be very sweet scented. He also had a collection of *Orchidea*. Amongst these were *Maxillaria tetragona*, with six spikes of flowers. It is not on the whole a showy species, but the flowers are large for this short stalked section of this genus, being about two inches across, of a lemon-yellow color. He also had in this collection an *Oncidium sphacellatum*, with the panicle about two and a half feet; and an *O. altissimum*, with about a four feet panicle. What are called "French" pansies, would not take at an English Pansy show, where the flowers have to be flat, and round, and "cat-faced," and so forth; but the public cares more for these we think than the English sorts. Mr. Thomas, gardener to Mr. Buckner, had some of the prettiest of these that we ever saw. Mr. Dreer had a new style of this French race, called "Odier" breed. They are of a golden bronzy hue, and promise much novelty and interest. A collection of the "coming" plant the *Echeveria* was on exhibition, we believe, by Mr. Sherwood; but so many things not having contributors' names on them, render a reporter's duties somewhat uncertain as regards accuracy. From Meehan's Germantown nurseries, a lot of the wild English Primroses—the Primrose of the poets—was contributed. These were arranged so as to form a bank of blossoms. There was not much in the way of hardy novelties. Mr. Buist had *Viburnum macrocephalum*, one of the Japanese Snowballs, quite as beautiful as its colleague, *V. plicatum*, now becoming much known and admired. Mr. Meehan exhibited from Mr. George Such, of South Amboy, a plant of *Ruphiolepis obovata*, a plant with white flowers like the wild Amelanchier or Indian Cherry, but with leathery evergreen leaves like *Pittosporum*; it is believed to be hardy. Mr. Buist also had some new tricolor and double-bedding *Geraniums*.

With the present encouragement, there will no doubt be competition from great distances; and schedules can be had from Secretary Harrison.

# The Gardener's Monthly.

DEVOTED TO

*Horticulture, Arboriculture, Botany and Rural Affairs.*

EDITED BY THOMAS MEEHAN.

*Old Series, Vol. XIII.*

MAY, 1871.

*New Series, Vol. IV. No. 5.*

## HINTS FOR MAY.

### FLOWER GARDEN AND PLEASURE GROUND.

We are very glad to note that the purely *not* *ural* style of gardening is finding its proper place in popular estimation. Like most good ideas, it was taken hold of by abstractionists, and stretched so thin, that it would not carry the pleasure anticipated. No doubt *nature* is pretty in itself, if not altogether lovely, as the sentimentalists tell us; but we think gardening is an art which is to produce for us something rarely or never seen in nature. Indeed, we are almost tired of the talk about the natural style in gardening, and find ourselves often in the position of those Israelites who longed for the onions and cucumbers, and flesh pots of Egypt, in spite of the pictured beauties of the promised land. We often look back on the old Dutch or Italian gardens, with their walls and terraces, and vases, and clipped trees, and see a great deal of beauty which we altogether miss now. There was, to be sure, often exaggerations of taste—frequently many things in such gardening which was ridiculous; but there were flowers of all kinds—sweet flowers, which when bathed in the dews of the early morning, gave us something worth rising with the lark to enjoy, instead of as now making us feel that an hour or two, more or less, in the early day is nothing particularly lost, so far as the garden is concerned. We should by no means like to part with the beautiful groupings of trees and shrubs which are amongst the most admired characteristics of modern gardening. Those beautiful ideas which float in the mind of the landscape gardener, and which he manages to make speak to us through his combinations,

in the most musical of nature's language, could never be conveyed to us in the dead utterances of the past style of gardening. We do not want to part with our gay bedding plants, either when grouped for their gaudy colors, or for the brilliant and subdued hues of their foliage; but we do want to see again those sweet innocent things, clothed in a glory greater than Solomon's, which that system did so much to fill up our gardens with. We have so much more to fill up the beds with than they had; and could make them still more charming. Even the beds themselves could be bordered with things which they never thought of. For this they were confined to dwarf box. We have now for edging, several things quite as good, which adds much to the variety. A very good thing is the arborvite named by Ellwanger & Barry, called Tom Thumb,—or the closely allied Heath leaved, which the writer of this introduced from Germany. The Globe Arborvite, *Thuja occidentalis globosa*; and the bluish Booth's Globe, *Thuja occidentalis pumila*, are both excellent edging plants. Another very pretty thing introduced by the writer for this purpose, is the *Evergreen Candytuft*, which, in addition to the pretty dwarf evergreen habit, has pure white flowers in April. It is likely to be cut by cold winds in winter, but in the average of places it does very well.

Who of us who has any gray in his hair, but remembers how beautiful the gardens used to look studded all over with the plants which used to be kept in tubs or large pots during the winter in cellars or the "orangery," expressly to be used in summer decoration. We hope to see these times again. The following are some of the plants we used to have.

Magnolia fuscata, Pittosporums, Clerodendron Bungei, Hydrangea, Figs, Oleander, pink and white; Pomegranate, single for fruit, and double for show; Bignonia capensis, Bouvardia tryphylla, Oranges, Lemons, Laurel Bay, Laurustinus, New Zealand Flax, Mahonias, particularly *M. Darwinii*, *Euonymus japonicus*, Aloes, Agaves and others. In very cold climates Peaches, Nectarines, Apricots and Plums might be grown in this way, and would not only charm the eye during the flowering season, but add their mite to more material pleasure in a way agreeable to most persons of taste, if not of refinement.

The first week in May is usually the time to set out Dahlias. They do best in a trenched soil, say 18 inches deep at least, and prefer cow-manure to any other when it can be obtained. If planted on thin or dry soils, they will not bloom till near the approach of frost, when the chief enjoyment of the Dahlia is lost. It is best, where possible, to plant a duplicate of each kind.

Tuberoses and Gladiolus like a warm rich soil, and may be set out at once.

In transplanting any thing that has roots large enough to admit of the practice, it is best to dip the roots, immediately before planting, into water. This will obviate the necessity of after-watering, and its consequent injurious effect. If the plants appear to flag, shade or put an inverted flower-pot over the plant for a few days; if this do not bring the plant to, it must have water.

Flower-gardening, as we have often said before, affords scope for many pretty fancies, besides arrangement of color, which, in the hands of a person of taste, render a garden a paradise of enchantment. Borders and edgings of Ivy, Periwinkle or variegated plants, may be made to appear as frames to the pictures of pretty flowers enclosed by them. Waves and fringes of green may be led along through a large flower-bed, and the various divisions formed be filled with its own color, making a natural and living bouquet; different colored gravels may be chosen for paths between beds; different shades of green may be made by the selection of grasses of different hues, where grass walks are employed. Old stumps or roots may be occasionally introduced in the centre of beds, and covered with green vines, or flowering climbers, as taste may dictate; rustic baskets and vases, and even in

many instances where artificial styles prevail, the topiary art may be called in, and good effects result from the use of the knife and shears on certain plants.

Trellisses and stakes for climbing plants and vines should be put in at or before setting out the plants. These plants always seem to grow with more freedom and vigor when they can find something at once to cling to. Climbing vines add greatly to the interest of a garden. They can be trained into all sorts of forms and shapes; and many of them, for gracefulness of form, or beauty of their flowers, cannot be excelled by any other tribe of plants.

In planting extensive flower gardens, it is best to retain a few plants in pots, in case a frost or other accident should, by chance, destroy some of those set out earlier.

Pansies and Daises should be set out in rather a shady and moist place,—not under the shade of trees, as the roots of these dry the soil too much.

The Hollyhock has become one of the most popular and useful of summer bedding plants. They like a rich, warm, and rather dry soil.

The Carnation likes a deep, rich soil; the plants should be raised from layers afresh every year. July is the time to do this.

#### FRUIT GARDEN.

Watch all young fruit trees against bearing too abundantly while young, or the first season after planting. There can be no objection to the ripening of one or two fruits on a tree the first season of setting out, in order to test the kind, or to administer to curiosity, if the tree be otherwise growing freely. If little growth is making, no fruit at all should be permitted. It is a better practice to disbud or take out soon after shooting all shoots that are needless to the perfect shape of the tree, than to wait till fall or winter. The pruning knife need then only to be used to shorten a branch into where several branches are desired to push, or to induce a more vigorous growth from the pruned parts. In the gooseberry, raspberry and strawberry also, no more shoots should be suffered to grow than will be required to bear the next season.

In summer pruning or disbudding, it is also worth while to watch for shoots pushing stronger than others, and always take them out. This is the only way that shoots of equal strength can be encouraged in every part of the tree. This is

particularly true of grape vines. If a shoot once get the start of the others in strength and vigor, the others will gradually get weaker to the other's increasing luxuriance.

When the strawberry crop is about to ripen, mulch with clean straw, to prevent rain soiling the fruit. Short grass from the lawn is often used; but it mildews as it decays, and detracts from the flavor of the fruit. Hot suns increase flavor, and strawberry tiles were once in fashion to put around the hills, which, by absorbing heat, added greatly to the fruit's rich quality. All that we have said of strawberries supposes them to be fruited on the hill system, with the runners kept off. Those who desire the best results, will grow them no other way.

It is gratifying to note that the great scourge of American fruit growing, insects and birds, are getting more and more under control. We recognize the fact, that we must do something ourselves,—that in the "sweat of thy brow" only shall we have fruit as well as bread. Whenever there has been any care taken to drive away birds, or gather insects together, there has been success quite commensurate with the labor bestowed. It may be well to remind the reader that for a great variety of insects, there is nothing so good as wide mouth bottles, with sweet liquid to trap them with.

#### VEGETABLE GARDEN.

In raising vegetables, it is particularly important that the soil should be very rich. In fruit or grains, good soil is of course requisite to success; but in vegetable growing, great succulence is the first great aim, and this cannot be secured without great abundance of manure. Cabbage,

Cauliflower, and Brocoli are to be set out at this season, and these particularly want rich soil. This is also the case with Lettuce. As the weather gets warm, it soon runs to seed, and only very rich soil will produce it good enough for summer use. String Beans are truly stringy when grown in poor ground, but when sown in rich deep soil, any kind is a "snap-short" as well as the early "Valentine," which usually bears this name.

Melons, Cucumbers, Corn, Okras, Squash, Beans, Sweet Potatoes, Lima Beans, Peppers, Egg-plants, Tomatoes, and other tender vegetables that do not do well till the sun gets high, and the ground warm, should go into the soil without delay.

Bean poles should be set before the beans are planted; and near cities where they are comparatively high priced, their ends should be charred. This will make them last some years.

Keep weeds of all kinds down from the time they first show their seed leaves. It not only saves labor "in the end," but the frequent stirring of the soil vastly serves the crop. Sow a succession of vegetables every few weeks,—sometimes insects, sometimes frost, or occasionally other accidents will cut off a crop, and then there is some chance for its successor not wholly to disappoint.

In planting Tomatoes, remember the advice of Mr. Blodgett, and others in our magazine, to plant them to stakes, or against a wall or fence. The fruit is much better, and the plants more productive. Set the stakes in the ground before planting, as we do for the Lima Bean. The stakes need not be over 6 feet high, and if they have snaggy portions on them, all the better for sustaining the plant.

## COMMUNICATIONS.

### REMINISCENCES OF AUSTRALIA.

BY MR. W. T. HARDING, BRIGHTON, MASS.

The hot winds with which all are unhappily familiar, who cast their lot in Australia, had been blowing with an unusual degree of intensity, which has often been described as a "red-hot wind." Withering and enervating, it effects

both man and beast; neither does it spare the vegetable kingdom its fiery blasts. "The flowers of the forest," the trees and shrubs, and even the grass becomes flaccid, and seem for the time while passing through so scorching an ordeal, to have lost their vitality. The noisy parrot and cockatoos were happily silenced for a

time; and for once a sympathetic feeling of supineness, languor and prostration was shared alike by all created things.

The third day, with its attendant miseries, had passed; and the morning was ushered in with a more life-breathing atmosphere. We "struck tent," and proceeded onward, followed by a number of aborigines, who carried the panniers, which were well filled with specimens of plants, roots and seeds which I had collected, labeled, and carefully packed, with the remainder of our scanty provisions. Of what subsequently occurred during that eventful day, I will briefly relate.

One of the party, who had assumed the name of Boston, after his native city, accompanied us, having met with him on his way back to civilization and the "States," as he termed it. He had been a "stock-rider" or keeper, five long years in the wilderness; and his heart fondly yearned for the "home of his youth and its happier days." Poor wail, he had been a luckless wanderer "o'er many lands." By his knowledge of the bush he proved useful to us as a guide, whose footsteps we followed through a deep gorge to a more open valley, which was thickly covered with the most varied and beautiful specimens of New Holland plants I ever beheld mingled together. Memory went back to Chiswick, when in its palmy days; and the Regents Park exhibitions, where the choicest of England's floral gems were gathered; but they seemed meagre when compared with the grand exhibition around us. But sad is the sequel to so fair a scene. Ascending from the valley, and listening to the dulcet tones of "Boston's" flute, as he played the plaintive air, "Home, sweet Home!" in a moment up rose one of the most hideous serpents I ever saw, and reared its disgusting body some six feet high, and with distended jaws, hissed in the face of our guide. Poor fellow! the melody suddenly ceased, and the musician staggered and fell. At the sight of so fearful a monster, all fled in terror from the spot, excepting the "blacks," who immediately "showed fight." In the meantime, the loathsome creature stood erect, and with its devilish looking eyes stared around. Whir-r-r went a "boomerang," dexterously thrown by one of the "blacks," which struck down the snake, and while floundering about, was soon despatched with their "waddies." Thinking poor "Boston" was in a swoon, we carried him a short distance and laid him be-

neath the shade of some magnificent tree ferns, *Cimbotium Billardii*, whose elegant fronds waived some forty feet high. Near by, grew some fine she-ak trees, — *Casuarina quadrivalvis*, *C. torulosa*, *C. equisetifolia*, and *Exocarpus cressiformis*. The landscape around was grand indeed; just such a sublime scene as an artist would select to portray, or a lover of nature to linger in and exclaim, "how manifold are Thy works, in wisdom hast Thou made them all!"

Every effort was made to restore our companion. Supposing he was in a protracted syncope, venesection was tried, which failed to show any signs of life. Alas! all was in vain, for the heart had ceased to beat, and the hand that had so tenaciously held on to life, had relinquished its hold, and the spirit had fled. Silently our vigils were kept through the night, as we steadfastly gazed on the face of the dead. "The windows of heaven were opened," and through them poured a flood of light, as the moon looked serenely down from her vaulted casement above. Towards midnight, a breeze shook the foliage around, and gently waived the long pendant branches of the *Casuarinas*, which produced a most peculiarly wailing sound, so like a requiem for the dead. During the passing excitement, we had forgotten the "blacks," having left them with the snake. Returning to look for them, while preparations were making for the interment, to our great surprise they were not to be seen. Scattered around the embers of a fire, were portions of the vertebra of the snake. They had evidently cooked and eaten the body and then deserted us, carrying off the panniers which contained the provisions and specimens, which were somewhat mixed together. While looking around, my attention was called to "Boston's" flute, which rested upon a beautiful bush of *Pimelia linifolia* in full bloom, which I carried away and laid in the grave with all that was mortal of its owner, who had so suddenly passed away, literally frightened to death. With feelings of sadness, we left his grave, after planting an *Epacris pulchella*, a *Boronia serrulata*, a *Eutaxia* and *Gompholobium*, four of the prettiest plants I could find.

Returning to the *Casuarina* subject, I may say they are trees of large dimensions, whose long and slender branches have much the appearance of a horse's flowing mane. *Casuarina equisetifolia* is a lofty and wide spreading tree, so is *C. torulosa* and *C. quadrivalvis*. I saw

the trunk of a very large tree an ignorant fellow had cut down, which was not a "labor of love" by any means. It grew near to his hut, and as he said, "he could stand it no longer, for whenever the wind got up, it sighed and lamented so, it made him feel miserable." Evidently he had no music in his soul, or he would have known that he was chopping at "the harp with a thousand strings." The wood is almost as heavy and hard as iron, and is used by the natives to make their weapons of, and is known to them as the She-ak, which the settlers have somehow twisted into the oak.

The *Exocarpus* is an evergreen much like a cypress in growth and appearance, and attains to a height of sixty or seventy feet. It has been described as "the native cherry, with the stones growing outside the fruit." The name certainly indicates such to be the case; but why called a cherry I cannot imagine, unless it is on account of the color being "as red as a cherry," and there being a bare possibility of swallowing a few. The fruit resembles that of a *Taxus*.

It is a singular fact, that there is neither a fruit or vegetable indigenous to Australia worth growing or eating, the mushroom excepted; and yet may it be called a land of paradise. Of which, more anon.

---

### WINTER FLOWERS.

BY J. M., PHILADELPHIA.

Passing through the greenhouses of Mrs. Geo. W. Carpenter, a few days ago, I noted in bloom many plants, the list of which I propose to give, as a guide to those who wish to grow plants for winter decoration. It will be seen that the list contains not so much new plants, as those which have been proved useful and good: *Siphocampylus bicolor*; Chinese *Primula*, beautifully fringed; *Abutilon album*, a splendid plant, with over one hundred expanded sulphur-colored flowers on, probably the best of the commonest known ones out; a new variety *Abutilon petuniflora*, a rosy flesh, promises to be a good thing; *Bignonia venusta*, climbing over the rafters, and covered with its trumpet-shaped flowers, was really uncommon: this is growing in a large tub, and has been undisturbed for some time; it is not usual for it to bloom so abundantly, speaking well for its treatment; *Daphnes*, *Salvia hispidula*, *S. involucrata* and *splendens*; *Gesnera oblongata*, a good kind for winter, easily kept, and with handsome leaves; *Heterocentron ro-*

*seum*, nearly over; *Lopezia rosea*, one of the prettiest and easiest cultivated of all winter plants; *Belleporone oblongata*, *Habrothamnus elegans*, *Fuchsia syringæiflora*, with flowers in bunches, like a lilac, and pretty leaves; *Aphelandra Ghiesbreghtii*, White *Lantanas*; *Eranthemum pulchellum*, just opening; *Bouvardias*, *Heliotrope*, *Olea fragrans*; *Sparmannia Africana*; *Chorozemas*, just opening; *Leonotis nepetalifolia*, a rather scarce plant with tubular orange flowers; an *Ardisia*, with much larger leaves than *crenulata* and blackish berries, name unknown; *Chorozemas*, *Camellias*—of these *Lady Anne's Blush* is the first to open—followed by a great variety of others. As desirable plants of *Geraniums* as could be wished, can be seen here. I have never seen better flowers in winter, the house being steep and dry, suits them well. The heads of bloom on *General Grant*, *Chance* and *Rosamond*, could not be excelled. Mr. Joyce, the gardener, considers *Rosamond* the best of all for winter. Its color is rosy salmon and white. Another large house is devoted exclusively to the care of the large specimens of *Bamboos*, *Fan Palms*, *Sweet Bays*, *Evergreen Magnolias*, and *Australian Plants*, used extensively for decorating the grounds in summer. The fine old *Sago Palms*, so often seen at the Pennsylvania Horticultural Society, are in this house. Mrs. Geo. W. Carpenter, with members of her family, have been for some time sojourning in Europe, and we understand, contemplate staying there a considerable time. A visit to these grounds in summer, when the large tub plants are intermixed with the statuary, would well repay one; or in winter, when its storms drives you within doors, how doubly welcome is its shelter, when the charms of such greenhouses as these are added.

---

### FLOWERS.

AN ADDRESS DELIVERED BEFORE THE FRANKLIN COUNTY (PA.) HORTICULTURAL SOCIETY.

BY REV. P. S. DAVIS.

*Mr. President, and Ladies and Gentlemen:*—My professor of natural science at college gave me credit for being the best ground squirrel catcher that belonged to our botanical class. That was the only compliment the conscientious man could ever pay me; for during all our rambles over hill and through dale, I had no sympathy with a science that made the rose a monster, and the most beautiful varieties of that queen of

flowers mere hybrids. So I further concluded that pulling plants to pieces and counting the petals was like the child's play of breaking the drum to see where the sound came from; and that chasing "chip-monks" was more refreshing. I have changed my opinion on the subject as the hairs on my head have become less. And although I know nothing about Botany, I have long since coincided with wiser men, that the science of plants opens a vast field of useful and delightful knowledge to those who press their inquiries on her domain.

True, science has sometimes "run mad." There have been botanical fools as well as chemical fools and theological fools, in the times that are past. Mary Howitt, to whom I am indebted for some facts,\* speaks of a very curious book published about 1631, by a German, on the rose, in which two hundred and fifty mortal pages are devoted to the curative properties of that flower in every disease—making it a universal panacea. The author also claims for it supernatural powers, particularly in driving away evil spirits. He also speaks of the re-production of the rose, as something that could be affected from its own ashes, like the fabled Phoenix, an idea which is gravely re-produced in a French work published as late as the beginning of the 19th century. This was called the *imperial secret*, because the Emperor Ferdinand III. purchased it of a foreign chemist at a very high price.

And yet the fact that men have failed to extract the elixir of life from the rose is no objection to Botany, any more than the failure of the old alchemist to find the philosopher's stone is an argument against chemistry, or any more than the failure of the old-school men to determine how many angels could stand upon the point of a needle, is an argument against Theology.

But independent of the classification of plants and the uses to which they may really be put by the man of science, every little incense breathing flowret has a rich store of joy for any man who will but study it closely. For example, I have copied before me an extended statement by a distinguished man in regard to the tiny flower known as the Daisy, in which he shows that this little beauty, so small and delicate, contains between two and three hundred flowers; that every leaf and stamen and pistil is itself a perfect flower, having each its corolla,

stamens, pistil, and fruit, so that we can see how much is compressed into the calyx of that one little gem; and I cite the instance to show how our pleasure may be increased by a close examination of these things.

But flowers afford pleasure to those who may see and handle and trample on them all their lives, without ever suspecting the multiplied glories revealed by a minute examination of their structure. Poor Burns appreciated the wee crimson-tipped daisy he turned down with his plowshare, more than Rosseau, to whose description I have just referred. There are no grotesques in nature, no ridiculous fancies made merely to fill up space, and God has scattered his beauties for men who cannot, like Solomon, discourse on all the plants, from the cedar of Lebanon even to the hyssop on the wall. Our Divine Redeemer did not address a Botany class when he said, "Consider the lilies of the field." Indeed the multitude of men must be satisfied to use and enjoy what the few are given to know and understand. I know nothing of *materia medica*. I apply an arnica plaster and take senna and Peruvian bark, when my physician says I ought to do so, and in this I show more faith than some people when they listen to their preachers. In fact, it is a law of our being that we must use and may delight in most things, before it can be expected that we should come to any proper understanding of them. The man who would refuse food until he knew all about albumen and how much is in his bread and potatoes, would be set down as a fool, deserving to starve, as he surely would have done before he was old enough to make the inquiry.

The same truth holds good when we leave the sphere of the strictly useful, and go out into the realms of what men call the purely beautiful. We opine that Noah never thought of analyzing the hues of the rainbow, and yet the old patriarch doubtless had more delight in it than Humboldt had in anything he ever found while studying the *cosmos*.

The use I would make of this general fact in its application to the world of flowers, is to show that the masses of men who can never expect to have any scientific knowledge of it, or even to be close observers of the wonderful organization found there, may yet find great and varied enjoyment in it. And in this connection it may be well to call attention to the fact that men have almost everywhere and always obeyed the promptings of nature, and used flowers for

\* See a short article in a volume of Boha's Illustrated Library.



the purposes of ornamentation. I was astonished some time ago to see it stated by Mrs. Gore, that there are roses indigenous to the extreme Arctic regions. "Not only do they unfold their pink corollas there, but the Esquimaux decorate their hair, the reindeer and the seal skins in which they are clothed, with the beautiful blossoms." Indeed the whole world seems to have said with Solomon, "Let us crown ourselves with rose-buds before they wither." A few facts in regard to this may not be uninteresting to those present.

The cultivation of flowers for ornament is mentioned in the oldest Coptic manuscripts, and the celebrated hanging gardens of Babylon, built by Semiramis 1200 years B. C., in which the choicest plants were raised, are familiar to you all. All the Eastern nations had a superstitious regard for flowers. Zoroaster tells us that every flower is appropriated to a particular angel, and that the *Rosa centifolia* (our common hundred leaved rose) is consecrated to an arch-angel of the highest order. The Turks suppose that the rose owes its origin to the perspiration that fell from the brow of Mahomet, and they never tread upon a rose leaf nor suffer one to lie on the ground. The *Rosa Damascena* (Damascus rose) was brought from Syria by the Crusaders, and it would be impossible for us to say here, how fully flowers have entered into the history of heraldry: that is, when used as devices on standards and banners, as the symbols of heroes, families and nations, in their struggles for honor, fame and power. The lilies of France, and the red and white roses of the houses of York and Lancaster during the thirty years' war in England, are good illustrations of this.

Among the Greeks, whose idea was that the highest good culminated in the beautiful, there are many references to flowers. This idea entered into their mythologies, and all their historians and poets constantly refer to flowers. Every school boy who has had his ears boxed over Homer, knows how he describes Aurora with rose-tipped fingers filling the air with their perfume.

The Romans, however, carried the luxurious use of flowers to the greatest height, covering the couches of their guests and their banquet tables with them. Some of the Emperors scattered the hall of their palaces with them. When Cleopatra went to Cilicia to meet Mark Antony, she gave him a succession of festivals which displayed a royal magnificence. On the fourth day

the Queen carried her sumptuousness so far as to pay a talent for a quantity of roses, with which she caused the floor to be covered to the depth of eighteen inches. But the greatest profusion of flowers mentioned in ancient history, and which seems scarcely credible, is that which Suetonius attributed to Nero. This author says that at a fete which the Emperor gave at Baiae the expenses incurred for roses alone were more than 4,000,000 sesterces, which equals £20,000, or nearly \$100,000. At this, or some other reception at Baiae, when the entertainment was given on the water, the whole surface of Lake Lucina was covered with roses.

At first, the Romans brought their flowers from Egypt at those seasons of the year when Italy could not produce them. But afterwards, to render these luxuries more easily attainable during the winter, the Roman gardeners erected green-houses, warmed by hot water pipes, and by artificial temperature kept roses and lilies constantly in bloom. They carried their hot houses to such perfection, that in the reign of Domitian, when the Egyptians thought 'to pay him a splendid compliment by sending roses on his birthday in winter, their present excited ridicule. It was like hauling coals to Newcastle.

If any one thinks of furnishing this society with the means for a grand display from year to year, and wishes to be encouraged by precedent, I would refer him to the following scrap of history taken from a French Universal Biography:

"Clemence Isaure, a French lady who lived in the latter part of the 15th century, bequeathed to the Academy of Toulouse a large income, exclusively for the celebration of floral games, and the distribution of five prizes for as many poems. The prizes consisted of an amaranth and a rose of gold, and of a violet, marigold and lily of silver. The will also required that every three years, on the day of the commencement of the floral games, the members of the Academy should scatter flowers on her tomb. Bonsard, the French poet, took the first prize, and received in lieu of the accustomed rose a silver image of Minerva. Mary, Queen of Scots, was so much delighted with the poem that she sent him a magnificent rose valued at £500." But enough on this point.

The general sentiment the world has expressed by flowers are those of love, honor, refinement, charity, holiness and happiness. In looking up this subject at the request of this society, I have found one or two exceptions to

this. A synod at Nismes, about A. D. 1284, ordered the Jews to wear a rose on their breasts, that they might be distinguished from Christians and not receive the same attentions. At one time, too, in certain parts of Germany, a crown of red roses was the punishment of immorality. As an offset to this, we may mention a beautiful custom that prevails in the Valley of Engadine in Switzerland. If a man accused of a crime is able to justify himself, the day on which he is delivered from prison, a young and beautiful girl presents him with a white rose, called "the rose of innocence."

Seneca made a raid on the green-houses of Rome, and denounced them as tending to edemiancy and vice. He tells one rich old curmudgeon that he could not sleep if one of the rose-petals, with which his bed was spread, happened to be curled. And Cicero, who rendered Verres immortal by the unmerciful castigation he gave him, tells that citizen not only that he is a robber; but such a lazy, effeminate libertine, that he would not know when spring came if he did not see the flowers in bloom. But Seneca, great as he was, could not do away with the green-houses. It appears, however, that some of the nobles did appoint a board of eminent physicians to determine what kind of flowers were suitable to place in crowns, without detriment to health; and that the doctors reported the parsley, the ivy, the myrtle, and the rose as possessing peculiar virtues for dissipating the fumes of wine.

Less men than Seneca and Cicero might have told emperors and patricians that if their palaces had not been hot-beds of iniquity, seething with drunkenness and licentiousness, the wreath put on their virtuous brows would not have killed them, even though their courts had smelled like the city of Cologne, where a great English poet says he recognized seventy two separate and well defined odors, some of them not very pleasant.

We of course repudiate the idea of the old German already alluded to, who found in the rose a universal panacea even for physical evils. Had this virtue been found, Nero and Marc Anthony might have been spared. But to relieve all the disorders with which our humanity is afflicted, there must be in the remedy some inherent quality sufficient to cure *sin*. There is only one Balm in Gilead sufficient for that. And this leads me to remark that what I have yet to say will be in regard to flowers viewed from a *Christian stand point*, and if you will bear with

me yet longer, I would like to inflict a few of what my little daughter calls my "*Christianary ideas*" upon you. I must premise however, that the world has its aesthetic tastes. The beautiful *can* be looked upon and enjoyed in its measure in the sphere of nature, as over against the sphere of grace. Athens was once the most refined city in the world, and at the same time the most idolatrous and immoral. During the middle ages, the cultivation of flowers, as well as art, in the northwest of Europe, was confined to the monks and nuns, who kept their gardens while every one else was off at the wars. But the church does not now monopolize these things. Some people who make no pretensions to Christianity appreciate flowers more than many very pious persons do. There is a worldly thrift and taste that often expresses itself in this way, and although Christianity without flowers is better than flowers without Christianity, it is certainly better to have the flowers alone than neither Christianity nor flowers.

We do not usually find the people who love and cultivate flowers to be the worst and most improvident members of any community. People whose ideas are entirely utilitarian—in whom the beautiful things of the world excite no emotions, are oftenest contracted and illiberal in all their views—moral dyspeptics; and when all the innocent and legitimate pastimes by which the toils and cares of life may be relieved are ignored, we are apt to have great stupidity, or what is worse, gossips and busy bodies in other men's matters. Louis Napoleon understood this. He was always amusing the French to keep them from malicious mischief—to himself. The ancients had this idea, too. They consecrated the rose to Harpocrates, the patron of silence, of which it was the symbol, and they presumed that when they could say anything to a man—or woman—under a rose bush, they could say it *in confidence*. That was just the meaning of their *sub rosa*.

It was the custom in some of the northern countries, too, to suspend a rose over the table at their feasts, to remind the guests that honorable silence was to be preserved in regard to every thing said during their meals. A little of that old Roman honor, pagan though it was, would not be amiss now. You may think this suggestion uncharitable, but if you were up here speaking, you would say that if you could enforce the code, you would make many that you wot of take breakfast, dinner and tea, lunch

between meals and strawberries at night, *sub-rosa*. You would pen them up between silence and starvation. And it would do you good to see two chronic gossips chewing and swallowing opposite to each other, with the dread consciousness that they dare not say one dishonorable word about what they might hear. The effect upon them would be such as arsenic and water are said to have had upon rats, in the good old times when adulteration did not belong to the apothecary's art. Many a person's first mouthful would prove the death dose, but you would say, "If the rose can drive away the evil spirit, let the bush be planted, even though he tear some as he goeth out." The preachers and churches would have a good time generally; the lawyers certainly, and even the doctors would have more leisure, for there would be less sickness because less wounded, troubled, broken hearts. Ah! though the rose may be appointed of God as means to help keep the mind in proper, healthful channels, they cannot, as the old German supposed, exorcise the Demon. The strong man keepeth his palace, and until a STRONGER ONE come his goods are in peace. Only He who met and conquered the old enemy, when He was manifested to destroy the works of the devil, can vanquish him now.

All this by way of parenthesis. I started out to say only that even in a worldly point of view, honor and flowers ought to go together. Moreover, I have noticed during a ministry that has extended through half of my life time, and chiefly among the poor, that those people in the humbler walks of life, whose natural promptings have led them to whitewash their cottages, and train the jessamine and morning-glory by the door, or plant the marigold in the yard during the summer, are not *generally* the persons to whom my deacons have had to carry coal and potatoes in winter.

Conceding, then, the beneficial effects that may be said to flow from the cultivation of flowers in a worldly point of view, what we wish to insist upon is that nothing can find its true meaning outside of Christianity, which alone can sanctify our tastes and make our joy in them perennial, and that in all this we have higher incentives than the old Greek had when he taught his boy to study and admire the works of Phidias.

Even refined paganism taught that the highest beauty culminated in the service of the gods,

and if they were impelled to invest deities as the patrons of flowers, why should we ignore Him who "clothes the lilies of the field?" Indeed it is wonderful how flowers have entered into the religious life of the world, and how in all heathenism we have dim adumbrations or shadowings of what is told us by revelation. Into this field I may not enter, but let me give one instance. Zoroaster tells us that the stem of the rose had no thorns until the entrance of Ahrim-anus (the evil one) into the world. Here we have evidently a stray gleam from the burning bush, for this is just the truth that the Bible declares. When God made man, he placed him in an Eden of beauty, and when man fell he involved his whole heritage. The earth was cursed for his sake and doomed to bring forth thorns and thistles. Every one who contends with weeds and briars, feels that this curse is a dread reality, that reaches away down to the very soil on which we tread. Flowers, then, comport with innocence, and thorns with sin.

But now this law of sin and death is to be reversed. A Deliverer is promised, by whom the curse is to be removed, and when his triumph is predicted it is in this language: "The wilderness and the solitary places shall be made glad \* \* the desert shall rejoice and blossom as the rose. It shall blossom abundantly and rejoice even with joy and singing; the glory of Lebanon shall be given unto it, the excellency of Carmel and Sharon, they shall see the glory of the Lord and the excellency of our God.—Is. 35: 2.

If then the restoration is to be as much of a historical reality as the curse is, the bloom of Eden must be renewed, and the evil one will not be permitted to say, "Although man has been redeemed, I hold his heritage." He will not be able to say, "The blighted Eden spoken of in the *first* part of your Bible was a fact, but the new heavens and the new earth described by St. John, in the *last* part of your Bible, and promised as the restored paradise into the which the redeemed shall enter, must ever remain a fiction." No, even the plants and flowers of the earth are to "see the excellency of our God," and this thought is one to which the Christian ought not to be indifferent.

It is remarkable that He by whom all this is to be effected, has many names given to Him from the world of plants, as "the Root and Stem of Jesse," "the Branch," "the Balm in Gilead," "the Rose of Sharon," and "the Lily

of the Valleys." And it is further remarkable that in the song of Solomon, the love of Christ for His Church is set forth under the image of a lover in a garden of flowers. But I would yet call attention to the fact that the use of flowers in religious decoration is spoken of in the Bible. The high priest's dress, and some parts of the tabernacle, with its sacred furniture, were decorated with the blossom of the pomegranate and the almond, and as this was done by Divine directions, no one dare cavil at it.

He whose lips were touched with a live coal from off God's altar, and who spoke as he was moved by the Holy Ghost, uttered this prediction: "The glory of Lebanon shall come unto thee; the fir tree, the pine tree and the box together, to beautify the place of my sanctuary, and I will make the place of my feet glorious." This prediction has been fulfilled in the custom of the churches that adorn their houses of worship on festival days. And this custom is no longer confined to the old German and English churches, but is coming into vogue among those who do not lay so much stress upon the regular festivals. The late centenary celebration of Methodism in this country witnessed many a floral offering, and at the meeting of the united Assemblies of the Presbyterian Church, just held in Philadelphia, the sacred edifice was festooned with evergreens, and their pulpit and communion table were crowned with flowers. I like my Methodist and Presbyterian brethren all the better for that. And if any long faced croaker should speak to me of it as an evidence of a decline in what he would be apt to call their "vital godliness," I would respectfully differ from him; but if he should go farther, and seriously say that they were worshipping flowers, it would take all the little grace I have to keep from thinking him a donkey that had been feeding on thistles all his life. But even if it were established that a man must make an idol of everything brought into our churches, it were better then to adorn our chancels with flowers, than to litter them up with hats, overcoats, umbrellas and muddy gum shoes, which you would expect any refined pastor to leave outside of your parlors.

A minister of our own church once preached a sermon against the time honored custom of decorating churches, because, as he said, it was hostile to spirituality; as if there was something essentially spiritual in bare walls. He took the text, "Worship the Lord in the beauty

of holiness." Unfortunately, he found it in the book of Chronicles, where we are told God built the most gorgeous temple the world ever saw, and the text itself means in the original, "Worship the Lord *with the ornaments of the sanctuary.*" If he had quoted the whole song from which his text was taken, he would have read these words, "Then shall the trees of the wood sing out at the presence of the Lord." Men will find out one of these days that it is a terrible slander to say that our most holy Christianity is to be represented only by what is poor and ugly and mean, and that if that is only done, the spirituality may be taken for granted. God ordered the richest and best of everything for His temple of old. The wise men from the East brought gifts, gold, frankincense and myrrh to the infant Jesus. When the palm-branches were strewed in the Saviour's way, it was the Pharisees that protested, and not Christ Himself. The woman who poured the precious ointment made of the nard plant at the Saviour's feet was commended by Him, and built herself a monument lasting as the gospel itself. It was not the most spiritual of the disciples, but a gold loving Judas, who said, "Why was all this waste made?" The early Christians had a great many flowers in their services on the festival days. Whitsuntide, or White-Sunday, received its name, as is generally supposed, from the white dresses and flowers used on that day. These things could not then, nor can they now, add anything to Christ, any more than Mary's ointment could, but He can add something to them, by sanctifying our tastes and associating them with that which is holy, and thus symbolizing the Paradise of God, which will re-appear whenever the creation shall be delivered from the bondage of corruption unto the glorious liberty of the sons of God.

Tell me not, then, that the gold does not sanctify the temple. It is enough for me to know that the temple sanctifies the gold. I love flowers, and I love them all the more because, as I hope, I love God, and I do not see why they should be excluded from our holiest activities and associations. I like M. Beecher's bouquets on his pulpit more than I like some of his smart but erratic sermons. I think if any one could be found with such a scrofulous mind as to object to a bunch of God's innocent flowers on His own altar, one might say to him what John Calvin said to the only person he ever heard object to the repetition of the Lord's

prayer, "Poor creature!" You can imagine such a one at his public devotions. You would be apt to see him with any of our modern hymn books in hand, standing on Jordan's stormy banks, and casting

"A wishful eye  
To Canaan's fair and happy land,  
Where his possessions lie"

You would hear of a "land of pure delight," and he would sing

"There everlasting spring abides,  
And never withering flowers,  
Death, like a narrow sea, divides  
That heavenly land from ours."

Oh, yes, his "land of pure delight" is full of flowers, by Divine appointment, of course, and it is, perhaps, well that he can't see all, for he might be impelled to commit suicide by drowning, for—

"Could he but climb where Moses stood,  
And view the landscape o'er,  
Not Jordan's stream nor death's cold flood,  
Could keep him from that shore."

See! anxious to get over where the flowers are, but he don't want any such superstitious nonsense here, and could hardly pray, "Thy will be done on earth as it is in Heaven." There are such jewels of consistency in the world, who, though they think flowers very wicked, do not object to thorns, especially if they stick them into some person's side.

My own opinion is, that the greatest enemies of our holy religion are not open revilers, but those professors who look upon our Heavenly Father as a merciless tyrant, and his service as a series of inexorable hardships. They may profess to be the antipodes of the Carmelite monks, but they differ from them only in placing purgatory on this side of the grave. They represent Christian duty as a heavy premium we must all pay in this world, as an insurance against fire in the next; and they would never take a policy themselves if they were not afraid of a future scorching.

These people make religion seem harsh and forbidding. They drive all the best music out of the churches into the opera houses, and then storm at their children if they go after it. And such people ought to have in reality, as they have to all intents and purposes, two sets of eyes, one set to "roll up in meeting," and another set with which to look at God's green earth and starry heavens. As it is, their *Christian* eyes see nothing but skulls in the rose bushes and cross bones in the skies. With them Chris-

tianity is a dry, hard, harsh, abstract theory, whereas it is, in truth, a *new life*, that ought to underlie our natural life and give tone and color to the whole constitution of the world in which God has placed us. For no one is bound to give up anything as a Christian which he ought not to be ashamed of as a man. And Christianity does not ignore any of our relations, or any enjoyments or pleasures growing out of them; it simply sanctifies them in such a way as to make them truly joyous. Nay, more, in the second Adam we may gain everything we lost in the first; and even the outward world, instead of being irredeemable, is to be restored finally, *though it may be through catastrophe*, to its pristine glory and claimed for the service of God. His grace and power are to be as far reaching as the blight of sin. He came that even the matter of which the outward world is composed—not simply the coarser parts of it, not simply what we see at Golgotha and Calvary, jagged rocks and bare earth wet with blood; not simply the rude wood to which He was nailed; not simply the wormwood that He drank, and the thorns with which He was pierced, but that *all* things, the richest and best of everything should praise Him; yea, that even the aroma of the plant and the fragrance of the rose should be brought to Him, (Luke 24: 1), not to purchase favor indeed, but as the offerings of joy, and the ointment of grateful love poured out at his feet. The Christian who does not appreciate this fact, comes short of his high privileges, if not of his most solemn duty.

These are my views, which, however, none of you are compelled to adopt. I would not force even my roses upon you. If you prefer *thorns*, you pay your money and can take your choice. But I love the flowers.

#### ACORUS JAPONICUS VARIEGATUS.

BY MR. JAMES TAPLIN, MANAGER TO GEO. SUCH,  
SOUTH AMBOY, N. Y.

I beg to call your readers' attention to this plant, than which there are few striped-leaved plants more ornamental. It will grow nearly a yard high in one season from small plants; one-half the leaf is a bright green, and the other white, which gives it a very striking appearance. Grows best in moist soil, or kept well watered; is nearly or quite hardy; makes a splendid edging to Cannas, Castor Oil plants or any other tall foliage plants.

[The pretty "Calamus" is also interesting by its very curious flowers.—ED.]

### FLOWER GARDEN DECORATIONS.

BY WALTER ELDER, LANDSCAPE GARDENER.  
PHILADA.

May is the famous month in the year for decorating the flower garden with "bedding plants," which consist of annuals, biennials and perennials. They are propagated in glasshouses, and sold in small pots; but when transported great distances by mail or express, they are tapped out of the pots with the balls of soil at their roots, and packed more closely to lessen the price of transportation. Our leading commercial florists are so very skillful in packing and shipping, there is scarcely any chance of failure or miscarriage. We have inspected the collections of those around us, and have received the beautifully illustrated catalogues of many at a distance; we are both surprised and delighted at seeing and learning of the many new species of merit introduced, and the numerous varieties of superior excellence originated since last year. The vast collections of indescribable beauty and diversity which all the leading florists have, are wonderful in the extreme; every fancy and every purpose of floral ornamentation can be suited. Among the genera of ornamental leaves for making "ribbon beds," we mention *Achyranthus*, *Alternanthera*, *Caladium*, *Coleus*, *Centaurea*, *Cineraria*, *Panicum variegatum*. There are many other genera with variegated leaves, the Silver-leaved *Geraniums*, &c. As for those of splendid blossoms, they are legions, and the beauty of their flowers is beyond our ability to describe; even the *Verbena*, *Petunia*, *Phlox Drummondii*, *Carnation*, and *Picotee* Pinks, and all the species of green leaved pinks, like *China* and *Mule* Pinks, are wonderfully improved, and surpass in the brilliancy, constancy and beauty of their blossoms, many of the new species. How can we describe the extraordinary improvements made upon the *Geranium* and *Fuchsia* families. Their blossoms are enlarged, made double, and made more highly beautiful, and their perpetual blooming established; their foliage is also enlarged and splendidly variegated; the same may be said of *Chrysanthemums* and *Dahlias*, and so with the *Rose* which illuminate the autumnal flower garden; and we cannot pass, unnoticed, the smiling dwarfs of spring, the *Daisy*, *Primrose*, *Polyanthus*, *Violet*, *Forget-me-not*, *Pansy*,

*Calceolaria*, *Cineraria*, *Feverfew*, the *Lobelia*, &c.; *Heliotrope*, *Sweet Alyssum*, *Mignonette* for fragrance; the *Lemon Napoleon*, *Variegated Mint* and *Geranium*, with sweet scented leaves. *Antirrhinums*, *Salvias*, *Larkspurs*, *Nierembergias*, *Lantanas*, *Gazaneas*, &c. The new *Hydrangeas* are splendid in bloom and variegated foliage; the ornamental grasses are also showy and beautiful; but the *Cannas* are altogether *too coarse and clumsy* for small gardens, but if grouped upon large grounds, they make a show. The annual climbing vines are very beautiful to train upon fancy wire-work, and they are needed for a diversity; and to complete a whole, the double *Zinnias*, double *Balsams*, double *Gillyflowers*, the rich *Cockscomb*, and *Globe Amaranthus*, are all of high value in floral decorations. The *tender bulbs* too are needed for their diversity and splendor of blooms; the *Japan Lilies*, *Gladiolus*, *Tuberose*, *Tigridia*, and the grand *Golden Lily*. Oh what a gracious Providence we are blessed with to make life pleasant.

### BLIGHT AND INSECT COMPOSITION.

BY MR. J. M. MATTISON, JACKSONVILLE, TOMPKINS CO., N. Y.

Some of our townsmen, with myself, paid \$50 for a blight composition, but I do not think it is equal to the following. My mode is:

25 ozs. of Salt, fine or coarse.

5 ozs. of Copperas.

3 ozs. of Blue Vitriol.

1½ ozs. of Saltpetre.

1 or 1½ ozs of Oil of Vitrol.

1 lb. of Babbitt's Concentrated Lye.

5 lbs. of hard soap, or 1 gal. soft soap.

Take an old iron pot, and put in the salt, with a sufficient quantity of water, then heat. Pound up the Blue Vitriol then the balance of the compound; if too hard, put in lard or harness oil until it is thin enough to brush on. Clean the roots of the tree, and cut out the borer; have a small brush something like a marking brush, and cover the wound. Then take the body and limbs. On the largest parts of the body and limbs I use a very small whitewash brush, 4 to 5 inches wide, and not very thick. This will make the varnish regular, and kill every insect. To every man that owns an orchard, it is invaluable. I have some 3000 pears and 1000 to 2000 apples, plums and peaches. I intend to hire a man in the spring, and let him go all over my orchard.

If this is worth anything to your valuable journal, please use it.

### AN ABSTRACT OF REMARKS UPON THE PLANTS OF SCRIPTURE.

BY GEORGE D. PHIPPEN.

(Before the Essex Institute)

The lectures, of which this was a condensation, were prepared for an entirely different purpose than presentation before a scientific association. There is much greater obscurity in our version regarding these plants, than would be the case were a new one now made which should include a better knowledge of the productions of Palestine and the neighboring countries, than was then possessed. The copiousness of allusions to the vegetable kingdom, throughout the Hebrew Scriptures, impresses with an interest, amounting to astonishment, all those whose attention has been called to the subject.

A large portion of the rich and glowing passages, from both the greater and lesser prophets, that have chimed their measured cadences into our ears from earliest childhood, are of this class, examples of which are here cited. So marked is this quality of Hebrew poetry, as seen in the Bible, that it was declared, by a learned man of the last century, to be botanical poetry, and who states that upwards of two hundred and fifty botanical terms can be found therein.

The glory of Lebanon, the excellency of Sharon, and the waving forests of Carmel have lent their aid to illustrate sacred themes.

The Lord is described as riding upon the wind, but his more gentle going is heard in the tops of the mulberry trees. The righteous shall cast his roots as Lebanon—they shall flourish like the palm tree—they shall sit under their own vine and fig tree. The thorn shall give place to the fir tree, and the myrtle grow instead of the briar—and all the trees of the fields shall clap their hands.

The New Testament is not so rich in metaphor. The lily of the field, the grain of mustard seed, the wild and good olive tree, the seed sown in weakness but raised in power, are familiar examples.

The remarkable range of temperature of the land of Palestine, from the snow-clad summits of Lebanon and Hermon, to the coast plains and to the deep and almost tropical valley of Jordan, is productive of a more varied vegetation than can be found anywhere within the same territory upon the surface of the earth. On her heights

are to be found natives of the colder zones, while in the Jordan valley grow plants not to be found nearer than India.

The mountains abound in oaks, cedars and pines; while the palm, the fig and citron find a congenial home in the plains or lower declivities.

Our familiar garden bulbs flourish along the water courses, and numerous species of Legumes and Labiates render the sandy regions less desolate.

Its anciently terraced and artificially watered hills were capable of a luxurious cultivation, and though now comparatively desolate, once supported a numerous population.

The region of ancient Jericho with its palms—the enchanting valley of Sechem—the gardens of Engedi—fig and olive groves and vineyards in great numbers, altogether impress us with its former wonderful fertility.

Immense grain fields and gardens of cucumbers and melons, each with its hut or lodge for the abode of a watchman, who remained during the ripening season to guard the fruit, were numerous and in some parts are still to be seen. Isaiah compares Zion “as desolate as a lodge in a garden of cucumbers.”

The plants represented might be divided into plants ornamental; plants used for perfume or incense; fruits, grains, woods, &c.

Of ornamental plants, the Rose, strange as it may appear, is not found in the Scriptures. The two solitary cases, in Isaiah and the Song of Solomon, where our version has the word Rose are thought to indicate a bulbous plant—an Amaryllis or Narcissus. The Rose of Sharon is therefore supposed to be the *Narcissus Tuzzeta*, a plant that freely abounds in the wilds of Sharon. The Rose of the Apocrypha is supposed to refer to a shrub, extremely common around the Sea of Gallilee and the water courses of that country generally, that is the *Nerium Oleander*, well known and cultivated among us.

Our native Apocynæ are of the same order with it, and all of them, though so beautiful, are more or less poisonous; indeed most milky-sapped plants should be regarded with suspicion. The sap of the Oleander is most virulently poisonous, and has even caused death. The powdered wood is sometimes used as a rat exterminator.

The LILY is the ornamental plant of Scripture; its flowers adorned, in relief, the brim of the Moulton sea; and furnished Solomon in his wonderful song with with one of its choicest

images. The Lily of the Old Testament differs from that of the New. The Hebrew word "Shusan" (hence our name Susan) is thought to mean the *Nelumbium speciosum*, a species of the Lotus, sacred and venerated by the Egyptian, Hindoo and Chinese. It is a water plant and once common in the rivers of Egypt and Syria. It is the most beautiful of all the Nymphaea, examples of which we have in our native water lilies and the famous Victoria Regia. The Lily of the New Testament, the Greek "Krina," is now understood to be the *Lilium Chalcedonicum*, a scarlet martagon, and not the Crown Imperial, as formerly supposed, which latter is a Persian plant, and never common in Palestine. The imported bulbs of this Lily [once compared to the scarlet robes of Solomon], can occasionally be purchased at the seed stores in Boston.

"Camphire with a pikeard"  
 "My beloved, is unto me a cluster of  
 Camphire in the vineyard's of Eugedi."

The plant thus rendered *Camphire*, is believed to be the Henna plant of Egypt and Palestine, the *Lawsonia inermis*; a most beautiful and deliciously fragrant shrub, whose flowers have been used both in ancient and modern times as an article of luxury and adornment. It belongs to the Loosestrife family, types of which we have in our cultivated and native Lythrums.

The BALM OF GILEAD and that rendered MYRRH, are the exuded sap from two species of *Balsamodendron*, i. e. the *B. Gileadense* and *B. myrrha*, belonging to the order Amyridaceæ, the plants of which abound in balsamic juices and yield frankincense, olibanum, balsam copaiba and other fragrant resins and gums. This order belongs exclusively to tropical India, Africa and America. It has some alliance to the Orange tribe, but differing greatly in its dry nut-like fruits. The Balm of Gilead is believed to be one of the earliest articles of commerce known, even as far back as the time of the patriarch Jacob, as the Midianite merchantmen, to whom Joseph was sold, were then on their way to Gilead to complete their camel loads with a choice supply of that costly balsam for the Egyptian market. It often sold for twice its weight in silver. It was cultivated only in the King's garden in Judea, the revenue from which belonged exclusively to the Crown.

Strabo speaks of it. Titus carried some of it to Rome. Pompey exhibited one of the trees in a triumphal entry. When Alexander visited Judea, one teaspoonful per day and seven gallons per year was the entire product.

FRANKINCENSE, so often mentioned in Scripture, is a gum from a tree of this same order with the last. It has been used from the remotest times by the Hebrews and Egyptians in their sacrifices. It exudes from the straight trunk of the *Boswellia-serrata*, a lofty tree, native of the mountains of Central India. Frankincense is still used as incense in Catholic churches, and somewhat as a medicine.

The LIGN ALOE, *Aquilaria Agallochum*, or Eagle-wood, is found only in Asia. It grows sometimes to the height of one hundred and twenty feet. The heart wood is loaded with aromatic properties, and is one of the most grateful of perfumes. It has been held more precious than gold. "All thy garments shall smell of myrrh, aloes and cassia."

This was one of the drugs, one hundred pounds of which Nicodemus brought after the Crucifixion, in which, with the linen clothes, was wrapped the body of our Lord; it was therefore a very costly preparation. We have no plant of more approximate affinity than our hedge buckthorn. The aloe of the apothecaries is an entirely different article, and obtained from a plant of the lily tribe.

SPIKENARD, of the Valerian family, has a most rare and agreeable perfume. Our garden Heliotrope and the Centranthus are of this order. Several of them yield a fragrance which intoxicates the cat tribe, and that from one of them is said to be sufficiently powerful to throw even man into convulsions.

The *Nardostachys Jatamansi*, of the mountains of upper India, seems conclusively proved by Sir William Jones and Dr. Royle, to be the plant which furnished the "Alabaster box of Spikenard very precious," with which Mary anointed the feet of Jesus, and which Judas declared might have been sold for three hundred pieces of silver; which price, among other unguents, is given by Pliny, who remarking on the extravagance of such preparations, says, "We have known the very soles of the feet sprinkled therewith." He also intimates the form of the alabaster ointment box.

"Spikenard and Saffron, Calamus and Cinnamon.—S. of S.

SAFFRON is the yellow stigma of the *Crocus sativus*, or fall Crocus, belonging to the well known Iris family, very common in cultivation among us. Saffron was and still is used as a perfume, spice, confection, dye and medicine. Its collection required great patience, four thousand flowers yielding but one ounce, and the entire product



of an acre for the season averaged but about ten or twelve pounds. It was formerly extensively cultivated at Welden in Essex, England, which hence has borne the name of Saffron-Welden.

A totally different plant, the *Carthamus tinctoria*, once familiar under the name of Saffron in our gardens, has been successfully used to adulterate the true Saffron.

*Calamus aromaticus* "the Sweet cane, from a far country," is allied to our sweet vernal grass.

[In fragrance.—ED.]

*Cassia* and *Cinnamon*, well known spices, were in the time of Ezekiel common articles of trade with the merchants of Tyre. They belong to a family of which our *Sassafras* and *Laurus benzoin* are examples. *Cumpher* of commerce is from a tree of the same tribe.

The *Hyssop* and *Mustard* of Scriptures, around which many inquiries cluster, are not so satisfactorily identified by modern investigation as would seem reasonable to expect. The former is declared by the best authorities to be the *Capparis Egyptica*, or Caper plant, and not the officinal herb, Hyssop; the latter, the *Salvadora Persica*, a tree-like plant, sufficiently large for birds generally to lodge in its branches. Some still adhere to the common Mustard as that alluded to on two occasions by our Saviour. The uses of Mustard were well understood and described by Pliny, who was nearly contemporary.

The FRUITS were identified and described. Among them the PALM tribe, a family acknowledged by botanists to be the princes of the vegetable kingdom, and to which, in Scripture, the righteous are most fitly compared. "They shall flourish like the Palm tree; they shall bring forth fruit in old age." The whole Palm tribe are of immense importance to the countries in which they grow. The *Date Palm* yields year by year, an even crop of perhaps three or four hundred pounds, and that for a century together, scarcely ever materially failing.

The APPLE of Scripture is, without doubt, the Citron, *Citrus medica*. "A word fitly spoken is like apples of gold in pictures of silver," might be rendered, "like golden citrons in silver baskets," in allusion to a custom of the Jews of presenting that fruit in this manner at their sacred feasts.

The FIG, SYCAMORE-FIG and MULBERRY, of the *Morads*, a family peculiar for the manner in which their fruits are formed, being an aggregation of calices consolidated into round, succulent heads. The manner of the flowering of the

fig, inside of the fruit, but} having all the requisite organs of true flowers, was satisfactorily explained.

The OLIVE and VINE are among the most signal of the bountiful gifts of Providence, and would in their history and economy exhaust volumes, yielding as they do such indispensable products, as fruits, wine, oil, molasses, &c.

The ALMOND and POMEGRANATE, with the numerous texts in which they are mentioned, received a share of attention and were found full of interest and instruction.

The CRAB-TREE, *Ceratonia siliqua*, with its sweet pods or husks, furnished food for the poor; but the copious crops of the tree were generally fed out to mules, asses and swine. No doubt this fruit is referred to in the parable of the prodigal son, upon which he was obliged to feed, "the husks that the swine did eat."

CUCUMBERS and MELONS are invested with great historical interest on account of the extent of their ancient cultivation and the great place they filled in the diet of the ancient Hebrews and Egyptians.

The LINTEL of Jacob and Esau; the PAPYRUS, from which paper was made, and which is alluded to in the epistles of John; the *Zysyphus*, the plant from which the "Crown of Thorns" was probably made, have each an interest peculiarly their own.

The TIMBER TREES of the country, and such as were used in the building of Solomon's temple, received a passing notice.

JONAH'S GOURD, ELIJAH'S JUNIPER, the mythical APPLES of SODOM, and the ROSE of JERICHO, received severally their share of explanation.

The foregoing plants were illustrated by colored representations, which served to fix their identification in the mind, and added greatly to the interest of the subject.

#### KEEPING EGG PLANT SEED.

BY MR. W. L. AKERS, JOHNSTOWN, PA.

Having frequently observed that Egg-plant seed which was exposed during the winter to low temperature, did not germinate freely, I kept a portion during the past winter in a warm room, and another portion in a closet in an out-building, where the temperature was as low as zero. The result was, that of the portion kept in a warm place, nearly every seed grew, while of the other part, not more than one in ten came up. The seed was equally good in both cases.

Has any one else observed circumstances of the same kind? If exposure to cold was the cause of failure in this case, might it not be so in regard to some other seeds?

#### CIRCULATION OF HOT-WATER.

BY B. ILLINOIS.

Having experimented to some extent, I was much pleased with your article on hot-water boilers. Your remarks are in the main just and correct. I cannot agree with you when you state "the active power in hot-water circulation is *cold water*;" but do, when you say it is a simple act of gravitation, and caused by difference in temperature. Water attains its maximum activity at 39°, and sinks at 32°; it is 70 degrees colder, remains on the surface and forms ice. In this state of affairs, is Pat Murphy standing on his head?

#### NOTES BY MISS A. G.

TO KEEP THE CURCULIO FROM PLUM TREES.

##### *Another Remedy.*

The following remedy was tried by a friend, of Maryland, with success.

As soon as the tree is in blossom, and every few weeks afterwards, paint the trunk of the tree from the ground up, two feet, with turpentine. Turpentine is obnoxious to insects.

##### THE YELLOWS IN PEACH TREES.

I give the experience of a friend, in restoring his sickly yellow trees to vigorous fruit bearing.

The earth around the trunk of the tree was taken away, until there was a hole made of the size and depth of a common wash-basin, coal tar from the gas works was then poured on the roots, up to the edge of the ground; rags and bronze paper were wrapped around them to keep off the earth, and the soil filled into the former level. The trees sent out new leaves, and were cured. The worms in them, also, were destroyed. This protection will last for two years.

##### *Another Restoration.*

A lady finding some coal dust in the cellar of a house she had rented, ordered it thrown around a forlorn old peach tree in the yard, which she expected to have cut down; but its new dressing seemed to inspire it with life. It soon put forth an extra growth, and had a fine crop of peaches. Perhaps the sulphur in the coal imparted health to this "ancient citizen," or exterminated its enemies,—the worms. There is an acid appa-

rently in coal, which destroys the fish in the Schuylkill. Perhaps it is this acid the peach needs, as Prussic acid is found in the kernels of its fruit.

#### CHINESE WATER LILIES.

Since writing of our native water Lily, I have read an account of the Chinese Water Lilies. The root is used as food, and the seeds sold as a nut in Europe. The colors are white, yellow, pink and crimson; they are said, by Hue, to present a dazzling appearance on the lakes and ponds of China. Could not these be introduced and cultivated in tubs? Who will favor this side of the world with their beauty?

I have heard of a large white lily growing in the hollows of our Western prairies. It might be possible to cultivate these also.

#### HOT-WATER BOILERS—II.

BY MR. J. ELLIS, WHITE PLAINS, N. Y.

I must quote you in order to find a text to my subject, and I suppose you will have no more objection to that, than Blackstone would in being quoted by all the lawyers in the land when necessity requires it. But Blackstone is not law, only an explanatory opinion of law. So it is with all of us, Mr. Editor, including your very humble servant.

"We would most likely find that the boiler has been so set that the *return pipe gets heated nearly as much as the flow*, and the full flow of cold water is thereby checked. It is almost impossible to get water to 'circulate' freely under such circumstances."

For several years past I have been endeavoring to devise some contrivance to apply the *secondary* heat of the fire from the boiler to the return water before the heat in question passes up the chimney, and recently I have discovered *how to do it*. This of course would be diametrically opposed to the theory of keeping the return pipe cold. You want it cold, and we want as much heat driven into it as is possible to be got there. Now what would be the practical result of the latter suggestion? We cannot call to our recollection at the present, a more forcible example of heating a return pipe, than is manifested in the boiler of Burbridge and Healy of the English make. In this case, both return pipes enter the bottom of the boiler, and with it rest or sit immediately over the hottest of the fire. Now, whoever found anything imperfect

in the circulation of these boilers if the *ever necessary precaution was taken to so arrange the pipes that air could not be shut in*. You, Mr. Editor, I know have worked this boiler as well as I. It seems to my mind a matter of impossibility for such an arrangement to interfere with proper circulation, and for the following reasons: First, because the ends of the returns being over the hottest fire, the water in those portions of them are placed precisely in the same conditions as is the bottom of the boiler—the force of heat being equal to the square inch of iron surface acted on by the fire. Now the water being moved by the power of expansion, and the boiler itself containing more of expanded water than do the pipes at the commencement of heating, the heated water at the ends of returns have less resistance in passing to and up the boiler, than they would receive in trying to force themselves against a colder body and backward in the return pipe. The pressure is also lessened by taking to the boiler from its *upward* tendency, whereas, if it were disposed to travel some portion of the return pipe, its course, probably, would be horizontal, and *friction* would be the result; for water, when expanded by heat, is propelled upward, so that the point of friction would be against the upper side of the horizontal return pipe, hence the *conditions* would be more favorable the other way—into the boiler and up.

Now again, if your theory of circulation be correct,—plenty of cold water in the return pipe, and that it is cold water that pushes the hot-water out of its place,—what law is there to prevent it so acting in the return pipes? But you manifest much fear about the warming at the return at the boiler; fear of what? Why that the hot-water would push the cold water back, a fear that the hot-water has more power and force than the very cold water on which you say depends the whole total system of circulation.

Should I be thought to be *personal* in my remarks by your readers of the *Monthly*, I beg to say here that my personality is directed at *theory* in that, and in no other sense.

That there are such things as bad working hot-water apparatuses we know full well, and have had in our time to contend with them; but with all due respect towards the various boiler makers of OLD ENGLAND, I have never worked boilers and pipes with so little fault connected with them, as those made in New York City. Something is more necessary to a boiler than merely its capacity to generate heat, if the cir-

ulation is to be perfect, and one thing is requisite to this end is to see that it does not generate air. Once in our time, I worked a boiler whose flow pipe came out of the side, and not six inches of the top, and the consequence was a continual war of heavy sounds and slaps, both in boiler and pipes; but in those days I thought I knew a great deal more than I do now, and of course thought it was all right for the fire to make the boiler do such wonderful things. A boiler whose flow pipe does not come out at the top of the boiler, or at the highest point of it containing water will contain *air*. If there be a vacuum or space in the boiler *above* the upper water surface of the flow, that space is filled with air, and never will fill with water, unless an air pipe be placed there to let it out, and then scalding water will be drawn out as well as air. Again, every socket joint of the pipes contains air, more or less, so that with a boiler containing air with what rests in the joints of the pipes, you have to commence with obstructions to the proper circulation of the water. Now if we place the pipes *level* through a house, there is but little chance of such air getting out, but if we give to such pipes a quarter of an inch rise to every pipe from the top of the boiler to a point where there shall be a *drop* to the boiler, and at the highest point place a cast-iron tank to receive such pipe, the tank having sufficient capacity to retain the water when expanded to its fullest capacity; we then have something that kills two birds with one stone,—the relief of air formed or generated, and the expansion of the volume of water by heat.

How ridiculous is that system of wooden box tank, having a supply tap with a lead pipe running into the return pipe near the boiler. This supply tank is supposed to be always full of cold water to guard against lack of water in the pipes; but the moment the water in the pipes gets warmed, *expansion* forces it back and over, and continues to run over and run in, wasting the heated water as well as the cold fresh water. We have this goosey system in America to-day, and scarcely any other in England, causing the consumption of coal and time for no purpose whatever.

Water cannot be made to work “any way;” there is only one way that water can be made to work properly, and that is the *right* way; any boiler will work the circulation right (if it has capacity to warm the water) if the boiler and pipes contain *no air*, and an intelligent person

putting up such apparatus will so put it up that it shall not shut in air. Very often it occurs that pillars or posts on which pipes rest sink down, thereby dropping the pipes in various places out of their original grade or level; where this occurs, it is impossible for the water to circulate properly, and often times this alone stops the circulation. But a gardener should always have his eyes about him as well as his thoughts, and try the grade of the pipes by taking a straight edge and a spirit level on the top of it, and if the pipes have been set, giving each a *rise* from the boiler, determine how much that is, and allow it at the proper end of the straight edge, and so try the pipes through their whole length. If this matter was attended to, we should not hear so much about "bad circulation." It was only the other day that we happened to be in a large grapery, where "Pat Murphy" was in the act of taking out a valve, to be replaced by another, when we inquired of him the reason for taking it out, "shure it is not big enough to let the water pass through it;" why, I said it is as large a *bore* as the one you intend to replace it with?

"Well I have tried it, and the water won't go through it." I told him that the valve he had placed there first, was set *upside down*, and consequently had shut in the air, which was the cause of the non-passage of the water. This was altered, and the water flowed all right, saved the expense of another pattern, and the old one left to retain its original character of adaptation.

Through the settling of pipe supports, which causes the locking in of air, arises many difficulties. "Pat Murphy" says that the water boils out of his expansion tanks, and still there is but very little heat in the pipes, and if he drives his fire stronger, it will boil all the water out of the pipes. I suggest to test the truth of the *boiling*, but putting the thermometer into the boiling water it is done, and the thermometer only indicates 90°; I further suggest that it is *air* that is throwing the water out, and not expansion caused by the boiling point, 212°. Sequel—*pipes out of level*. Consequence—water lifted out by air.

## EDITORIAL.

### OVER-DOING THE STRAWBERRY TRADE.

We notice that all through the country the question is seriously discussed, as to whether the culture of small fruits for market is likely to be overdone. This is particularly questioned in reference to the strawberry. It has been a difficult thing to answer. It is a well known fact that hundreds have lost heavily by strawberry growing; while as many have made handsomely by their labor and investments in them. So few people keep books or accounts that we have had little chance to judge of the elements of success or failure in this particular crop. We have had to be content with the statement of this grower, "that with him the strawberry was the best paying crop, and the profits were enormous;" or of that one, "that strawberry growing does not pay at all."

Fortunately we can now get at some facts which will place the matter on business principles. Mr. Wm. Parry gave an essay to the late meeting of the Pennsylvania Fruit Growers' So-

ciety, at Chambersburg, in which he detailed the average expenses and profits of a series of years. We have not those figures, at this moment, before us; but they are not necessary, for our purpose which is to show an approximate rule for the guidance of those who would make strawberries pay expenses.

The one great fact is, that from \$300 to \$350 per acre is about the best that one can get for the crop, taking a series of years—sometimes more and sometimes less. The whole question of profit then is in this:—can the expenses be kept below that? In Mr. Parry's case the expenses were about one half—leaving a good margin of profit. But it must be remembered, that in his case land is cheap; while he is so near the poorest part of a great city as to get the cheapest kind of labor possible to work amongst the plants and gather the fruit. Outside of the city limits his taxes are low; while with cheap land, cheap labor, low freight charges, and proximity to the seat of the greatest demand, he is situated more favorably than it is possible for a large number

who would follow in his successful wake, to do. It is then barely possible for many to make one-half profits. Some may excel Mr. Parry in some single advantage. For instance, if we mistake not, Mr. Parry allows about \$10 per acre for interest on his land, at 6 per cent. There are plenty of strawberry patches in land worth \$50 per acre, or \$2.50 per annum interest; and this betters Mr. Parry's figures by \$7.50; but then this is most likely far away from the headquarters of the market; and thus the extra profit, and uncertainty, much more than counterbalances the little interest saved.

There is yet another profit to be remembered. Mr. Parry is not only a practical man, but a man of science, one who reads and thinks, and strives for excellence. In this \$300 or \$350 per acre, much of it is for *superior fruit*. We question whether the *average* grower would make this

average yield. It would be wise, therefore, for those who are studying this strawberry business to make the figures for their average receipts still lower than this; and, then, after calculating what all their expenses are likely to be, they will have one of the best rules for judging what can be done in it, than any thing yet offered.

And then as to being "over-done," of course there is danger. There is this danger in every thing. Manufacturing, store keeping, cotton raising, grain, fruit,—all are at times overdone. No one can calculate exactly how much will be wanted, or how much to raise. But when it is overdone, it is only those who allow the smallest margin for profit who go out. Those who calculate wisely and well, and for whom we now offer these figures, need never fear failure. For them the strawberry business will never be overdone.

## SCRAPS AND QUERIES.

EARLY GERMINATION OF SEEDS.—*P. H. F., Babylon*, writes:—I write a line on the subject of seed envelope, and the artificial germination of seeds, and hope you will publish it with your comments, in order to give the readers of the *Gardener's Monthly* information on the subject of raising seedlings in this country, particularly those who have had practice. I think I have discovered a universal law pervading all seed creation, *i. e.*, the *Mucous envelope*, which dries, hardens, and becomes insoluble in water. John Grigor says the Ash will not germ the next season after ripening, but requires fifteen to eighteen months. In order to test the Mucous theory, I placed American White Ash seed in a vessel with yeast, allowed fermentation to take place, then a partial acetic fermentation; planted seed in a warm room, in four weeks it came up beautifully.

[Our correspondent has started a question alike interesting to the mere practical man, and the man of science. It is a great feat to get Ash to grow in the way described. If this could be done every year as a regular thing, it will rank as one of the most valuable horticultural discoveries of the age. But we have often

met with circumstances which produced similar results, but failing to repeat themselves, proved that we attributed the results to the wrong causes. We never could get an ash, or a chionanthus, or a privet, or anything that we remember of this natural family of *Oleaceae* to grow the first year from seed, except last year a few dozen seeds of the green ash, *Fraxinus viridis* sent us by a friend, and kept dry till May before sowing, were all growing by June; yet we never expect again to have ash seeding growing by sowing in May. Last year also we had some seed sent us from Virginia of *Cydonia sinensis*. It was sown in the spring, in a large pot. The half grew at once, the balance remained in the ground a year, and are only just now coming through.

This is probably the experience of every seed sower; and yet no one can give any philosophical reason for it. The hint of our correspondent may put students of this phenomenon on the right track. It is quite possible there is a "water-tight" substance which has to be decayed away by some means before the embryonic germ of life can be reached. We think one of our western correspondents, Mr. Douglass, if we ar-

not mistaken, once took in hand to treat Red Cedar seed on some such a principle, with some prospects of success, but we have heard nothing of it lately.

We do not know any subject of more practical importance than this now suggested, and we shall be very glad to have any further hints or observations that any of our correspondents may have to offer.

In raising many hard shelled seeds, the prevalent idea now is that frost is necessary to cause them to germinate. We have long since found this to be an error. Frost is rather an injury than a benefit; some kinds, especially peach, will grow well in the spring, if put out in the ground in the fall; when the same seeds saved under cover till spring will not grow till the next year, and this is placed to the credit of frost; but this is a mistake. It is the moisture, not the frost which acts favorably. It must have been the observation of all peach growers who lay out their peach pits in layers to freeze in the fall, that it is those at the bottom, in contact with the damp earth, which grow first in spring, although the farthest removed from the action of frost. In fact the pits had the same moisture with a little heat, instead of with frost, it would no doubt be better for the seeds. This is again exemplified in the case of imported Mahaleb cherry. Though put out in the ground in fall before frost, and with the aid of frost all winter, they yet oftener fail to grow than to sprout in the next spring; but if kept barely warm and moist, yet secure from mould all winter they will usually grow very well when planted in spring.

This experience accords also with our correspondent's observation; for if it is a gelatinous water-proof substance which prevents the vivifying action of the elements, warmth and moisture will hasten the decay of this much sooner than frost, or moisture alone without warmth with it.

**A FLOWERING HEDGE.**—*Mrs. L. P. M., Manchester, N. H.*, writes:—"Visiting a friend recently, who has a very neat Buckthorn hedge, it was remarked by one of our company that it was a misfortune so pretty a thing had such mean looking flowers, and some one remarked that plants should be chosen for hedges which had pretty flowers, as well as made effective hedges. A gentleman of the party, who is a good amateur, said that pruning plants properly for hedge purposes, prevented their flowering, and there was nothing thus suited to have this

effect in our part of the country. Is this really so? A flowering hedge plant would be very desirable."

[It is not one of the things we court to decide questions between ladies; but the *Gardener's Monthly* must fearlessly do its duty. The *Pyrus japonica* and the *Privet* will do well about your section, bear pruning well, and yet produce flowers abundantly. The last named is sometimes badly attacked by a fungus, in the same way as the pear tree is by the fire blight; this is an objection, but the *Pyrus japonica* has no enemy, and is a blaze of blossoms in spring. We never saw a hedge of the red and white mixed, but we should think this would have a pretty effect.]

**MR. SOUCHET.**—*L., Cincinnati, O.*, writes:—"I wish to get some information regarding the origin of the Souchetti Raspberry, and have addressed a letter to Mr. Souchet according to his advertisements in former numbers of the *Gardener's Monthly*, but have my letter returned. Can you give me his address?"

[It is unknown. He and his family took passage on the City of Boston for Europe a couple of years ago, since which time neither steamer nor her passengers have been heard from.]

**GARLIC ON LAWNS**—*C., West Philada.*—"I am very much annoyed by garlic on my lawns, which in spring gives it an unkempt wild appearance, anything but agreeable to a lover of neatness and order. You will not wonder at my desire to be rid of it; but how can I do it?"

[Easily enough. Let a man go over with a spade, dig down well under it, loosen the soil, and with one hand grasp the tuft and draw it out, roots and all. Afterwards fill the hole with earth, and roll level; the grass will soon grow through it, and all be green again. Next year a very few may grow again; but these are soon disposed of in the same way.]

**WHITE FLOWERED LARCH.**—*L. B., Manchester, Ills.*, asks:—"Is there such a thing as two species of European Larch? A nurseryman here asserts that there is one a white flowered, and the other a red flowered species. I supposed there was only one."

[There is but one species. As to the color of the flowers, we suppose the idea of two species originated from these different colored flowers. The Larch has the sexes separate in different flowers. The males are white, the females (which afterwards become cones) are of a rosy crimson.

There may be variations in the quality of timber grown in various localities, and yet be little or no difference in the appearance of the trees. It is generally admitted now that there is continual creation of new species. The elements of this change probably exist in the cell long before we can take cognizance of them in outward form. What it is that causes this elementary change beyond what we humbly style infinite power and wisdom, no one knows; but after this elementary matter has been prepared, the theory of Darwin—natural selection, or the survival of the fittest—comes into play, and the external organs are modified so as to be better able to sustain the new form than the old one was.

In this way we think it quite likely that they are right who think there are two kinds of Larch, although there may be *yet*, no character which a botanist could take hold of so as to separate them.]

**TOMATOES FROM CUTTINGS.**—*W. W., Canada*, says: The *Canada Farmer* of Feb. 15th, contains an article upon the Tomato, in which it is stated that cuttings of this plant should be taken in the fall, kept through the winter, and set out in the spring, and that this mode of propagation is better than sowing seed in spring, &c. Now it seems to me that the tomato being an annual, cannot be propagated by cuttings taken in the fall and kept through the winter. Am I right, or is the writer in the *Canada Farmer* correct?

[Any annual can be perpetuated for an indefinite number of years, by cuttings each year. It is reasonable that Tomatoes would be somewhat earlier this way,—of course it involves extra trouble. We supposed the *Canada Farmer* was dead, as we have not heard of it for two years.]

**CHRYSANTHEMUMS.**—*W. W., Ottawa, Canada*. "How can Chrysanthemums which have flowered out of doors, be best kept through the winter? In the Temple Gardens (London, England,) they stand the winter, but I suppose no amount of protection would enable them to stand out in our climate."

[A foot of dry leaves, and a board over all to keep out the wet, will enable the Chrysanthemum to stand the winter in Canada.]

**OUR FUTURE NURSERYMEN**—*A Rochester, N. Y., correspondent* says: "The nurserymen who have followed the business for the dollar only, must shortly I think step out, leaving it

as a *quiet* trade in the hands of those who love it as well as live out of it. I may be wrong, but around here it looks like it."

**CLIMATE OF PORT LAVACA, TEXAS.**—A subscriber says: "Our plants here become dormant about 20th of November. By end of February, China Roses, Verbenas, Plums and Spiræas are in bloom. By March, we have terrific dry winds which almost kill well established young trees. Very dry weather then sets in, which usually lasts till April or May. This is our most trying time on vegetation. Very few evergreens get through well; but a grafted *Libocedrus decurrens* which I have, is thriving nicely."

**FORSYTHIA SUSPENS.**—*M. B., Pikesville, Md.*, writes: "Can you tell me whether there is such a thing distinct from others as *Forsythia suspensa*? I bought one at a high figure some years ago, but it seems the same thing as the common Golden Bell."

[*Forsythia suspensa* does look like the common one *Forsythia viridissima*, but it is a better thing. The petals are much broader. There is also some difference in the leaves, which, no doubt, our correspondent can detect on a close examination. We may say that *Forsythia suspensa* is the same as the common one, only much improved for ornamental purposes.]

**FINE CALCEOLARIAS.**—*Mr. Herman Kriger*, gardener to John Welsh, Jr., Esq., places on our table a pot of Calceolarias which reminds of the "olden time" when these plants were well grown, and amongst the greatest ornaments of our greenhouses. They have declined of late,—it is said because our climate is too hot for them; but neither heat nor cold ever stands in the way of a good gardener, as this specimen shows.

**CALIFORNIA PITCHER PLANT.**—*A. Salem, Mass.*—"Can you tell me whether the *Darlingtonia* or Californian Pitcher plant is in cultivation yet, and whether plants can be had of it?"

[Of the last part of the question we may say, we think not. It was in cultivation, as Prof. Thurber told us a year or so ago that some friend of his near New York had flowered it. Mr. Robinson, author of *Parks and Gardens of Paris*, wrote to us from California, that he had found a location, and would take plants to England with him. It is not unlikely that through English sources, it will soon get into cultivation.

## BOOKS, CATALOGUES, &amp; C.

**MONEY IN THE GARDEN.** A Vegetable Manual, prepared with a view to economy and profit. By P. T. Quinn, N. Y. Published by the Tribune Association.

This is the title of a very useful work, written by one of our most successful vegetable and fruit growers—truckers—as they are called about Philadelphia. Mr. Quinn tells us he is not a literary man,—and claims only to set down in his every day language what courses he has found in his practice produce the best results. Thus we accept the book as we find it, not even stopping to enquire whether by “economy” in the title page he means *good* economy or *bad* economy; but assuming that as he writes to tell how to make money, the former is what he means. Like everything from the pen of Mr. Quinn, the ideas expressed have evidently grown up and matured their seed on their own legitimate ground. The roots have not spread out and robbed their neighbor, as we too often see literary plants do in these book-making days. This honest course is not always the best for the reader.

When a writer depends wholly on his own resources, his ideas are not all of them of the best. Yet there is this great advantage, that there is sure to be something which will interest all. Some new thoughts come up to everybody's profit. This is what we see in Mr. Quinn's book. No matter how full the library may be of similar works, this one will be found welcome.

**BEAUTIFUL CATALOGUES.**

Ellwanger & Barry sends us a set of their catalogues, Nos. 1, 2 and 3, bound beautifully, and illustrated with a nice colored plate of the double *Deutzia crenata*; and John Saul, of Washington, D. C., sends with his catalogue one of the prettiest plates of Geraniums, which we think ever appeared in this country. The liberality of our nurserymen in going to such expensive illustrations, is very praiseworthy; yet we doubt not in educating public taste, in this way, they will have their reward.

## NEW AND RARE FRUITS.

**THE BUFFALO CHERRY.**—Some twenty years since Smiley Shepherd, one of the first settlers of Hennepin, on the Illinois River, received a large number of cherry trees from the Buffalo Nursery. With the exception of one variety, or, rather, one tree, they have dropped off one by one, and whether this one is a graft, or the original stock that has sprouted up from below the graft, is not certain; but, what is of more importance, is the fact that it is a valuable sweet cherry, and that the tree has proved hardy and productive. When we contrast this with the fact that we have no known variety of the sweet cherry that is of any particular value for our prairie orchards, one can appreciate the value of the new cherry. Fortunately, Mr. Shepherd is not only one of our best pomologists, but an honest man. His experience teaches him that too much reliance is not to be placed on a single tree, in a single location, for that may be effected by some local cause producing the favorable result, and, of course, leading to a failure in

other locations. The old French pear trees at Detroit and the mammoth pear trees at Vicennes are marked specimens of this kind, as scions of these sent to other localities have most signally failed to produce like results—that is, either remarkably large trees or remarkable crops. With numerous facts of this kind before him, Mr. S. is a trifle conservative, and yet the experiment is well worthy of a trial. In the meantime, other eyes than those of Mr. S. have been turned toward the annual crops of this single tree, remarkable as compared with its fellows. Those eyes are owned by the plant speculator, the dealer in new things, the man of Missouri mammoth blackberries, of joint pop-corn, of Mexican everbearing strawberries, etc., for he knows that a cherry, or in fact any thing endorsed by Mr. S., or even coming from his grounds, would sell; hence he makes a large offer for the entire stock of scions of this remarkable tree. No! says Mr. S.; the thing needs a further test; it must go out from the shelter of my grounds,



from the influence of the river climate, beyond the peculiar geological formation where it has produced such happy results; in short, it must go out of its Eden and take the rough usage of the world. If it can stand that test and maintain its integrity, then will it find a place in the gardens and orchards of the people, to make glad the hearts of the household. We say noble and patriotic, and thanks to the venerable Smiley Shepherd, whose locks have been frosted by 80 winters, and whose memory will go down the vistas of time as a bright example of the noble and the right.

The speculator in new varieties is moved aside, and Mr. S., with his own hands proceeds to shear the tree of its scions, to carefully wrap them in small packages for the mails, pre-pay the postage, and direct them to our most careful pomologists. The satisfaction to him in this work is greater than the counting of the proffered thousand dollars, and is an example that others may follow. Out of the several scions sent me last year, one survived, and has stood the past remarkable cold winter unharmed.

Let no one be in a hurry, for it will require some years to make the test; in the meantime, those having the scions will distribute them to others in a limited manner, so there cannot possibly be any speculation in it, unless some bold operator, as in times past, sends out the counterfeit. Therefore don't purchase scions or trees of this new cherry, for no genuine ones are for sale, and are only to be had of Mr. S. or those friends who have been favored with them—not for money, but as a gift to the good cause of progressive industry. Though I have hope that the new comer may prove hardy and productive in all parts of the Northwest, yet we should not be over-sanguine from its limited history, unless it should prove to be some old, though long-neglected variety, well worthy a place in front.  
—RURAL, in *Chicago Tribune*.

**BURGHLEY PARK CHERRY.**—We first saw samples of this cherry at the Royal Horticultural Society's Exhibition at Oxford, and shortly afterwards we were favored with samples from Mr. Gilbert, head gardener at Burghley Park, Stamford, which enabled us not only to see it again, but to taste it. Although this comes before us a new fruit, being now published as such for the first time, it is more than thirty years since the original seedling tree fruited and proved its right to a position in the world. The sole

reason of its remaining so long in obscurity is that it was considered shy in bearing, which, strange to say, is now proved to be a mistake. The truth is, the fruit was annually pruned out of it; but Mr. Gilbert determined to adopt another course, and accordingly left on the tree at the last winter pruning a lot of young wood which in ordinary practice would have been removed. The tree has amply rewarded him, the crop of the past summer being most abundant and the quality as good as ever. The fruit is large, usually round with an obscure suture, but occasionally compressed or flattened, the skin very thin and transparent, the color rich deep red with shades of maroon. The flesh is of a tawny color, juicy and melting with a good trace of styptic flavor, very pleasant and refreshing. It belongs to the Red Duke class, and in general characters comes nearest to Reine Hortense, though it appears to combine the best qualities of that fine cherry with the best qualities of the Red Morellos.—*Gardener's Weekly*.

**GARIBALDI APPLE.**—In the *Gardener's Magazine*, of December 8th, 1862, we presented our readers with a notice of this apple, which was then for the first time offered by M. A. Verschaefelt, of Ghent. Having lately received samples of the fruit from an amateur cultivator, we can now give it a good character from our own observation. In the original notice, it was stated that the variety was raised by M. Fontaine, of Ghelin, from seed sown in 1842, which fruited for the first time in 1860. The samples sent are large and handsome, the form an oblate spheroid the skin lemon-yellow with spots of russet; the stalk long, slender, deeply inserted, eye large and open; the flesh white, crisp, juicy and agreeably aromatic. The Garibaldi Apple is one of the Calville class, and a decidedly superior dessert fruit.—*Gardener's Weekly*.

**MONTE BELLO APPLE.**—President Hammond brought it to the notice of the Illinois Horticultural Society, and presented specimens of a seedling apple from the orchard of Dr. Chandler. It is a most magnificent apple, of the highest quality, and is certainly a great acquisition.

*Description.*—Tree rather upright, moderately vigorous, healthy, very hardy, early and constant bearer; shoots, grayish brown; leaves medium.

Fruit large, blate, very handsome, surface smooth, color yellow, striped and splashed with

deep red, with which it is almost completely covered; dots large and scattering; basin wide, regular or wavy; eye medium, closed; cavity wide, regular; brown, stem short and slender; core medium, regular, melting; seeds small, pointed; flesh white, fine grained, tender, delicate juicy; flavor mild, sub-acid, sprightly, vinous; quality very best; season, September to December. A. C. HAMMOND, *Warsaw, Ills. in Pomologist.*

THE OBLONG SIBERIAN CRAB.—The varieties of the Siberian crab are becoming quite numerous, and its merits as a hardy fruit bearing ornamental tree more generally recognized than heretofore. They are all among the most hardy of fruit trees, enduring the most rigorous climates. They grow rapidly, generally symmetrical in form, have ample foliage, a profusion of beautiful flowers and brilliantly colored

fruits. Either as single specimens or in groups on the lawn, they are highly interesting and ornamental. One of the most attractive varieties among all those in cultivation is the "Oblong," imported some years ago from France, by ELLWANGER & BARRY, and it is now considerably disseminated.

Size medium, averaging a trifle over an inch in diameter; form oval, oblong; stalk about an inch long, slender; calyx closed, projecting; skin brilliant scarlet, crimson with a thin bloom, and sprinkled with gray dots; tree vigorous in growth, with large leaves; season, latter end of September.—*Rural New Yorker.*

NEW STRAWBERRY, MONARCH OF THE WEST.—This is an Illinois seedling, and claim for excellence is founded on great size. It is said from 12 to 15 berries fill a quart.

## NEW AND RARE PLANTS.

NEW DOUBLE WISTARIA.—Mr. Francis Parkman of Jamaica Plains, Mass., received a small plant of *Wistaria* from Japan, several years since, which bloomed last summer, when it was discovered to be a new and valuable variety, with double purple flowers. The plant is perfectly hardy, resembling the old *Wistaria sinensis* so well known as one of the most beautiful of all our climbing plants. It is to be hoped that Mr. Parkman will be successful in propagating this new and charming sort, for the more varieties we have of this beautiful genus the better. There are quite a number of distinct sorts to be found in the larger nurseries, among the best we will name, *Wistaria sinensis*, with deep bluish flowers and very long trusses; *W. S. alba*, flowers pure white and trusses nearly a foot in length; *W. frutescens*, a native species, with small, compact clusters of purplish flowers. The plant is a vigorous grower and usually blooms twice in a season. The *W. frutescens alba* is a charming sort with white flowers, excellent for forcing under glass, as the plant is rather a

stocky grower and not inclined to climb as much as other sorts. The *W. magnifica*, with pale blue flowers, is also a handsome sort, and one of the most vigorous of growers. The *W. brachypoda* resembles the *frutescens*, the flowers smaller and deeper purple.—*Rural New Yorker.*

VAN HOUTTE'S *Flores des Serres* recently described the following plants, which will be of interest to American cultivators.

LACHENALIA LUTEOLA.—An exceedingly pretty little cool greenhouse bulb, with yellow tube shaped pendulous flowers, slightly tipped with green, the top flowers on the spike being almost red. Valuable from the long time it remains in bloom, and of the easiest culture possible.

CLEMATIS PATENS, JOHN GOULD VEITCH.—This beautiful and evenly double-flowered variety of that well known family of climbing plants, the *Clematis*, was introduced direct from Japan, by the distinguished collector and horticulturist whose name it bears. It produces its

fine porcelain blue flowers in great abundance; they are four inches in diameter, and of nearly perfect form. It is, like other *Clematis*, perfectly hardy.

**IMANTOPHYLLUM CYRTANTHIFLORUM.**—A hybrid of *Imantophyllum* obtained by crossing the *I. nobile* with the *I. miniatum*. The shape of its flowers resemble those of a *Cyrtanthus*.

**CYPRIPEDIUM BARBATUM GRANDIFLORUM.**—A fine variety of slipper plant, remarkable for the exceptional size of its upper segment, the beauty of its markings, its fresh clear coloring, and the extreme robustness of its habit of growth. It is a great improvement on the old *Cypripedium barbatum*.

**BRUGMANSIA OR DATURA SANGUINEA.**—This handsome flowering shrub is a native of the mountains of Peru, where it was found by Humboldt, growing in stony places at a height of nearly 700 feet above the sea level. It reaches with us a height of from six to nine feet, requiring the protection of a greenhouse in winter, and passing the summer in the open air. It produces its flowers during August and September.

**ANTIGONON SEPTOTUS.**—A most beautiful and exceedingly free-flowering greenhouse creeper, introduced by Dr. Seeman, and sent out by Mr. Bull. It comes from the neighborhood of Oaxaca, and covers any trellis or bush which it is allowed to trail over with a profusion of bright rose-colored flowers; produced in the autumnal months.

**DESMODIUM PENDULIFLORUM.**—One of the most beautiful and free-flowering of recent introductions from that mine of horticultural wealth, Japan. It is perfectly hardy, and its long, drooping branches are sometimes entirely hidden by the millions of deep rich purple flowers, of a pea shape, which are successively produced from the end of August to the beginning of winter. On a lawn the effect of a good specimen of this plant is exceedingly striking.

**HYDRANGEA STELLATA PROLIFERA.**—A very ornamental semi-double flowered variety of this well known, hardy, flowering shrub; color pink and white. It is likely to be an acquisition.

**HEMEROCALLIS DISTICHA FLORE PLENO.**—An exceeding handsome variety of the double-flowering day lily introduced from Japan. It produced a succession of very double flowers of a brilliant golden yellow, with bright red spots at the base of each petal, and is perfectly hardy.

**GUNNERA CHILENSIS, OR SCABRA.**—This is a plant of immense size, and by some considered

to be also of great beauty, as Mr. Van Houtte christens it queen of herbaceous plants. It certainly requires a great deal of room, and most resembles an exaggerated and overgrown plant of rhubarb. In sub tropical gardening on a very large scale it may be found useful.

**XANTHOCERAS SORBIFOLIA.**—A beautiful and apparently free-flowering hardy shrub, sent from China by one of the French missionaries there, to Professor Decaisne, of the Paris Museum. The height of the plant is between three and four feet; the flowers pure white, with an orange centre, and produced in large and handsome bunches.

**VANDA CÆRULESCENS.**—For the introduction of this Orchid gem we are indebted to Lieutenant-Colonel Benson, who discovered it growing in Burmah, at an elevation of 1,500 feet above the sea. Though the flowers are much smaller than those of the well known *Vanda cærulea*, this species is equally worthy of cultivation, the sepals and petals being of a decided azure-blue, whilst the labellum is of the richest violet color. The number of blooms on a spike averages from fifteen to twenty. The plant is a dwarf grower, resembling in habit the *Vanda Roxburghii*; it is a free bloomer and of very easy culture. A figure of this beautiful novelty has been published in the May number of the *Botanical Magazine* for this year.

**VANDA DENISONIANA.**—We are indebted to Colonel Benson for this lovely Vanda, and it must certainly rank amongst the most striking of his discoveries. A figure of this beautiful Orchid will be found in *Curtis's Botanical Magazine* for December, 1869, and we give the following description by Professor Reichenback, taken from the *Gardener's Chronicle* of the same year, page 528: "The white Burmese Vanda was one of the secret treasures of the Royal Exotic Nursery for a while. It has just flowered, and Messrs. Veitch have kindly placed in our hands the beautiful spolia of this striking novelty. The habit of the plant compared to that of *Vanda Bensoni*, though, as far as our recollection goes, the new one is much stronger. The leaves, Mr. Veitch informs us, are wider; they are ligulate, unequally bilobed at the attenuate apex, and very shining. Our inflorescens are four-flowered, the flowers larger than those of *Vanda Bensoni*. There can be no doubt that this lovely

plant will create a sensation amongst amateurs. We need scarcely say that it is one of Colonel Benson's most striking discoveries, though we should not care to be appointed the modern Paris to decide which was the loveliest amongst

the Bensonian Fairies." "We have dedicated this Vanda to Lady Londesborough, naming it *V. Denisoniana*, in appreciation of Lord Londesborough's great and generous love for Orchids."—*Gar. Chronicle*.

## DOMESTIC INTELLIGENCE.

**A GRAPE VINE BEARING PEACHES.**—The *San Antonio Express* says: Western Texas is a land of strange growths. We saw last year on exhibition, at Austin, a Mustang grape vine which had produced perfectly formed acorns; and another grape vine which had undertaken, with some success, to produce a crop of peaches.

Of the unique production of nature named above, but little is known, and we are informed that it has never been scientifically described.—(!! *Ed. G. M.*)

**DWARFING TREES.**—A foreign correspondent of the *Boston Traveler* relates with how much curiosity he witnessed some remarkably successful specimens of dwarf trees in Japan. I have seen in the gardens, more especially those about Owari, a Maple, a Pine, a Peach, and a Camphor tree, all more than fifteen years old, with their limbs, leaves and trunks as perfect as any in a forest, and all grew from a box not a foot square, and not one was over two feet high. The trunks looked like old trees, and the limbs were gnarled and rugged as the mountain tree of the same kind. The owner told me that these trees would grow no larger for fifty years. In one garden there was a complete fruit orchard in a box four feet long and two feet wide—Pears, Peaches, Plums, Apples, Oranges, Lemons, Olives, Bananas, and Cherries, represented by perfect trees, the tallest of which was not over three feet. Whether these ever bear fruit I failed to ascertain; neither could I learn the process by which the tree is kept so small. But I am satisfied that it is done by killing a large tree and keeping a sprig, which starts from the old root, for the dwarf. The climate and soil favor this torturing process, for a root will not die as long as it remains undisturbed in some localities. I saw great trees near the gateway of a temple yard at Sinara, which were bent

over, making a large circle, like the curls in the pipe of a bugle. They must have been bent around something fifty years ago. At another place a large Oak tree was bored out from the joint of two limbs near the top to the roots, and a magnolia tree set out down in this hollow, which grew up inside the Oak until it spread out its branches in the top, making of it an "Oak Magnolia." This tree has been spoken of by Japanese writers in native newspapers as an Oak tree with a Magnolia graft upon it. The system of grafting is carried to great perfection, and Yacca said that they successfully graft Orange into Apple, and Pear into Cedar.—*Horticulturist*.

**NATIVE GEORGIAN** is the name of the Irish potato grown by Dr. B. Hamilton, Dalton, Ga., which took both premiums at the late State Fair. This potato was originated from the seed of the long red potato, grown in the mountains of North Georgia. The Native Georgian is remarkably prolific, and come in two weeks later than the Early Rose. It does not rot in this climate, and in point of flavor is unsurpassed. Samples of this excellent potato may be seen at the seed store of Samuel A. Echols, who is the sole agent for its sale.—*Southland Weekly*.

**MULCHING BEARING FRUIT TREES.**—There is no doubt now by our most intelligent horticulturists about the practical advantages to be gained by mulching the surface of the orchard and fruit garden. This should be more generally practiced in fruit producing districts, for it is the least expensive and most effective method of protecting the fruit trees against the bad results often following the frequent and sudden changes of temperature during the summer and fall months, when the surface of the ground is left exposed to the direct rays of the sun. Again,

when the mulch is put two or three inches in thickness, the surface soil is constantly moist and loose, even when no rain falls for a term of several weeks, and the trees or fruit receive no check for want of moisture and food under such circumstances.

My method is to cultivate the spaces between the rows of trees in the orchard, using a small one-horse plow and cultivator, running not more than two inches deep, during the early part of the season. From the 1st to the 15th of July I have put on a heavy coating of salt hay, covering the surface as far as the branches extend. After this there is no more trouble with weeds

or grass. There may a few scattered ones start up, but they are easily destroyed.

Every fruit grower knows that two or three weeks before the time of gathering the main crop of fruit, fine specimens are constantly falling off by strong winds. When the ground is mulched the majority of such specimens are not bruised or injured for sale. This saving alone I consider pays me for the trouble of mulching the orchard.

There is only one serious drawback to the application of mulch, that is the danger of the hay or straw getting on fire when rendered dry by continual warm weather.—*P. T. Quinn, in N. Y. Tribune.*

## FOREIGN INTELLIGENCE.

**ALPINE STRAWBERRIES.**—Mr. Radcliffe says in *London Journal of Horticulture*: "The Alpines have been most abundant. Galande is a splendid red Alpine. I wonder people do not grow Alpines. With a little sugar, I think they are the finest flavored of all Strawberries.

**PRESERVING FRUIT.**—Having read the letters on Preserving Fruit from "A Head Gardener," "Another Head Gardener," "A. I. H.," and "A Constant Reader," I beg to add a few more observations on the same subject. It appears to me that these several correspondents only assert their various theories, without giving any reason for their opinion; and the public is little benefited by this war of words. In gathering fruit for making preserves, due account should be taken of the sort or kind to be made, whether jam, jelly, or cheese. Jam, in the ordinary acceptance of the term, is the entire fruit, skin, pulp, juice, seeds, all boiled together, with a certain proportion of sugar. Jelly is the juice only of the fruit boiled to a consistency with sugar. Cheese is the juice and pulp of certain fruits divested of all skin, seeds, or fibre, and submitted to the same process of cooking or *preserving*. Now, it must be evident to any one who thinks at all on the subject, that the ripest fruit will yield the largest proportion of juice and soft pulp, and therefore is the most suitable for jelly and cheese, and the most unsuitable for

jam; for, as "A. I. H.," justly remarks, a too juicy or watery fruit, like cherries, makes a poor preserve, unless such a quantity of sugar is used as entirely destroys the flavor of the fruit, or it is boiled so long to give it consistency that both color and flavor are lost. By taking fruit for jam before it is thoroughly ripe, all the fine flavor is drawn out, and there is no waste from long boiling to obtain the desired consistency. Thus all your correspondents have some degree of light on their side, if they intend to speak of jelly or jam, when they insist on fruit being ripe or half ripe; but on this important point they are silent. As to the various kinds of Strawberries for preserving, I cannot agree with "A Head Gardener," that all sorts are equally good. Those that are white in the centre or at the end, as so many of the best table varieties are, do not make jam of so fine a color as those which are red all through, though the flavor may be equally good. Then, again, fruit for "bottling," if "ripe," will fall into a perfect mash in the bottles from its own steam, arising from the heat to which it is exposed. For preserving in this way fruit, whether currants, gooseberries, plums, or cherries, should be quite soft enough to yield to the finger, or the result will be, as I have said, a sort of *puree*, instead of the entire or unbroken berry. I know it is difficult to overcome popular prejudice; but it is worth trying to do so by giving reasons and practical experience, when

we consider the enormous quantity of good fruit and sugar wasted every summer by these unskillful—and, may it not be added, ignorant?—and consequently prejudiced *artistes* of the kitchen. In a former communication (July 16), I gave some directions for making the varieties of preserves I have spoken of in this letter, and, as I said before, my remarks are the result of personal and practical observation.—GEORGIANA JAMES, in *Gardener's Weekly*.

**STRAWBERRIES OF DR. NICAISE.**—Dr. Nicaise has come out by a master-stroke in obtaining at one effort *La Chalonnaise*, which equals in quality the excellent *British Queen*, but which is more hardy and fertile. By force of a good selection of seed bearers, and of operating on successive improvements, he has been able to obtain very large strawberries, of most regular shape, and having superior qualities. This is the means of improving “breeds,” and it is thus true raisers proceed to bring to perfection the original varieties they obtain.

This method of operation is the reason that each seed-raiser obtains particular types. Thus, Myatt has given us varieties of strawberries of perfect quality and taste, but the plants of which leave hardness to be desired. De Jonghe has obtained strawberries dwarf and hardy, without being too free, producing generally strawberries medium-sized or large, good in quality and taste but, above all, of fine shape.

Certain raisers have had strawberries very early; others very late; so that the same have obtained varieties either very fertile or very hardy; others new forms, or superior qualities to those we have already; but of all the raisers of seedlings, we believe none have obtained varieties so large as those of Dr. Nicaise.

**VICOMTESSE HERICART DE THURY STRAWBERRY.**—At page 441 of the *Gardener's Magazine* this fine strawberry is recommended as a good variety for mid-season. This recommendation hardly does it justice, for here we are able to gather from it quite as early as from the Black Prince, which is generally considered to be the earliest strawberry grown. Vicomtesse Hericart de Thury may, however, be planted for furnishing a mid-season supply, because it continues in bearing so long that we are able to gather fruit from it quite as late as from several other popular sorts that do not ripen their fruit

so early by a fortnight or three weeks. I have grown it largely for many years past, and am therefore able to speak with confidence as to its merits. It appears to adapt itself to every soil and climate, the plants with the most ordinary management producing on an average 2 lbs. of fruit each, and it is worthy of notice, that out of several thousands of plants I have not yet seen one barren. In good seasons it will produce a very fair second crop, and to-day I gathered a fine dish of fruit from a small bed, the plants of which it consists having produced a heavy crop in the early part of the season. Drought and frost alike do not affect the plants, and it appears worthy of remark that it forces well. As a proof of its fruit-bearing qualities, it may be mentioned that, at the exhibition of the West of Scotland Horticultural Society in July last, Mr. Campbell, nurseryman, Blantyre, exhibited a number of plants carrying 3 lbs. of fruit each. In addition to the synonyms mentioned at page 441, that of *Garibaldi* may be added, as the so-called variety under that name has been proved beyond doubt to be identical with it.—A STRAWBERRY GROWER, in *Gardener's Weekly*.

**CHERRY—GOVERNOR WOOD.**—This American variety seems to do well in England. A correspondent of *Cottage Gardener* says: “This is a delicious cherry, large and fleshy; it bears abundantly on walls, and as a pyramid it is not inferior to any of the varieties previously noticed. It is a dessert fruit.”

**A SUPPOSED HYBRID PEAR.**—The ninth volume of M. Decaisne's excellent work, the “*Jardin Fruitier du Museum*,” contains the completion of the account of the more important Pears in cultivation, of which M. Decaisne describes and figures no less than 317 varieties. To make the history of the genus as complete as possible, M. Decaisne now adds, in the 104th part of his magnificent publication, an account of certain species or varieties growing wild, or apparently so, in different countries, and which have been regarded as distinct species by various authors. Great interest attaches to these trees, inasmuch as they, or some of them, are the parents of our domestic varieties. Among the trees so mentioned is the Polwiller Pear (*Pyrus Polwilleriana*), a hybrid form, thought by Bauhin to be intermediate between the Apple and the Pear. The Polwiller Pear, says M. Decaisne, affords a remarkable illustration of the persistence of

character in a hybrid tree, perpetuated for three centuries by grafting, and which affords strong evidence against the opinions of those who maintain that our old varieties of fruit trees degenerate and disappear. The only plants of the Polwiller Pear known are those derived originally from the hybrid form described by Bauhin. In 1860, out of 150 fruits collected in the garden of the museum, M. Decaisne found only 13 seeds well formed, and these seeds, when sown, produced four very different forms. In 1864, 139 of these small Pears furnished 62 seeds; in 1867, 50 seeds which were obtained from the Jardin des Plantes of Dijon all proved sterile. Lastly, in 1865—a very hot and dry summer—it was found necessary to cut open 356 fruits in the Museum garden in order to obtain a single well-formed seed. Among the four forms derived from the seed of the Polwiller Pear, three were remarkable for the small size of their leaves, while their pubescence was like that of the parent tree, on that of *Cratægus Aria*. The seedlings belonging to the fourth form seemed to M. Decaisne to belong entirely to the category of cultivated Pears, but were not referable to *P. communis*, the leaves of which are roundish. On the other hand, the bark of old trees of *P. Polvilleriana* remains smooth and grayish, like that of *Cratægus Aria*, instead of cracking and becoming blackish like those of the Pear.

**CROTON UNDULATUM.**—This variety belongs to Messrs. Veitch & Son's valuable series of these plants. It is of free growth, the edges of the leaves elegantly waved and undulated, the young leaves richly mottled with yellow, which changes to pink and crimson, and ultimately, as the leaves attain maturity, to the brightest crimson on a dark green ground. As the colors have a most brilliant appearance under artificial light, this plant is admirably adapted for table decoration; and as a subject for cultivation in the stove, whether for exhibition or otherwise, it is without question the finest of all the *Crotans*.

**CROTON VEITCHII.**—This handsome variety has leaves of great size, averaging 10 to 14 inches in length and 2 to 3 inches in breadth, slightly undulated, and quite new in coloring. The young leaves are traversed by bands of creamy yellow, which change with age into rose and carmine purple, the whole of the coloring acquiring increased intensity as the leaves attain maturity. This is a remarkably fine plant, and

amply justifies its name as commemorative alike of its discoverer and the firm by whom it has been introduced to cultivation.

**THE MANUFACTURE OF TAR PAVEMENT.**—Tar pavement may be made of the ordinary cinder dirt produced in gas works, of shingle, or of a mixture of both. The material is burnt in heaps like ballast, and when hot is mixed with hot tar. In practice a small fire of coke is made on the ground, and covered with cinder-dirt or shingle. When this layer is hot another is added, and so on in succession until a large enough heap has been provided. The tar is now boiled in an iron copper, and taken when hot and mixed with the hot material from the heap already described, in quantities of two bushels at a time, in about the proportion of one gallon to every bushel of cinder dirt, and slightly less than a gallon for the gravel. It is turned over and over with the shovel until every part of the material has got a covering of tar. Then the whole is passed through a sieve with  $\frac{3}{8}$  inch mesh, and part of it through another with  $\frac{1}{4}$  inch mesh, and put in heaps until required. Indeed, it may be kept for months before being laid down.

Before the pavement is laid, an edging should be provided about two inches thick, and projecting 2 inches above the surface of the ground to be covered, which should be tolerably even. It is advisable to have the ground next the curb well trodden on and rammed before the pavement is laid, otherwise there will be an unseemly hollow next the curb. In laying, the rough stuff is put down first and rolled tolerably firm, then the second quality is put on, then the third, and when the whole has been raked level, a little of the finest material is sifted on through a sieve with  $\frac{1}{2}$  inch meshes, and a little fine white shingle or Derbyshire spar is sprinkled on the top. The whole now must be well rolled. The best roller is a water ballast roller, which at first is used without ballast, and well wetted to prevent adhesion of the material, and, when the pavement is slightly consolidated, the full weight should be applied.

For heavy cart traffic the material should be made of shingle only, heated and mixed as above and well rolled. Both descriptions of pavement are laid best and most easily in warm weather, and should be rolled when the sun has warmed it well. Those parts in angles should be well rammed and trimmed with a light shovel.

Though apparently a simple manufacture, there is a little difficulty in ascertaining the proportion of tar to gravel or cinder dirt. A little experience will only be necessary in this, as well as in all other manufactures, to enable any one to carry it out successfully.

This pavement cannot be spoken of too highly, as it is cheap, wears well, and can be easily repaired. The color, which never can be made to equal York flag, and the smell for some time after it is laid, are the only objections to its use; it can be laid with a good profit in any district at 1s. 4d. per square yard; and besides being a boon to the public, who must otherwise walk on gravel, is a great advantage to gas companies.—(Nature).

FERTILIZATION OF GRASSES.—The French botanist, M. Bidard, has paid attention to the fertilization of grasses, and finds a set of phenomena with a different signification. He states that the pollen of *Graminææ* does not exhibit any trace of pollen tubes, and that self fertilization takes place before the anthers are extruded beyond the scales of the flower. The heat of the breath or a ray of sunshine is sufficient to bring about the phenomena of fecundation; and the natural hybridization of grasses is impossible, owing to the exact closing of the chamber containing the fecundating organ.

MR. JOHN GOULD VEITCH, the eldest son of the late James Veitch, of Chelsea, died at Coombe Wood, Kingston Hill, after three years' illness, aged 31. The loss which botany and horticulture alike sustain by this gentleman's decease cannot be otherwise than one of the severest, for as a traveller and introducer to this country of new and valuable plants, he had long since become a formidable rival of the veteran Fortune. When we glance through the list of plants of recent introduction for which we are indebted to the industry and prescience of Mr. J. G. Veitch, we feel how great is the gap amongst scientific explorers which his death occasions, and can most sincerely join our griefs to those of his bereaved family.—*Gardener's Weekly*.

LONDON GARDENERS IN THE OLDEN TIME.—The following may be interesting, as illustrative of the manners of the gardeners in the olden time. In 1345 (19 Edw. III.) "the gardeners of

the earls, barons, and bishops, and of the citizens of the City of London," petitioned the Mayor, John Hamond, that they might "stand in peace in the same place where they had been wont in times of old, in front of the church of St. Austin, at the side of the gate of St. Paul's Churchyard, there to sell the garden produce of their said masters, and make their profit." But the Mayor, finding that "the seurrility, clamor, and nuisance of the gardeners and their servants there selling pods, cherries, vegetables and other wares to their trade pertaining daily, disturbed" the priests in the church of St. Austin, as well the reputable inhabitants, ordered that henceforth the gardeners "should have as their place the space between the south gate of the churchyard of the said church and the garden wall of the Friars Preachers (Black Friars) at Baynard's Castle."—*City Press*.

POT VINES.—The economical value of pot Vines has often been called in question; indeed I have often heard people say, "Grapes produced on pot Vines are never worth eating." It is quite true they are often very inferior, nor is it surprising that such should be the case. Badly grown and badly ripened canes are often fruited in pots; and frequently where no fault can be found with the Vines they are expected to bear far too many bunches, and are not half fed nor attended to during their growth.

Gardening must generally be considered a luxury except in the case of the commonest vegetables. Supposing the problem to solve be how to get Grapes when they are worth, say, from 7s. to 10s. a pound in the market, I think it is a great question whether this cannot be done more cheaply by growing pot vines than by forcing permanent ones; besides which, nothing is more beautiful than a pot vine loaded with well ripened fruit.

Having seen at Chatsworth last spring the best house of pot vines I ever saw grown, I asked Mr. Speed to tell me how they had been managed. They were standing on a shelf covered with hite spar, such as is brought out of the Derbyshire lead mines, consequently not a root had grown out of the pots. Every eye had been allowed to break and produce a shoot, and each shoot had made six leaves before being stopped. From the time leaves were produced, till the fruit began to color, the vines had never had water without guano in it, the plan being to give



very weak doses constantly in place of stronger ones at longer intervals. A quantity of Peruvian guano broken small and passed through a fine sieve stood in a large pot, and the foreman put as much as his closed hand grasped into a large watering pan each time he filled it. I have never weighed this quantity, but it must be a small amount to the gallon.

One thing struck me—that was the very careful way the watering was performed. The man had in his left hand a small wooden hammer with which each pot was struck, and if the sound produced did not indicate a want of water, the plant was passed by. During the hot weather the pots were examined twice-a-day, so that no plant could suffer from want of water, or receive it before it was required.

I should think the vines carried on an average 8 lbs. of Grapes, and yet many of them had only four bunches, and none more than five, and they were as well colored as one would wish to see. As the vines were trained to meet in the centre of a narrow double-roofed house, and the leaves of the vines just met all the way up, the whole roof was covered by foliage, and the crop looked a very heavy one. It was one of the prettiest sights I ever saw. Where less skill and attention can be bestowed on pot vines, it is a question if they had not better be placed on a rich bed of soil and be allowed to root through ;

but as I never before saw so good a lot of pot vines as these were, I thought some of your readers might like to know how they were cultivated.—J. R. PEARSON, *Chilwell, London Journal of Horticulture.*

**CALADIUM CULTURE IN ENGLAND.**—In reply to a correspondent, the *London Journal of Horticulture* says: The party you mention says his mode of growing them differs but little from that described in more than one place in our pages, excepting that he uses poorer soil. His mode of culture is as follows:—After the plants are no longer ornamental they are set aside in some dry place, often a vinery, and but very little water given ; still they are not kept quite dry, and when the foliage is quite gone the pots are stored in some place warmer than an ordinary greenhouse. In spring the Caladiums are brought out and repotted, and placed in heat, using for the first potting a mixture of rough peat and maiden loam, with charcoal for drainage, and adding sand to the mixture if the peat does not contain enough of it. After growing a little while repot, using a much poorer soil this time ; very often the sweepings of the potting shed, as a too rich material to grow in, however conducive to robust health, diminishes the high coloring which constitutes the beauty of this plant. He considers it unnecessary to maintain the high temperature so often recommended, as plants so reared are unable afterwards to endure a position in the conservatory.

## HORTICULTURAL NOTICES.

### PENNSYLVANIA HORTICULTURAL SOCIETY.

This has been a grand month for the Society. In the first place, Col. Wilder's Lecture on the 13th was the leading attraction. The lecture business has been very much overdone in Philadelphia, and with the multiplicity of evening attractions, it is hard to get a big audience. But the prospects of a full house for Col. Wilder were so good, that the committee decided not to have it in the Foyer the usual lecture room, in which was held the great meeting of the Pomological Society ; but to have it in the large exhibition hall, capable of seating, with the galleries, between two and three thousand persons.

It was very gratifying to the Society, that not-

withstanding the drawbacks to the success of the Lecture, the spacious galleries and the hall, up to the range of the speaker's voice, was well filled. Col. Wilder never appeared to better advantage, and while giving the account of his California trip, with the comments which his ripe experience suggested, was frequently and enthusiastically applauded. It was conceded to be one of Mr. Wilder's best efforts. The proceeds of the lecture will be offered as a premium at the September exhibition of the Society.

The exhibition on the 17th was undoubtedly the grandest spring exhibition ever held ; whether we consider the immense throng of spectators, or the quality of articles exhibited. It was estimated that at one time over five thousand persons

were present, and considering the number of those who went out to make way for others, it is computed that not less than *six thousand persons* witnessed this exhibition.

It is impossible in a brief magazine article to do justice to the contributors; we will only attempt to note a few of the most striking features. In the collection exhibited by Mr. Huster, gardener to J. B. Heyl, was a rare orchid *Dendrobium densiflorum*, which though it had but one spike, was eight inches in length. The old *Hermannia odorata* was also here, showing by its sweet scented yellow blossoms, how well old favorites will sometimes please. N. H. Harris, florist, on the Darby Road, had a very fine collection of double and single Zonale Geraniums. One of them, the General Lee, was perhaps the finest geranium ever exhibited here. The truss was about four inches across, and the numerous cherry scarlet single flowers were as regular as if the truss had been sheared over. Amongst Mrs. Bissett's Roses, one, Charles I., was an excellent flower. Mr. Newett, gardener to H. Pratt Mc Kean, had some remarkably fine plants. One of them a *Dendrobium densiflorum*, though the single trusses were not so large as in the case of the one above referred to, had *eighteen* of them; this is an orange yellow, and a very desirable April flowering kind. He had also an *Oncidium Cavendishii*, and a *Catleya amethystina*, a very rare kind of orchideæ, with nine blooms on it. In Mr. Mackenzie's collection, we noted, we believe for the first time on exhibition, *Scutellaria Moquiniana*, with scarlet tubular flowers about two inches long, and one fourth of an inch thick; its growth is upright, and not calculated to form showy specimens. Amongst Dreer's Roses, Merveille d'Anjou attracted much attention, though to us it seemed too much like the old La Reine; his Ville de Lyon was very good, as was the pretty yellow Merechal Neil, now so well known. Buist's Azaleas were grand,—not only the old kinds of which magnificent specimens were exhibited, but the small plants of the newer kinds made a good show. A rosy variety, Juliana, pleased every one by its waxy petals and regular form; and Admiranda, a white striped one, was also worthy of much praise. Count Borsig, a semi-double white, is, we think, the best of its class yet raised. Baroness Hester, a purple rose, and Scharenkherst, vermilion rose, promise to be good acquisitions. Souvenir de Prince Albert, a white and pink blotched, gave a pretty effect. He had also a splendid

specimen of the beautiful fern *Lomaria gibba*, with fronds about 18 inches in length. Dreer had his usually fine pansies, besides a bank of *Echeverias*, in which *E. secunda* and *E. metallica* were conspicuous. Amongst Robert Scott's roses, the hybrid perpetual, M. Thiers, was very conspicuous for its beauty.

Thos. Smith, gardener to Matthew Baird, Esq., had a beautiful collection of Dracænas and other plants; but perhaps one of the most attractive plants in his collection was *Dendrobium macrophyllum* with nine beautiful flowers on it. The numerous rare orchids which are being constantly exhibited at this Society, is one of its most valued features to lovers of flowers.

Amongst some rare variegated plants one of the prettiest was a *Polemonium cœruleum variegatum* by Mr. Buist. In this collection also was a Caladium "Beethoven," which had the leaves chiefly white, but veined with pink and green. He also had a cut specimen of Camellia "Cocheleata." This flower was four inches across, and the pink and white petals were arranged like spoons, whence its name. Mr. Buist's double Petunias were remarkably fine; one "Dandy," a crimson white, and another "Beauty of Rosedale," almost all white, only a small spot of purple in the centre; these appeared two of the best. From Meehan's nursery came *Ajuga reptans*, with spikes of blue flowers, and adapted to shady places, being a companion plant to *Lysimachia*. Mr. Hugh Graham besides a beautiful collection of house plants, had a splendid show of designs and baskets of cut flowers.

There appeared to be many exhibitors in this department, but the incessant throng of ladies around them, prevented anything in broadcloth from getting within twenty feet of them. We tried at various times within a couple of hours to break through this charmed and charming circle, but all in vain. Whose they were and what they were, will be long held in remembrance by the many hundreds of Philadelphia ladies who saw them, but "not for me" was the sigh of our discomfited reporter. The numerous contributors deserve great credit for their spirit and enterprise in sustaining the Society, and the Society in turn should endeavor to do them honor. It is well enough to award them high premiums, but if the list of those to whom the awards were made, was published in full in the horticultural journals, we think it would be but full justice to the exhibitors, and redound to the interest of the Society.





# The Gardener's Monthly.

DEVOTED TO

*Horticulture, Arboriculture, Botany and Rural Affairs.*

EDITED BY THOMAS MEEHAN.

Old Series, Vol. XIII.

JUNE, 1871.

New Series, Vol. IV. No. 6.

## HINTS FOR JUNE.

### FLOWER GARDEN AND PLEASURE GROUND.

The time will soon come when the greatest source of enjoyment in gardening—the lawn—will be, so to speak, in season. It used to be the most expensive part of a place; but thanks to the introduction of lawn mowers, it is now a comparatively easy task to keep the lawn in order. It is now well to remind our readers that the *Gardener's Monthly* has been the means of developing the fact, that we have been cutting too close with these machines. This is the great cause of machine mowing ruining lawns. The implement should be set so as to leave the grass a half inch at least above the roots, and where the grass is weak, an inch will be better. To those who have not yet a lawn mower, but have still resort to the scythe, we would say mow lawns often, if you would have them green and velvety. Keep the scythe sharp; usually mowers do not use the grindstone often enough. Common farm scythes are not fit for lawn use; rivetted and short scythes are the kind to get. If a lawn is mowed often, the grass need not be clean,—the sappy blades soon wither, and make a manure for the roots. The longest should be raked off, or the lawn will have a littery appearance.

Evergreen hedges will require attention as they grow. Where the height desired has been attained, the top and strong growth should be cut back while they are still watery. The side shoots need not be touched till past midsummer. All wise people now employ the conical shape for hedges. In cutting back the top growth at this season, the conical form can still be preserved. When we commenced to advise this,

the square top form was very common, and as a result the sides soon became thin towards the ground. We have kept reiterating this advice every year, till now we have the satisfaction of rarely seeing one of the old miserable things.

The Rose season reminds us to say that we are almost sorry they are so generally grown on their own roots, for it was such a nice employment for many people, not professional gardeners, to bud them on the Manetti stock. But the suckers from these wild stocks came up, and in time so weakened the grafted part, that it soon died. Florists would say that amateurs should keep the suckers cut away; but it is not easy for amateurs to distinguish one from the other. Yet we hope the pleasant practice of budding roses will not fall into disuse. Any hardy kind can be used for a stock, and one may have a dozen or more kinds on one plant in this way. In budding roses, or indeed in budding any kind of plant, strong healthy stocks should be selected, and above all, strong healthy buds. It is chiefly when weak stocks or weak buds are used, that failure follows.

The rose bug is a great pest in some districts, but these are easy kept down by being shaken off into a bucket of soap-suds; and the larvæ of the rose fly, which in the form of small green caterpillars, which skeletonize the leaves, are so easily kept down by *pinching them*, that we know at once there is no reader of the *Gardener's Monthly*, wherever we see roses denuded of foliage by these little "worms." If the job is too severe for delicate nerves, there are plenty of boys will clear one's whole rose patch of them in an hour for 25 cents.

Propagation by layering may be performed any time when strong vigorous growing shoots can

be had. Any plant can be propagated by layers. Many can be readily propagated no other way. Cut a notch on the upper side of the shoot, not below, as all the books recommend, and bend down into, and cover with rich soil. In a few weeks they root, and can be removed from their parents. Stakes for plants should be charred at the ends before using, when they will last for years.

Flower-beds should be hoed and raked, as soon as the ground dries after a rain. Loose surface soil prevents the under stratum drying out. Peg down bedding plants where practicable. Split twigs make the best pegs. In dry weather do not water flower-beds often; but do it thoroughly when it is done. See that the water does not run off, but into and through the soil.

No trees, Evergreens especially, should be suffered to have grass grow about them for a year or so after planting. It becomes "rank" in the deeply loosened soil, abstracts moisture, and otherwise seriously interferes with the tree. When the tree gets a fair start, grass does less injury, and when it becomes a tough sod, and the tree by its shade, or say by frequent mowing keeps the grass short, the grass roots do not penetrate deep, and the sod is of benefit, by keeping the surface spongy, and the substratum cool.

Many herbaceous plants, such as Phloxes, Hollyhocks and similar things, that are scarce and valued, may be propagated now very easily, by taking portions of their flower-stems before the flowers open, and inserting them as cuttings in a half shaded, cool, and not dry situation. Layering of many things, shrubs, half shrubby perennials, etc., should be done before the young wood becomes too hard, if good plants are required the first year. Most plants root more quickly by having a notch cut in the layered shoot. Good, rich soil, put just about the layers is very important. Good soil favors an abundance of roots. One of the greatest mistakes in gardening is the prevalent notion that plants in a poor soil have a greater proportion of roots than in a rich one.

---

#### FRUIT GARDEN.

The test of a good gardener is to be found in how he thins his fruit. Your shoddy fellow takes all nature will give him; he buys the largest trees he can find, because they will bear "right away," and he expects not merely a specimen or so of a kind, but pecks if not bushels from newly

planted trees. But as he becomes amongst the refined and educated in the pursuit, he gradually learns that nature loves best the patient waiter. He learns that good luscious fruit—fruit truly enjoyable—only comes from healthy vigor, and that this never follows a tree which bears too much. Even good gardeners often say that if a tree is healthy, it may be permitted to bear all it will; but that kind of tree is very rarely seen. Certainly half the trees which bear fruit every year, would be benefited by having half the fruit taken off, as soon as it is well set; that is after they commence to swell a little. The grape vine especially suffers from overbearing; two or three bunches usually come out from each fruit bearing branch. We should always cut away one, the one farthest removed from the main stem; and in many cases leave only one—the nearest one—to mature. When this is decided on, cut away these superfluous bunches at once.

Fine rich color is always esteemed as one of the criterions whereby to judge of the excellence of a fruit. Sun-light is of first importance; but it is not generally known that this is injurious when in excess. In a dry atmosphere, with great sun heat, where the evaporating process goes on faster than the secretive principle, what should become a rich rosy blush in a fruit, is changed to a sickly yellow; and the rich jet black of a grape becomes a foxy red. Some Grape growers of eminence, in view of the facts, shade their vineries during the coloring process; but others, instead, keep the atmosphere as close and moist as possible.

We again report the advice to trap insects with wide mouthed bottles filled with sweet liquid.

---

#### VEGETABLE GARDEN.

Peas for a Fall crop may be sown. It is, however, useless to try them unless in a deeply trenched soil, and one that is comparatively cool in the hottest weather overhead, or they will certainly mildew and prove worthless. In England where the atmosphere is so much more humid than ours, they nevertheless have great difficulty in getting fall Peas to go through free from mildew; and to obviate these drying and mildew-producing influences, they often plant them in deep trenches, made as for Celery, and are then much more successful with them.

Cabbage and Brocoli may still be set out for Fall crops, also requiring an abundance of ma-

nure to insure much success. Lettuce, where salads are much in request, may yet be sown. The Curled Indian is a favorite summer kind; but the varieties of Cos, or Plain-leaved kinds, are good. They take more trouble, having to be tied up to blanch well. Many should not be sown at a time, as they soon run to seed in hot weather.

At the end of June, some Celery may be set out for early crops, though for the main crop a month later will be quite time enough. It was once customary to plant in trenches dug six or more inches below the surface; but the poverty of the soil usually at this depth more than decreases the balance of good points in its favor. Some of our best growers now plant entirely on the surface, and depend on drawing up the soil, or the employment of boards or other artificial methods of blanching.

Beans produce an enormous crop in deeply trenched soils, and are improved as much as any crop by surface manuring. We hope this method of fertilizing the soil will be extensively adopted for garden crops this season. Those who have not yet tried it will be surprised at the economy and beneficial results of the practice.

Cucumbers for pickling may be sown this month, and Endive for fall Salad set out. Parsley for winter use may be sown now, in boxes of rich soil, and set in a cool, shady place till it germinates.

Asparagus beds should not be cut off after the stalks seem to come up weak, or there will be but a poor crop the next season, and the beds will "run out" in a few years.

Tomatoes, after trying all kinds of trellises recommended, will be found to do best on stakes tied up singly. It is best to plant a strong pole as for Lima Beans, with the plants when first set out, and tie up as they grow. Marketmen generally let them grow as they will, on the ground, which, perhaps, although not yielding as much, costs less labor, and may thus be most profitable.

The Swede Turnip or Ruta Baga should be sown about the end of the month. A well enriched piece of ground is essential, as by growing fast they get ahead of the ravages of the fly. Manures abounding in the phosphates—bone-dust, for instance,—are superior for the Turnip.

Sweet Potatoes must be watched, that the vines do not root in the ground as they run, which will weaken the main crop of roots. They should be gone over about once a month, and with a rake or pole, the vines disturbed somewhat from their position.

Parsley for winter use may be sown now in boxes of rich soil, and set in a cool, shady place till it germinates.

Herbs for drying for future use, should be cut just about the time they are coming into flower. Dry them in the shade, and after sufficiently dry to put away, tie them in bunches, and hang in a cool shed, or place them loosely between the paper, and stow away in cupboards or drawers,—the last mode is by far the cleanest and most approved plan with the best housekeepers. Some, indeed, powder the leaves at once after drying, and put them away in bags, ready for use.

## COMMUNICATIONS.

### HOW TO MAKE PRODUCTION POPULAR.

BY E. T. POWELL, ADRIAN, MICH.

It is an undoubted fact that farm life is unattractive, and is like a treadmill. One must rise at light and toil into the night, and cannot have a dazzling prize to lure him on—and he must feel that a roaring world is busy all about him, and he is hid from the sight of it. He feels separated from the beating pulse of the world; and in our age when a railroad runs within easy

range of every man, it goes hard to feel that the world is alive with new ideas and new schemes, and inventions, and discoveries, in which we can have no part.

This difficulty must be reached and obviated by bringing the world home to the farm—I mean that production will become popular just when you make it as enlivening, thoughtful and poetical as the work of the professions and city arts. Heretofore it has been supposed that a meagre

knowledge of reading, writing and the rudiments of geography were sufficient for a farmer. When you lay it down that our farms must have their high schools and the farmer his college training, you will make agriculture the most bewitching employment under the sun; you will make it what it was to Virgil and Horace, and what it is now to Greeley and Beecher, and what Auerbach in his Villa on the Rhine makes it to Sonnenkamp. Now the farmer walks ignorantly over thousands of beauties, of discoveries, of laws, of thoughts, of sources of wealth, and he does not see them. With a thorough education he will recognize them; for instance, many a man has tilled over a silver mine and not known it; he has walked over untold wealth and discoveries which he had no power to recognize. Give him now a knowledge of chemistry, and he will understand the composition and nature of the soils that he works, and his brain will be alive with study and thought while his hands hold the plough. He will know the value and use of a mineral spring—what to do with a deposit of peat or marl. Indeed you have set him on a search, taught him to expect something and you may be sure he will find something. Teach him botany, open before him the organic world of plants, trees, and flowers. Every flower that is to another but as a grass spire is to him a cup brimful of wisdom. Emerson sings as he looks on the farmer's work,

"One harvest from thy field  
Homeward brought the oxen strong,  
Another crop thine acres yield  
Which I gather in a song."

There is no reason why the farmer should not be educated to see the beauty and the wisdom that receives his booted heel. Give him a thorough scholarship in horticulture, so that he can keep even paced with all improvements in varieties of fruits and vegetables, and try experiments himself in the origination of new varieties. It will bring his soul into quick thinking connection with such experimentors as Van Mons, Verschaffelt, Downing, Warder, President Wilder; it will lead him into sympathy and a comprehension of such princes of enquiry as Agassiz, and Tyndall, and Faraday. What matters it that he is on a farm? His very feet tread the volumes of nature, and these volumes are open books to him. We cannot go into his pasture, or his garden, or his orchard, but new truths meet him, quicken him, and incite him. I do not know a pleasure much more exhilarating and healthy than that which comes from

success in hybridizing, or by seedlings originating an improved fruit or flower. Last year I brought to bloom several seedlings of *Gladiolus*, one of them proved to be a variety hardly ever equaled. Do you know what pleasure, what a fresh draught of life that gave to me? I absorbed its life and beauty into my life, and felt for even that one flower my life had not been in vain. There are farmers who are every year, by these experiments and scholarly zeal, proving themselves royal benefactors of their race. Take Dr. Kirtland of Cleveland, who started our Gov. Wood and several others of the best cherries.—take Seth Boyden of Jersey City, who originated the *Agriculturist* and more of the finest strawberries,—instance Rogers, and Allen, and Barry, and Longworth, who, by patient care, have added much wealth to our list of grapes and pears. I think I should like to have my name go around the world embodied in a strawberry, or labeled on a peach. No one who sucked the sweet juices but will breathe a blessing on me, and my immortality will be secured by the ever recurring spring giving a new bloom to my cheek. That will be better than publishing a volume of priceless sermons, or being immortalized in Latin or by two d's in capitals. Why, do you think farm life could have been dull, or production drudgery to Goodrich of Utica, who, after years of patient culture, gave us as the result, the Harrison, the Goodrich, the Garnet, the Cuzco, and the Gleason Potatoes? Such men are putting spires to progress,—they are doing more than all gold miners to increase the material prosperity of the land, and they are doing only what any young man may do. The field is absolutely infinite. We need new apples and pears still,—new strawberries and cherries. I prophesy that in ten years we shall have quinces more soft and delicious and fragrant for eating than peaches,—berries that utterly supplant what we now use,—and such an advance in fruits and flowers as will make past progress seem to have been slow.

For one, I hail the Agricultural Colleges with intense joy. I deprecate every attack upon them. Correct their errors, but give them every encouragement. Let us have rural schools of the highest order of merit. It is not enough to educate our lawyers and ministers; educate also in the fullest sense your tillers. In England it is becoming quite common to educate the second son for the ministry, and the third for a professional agriculturist. That is it!



Give us professional farmers; make farming as much and as truly a profession as law, and preaching, and healing.

Last Fall, at our State Fair, one of the most interesting sights that I saw, or have ever seen, was a collection of somewhere near a hundred varieties of potatoes, and some two or three score varieties of tomatoes from our State Agricultural College, each labeled, and all presided over by a young student who was as well skilled in such roots as ever a classical student was in the roots of Latin and Greek. Now I do not care to eat tomatoes, but I can wax very enthusiastic in raising them. Fejee, Early York, Tilden, Sim's Cluster, Cook's Favorite, Lester's Perfected. I like to know the origin, history, color, and solidity of each; just the shade of color, their prolific rank, and season of ripening. And really I esteem acquaintance with every new potato from the old Western Red at \$1 50 per barrel, to Early Rose at \$90, as much as my acquaintance with Cicero, Virgil, Sallust and Homer.

Nor is there any reason why the farmer should not be taught astronomy. Thank God one does not leave the stars behind when he leaves the city gas lights. There is no reason why every farmer of moderate means should not have his small telescope mounted in an observatory on his roof, and with it take many a tour far wider and more useful than the tours of the wealthiest tradesmen. Whereas the one goes to buy dry goods, the other goes to buy truth; the one goes to the metropolitan towns of his native earth, the other visits the metropolitan worlds of space.

Let the idea be thoroughly adopted, that no one needs a more thorough education than the farmer, that he must have a thorough discipline of mind. Send him out into the fields to meet sciences, inventions, discoveries, art, poetry and law, and you have utterly transformed him. You have turned the drudge into the king, you have made him Lord of the soil. Now you rarely find a farmer who has skill or information that goes farther than a well covered mow, and a well curried stall. His farm is only so many acres of pasture, and meadow, and woodland, out of which to get the heaviest crop and the best living.

#### THE GOLDEN AND SILVER YEWS.

BY EMILE W. WINTZER, MORRISVILLE, PA.

There are two evergreens which are worthy

of more notice than they receive. They are the Golden Yew (*Taxus baccata aurea*) and the Silver Yew (*Taxus baccata elegantissima*). They are two of the most beautiful evergreens in cultivation, and are well adapted to our climate. They are varieties of the English Yew. The great peculiarity of the Golden one, is that the young growth is of a bright yellow color, which gives it the appearance of being tipped with gold; and when the wood ripens it retains its beauty, as the leaves are still edged with a golden color. Unlike most of the variegated plants, it is not affected by the burning sun. It is as well adapted to small gardens as larger ones, and is hardy in most parts of the United States. It is easily propagated by cuttings. It is of slow growth however, and a much quicker way to raise it is by grafting on some of the stronger growing sorts on which it takes quite freely.

The Silver Yew differs from the Golden in having its young growth more of a silver color, which gives it a very delicate appearance; but it does not stand scorching by the sun quite so well as the Golden. The propagation is the same. Either of these evergreens are well worth cultivating, and deserve a place in every garden.

#### THE NANKEEN COTTON.

BY W. G. B.

Fifty years ago, a common and popular material for summer clothing for men and boys was an article imported from China, and commonly called Nankeen. This fabric retained its reputation for many years, but was finally driven from the market, as many other excellent fabrics have been, by worthless imitations introduced from Europe, or manufactured in the United States. I am surprised that no effort has been made in this country to produce an article identical with that originally imported from China. If such an attempt has been made, I never have heard of it. Would it not be profitable for some enterprising southerner to obtain seed and introduce the culture of the kind of cotton necessary for the purpose? I was induced to make the inquiry whether this has ever been done, by reading lately the work of Fortune from which the enclosed extract is taken:

"The yellow cotton from which the beautiful Nankeen cloth is manufactured, is called 'Izemic wha' by the Chinese, and differs but slightly in its structure and general appearance from the kind just noticed. I have often compared

hem in the cotton fields where they were growing; and although the yellow variety has a more stunted habit than the other, it has no characters which constitute a distinct species. It is merely an accidental variety; and although its seeds may generally produce the same kind, they doubtless frequently yield the white variety, and *vice versa*. Hence specimens of the yellow cotton are frequently found growing amongst the white in the immediate vicinity of Shanghai; and again a few miles northward, in fields near the city of Pouchon on the banks of the Yangtse-kiang. Where the yellow cotton abounds, I have often gathered specimens of the white variety."—*Fortune's Wanderings in China*.

### RECOLLECTIONS OF VAN DIEMEN'S LAND, OCEANICA.

BY MR. W. T. HARDING, BRIGHTON, MASS.

I thought of the old song addressed to

"Ye gentlemen of England, who live at home at ease,  
How little do you think upon the dangers of the seas."

and how applicable it seemed as I staggered about the deck of our tempest tossed barque, anxiously waiting for daylight and the sight of land. The night had been stormy and wet, and the wind seemed to blow from every quarter but one, and what with tacking about and knocking about, and involuntarily performing some "wonderful acrobatic feats," "balancing and posturing" with many "marvelous gyrations," I fancied I was more skilled as a tumbler when at sea, than a horticulturist, in which capacity I lived when on shore,—although I well remembered performing some "remarkable feats of lofty and ground tumbling" when a boy, from a Jargonelle pear tree which grew in my old school-master's orchard, and which I visited one evening during the fruit season; a fact that certainly indicated an early enthusiasm for pomological studies. So forming a committee of one, I climbed up the tree with a view of testing the merits of such luscious looking fruits, when a voice, I had often heard, and a form with a hazel stick I had seen and felt before, warned me of the wrath to come, which surely did on the following morning, when I was "beaten with many stripes." I was made to smart for it to be sure; but that was slight when compared with the bruising I received on the ill-fated "Merope," which afterwards foundered, with the writer on board.

But to make amends for the trespasses I committed (although the sin was only in prospective, for I did not get a taste of the fruit I

so much admired) when in after years I returned to my native village, I asked the old man's forgiveness, when his time furrowed features seemed radiant with goodness, and removing his spectacles, which were dimmed with tears, he grasped my hand silently, admitting that it was even so. Subsequently I planted a St. Helena weeping willow over his grave, which I brought from there

"Where the spring water flows  
And the willow tree grows  
By the grave of the Great Napoleon."

But I fear this is rather a rambling story, which memory seems to recall again, and lead me back to "the long ago."

The first gray streaks of morning light showed land in view, which the gallant Tassman named in honor of his lady love, Maria Van Diemen, Van Diemen's Land. Literally it was a land of demons at one time, having been for many years a penal colony, which held in durance vile those "who left their country for their country's good." It was an agreeable surprise to find Hobart Town such a flourishing and beautiful city, with well macadamized streets, good stores, comfortable dwellings and public buildings, that would do credit to more favored and older settled countries.

Leaving the city and looking around, I was attracted to an enclosure which contained some fine Date Palms in full fruit, also fine Loquats, Mangos, Figs, Oranges, Shaddockes, Guavas, Limes, Pomegranates, Peaches, Raspberries, Currants, and Strawberries; most of which were well loaded with fruit, and growing luxuriantly.

Grape vines seemed very vigorous and fruitful, bearing larger bunches than two of the biggest white Syrians put together, I ever saw grown under glass. I feel certain that many of the bunches would weigh more than the famous one grown by Speechley. The kinds grown were chiefly Syrians, Malagas, Tokays, Lombardies, Muscats and Hamburgs.

It has been my good fortune to see some excellent vineyards along the shore of Lake Erie, of which the owners may justly feel proud; and also the extensive ones at the foot of Table Mountain, Cape of Good Hope, which supplies Europe with the celebrated Constantina wine; but I never saw elsewhere bunches grow to such an enormous size, or of better flavor. Australia is producing a good domestic wine, for which the demand is steadily increasing, and it will, no doubt, become generally used instead of the fiery fluids with which the country is cursed.

In the suburbs of the city were some beautiful cottages, nestling beneath clustered masses of *Chorozema ilicifolia*, *Podolobium scandens*, *Edwardsia grandiflora*, *Kennedyia monophylla*, *Jasminum divaricatum*, and other handsome climbers, which in many instances completely hid the houses, all but the doors and windows. Most of the gardens and yards enclosed and divided with hedges of *Hakea ulicina*, *Epacris exerta*, *Eugenia myrtifolia*, and *Eriostemon buxifolium*; *Banksia serrata*, and *B. dentata* make quite a defensive hedge.

Leaving the city as soon as I could make arrangements for the journey, I hastened onwards towards the "bush," as the forests are so called, and had not traveled far, when, to my great surprise, I beheld in the centre of a large and beautiful garden, a group of the brilliant *Telopia speciosissima* trees in full bloom, which in the distance appeared to be a pyramid of fire. Such a gorgeous sight I had never gazed on before, and will ever remember it when thinking of the many floral beauties I have seen. The proprietor's mansion was situated in the rear, and approached through an avenue of *Cyathea glauca*, alternated with some fine *Livistonias inermis*, and faced with a row of *Foucroya Australis* of good size, which was margined with a hedge of *Hovea Celsi* of a uniform height, and completely covered with its beautiful blue flowers. Such a paradise, and such temptation, I could not resist entering; so opening the gate I ventured within, and was met by a venerable looking old man of a patriarchal appearance, who invited me to examine his grounds; and seeing how delighted I was, he volunteered to accompany me and show me the choice fruits, trees, and flowers, so abundant and beautiful on every side. The sun was at its meridian, "high noon," and hot indeed was the atmosphere when we sought the shade of a rustic arbor, and took a seat within, which was well shaded by a *Billardia fusiformis*. Pointing to a tree near to where we sat, my aged companion said he valued it more than all the trees or flowers his grounds contained, as olden memories returned whenever he saw it. "Why, it is a Hawthorn, I remarked." "Yes," he replied, and the haw from which that tree was raised I received from dear old England, years ago; my brother sent me the seed, which he gathered from a tree that overhung my father's cottage door, and which I had often climbed when a boy, and the recollections of my mother seem to return again with all the fresh-

ness of youth, as she sat beneath its shade one summer afternoon busily engaged with her needle repairing my little jacket, (and I believe the only one I had,) for she was very poor, and had a large family to care for. I was then an innocent boy, free from guile, little thinking of the mysterious future in store for me. Enquiring what part of England he formerly lived in, imagine my surprise when he mentioned the village where I was born, and told me his name was \* \* \* \* Good heavens! how nervous I felt, and how the perspiration streamed from every pore, as the thought occurred that I was conversing with the man who burglariously entered my father's house and stole his watch and other things, for which he was arrested, tried and found guilty, and sentenced to seven years transportation to Van Diemen's Land. Oh how sorry I felt for him, poor tottering old man, what a career his must have been.

Hastily rising from the seat, and thanking him for his kindness, I made the best excuse I could for my abrupt departure, assigning as a reason urgent business. Thus leaving and bidding him adieu, I felt somewhat relieved from the embarrassment under which I was laboring; as I closed the gate behind me and returned to the road, and in a thicket of *Metrosideros* near to, gave vent to my feelings unseen.

God knows I pitied him, and to spare his feelings, hurriedly withdrew, fearing that he might enquire where I came from, and ask my name. I afterwards learned that he obtained a "ticket of leave" soon after his arrival for his good conduct, and hiring himself to a farmer, whose daughter he afterwards married at the expiration of his term, and having obtained a fortune with her, speculated in business, became wealthy, and I hope happy too.

*Oxleya xanthoxylon*, a singular tree, often attaining to two hundred feet in height, *Metrosideros robusta*, *Melia Australis*, and the noble *Eucalyptus amygdalina*, and *E. obliqua*, made excellent shade trees along the roadsides. *Cupania Cunninghamii* was abundant, and wherever I saw it, I invariably found its branches entangled with dense masses of a beautiful climbing plant, *Thysolobium carinatum*, bearing scarlet, pea-shaped flowers. *Epacris coreallora*, *Chorozema nana*, and the lovely *Veronica nivea*, with its snow white flowers mingled with *Tasmania aromatica*, and *Trymalium odoratissima*, which perfumed the air. Large patches of *Geranium parviflorum*, *Thysanotus proliferus*, and

the curious *Stylidium fruticosum* were both singular and beautiful. Of Ferns, I will note a few, namely: *Pteris Kingeana*, *Polystichum proliferum*, *Lomaria lanceolata*, *Hypolepis rugulosa*, *Drynaria diversifolia*, *Dictyopteris attenuata*, *Adiantum pubescens*, *Schizœa bifida*, *Aspidium coriaceum*, *Polypodium scandens* and other kinds were plentiful in their favorite habitats, the shady groves.

Orchidæ were well represented, and the name of a few which were conspicuous, are as follows: *Thelymetra longifolia*, *Dendrobium cassythoides*, and *D. rigidum*, *Neottia Australis*, *Cymbidium suave*, *Cryostyles longifolia*, *Sarcochilus falcatus*, and *Gastrodia sesamoides*,—kinds which will be recognized by some of the *Monthly's* subscribers as favorites of the olden times.

### THE CODLING MOTH.

BY MR. D. N. BROWN, ST. JOSEPH, MO.

*Read before Berrin Co., Hort. Society.*

It has pleased you to call on me to address this county association of fruit growers on the nature of and habits of the codling moth. I regret exceedingly that you have so overrated my ability. After a moment's hesitation I consented to do so, only through the strong desire I feel for the entire success of every fruit grower in this county and elsewhere. It is known to some of you, that I have for a few years past, devoted much time to learn from my own observations the nature, habits and character of this insect most destructive not only to the apples and pears of this section of country, but of all parts of the United States, and Canada, except that portion lying west of the Rocky Mountains; and as apples are being transported to California, I see not why this codling moth will not find her home that favored land.

As I am not a great reader, I shall not be able to inform you where this moth originated, or by whom it was first discovered. I well remember when a boy, how in my father's orchard in Connecticut the Seek-no-further and Greening apples were nearly all destroyed by this same ugly looking apple worm; and for the last 40 years, wherever I have traveled, I have seen her mark of destruction upon the most valuable fruit of our land.

Last year, this insect was more destructive than usual, owing to the warm, dry and long season, which is more favorable to the insect tribes than cool or wet seasons. My young or-

chard, which promised some 20 barrels of apples, was by the larvæ of the codling moth cut down to less than one bushel of sound fruit; also my Bartlett and Seckel pears were chiseled out to give them nutriment, and shelter from the eagle eye of many of the feathered tribes who are seeking such for food.

The codling moth is a gray, dirty looking miller, about three-fourths of an inch in length, very quick in her movements and when still her wings lie close to her body. Early in the month of June, she makes her appearance, and may be seen by jarring the limbs of the trees. She makes many angular motions while descending to the ground, and conceals herself instantly.

When the apple reaches the size of a hazelnut, she deposits her egg in the down of the blossom, where it hatches in a few days if the weather is warm. Immediately the young larva begins to cut its way toward the centre of the fruit to feed upon its flesh and seeds. If, however, the end of the fruit is too hard, the larva will leave and enter some more tender part. It is common for them to leave one apple and enter another; and thus a single worm may destroy a large quantity. There are continuous and consecutive crops of these insects from early summer until late in the fall, or until the apple crop is gathered. They increase rapidly as the warm weather advances. In the spring their commencement is but small, owing to the wood pecker, and many other birds which prey upon the larva whilst slightly protected in its silken case, and deposited about stumps, hollow weeds, and especially under the scales of dead bark on the apple tree. On examination you will see many of these scales perforated by birds, who subsist during winter upon insects. I have often wondered to see with what precision they strike their game. When you see a small hole through one of these old scales, pull it off and notice the accuracy with which this natural mechanic hits the cocoon which contained his morning meal.

Many apples containing the larvæ of this moth are barreled, and you will often find a large number of these cocoons, about the hoops and joints, which should be carefully destroyed. Should you make any of your lighted rooms a storehouse for apples in the spring, you may find your windows dotted with this miller. Owing to the many methods by which this larvæ in winter is destroyed, the early brood is small. These, however, deposit their eggs, which hatch

into a perfect moth in about thirty days, which in their turn are ready to make in the apple a second deposit of eggs; which, as we are not able to ascertain the number of eggs each female can lay, we may safely conclude that this crop can out number from fifty to one hundred times the spring crop. We have now reached about the middle of July, or the first of August, when the fruit bitten by the first crop of the larvæ are falling to the ground, and some of the early varieties beginning to ripen. A fair crop of early fruit may be expected, for they escape the latter broods of this sweeping pest.

In August and September we shall find issuing from the blossom, and of many of our fine smooth apples, a dark liquid matter, indicating that another brood of this loathsome insect has commenced its work of destruction. You will also see small red spots on the fair perfect fruit, showing that another brood of these larvæ are cutting their way through to the completion of their work. Thus one brood succeeds another, until in many cases, nearly our entire crop of winter fruit is pierced with holes and lies withered on the ground.

The worm, when small, is dark, and has a black head; when about half an inch long it moults, after which it grows rapidly and soon completes its work of destruction; when of full size, the worm—yellow or reddish, with a copper colored head—prompted by instinct, leaves the apple and hunts a place of concealment to wind into a cocoon, and pass its transformation to the perfect moth.

The larvæ is seldom seen outside of the fruit by daylight; but in the dark hours, it is quick in its motions, and travels from one apple to another; it travels up and down the branches and trunk, either to enter new fruit or a place of concealment. When it reaches maturity, it hunts a hiding place to pass from the worm to the perfect moth; a period, in very hot weather, which does not exceed ten or twelve days. Should the worm fall with the apple to the ground, it will on reaching maturity, in most cases return to the tree. These characteristics we have carefully noted; on these habits we have extensively experimented, and have demonstrated beyond the possibility of a doubt the certainty, and the practicability of their destruction.

Few have ever contemplated the vast injury done throughout this continent to the apple by this self-sustaining, unyielding and greatest of

all destroyers, the codling moth. I now feel called upon to show you the amount of damages sustained by this unlimited destroyer. Here I find myself wholly incapable, when we look at this vast country from Maine to Florida, and from the Atlantic to the Pacific coast, and so extensively populated by farmers and nearly every one has his apple orchard, and from 25 to 2,000 trees each; and that all these have suffered from 10 to 95 per cent. annually, from near the first settlement of this country to the present time; and that Europe and many other parts of the world have suffered equally with us, from this same muddy looking miller, we can only compute the injury sustained by untold billions.

Other insects, or many of them, seem to have their time, and pass away like the army worm, the weevil, the hessian fly, the forest and canker worm; not so with the codling moth—he lived many hundred years ago, and from that without intermission to the present, and unless the future shall call out and develop a class of fruit growers who shall more earnestly study and learn the nature and habits of this (to me, the most hateful and destructive pest,) we may look in vain for a remuneration from our fair and beautiful apple orchards.

Mr. Ransom, my respected friend and colleague, in the study of worm and "bugology," who with his untiring diligence, has done such ample work in leading out our armies of orchardists, to destroy the curculio, may have led some of us to conclude, that as fruit growers we have no enemies to fight but the curculio; but when we look at the little local patches of from 10 to 50 miles square scattered up and down this country alone, and all lying east of the Rocky Mountains, its destruction to fruit, when compared to that of the codling moth, is as St. Joseph to the remainder of Uncle Sam's vast domain.

We now invite the attention of all apple-orchardists to a simple, practical method of exterminating this pest from any given locality, at an expense which will not exceed \$1 50 per acre. About the first of June, take a whisp of rags, cotton or woolen, woolen preferred, which will wrinkle and afford concealment,—say about the size of a sleeve doubled,—and place these rags in the lowest forks of the apple tree, or wind several thicknesses of rags about the base of the tree, or both. All the worms descending and ascending will crawl in and remain. Now we

know where the apple worm is. How shall we kill him ?

Take a clothes wringer, place it on a light frame, then carefully remove the rags from a tree, for some of the worms will be attached to the bark, place an end in the jaws of the wringer and run the rags through, every worm is annihilated; after this replace the rags.

This work should be repeated every ten or twelve days during the season, and until the fruit is gathered, varying according to the heat of the season. The rags should not be used unless the wringer is also; for unless the worm is destroyed, you have only given it a comfortable and convenient concealment, close to the favorite fruit it greedily destroys.

Various methods are recommended to aid the orchardist to defend himself against this most formidable destroyer; among them is that which turns our orchards into hog-yards. This is not practicable; for many of our orchards are open to corn and potato fields and to our strawberry and vegetable gardens. I have for the last two or three years considered it as necessary to destroy the apple worm as to look after any other interest. We often find from fifty to one hundred at a time in our simple rag traps. One of my neighbors killed from a single tree over four hundred in one season. Another of my neighbors with the rag traps slaughtered in his orchard of a few hundred trees, from fifteen to twenty thousand.

These are facts which many here present can verify; for the men who make these statements are our neighbors, practical fruit growers, whose truth and veracity are beyond a doubt, and in whose word we place implicit confidence; and yet certain professional entomologists throw the influence of their reputation against this testimony. Young men with a smattering of Latin, a powerful microscope and a drawing pencil, discredit practical fruit growers whose lives have been spent in an orchard, because they have not the key to the ear of the public. We would respectfully ask: Can Mr. Riley, or any other professional entomologist, tell us by what means so simple and so cheap as the rag trap this wholesale destroyer of our precious fruits can be taken in such quantities and used up?

This Mr. Riley, the State entomologist of Missouri, and one of the editors of the *American Entomologist and Botanist*, when on a visit to this grand fruit belt, on the eastern shore of Lake Michi-

gan, acknowledged this far ahead of any previous discovery in our battle with the codling moth; but on his return to Missouri, he changed his mind and went back to the hay and straw bands. His reasons he omitted to give. To my mind there is but one solution to this mysterious change of opinion; and that is perfectly reasonable and legitimate.

Mr. Riley, when here, was brought into the atmosphere of several of our most progressive and successful fruit growers; and therefore looked upon these improvements from the standpoint of common sense; but on his return to St. Louis, he struck an old atmosphere, that carried a grist to mill with a stone in one end of the bag and corn in the other; the atmosphere that recognizes no advancement outside or beyond, and sees no merit in the lower walks of life. Yet, I believe were he here to day, he would discard his straw bands as out of date and too complicated for common use, and again approve the trap of rags.

The proposed method is better than making a hog-yard of the orchard, for we have already stated that many of the worms, we believe that all of the worms have left the apple, except windfalls, before it falls from the tree. Wisps of straw and hay have been recommended to aid the fruit grower to wage war successfully against this hateful pest; but the successive broods from summer until autumn require many bands, and make this plan too laborious, since it consumes too much precious time. Loose bark should be removed from the trunks of old trees, thus removing a natural hiding place.

In the opinion of the speaker, but one thing remains to complete the destruction of the apple worm. It is united and combined action, and I would respectfully ask that a resolution may be passed, recommending all apple orchardist to unite in applying this simple remedy.

#### THE CABBAGE HEAD.

BY MR. H. W. RAVENAL, AIKEN, S. C.

I so often derive instruction as well as interest from your "record of facts" in vegetable physiology, and your speculations and conclusions are so generally apt and appropriate, that when I read your article in April number of *Gardener's Monthly*, "About Cabbages," I hesitated about expressing dissent from your conclusions. You say "the only reason why a Cabbage heads, is because the natural growing season of the plant has

been delayed by man several months after seed ripening." I think the "heading" of Cabbage and Lettuce is to be explained otherwise, and that the delayed time of seed sowing is only an auxiliary in affording to the plant the best season of the year for developing its powers.

In your latitude, the seed sowing is delayed some months after seed ripening, to get the best season. Here in our latitude, we sow (or ought to do so) our green glazed Cabbage in May or June, just after the maturing of seed of previous crop. They grow all summer and head in fall and winter. About February or March they run to seed, and then ripen towards the end of spring. So there is no delay (or need not be) in sowing after maturity. This fact would seem to destroy your conclusion as stated above.

The true reason "why and how a Cabbage heads" is, I think as follows: All plants have an aptitude and inherent capacity for storing up supplies of plant food for future use. Among the annuals the growth is so rapid, that this tendency is not so perceptible. The biennials and perennials show it in various ways; sometimes it is in the thickened root, sometimes in the rhizoma, the bulb or the tuber, but oftenest in the buds. Preparation being thus made for the future, there is a period of rest, more or less extended; then follows a rapid growth,—inflorescence, maturing of the seed and exhaustion. Among the perennial and woody plants, this is done towards autumn in the form of buds, and it is here I find the explanation of the Cabbage heading process.

A bud, as it stands in winter on the tree, with its compact folds of leaves and shortened axis, is only a small "head;" and a Cabbage head is only a large "bud" with compact leaves and shortened axis, resting for a period, and accumulating starch and other plant food for the supply of the flowering process and ripening of seeds.

It is perhaps a universal law in all vegetation which is prolonged for any time, that the collecting and storing up of plant food takes place preparatory to the exhaustive process of maturing seeds. The Turnip, Beet, &c, store theirs in the root; the Cauliflower in the flower stems; some do it in the thickened leaves, but the most common mode is by buds.

The Cabbage, after growing for a certain period, begins to form its "bud," and as in other cases, there is a shortening of the axis of growth so as to compress into the bud the embryo of the

future inflorescence. Starchy matter accumulates and other peculiar compounds are elaborated, the leaves become blanched by exclusion from light, and it becomes a hard, solid bud. After a certain period of rest, a new growth commences, the axis elongates rapidly, inflorescence takes place, and as the process goes on the leaves become green from exposure to light, and finally flaccid and exhausted. The same process takes place in spring-time, in the bursting of every bud, and the rapid growth and elongation of the axis. The "bud" and the "head" are the same process taking place under different conditions of growth.

[Mr. R. is right in his view of the Cabbage head being simply a terminal bud. He has made the matter much clearer than we did in the article referred to, and we are much indebted to him for the paper. But it is after all the season, or other circumstances not well known, which is the auxiliary in the formation of this bud. For instance, in the European Ash, *Fraxinus excelsior*, there is a strong terminal bud, with four well formed scales over it usually,—but if the ash makes a second growth in the season, as it often does, the bud is naked, and has no scales, only minute specks, which develop the next growing season into true leaves. So that the element of time enters into the case, as we suggested.—ED.]

#### SOLANUM CILIATUM.

BY MR. W. G. CLARK, CLEVELAND, OHIO.

I have a plant of the *Solanum ciliatum* raised two years ago from seed, which I believe came from Peter Henderson, which I have bedded out in the summer and taken up and potted and kept in my window through the past two winters. The repotting of course checks it, so that it has to be cut back to get new growth; but I am under the impression that if kept in a pot it would continue to bloom and bear fruit. During the summer it has fruit and flowers at the same time, and all the time until checked by repotting. A valuable feature of the plant is the durability of the fruit, making it very desirable for parlor and Christmas decoration. Scattered among evergreen branches it has a brilliant effect. I have branches on my mantel now with fruit but little shrivelled, which were out in November. To make a handsome bushy plant, the ends of the branches should be pinched occasionally.

## NOTES FROM MEADVILLE, PA.

BY MR. A HUIDEKOPER.

It is too early to speak of fruit prospects in this region, but the winter has been a favorable one, the thermometer falling a degree or two below zero twice during the season. Pear and peach trees are making a fine show of flower buds, and fruit will be abundant if not cut off by frost.

Mr. Saunder's article on pruning, in the March number of the *Gardener's Monthly*, will commend itself to many fruit growers. While some regard should be paid to balance and symmetry of form, too free an application of the knife produces more sprouts than fruit.

We are gradually outgrowing some theoretical errors. A few years ago it was thought the life time of a dwarf pear was about 20 years, whereas it takes about that time to get some varieties into their best condition, and there is no reason for supposing they will not thrive much longer. I compromise between the theories of "sod" and "clean culture" by inverting the sod for a circle of three or four feet around each tree in the fall, and mulching on this for the winter. The mulch is removed in the spring, and before the hot-weather of midsummer a new turf has formed around the tree, keeping the roots cool but not dense enough to interfere with the trees' growth. In this way dwarfs make a satisfactory annual development and keep healthy, growing almost as fast as they do in the garden. Mr. Satterthwait's "Address" is just such an article as one of your readers at least likes to see in the *Gardener's Monthly*. Novelties in the way of fruit are so apt to be overpraised, that one likes to have the best result of experience.

I am building a new grapery, with inch sash bars five inches deep (and stiffened with two rods the length of the building tacked on at equal distance below) between each row of glass. What I hope to obtain by this, the building standing north and south, is a full measure of solar light in the morning and evening, and some modification of heat by the deep sash bars intercepting a portion of the sun's rays at noon. If I find it works well, I will report hereafter. By-the-by, we are often told of the great amount of heat grapes will bear, but seldom of the degree of cold. Several times when the thermometer in a cold grapery has indicated at least four

degrees below freezing, I have noticed no injury whatever to the just opened buds.

## BOILERS AND CIRCULATION.

BY MR. A. L. PENNOCK, PHILADA.

In the April number of the *Monthly*, from Mr. John Ellis we have a new theory, that expansion is the motive power of the circulation of hot-water. He says the first particle of water that moves, is the particle that has absorbed heat and expanded, which is correct. He then says the following particles come under the same natural law, which is correct also; but he does not explain how the following particles come there to be acted upon under the same natural law. Expansion of the first particle could not make room for them; but if the only force of operating, and he acknowledges no other, would crowd them back, instead of allowing them to enter the boiler. In support of his theory, he says in substance, that in order to heat a glass structure the water in the return pipe should be nearly as hot as when it left the boiler in the flow, and if it returns cold, little heat is given out. In other words, in the first case, the water leaves the boiler in the flow boiling at  $212^{\circ}$ , and returns at  $200^{\circ}$ ; in the second case, it leaves boiling at  $212^{\circ}$ , and returns cold, say  $80^{\circ}$ . In the first, according to Mr. Ellis, it heats the air in the glass structure, although it has given out but twelve degrees of its heat, while in the second case, a year's firing would not heat the same air, although one hundred and thirty-two degrees of the water's heat were being continually given out. He says his experience is, the hotter the water in the return pipe, the more rapid the circulation, but he does not tell us how he judges of the rapidity of circulation. If the water in the first case circulates eleven times as fast as the second case, it will give out as much heat to the air, but not otherwise. I suppose if the water in the return pipe could be the same heat as the flow, there would be no circulation; and my experience is, when it approaches that point something is wrong in the circulation. I have never made any accurate experiments to ascertain the velocity of circulating water, but on one occasion I tried the circulation of water in a propagating tank, with sufficient accuracy to show that cold water in the return pipe causes quicker circulation than hot. The fire had gone out, but was renewed when I first tried the temperature, which with subsequent trials are here given.



Flow	Return	
88° & 96°	53°	No circulation in the tank, water circulating both ways in flow.
98	54	Circulation very slow.
106	54	“ more perceptible.
112	56	“ faster.
120	58	“ faster.
122	61	“ no change.
120	64	“ slower.

At this point I made another opening over the water in the tank, allowing a chip to float through.

122	66	2½ min.	chip floating through.
122	66	2¼	“ “ “
126	66	2	“ “ “
126	70	2	“ “ “
120	70	3	“ “ “
122	72	4½	“ “ “
114	75	12	“ “ “

The true theory is, that the first expanded particles are moved, so far as circulation is concerned, by the heavier cold water particles sinking to the bottom and displacing them, and circulation is effected by no other cause.

### HOT-WATER BOILERS.—NO. 3.

BY MR. JOHN ELLIS, WEST PLAINS, N. Y.

It seems as though many persons, when they have purchased what is termed a good boiler, think that is all they need. It would seem also from the manner in which they express themselves, that boilers are expected to do a vast amount of heating with a very small amount of coal, and that if they should put their hand over the top of the chimney and find heat escaping, they exclaim, oh, what an enormous loss of heat! This may be so, or it may not be so, but those who suppose that it is possible for any form of boiler to absorb *all* the heat generated or given off from a burning body of coals or any other material are very much in error. Such results are not manifest in the constitution of nature. What enormous fat oxen we should see did they but appropriate the whole total of hay, water, meal, oil cake, and all the various compounds that go into their stomachs without any loss; but we all know that this is not so, and the facts are that nothing but the constituents of the grass produce the positive results, let them be what they may. Another person says “I will save this loss of heat by carrying it in a flue through the house,” and when this is done it is found that the *draft*

is impeded and the boiler fails to do what it did before the flue was carried through the house; and the consequence is dissatisfaction with both flue and boiler. The escape of some heat at the top of a chimney cannot be prevented, because the water in a boiler will only absorb so much and no more, and then it is necessary that the chimney should be kept warm, for if it were cold, the rising heat would be condensed, and thereby the draft very much affected. I have used cast iron chimneys and had to discontinue their use, solely on account of the cold in winter acting with greater force on iron than brick, or more correctly speaking through the iron giving off its heat quicker than brick.

That there are many poorly constructed boilers we know from experience, although their makers claim by the mode of their construction to have placed a surprising number of square feet of iron surface containing water in immediate connection with the fire, much of such claimed surface becoming non-effective; not because the radiant rays of heat is not in direct line with such surface, but because the surface in question is not in position to receive the proper force of heat. Let me illustrate what is meant, by a man standing out at night in the external atmosphere without a wind, and the thermometer standing at zero; and on another occasion he shall stand out with the thermometer indicating the same low temperature, but the north wind driving with powerful force; in both instances the thermometer indicates no more cold, but the man, what does he think? why that the thermometer ought to indicate *double zero*. Now what is this that has produced such powerful sensations and so intensified the cold; the force or pressure of the wind. Hence we have boiler makers who construct according to the scientific theory of Hood and others, and woefully fail in the results aimed at, because they never take into consideration the pressure or force of heat. Hood and his contemporaries have said nothing about it, and consequently we never heard any boiler maker speak in reference to it; but still they wonder why their boilers presenting the requisite square feet to the action of the fire do not heat as many feet of pipe as the scientific authority has laid down as a rule should be heated. The man in the wind cannot understand how it is so much colder when the thermometer indicates the same temperature in both cases.

Let us look a moment at an ordinary con-

structed horizontal boiler with a good draft, here we see the lines of radiant heat drawn down to a horizontal line, and forced by the pressure of the draft out at the end of the boiler to come against some crook or bend in the brickwork, and then made to pass along the boiler's sides or some such position before the heat reaches the chimney; this much done, and there is a wonderful achievement on the most scientific principles. We conclude by calling such arrangements miserable botches.

In such cases as this cited, it will be seen that the *force* of heat is thrown against some portion of the brickwork in order to turn the heat around the outsides of the boiler, where it could never do any good were it made to travel round it a million times over. My readers may think this a strange manifestation of scientific principles, but wait a wee while, and let us see. You will recollect that the *force* of heat is thrown against the brickwork in order to turn it round the sides, that *force* is lost there; and when once round the sides of the boiler in form of flue heating, this heat becomes a *secondary* heat, that is, heat having less intensity than that which is given from the fire resting on the grate surface. Now we must bear in mind that of the water in a boiler, that portion of it that is placed immediately over the fire remains there until it has absorbed all the heat from the iron surface that is possible it can absorb, and consequently the hottest water in a boiler is that surrounding the top sides. Now if this water has been made the hottest by the agency of the hottest fire, how is it possible to add one more degree of heat to its temperature by placing a *secondary* heat in connection with it? I contend it cannot be done. All flue arrangements are worthless, otherwise than in protecting boilers from the action of external air, and forms of boilers, whether horizontal or conical, should be cased in with brick, or there will be a great deal of heat lost. A boiler standing exposed to cold icy air, may just as well be standing in icy-water. When it is stated that such and such boilers require no brickwork in setting them up, as everything is iron, remember that if no bricks are used, you have to pay for it in coal and time in getting up the heat.

One great objection to the majority of boilers, is their incapacity to hold coal enough during the night, and when we speak of this, the question is instantly asked,—“do you want the boiler to hold a *cart-load* of coals?” I reply *yes*, if it is necessary; for if it is necessary

to burn a cart-load at night, is it not much better to do it at one operation, than to have a man standing the greater portion of the night by the boiler shoveling in coal at intervals and in small quantities? I should feel most secure under the cart-load principle, at the same time giving some thought to health and comfort. It is a mistaken notion in supposing that small grate surfaces or small fires are economical; my experience is quite the reverse, for they have, most of the time to be on full draft, and constant stirring and breaking up the coals, causing the combustion of coals to be rapid, imperfect and wasteful. Another point regarding coals is the size used. It is customary to use large coals, known by the name of broken, as when once hot it will throw off an immense heat. This is comparatively true, but does it effect what may be supposed it does? Not by a very great deal, for unless large coals are in a very large body, a large volume of air is constantly passing between the lumps and carries the heat away as well as lessening its temperature, and often we shall find such fires burnt out, or rather gone out, and the grate left nearly full of large cinders or coke. There are many boilers that would heat more feet of pipe than they do at present if a small sized coal were used, and it would keep a fire for a much greater length of time, as well as its effect on the water be more powerful, all owing to a better combustion. In stating what has, it is our experience after using large coals for a number of years, and in some fourteen or fifteen boilers of different makes, and I must say, that this much of experience came to me against my inclination, and in this way: I had ordered large coals, and when the delivery came, came egg; this is no good for our boilers, we exclaimed! “Well this is all we can do now.” Compelled to burn it, as it were, by accident, we could scarcely believe our own senses at the difference in the results. I have never used large coal since. Now I do not wish your readers to run into extremes through what I have suggested by getting coals so small that will lie so compact that the air cannot get through them, but think a little and try, as well.

There is no system of heating, to my mind, so efficient, so equal, that can be depended on, as well as healthful to vegetable and animal, as that from heated water, not that there is any difference in caloric, for the latter is the same, whether from a hot air chamber or steam pipes; but there is a life depending difference on the amount of heat radiated or thrown off to the

square foot by these different modes employed ; one healthful to man as well as vegetables ; and the others vitiating every vitalized property of the pure air sent for our existence. The beauty and perfection of hot-water, I say, lies in the *low-ness* of the temperature given from the pipes, and the perfection of a heated structure even if it be required at 100° should be dependent on the amount of iron surface radiating a low temperature, than half the amount of surface giving off double the heat. How much we lose in our attempted culture of plants and fruits through not giving this subject its due consideration. How many abortions in our undertakings may we truthfully trace back to our artificial creation of that great principle of light—heat—and then again see what is the result of our imperfectly understanding the subject,—mildew, spider, mealy bug, and oftentimes things belonging to the animal world that seem to have none of man's excellent classification. We always make our mind that we are wrong somewhere when we get results not wanted nor expected. But here I find my pen getting into that funny subject, horticulture, which I did not intend to speak of.

Hot-water heating, beautiful as it is in its application to horticulture, is very expensive, we must confess, and nearly worthless when needed no longer. This fact arises from the manner the pipes are put together, who all know who have recourse to their use ; and few we think have felt the annoyance more than I have, so I came to the conclusion that it was possible to make a *portable* pipe that could be put up or taken down by an ordinary laborer. This much I have done, and can now put any length together and make tight without using either screws or bolts, or cement or caulking, in a very little more time than it takes to place the pipes in their positions. Shortly I will send you a drawing of this portable pipe, with explanations for the benefit of your readers interested in hot-water. The cost of the pipes will be no more than the current value of the present mode of making, and will be found very convenient, for they can be removed from one house to another when required, and additions made to suit necessities, without having to send (as is often the case) a great many miles for an *original mechanic*.

[We shall be very glad to have the drawing referred to. We do not know a more important question at present in gardening than this one

of boilers, and hot-water generally, and do not regret the occupation of any amount of space that it occupies or may yet require.—Ed.]

### PEARS.

BY E. P. POWELL, ADRIAN, MICH.

I thought, when reading Mr. Satterthwait's review of Pears, that taking his list as a basis, reports might be sent in from all parts of the country giving supplemental information, so that we might have a really valuable standard of judgment. My own experience in Michigan, would in reference to many varieties, be quite unlike that of Mr. S. I would add to *Madeleine* that the tree is the first of all to feel blight, is exceedingly brittle, and the fruit sometimes excellent, but more often flavorless.

*Tyson* is with me not a poor bearer, but in alternate years very fruitful, and in quality, as he says, "best."

*Flemish Beauty*, as I grow it, does not rot quickly, but is an excellent keeper ; its growth surpasses *all* others ; its productiveness unsurpassed, and it is with *Seckel*, *Lawrence*, and a few, most hardy. With me there is never any premature shedding of leaves from any variety, certainly not *Flemish Beauty*.

*Onondaga* does not rot, but keeps admirably ; some years it is nearly first-rate, then for two or three seasons it is simply unendurable.

*White Doyenne* only seldom cracks.

*Seckel* has no tendency to early decay, but just the contrary.

*Buffum* is a remarkable keeper, but does not show well nor sell well ; trees unsurpassed for symmetry and color.

*Sheldon* never cracks with me, but is every way superb, only not prolific.

*Beurre Clairgeau*, not of "poor quality," but extra fine ; handsome in the highest sense ; and Mr. Quinn is not the only one who pets it.

*Winter Nelis* does not like my style of culture, that is in sod with careful mulching ; the fruit is scarce, and poor, and small.

Otherwise than as noted, my experience tallies with that of Mr. S's., so far as we cultivate the same varieties. I would add a good word for

*Beurre d'Arenberg* as an unusually good winter pear, a good bearer and of fine quality, and an admirable keeper, ripening well in February and March. I would not ask for anything more toothsome in late winter.

## EDITORIAL NOTES.

## DOMESTIC.

*Layering of Grape Vines.*—It is not generally known that when a plant is layered, the main plant is injured. But it is so. We are reminded of this by some excellent observations on the grape vine, in a catalogue of grapes and fruits issued by Mr. A. M. Burns of Manhattan, Kansas, who is probably the most western grape grower this side of Utah.

*Protection against Swindlers.*—It is a curious commentary on these organizations, that in one especially designed we are told to guard the agriculturists against "humbugs," the name of one of the most notorious rascals in the community appears as a leading officer.

*Figs for Profit.*—The *Rural Carolinian* believes Figs may be grown for drying, so well as to compete profitably with the foreign fruit.

The *Christine (Telegraph) Grape* is praised by some correspondents of Western papers, for being quite ripe when the Hartford is yet sour.

*Martha Grape*—John H. Heyser writes from Hagerstown, Md., that with him Martha proves the best white grape in that region.

*Arnold's Hybrid Grape.*—Mr. John H. Heyser writes to the *Grape Culturist*, that Cornucopia and Canada ripened last season at Hagerstown, Md., together with Adirondac, Rebecca and Ives.

*Grape Tendril Pickles.*—The tendrils of the grape vine make a very pleasant pickle, so says an exchange. This is a good thing, as the taking off of the tendril is good for the vines.

*Formation of Bark.*—In the earlier numbers of the *Gardener's Monthly* there were many instances given of trees making a new bark, when thoroughly divested in June of their old one down to the wood. By our Western exchanges we note that Mr. D. B. Wier has been making similar observations recently.

*Sequoia gigantea.*—The mammoth tree of California does not do well in the Eastern States. Some few still continue to do so; perhaps the best is on the grounds of Ellwanger & Barry, Rochester, N. Y.

*Georgia Blackberries.*—Mr. Van Buren writes to the *Country Gentleman*, that the Blackberry is one of the greatest pests the planter has to contend with in Georgia. He intimates that they bear fruit as large as the Lawtons, and says they can be bought at Clarksville for about \$1 per bushel.

*Peach Soil.*—A Maryland correspondent of

*Country Gentleman* says no one will plant peaches in that section in heavy ground. Light soil is always sought for by the experienced.

*Buckthorn Hedges.*—A Canadian paper says Buckthorn is the only plant that will make a really good fence in the northern part of America.

*Festuca gracillima* is a grass recently discovered in California by Dr. Bolander, and believed by him to be identical with one found in the Straits of Magellan. This makes one hundred and forty species of grasses he has discovered on the eastern coast since 1861.

*The Sparto Grass.*—Immense quantities of this grass is imported into the United States by American paper makers. There has been confusion in regard to what plant this comes from. Some regard it as *Juncus tenacissimus*; but it seems to come from *Macrochloa tenacissima* or *Lygeum spartum*; perhaps from both.

*Wood in Kansas* is tolerably abundant. Every stream bank is well supplied, and it can be bought by the cord for from three to four dollars.

*Western Michigan as a Fruit Region*, promises to be equal to Delaware. A correspondent of a western paper says:

I came here ten years ago last Spring, from Iowa, for no other purpose than that of growing fruit. I selected a splendid piece of land near Troy village, and set out seven hundred apple trees of choice Winter varieties, one thousand peach trees, and one hundred pear trees; also cherries, blackberries and strawberries. I raised 600 boxes of peaches this year, 100 barrels Wine apples, 500 barrels of Baldwins, seventy-five Russets; Wageners, 105; King of Tompkins County, eighty; Rhode Island Greenings, 100; Seek-no-further, twenty-five. The apple trees have been set out eight years. I am raising apple and peach trees, and will set out a thousand additional trees in two years.

*Water in Trees.*—Just before the leaves push, there is more moisture in wood than at any other season, because the roots continue absorbing all winter, while there is little evaporation. At this period *one-half* the weight of wood is water. As soon as the leaves are fully expanded, the moisture diminishes about 5 per cent.

*Hale's Early Peach.*—A correspondent of *Colman's Rural World* says a neighbor has an orchard of Hale's Early, half of which were in oats, and the other well cultivated in potatoes. There was no other difference. Those in the oat lot bore well; the others all rotted.

*Fruit in Iowa City.*—L. Kauffman commenced planting in 1855; his trees have all borne some fruit, and he finds that in that time he had as many bushels of pears as of apples; but while the apples brought \$1 to \$1 50 per bushel, the pears sold from 3 to 5 dollars.

*Salterthwait's Pear Orchard* near Jenkintown, Pa., bore a tremendous crop last year. A reporter of a city paper asking him the secret, he replied "thorough cultivation and bountiful manuring." It should be remarked that Mr. S.'s idea of thorough cultivation is the continual stirring of the soil.

*Grape Vines Growing over Tree Trellises.*—The paper we published last summer on this subject, has had a pretty liberal run through our exchanges. We are never so wedded to our own opinions as to suppose those of others are not sometimes better. We therefore give the objections of Mr. Geo. Husmann from the *Grape Culturist*. Few persons are better qualified to give an opinion about the grape than Mr. Husmann. We should perhaps value the opinion more, if we felt sure that he had read our article attentively; but when he talks about "letting vines scramble at will over trees," while we were recommending trimming the trees into trellises, and then carefully training the vines "according to a system," it would seem as if there were something wrong in Mr. Husmann's reading of the paper. However, this is what he says:

In copying the above from the *Gardener's Monthly*, we could not but think that the vivid imagination of our friend Meehan had run away with him, and that his love for trees, and all that is beautiful in nature, had blinded his eyes to what is useful and practical. No one, certainly, who has planted a vineyard along a forest, where the vines were shaded by the trees,

or the sun's rays reflected from a belt of timber on the vines, can have failed to see that the two will not agree.

We love trees as well as friend Meehan, in their proper places, but think they are decidedly "out of place" in a vineyard. We have seen peach and apple trees planted in vineyards, at the same time with the grapes, but they invariably killed the vines around them, as far as their shade extended. The owners of such vineyards had either to dig up the trees or the vines, and make one or the other of it—orchard or vineyard.

The isolated cases friend Meehan quotes, will do as little to prove the point, as one swallow will make a summer. The vines as well as the trees may have been planted in a very rich spot, or may have been heavily manured. He quotes the Italian vineyards as an illustration. Let us ask him in all friendship where is the reputation of Italian wines, compared with those of France and Germany? Except a few isolated brands, they are unheard of in trade or imports, while the wines of the former are known and estimated throughout the civilized world. We all know that even where vineyards are planted too closely, the product is not so good nor the vine so healthy; how much more so, then, when the poor vines must "scrape up a living" under the shade, and among the roots of trees.

This may be all very fine and poetic on paper, but it will hardly work in practical life. Nor will it do to say that it will require more work, and therefore is not practical. Just because it is easier to let the vines scramble at will over trees, do the Italians follow it; for if it required additional labor, they would certainly abhor it, being one of the most indolent nations upon the earth.

## EDITORIAL.

### FLOWERS.

In former numbers we have devoted considerable space to fruit culture, and in our last number, flowers retaliated as "coals of fire" on our heads. But we doubt whether any punishment would be more bearable than the beautiful essay of Mr. Davis, which appeared amongst the

others. The youth talks of the chains of love, yet willingly endures his slavery; and we doubt not but those who missed the accustomed feast of fruit articles, were as well satisfied after reading this charming address.

Mr. Davis is minister of one of the branches of the Lutheran denomination at Chambersburg.

and we need scarcely tell those who follow him through, a gentleman of eminent mental power and attainments.

There is a peculiar interest in the study of the ancient history of flowers. Of course a large amount of it is pretty, but not true. The iconoclasts of literature are perpetually tearing down some idols which we love to worship. We see some of these venerated points in Mr. Davis's address. It is wonderful how such ideas come to prevail. We remember well with what force a passage in a great writer struck us in our younger days, that "if the Quakers had any hand in the creation, not a bird would be allowed to sing, or a flower be allowed to bloom." As we came to know these people better, we found none loved flowers more, and recently we learned that George Fox, the great Quaker patriarch, actually left in his will a tract of land in the city of Philadelphia for the purpose of founding a botanical garden. On account of some legal technicalities the will was broken, and the property diverted to other uses; but the mind of the great founder of the Society of Friends is photographed in the bequest, and is a strange commentary on the above idea of the Quakers as well as what we often hear of as the truths of history. So we doubt many of the facts given in Mr. Davis's epitome of the ancient history of flowers; but they are history, and as such quite germane to his text.

It is well for those who are enthusiasts to paint the objects of their adoration in the most inviting colors. But yet this often does injury, and in the midst of so much that is apocryphal, it is gratifying to note how truly some of the real facts are presented in the essay before us. How often have we not seen it stated, that no one who loves flowers is really depraved. This is a standing assertion with a certain class of writers. Every cut flower dealer in any populous town, knows that this is not true; and it is one of the great merits of this essay, that in the midst of so much that is poetical and pure, the truth is so pleasantly, yet so plainly told.

The true history of flowers we fear would show, alas! that it is not the very good people who love them. Some, many indeed there may be, but the great mass is lost to us. Amongst good men especially there is a great disposition to look on the culture of flowers as an occupation fit only for women or children. True, this feeling is fast wearing away; but not as rapidly as we would like to see it. Mr. Davis's address will

do much to hasten the good time

We hope that after our readers have read it, they will hand it to some of their friends who are not among our subscribers, so that the good seed may be sown as widely as possible.

#### THE CODLING MOTH.

We publish to day an essay by Mr. Brown, on the Codling Moth, to which we invite the earnest attention of all our readers. It is impossible to estimate the value of this paper; and we know if well weighed, it will be of immense benefit to the fruit interests in the United States. We regret that it should be marred by a reflection on the motives of Mr. Riley. We deprecate all such manner of argument in discussions of this kind. If Mr. Riley chose to give it to the world as his opinion, that straw bands are better than woolen traps, *demonstrate*, if you like, that this is an error; but a man's motives are his own. These may be good or they may be bad. It is unfortunate when they are the latter; but as they cannot be demonstrated, we should leave them alone. As far as Mr. Riley is concerned, he is too good a scientist not to know that "the truth will surely find him out;" and he would be loth to risk his reputation on a motive not of the purest character.

#### DENDROBIUM NOBILE.

(See Frontispiece.)

We give to day, as an illustration, an engraving of a plant, the superior growth of which is always a leading aim with first-rate gardeners. One recently exhibited at the rooms of Pennsylvania Horticultural Society, had over five hundred blossoms on it. This was grown by Mr. Newett, gardener to H. Pratt McKean, Esq., of Philadelphia, and the specimen used in our drawing was taken from this plant. This plant,—*Dendrobium nobile*—we may say for the information of those not well learned in the higher branches of horticulture, belongs to the orchid or air plant family. This species is a native of the East Indies; but orchids are found in all regions from the arctics to the equator. There is, however, a great difference in their habits in different temperatures; for though in the tropics they are mostly "air" plants, as we get further north the number of those which live in the earth greatly increase. Those which grow on trees or stumps are called *Epiphytal* orchids, and those are *terrestrial* which live in the ground. Those which live on trees, simply attach them-

selves by long worm-like roots, and probably derive but little support from the dead matter among which the roots run. They live chiefly on the air and moisture of which this half dead matter about old bark affords a pretty regular supply. The Epiphytal orchidæa do not extend far into the United States. There are two found in Florida, *Epidendrum conopseum* and *E. venustum*; but neither of these are anything like as handsome as the one we give in the plate. In our northern States the handsomest orchids are the Mocassin flowers, (*Cypripedium*) but these are becoming very scarce. Indeed orchids are seldom very plenty anywhere, as the flower is so constructed that it cannot fertilize itself, but is dependent wholly on external aid. It is to Mr. Charles Darwin we owe this knowledge. His work "on the fertilization of orchids" will probably be one by which he will be remembered longest. It completely reversed old opinions. It was thought most plants had arrangements especially adapted to self-fertilization. Writers on the *Fuchsia*, for instance, were sure to tell us that the flower was made pendulous especially that the pollen might easily drop on the stigma; but now it is universally conceded that plants in general avoid self-fertilization, and in some cases, as this of orchidæa, it is impossible to be fertilized at all without insect aid, which carries the pollen from one flower to another. Mr. Darwin's theory of the "origin of species" may not ultimately be accepted, but this on the fertilization of orchids will always mark a great historic phase in botany and horticulture.

Orchids are peculiarly interesting to the plant cultivator, from the fact that almost all of them are delightfully fragrant; while most of them have particularly handsome flowers. These

flowers seem to delight in simulating the forms of the insects which aid in fertilizing them. Some are like bees, others moths and butterflies, and some like birds. The Dove plant of Panama is so called from the resemblance of the flower to this bird; and "Flower of the Holy Ghost" follows from this in the natural habit of Spanish America to associate such resemblances with their spiritual ideas.

Their peculiar service in the economy of nature from a human standpoint is not clear. With the exception of the *Vanilla Bean*, which is the seed vessel of an orchid, called *Vanilla planifolia*, they are of no immediate service to the wants of mankind, as we usually understand them; but if we believe that human wants are not limited to food and medicine and raiment, but that the mind was destined to crave for the lovely and the beautiful, as the "hart panteth after the living waters," surely these wonderful flowers are amongst the choicest necessities of life.

As for their cultivation, it is not near as difficult as it was once supposed to be; though to be sure if one wishes to excel in their culture, the highest skill is requisite. Thousands, for instance, could grow the *Dendrobium nobile* we have figured; but not one in ten thousand could grow it as a Newett or a Taplin has done.

In former times the orchid house was a very expensive affair. A thousand dollars was but a drop in the bucket. Hot-water, tanks, peculiarly constructed glass, and we know not what were thought to be essentials. In such places orchids were "coddled;" but now it is enough to hang them from the rafter of any well constructed greenhouse; and if the plants in winter do not get a temperature lower than fifty-five, they will for the most part grow and do well.

## SCRAPS AND QUERIES.

ROOTS AND WATER.—*R. S.*, *New Haven, Conn.*, says:—"I observed recently a quotation in some paper from the *Gardener's Monthly* that it was not water, but watery vapor which plants absorbed from the soil, and that water in soil was an evil, and would kill the roots. If this is correctly your views, how does this tally with

the observations of other scientific men? Prof. Dana, one of the Editors of *Silliman's Journal*, believes the contrary. I have his assertion that trees grow in swamps, some kind or another, all over the world. I have myself seen willow trees growing along streams, and also grape vines, if not many other trees, which had their roots

completely under water,—and they seemed to go to the water in preference, as they were frequently found in immense masses. I hope you will not think I am criticising your views; but your admirable journal so encourages one to think about these things, that I should really like to know how your views and Prof. Dana's can be so different."

[We do not know exactly what Prof. Dana's views are. Possibly they may not be quite as our correspondent understands them, for every observer knows that trees grow in swamps all over the world. But the roots of these trees are by no means *all* under water. Along under the moss, and grass, and weeds, and *above the surface* of the water, our correspondent will find myriads of rootlets. So in regard to his own illustration of mats of roots going to water. It is only *some* of the roots. Let him try the experiment of growing a willow wholly in water, and he will find that it will not live a year. Any one who travels through Indiana, may often see scores of acres of trees which grew for many years "in swamps," entirely killed by having a few feet of water turned on them either by a new railroad embankment, or by an unusual overflow of some kind. The writer remembers seeing a striking instance of this kind once, a few miles out from Marquette, on Lake Superior. It is therefore not true that a plant will live long with *all* its roots under water; at the same time it is a very interesting fact, as our correspondent suggests, that some rootlets seem to prefer to get under water if they can.

The true state of the case is, that there is an immense amount of knowledge yet to be developed from a study of roots, and it is a very inviting field for those who are fond of original researches.]

FLOWERING OF DARLINGTONIA.—Last month a correspondent enquired whether this was yet in cultivation. Since our last reply, we have seen a note in reference to it in the Bulletin of the *Torrey Botanical Club*, from the pen of Dr. Torrey, in which he speaks of examining some flowers which were produced in New York; but these were from plants recently brought from California.

BRANCHED TRUSSES IN GERANIUMS.—V., *Vicksburg, Miss.*, writes:—"I enclose you a flower-stalk of a Geranium, a seedling raised by me

more than nine years ago. It is a seedling of the "Queen of Summer," and resembles the parent somewhat in foliage, which is a rich light green on the edges of the leaf, shaded to almost entire white in the centre; but the growth and habit of the plant are entirely different. This plant is disposed to be bushy; the body of it frequently entirely white, striped with green. The flower stalks almost invariably green. This constitutes one great beauty of the plant. Another beauty and peculiarity is, that after the first cluster of flowers is past its best, but not yet out of bloom, out of the cluster of flowers there springs one or two small green leaves, and another flower stalk, in a day or two another and frequently a third; these bloom quite as finely as the first, giving the plant a very unique appearance. After testing it two years, and finding this to be the regular habit of the plant, I gave a plant of it to Mr. Charles Allen, formerly a florist of this place, who propagated and sold it under the name of "Madam Balfour." I have always called it "Louise."

This may be nothing new to you, but I have never seen the same thing in any other Geranium. Please let me know what you think of it in your answers to correspondents.'

[This Geranium has taken on something of the thyrsoïd character of allied species, and which is seldom seen in this one. It is, however, occasional,—and only occasional. If, as our correspondent says, he has one which has the flower stems almost always branching as this flower stem sent us does, it will be a valuable variety well worth disseminating.]

HEATING RAILROAD CARS BY HOT-WATER.—*J. G., Ypsilanti, Mich.*, kindly sends us the following note: "In reply to B. D.'s query, page 122 of the April *Monthly*, would say that the cars of the Michigan Southern Railroad are heated by hot water. The apparatus (made I think in Chicago) consists of an ordinary cylindrical stove, jacketed by a galvanized iron boiler. It works very well."

CIRCULATION OF HOT-WATER.—*Correction*.—Mr. Editor, please correct the quotation given in the May number of the *Gardener's Monthly*. I wrote "that water attains its maximum density at thirty-nine degrees, F., and sinks at thirty-two degrees. It is *seven degrees colder*, yet



remains on the surface and forms ice. In this state of affairs, is Pat Murphy standing on his head?"

Galena,

E. H. B.

**SOUR AND SWEET APPLES.**—*M., Rochester, N. Y.*—Sour and sweet apples, that is apples having both these peculiarities in the same fruit, have been known for at least a couple of hundred of years. We did not mean that Mr. Blodgett's father originated the first sour and sweet apple, but that it is possible from the facts we gave in embryonic inarching, that he originated a sour and sweet apple. The tenor of our remarks was not, however, to show that sour and sweet apples originated this way. We believe that such an apple could originate just as well from seed, and no doubt has done so. Our point was the possibility of varieties originating by inarching of embryos, as well as by seeds.

**FRUIT TREES ON CITY LAWNS**—“*Old Subscriber*” says:—I have my garden in town planted with fruit trees, and want to know if it would injure those trees which are small and young to keep the ground in grass, which would certainly look well, and looks are of some importance in this case. Can I get some advice from some of the contributors to your useful magazine.”

[Some of the best pear trees we know in Philadelphia are in grass. If top-dressed with fertilizing substances occasionally, they will do better in grass than any other way—the grass of course mowed as a lawn should be.]

**FANCY GOURDS**—A correspondent suggests that more attention should be given to fancy gourds for ornamenting grounds. Some beautiful effects can be had from a judicious arrangement of them.

**ORIGIN OF SOUCHETTI RASPBERRY.**—*J. E. M., Philada.*, writes: “Your correspondent L., Cincinnati, is informed that the Souchetti Raspberry was introduced in this country 1850, by Mr. Souchet, (of firm of Aubrey & Souchet) was named after his father, a famous raspberry grower for the Paris (France) Market. He also introduced the Hornet, Pilot, Imperial, and Jouet, and the four first named have probably never been excelled, unless Mr. Herstine's seedlings should prove to be superior. The Jouet

was a yellow fruit, smaller than the “Souchetti,” but not equal to it either in flavor or productiveness.”

**NOTES FROM JACKSONVILLE, FLA.**—*J. W. S.*, writes: “I send by mail, this day, three plants for the want of a better name, we call them the ‘Air Plant.’ They grow on the live oak, generally found in the forks of the limbs; a larger variety takes to the smaller limbs of the oak, and grasp it firmly with a net work of roots. Will you name this for me? I suppose it belongs to the Orchis family, or is it one of the Bromeliaceæ, say *Tillandsia caespitosa*. The plant is not quite so pretty as others, yet its singular habit invests it with some interest.

I will try to get you a yellow Jasmine vine root, one of our earliest spring flowers; very fragrant, with its brilliant yellow bloom, mixed with its deep green leaves, make it very attractive. Unfortunately its flowers do not last long, commencing about middle of February and lasting until end of March, only 4 to 6 weeks.

The *Caladium esculentum* grows in great perfection here. I have a large quantity now growing, the leaves being from 8 to 14 inches broad and 18 inches long.”

[The *Tillandsia* is rightly named. The “Jasmine” is *Gelsemium nitidum*, and is already in northern collections. It is barely hardy in Philadelphia.]

**TRANSPLANTING TREE-BOX.**—“*Old Subscriber*,” *Philada.*, writes: “Can you give me in the *Monthly*, any information about the *Tree-box*. I have some large ones to transplant. I think they bear transplanting well. Which is the best season, spring or autumn? I know they flourish in the shade. Will they bear sunshine? All directions will be very acceptable to your old Subscriber.”

[Tree-box is one of the easiest plants to re-plant. April or October are perhaps the best months; if in the latter month, a good watering to settle the earth well about the little fibres, will be an advantage. They bear sunshine better than shade; but it requires in any case an abundance of rich earth, or it will soon get yellow.]

**L'ILLUSTRATION HORTICOLE.**—*Mr. Such*, says: “Some time ago one of your readers was

asking how he could procure the above named interesting publication. The cheapest and best way is to buy a draft on London, for *one pound sterling*, make draft payable to the order of J. Linden. Enclose in a letter to

J. LINDEN,  
Rue du Chaume,  
GAND,  
Belgique.

telling him it is for subscription to *L'Illustration Horticole*. For this sum it will be sent, *postage pre-paid*, for one year. The letter containing the draft should be *pre-paid*, a ten cent stamp being needed."

WORCESTER CO. (MASS.) HORTICULTURAL SOCIETY.

"Worcester, Mass., May 8th, 1871.

THOMAS MEEHAN, ESQ.,

*Ed. Gardener's Monthly, Philada.*

DEAR SIR:—I have the honor to inform you that you have been elected an honorary member of the Worcester County Horticultural Society.

Very respt'y your obdt. servant,

GEORGE C. FRANCIS,

*Sec. Wor. Co. Hort. Society.*

[It is now twenty-eight years ago since the first honor of this character came to the hand of the writer in the shape of a notice of election as member of the Royal Wernerian Society of England. Since then some scores of such notices of election to societies, agricultural, horticultural and scientific, have been received, which seemingly more of a personal than a public character, have been gratefully accepted, and quietly left to the records of the institutions themselves.

The present one seems owing to the influence of the *Gardener's Monthly*, and it is due that the magazine itself should return thanks. The Worcester County Society, though with a local name, has been established thirty years, and is one of the most useful in the country, and we are proud of our connection with it.]

CALIFORNIAN FLOWER FOR NAME.—*G. L. S., South Framingham, Mass.*, writes: "I take the liberty of sending you the enclosed flower for naming, as I see others do in your column of answers in the *Monthly*. This flower forms one of an umbel of 12 or 15, on the summit of a stalk about 18 inches high. The plant is a bulb, and has flat recumbent leaves of little beauty. It was sent me from California, and was labeled

Dychostoremma. As the flower possesses a good deal of beauty, I am anxious to know something more of it. Should it possess any rarity, and my bulb increases, I shall be happy to send you one of them."

[This is *Brodiaea macrantha*, by some botanists called *Dichelostemma grandiflora*. We should be glad of a bulb, as we never saw the living plant.]

THE YELLOW ASPHODEL.—We are indebted to some unknown friend for this plant, which we have sent to the lady at Washington, Ohio, for whom we requested it. We have also received a "London Pride" from a Boston correspondent.

PEACHES IN VIRGINIA.—A Williamsburg correspondent writes, that in spite of the frosts which have been rambling about, the Peach crop, May 4th, was promising.

FRUIT IN OHIO.—*A Delaware correspondent* says: "The fruit is about all killed here, and I am glad of it. The insects will have no place to lay their eggs."

[Not quite so fast, good friend! The curculio will take to your pumpkins or egg-plants, when the plums and cherries are gone. There is a wonderful adaptation in nature. The peach and plum were no more born to wait on the curculio, than a waiting maid was born with Eve in the Garden of Eden. Servants are nice; but the respected grandmother of all of us got along without one, and so will the curculio when the plums are gone. We hope the curculio hunters won't stop work on this account.]

OUTLINES AND DESCRIPTION OF SEEDLING FRUITS.—*D. E. H., Vacaville, Cal.*, says: "I fully agree with you as to the naming and introducing so many new fruits, no way superior to others of the same season. There are now a thousand too many fruits in cultivation as desirable, which might better be dropped from the lists."

LIBOCEDRUS DECUNENS & THUJA GIGANTEA.—*D. E. H., Vacaville, Cal.*, writes: "I send you a sample of the leaves and seeds of both kinds."

[Thanks for the specimens. No one can fail to see the difference between these two plants.]

## BOOKS, CATALOGUES, &amp; C.

THE PRACTICAL POULTRY KEEPER. By Wm. M. Lewis, New York. Published by D. D. T. Moore. Received through Claxton, Remsen, & Co., Philada.

That we like poultry, we verily hope and believe; and that we desire to see their "culture" extend, we prove in deeds as well as in thoughts and words. Mr. Lewis is no doubt moved to his work by similar feelings; but we do not know that he is more likely to accomplish his desire by reckless statements, than by a clear elucidation of sober truths. He tells us, for instance, that "fowls can be reared with little expense, by nearly every housekeeper, and can be made to pay an *hundred fold* on the investment." If we understand what is meant by "hundred fold"—one hundred for one—this is wild extravagance. In another sentence he tells us that the pleasure can well be imagined, when a person knows that by keeping "a dozen or twenty fowls," he will be "able to supply his table with birds of his own rearing, and his larder with fresh eggs the year round." We imagine the wants of some people's tables the "year round" must be smaller than those of people with whom we have been accustomed to come into contact.

We look through the book to consult the figures as to such wonderful profits and abundance, but find none. The only clue is that Mr. Lewis thinks "every farmer should make a couple of hundred dollars worth of their products yearly;" but by the "hundred fold" process, this will give a capital of two chickens at one dollar each. Surely one might venture on more than this?

Mr. Lewis, however, does not seem so clear, as he proceeds about the profits. He settles down finally on the assertion, that at least he "knows there is no money lost in keeping and rearing a few fowls, and a great deal of pleasure and profit derived from it." Of course, if there is "profit," there is no "money lost;" but in connection with pleasure, we presume mental profit is meant, and this may be some comfort to those who notoriously do lose their *chickens*, if not their money, by the numerous diseases and accidents which fowls are heir to.

Our author seems no less confused when he comes to matters of detail, than when laying down his general principles. In one place he tells us, poultry to be "remunerative, *must* have good management," which is true; but when he says the care of them can be left to wife and children, we

doubt whether "good management" will always follow. The "labor incurred" in the "prices which he receives" can be "performed by the junior members of the family," we suppose meaning that the children can be sent to market with the eggs and poultry; but we imagine this would not be found good in practice, and that marketing would be much better done by juniors pretty well advanced in years.

He claims the credit of having in his book placed the experience of breeders and fanciers in juxtaposition with each other. This would be of value if the views were reconciled when they conflict,—but when one's view is that "fowls can be bred in cities and villages *equally as well* as on the farm," and "it requires but a small space to keep a dozen or twenty fowls," while another is quoted to show that "for every hundred fowls you must give up at least an acre;" we pity the women and children by whose "good management" the "farmer" is to profit in poultry raising.

In regard to the general matter of the book, the main part is occupied with description of varieties, which are better than the cuts, for we suppose a Bantam should be much smaller than a Shanghai, though they appear of the same size here. The chapter on diseases will also interest many readers, leaving out the fact that we think the author imagines chicken troubles yield to remedies much easier than they really do.

WHAT I KNOW ABOUT FARMING. By Horace Greeley, New York. Published by the Tribune Association.

We are indebted to the author for a copy of this book. It runs counter to many views which we hold sound. This is to be expected, however, as Mr. Greeley lays no claim to be a practical agriculturist. He offers it as some common sense thoughts on a subject he loves, and has really done a great deal to serve. We are in no danger of suffering from too much thought, and feel that any one who thinks at all about the subject, will profit by reading Mr. Greeley's book.

INSECTS—NOXIOUS, BENEFICIAL AND OTHERWISE. Being the third annual report of Chas. V. Riley, State Entomologist of Missouri.

While looking over the vast amount of useful

information here gathered together, one cannot help feeling a regret that every State does not follow the example of Missouri, in thus encouraging science. The paper on mimicry, with remarks on natural selection, is worthy of the pen of Darwin, whose views it materially aids.

RHODODENDRONS AND AMERICAN PLANTS. By E. S. Rand, Jr., Boston. Published by Little, Brown, & Co. Through J. B. Lippincott & Co., Philada.

This is a neat little volume of 188 pages, in the style of Mr. Rand's former works. Its object is to bring into better notice a class of plants which are worthy of being better known by cultivators. They have been found somewhat difficult to cultivate in the ordinary way of garden plants. Yet with a little labor easily given, they may be grown to great perfection.

We do not notice anything new in the work—very little in fact with which the readers of the *Gardener's Monthly* are not familiar,—while many things are omitted which might be told to advantage, such for instance as the grafting of

Rhododendrons, the treatment of plants from the woods, &c. The whole practical part concerning propagation is dismissed with six pages, in fact; while over twelve pages are devoted to descriptions, which even as descriptions, are very brief indeed,—about the same in fact as we find in common nursery catalogues. Although we thus feel that the "book of Rhododendrons" is to be written; yet as in all of Mr. Rand's books there is a great amount of useful matter collected together, which gives it much value, and until those who think they can do better, really do it, we shall thank Mr. Rand for his very useful contribution to our floral literature.

AMERICAN HORTICULTURAL ANNUAL, 1870. Orange, Judd & Co. New York.

This we have ever regarded as a model "annual," giving the chief discoveries of the year. It confines itself to new varieties, and implements however, and has little to do with recording new ideas.

## NEW AND RARE PLANTS.

The European journals describe many new plants, the following of which may have an interest to our cultivators:

ACHIMENES (EUCODONIA) NÆGELIODES DIAMANTINA.—A charming stove perennial, the large cordate ovate leaves of which are hairy, and the Gloxinia-like flowers of a pleasing rosy-purple color marked down the lower side of the tube with a yellow band. A garden hybrid, raised in M. Van Houtte's nursery.

ALTERNANTHERA AMABILIS TRICOLOR.—This genus of Amaranthaceous herbs has become highly popular for carpet bedding, and we have in the present plant an addition which promises to be an acquisition for that purpose. It is dwarf, but erect and much branched in habit, and is clothed with broadly ovate, glabrous leaves, which are dark green at the edge, and have a centre of vivid rose, traversed by purple veins, an irregular band of orange-yellow intervening between the centre and margin. It has been introduced to the establishment of M. Linden, from Brazil.

CALLIPSYCHE AURANTIACA.—An Amaryllidaceous bulb, requiring a warm greenhouse. It throws up a few oblong-acute, bright green, conspicuously-veined, stalked leaves, 6 inches long, and an erect scape, which is nearly 2 feet high, and bears an umbel of several spreading, deep golden yellow flowers, which are much flattened sideways, and have green stamens, which are more than twice the length of the perianth. It was obtained by Mr. Wilson Saunders from M. Linden, who received it from South America, but the exact locality does not appear to have been stated.

CALLIPSYCHE MIRABILIS.—A most remarkable Amaryllid from Peru. It is a warm greenhouse bulb, and produces about two oblong spatulate green leaves, a foot long, and a scape 3 feet high, bearing an umbelate head of about 30 small pale greenish yellow flowers, with stamens three times as long as the perianth, and spreading out on all sides, so that the general contour of the flower head may be compared to that of an expanded parasol. This very pecu-

liar plant—more curious than beautiful, was also received by Mr. Saunders from M. Linden.

**DEUTZIA CRENATA ALBO PLENA.**—A fine dwarf, hardy, deciduous shrub, which, like its allies, is valuable for forcing. It resembles the ordinary double *Deutzia crenata*, but the flowers instead of being pinkish are pure white, both in the bud state and when expanded. The same plant appears to have also received the name of *candidissima*. It is a Continental garden variety.

**DORSTENIA ARGENTATA.**—A pretty variegated-leaved stove herb, having an erect dull purple stem, which bears numerous oblong lanceolate leaves, each from 3 to 5 inches long, deep green at the margin, with a broad, feathered, central, silvery band. The receptacles of the flowers are orbicular. It was imported from South Brazil by W. Wilson Saunders, Esq.

**GODWINIA GIGAS**—The largest Aroid known, whence the name *gigas*. It has a tuberous rootstock upwards of 2 feet in circumference, a single leaf, with a thick aculeolate petiole, which is yellow, beautifully barred and striped with purple, 10 feet high, and terminates in a broad trichotomously divided supra-decompound limb, nearly 4 feet long, the ultimate divisions of which are confluent pinnatifid. The inflorescence succeeds the leaf, and consists of an erect, convolute, leathery, dark colored spathe about 2 feet long, bluish-brown outside, brownish-red within, supported on a peduncle 3 feet long. Found by Dr. Seeman in the mountains of Nicaragua, whence living roots were sent to Mr. Bull.

**HYACINTHUS CANDICANS.**—This magnificent Liliaceous bulb, which requires greenhouse treatment, is so totally dissimilar in aspect from the ordinary *Hyacinthus* as to raise some doubt whether

it really belongs to the same genus. However this may be, it is a grand plant, with large round bulbs, from which proceed several ovate-lanceolate, sub-erect leaves,  $2\frac{1}{2}$  feet long, recurved in the upper part. The flower scape is erect, glaucous, 4 to  $4\frac{1}{2}$  feet long, including the raceme, which is a foot long, and consists of from 15 to 20 large drooping, funereal bell shaped, pure white flowers. It is a native of South Africa, whence it was introduced by Mr. Cooper to the collection of W. Wilson Saunders, Esq., who observes:—"This very free-flowering bulb is of great beauty, and very valuable as an ornamental plant, its large nodding white flowers, produced in an elongated spike, giving it a peculiar and graceful appearance."

**HYACINTHUS PRINCEPS.**—A very fine greenhouse bulb, with the general habit and foliage of *H. candicans*, and closely related thereto, but less ornamental, having broader and shorter racemes, and smaller greenish-white flowers, the segments of which are spreading; the flowers are nodding, but the capsules become erect. It is a South African species, and has been introduced to and flowered at Kew. Mr. Baker remarks of this and the preceding:—"These are two magnificent additions to our list of cultivated Liliaceæ. Although so different in habit from the previously known species of *Hyacinthus*, the principal technical difference is in the much more numerous and angular seeds. As we have characterized it, *Hyacinthus* includes *Bellevalia*, *Peribæa* and *Strangweia*. The extremes differ from one another a good deal in the shape of the capsule and the number of seeds, and in the insertion and shape of the filaments, but we do not see that any line distinct enough to separate genera can be drawn."

## FOREIGN INTELLIGENCE.

**DIGGING AMONGST THE ROOTS OF FRUIT TREES.**—Although we have made much progress in America—the *Gardener's Monthly* taking credit therefor—towards abandoning the old time notions about digging amongst fruit trees, it must not be supposed that other coun-

tries are not progressing as well. A correspondent of the London *Journal of Horticulture* complaining that his fruit trees don't bear, the Editor thus enlightens him as to the causes thereof:

"The above letter, just received, describes in forcible language the state of many gardens and

individual fruit trees—trees and plants growing luxuriantly, and bearing little or no fruit. I believe, in the majority of cases, keeping the land loose by digging and forking is the cause of failure.

Some years since I was sent for by a gentleman to inspect his Peach trees (standards planted out in a border of his orchard house), which he told me always cast their fruit. No trees could look better; they were as clean and healthy as could be wished. After asking his gardener all the questions I could think of as to the management, and receiving satisfactory replies, I all at once thought of the soil, stamping upon which with my heel I found it almost as light as a feather bed. "How is this?" I asked, knowing the gardener had often been to see my trees, and that he knew the borders had never been disturbed since the houses were built. "Oh," he said, "Mrs — will have winter salads grown here." "Give my compliments then," I replied, "and say she must not expect Peaches." The border was made solid and kept so, and there was a full crop the next season. The fact is not so easy of explanation as some people think, but fruit trees like solid soil, not loose.

That digging amongst such plants as Raspberries and Strawberries must be a stupid practice is patent on the least consideration. Why manure a piece of land and then destroy the roots seeking to occupy it? When the roots have been mutilated, how can the plant be expected to bear drought or carry fruit? I saw at Berry Hill, near Mansfield, the other day, a large bed of Hautbois Strawberries with as much fruit as any common variety might be expected to carry, and this on light land. Other varieties were loaded with the largest crop I ever saw in my life. I asked Mr. Cope, the gardener, how they had been managed. He said as soon as the crop was gathered, all weeds, runners and dead foliage had been removed, and the ground between the rows covered with a very thick dressing of manure. The rows had also been watered two or three times with manure water. The plants were then encouraged to make a strong healthy growth in the autumn. The whole land was full of roots, and covered, as the surface was with the remains of the manure, the plants had not suffered from want of rain, whilst Strawberries in the neighborhood, on better soil, which had been dug in the winter, were burning up. Ram the soil hard whilst dry when potting Vines, Peaches, or any other fruit trees, keep

fruit tree borders solid and mulched with manure, and there will be fewer failures in fruit culture.

EUGENIA UGNI.—All who possess orchard houses should procure a plant or two of this myrtle. It fruits profusely, and possesses the most delicious flavor imaginable. In general appearance it bears a close resemblance to the common myrtle (*Myrtus communis*). It may be propagated freely from cuttings of the young wood in a moderate heat.—*Gardener's Weekly*.

LINUM TRIGYNUM.—The following about a pretty old plant often seen in American greenhouses, is from the Dublin *Gardener's Record*

"I see your London correspondent R. D., has mentioned my name in the *Gardener's Record* of the 9th of April, and asks if I would say something about the management of that fine old winter-flowering plant, *Linum trigynum*. Then he adds:—'I know Mr. N. Blanford is a reader and an admirer of the *Gardener's Record*.' In this statement R. D. is quite correct; for I do both read and admire *The Gardener's Record*, and where is the gardener that does not after having once seen it? I read it because it is instructive, truthful, and original; I admire it for its noble object, its freedom of expression, and its decided Christian tone; and since I have been a reader of it, I must own I am brought very near to the heart and homes of the Irish people—"gardeners at all events." In fact, I begin to know many of them in heart, and, as the increase of friends tends to the increase of happiness, I certainly enjoy more intellectual pleasure through the reading of its pages.

But to return to my subject *Linum trigynum* is a hard-wooded, greenhouse plant, a native of the East Indies, introduced, I believe, about 1802. My plants have done flowering, and are pruned so I shall just mention the way that I treat them from this time—May 1st—till flowering time again.

I have said they are pruned, and some of your readers may ask how? By shortening the last year's wood to about three inches off the old wood. And then I put them out by the side of an old fence with a lot of other things, such as forced roses, weigelas, &c.; but give them very little water at the roots till they make new growth.—Then, when they have fairly started into growth, the young wood being about half

an inch long, I bring them to the potting bench, turn them out of the pots and examine the roots; if healthy, remove a little of the old soil, then re-pot them, using a compost of sandy loam, two parts, light fibrous peat, one part, with a little sharp sand, and a pot large enough to allow the soil being properly placed round the ball of the plant. If, however, the roots have not well filled the pot, or do not appear to be in a healthy state, I leave the plant in the same pot for another year, in the former case, and reduce into a smaller in the latter. The plants are now put into cold pit with azuleas, &c., and kept close for a few days. But I do not allow them to remain under glass longer than is necessary to give them a fresh start, which is from one week to three, according to circumstances. They are again placed out by the old fence, and there remain in company with anything that requires a turn with the syringe in the evening after a hot day; till having time in the autumn, when a cool airy place in the greenhouse is allotted them for a week or two. And now the finishing stroke of training is performed—a good syringing with clean water against the under side of the foliage, in case a red spider should be lurking there; and I take them to the conservatory (for convenience) where the first beautiful yellow flower makes its appearance about the first week in December, and the plants continue to flower with me till the latter end of March, when they are kept rather dry at the root till opening time again.

A little care is required in watering, all through the year. Now, I beg to say, I do not mean to tell others what to do, but only tell them what I have done, and been successful.—N. BLANDFORD.

EXHIBITION FERNS.—The London *Journal of Horticulture* says:

“EXOTIC FERNS.—Of these there is not so large a show as on some former occasions, but the want is more than made up for by the quality of those shown. Mr. Williams, of Holloway, is first for nine, with large and fine examples, with fronds of the greatest freshness, consisting of *Cyathea dealbata*, *Todea africana*, two good *Gleichenias*, *Cibotium Schiedei furcans*, *Dicksonia squarrosa*, *Davallia dissecta*, very beautiful, *Dicksonia antarctica*, and a particularly fine and very wide-spreading *Cyathea princeps*. Messrs. Bell & Thorpe, Paddock Nursery, Stratford-on-Avon, are second with a very good Bird's-nest Fern,

and small well grown specimens of *Cibotium*, *Alsophilas*, *Blechnum coreovadense*, &c. Mr. J. J. Chater is third. In the amateur's class for six, Mr. Baines takes the first position for a specimen of *Gleichenia speluncæ* most beautifully furnished, and measuring nearly 5 feet in diameter; good examples of *Cyathea dealbata* and *medullaris*, *Davallia bullata* fine; *Davallia tenuifolia*, and a fine pan of *Todea superba*. The second prize goes to J. Mapplebeck, Esq., Woodfield, Moseley, Birmingham. The first of the special prizes given by H. Grisewood, Esq., was awarded to Mr. Wright, gardener to C. H. Crompton Roberts, Esq., Regent's Park, for a collection containing a beautiful *Adiantum Farleyense*, *A. cuneatum*, *Cibotium Schiedei*, *Lomaria gibba*, *Dicksonia antarctica*, and a *Cyathea princeps*. Messrs. Bell & Thorpe are second. A first-class certificate was awarded to Messrs. Wood & Ingram for a new variety of *Lomaria nuda*.

The best pair of Tree Ferns are from Mr. Williams—viz., *Dicksonia antarctica*, and *Cyathea Smithii* about 12 feet high; the second best come from Mr. C. Walton, Cowley Road, Walton, and are a well grown pair of considerably less size, round the trunks of which is trained white variegated Ivy.

CHANGE IN THE HABITS OF BEES.—“That the praises I have vented on the Californian climate are not exaggerated may be inferred from this circumstance. It was some time after settlers had flocked here from other parts of the American continent and from Europe before the honey-bee was introduced. This useful little insect soon made itself at home, and filled hives with honey. After a year or two had elapsed, the store of honeycomb was diminished to a minimum. The bees found that as flowers were in bloom all the year round, there was no necessity for laying up a large supply of honey against a barren and blossomless winter season. Consequently, arrangements had to be made to deal with the bees as with hens, abstracting the honey in small portions in order that the formation of the honeycomb might go on uninterruptedly. Perhaps it may prove interesting to add what I have learned at second-hand, but from unprejudiced sources, that the highest eulogiums passed upon the soil, sky, and climate of California are literally applicable to Vancouver's Island also; and that if Americans are to be congratulated on having such a Garden of Eden

as California among the States of the Union, the English people are quite as fortunate in numbering Vancouver's Island among the possessions of Great Britain. My informants were Americans, who did not conceal their desire to substitute in British Columbia the Stars and Stripes for the Union Jack. It is hardly creditable that a possession so valuable should be almost disregarded. Those who are concerned in the organization of emigration from England, might do their fellow countrymen a service by investigating the advantages of settling in British Columbia. — W. F. RAE, in *Cot. Gardener.*"

*SAPONARIA OCYMOIDES* should not be classed with *Silene pendula*, a hardy annual of a somewhat weedy nature, though well adapted for spring gardening. When well grown, *S. ocymoides*, seldom attains to more than a foot in height; hence should be encouraged to make as much growth as possible, as whatever growth is made during the season ultimately becomes masses of dense bright rosy pink flowers, which have an exceedingly pretty effect. — *G. Chronicle.*

**RHODODENDRONS FOR THE CONSERVATORY.** — I would strongly advise those who have plenty of room for cultivating the tender kinds, whether in several small houses or one large one, to grow the following: *Arboreum*, deep crimson. *Ciliatum*, blush-white, dwarf and compact; one of the very best for pots. *Countess of Huddington*, white tinted with pale rose; flowers very stout and waxy, and of large size; grand either for pots or for planting out in the conservatory border. *Formosum grandiflorum*, pure white; flowers large and waxy, and produced in wonderful profusion. *Fragrantissimum*, pure white, top segments spotted with deep yellow, and exterior of tube stained with pale rose; a hybrid between *Edgeworthi* and *Formosum*, combining the delicious fragrance of the former with the free-flowering qualities of the latter; the flowers are, moreover, very stout, and when fully expanded average five inches in diameter. *Jasminiflorum*, pure white; flowers very similar in shape to the well-known *Stephanotis floribunda*, and, like that fine old subject, very sweetly scented. *Princess Alexandra*, of a similar character to the preceding, but the flowers are larger and longer in the tube, and the stamens are pink which adds considerably to the beauty of the flowers. *Princess Helena*, also in the way of *Jasminiflorum*, but the flowers are much

larger, and beautifully tinted with rose. *Nuttalli*, pure white, magnificent when in flower, but only suitable for large winter gardens. *Retusum*, reddish orange. *Veitchianum*, white; flowers large and stout, with fringed margin. There are several other sorts worth growing, but the above selection includes the best and most distinct.

The proper way to deal with this section is to plant them out in the conservatory border where they can have room for their full development. All will do well in a good camellia-house, and should be planted alternately with them, as they commence to flower just after the principal bloom of the camellias is past. To say anything about the magnificent appearance of large specimens of such kinds as *Arboreum* or *Nuttalli* is unnecessary. Few who have seen the grand specimens of the former in the conservatory of the Royal Botanic Garden, Regent's Park, or that of the conservatory of the Royal Horticultural Society at South Kingston, will readily forget the extreme grandeur of their appearance when in bloom. There are also several fine specimens at the Crystal Palace, which are loaded with magnificent trusses of bloom every year. — *The Gardener's Magazine.*

**GOOSEBERRY SHOW AT AKROYDON.** — The second annual gooseberry show, in connection with the New Town and Booth Town Allotment Gardens, was held at the house of Mr. George Wood, Flying Dutchman Inn, Akroydon. It was a complete success, and reflected great credit on the exhibitors. The heaviest gooseberry, weighing 20 dwts. 3 grs., was exhibited by Mr. Thomas Murgatroyd. The first prizes in each class, with the weights of gooseberries shown, were the following: Red gooseberries, 16 dwts. 17 grs., Mr. John Clayton; white ditto, 12 dwts. 6 grs., Mr. John Clayton; green ditto, 14 dwts. 15 grs., Mr. Thomas Watson; yellow ditto, 15 dwts. 7 grs., Mr. John Clayton; best pair of twins, 19 dwts. 10 grs., Mr. John Clayton. The other prize-winners were Messrs. J. Clayton, T. Murgatroyd, T. Watson, T. Barrett and James Greenwood. One or two fine specimens were exhibited for non-competition by Messrs. Richard Parker and William Town. Mr. Samuel Sutcliffe, of Owendon, officiated as weigher, and gave general satisfaction. — *Gardener's Weekly*



MR. J. G. VEITCH.—So many new plants have been named after this enterprising collector that the following from the *Gardener's Chronicle* will have general interest :

“John Gould Veitch was born at Exeter, in April, 1839, and had, therefore, only reached his 32nd year. He was at an early age initiated in the mysteries of the nursery trade, and took an active part in the management of the establishment at Chelsea. It was in April, 1860, almost as soon as he had attained his majority, that he started on his voyage to Japan and China, whence he proceeded to the Phillippine Islands. The result of this journey was the enrichment of our collections with many choice plants, among which the lovely *Primula cortusoides amœna* would of itself form no mean monument to his memory. Various handsome conifers, as *Abies firma* and *Alcoquiana*, *Cryptomeria elegans*, and other plants, as *Lilium auratum*, *Ampelopsis tricuspidata* (*Veitchii*), and *japonica*, &c., were, however, also obtained as the fruits of that first journey, and our volumes for 1860-61 contain from his own pen the interesting records of his journeyings and discoveries during the two years which elapsed previously to his return in the spring of 1862.

The spirit of enterprise, and the desire of making discoveries, which prompted him at the first to set sail for Japan, then lately made accessible to Europeans, did but slumber for a season, for in 1864 we find him again *en route*, this time bound for Australia and the South Sea Islands, whence he returned in February, 1866, after an absence of some eighteen or twenty months, bringing with him some of the most beautiful plants of modern introduction : witness the numerous richly colored forms of *Croton* and *Dracœna*, which are only now becoming known. Of the *Crotons* alone no fewer than than twenty tree distinct kinds were obtained ; and of *Dracœnas*, *Regina*, *Magnifica*, *Mooreana*, *Chelsoni*, *Macleayi*, and several others ; to these added such distinct and popular subjects as *Acalypha Wilkesiana* (tricolor), *Anuraphis melancholicus ruber*, *Coleus*, *Veitchii*, and *Gibsonii* the more choice and valuable *Pandanus Veitchii*, *Aralia Veitchii*, and many others. During this journey, Cape York in Northern Australia was visited, and here was obtained a new palm, which has since been dedicated to his honor under the name of *Veitchia Johannis*. The record of this second journey, specially interesting as referring to many little known and rarely visited islands, will be found in our volume for 1866.

In the early part of 1867, Mr. Veitch, then recently married, was taken seriously ill with an affection of the lungs, and for some time his life was despaired of. He, however, rallied under careful treatment and the potent aid of his indomitable spirit, and though subsequently obliged to winter in a warmer climate, his friends were not without hope that his life might have been for some time spared to them. But this was not to be. On the 9th inst., hæmorrhage from the lungs, under which he gradually sank, set in, and he expired on the evening of the 13th inst., at his residence at Coombe Wood, leaving behind him a widow and two boys. On Thursday last he was laid beside his father in the Brompton Cemetery, having been borne to his grave by the same trusty workmen ; some of whom had, moreover, assisted to carry his grandfather to his last resting place.”

LINUM TRIGYNUM—*Another Plan*.—This is a fine winter flowering plant, a native of the East Indies. It is often treated as a greenhouse plant, and it is said, that it may, during summer, be grown out of doors ; but I have not had it to do well in either situation. If it is expected that this plant should give that satisfaction which it is capable of giving, it must be well grown during the summer and autumn months, and to do that, it will require warmer quarters than either of the above. The cool end of a moist stove, an intermediate house, or a close pit or frame, with a gentle bottom heat and a humid atmosphere, will grow it well. In such a situation, a partial shading from the mid-day sun will be beneficial during the brighter and warmer days of summer. At other times and seasons the plant will require as much light as it can obtain to ripen the wood before the approach of winter. A temperature of from 65° to 75° will suit it during summer, and from 50° to 60° during winter. A sharp look-out will have to be kept to guard against the appearance of red spider. If they should attack the plant, they will, in a very short time, make fearful ravages ; therefore the necessity (if for no other purpose) of a moist atmosphere and the daily use of the syringe. It strikes very freely from cuttings of the half-ripened young wood, any time during the autumn. Cuttings inserted from the end of July to the middle of August will, if grown on in heat, make nice stuff, and flower well the following winter. They are, even when small, very useful and effective, with their

fine, rich, golden flowers. I strike them singly in small thumb pots. As soon as they are rooted, and that growth has commenced in earnest, I pinch off the top down to three or more eyes, according to strength of cutting. As soon as the buds have fairly burst into leaf, they are shifted into three or four inch pots, using a soil composed of good turfy loam and peat, in equal parts with some silver sand. After shifting, a slight watering through a fine rose will suffice, just enough to settle the fresh soil about the balls and to prevent the plants from flagging until such time as they have recovered from any check which they may receive during the operation; after which, a little weak liquid-manure, at least once a week, will be of service. The same rules hold good in the case of older plants shifted or re-potted during the spring.—C. P., in *Gardener's Record*.

AN ENGLISH GLADIOLUS SHOW.—The following from the *Dublin Gardener's Record* describes how these were put up at an exhibition in England:

The thirty-six spikes were arranged in two boxes, each having three lines of six spikes. At each end of the front line rises a short stout brass rod, about eight inches in height, which supports a horizontal rod of a similar character, running the length of the box. The second line has the rods about two inches higher; the third or back line, still higher by two inches. The spike stands in a zinc tube of water, as in the case of dahlias, and is neatly tied to the horizontal rods. The boxes are also nicely covered with green baize. It is an excellent mode of showing this truly superb flower, and displays the spikes to the best advantage. In the arrangement of his flowers, Mr. Kelway is a true artist, and the most is made of each individual spike. How largely this firm cultivates the gladiolus may be inferred from the fact that at this season of the year they are found exhibiting at all the leading shows. On Tuesday, the 16th, I had the pleasure of awarding them a first prize for a splendid eighteen spikes, at Shepton Mallet, in Somerset; and the next day they were exhibiting at Trowbridge, in Wiltshire, as well as at South Kensington. The following were the thirty-six varieties shown at the the exhibition of the Royal Horticultural Society:—*Honore*, *Nannie*, *Anna*, *Canora*, *Van Dyck*, *Sultane*, *Mons de Brogniart*, a beautiful variety, the petals edged with pink, and feathered and flaked with carmine; *Orphic*,

very fine; *Leonora*, *Matilde de Landevoisin*, *Virgile*, *Norma*, very fine; *Duc de Montbello*, very fine; *Prince Imperial*, *De Humboldt*, very fine; *Schiller*, *Newton*, rich deep crimson, very fine; *Laccpede*, a very fine rose colored variety; *Le Gouze*, very fine; *Villeda*, *Eugene Scribe*, very finely feathered; *Formosa*, *Rosini*, very fine and beautifully colored; *Stella*, *Mayerbeer*, *Elizabeth*, *James Veitch*, *Agnes Mary*, *Robert Fortune*, very fine; *Madame Desportes*, very fine and a noble spike; *Fremason*, very fine; *Rosa Bonheur*, *Le Titien*, *Moliere*, very fine; *Spectabilis* and *Mad. Vilmorin*, also very fine. In addition, Messrs. Downie, Laird, and Laing, London and Edinburgh; and Messrs. Stuart and Mein, Kelso, N. B. among Nurserymen; and the Rev. H. H. Dombrain, West Well Vicarage, Ashford, and Mr. Fry, gardener to V. Stuckey, Esq., Langport, among amateurs, showed very fine also. As a gladiolus exhibition it was a great success, and very encouraging for the future.

LILIUM AURATUM.—I had between 400 and 500 seedling varieties of this glorious *Lilium* in flower this summer; and being nearly all in flower at one time, the display was gorgeous in the extreme. The seed was sown in April, 1866, and some of it did not vegetate that year, but formed little bulbs in the soil. In 1867 they were pricked out into shallow boxes, the soil being peat and sandy loam; and the year after, they were all potted singly into small pots. A few of the plants flowered last year, but the great bulk of them did not flower till this season, when many of them yielded from seven to eleven flowers on the stem. A great diversity of color and of form was to be seen in these seedlings. Many of them had a broad red band instead of the yellow, which changed to a brownish tint when the flowers got older. Some of the pods of seeds sown were crossed with *L. speciosum*, but none of the seedlings showed the reflexed shape of *speciosum*, only a darker spotting, and the red band in several which have been marked and crossed again this year with a very dark crimson seedling of *speciosum*—*Gardener's Record*.

Never sweep a gravel walk with an old broom. It not only tears the edging, but it also scrapes up the walk itself.

Keep a journal of gardening, with memorandum of when everything is sown, planted, and cut or gathered for the house; with as many other particulars as you please.

## HORTICULTURAL NOTICES.

PENNSYLVANIA HORTICULTURAL  
SOCIETY.

## MAY MEETING.

In consequence of the immense throng which crowded the large hall on the April meeting, and which made it very difficult for any one to see the half of what was exhibited, the managing Committee determined on a grand flank movement, in the shape of a pretty heavy charge for admission to all persons not members of the Society. We are sorry to say this brilliant manoeuvre was a complete failure. It appeared as if the whole beauty and fashion of Philadelphia had been gathered up by a floral whirlwind, and then poured out in a huge mass, for the especial swamping out of the unfortunate Society. Here were to be seen the leading politicians, from the popular Collector of the Port down to members of City Councils, hobnobbing with high dignitaries of the church, as if the affairs of the other world and the schemes of rulers had but one thing in common. Lawyers, and Merchants, and Doctors; forgetting their briefs, and prescriptions, and account books; were scattered amongst myriads of elegant ladies, and seemed of no more account than as so much cement in a pretty piece of mosaic work; and as for the ladies themselves, all we can hope is that they will endeavor to take somewhat from their personal charms and attractions. As it was that night, the Roses became jealous, and the Lilies paled; and it was clear that in the interests of horticulture, the managers must do something to lessen the popular tide of enthusiasm which is setting in towards these exhibitions. However, this is their business,—ours simply to note for our distant horticultural readers such items as may interest them.

Our note book opens in front of the collection of Wm. C. Harris. This is a new name on the roll of honor connected with the Pennsylvania Horticultural Society. From the past and present month's exhibition, this gentleman promises to take high rank amongst Philadelphia Florists. Now he has some gems in the Fuchsia way. One, Elm City, was grown just to our taste. Not a Mammoth of the paleozoic age, but just such a modern little pet, that would make itself at home as well on a dinner table, as

in a grand conservatory. Not over two feet in height, yet regularly conical, and with hundreds of pretty semi-double, crimson and red flowers; it was all one could desire. Alfred, a light red with large corolla, also distinguished itself. Another very good one was Symbol, with recurved scarlet sepals, and double white corolla. Here was also a nice collection of double Geraniums, Madame Lemoine, and E. G. Henderson, were two of the best; but there is too much sameness between all these doubles.

Mr. Smith, gardener to Matthew Baird, Esq., had a circular table filled with plants—Rhododendrons, Azaleas, and leaved plants. As a "collection," altogether, they made a good show; especially an *Ixora crocata*, was to many somewhat of a novelty.

In Mr. Graham's collection we noticed a very good specimen of *Guzmania nidularis*. With their pineapple-like leaves, and flowers of rich bracts nestling in the centre, these always have an interest to the spectator. One of his best plants was *Medinella magnifica*, which, besides being a very well grown and striking foliage plant, had several fine clusters of pendulous pink blossoms. Amongst his rarer plants, we note a *Caladium fulgens* in the way of the old *C. bicolor*, but with a much richer tint of foliage. His collection of *Coleus* was very attractive. There are few to our mind more effective than the old *C. Verschaffeltii*, unless perhaps one in this collection, *C. aurea marginata* may prove to be so.

From the old garden of the late Peter Raabe, was a collection of Iris, received recently from Alsace; also a double white anemone-leaved "butter cup," which we think has not hitherto been in cultivation in the United States.

Mr. Thos. J. Mackenzie contributed in his collection some things which were striking. Amongst the others, a well grown *Hibiscus Cooperi*, for instance, with tricolored leaves, was as handsome as some *Dracenas Fuchsia aucubifolia* with large white blotches on the leaves, is very ornamental under greenhouse culture. A variegated ivy-leaf—Duke of Edinburgh—though evidently not a true ivy-leaf, is an excellent thing of this class. Here also was a good specimen of *Aralia Sieboldii*, which though not in any way variegated, is a striking leaf plant.

Mr. Newett, gardener to H. Pratt McKean, has as usual a grand collection, with many plants as well grown as they were rare. A cylindrical plant of *Clerodendron Balfouri*, 2½ feet high, had some hundred of its crimson and white flowers. *Azalea variegata*, usually of slow growth, about three feet high. A *Begonia amena* in a flat pan with scarlet flowers and dark green leaves, was very well grown. *Phyllocactus crenatus* had three expanded cream colored flowers, about 6 inches long. A pretty pan of *Panicum variegatum*, about two feet over, was also very well done. *Agave filifera*, a curious dwarf species from Mexico, with threads like the common *Yucca filamentosa* is a striking kind, and very valuable for some forms of conservatory decoration. There were not so many rare orchids as usual in the collection. There was, however, a *Cypripedium barbatum* with three flowers, and an *Acanthophippium bicolor* with fourteen. A few *Pelargoniums* were remarkably well grown for Philadelphia; they were about 2½ feet high, and nearly as thick, and pretty well covered with flowers.

Mr. G. Huster, gardener to J. B. Heyl, had some very fair specimens of some old fashioned plants. That beautiful old Cactus, *Epiphyllum Jenkinsii*, had about 50 of its cup-shaped scarlet flowers; also a *Begonia Sandersii*, about three feet high, well flowered. He also had a nice collection of *Fuchsias*.

Mrs. Bissett's collection had more well grown ferns than any other collection; amongst these was a very nice plant of *Cyrtogoncum falcatum*. Amongst the other plants was a good specimen of the delicate leaved *Muhlenbackia rotundata*, or as it is sometimes called in greenhouses, *Polygonum rotundatum*. It is a neat little basket plant.

Mr. H. A. Dreer had the new spotted *Calla*, *Richardia albo maculata*, amongst his plants. His *Petunias* were also attractive; so also were the *Fuchsias*, and especially *Montrose* with a very narrow red tube, and large double white corolla.

For rare and lovely plants, the collection of Robert Buist is always sought. Here we believe for the first time in Philadelphia, *Begonia Boliviana* was exhibited. The leaves are "all right," but the pretty pink flowers are unlike the common styles of *Begonias*. In *Ericas*, usually so hard to grow well in our summer climate, he had a good representative in one labeled "Westphlegi." He had also a very pretty plant

of the old, but very rarely seen, *Mussaenda frondosa*. This has yellow flowers, in shape like a short and thick *Manetta* or *Bouvardia* which are surrounded by large white bracts, similar to the dark red ones in *Poinsetta*. He had also a *Clerodendron Balfouri* about four feet high. Plants of this, either large or small, were in most collections, showing how popular it is becoming as a spring blooming plant. Amongst his remarkably well grown *Geraniums*, we noted *Christine Nosegay* as one of the best. The double *Petunias* were also well grown. Indeed it is one of the good points of Buist's plants, that they are always well cultivated. The *Pelargoniums* were particularly fine, and attracted much attention, especially a dark one, *President Lambourg*. Among his other rare plants, which are acquisitions, were *Peristrophe angustifolia*, and a variegated *Pampas grass*.

Mr. David Fergusson, of Laurel Hill, had a very well grown *Adamia versicolor* among his plants, another old and good plant seldom seen; here also was a very good *Clerodendron Balfouri*, besides numerous *Azaleas*, *Verbenas*, &c.

From Meehan's Germantown Nurseries came a collection of cut hardy shrubs, &c.,—to bloom early in May. Among them were *Spiræa Reevesii*, and *S. Hookeriana*; *Persian white*, and common lilac; *Tree Peony*; white and purple *Wistaria*; *Tartarian Honeysuckle*, *English Bird Cherry*, *Halesia tetraptera*, and *Magnolia purpurea*.

The cut flowers were chiefly exhibited by Messrs. Graham, Huster, and John Dick. The presence of the latter gentleman amongst the exhibitors was taken as a happy sign of the times, as he never takes his place among things which "don't pay." His basket of cut flowers was well worthy of a first appearance, and struck us as being very original in style. Usually there is no difference in the kind of flowers used for small or large baskets. This was a large one, and the flowers selected also large, such as *Callas*, large *Roses*, trusses of *Geraniums*. Yet gracefulness was imparted to it by a liberal use of *Deutzia gracilis* and *Heliotrope*. The baskets of cut flowers exhibited at this Society, are usually models of good taste, and this one of Mr. Dick's well sustained the Society's reputation.

Fruits were scarce. Two collections of forced *Strawberries*, one by Mr. Blair, and the other—very fine *Triomphe de Gand*—from Mr. George Hughes of Chester County. Thos. J. Pullen, of Hightstown, had some pretty white *Peaches*, the name of which we did not recognize.

The Vegetable department was very well sustained by Mr. Huster and Mr. Felten.

# The Gardener's Monthly.

DEVOTED TO

*Horticulture, Arboriculture, Botany and Rural Affairs.*

EDITED BY THOMAS MEEHAN.

*Old Series, Vol. XIII.*

*JULY, 1871.*

*New Series, Vol. IV. No. 7.*

## HINTS FOR JULY.

### FLOWER GARDEN AND PLEASURE GROUND.

We suppose by the time this page gets before the public, many of our readers from the large towns and cities will be far more interested in what the wild waves are saying along the lakes or sea shore, than in anything we may write here. Yet we should not mind so much their non-attendance on our monthly discourses, if we were assured they did not neglect the lessons on gardening which we have been regularly giving them; for the average of these "summer resorts" are a disgrace to the civilization of the age. How most of the branches of fine art fare, we shall leave other tongues to tell,—it is in our province to refer only to gardening, and what this is, every one who loves a plant or flower knows! But we hope that those of our readers who are among the "world's people"—the world of people who have no appreciation of the great pleasure or love of art in nature brings,—will endeavor to sow better seed, and realize a better state of things. It is really wonderful that those who start these summer boarding speculations, do not understand how much more profitable these several institutions would become if some attempt at tasteful gardening were made about their establishments. Animal comforts are of course essential. A good table, and good attendants can by no means be dispensed with; nor perhaps conveniences for quiet walks and fashionable displays; but it is an error to suppose that the average American is all animal; and this we are assured any leading hotel or boarding house that would give us a first-class garden, in addition to other good things, would speedily and most profitably discover.

But we will say no more about those who are for this month lost to us; but will offer a few words to thousands who are enjoying the comforts of home amidst the trees, and plants, and flowers their own hands have tended; and the beautiful groups of trees and chaste designs of growing shrubs and flowers which their cultured brains have designed, and loving nature brought forth for them. Under some cool tree,—in some shady spot,—we can enjoy some part of a good summer life in our gardens, in a way the jaded "health seeker" of a summer resort never knows. And we may have much more of this pleasure than we have, if we will only think of it at this time. We can see now, as we sit in our easy chair in the light of the setting sun, how an addition here or there would add to the beauty of the scene before us, and we revolve in our minds what particular kinds of plants would produce the best effects in our suggested improvements. In some parts or another of our grounds we have specimens of all the popular trees and shrubs, so that we become familiar with their habits and appearances; and thus know at once the uses we can put them to in our proposed improvements; and we note them down while the ideas stand fresh before us.

Around our rustic arbor we have our gay flowers blooming; and far away in the distance Mignonette and other fragrant plants set out. We resolve to correct this another year. Indeed distance does increase the enchantment which a bed of massed geraniums, or tastefully arranged collection of Coluses or leaf plants create,—but we cannot imitate the grand Turk's faithful slaves in wafting the sweet odors from incense burning censers, in a better way than by plant-

ing these sweet things close about our favorite evening lounging places. In vines for such arbors we can have an odorous succession during the whole year. We commence with *Akebia quinata*, which during April and May, give the fragrance of orange blossoms.—not so powerful it is true, but yet pleasingly delicate. With June comes in the American Wisteria, *Glycine frutescens*, and if a bunch or two of *Philadelphus coronarius*, the sweet Mock Orange, and the common Lilac be set about outside, they fill in a few days of interregnum between these right royal things. The Honeysuckles, however, soon follow June Roses, and these in turn succeeded by sweet Clematis and Jasmines, make these retired seats odorous throughout the year.

It will also be well at this season to make notes of these things which we find to stand the summer heats and droughts, and yet flower well. The Gladiolus is now very popular as one of these plants. The *Tritoma uvaria* is not so well known, but quite as beautiful.

The time is coming when transplanted trees of the past Fall and Spring will suffer more than during any other part of the season. If they show a vigorous growth of young wood, no danger need be apprehended, as it indicates that the roots are active, and can supply all the moisture the foliage calls for; but if no growth has been made, no roots have been formed, and the leaves are living for the most part on the sap in the wood and bark, and hot, drying weather will tell with injurious effect on such trees. This is generally first shown by the peeling off of the bark on the southwestern side of the tree,—the most drying aspect; and where such exhaustion appears probable, much relief may be afforded by cutting back some of the branches, syringing with water, occasionally, shading the trees where practicable, or wrapping the trunk in hay-bands, or shading the southwest with boughs or boards.

Plants set against walls and piazzas frequently suffer from want of water at this season, when even ground near them is quite wet. Draw away the soil around each plant so as to form a basin; fill in with a bucketful of water, allowing it time to soak gradually away, and when the surface has dried a little, draw in loosely the soil over it, and it will do without water for some weeks. This applies to all plants wanting water through the season. If water is merely poured on the surface, it is made more compact by the weight of water, and the harder the soil

becomes, the easier it dries; and the result is, the more water you give the more is wanted.

Keep the pruning knife busy through the trees and shrubs, with the object of securing good form. Judgment will soon teach one which shoots would spoil the shape if not taken out.

In most kinds of soil the keeping the surface loose by hoeing and raking in dry weather, will be an excellent method of keeping the main body cool and moist.—admitting the air, which is a good non-conductor. In soils, however, which are deficient in loam, and in which sand prevails to a great extent, frequent stirrings have a drying tendency, and a mulching of short grass, or decaying vegetable matter of any kind, will be found very useful around transplanted trees, shrubs and other things.

#### FRUIT GARDEN.

People sometimes are anxious to get rare kinds of strawberries to fruit early, and hence plantations are made in the fall. For general crops we think there is not much gained by fall planting. In the case of rare varieties, however, it is often worth a little extra trouble to do things well. The best way to proceed, is to get small pots with rich earth, and sinking them in the ground, layer runners into it. Such plants become very strong, and can be transplanted from the pots without injuring the roots, and will make strong stocks which will fruit very well next year. We raised some excellent President Wilder's this way last year,—of course the result was not sufficient to enable one to form an opinion of its whole character; but we may say, that in spite of the excessively hot weather, it has turned out remarkably well. In regard to the best strawberries, it is remarkable that the bulk of all the thousands of bushels which come to the Philadelphia market is still Albany Seedling. Amongst amateurs there is no one that carries universal supremacy with it, as personal taste dictates the favorite. But certainly those which are grown the most extensively are Green Prolific, Triomphe de Gand, Jucunda, Agriculturist and Downer's Prolific.

The thinning of fruit,—watching of insects, especially the borers in Dwarf Pears, Quince, Apple and Peach,—and summer-pruning are the main subjects of attention at this particular season. Where the soil is not very good, as may be noted by a weak growth of the trees, a surface manuring may be yet given with advantage.

Every day's experience more decidedly shows the great advantages to the pomologist of this method of applying manure.

It used to be, and is yet to a great extent, the recommendation of writers to cut away raspberry canes as soon as they have borne fruit; fruit-growers know better know. The slight shade these old stalks afford, is agreeable to the new growth which is to bear next year.

In regard to training fruit trees, this is the most important month in the year. If a shoot appears where it is not wanted, pinch it off, this throws the sap into other directions where strength and vigor is desired. A good summer pruner does not leave much to be done in the winter time.

The time when currants and gooseberries mildew and drop their foliage is at hand. Some have found a mulch of salt hay to be good against these troubles, but in fact anything that cools the surface and thus helps to keep the atmosphere about the plants, is good. A heavy mulch of old corn stalks we have found to be excellent help to success in growing these fruits.

---

#### VEGETABLE GARDEN.

Preparations for the Celery crop is one of the chief matters in this department at this season. No plant, perhaps, requires a richer soil than this, and of all manures, well decayed cow dung is found to be the best. After so many trials with different ways of growing them, those who have their own gardens,—amateurs, for whom we write,—find that the old plan of sinking the plants in shallow pits is about the best. Trenches are dug about six inches deep, and three or four inches of manure then dug in, of which cow manure is the best. They can be watered better this way in dry weather, when in these trenches, and it is so much easier to fill the earth about

them for blanching purposes than when grown on the level surface. Salt in moderate doses is usually a wonderful special fertilizer for the Celery plant.

Late Cabbage is often planted in gardens between rows of potatoes, where it is an object to save space. Some fancy that the Cabbage is better preserved in this way from the Cabbage-fly, which they say prefers the potato; but on this point we are not sure. We do not think the Cabbages do quite as well as when they have the whole ground to themselves; but of course a double crop could not be expected to be quite so fine.

Tomatoes trained to stakes give the sweetest fruit, and remain in bearing the longest; but many cultivators who grow for size and quantity only, believe they have the best results when growing them on the level ground.

For winter use, Beets are occasionally sown now, and also Cucumbers for pickling purposes; but not often; and at any rate it must be attended to early in the month.

The Lettuce is another cool country plant. It can only be grown well in hot weather when in very rich and cool soil.

Bush Beans may also be sown for late crops. A very deep rich soil is necessary to tender, crisp pods. The Lima Bean will now be growing rapidly. It is time well spent to tie them up to poles as they grow. The poles should not be too high: about eight feet is enough. They commence to bear freely only when the top of the pole is reached.

In many amateurs' gardens late Peas are valued. It is essential that they be planted in the coolest part of the ground. The Pea is a cool country plant, and when it has to grow in warm weather, it mildews. The Marrowfat class are usually employed for late crops. They need support. All Peas grow better and produce more when grown to stakes.

---

## COMMUNICATIONS.

### AZALEAS AND RHODODENDRONS OF BLOOMSDALE.

BY WALTER ELDER, LANDSCAPE GARDENER,  
PHILADA.

In the third week in May last, I satisfied a

long desire to see the Belgian Azaleas and Rhododendrons in their prime of blossom, which are grown so successfully, and the varieties so numerous in the open air, in the chaste pleasure grounds of Bloomsdale, belonging to the distin-

guished seed growers, David Landreth & Son. Large numbers of the large plants were in full bloom; some beginning to fade, while others were breaking their blossom buds, and showing their colors. I was so much delighted with the beauty of the individual varieties, and the splendor of the whole, that I cannot rightly describe them. The Azaleas were completely covered with blossoms with various hues of red, scarlet, rose and pink, white, yellow, buff and orange. Here are a few of the names I noted,—aurant, coccinata, rosa pensansia, Utolfe, Princess Mariana, Midas, viscosa splendens, Julius Cæsar, hybrid odorata (Van Hartwig is evergreen with a profusion of blooms.)

The Rhododendrons were of more numerous shades, from deep crimson to scarlet, rose and pink deep, to pale purple, and various shades of blue, pure white, and white shaded with pale yellow and pink. The individual blooms were all large, and the heads or trusses were great masses of beauty, and looked most rich. We have never seen anything of out door growth so very splendid and delightful.

Mr. Landreth has furnished a lesson in ornamental gardening worthy of all praise and extensive imitation. Very many of the species resemble the *Ponticum*, both in blossom and foliage; those of crimson and pure white, are all equally as hardy the others. Here are a few of the names I wrote down on the spot: purpureum elegans, roseum superbum, grandiflora, candidissimum, Catawbiense, cælestinum, Everestianum, John Waterer, alba delicatissimum, Russelianum, atro-sanguineum, Rembrandt, Sir Isaac Newton, Gem, Pontica elegans, ferruginum speciosum; many of the large, old bushes were only with colors named, as follows: pure white, deep crimson, dark purple, deep rose, dark lilac, deep pink, pale pink, bright scarlet, &c.

A *Purple Beech* tree near to the mansion, is 45 feet high, and the diameter of its spreading branches is 40 feet. A perfect model of symmetry; almost hemispherical.

A *Weeping Elm* tree is five feet high, and the diameter spread of its branches is thirteen feet, and very dense.

Three hundred new Azaleas and Rhododendrons were imported and set out last spring, all a foot high; and many of them were in bloom during our visit. Eighteen new *Holly* trees, and six new *Junipers* have also been imported and set out. There are some thrifty plants of *Erica*

*scoperia pumila*. One of the large glasshouses was almost filled with *Calceolarias* and *Cinerarias* grown for their seeds the varieties most superb; we never saw their equal.

## HOW TO GROW PEARS.

BY J. W. ADAMS, SPRINGFIELD, MASS

Mr Adams sends us the following excellent paper. It has already appeared in the *New England Homestead*, but is none the worse for having been published in that excellent paper:

The proper cultivation of this universal favorite is more frequently the subject of discussion than that of any other fruit. Successful growers of apples and other fruits so often fail in their attempts to raise pears, that they regard the favorable results of their friends as a mystery,—the effects of a dear-bought recipe, to them kept secret. Their extensive cultivation, especially in the Northern States, has seldom been attempted; but those most successful in raising them are most desirous of extending their culture and improving their qualities.

To discuss the merits of the various theories and practices of different cultivators, would require more time and space than we can at present devote to the subject. From the widely different modes of treating this fruit tree, an outline of the course suggested by our own experience and observation will, we feel assured, prove satisfactory in similar circumstances.

It cannot be far from correct that every climate and soil which will grow corn, can be made to grow pears. Soils which are of a strong, gravelly texture, with some clay intermixed, appear to be best adapted to produce fruit of the highest excellence. Varieties which flourish on the quince, do exceedingly well in a soil rather moist; but any soil not inclining to be dry, with good culture will produce fine fruit, either on the pear root or quince. It must, however, in either case, be deep and rich, as success can be obtained on no other condition.

Whether pears succeed best on the quince or on their own roots, is a question frequently asked. "I do not want any more of your dwarf trees," said a driving farmer, 'they get broke down with the snow, and break off where they grafted. They are good for nothing; too short-lived. I want something not afraid to hold their heads up; some good large standards, as you you call 'em. If they don't bear in my day, my grandchildren will have something to remember



me by, and I shall get some credit, if no pears."

"If I can have only one style of tree," says our city gardener, "I would sooner take the dwarf. It takes very much less room, and you can have a greater variety, and get pears in a year or two after they are planted. I have gathered two bushels of as handsome Louise Bonne's as were ever seen in market; and the tree had been planted only six years last spring. And I have a dozen more trees in my garden, all dwarfs and planted at the same time, that you could not buy for fifty dollars apiece."

It is not to be wondered that tyros, who come in contact with either of the zealous representatives of these different methods of pear growing, should become at the outset as decided in their preferences as a young politician, who reads one political paper. In this, as in many other theories, truth is found between two extremes. It is as well ascertained that the Duchess does admirably on the quince, as that the Bartlett will flourish best on the pear stock. The Duchess cannot be grown advantageously on the pear; and the Bartlett will not unite well nor flourish on the quince. But we venture an opinion that few lovers of pears would be willing to leave either of these choice old varieties out of their collection.

The first requisite is a rich and mellow soil. If moist, it must be underdrained. We do not mean by richness any such quality of soil as the farmer describes when he speaks of his best corn lands, or grass fields, or even his garden. One of the pear growers in Massachusetts plowed a certain lot ten or twelve times, as deeply as possible, and applied thoroughly decomposed compost half as many. The trees had been planted three years, and had made a growth of four to six feet in one season on the leading shoots. This extravagant mode of enriching, succeeded by a like excessive growth, is so unlikely to be imitated, that we need not caution our readers in this direction. Our fear is that sufficient nourishment will not be provided to produce satisfactory results.

Next in importance is the selection of the trees; and in no particular is the novice likely to err. The variety, size, form and health of the tree, are points about which he can inform himself only by years of observation and experience. Trees slightly crooked are certain to become of sufficient size; but they are often rejected for such as are perfectly symmetrical, but defective in other respects, when examined by

the experienced grower. And this demand for perfectly formed trees, as if manufactured to order at some umbrella establishment, has a tendency to induce the growth of certain straight, vigorous growing sorts by nurserymen, to the exclusion often of better varieties, which are straggling and crooked in their habits,—as the Winter Nelis. Varieties, too, are often selected which it is as unwise to plant as it would be to attempt to grow the fig or the apricot; and the more experience a gardener has in this department, the more caution and care will he exhibit in his recommendation of sorts.

Planting when the ground is thus thoroughly prepared, is very quickly and easily performed. The holes for the reception of the tree should be wide and deep enough to receive the roots without bending. Branches that are too luxuriant are checked by simply bending them downward. In like manner a short curve of the roots from their natural position will prevent growth and weaken the tree. Deep planting is yet more fatal in its effects. Even the dwarf tree on the quince should not be planted as low as is recommended by some writers. It is sufficiently deep if the stock is covered. The greater facility of operating has induced some nurserymen to graft the quince at too great distance from the ground. When planters understand their interest, the practice will be discontinued for want of purchasers, as trees grown in this way seldom produce satisfactorily.

Various methods of staking are adopted to prevent the newly planted tree from being blown about by the winds, an important item, sufficiently understood. Watering is seldom necessary, and as usually performed is injurious. At the time of planting, it may be applied very soon after the roots are covered, but the final layer of earth should be thrown on dry and light, to prevent evaporation. Every one must have noticed how much sooner and deeper a hard road dries or freezes, than lightly plowed land; and watering the surface very soon hardens the soil, when it resists the action of dews and becomes parched and cracked, thus producing the dryness so important to prevent. It is, however, sometimes necessary to resort to artificial watering, to save the life of the tree, and the more nearly we imitate the natural showers, the greater will be our success. We have several times saved very valuable trees by sprinkling the top with a garden engine,—the best method we have ever adopted for this purpose. Very good results

may be obtained by simply removing the earth nearly to the surface roots and applying a large quantity of water at once,—only in as gradual a manner as possible. When a barrel of water has thus been absorbed, the soil may be replaced, and no more water applied for several days or weeks.

Mulching with any substance that will keep the ground moist, is of great importance. Where various materials can be had, preference should be given to those of an enriching nature, and the mulching should be kept on in winter as well as in summer. In young apple orchards, if this were allowed, danger would arise from the depredations of mice, but pear trees are seldom troubled by this vexatious quadruped. Offensive substances are sometimes applied to guard or preserve them. Alkalies and various other substances, at proper times and proportions, benefit the tree also, by producing thrift and preventing insects. But application of coal tar or oily substances, should never be made to a growing tree.

At the time of planting, the tree requires more or less pruning and shortening of the branches. You will never need to caution the nurserymen about giving you too many roots. It would be better to ask him to send the roots with the tops, and have them packed in the most approved style, as pennies saved in lifting or packing, are as many dollars deducted from our prospective pear orchards. Smoothly paring the roots, where they are broken, assists them in healing. All superfluous branches should now be cut out, and usually one-half the growth of the previous season should be cut back. The most upright shoots, however, being the strongest, should be reduced more than one-half, while the lowest side branches should remain nearly their full length. The form of the tree has much to do in the proportion of this reduction.

The dwarf pear tree requires to be pruned in a manner somewhat similar, but its lower branches should be kept within two feet of the ground, and the pyramidal form adopted. All attempts to grow this tree as a tall standard have failed. The leading shoot of two year old trees (the usual age to plant) should be cut back, leaving only six or eight buds at its base, while the side branches should be pruned in less proportion, keeping the pyramid form in view.

In the month of June two leading shoots will have started from the top, and after they have made a growth of eight or ten inches, one of

them should be stopped by pinching off the end of the shoot, which will weaken it, while the remaining one will advance with greater rapidity and strength. Subsequent pruning will become easy to those who have attended to the first principles, stopping the secondary branches during the growing season, as will appear necessary to give light and air, or vigor and symmetry to the tree.

List of Varieties.—To which may be added Fulton, Osband's Summer, Buffum, Winter Nelis, Lawrence, Sheldon, Clapp's Favorite and others.

1. Rostiezer—Small, juicy, sweet and high-flavored. Tree vigorous, not hardy. Succeeds best on the quince stock. Season, September.

2. Bartlett—Large, buttery, melting and juicy. Tree quite tender; one of the most popular pears, and ripens perfectly in the house, even if picked before it is full grown. September.

3. Beurre d'Amanlis—A large, melting, fine pear,—a strong grower, and most abundant bearer on the quince. One of the best. September and October.

4. Doyenne d'Ete—Melting, sweet and beautiful; succeeds well on the quince. August.

5. Fondante d'Automne—(Belle Lucrative). Medium size; melting and delicious. September and October. Trees very hardy.

6. Flemish Beauty—Very large and beautiful,—does well on the pear stock. One of best. September and October. We formerly marked this as our first choice, but now prefer

7. Beurre d'Anjou—A large, fine, buttery, and melting pear. Tree vigorous on pear or quince. October and November.

8. Beurre Clairgeau—Very large; juicy, with a vinous flavor; on pear root it promises to be one of the best new pears. October.

9. Louise Bonne de Jersey—Large, beautiful, and delicious. A hardy, upright grower and enormous bearer,—succeeds best on the quince. Should be in every garden,—and next to the Vicar of Winkfield, the most profitable for market. October and November.

10. Doyenne Boussock—Very large; similar in quality to White Doyenne, and will doubtless supersede that fine old sort. October.

11. White Doyenne—(or St. Michael,) rather large; flesh white, fine grained, very buttery, melting, high-flavored, and delicious. Cracks and falls when grown on the pear root, but on the quince, usually good. Oct and Nov.

12. Urbaniste—Medium; melting and but-

tery. A very hardy tree, and one of the best on the quince. Oct. and Nov.

13. Duchesse d'Angouleme—The largest dessert pear, juicy, rich and excellent. In warm soils a vigorous grower on the quince. October and November.

14. Beurre Diel—Very large; buttery, rich, and delicious. Sometimes coarse at the core on pear stock; invariably good on the quince. A very strong and rapid grower, and productive. Nov. and Dec.

15. Vicar of Winkfield—A large, long pear, fair and handsome, of good quality when well grown and ripened. Tree vigorous on pear or quince; on the latter it is very productive. One of the most valuable of all late pears, and worthy of a place in every garden. December to March.

#### TO FIX SCREWS IN OLD HOLES.

BY A "BOSTON BOY."

I notice that you request notes of any thing that may interest gardeners. I have thought sometimes to send you accounts of how we manage different things, but hardly knew that I could say anything worth printing. But I have a little hint about fixing screws, which I think worth knowing, though it is not perhaps true gardening. However, gardeners have to be jack of all trades, if masters of none,—sometimes it is carpentering, then bricklaying,—indeed since I have been in the gardening business, nearly eleven years, I think I have done a little of all kind of trades. Well, about screws. Some weeks ago a "regular" carpenter here had to put up a screw in an old hole; he sharpened a piece of wood with a chisel, drove it in, cut it level with the surface, made another hole with a brad awl, and sent in the screw. In about a week the screw, wood, plug, and all were out again. I reasoned on this that some elastic thing would be better for the plug, as it would fill up the inequalities and "bite" better. So I rammed long, narrow strips of cork in before putting the screw in, and it is astonishing what a good job it makes.

Now sir, as I said, this is not gardening, but if you think it worth putting in the *Monthly*, I think likely it will help many a gardener who like myself takes a pride in doing such little things, and yet has not time enough to spare to be doing such things two or three times over and over again.

#### CIRCULATION OF HOT-WATER.

BY MR. A. FENDLER, ALLENTON, MO.

Having received the April number of the *Gardener's Monthly* a day or two ago, I noticed in it a controversy going on concerning "Hot-water boilers." I hope you will not think it presumptuous if I venture to give you my views on this important subject.

I think you are right in saying that the cold water, in consequence of its greater density being more powerfully acted upon by the earth's gravitation, pushes upward the less dense warm water, and hence the ascent of the latter is a purely *passive* motion, (the same as in a pair of scales the upward motion of the ascending lighter body is purely passive). But before the ascending motion can take place, there must some particles of water first be made lighter than the rest; this is done by heat. Moreover, these lighter particles must not be debarred from rising by the sides of a *horizontal* flow pipe; in other words, a chance must be given these particles to *go upward*, whenever pushed in that direction by the colder water. Neither downward nor horizontally the cold water can push them, except indirectly in the case where a partial vacuum has been created ahead. The water *may* also be made to move horizontally or even slightly downward along the flow pipe as long as there exists an unusually great difference of temperature between the water in the boiler and that at the farther end of the pipes; but when sometime after starting the fire, the difference of temperature is not so great, then it will be found that a gradually *rising* flow pipe is necessary to carry on a vigorous circulation of the water. It is true, as one of your correspondents remarks, that the force of expanded particles of water presses against the non-expanded, and compels them to move; this alone, however, without the action of gravitation would produce but a very short movement, and no circulation at all, for as soon as the particles of heated water, in proceeding on their journey, cool down, so soon are they contracted again, and this contraction in one place effectually neutralizes the expansion in the opposite place.

My maxims with regard to "hot-water boilers" would be:

1. The flow pipes should always be gradually ascending or rising.

2. It makes no difference whether the return pipe be horizontal or descending, or even somewhat ascending, provided it be straight.

3. The rapidity of circulation is in proportion to the height of the hot-water column in the boiler, and also to the difference of temperature between the ascending and descending portions of the water.

4. Both the flow and return pipes ought to be of a sufficiently wide diameter, as straight as practicable, and smooth inside.

---

### SPLENDID VARIETIES OF ALTHEA.

BY CHRONICLER

*Hibiscus syriacus* is a native of Syria, and is commonly called "Althea," as its blooms resemble those of the *Hollyhock*; it also gets the name of "Rose of Sharon," from the double flowers resembling roses, and the plant having no thorns. The original species bore single blooms, and was considered an acquisition, as its blossoms were produced at a time when no other ligneous plant showed a flower. We now have got by hybridization and special culture, many varieties which bear double flowers, and two with variegated leaves. We have a score of nurserymen's catalogues, and not two of them describe the Altheas alike. So those ordering them from nurseries, may do it in a plain English tongue, this way: Double white, double purple, double white and purple mixed, double reddish purple and blueish purple; and for the variegated varieties, state, yellow variegated leaved, and the white variegated leaved. These variegated leaved varieties should not be allowed to bloom, as their flowers are insignificant, and their foliage is their real beauty. The plants grow more massy and beautiful when their blossom buds are taken off before they expand.

All the varieties are of thrifty growth upon various soils, and as they bear their blooms upon the young shoots of the same year's growth, they never fail in giving an annual profusion of blossoms. They are very tenacious of life, and withstand severe pruning; they grow fifteen feet high when set singly upon rich soils, but *ten feet* is high enough; so in pruning them in winter, cut them down to eight feet high, and when they bloom, they will be ten feet high. They make very ornamental hedges, which may be clipped down to five feet in winter, and they will be over six feet high when they bloom. In every way the plants are grown, their fading blooms should be cut off to prevent them bearing seeds, as that would make them grow too lean. All the varieties will grow more massy and beautiful, and

will live longer if the plants are not allowed to bear seeds. They bloom in August, September, and October. All the blooms do not open at the same time, but keep up a succession of beauty for a long time. When all the double varieties are set in a group, or even set singly near to each other where they are all seen, their beauties when in bloom are greatly enhanced. No arboreal embellishment is perfect without the Althea, as owing to its time of flowering it fills up what would be a vacuum in the blossom of the arboretum without it. It prolongs the bloom until such trees and shrubs as bear ornamental fruits show themselves to advantage; thus making a continued chain of beautiful blossoms and showy fruits in the arboretum for ten months in the year.

The greater number of species of trees and shrubs produce their blossoms and sweet perfumes in spring, and each species tries to outvie all the others with its attractive charms. The Althea is master of its own mind; does not compete with any other species, but bides its time, and husband its vitality, and in its own time, it illuminates the arboretum with blossoms of splendor, when most needed, and at the time when all the spring beauties are exhausted and hang their heads in despair; it seems so sensible of its value and worth. We append to it the following lines from the "Ploughman Poet,"

"The man o' independent mind  
Is king o' men for a' that."

---

### EGG-PLANT SEED.

BY MR. WM. SELTER, BARDSTOWN, KY.

Seeing Mr. W. L. Aker's communication in the last number of the *Monthly* in regard of his experience with his Egg-Plant Seed kept under a different temperature, I thought to give you my experience in a similar case, with the pea, which is naturally a more hardy seed than that of the Egg Plant. On the 15th of April I planted two rows of the Eugenie close together. The seed or one row was kept during winter in a warm room, that of the other in an empty stable, perfectly dry, but exposed to the severe cold. Previous to the cold both seeds were in the same pot. Now the peas in the row which had been kept in the warm room came all up very vigorously, while in the other row only a small part came up and thus looks very weakly. As Mr. Akers supposes, there must be some influence of the temperature on seeds while laying in a dormant state.

## TRANSPLANTING TREES.

BY MR. J. H. CREIGHTON, DELAWARE, OHIO.

A tree will transplant very much better and grow with more certainty if dug when the ground is very wet, and if it is a valuable tree it pays well to wet the ground the day before digging.

Almost any evergreen will bear transplanting and will do well if shaded the first summer. No one would believe the difference till they try it.

There is no trouble about transplanting large trees, if you take two or three years for it. We have tried it on pear, which is the hardest to move. Dig three-fourths up and then fill up the place till another year; or if a very big tree take still another year. This saves labor, for then not so much digging is necessary.

Plants started too early in the spring get a check or kind of chill from which they will not recover the whole season.

Trees should hardly be watered at all unless they are mulched, not simply because of the waste of water in evaporation, but the cold produced by the evaporation does about as much harm as the water does good. We often hear persons say they wonder why watering trees seems to do so little good. The reason is that the evaporation produces so much cold that the tree is stopped growing. And then it takes very much more water to reach the roots of a tree than the inexperienced are aware of—so that the single bucket of water does nothing more than make a cold place round the collar of the tree. If the tree was in a strong growing state it could bear it, but it is in as much need of warmth as water.

Mulch prevents evaporation and holds the water till it has time to reach the roots. But when we consider that a barrel of dry earth will nearly hold a barrel of water, we must not think that a single bucket of water will be of much use.

## ORCHID CULTURE.

BY MR. JAMES M. PATERSON, NEWARK, N. J.

Sojourning for a few days recently, among some of the towns upon the Hudson River, I had the curiosity to take some pains to learn to what extent orchidaceous plants now becoming so deservedly popular, and so extensively grown compared with former years, were cultivated among the many country seats, and particularly upon those places keeping up establishments of plants under glass.

Considering the large number of splendid places, old and new, adorning either bank of that noble river, from Poughkeepsie down to New York City—places many of which are noted for their wealth of taste and money that has been expended upon them; upon which stand splendid structures of glass, containing the choicest collection of stove and greenhouse plants—I cannot learn that there are to be found orchids, as collections upon as many as might generally be supposed,—a fact perhaps attributable to their rarity and high price, and to the presumption generally entertained, that they can be grown only in houses specially erected for their cultivation, combined with a knowledge of the requirements essential to their successful growth, that in the previous lack of published works treating to any extent upon their growth or habits, few were possessed of. The increasing taste however for them, with a better knowledge of their nature and requirements, has induced the importation by growers of several of the French and English publications; first among which, and the English standard work upon the subject, as well as the most useful to the amateur, is “B. S. William’s Orchid Grower’s Manual,” a work I notice advertised by Mr. Geo. Such of South Amboy, N. J. Of the many beautiful country seats upon the River, few others perhaps equal in the extent of their collections, both of tropical plants and orchids, that of Wm. Kelly, Esq., of Rhinebeck, kept up with a munificence rarely excelled, it has long borne the reputation of holding the largest and most valuable collection upon the Hudson.

At the summer residence of Wm. H. Aspinwall, Esq., some two miles north of Tarrytown, among a large assortment of plants, some of them very fine, I noticed some really fine orchids, which under the care of M. Carl Regel, showed great vigor and health.

At Yonkers, Alex. Smith, Esq., has under what would be considered rather cool treatment, a number of particularly good *Odontoglossum*, and *Tricopelia*, their unusual growth and vigor proving their adaption to the cold house. He has also some other fine species, to which however, the coldness of the house is not so congenial.

Jacob Hays, Esq., of Inwood, has a very good collection of South American Orchids, principally *Cattleyas*, for which plants he has a special hobby.

Of the commercial growers of Orchids in the vicinity of New York, stand the names of Isaac

Buchanan of Astoria, John Cadness of Flushing, Long Island, and Geo. Such of South Amboy, N. J. Their collections are large, and embrace most of the principal species now considered indispensable in first class collections. Mr. Buchanan's collection is a very large one and particularly rich in Cattleyas. For fine specimen plants, however, showing skillful management, few perhaps excel Mr. James Taplin, Mr. Such's able manager.

There are comparatively few Orchid growers in our own State (New Jersey), and those few mainly in the localities bordering upon New York and Philadelphia. Gen. Perrine of Trenton, has a collection containing some very fine kinds, and there are probably a few others between that place and Philadelphia, the names of none, however, occur to me at the present moment. Jersey City has, during the past ten or fifteen years, held the largest collections and most valuable plants in the State; that of Cornelius Van Vorst, Esq., although not as extensive as many others, probably contained in the same number of plants, more rare and valuable ones, than any other in the country, comprising in great part all the most rare varieties of *Vandas*, *Acerides*, *Saccolabium*, *Phalanopsis*, *Cœlogyne*, &c. This collection, within the last two years has been discontinued, and merged into that of M. Lienau, Esq.

The collection of M. Lienau (also a resident of Jersey City), is the finest and most extensive private one I have ever seen. Of his establishment, occupying nearly an entire block in the heart of the city, fully two-thirds of it, occupied in part by the houses, is devoted to the cultivation of nearly everything rare and beautiful in the plant line. A gentleman of wealth and cultivated tastes, an amateur grower of orchids, and enthusiastic lover of Horticulture, he has, during a residence there of nearly twenty years, spared neither pains, nor expense, in the accumulation of his unequalled collection.

In his grounds I have seen flowering splendidly, the *Lagerstromia indica*, or Crape Myrtle, as it is sometimes called, of the South, a plant fully ten (10) feet in height. Also the white flowering and perfumed *Rhododendron Jenkinsii* (or *Jenkinsonii*). And during the summer months, when the large plants in tubs, as *Rhododendrons*, *Oranges*, immense sized *Lemon trees*, an *Araucarias* are arranged along the walks, and grouped here and there between them, great sized plants of *Pampas* and other grasses with

their graceful plumes; *Cannas*, *Caladiums*, *Crinumms* and *Musas*, with their rank waving leaves, the whole place wears a most tropical like appearance. Seeing it as I have at times, fine specimen plants of *Cattleya Mossiæa*, *Speciosissima*, *Schilleriana*, &c., &c., in baskets in magnificent bloom, hang beneath the dense shade of a *Magnolia tree*, standing within sound of a chattering monkey, noisy parrots, the cooing of doves and the singing of a score or more of canaries, whilst through the foliage of the trees glistened the white roofs of the glass houses; it required no great effort of the imagination to conceive ones-self standing in a garden within the tropics. Of the houses, three are devoted to orchids, one being for East India plants, another for *Cattleyas*, and the third miscellaneous.

The collection of orchids consists of over 1000 plants, among which are to be found, nearly all the rare and valuable named species, besides very many unnamed and entirely new species, collected within the last two years by the wellknown botanist, Roehl. Passing through the houses once or twice within a week or two past, I noticed magnificent flowering spikes of *Phalenopsis grandiflora*, with its large white waxy-like flowers, as well as *Phalenopsis Schilleriana* and *Lowii*. Also *Acerides Fieldingii*, with its beautiful rose colored insect-like flowers. A grand plant, nearly two feet in diameter, of *Cœlogyne asparata* (*Lowii*), with very large spikes of pale yellow petaled and deep chocolate-lipped flowers, filling the whole house with its delicious perfume. Numbers of *Vanda tricolor*, *teres*, *sauvis*, &c., together with many rare and fine varieties of *Acerides* and *Saccolabiums*, partly coming into or passing out of bloom. Of *Cattleyas* there are no end to the varieties. Also noticed in bloom *Epidendrum vitellinum*, with flowers of deeper orange—*Epidendrum ionosimum*—*Leptotes bicolor*, one of the prettiest little orchids I have ever seen grown to the perfection in which I saw it.

*Phaius Wallichii*, with six spikes of its splendid flowers; *Uropedium Lindenii*, with its wonderful tail-like petals, nearly 15 inches long. *Dendrobiums*, *Calceolaria transparentis*, *Farneri*, and *fimbriatum oculatum*. Also *Warszewiczii cochlearis*, which I have been told is not yet to be found alive in Europe. And so I might go on noticing a hundred others in bloom, of these most interesting plants, a class of plants of almost every possible size and form, of every hue and spot and combination of color, from their

very natures, always likely to be comparatively rare, yet so beautiful and endless in their varieties, as to keep up in the grower of them the interest always attaching to the cultivation of uncertain bloom, in the spirit of emulation excited, and the hopes of something finer perhaps to be realized. It is not wonderful that the cultivation of orchids once engaged in by the amateur, is a pleasure not often willingly abandoned.

#### NOTES ON THE COMPASS PLANT.

BY MR. G. G. HOWARD, IOWA STATE AGRICULTURAL COLLEGE, AMES, IOWA.

In the report of the Department of Agriculture for the months of March and April, on page 149, I see a statement by you in relation to the tendency of the "Compass Weed" to point North and South.

You state that it is noticed only in young plants and when they first come up, since after becoming large and heavy they are moved out of place by rain and wind, and are unable to regain their original position. Now the result of my observation has been a *direct* contradiction to this.

The tendency is not so strongly marked in the *young* plants for two reasons: first, while small, the leaves are very numerous and necessarily much crowded, and therefore cannot grow as they *would*, but as they are compelled. Second, while young and tender, the winds and rains blow and beat them out of position.

When the plant gets large and strong, it will be noticed that the number of leaves is not so great as at first, (a number having died out, hence each leaf has more room, and does not infringe upon the rights of its brother leaves. As the leaves increase in age, their strength also increases and the *old* leaves are enabled to spring back to their North and South position when blowed out of it. Hence, we see the tendency to point North and South more strongly marked in old leaves than in young ones.

[We are much indebted to our correspondent for his kindness in contributing these additional facts in reference to this singular plant. The paper of Mr. Meehan's referred to, was originally published in the Proceedings of the Academy of Natural Sciences of Philadelphia, from which it was transferred to *Nature*, *Gardener's Chronicle*, and other English and German Scientific journals, and from an *abstract* of one of them transferred to the pages of the report of our Agricultur-

al Department at Washington, which, consistently with the time honored practice of American journalism "goes abroad to hear news from home." This system has one disadvantage. When a story starts on so long a run, it often loses somewhat from its accuracy before it gets back; and we have an illustration of it here. There is nothing in Mr. Meehan's paper to justify the quotation of our correspondent, that the Northern tendency of the leaves is noticed *only* in young plants, and when large and heavy, are (all of them) moved out of place, and (none of them) are able to regain their original position. What was said (see *Gardener's Monthly* page 360, volume for 1870) was that the leaves always had this tendency naturally, whether old or whether young; and that, when it was not observed it was to be accounted for by wind or rain or other external causes; which instead of being in "direct contradiction" to the experiences of our correspondent, is singularly confirmed by them.

While on this subject, we may express regret that there is not more care given to catching the real meaning of what another says. It is rare for even the most careful and unprejudiced author to do it properly. Even Mr Darwin, one of the most painstaking and most candid of modern scientists, does not always do it well. For instance, in quoting Mr. Meehan's paper "on the uniformity of relative characters between allied American and European trees," says, the trees referred to by Mr. Meehan were "all growing together in his garden," which Mr. Meehan nowhere says in the paper referred to, and, which was not the fact, though they did grow within a radius of ten miles of one another. This error does not effect Mr Darwin's use of the facts, but some historian might take this second hand statement to prove what kind of trees Mr. Meehan had *growing in his garden*, at the time stated. Again, in Mr. St. George Mivart's recent work "*Genesis of Species*" this very paper on the uniformity of characters, is quoted by this author as one of the severe objections to Darwinism; but it seems evident that Mr. Mivart has not read the original paper, but only Darwin's statement of it. Much the same exists in regard to Meehan's "*Theory of leaf adnation in Coniferae*" given to the American Science Association at Chicago a few years ago, references, not quotations, are being continually made to it; but except in the single fact that the so called "needles" of Pines are not leaves, but branchlets, ideas are attributed to the author which he never held.—ED.]

## CIRCULATION OF HOT-WATER.

BY "TEXIAN," PORT LAVACA, TEXAS.

I see that Mr. Ellis is about to establish a new school of philosophy. In his article on Hot-water Boilers, he says, "a particle of water cannot absorb heat without expanding, and where expansion occurs, is the *evidence of power and force.*" Again he speaks of "water after receiving *power and force* from the agency of heat." Now I know that the conversion of water into steam produces such an expansion as to prove quite useful in driving machinery; but if simple water receives power and force from the agency of heat, then your correspondent should get out a patent for running a light engine with expanded water. According to his theory, particles of water "move up through the agency of heat expanding them, and thereby giving them the power and force to pass up and through (particles of colder water) to the top of the boiler." But just here he fails to explain to us how the particles of cold water come in to fill the vacant place occasioned by this movement. On the contrary, he says that the heated particles of water "press *against* the non-expanded, and compel it to move *up and down in all directions*" If the heated particles press *against* the colder particles and compel them to move in all directions, I cannot see how they can come in to fill vacancy or vacuum, unless they possess a *greater* force and power than the expanded water. I have heard of a battle in a tub, but it may be that the contest is first begun in my washer-woman's boiling kettle—for certainly a commotion is there plainly manifest. If this pressure of warm water against the colder element, is the "force" which creates the current in hot-water pipes, then why not have the return pipe enter the boiler on a level; or if necessity requires it, above the flow pipe; since this power of expansion can compel it to move up and down in all directions?" Here is a new theory, Mr. Editor, for our boiler makers to take hold of.

I would like to ask Mr. Ellis, why does the water in a pump-pipe ascend? My school-book said that it was the *weight* of the atmosphere which pressed it up into the vacuum. Why does a balloon ascend? I did suppose that the weight of the heavier atmosphere, in settling down, pressed it upward. What "power and force" has oil to cause it to move up or through heavier particles of water? In the language of Mr. Ellis, "we must not forget that when the

first particle" of oil "moves up, \* \* \* \* it has much weight against," and yet it rises unaided by the power of expansion. Do not the heavier particles of water sink down, like the weighted end of a balance, and thus press or *push* upward the lighter particles of oil? And could we change all water at the furnace end of our hot-water pipes into oil, and re-convert this back to water at the opposite end, a current would be immediately established, whose velocity would be proportioned to the difference in specific gravity between oil and water, together with the difference in height between two columns, representing these two fluids; and the greater the difference in the temperature of water in heating pipes the greater will be the difference in its specific gravity; and its current will depend entirely upon this fact, in connection with the difference in height between the column of heating surface compared with the column of cooling surface.

In practice, it may not be advantageous to make either of these differences great. It may be a waste of heat to cool the return pipe much; or it may be inconvenient and expensive to use a high boiler. Experience only can determine how much these principles can be modified, and favorable results obtained.

[Mr. Ellis will hardly claim the credit of founding this new school, for some of the best gardeners in England think as he does. Since the discussion of this question was opened in our columns, the *London Gardener's Chronicle* has had an editorial on the same subject, and we were somewhat astonished to find this admirably edited paper holding similar views to those given by Mr. Ellis.—Ed.]

♦♦♦♦♦  
EDITORIAL NOTES.  
DOMESTIC.

*Embryonic Inarching.*—We have on several occasions referred to the fact, that embryos will inarch, and Dr. Masters has shown, in his highly interesting work, *Vegetable Teratology*, that two distinct varieties of Fuchsias united in the embryonic state, produced two distinct kinds of Fuchsias from the stem. Every fact relating to such a subject is of interest, and we give the following from a correspondent of the *Rural New Yorker*:

"I was born and brought up in Herkimer County, N. Y., and there, while a young man, learned to graft the different ways, and was told by the man I served with, if I could get a graft to grow wrong end up it would produce apples without



seeds. I often tried it in cleft grafting, but never could get one to grow that way; but the first graft I whip-spliced grew and did well, and bore apples the third year. But lo and behold, the apples were just like all other apples, full of seeds. The shoots on the scion grew down for a time, then curved and grew up. It was grafted in the top of a bearing tree on a sprout. This tree bore bushels of apples while I owned the place. There is a curiosity in Busti, Chautauqua County, New York—an apple three parts sour, and three parts sweet, done by splitting the buds of two kinds and putting one half of a bud of each kind together. A Mr. Arby Blodgett of that town, worked all one day budding for that purpose, and only got one to live. The kinds were Tallman Sweet and Rhode Island Greening. The sour parts are in ridges from stem to blow and the sweet in hollows.—J. A.

*Schinus molle*.—A correspondent of some paper, the name of which we have lost and so cannot give the accustomed credit, writing from Los Angeles, California, says:

“A favorite shade tree all over this lower coast, and especially a favorite of the Spaniards, is the Pepper tree, *Schinus molle*. A good part of the streets of this city are lined with them. Most of them are young, with a circumference of only three feet or less, and a height of twenty-five, but old trees obtain a girth of seven feet or more. Perhaps the tree resembles the locust more than any other Northern tree, though the long, delicate, and pendent leaflets give it a touch of weeping willow aspect. It is an evergreen, and with its soft foliage swaying in the gentle breeze, is a most lovely tree.”

A curious fact connected with this tree is, that when the leaves are broken to pieces, and the fragments strewn on the surface of still water, they dart about like living things. One can see that this is done by the force of some matter being projected from the severed vessels; but it does not seem to be oil, as no film is left on the water. It is probably gaseous matter. As the plant is very smooth, the name *molle* may mislead some who know that this is a botanical term implying a softly downy nature; but the name is adopted from the aboriginal Peruvian, where the plant is called “Molle,” or as some writers say “Mulli.” The plant is closely allied to our *Rhus* or “Sumac” family, and indeed one of them, the *Rhus toxicodendron*, or poison vine, has been observed to move the fragments

of its leaves in water the same as this does, though not near as freely—very often, indeed, not at all.

*Flowering of Glyptostrobus pendulus*.—Messrs. Parsons & Co., have flowered the Chinese Weeping Cypress,—this is probably the first in the United States. It has been suggested that this tree is probably but a development from our common cypress, *Taxodium distichum*, and that the seed vessels on which the genus has been founded will not probably vary in important points from the cypress, than some Chinese arborvitae seedlings often vary from one another. Messrs. Parsons will be able to decide this question by facts.

*History of the Nectarine*.—It has been asserted that the Nectarine first originated by a branch springing from a Peach tree; but so many things get into history on doubtful evidence, that for the sake of true science confirmations are generally valuable. A correspondent of the *Rural New Yorker*, L. Merzean, Aiken, South Carolina, has gathered, this spring, a Nectarine from a Peach tree. We have often known seeds of Nectarines to produce Peach, and of Peach, Nectarines, but we do not know of any instance since the original discovery where a sport on the Peach tree direct has been recorded.

*Garden and Farm Culture*.—An exchange feelingly says: “It is sad to relate that when mechanics have land, they generally give better cultivation than farmers; they have more grapes, pears, strawberries, and watermelons, and earlier potatoes and cucumbers.”

This is simply because gardening is a higher art than farming. When mechanics become farmers, they are usually amongst the least successful agriculturists; on the other hand, there are plenty of farmers who, when they care to do a little more than merely “plough up the truck patch,” have pretty good gardens.

*The Cork Oak*.—It is said that the production of cork is very profitable. The thick suberous layers from which the cork of commerce is obtained, can be taken again and again from the same trees. Some years ago the Agricultural department introduced a large quantity of plants. They do not appear to have been successful anywhere except in California. There are trees in Santa Clara County, sown in 1858, which are over 20 feet high, and three feet in circumference.

## BLOOD-LEAVED PLANTS.

BY W. G. A., PHILADELPHIA.

These singular plants are so remarkable in the Landscape, that I thought a few notes in regard to the most desirable might be worth a place in the *Monthly*.

First, and before all, I place the

## BLOOD-LEAVED BEECH,

and perhaps this is the best known of all the class. It is one of the most striking objects possible in the spring of the year. The branches while young droop, and become erect only towards the autumn. As they erect themselves, they lose somewhat of the bronzy lustre which characterizes their growth in spring. The Blood-leaved Beech is a variety of the English Beech. It comes tolerably true from seed. In France and Germany thousands are now raised in this way. Some of the seedlings show a tendency to return to their original State; these are weeded out, and the balance left are the Blood Beeches. Of these again they make two classes, the Copper Beech and Blood Beeches, or as they are a little learnedly called in the lists, *Fagus sylvatica cuprea* and *F. sylvatica purpurea*. These have the one class a lighter, and the other a darker tint,—some preferring one, and others the other. These who have not the means to get seed, graft, and this is quite a delicate business, until the secret is mastered. Hoopes, Bro. & Thomas of West Chester, who work them largely, grow the stocks in pots, and graft them in spring in a greenhouse adapted to the purpose. In a recent visit to their establishment, I noticed that about fifty or sixty per cent were doing well under this treatment; others work them in the open air. For amateurs, however, for whom, at the suggestion of the Editor I pen these notes, the best mode of propagation is by inarching. A few plants of either the American or European Beech may be planted in the spring, near the Blood Beech, and in July or August the branches of the two brought together, and each slightly shaved so as to just penetrate through the bark. These two shaved faces are then tied together, and they unite the same season. By fall, or say next spring, the two may be separated and the grafted plant taken up and set out where it is desired to grow. The demand for Blood Beeches is very great,—much greater than the supply, and hence prices are usually high in proportion to other trees.

Another beautiful Blood-leaved plant is the

## BLOOD-LEAVED HAZEL NUT.

I do not know the history of this tree, though I suppose it is of European origin. The first I ever saw was some twenty years ago, in the collection of Mr. Robert Buist, who could probably tell more about it than I can. Its leaves are quite as dark as those of the Blood Beech, while being double the size, they make a great show. They, however, want the graceful drooping of the young Beech growth. I find one defect in it, and that is that quite large branches will sometimes die just as the pears do by a sudden blight. They become quite girdled by a fungus, when the branch above it dies. Any one can see that this is a fungus, as the spore cases come out in regular rows, like a double set of molar teeth in an animal. I should say that if we could see such an appearance in the bark of a branch struck by the fire blight, no one would doubt the pear disease was a fungus, as this undoubtedly is. However, the disease in this hazel is no great bar to its culture as a bushy shrub, as plenty of sprouts issue below the injured portions, and the plant thus has plenty left for our admiration.

I believe the only way of propagation is by dividing the shoots, or by laying down the growing branches into good rich earth. These often root well the first year; but to ensure very strong good rooted plants, it is best to let the layers stay two years in the ground. I have never known any raised from seed, and so cannot say if they can be propagated this way.

## BLOOD-LEAVED PEACH.

This I have seen only on the grounds of the Editor of the *Gardener's Monthly*, who informed me it was found by Mr. Hatch of Mississippi, or some of his friends, on the battle ground of Fort Donnelson. It is a very rich crimson red, and will be doubtless quite popular, especially with people, who besides pretty leaves and pretty flowers, like something good to eat afterwards. Mr. M. was under the impression that the fruit, though not equal to some of our best varieties, was yet something people would not "care to be without" in the language of some advertisers.

Perhaps one of the grandest things in the way of Blood-leaved trees is the

## BLOOD-LEAVED ENGLISH OAK.

This appears to be a variety of German origin. It has been in this country I believe nearly twenty years; but though in all the leading nur-

series, is still scarce through difficulty of propagation. There are a few in the Central Park, and in the Prospect Park at Brooklyn; but it seems to be getting into general culture very slowly. I believe it inarches very readily on the common English or other oaks. I saw a tolerably strong one this year on some private ground near Philadelphia, in May, and nothing could possibly be more brilliant.

#### THE BLOOD-LEAVED MAPLE.

This has been before the public also for near twenty years; but seems to defy propagation, as I see it nowhere except as "imported" plants. The tint of crimson red is different from any that we have here described, having a sort of winery lustre. It is quoted in European catalogues as *Acer japonicum atropurpureum*, but I believe botanists call it a variety of *Acer palmatum*. The leaves are somewhat like our silver or white maple in outline, but of the winery red tint before described.

These are all the truly Blood-leaved hardy trees or shrubs that I know,—a list far too limited when we consider the splendid material they afford the landscape gardener to work out his peculiar beauty spots in his noble art.

There is one matter in regard to the blood-leaved trees, which, with my limited knowledge of science, seems worthy of some thought by those who are studying Darwinism. As I understand this theory, plants select those changes in form and structure which are the most likely to per-

petuate the species. When we see a change from the normal form, it is therefore to be considered a disease, in which the plant will not grow as well as before; or else it is something which is to help the plant to maintain its existence. Usually, variegation is clearly a disease, because the plants do not grow as well as when in the green leaved condition; but in this blood-leaved state the plant grows better. I think most persons acquainted with the growth of the Blood-leaved Beech will agree with me, that it is much more luxuriant than the common green leaved form from which it sprung. The question suggests itself, why, if this tint is better for the plant, not so much why the Beech has in an isolated case adopted the color, but *why it has not universally done so long ago?* We have always supposed that the green color of vegetation was the color best adapted to the perfect growth of vegetation; but this purple growth seems to "perfect perfection," which stated in these terms becomes an absurdity. I should much like to have some of your readers skilled in Darwinic lore answer this question,—why, if plants have a power of "natural selection," do they not generally "select" a brown instead of a green tint, if this brown tint is more favorable to the healthy and vigorous growth than the green one? Perhaps Mr. Riley, whom I note you quote as an ardent Darwinist, can explain this. [Mr. R. is about so sail for Europe.—ED.]

## EDITORIAL.

### COLORED LIGHTS ON PLANTS.

Some years ago it was noticed in our magazine, that one of our most successful graperies near Philadelphia, General Pleasanton's, had colored glass in some parts of it,—and much of the success of this house was attributable to this glass.

Recently the matter has come prominently before the public, in consequence of an address delivered before the Philadelphia Society for Promoting Agriculture; in which the speaker detailed at much length his experiments with variously colored glass. The result was, that he considers blue glass as being much more conducive to

health than any other. A calf, so weak that its life was despaired of, was made healthy and sound by being kept under glass of this color; and he is sure the great success of his graperies is due to the same thing. One accustomed to reasoning cannot but be struck with the fact that wonderful recoveries from sickness often follow no treatment at all,—and as for fine grapes, General Pleasanton's neighbors, Messrs. Yarnell and David S. Brown, have long been famous for the superiority of their grapes without claiming anything more than has been known to gardeners for generations. This we say, not to suggest that General Pleasanton has had no

success with blue glass, but only that there have not been comparative trials enough to trace the good results entirely to them.

We are acquainted with experiments of a similar character made some twenty years ago. In this case rapid growing seeds were sown in pots, and colored glass put over each. The blue seemed to make a more vigorous growth than any of the others; but after awhile the plants sickened, and were the first to die away. General Pleasanton's blue glass, however, was not wholly employed over the plants, and this is a great difference.

We write to suggest that further experiments on a more comparative scale be instituted. Though these experiments are not, as we have said, entirely satisfactory, there is enough in them to make it probable some good to practical horticulture may come sometime out of them.

In another column a correspondent notices that the purple Beech usually grows better than the common form from which it sprung. We are inclined to think he is right; and this also favors General Pleasanton's idea that these purple, violet or blue tints may be more favorable to growth than any other ones. As to our correspondent's enquiry, why, if this is the best condition of plant growth, all plants are not made with purple or blue leaves, instead of green? We shall leave that to be answered by those to whom the question is addressed. If General Pleasanton or others can prove that *it is a fact*, the why or the wherefore is another matter.

#### DESTRUCTION OF THE COLORADO POTATO BEETLE.

Some years ago, one of our correspondents recommended destroying this terrible enemy of the Western potato growers, by using Paris Green. Now it has become the only remedy. It is, however, expensive, besides being a dangerous and annoying article to use.

We have had no personal experience, for the enemy is not here; but it has often seemed to us that if we were to be plagued by the bugs and grasshoppers on our field crops as our Western friends are, we should try rolling them down. We have tried this thing on a small scale, and with such success that we doubt not good results would follow a wider application. For instance in raising *Clematises* by layering, we are very much troubled by *Cantharides*, which in one night will often make as much havoc as we sup-

pose the Potato Beetle would do. We crush them with any flat instrument, beating them down on the plants, which are very little injured, while the beetles most decidedly are. We suppose the *Doryphora* is no more able to stand these crushing sensations without winking than a *Cantharides* is, and we wonder why somebody don't do it.

To be sure the potato is of softer tissue than the Clematis is, and no doubt much injury would result from a heavy rolling of their stems; but we suppose no more injury would follow than the bug would do; and if it paid the Russians to burn Moscow to get rid of the French; or it was worth Samson's while to pull down the pillars of the temple and send his enemies as well as himself into one common ruin; it would surely be some satisfaction to see the potato Beetle and the potato crop go under together, rather than to see the detestable thing walk in triumph away. So with the grasshopper, why not roll him down, so that the green blades may fatten on his decaying carcass? He would of course try to jump away before your horses; but we guess a few dozen jumps would tire him out. It is a queer thing if a horse cannot beat out a grasshopper. We read that the iron horse crushes so many along the rails that he can sometimes hardly draw his cars along. No doubt the living horse in flesh and blood could do the same thing; and if the roller met the fate of the locomotive, and had to rest awhile through clammung up with the enemy's bodies, the farmer could afford to take a rest for the purpose of cleaning them away.

We do not, however, think rolling would entirely destroy a potato crop, though it would do so for the bug. Many of the stems, though split, would soon grow; while from the base new leaves would soon push to make up for the injured ones.

#### SHELTER FOR RARE TREES.

We trust that as the winter season approaches, our readers will remember what we have several times told them, that hardiness is not so much a question of of temperature as of *evaporation*. Two plants of the same kind may be of the same constitutional hardiness,—yet if one be exposed to wind, and the other sheltered by some screen, though the thermometer shall mark the same degree in both instances, one will die and the other live. The wind drains the plant of its moisture, and it dies by drying up.

Many of our indigenous trees which naturally are gregarious and thus help to shelter one another, become tender when urged to solitary habits. Even the Hemlock and Balm of Gilead are often badly hurt as solitary trees, though native to the locality in groves and woods.

We see continually cases where rare half-hardy trees do well when sheltered, though the general report has had them unfit for general culture. On the property of Mrs. Carpenter, opposite the residence of the writer of this, is a very handsome Deodar cedar well sheltered, while most others exposed have died away. In our own case, our Deodars exposed died many years ago, while one in a low place lived for many years. At that time we supposed it was because it was in the low place that it did so well, and this reason is given in Mr. Sargent's edition of Downing's Landscape Gardening; but we now see that it was owing rather to the slight shelter from wind which the undulation afforded it. As soon as it grew high enough to become exposed to the wind, it died like the rest of its fellows.

We are again with this matter fully before us in consequence of a visit to the superb collection of rare trees on the grounds of Minchell and Jacob Painter, in Delaware county, Pennsylvania. Here is a specimen of *Buddleja Lindleyana*, which has made a dense bush four or five feet high, blooming profusely every year,—while in every other place in Pennsylvania that we know, it gets killed to the ground every winter. The same is the case with the *Callicarpa purpurea*, so interesting by its violet purple berries in fall; here they are in profusion, because the bush never dies back. Among the evergreens was a noble specimen of *Abies Douglassi*, which was

perfect in shape and form, and here, as we say, "as hardy as an oak." As for *Cryptomeria japonica*, which so many find hard to grow, we doubt whether its native country, China itself, could furnish a better specimen than the one here. But the grounds are well sheltered, both by the trees themselves, which are thickly planted together, and by dense woods everywhere about them.

When we think how much enjoyment in the culture of rare trees, fruits and flowers most of us are deprived of who have exposed places, which we might have by planting belts of wind breaking hardy trees, we think we are doing a public service by keeping this subject before the people.

We add a list of those half hardy evergreens, which, we think, if well sheltered from winds, would do well in any part of the country; but which we now rarely see anywhere. *Abies* or *Spruces*: *Alcoquiana*, *Appolonis*, *Cephalonica*, *Cilicica*, *Douglassi*, *Engelmannii*, *grandis*, *Jezoensis*, *Menziesii*, *Mertensiana*, *nobilis*, *Pindrow*, *pinsapo*, *Webbiana*. *Araucaria* *excelsa*, and *A. Cunninghamii*. *Cedars* of *Lebanon*. *Cephalotaxus drupacea*, and *C. Fortunii*. *Cryptomeria japonica*; *Libocedrus decurrens*; *Thuja gigantea*; *Thujopsis borealis*; *Cupressus Lawsoniana*; *Pinus insignis*; *P. Halapensis*; *P. pinaster*; *P. monticola*; *P. palustris*; *P. tæda*; *P. patula*; *P. radiata*; *Podocarpus*, all the Japanese species, and the *Yews*, both American and English; *Torreya taxifolia*, and *T. nucifera*, and the *Sequoia gigantea*.

Some of these have perhaps been found to do well even in exposed places; but all will be better if set out in well sheltered ones.

## SCRAPS AND QUERIES.

UTILIZING SINKHOLES.—We give the following from a Tennessee correspondent, because many others may be similarly situated, and we should ourselves be glad of the experience of any one in similar circumstances.

"I want some information upon a subject about which I know you are well informed. I have, however, some hesitation to ask it of you,

because I know from your position, that you are often troubled by similar queries. If I am asking too much, you will cast this sheet aside unanswered. If, however, you will give the information sought, I shall be greatly obliged to you.

I have upon my premises, upon a plain, slightly declining to the north, a sinkhole or depression, about fifty feet in diameter, nearly round,

and about twelve feet deep in the centre, with a growth and uniform declination from the rim. I have conceived the idea of converting this sinkhole into a pit, for raising early vegetables for market. The information I want, is how to do this *best* and *cheapest*.

The plan I have thought of, is about as follows: Set cedar pickets about four feet high upon the rim, bank the dirt from the outside to pickets: set posts in a row, east and west, about two-thirds the distance from the south to the north, then stretch canvass, painted or saturated with oil, from south to north across a pole attached to the tops of the posts, thus enclosing and covering the sinkhole.

Is my plan practicable? *Will it pay?* Can you suggest a *cheaper* and better plan to accomplish my design? Will the canvass give light enough? What kind of canvass shall I use, and how and with what material shall I prepare it, or how can I make a better covering?

If my project is feasible, it strikes me I can grow the hardier vegetables by using a stove in the coldest weather, nearly all winter. I am unwilling to incur the trouble and expense incident to my project, with my own judgment, and therefore ask the decision of one in whose judgment I have more confidence.'

[Of course the profit of an undertaking of this kind would depend on the price one could get for the product in the nearest market, the cost of production and getting to market, and the quantity of the article which could be raised on the given space. We much doubt whether any one could do much with oiled muslin or anything short of glass, as early vegetables want much light; but as we said before, we should be glad of the actual experience of any who has had experience.]

**BLISS' STRAWBERRY SHOW.**—We regret that we did not get notice of Mr. Bliss's show, time enough to call attention; though the advertisement appeared in our last. These meetings are always interesting, and we like to do all we can to aid them.

**TRITOMA UVARIA.**—This magnificent plant is one of the best adapted to our summers that has been grown for some time. It is a native of Southern Africa, and though hardy, is best taken up and protected with a little earth in a cellar. The flowers are said by some people to

resemble "red-hot pokers" or "sky rockets;" but, however, that may be, he or she is to be envied who has the chance to put a stick down beside one in August or September when the garden is gay with them.

**SOWING NORWAY SPRUCE SEED.**—An Omaha correspondent asks us to give, in the *Monthly*, instructions for raising Norway Spruce seed. It is so easy to raise these, and all other evergreens, no elaborate instructions are needed. They simply need shade. Corn stalks or brushwood laid on tolerably thick, as soon as the seeds are sown, and kept on during the first summer and winter, is really all the secret there is about the matter.

**BIGNONIA GRANDIFLORA.**—*M. P., St. Louis, Mo.*, says: "I bought, of an agent, a plant of this at a big figure, last fall. I am now told it grows wild about us here in the woods. The leaf does look the same. How is this?"

[The *B. grandiflora* is the Chinese trumpet vine, larger flowered than your wild one, which is *B. radicans*.]

**APPLE TREES ON RIDGES.**—*H. B., Fort Howard, Wis.*, writes: "Last spring I purchased a property here, and wish this fall to set out an apple orchard, which I believe will do well in this part of the country, which is the southern point of Green Bay. One of the older settlers here has a very promising orchard, which is set on a plan I have never seen before. The land is thrown up into ridges, and the trees set on them. At present the trees look very well, and if this were the end of them, I should not hesitate to do likewise; but when they come to bear fruit, and of course will have to draw on the earth for the wherewith to make so much cider, I should think these banks would prove to be too dry, and thus much of the fruit fall before maturity. What do you advise?"

[We should not hesitate to trust the banks. If there has been the success in growth which you state, it will bear out in fruit also. It is a good thing to have the feeding roots—fibres—near the surface,—high and dry,—the deep roots—tap roots will bring up the moisture from below when the bearing time arrives.]

MANURING IN THE WEST.—*H. B., Fort Howard, Mich.*, says: "I note that you in the East have an idea that out here we do not value manure. In a ride last spring between Milton and Fond du Lac, I noticed manure was quite commonly used. How different from Ohio, where I spent the last summer! It is there truly wasted."

PROPAGATING ARISTOLOCHIA SIPHO.—"*Cincinnati.*" "Can you tell me how to raise the *Aristolochia siphon*, or common Dutchman's Pipe Vine? I have tried cuttings, layers, and all sorts of ways, but failed in all."

[Let the wood grow all one season. The next spring, before the buds burst, lay down the wood, and in the fall following, they will be rooted. They will not layer from half ripe wood as somethings will.]

WEEPING WILLOWS HATING WATER.—*A. N.*, informs us that a willow, though it may be thirty feet high over water, will send its branches down to within a few feet of the water, but never into it. The branches always stop short of the water.

MAGNOLIA THOMPSONIANA.—An Ohio correspondent says: "Among the newer varieties, I cannot too highly recommend the *Thompsoniana*, it has as yet bloomed only one flower with me. It was splendid. Opens wider than most varieties, but not so wide as *tripetala*; most delightfully fragrant. Hoopes, Bro. & Thomas say of it, resembles the Sweet Bay, but has larger leaves and bloom, and is equally fragrant; bright yellow. *Longifolia* has not as yet bloomed here. *Auriculata* is a fine variety with whitish yellow flowers."

[We quite agree as to the merits of *M. Thompsoniana*. Not quite so sweet as *M. glauca*, the large flowers and fine foliage make it always a favorite. It is said to be a hybrid between *M. glauca* and *M. acuminata*, but it may be but a seedling development independent of hybridization.]

BOUVARDIA DAVISONII.—We are indebted to Mr. Davidson for specimens of this new white *Bouvardia*, which we have before noticed in our columns, and which is to divide popular appreciation with the *B. Virelandii* recently illustrated in our paper. They both resemble one another in those points which make them so valuable;

yet are distinct enough to obtain strong partisans for each.

BLACKBERRY RUST.—*N. H. R., Springfield, Ills.*, says: "The orange colored fungus mentioned by W. Parry, in Vol. 12 of the *Gardener's Monthly*, page 235, and also by Mr. Satterthwait, has been on my Lawton blackberries for 2 or 3 years, and has destroyed the most of the plants. It has also made its appearance on my raspberries, and unless checked, will probably destroy the whole patch. I would be much pleased to find a remedy. If you can suggest one, or obtain it through the *Gardener's Monthly*, I will be much obliged."

[We believe no remedy has been found for this, further than that of digging up persistently all that appear in spring; but we think the best advice would be at once to prepare a new bed of plants in a fresh location, and eventually destroy the old one.

We should be glad to hear from Mr. Parry, who, we believe, has had much experience in its destruction.]

NATIVE COUNTRY OF THE VERBENA.—*Alice M., Lancaster, Pa.*—The garden varieties came from Brazil, where they were first collected by the botanist *Tweedie*. The first introductions were red, and afterwards a white one came, known as *V. teucroides*. Most of our garden varieties are hybrids between these. Mr. Buist of Philadelphia was the first to have garden varieties. There are verbenas all through the American continent, but none so handsome as these Brazilian ones; though some of the Rocky mountain species are not far behind them.

MIKANIA SCANDENS.—"*An old Subscriber, Philada.*"—"Can I get any information through your useful magazine of the *Mikania scandens*. It has a tuberous root; throws up a running vine in the spring, which bears a composite flower of a dull lilac color; no beauty, but a delightful fragrance. It grows wild in Massachusetts. I should like to buy some of the roots, but do not know where to procure them; perhaps some collector of native plants could direct me."

[It is singular that this beautiful native climber has not found itself in our nursery collections. Quantities of it grow in Delaware, and

most likely Mr. Ed. Tatnell of Wawaset nurseries, at Wilmington, can procure plants at a reasonable price. If any nurseryman has it, we will willingly announce it in this column.

**NEW FIRMS.**—Our young men are infusing new life into some of our old firms. Mr. Wm. Barry, son of our well known P. Barry, has, during the past year, taken an interest in the old folk's business, and we hear is pushing things, especially in the way of house plants. Mr. Buist is also fortunate in an accomplished daughter, who takes a lively interest in everything about the establishment. Mr. Peter Henderson's eldest son, Alfred, has also exhibited a good turn for business, through which Mr. Peter Henderson has been induced to form a new firm, Peter Henderson & Co., consisting of himself, Son, and Mr. W. H. Carson, at 35 Courtland Street. Henderson & Fleming having thus dissolved, Mr. Fleming continues the old business at 67 Nassau Street.

**HANSON LETTUCE.**—On our table are three heads from Mr. Dreer of this variety, which some visitors take to be cabbage. It has much the character of the old curled Indian, but is earlier, and with larger heads. We can confidently recommend it.

**NATIONAL ARBORETUM.**—A correspondent briefly tells us that in a recent visit to this collection of trees at Washington, he was delighted with the extent and variety it contained.

**NEW NORTH AMERICAN PLANTS.**—People who are impatient because our leading botanists do not get out a "complete *Flora of North America*," have no idea how many new plants yet remain to be discovered, described and named. Among the results of the somewhat recent explorations of the 40th parallel by King, are over one hundred and fifty new species, collected by the botanist Watson, who proves to be one of the most successful botanical collectors of recent times.

**GRAPE-VINE FUNGUS.**—We shall be very much obliged if any of our readers who may note any curious mildew or moulds on grape vines, either in doors or out, will send specimens to Prof. John L. Russell, Salem, Mass.

**PROFESSOR OF HORTICULTURE.**—Our readers have mostly seen by the daily and weekly papers, that Mr Francis Parkman, one of the most intelligent horticulturists in the country, has been elected Professor of Horticulture in the Bussey Agricultural College of Harvard University.

**PLANT FOR NAME.**—*J. D. C., Evansville, Ind.*: "I have a plant that I got from New York, under the name of *Vere creata*, or tree of life. It is of succulent nature; leaves grown out of a round erect stem in couples opposite, and traversely. I do not know the botanical way of describing plants. The leaf has the singular property of throwing out small plants from the edge. When broken off and suspended in the air, the leaves full grown are about 4 in. by 2 in.; and the flower is said to be crimson. Can you tell me what it is and the proper name?"

[*Bryophyllum calycinum.*]

**ATLANTA AGRICULTURAL ASSOCIATION.**—Mr. Echols tells us this is to open at Atlanta, Ga., on the 16th of October, for five days,—and every effort will be made to make it worthy of the attendance of horticulturists from many part of the Union.

**COMMUNICATIONS AND BRIEF NOTES.**—We are much indebted to our horticultural friends who favor us with their thoughts, opinions or suggestions, from which we can make brief paragraphs, as well as to those who send us from time to time excellent articles for our "communication" page. Every gardener or lover of plants and fruits, can, if they only think so, send us notes of much value. The chapter this month on purple trees, show what can be done when once a man gets over his youthful modesty.

**AMERICAN POMOLOGICAL SOCIETY, MEETING AT RICHMOND.**—In another column we have given the circular of President Wilder in reference to the meeting, to which no doubt our fruit growers and horticulturists will respond with their usual enthusiasm.

We hear from private sources that the citizens of Richmond are doing every thing in their power to make it worth the attendance. We feel assured that those who may be unable to attend this session, will be deprived of one of the most enjoyable horticultural pleasures of the season.



## BOOKS, CATALOGUES, &amp; C.

## IOWA STATE HORTICULTURAL REPORT.

By the kindness of Prof. Matthews, we have the report of the State Horticultural Society for 1869, now for some months on our table. We find in looking through its pages, that the pear and the apple are the most reliable fruits for Iowa. They usually bear regularly. The cherry often does well, but the curculio has the plums here as well as elsewhere. The peach cannot be regarded as a general crop, and grapes are somewhat uncertain, small fruits thrive well. Planting of fruits and ornamentals goes on extensively. Amongst the newer apples, Grimes' Golden, Tetofski, and the Stark are particularly recommended.

Among the essays contributed, is one by Mr. G. B. Brackett, on "Pears in Southern Iowa,"—one by D. W. Adams, on "Fruits of Northern Iowa," one of the very best papers on the subject we have read; a brief one by Hon. C. H. Whiting, on orcharding in Northwestern Iowa; "what apples *not* to plant," by Z. Hollingsworth, which will, we think, meet with an affirmative response in most regards,—but we supposed *Fumeuse* was too good an apple in this region for such a list as this. Mr. Suel Foster has a brief but remarkable paper on "roots of trees." He commenced by remarking "in science it is said that the *spongioles*, that is small, young, tender roots, are the feeders to supply plant food for the tree, and that these fibres are annual, and die off in the winter." Let us consider this, &c. We did not suppose there was any man "in science" or out of it so excessively stupid as to confound a spongiole with a fibre, and think Mr. Foster might have spared himself the trouble of disputing with such a person, even though he did exist. But Mr. F. does not stop here. He asserts that the fibres or spongioles,—for it is not clear but the confusion in these ideas, is his own rather than "in science,"—exhaust the tree rather than help it; and that the tree receives its food through the "spongy bark" on the roots. How the little seedling lives until it gets the "spongy bark," or how hyacinths, tulips, or the thousands of things which never have "spongy bark" get along, Mr. F. does not tell us. Satisfied, however, that he has made some wonderful discoveries, he boldly braves "old and established landmarks in science," and, turning in

utter contempt from the creature, plants both hind feet fair in its breast, exclaiming, as the State report interprets his language, while he does so, "I take the responsibility of rather *altering the books than the laws of nature.*" We should think after this the *books* will not "fear to tread" in the path of Mr. Foster.

Mr. E. H. Calkins has a paper on "making and preparing cider." J. W. Pearman on "propagation or propagating and growing small fruits;" and D. W. Kauffman has an excellent article on "how to plant evergreens, and why they die," which, with his regard for the fibres, must be a terrible shock to "laws of nature." There is one sentence in this essay which should be given to every garden laborer to get by heart. It is "*never for a moment, if possible, allow the roots to be exposed to the influence of the sun or atmosphere.*" Drying is bad enough on deciduous trees, but terrible on the evergreen.

Mr. R. S. Willitt has a paper on hedge culture, which if it gives the most approved plan of planting in the West, is more expensive than the eastern one, which we should hardly expect in such a western subject as hedge planting.

---

THE RURALIST. Published at Cincinnati, and edited by Louis R. Iz.

Issues a German as well as an English edition.

## LOST EXCHANGES.

A notice in our last, that we supposed the *Canada Farmer* was extinct, brings it up again, after a two years disappearance. A whole year's volume, bound, has been placed on our table. We surely need no further evidence that this highly esteemed contemporary has not ceased to exist. We are sorry we had it dead before its time, but it was no fault of ours. Another mystery in the exchange way, is the appearance for the first time on our table of the *Massachusetts Ploughman*. It is Vol. 30, No. 31, and is published at Boston. It might naturally be expected that the last stronghold to stand out against the recognition of a new power, should be located at the "Hub of the Universe." Now that this has surrendered, we feel able to sleep in peace.

## NEW AND RARE FRUITS.

The following list of new Pears we extract from the *Rural New Yorker*:

**PEAR PARDEE'S SEEDLING**—This is an extremely pretty pear, of medium size, with a blush vermilion cheek, and a flesh that, in the specimens before me, rank as "very good." It is an exceedingly juicy pear, and would please most people for eating, while it is not large enough to meet public demand as one of profit in its season.

**BEURRE WORONZOU**.—This, to me, is entirely new, and I have no description of it anywhere. **LEROY** has it not. It may be in **MAS**—whose full numbers I have not. It is a fruit of medium size, obovate pyriform in shape, light, pale yellow, with a multitude of minute gray dots; stem one and a quarter inches wide, rather slender, set in a revolute cavity, with a nob; calyx open, connected, with half reflexed segments; basin shallow and broad; flesh melting, juicy, but astringent, only it is quite—"good."

**SHEPPARD**.—The American variety has been figured in the *Rural New Yorker*, is pretty well known, and needs no remark, except for me to say the specimens received were beautiful, and were in form oblong obovate pyriform, with stalk an inch long, set in a deep acute cavity.

**ST. FRANCIS SEIGNER**.—This is entirely new to me, nor can I find it in **LEROY** or **DOWNING**. It is medium size, roundish oblate, conical, dull yellow, with stripes of red in the sun, from the stem toward the calyx, and thickly dotted with rough dots of medium size. The stem is, say one inch long, set in a narrow, acute cavity. The calyx is small, but open in a very deep, rough russeted basin. The flesh is coarse and merely good.

**COGSWELL PEARMAN APPLE**—A correspondent of the *Western Farmer* says: "The public would like to know, I presume, that the tree is remarkable for longevity. The old seedling sprang into life about 1750. I ate fruit under its branches from 1801 to 1830; and I saw it in 1855. The old head was entirely gone, and it was rejuvenated by lateral branches having struck out vigorously, making a fair head; and was then in good bearing condition, and from

the appearance at that time, I have no doubt it is now at least 120 years old. (Dr. Joseph Fuller, an eminent physician, said when a person could eat a rare-ripe peach, they might eat a Cogswell Pearmain.)

Wm. Cogswell, Norwich, Conn., who owned the land on which the seedling stands, was my father. He caused the apple to be introduced to the world, and for him the apple was named, and for his sake, I have a desire that the true and original name should be retained."

**ETOWAH SEEDLING APPLES**.—We have again been favored with specimens of the Etowah Seedling Apples, grown by Major Mark A. Cooper, of Cartersville, Ga. The specimens on hand are perfectly sound, and bid fair to keep six weeks yet. We think this is decidedly the best flavored late keeping apple we have. It should be extensively planted. We are assured by Mr. Cooper that this variety has not failed to bear a good crop of fruit in the past ten years.—*Rural South-erner*.

**GRAPE LAURA BEVERLY**.—The *Ontario Farmer* says: Laura Beverly, a grape produced by one of the Niagara District vineyardists, is very highly spoken of by Mr. Beadle, horticultural editor of the *Globe*. We have not yet fruited it, but on the recommendation just referred to, it has found a place in our garden

**THE HAAAS APPLE**.—We have quite a number of times seen and eaten this fruit, and have the young trees of this variety. It is really a good fruit. The following from the report of the Minnesota State Horticultural Society, 1871, will be read with interest.

The Haas was first taken up.

Col. Stevens said it is becoming much cultivated. It is very hardy, as much so as the Duchess of Oldenburg. Does well as far north as Anoka; all through the Big Woods, and in fact in most parts of the State, and upon all kinds of soil.

Mr. Waters, of Wisconsin, stated that the fruit was originated, or at least was first brought

to notice in 1804 on the present site of St. Louis. Forty years afterwards the tree was living, and bore thirty barrels of fruit in one season, which would prove its longevity and productiveness. Trees are very thrifty; have always proved hardy in Wisconsin.

Mr. Jordan thought it was not so hardy as the Duchess of Oldenburg; tips sometimes freeze, but never injure the tree. He mentioned instances of orchards dying out—the Haas alone remaining sound and healthy. No tree in Minnesota has given better satisfaction. It should head the list; is of red color, good size, and No. 1 flavor.

Mr. Hoffman said it is a very rapid grower and very thrifty, more so than the Duchess of Oldenburg; had seen many fine specimens in different parts of the State.—*Iowa Homestead.*

APPLE, STAYMAN'S SUMMER.—Fruit medium; weight five to seven ounces; form round, regular, approaching conic; skin smooth, greenish yellow, splashed and striped with red and purple, covered with a white bloom, dots small, grey, scattered; stem medium, rather slender; cavity narrow, deep, irregular, russeted; eye very small, closed; basin narrow, shallow, furrowed; core

small, slightly open; carpels small; seeds small, short, plump, dark brown; flesh greenish white, very juicy, brittle, sprightly, high flavored, mild acid; quality very good; use kitchen table, and market; season August and September. Tree hardy, vigorous, spreading, irregular, tough, wiry; *very early bearer and extraordinarily productive*, droops like a weeping willow, with *ropes of fruit, never breaking a limb.* This tree stands by the side of six hundred varieties, and has come into full bearing at least two years sooner, and has produced more than double the quantity of any other variety at the same age. Flowers very large in clusters standing wide apart, striped red, blossom early, perfect, every blossom setting fruit, but soon after all drop that cannot be matured, those remaining never drop by the hardest wind until ripe

Leaves, large, heavy, dark green; bark dark, glossy, some speckled. This tree has some extraordinary peculiarities that we never saw in any other tree, and the fruit is very nearly equal to Benoni, and Summer Pearmain, but more handsome, and productive, and a much earlier bearer.

Original tree standing on my ground here, nine years old.—J. S., ASS'T ED., in *Pomologist.*

## DOMESTIC INTELLIGENCE.

SURFACE MANURING.—Having tried nearly all of the various modes of using manure, and finally concluded that surface manuring is the best, I propose to give some of the reasons for coming to this conclusion. In doing this I shall only refer to such manure as is made in the stables and barnyards in Western New York, where a large amount of straw and other litter is mixed with the manure.

The first one to discover fully the advantages of surface manuring, was John Johnston, near Geneva, N. Y. This was done accidentally, in this way. Having land badly infested with red root, he manured it early in the fall to induce the red root seed to grow, so as to plow it under in the spring, and thus clear his land of

this pest. But he found a greater advantage in the fact that the succeeding crop was much the best where the manure was thus applied. This led to repeating the experiment several years, and until fully convinced that one load applied to grass or clover in the fall did more good than two used in any other way. Then he wrote accounts of his experience in surface manuring to the agricultural papers. These were at first doubted and disputed; but Mr. Johnston persevered, his heavy crops of wheat, corn and grass being the best evidence he desired. When men doubted the benefits described, he invited them to come and see for themselves. Many went, saw and were convinced; the very heavy crops, for which Mr. Johnston is so widely and

justly celebrated, were evidence that could not be doubted. Many tried surface manuring, and also found it the best course they had ever pursued, and not a few have also strongly recommended this system in the papers.

Some of the reasons in favor of surface manuring are, that nearly all the valuable portions of manure being soluble, are washed out and taken into and completely diffused through the surface soil by the fall rains, so as to be in the best possible situation and condition to be used by the growing plant. And then there is little chance for loss, as when manure is spread, all fermentation stops, and no more ammonia is formed or set free, but the strength of the manure is washed into and retained by the surface soil. The leading agricultural chemist shows that, as Dr. Cameron says, "by a beautiful provision of nature—the absorptive powers of soils—they will be retained until required to nourish the plants." Liebig also states that if "water, holding in solution ammonia, potash, phosphoric or silicic acids, be brought in contact with the soil, these substances disappear almost immediately from the solution, the soil withdrawing them from the water." But perhaps to the practical farmer, the best proof of all is that his crops find the strength of the manure just where and when they want it; that corn, thus manured the previous fall, comes up rank and vigorous, grows better and yields better, than when manured with the same amount of manure in any other way. This I have found to be the case on a heavy sod; but when manure is plowed under it does not do so well. When the corn is small and help is most needed to give the crop a start, the manure is mainly out of reach, and the corn, if on sod, looks rather yellow and poor; and it is said that it must have time for the sod to rot, and for the roots to get through to the manure, before the crop can do well. Besides, when covered up by the furrow, the rains do not as readily reach and dissolve the manure, and spread it all through the surface soil, where it will be found and taken up by the roots of plants. Hence there is no way in which manure can be as thoroughly diffused through the soil, just where it is needed and easiest and best found by the roots of plants, as by surface manuring—unless it be by liquid manuring, and that is but another way of surface manuring.—*Country Gentleman*.

PRICKLY PEAR.—"P." says: "In your interesting account of the Cactus family in the

January number, you failed to notice one very valuable property of the plant, viz.: if the leaves are bruised and placed in keetles used in rendering tallow or lard, it will cause the candles made out of the same to be hard and firm even in summer time."—*Cor. of Agriculturist*.

A GIANT GRAPE VINE.—We have received from John S. Coulson, Natchez, Miss., a section of a monstrous grape vine, measuring eight and a half inches in diameter. This almost equals the great vine so often referred to in history, from which the doors of the Cathedral at Ravenna, Italy, were made. If anybody can show a larger grape vine stem than this one from Mississippi, we shall be pleased to hear from them.—*Rural New Yorker*.

GRAPES IN OREGON.—For years we had no grapes in Oregon except the Los Angeles, Isabella, and Catawba, and even the cultivation of these was not very well understood. They failed to ripen except in favorable seasons and locations, and when they did ripen, they were sour compared with the sweet grapes from California. So the people generally came to the conclusion that Oregon was not a good country for grapes, and but few were planted. But in the course of time varieties of the earlier foreign grapes were brought to this country, and were found to do well. The Delaware, Concord, Hartford Prolific, Allen's Hybrid and others of the natives were tried and were found to succeed, ripening their fruit early, and all without the slightest symptom of disease. Since then the planting of vines has increased from year to year, till now almost everybody wants to plant a few vines. At our last State Fair some 50 varieties were exhibited, all well ripened, and of unsurpassed flavor and size. Owing to our cooler climate, our grapes are not as sweet as the same varieties raised in California, but they are higher flavored, and have a great deal more character.—A. R. SHIPLEY, Oswego, Oregon, in *Western Pomologist*.

THE CATALPA.—"Old Settler" is sound in commending the Catalpa for Southern Iowa, both as an ornamental and timber tree. It is a rapid grower, and its timber is fully as durable for posts as our prairie burr oak. In the central and northern part of Iowa, upon the open

prairies, the Catalpa becomes somewhat dwarfed in habit; and while I could not commend it as a timber tree, I would urge its claims very strongly as one of our best ornamental trees for judicious planting upon lawns. Although a native of the States south and west of Virginia, the Catalpa shows a strange capacity for adapting itself to, and becoming wholly acclimated upon our most open and exposed prairies in Benton and adjoining counties; and perhaps it may do well even up to the Minnesota line. With us, if the seed is brought direct from the South, the seedlings are sure to winter kill more or less. But the plants grown from seed matured here at the North, are as hardy, so far as I can see, as the Scarlet Maple, and even more hardy than the White Maple. In the fall of 1869, the unprecedented October freeze injured scarcely a terminal bud upon our seedling Catalpas, though killing outright many of our trees of White Maple. The very fact that it does not grow as large in size of tree as at the South, is a strong argument in favor of the Catalpa as a Northern lawn tree.

For the benefit of those not acquainted with this beautiful tree, I will state that its leaves are very large, often seven inches broad. The blossoms, like those of the Horse Chestnut, hang in massy clusters beyond the outer surface of these huge leaves, and their delicate white color sprinkled with violet in contrast with the dense pale green foliage, forms a feature of which any homestead may well be proud.

The flowers are succeeded by numerous long, slender, nearly cylindrical pods, often fully one foot in length, hence the name "cigar tree," which is in some localities the common name.—  
JOSEPH L. BUDD, in *Iowa Homestead*.

**APIOS TUBEROSA.**—We received a few days since, from Rev. W. A. Drew—who as editor of the *Rural Intelligencer*, wielded a vigorous pen for the cause of improved agriculture and rural economy in our State—a few tubers of the *Apios tuberosa*, "the native 'bread fruit,' which with 'faith and clams' crowned the starvation boards of our Pilgrim Fathers during their first summer's residence in Plymouth." While it is quite pretty as a climber, and makes a good screen to keep out of view unsightly objects, it may be found somewhat troublesome, from its under ground tubers spreading where it is not wanted. Concerning this "staff of life" of the Pilgrims, Bro. Drew writes:

"The *Apios tuberosa* is indigenous to the Middle States, but not found, as I am aware, north of the Old Colony, whence some years ago I obtained the seed for cultivation in my garden. At first sight, you will pronounce the tubers good sized potatoes or artichokes, which they do, indeed, very much resemble; but really they belong to the *ground nuts* (Pulse family.) They are, however, of a different species from the little tubers of that name which are found growing wild in our Maine forests. These, ordinarily are not larger than a ladies' thimble, and are of insignificant value; but the *Apios tuberosa* grow to the size of potatoes, and baked, are as farinaceous and palatable as that important edible. Doubtless they answered a tolerable substitute for bread, before our forefathers could raise their first crop of corn or grain. Out of some curiosity, some years ago, I planted a few of them in my garden. It is an annual plant, but the tubers live all winter in the soil, and multiply the next season. The nuts are traced upon strings under ground, several feet in length, and the tubers, like egg-shaped beads, are hung along the line. The top is a vine or climber, like a hop, and will cover quite an arbor or trellis with their verdure and bloom. The flowers are ornamental, of a purple and green color in clusters, somewhat resembling the lilac, and are pleasantly fragrant. They are very pretty growing around a window, or climbing, like 'morning glories,' at the sides of front doors.—*American Farmer*.

**CHERRIES AT DR. HULL'S.**—It was our misfortune to be unable to meet several of the horticultural celebrities of the West at the residence of Dr. Hull, our horticultural editor, at Alton, last week. It was in the height of the sweet cherry season, and we know from the following extract from *Colman's Rural World* that we missed a rare treat. The paper mentioned, among other complimentary things, says:

"Finally we arrive at the cherry orchard. Oh what a glorious sight! The light and dark red fruit peering out from a mass of deep green foliage in clusters of from twelve to twenty all along the stem, or, in common parlance, hanging in perfect ropes. All present had the freedom of the orchard, and the Doctor would every now and then call attention to a variety more desirable or riper than the one just tasted. Two

years ago we thought the fruit delicious, but of our recent experience we can only say, that language is lame—what is the use of piling up adjectives? No one said touch not, taste not, handle not—so we did all three, and more than this. If our readers are not satisfied with the description they can fill out the picture according to their own liking—we plead want of words.

“The following are the varieties noted, though we think not all the sorts the Doctor cultivates. The most highly esteemed is the Gridley, not ripe at the time of our visit; next the Transcendent or Elkhorn; third the Black Bigarreau of Savoy, a meaty, sweet and most delicious fruit. Knight's Early Black, contrary to our expectations, was not ripe, which shows this tree to be somewhat capricious. Black Tartarian is a fine cherry, but a rather tender tree. We believe these are all the black sorts. Of the yellow kinds we place Gov. Wood at the head for quality, but it is too tender of skin to carry well to market—Belle de Choisey open to same fault (if yet it be one.) Yellow Spanish, Bauman's May, the earliest of the lot, Elton, Belle Magnifique, May Duke, Black Eagle, Napoleon Bigarreau,

Arnden's Whiteheart, Oxheart and Downer's Late. We believe this completes the list. How any one can visit this orchard and not determine to raise sweet cherries, we cannot understand. The want of money and the lateness of the season is all that hinders us from setting out in the enterprise immediately.”

Notwithstanding our inability to fulfil our engagement to be present, we accept the Doctor's kind apology in the shape of a box of the most perfect specimens of Black Bigarreau of Savoy, Belle de Choisey, and Napoleon Bigarreau, we have ever eaten. They were sent through the agents of the Doctor in this city, Messrs. Newhall & Stewart, who showed us the returns of the sales of many bushels of this delicious fruit at the rate of \$15 to \$18 per bushel. Readers of the *Prairie Farmer* may be assured that its horticultural editor is not a man of undemonstrated theories, but an actual grower of some of the finest fruits of various kinds that come to this or any other market. If any person doubts this assertion let him visit Dr. Hull and be convinced.—*Prairie Farmer*.

## FOREIGN INTELLIGENCE.

NAMING FRUITS.—We have endeavored time and again to induce our fruit authors to give us some system of classification by which we can name fruits with as much certainty as a botanist can name his plants. We are glad to see by the following from the *London Journal of Horticulture*, that the subject is attracting attention also in England. At present, the describing of new fruits is so much printer's ink wasted:

“Botanists, in ascertaining the name of plants and flowers, proceed on the principles of a systematic science. Botany has so arranged and classified all her subjects in their minutest order, that by careful study and observation we may trace out for ourselves the correct name of any which may be brought before us, whether we may happen to have seen the plant previously or not. There are the normal conditions of plants and flowers, the genera and species that

botany tells us of, which are typical and do not vary. These, when once seen and described, can be at any future time recognized. It requires study—profound study, no doubt—but it may be and is accomplished. With the varieties of species there is far more difficulty, and there are few amongst us who will either undertake to name, or expect any one to know, the given names of mere varieties of either plants or flowers. The Editors of our horticultural journals, who seem to know almost everything, do not attempt much with varieties, excepting in the case of a few easily defined forms.

Pomologists, in naming fruits, have but little to guide them. There is no system yet evolved which has reduced fruits to an order by which their correct names may be ascertained. Pomology is a science, and a most intricate and difficult science, without doubt. It is a science,

however, without order, or with but little. It is a science of very close observation and much varied experience—a science the various bearings of which are much better understood than easy to explain—a science, indeed, the whole superstructure of which each one has to erect for himself by close observation, acquaintance, and hard study. There is no royal road to learning it; there is no way of becoming acquainted with fruits or of knowing them, excepting by seeing them, tasting them, examining, describing, and comparing them for oneself. It is only by the most lengthened and varied experience of each individual subject, close observation, and most retentive memory that pomologists are enabled to determine the names of fruits.

Numerous and excellent as are our works on fruits, there is none by the aid of which without previous acquaintance that we can ascertain the name of a single variety. The best work of the Horticultural Society, was its "Catalogue of Fruits" out of perfect chaos. Mr. Thompson did an immense amount of good service by his classification of fruits, so far as it went, and his short descriptive notices of them. Dr. Hogg also, the leading pomologist of the present day, has done, and is doing, much to extend our knowledge of and acquaintance with fruits. His "Fruit Manual" is the very best guide we can have. We are also favored in various ways by minutely descriptive notices, outlines of the fruits, and even colored illustrations, and yet—look at them as we may, study, compare, commit the whole to memory if we can—without the previous acquaintance we can by no means determine the name of a single specimen. It is only by a work of years, by a long and patient study of fruits in all their varied forms, under all their various circumstances and conditions, that one can gain a true knowledge of fruits and their correct names.

Take any one class of fruit; they are mere varieties, the one of the other, each possessing its own peculiar and distinctive features and character it may be, but they are inconstant and subject to vary very much under altered conditions of soil, situation, &c. There are other varieties possessing nearly the same characteristics, which also vary, so that the two seem to intermingle, and it is almost impossible to distinguish one from the other—that is, supposing our observation is limited in extent. The varieties may be perfectly distinct and easily recognized, if grown under similar conditions, and when seen in quantity, it is also

a simple matter to distinguish. Take, as an example, of Apples, the well known Blenheim Orange, and another Fearn's Pippin: no two Apples in what might be termed their normal condition could be much more distinct, and as we have them described, they seem to possess no possible relationship, yet there are grown hundreds of bushels of Blenheim Oranges of the low flat form which it is most difficult to distinguish from Fearn's Pippin. The Blenheim orange is at times small, flat, highly colored, and dry; sometimes it is large, upright or conical, pale and juicy. The two forms may be found in the same garden, even on the same tree. Sometimes it is the soil, sometimes the season, a little good or bad cultivation, the influence of the stock, or more or less vigor in one branch as compared with another, that will effect all this difference which one who observes alone can tell. There is no book which can afford this information. Given—a flat form of Blenheim orange, if the observer has never seen the variety in that particular form before, there is no means at his command by which he can ascertain the name. It has simply to be arrived at by reasoning on previous observations and acquaintances, or by a reference to actual specimens. Reference to specimens assists greatly in determining, or rather in deciding, the correct names of fruits; yet if the variety is entirely new to us, it is extremely hazardous to identify it by this means alone.

Fruits, however, have certain normal features which do not alter, or but little. In forming our acquaintance with fruits, it is needful to mark these, and so have them well fixed on our minds.

There are other features which, being affected by cultivation and other circumstances, vary considerably; these must be taken into consideration as changeable. If we take Apples and Pears for example, the parts of the fruit which are fixed in character, and which may be pretty well relied on as distinguishing marks, are the stalks and the eye; these then should always be preserved uninjured. The size of the fruit is affected by cultivation; the flavor and consistency by the same cause; the color by exposure; and the shape is also at times altered, but more rarely. Some fruits are much more subject to variations than others, some are very uniform, such as the Golden Noble Apple, the one larger than the rest, but no other variation. There is, however, with most fruits some characteristic feature, some little peculiarity which may be noted,

and which serves as a mark for its recognition—as in the Keswick Codlin Apple, the peculiar sharp rib or angle down one side, not existing on all, but on three parts; or in the Kerry Pippin Apple the short slender stalk, and the little knob at one side of its base; or in the Lemon Pippin, the shape of a Lemon, but not always or in every example. Or take the Hoary Morning, which is beautifully striped, with its thick coat of white bloom as if it had been out in some hoar frost, although this feature is at times altogether wanting; or Dumelow's Seedling with its beautiful transparent skin, its wide open eye, and acid flesh, and there is no mistaking it. Take also amongst Pears the Vicar of Winkfield. Who that has once had its peculiar twisted, squinting look—the eye looking one way and the stalk the other—pointed out to him, can again mistake it? Again, look at Knight's Monarch—round, with its short thick stalk, thick leathery skin, and the crimson shade beneath the russet; or Beurre d'Arenberg with its stalk on one side, and the small eye frequently wanting entirely, like Winter Nelis in this only, entirely different in other respects. We know Beurre de Rance by its shape, eye, long stalk like a peg, and green flesh; Urbaniste by its pale green skin, its soft silky feel, and its small eye; Napoleon by its bright green color and peculiar shape, as if it had been squeezed out by the pressure of one's hand. Nurserymen know their trees by the leaves and habit of growth better than by the fruit. Some varieties are very distinct. Josephine de Malines Pear is easily known by its small, full, round buds and yellowish eye. The varieties of Peaches are distinguished not so much by the fruits themselves as by the flowers and leaves, or the glands on the leaves, &c.; and so on.

We thus by close observation and long intimate acquaintance acquire a knowledge of the distinctive features and peculiarities of many fruits. We know some by one feature, some by another; some by taste, others by shape or form, and others again by a peculiar mark or color. We know many, perhaps, without knowing why or being able to impart the same knowledge to others. Constant association with keen observation, will make one an authority on fruits, whilst no amount of study without association will do so.

The naming of fruits is no light task therefore; it is a special acquirement to be able to do so to any extent. There are many who can tell

the names of the few he may himself cultivate, but in general a knowledge of the names of fruit is necessarily very limited. We had a Robert Thompson and we have a Dr. Hogg, but who is there besides? We have fruit-cultivators in plenty, but where are our fruit-nomenclators, if we except the worthy Doctor? Seeing that it is only by acquaintance, by a reference to true examples of each variety, that a knowledge of fruit can be acquired, it is most important that the Royal Horticultural Society should still maintain its splendid collection of fruits as examples. In the re-arrangement of the garden I hope that this point will receive due attention. It is the most important function to the Society to keep up a correct fruit nomenclature throughout the country.

The editors of our horticultural journals deserve much credit for their persistent endeavors to correct the names of fruit. Every week we see a long list of names given: what a time it must occupy! what a patience is required to wade through basket after basket of fruits, many of them possessing no characteristic feature! Senders can surely have little idea of the labor required and the time to name forty or fifty sorts of fruit. It is expecting too much of good nature. Having had some experience of work of this sort I speak without restraint. Senders of fruit to be named should bear in mind that the namer has no knowledge of the circumstance under which the fruit has been grown to guide him, so that mistakes will frequently occur. The specimens selected to be sent, should be as characteristic of the whole bulk as possible, neither too large nor too small, and if two distinct characters are found, some of each should be sent. With Apples and Pears the stalks and eyes are required, and sometimes the leaves; with Peaches the flowers and leaves; with Grapes a bunch and leaves, and the more of any variety sent the easier it is to determine the name. It is altogether absurd to suppose that any one is capable of naming correctly small and deformed fruits. The greatest authority on fruits after all only knows a few well-defined forms in the great and extensive family of fruits. There are hundreds of fruits, especially such as apples, strawberries, &c., throughout the country which have no recognized names. In one locality they are by one name, and in another something else. To this, each year, are added seedlings more or less distinct, all multiplying and confusing the already too numerous varieties of fruits, and mak-



ing it more and more difficult to give the name of any with certainty

**VITALITY OF ROOTS.**—The *Gardener's Chronicle* says: "Mr. Fish send us an interesting illustration of the fact that Vine roots will live and grow for a period of five or less years without any top growth at all:

'In the specimens sent there are a dead root and a living growing extremity. The living portion received nothing through or beyond the dead portion. Neither along the entire distance between the two—which, in the case of the specimen with the upper portion tied on to the under, was at least a yard—has a shoot or leaf of any kind been produced. The roots, nevertheless, were in active growth with abundance of spongioles feeding apparently in the usual manner. The discovery of the large specimen sent was in this wise. A set of old Muscat vines, which were prized on account of family associations, were transplanted into a new border six years ago. It is my practice at this season of the year to remove the worn-out surface soil and replace it with new. This season the renewing process was carried deeper than usual. In removing the earth we came upon the largest root sent. It seemed in splendid condition, rooting away as one likes to see them do, but by the removal of the earth its main branch was laid bare; and my disappointment and astonishment were great when I found that it terminated in rotteness; and I believe that the connection must have been severed soon after the vines were transplanted. During the process of removal several of the roots looked somewhat suspicious. Many were cut off, but all that seemed to have a chance of living were left. This is doubtless one that refused to profit by its chance of new life. On examining the rotten portion, you will, I think, come to the same conclusion, that it has been dead many years. [Yes] But I have more positive evidence to offer on that head. Five years ago we resolved to renew another house of vines. The portion of the border next the house was taken out, the new soil introduced, and a brick wall built up between the new border and the old. A few days since part of this wall was removed to see if further extension was necessary. It was not. But outside the wall plenty of old roots were found, and in full growth like those sent. They were all unattached, and had made no attempt to form tops.'

We do not remember to have heard of a precisely similar case before in vines, though every one must have observed how long the vitality lasts in the roots of trees left in the ground and severed from the top. The fact is somewhat analogous to that of the subterranean tubers of some Orchids, which increase and multiply below the ground for years without putting up a leaf. In the case of Fir trees, the stumps of which are said occasionally to increase annually by the formation of woody rings, Goepert has traced a junction or "anastomosis" between the roots of the stump and those of adjacent perfect trees.'

**DIELYTRA SPECTABILIS FOR THE CONSERVATORY.**—This elegant growing plant is scarcely at home in the herbaceous border, because in exposed situations it is very frequently injured by the spring frosts; and the rough winds also do it considerable mischief when it is in full flower. For conservatory decoration it is unexceptionable, and so easily managed that the merest novice may take it in hand without experiencing the slightest fear of meeting with a failure. The plants are grown entirely in the open air during the summer, and as we require about two dozen we grow three times that number, which enables us to give every plant a rest every second year, and also renders it unnecessary to pot up in the autumn any but strong shoots. The way we shall deal with our stock in a few days will be as follows: we shall dig up all the plants in the border, and select the best twenty-four and replant the others again. I generally select for potting roots with about six crowns, and put them in eight or nine inch pots, as these are the most useful sizes. Of the rejected roots, all that are larger than those potted are divided into two or more, and the smaller ones are planted intact, but we never plant more than the regular number. When the forced ones come from the conservatory in the spring, they are carefully hardened off and turned out of the pots and replanted by the side of those left over at the autumn potting. The border set apart for this work has an annual dressing of manure or leaf-mould, and is dug up rather deeply at the same time. The most essential conditions necessary to ensure success with the plants when in the forcing house are to start them in a moderately low temperature, place near the glass to prevent the foliage being drawn, and to supply

liberally with tepid water when in full growth. The compost used for potting purposes, should consist chiefly of turfy loam and leaf-mould, with a dash of sand to make the soil feel gritty.—J. N., in *Gardener's Magazine*.

GOOSEBERRY SHOW AT AKROYDON.—The second annual gooseberry show, in connection with the New Town and Booth Town Allotment Gardens, was held at the house of Mr. George Wood, Flying Dutchman Inn, Akroydon. It was a complete success, and reflected great credit on the exhibitors. The heaviest gooseberry, weighing 20 dwts. 3 grs., was exhibited by Mr. Thomas Murgatroyd. The first prizes in each class, with the weights of the gooseberries shown, were the following: Red gooseberries, 16 dwts. 17 grs., Mr. John Clayton; white ditto, 12 dwts. 6 grs., Mr. John Clayton; green ditto, 14 dwts. 15 grs., Mr. Thomas Watson; yellow ditto, 15 dwts. 7 grs., Mr. John Clayton; best pair of twins, 19 dwts. 80 grs., Mr. John Clayton. The other prize winners were Messrs. J. Clayton, T. Murgatroyd, T. Watson, T. Barrett, and James Greenwood. One or two fine specimens were exhibited for non-competition by Messrs. Richard Parker and William Town. Mr. Samuel Sutcliffe of Ovenden, officiated as weigher, and gave general satisfaction.—*Gardener's Weekly*.

Study economy in the means you use to grow everything. It is impossible to be too careful in this matter.

GREENHOUSE AND CONSERVATORY IN AUGUST.—The pot Roses intended to flower in the conservatory late in the autumn should now receive whatever pruning is necessary. All those which require a shift should have it forthwith, in order that they may have their pots full of healthy roots by the flowering period; this, and the application of liquid manure, together with a sweet and mild atmosphere, will perform wonders. After these operations they should be placed in some open and airy spot, and if plunged in ashes they should be frequently turned, or the interior of the pot will be without fibrous roots. Give them regular waterings, and persist in picking off all blossoms buds as they appear from those required to blossom in November and December. Let the Camellia buds have a thinning as soon as possible. Look out and encourage a lot of good things for a late autumn display. Fuchsias and Achimenes in succession, and even choice Verbenas in somewhat thick masses in wide-mouthed pots, will add to the general effect. Remember that all those plants required to blossom in midwinter must have their final shift betimes. There is no success in forcing, or even retarding, without a plentiful of roots.—*London Journal of Horticulture*.

## HORTICULTURAL NOTICES.

### AMERICAN POMOLOGICAL SOCIETY.

In conformity with a resolution adopted at the last meeting of this National Association, the undersigned hereby give notice, that its thirteenth session will be held in Assembly Hall, 8th Street, between Grace and Franklin Streets, in the City of Richmond, Virginia, on the 6th, 7th and 8th days of September, 1871. All Horticultural, Pomological, Agricultural, and other kindred institutions in the United States and British Provinces, are invited to send delegations, as large as they may deem expedient; and all other persons interested in the cultivation of fruits are invited to be present and take seats in the Convention.

The coming session promises to be especially interesting, held as it will be in conjunction with the exhibition of the Virginia Pomological and Horticultural Society, and at a great central point, farther South than any previous session of the institution. This meeting will therefore, it is believed, be one of the most useful in a national point of view that has ever been held by the Society, thus affording an opportunity not only to examine the fruits of the South in comparison with those of the North, the West and of the Pacific Slope, which it is expected will be freely contributed, but also to foster and perpetuate the amicable and social relations which have heretofore existed between the members of the Society, and to widely diffuse the result of

its deliberations for the benefit of our constantly expanding territory.

The climate of Virginia and adjacent States is believed to be admirably adapted to the culture of fruits, especially the pear, the grape, and the strawberry. It is therefore hoped that there will be a full attendance of delegates from the South and West, as well as from other quarters of our country, thereby stimulating more extensive cultivation upon which the North are so largely dependent for early supplies; thus also, by the concentrated information and experience of cultivators, to aid the Society in completing the Second Division of its Catalogue of Fruits, being that part which pertains especially to the Southern States. This will be one of the prominent subjects which will come before the Society, and we therefore respectfully invite the various State and Local Committees to report to P. Barry, Chairman of the General Fruit Committee, agreeably to the constitution of the Society, such information and lists of fruits as may aid in determining what varieties are best adapted to their several localities. These reports should be transmitted by mail to F. R. Elliott, Secretary, Cleveland, Ohio, as early as possible.

Arrangements have been made with the various railroad companies, terminating in Richmond, to return all members and others free of charge, who have paid full fare in coming, and who exhibit certificates of the Treasurer that they have attended the sessions of the Society. Similar arrangements can undoubtedly be made by the various delegations, with roads in their localities.

Members and delegates are requested to contribute specimens of the Fruits of their respective districts, and to communicate in regard to them whatever may aid in promoting the objects of the Society and the science of American Pomology. Each contributor is requested to prepare a complete list of his collection, and to present the same with his fruits, that a report of all the varieties entered may be submitted to the meeting as soon as practicable.

Packages of Fruits with the name of the contributor, may be addressed as follows: "American Pomological Society," care of H. K. Ellyson, Secretary Virginia Horticultural and Pomological Society, Richmond, Va.

All persons desirous of becoming members can remit the admission fee to Thomas P. James, Esq., Treasurer, Philadelphia, who will furnish them with transactions of the Society. Life

Membership, Ten Dollars; Biennial, Two Dollars.

MARSHALL P. WILDER, *Pres't.*

Boston, Mass.

F. R. ELLIOTT, *Sec'y.*

Cleveland, Ohio.

Premiums to be awarded at the meeting of the American Pomological Society, in Richmond, Va., September 6 to 8th, 1871.

The following premiums are subject to the general rule of restriction, where objects are not deemed worthy of the same. All fruits must be grown by the exhibitor.

The Virginia Pomological and Horticultural Society for sundries offer One Hundred and Fifty Dollars.

The Virginia State Agricultural Society offer One Hundred Dollars for the best collection of Fruit embracing Apples, Pears, Peaches and Grapes.

Ellwanger & Barry, of Rochester, New York, offer Fifty Dollars for the largest and best collection of Apples, not less than fifty varieties, three specimens each.

Marshall P. Wilder, of Boston, Mass., offers Fifty Dollars for the largest and best collection of Pears, not less than fifty varieties, three specimens each.

Charles Downing, of Newburgh, New York, offers Fifty Dollars for the largest and best collection of American Grapes, not less than twenty varieties, three bunches each.

Thomas P. James, of Philadelphia, Pa., offers Thirty Dollars for the largest and best collection of Peaches, not less than ten varieties, of six specimens each.

Gen'l. R. L. Page, Norfolk, Va., offers Ten Dollars or a Medal for the best half bushel of the Flowers Grape.

G. F. B. Leighton, Norfolk, Va., offers Twenty or a medal, at the disposition of the American Pomological Society.

C. D. Barbot, Norfolk, Va., offers Twenty or a Medal for best dozen bottles of Scuppernong Wine.

L. Berkley, Norfolk, Va., offers Ten Dollars or a medal for best dozen bottles of the Flowers Grape Wine.

W. H. C. Lovett, Norfolk, Va., offers Ten Dollars or a medal for best Dried Figs,—cured within the territory of the Society.

Hon. Jno. B. Whitehead, Norfolk, Va., offers Twenty Dollars or a medal for best half bushel of Scuppernong Grapes.

W. S. Butt, Norfolk, Va, two premiums of Five Dollars each or medals,—one for best Figs; the other at the disposal of the Society.

By H. M. Smith, Richmond, Va., Ten Dollars or a medal for the best half bushel of Cider Apples.

By Downward, Anderson & Co., of Richmond, Va, Ten Dollars or a medal for the best 12 bunches of Norton Grapes.

By Chas. T. Wortham & Co., of Richmond, Va., for best 12 bunches of Delaware Grapes.

By S. Zetelle, of Richmond, Va., Five Dollars or a medal for best 12 specimens of Peaches.

By Messrs. Rudolph & English, of Richmond, Va., Five Dollars, at the disposal of the Society.

By Southern Fertilizing Co., Twenty Dollars, at the disposal of the Society.

The above Figs, Grapes, and Wines, entered for premiums, to be the property of the Society, for the use of those members residing in those localities where they are not grown.

The whole amount of premiums, general and special, offered by societies and individuals, in Virginia, has been generously placed by them at the disposal of the American Pomological Society.

It is also expected that other premiums will be added to the above list.

## PENNSYLVANIA HORTICULTURAL SOCIETY.

### THE NATIONAL EXPOSITION OF 1876.

At a meeting of the Pennsylvania Horticultural Society, held February 21st, the following Preamble and Resolutions were unanimously adopted:

WHEREAS, The Congress of the United States having decided that the Great National Exposition of Arts and Manufactures to celebrate the Centennial Anniversary of the Declaration of Independence, shall be held in this City in July, 1876; therefore,

*Resolved*, That the Pennsylvania Horticultural Society hails with delight this decision of our National Congress, and we hereby pledge ourselves that no exertions shall be wanting on our part to make the Horticultural Department of the display fully equal to any other portion of it.

*Resolved*, That the President is hereby requested to appoint a committee of twenty five members to represent this Society, and to confer with similar committees from other Societies, with a view to a concert of action in making the neces-

sary preparations for holding this great National Exposition on the 4th of July, 1876.

*Committee of Pennsylvania Horticultural Society for Centennial Anniversary, July 4, 1876.*

J. E. Mitchell, *Chairman*; Ex-Presidents Caleb Cope and Gen Robert Patterson; Vice-Presidents Robert Buist and S. W. Noble; H. Pratt McKean, M. Baird, J. D. Whetham, Robert Cornelius, Newberry A. Smith, Nath. Burt, J. B. Heyl, Thos Meehan, A. W. Harrison, H. A. Dreer, R. Kilvington, Jas. Ritchie, C. P. Hayes, W. Hacker, Geo. W. Earl, Robt. Scott, J. S. Houghton, E. Satterthwait, Chas. H. Miller, T. J. Mackenzie.

## STRAWBERRY EXHIBITION AT VINELAND, N. J.

The Agricultural Society held their annual Strawberry Exhibition in Union Hall, Saturday evening. The drouth having told fearfully on the strawberries the display was not what it could have been desired, but better than was anticipated.

Luscious Jueundas, from Messrs. D. B. Hinman, P. Snyder, R. Lush, and H. N. Greene, were on exhibition, proving that they can be raised if properly fertilized and attended to, though as yet there is some difference of opinion as to their being profitable to ship as a market berry.

The Agriculturist, by Mr. Paul, like that paper, were fine specimens.

The Chas. Downing, from Mr. Benham, were delicious.

The Wilsons, from Mr. C. S. Mason, showed the effects of drouth, but looked enticing.

Mr. Degroff presented two of the Dr. Nicanor strawberries, the product of one vine—he does not wish to extend his labors in this direction. There is money in the Nicanor, which no one has succeeded in getting out.

The Committee awarded premiums as follows:

Jueunda, 1st premium, D. B. Hinman, 50 cts.

2d premium, P. Snyder, 25 cents.

2d premium, R. Lush, 25 cents.

Agriculturist, Mr. Paul, 50 cents.

Chas. Downing, Mr. Benham, 50 cents

Wilson, R. Lush, 50 cents.

Messrs. Greene, Mason and Paul donated Strawberries which were sold at auction—the bidding was spirited between the contestants, who donated them back to the Society, until the berries brought over a dollar and a half a quart. —*Vineland Weekly*.

# The Gardener's Monthly.

DEVOTED TO

*Horticulture, Arboriculture, Botany and Rural Affairs.*

EDITED BY THOMAS MEEHAN.

---

Old Series, Vol. XIII. AUGUST, 1871. New Series, Vol. IV. No. 8.

---

## HINTS FOR AUGUST.

### FLOWER GARDEN AND PLEASURE GROUND.

It is somewhat remarkable, that with the great love of cool shady spots, which our climate excites in all of us, more attention is not given to making bowers of living trees than is customary for us to do. We have "summer houses" in abundance, but these are seldom cool. If they are roofed, the heat radiated from the under surface makes it very hot, unless the sides are open all around; and if the sides are thus open, the sun at all hours except mid-day, trespasses on our enjoyment. Besides this, as a matter of taste, summer houses, as we generally see them, are sadly out of character in relation to their surrounding. In some of our best parks, where there is indeed a great deal more than mere pretension to landscape gardening, the "summer houses," as they are called, too often mar the effect of the whole thing.

This is not so often the case when a mere bower of living trees is employed to make the necessary shade. The green mass is in keeping with other trees, and the crowding necessary to accomplish the desired shade, can often be turned to the very best account. This is especially the case when weeping trees are employed. The peculiar drooping habit comes into play in numerous ways in the hands of a good landscape gardener. Of the fast growing things of this kind, and where the position is not particularly choice, there are few things more useful than the *Weeping Willow*. For more select places we suppose there is nothing better than the *Weeping Ash*. Indeed, taken all in all, it is one of the best trees of this kind we have. The branches

can be trained over wires, and thus we can make the room beneath the tree as extensive as one could wish. For very large spots, a half dozen or so can be used. Set in one circle, and the trees about twenty feet apart. Such an arrangement would make a delightful croquet ground,—or a place for parties or pic-nics—entirely in the shade, yet with an abundance of room and air all round. The *Kilmarnock Weeping Willow*, if grafted high enough, would make a very pretty shade for one or two persons; but as they generally are, they are not worked over five or six feet high; and thus we have to be satisfied with them as the lovely little ornaments we see on our lawns.

Recently we saw a very pretty thing formed out of half a dozen *Japan Catalpa*—*Catalpa Kempteri*. These seem to grow only from fifteen to twenty feet high, and the branches form a dense mass overhead, appearing in leaf as if the whole surface had been closely sheared. When not too closely confined, the whole stem pushes out leafy branches. A half dozen of these set out by themselves, and trained up to single stems, will make one uniform mass of foliage if left to itself; and gothic arches, or arches of any other form, can be cut between each pair of trees. The leaves around each tree stem can be left two or three feet wide if desired,—and the whole can be made to have a remarkably unique effect.

The planting season will soon come around, and now is the time to look about and select the desirable kinds, and to decide on the proper places to set them.

It may be well to repeat what we have said in

substance before, that the latter end of August is one of the best seasons of the year to transplant evergreens. The young growth of the past season has got pretty well hardened, so as to permit of but very little evaporation,—and the earth being warm, new roots push with great rapidity, and the tree becomes established in the ground before cool autumn winds begin. The chief difficulty is that the soil is usually very dry, which prevents much speed with the operation; and the weather being usually very warm, the trees have to be set again in the ground almost as fast as they are taken up; so that it is not safe to bring them from a distance. It is as well, therefore, to make all ready in anticipation of a rain, when no time may be lost in having the work pushed through. Should a spell of dry weather ensue,—which in September and October is very likely,—one good watering should be given, sufficient to soak well through the soil and well about the roots. A basin should be made to keep the water from running away from the spot, and to assist its soaking in. After being well watered, the loose soil should be drawn in lightly over the watered soil, which will then aid in preventing the water from drying out soon again.

As soon in the fall as bulbs can be obtained, they should be planted—though this will not generally be the case till October,—but it is as well to bear in mind that the earlier they are planted, the finer they will flower.

Towards the end of the month, and in September, evergreen hedges should receive their last pruning till the next summer. Last spring, and in the summer, when a strong growth required it, the hedge has been severely pruned towards the apex of the cone-like form in which it has been trained, and the base has been suffered to grow any way it please. Now that, in turn, has come under the shears, so far as to get it into regular shape and form. It will not be forgotten that, to be very successful with evergreen hedges, they ought to have a growth at the base of at least four feet in diameter.

When White Lilies, or any other spring-flowered bulbous plants have done flowering, and the stems died away, they should be taken up and re-set; the disease in Lilies often met with, is probably caused by their being too long in one place.

Most of what is to be done now in this department consists of the routine duties of neatness,

—tying up, pegging down, removing faded blossoms, collecting and destroying insects, etc.

Many suffer their flowers to produce seed, but this injures the flowering. If it be particularly desirable to save seed of some things, allow only just as much to ripen as will be needed. In some cases, cutting off the flowers as fast they fade doubles the season of flowering.

Auriculas, Polyanthus, Pansies, Daisies, and other of these early flowering, half hardy plants, commence their root growth about the end of this month, when the time has arrived for re-planting. Good fresh, and yet half decayed sod from a pasture field, is the best to grow them in. Those who have the advantage of pots and frames, can re pot also at this season.

#### VEGETABLE GARDEN.

As soon as your vegetable crops are past kitchen use, clear them out. Never suffer them to seed. In the first place, a seed crop exhausts the soil more than two crops taken off in an eatable condition; in the next place, the refuse of the kitchen is likely to produce degenerate stocks. Good seed saving is a special art by itself, always claiming the earliest and best to ensure a perfect stock.

Celery will require earthing up as it grows, to get it to blanch well. It is not well, however, to commence too early, as earthing up tends, in a slight degree, to weaken the growth of the plants. Take care, also, not to let the soil get into the heart in earthing, or the crown is apt to rot.

As fast as Endive is desired for Salad, it should be blanched. Matting thrown over is the best for this purpose, as the plants are not so liable to rot as when pots or boards are employed.

In cold or mountainous regions, Melons are hastened in the ripening process, and improved in flavor, by a piece of tile being placed under the fruit.

Keep weeds from your compost heaps, as they exhaust the soil, and bear seeds for future brow-sweatings.

Sow Lettuce for Fall crop, thinly, and in deep and very rich ground.

Early Valentine Beans may still be sown early in the month,—the soil for a late crop should be well trenched, or, if the Fall be dry, they will be stringy and tough.

Cucumbers, Squash, and other similar plants, often suffer from drought at this season. Cold

water does not help them much, but a mulching of half rotten leaves strengthens them considerably.

Cut down straggling herbs, and they will make new heads for next season.

Towards the end of the month, a sowing of Spinach may be made in rich soil, which will come in for use before Winter. That desired for Winter and early Spring use, is usually sown in September in this region. A few Turnips may also be sown for an early crop, but will be hot and stringy unless the soil is very rich.

Corn Salad is often sowed at the end of this month. It does not do so well in damp soil or low situation.

### FRUIT GARDEN.

In the Western States we believe the fruit crop is not very good. The frost of the 16th of May finished up the business for the season. Strange to say, here in the East, we had the same frost, and yet our fruit escaped. The reason was that the season was remarkably early, and the fruit had really reached a considerable size before the frost came; and it is only when very young that the frost injures young fruit. It is somewhat remarkable that we should have fruit crops good for three successive seasons, and it is highly encouraging to the fruit grower. He must now take care that exhaustion does not follow. The wise orchardist has thinned his fruit at an early stage of growth, and will now be looking round for material to fertilize them with. It is not too late to do it yet to advantage. We should surface dress with manure, compost, or rich materials, any time between now and frost; but the earlier the better. There is not much use in putting it on after the soil is frozen. Rains wash it best portions away. As to kind of manure, it makes little difference. If the surface is not disturbed much, the richer the surface soil the better. We have noticed but little difference between animal manure and mineral. Some of the best and healthiest trees we know, stand near the manure heaps in farm yards.

A little trimming is useful to most trees at this season. The Blackberry and Raspberry may have their tops shortened so as to leave the canes about four feet. Some do this earlier in the season; but the buds are apt to burst if done too soon. In like manner, pear and apple trees that grow well, but produce no fruit, are benefitted

by having, say half of some of the young growth cut back. The buds then left are very likely to form flower buds, in place of growth buds for next season. Many take out the old shoots of raspberry and blackberry after they have done bearing, and we have in times past recommended it ourselves; but on further observation, we see very little good, if not positive injury. The partial shade the old stems make, seems rather beneficial than otherwise under our hot suns.

Strawberry planting often commences in August, providing the weather offers a chance. Get the soil in readiness for this chance. Heavy manuring is not good for the Strawberry except in very poor soils. Wet soils are not good. But the soil cannot well be too deep. In the field subsoil,—in the garden dig at least 12 to 18 inches. Strawberries do better moderately close than too wide, some kinds do very well in beds.

After a piece of ground is dug at this season for Strawberries, roll it well with the garden roller. When ready to plant, make holes with a dibble, fill the holes with water, and when it soaks away, put in your plant which has been kept in water to prevent wilting. *But*, in putting in the plant do not plant too deep. "Too deep" kills 99-hundredths of all the Strawberries that die in the year from transplanting. "Too deep" is when anything but the small fibres are buried under the surface.

In regard to the newer varieties of this season, we are very much pleased with *President Wilder*. Our plants were not strong enough to bear well, having been all transplanted in spring, we cannot, therefore, testify to whether it is an abundant bearer or not; but the size, color and flavor of the fruit, and the remarkable vigor and healthfulness of the foliage, seemed to leave nothing more to be desired in this respect. Moreover, they had the quality of firmness—a point dear to the hearts of all marketmen.

Almost all trees, and in particular the Grape vine, at this season will require attention, to see that the leaves are all retained healthy till thoroughly ripened. It is not a sign of healthiness for a vine to grow late; on the contrary, such late growth generally gets killed in the winter.—but the leaves should all stay on, to insure the greatest health of the vine, until the frost comes, when they should all be so mature as to fall together. Frequent heavy syringings are amongst the best ways to keep off insects from out-door grapes, and so protect the foliage from their ravages.

## COMMUNICATIONS.

## BOILERS.

BY CHAS. F. HITCHINGS, N. Y.

In the June number of the *Monthly*, I find two articles on the subject of boilers and the circulation of water; as the experience and theories advanced in these articles differ somewhat from my own, I propose, with your permission, to refer briefly to the several points.

Mr. Pennock gives the particulars of his experiment with a chip in a propagating tank, to show that cold water in the return pipe causes a quicker circulation than hot, and by his argument conveys the idea that there is more heat imparted by the pipes to the house when the water leaves the boiler at about  $212^{\circ}$ , and returns cold or about  $80^{\circ}$ , than there would if it should leave at  $212^{\circ}$  and return at  $200^{\circ}$ ; and further, that if the water in the return pipe nearly approaches the temperature of that leaving the boiler, there is something wrong in the circulation.

My experience is the reverse of this. I have always found it necessary to make all the pipes hot, including the return, in order to heat a glass structure satisfactorily during cold nights, and that it is both desirable and practicable to heat the water in the return pipe to a temperature but a few degrees below that of the water leaving the boiler, providing the circulation is free and the boiler of sufficient heating capacity. Theoretically, the rapidity of the circulation increases with the difference in the temperature of the two columns of water—one leaving the boiler through the flow pipe, the other entering through the return. But it does not follow from this, that because the water returns to the boiler nearly cold, therefore, the circulation must be quick, or that there has been more heat imparted to the atmosphere of the house; on the con-

trary, it goes to prove that the circulation is defective and sluggish, that the water moves through the boiler so slow, that it attains a high temperature before it enters the flow pipe, and then flows through the pipe so slow as to lose nearly all its heat before reaching the end of its course. If the water returns to the boiler at  $80^{\circ}$ , it is plain that a portion of the pipes through which it passes must be at the same low temperature, and the average heat of the line of pipe must be far below what it would be, if both ends of the pipe were hot; and it is just as plain that pipes at a low temperature cannot impart as much heat to the atmosphere through which they pass, as the same length of pipe would do at a higher temperature.

Again, if the circulation is good and the outlets from the boiler of proper proportions, it would be difficult, if not impossible, to create, as he implies, a difference of  $132^{\circ}$  between the flow and the return pipes at the boiler. Under favorable conditions, water moves freely at any temperature below  $212^{\circ}$ , with a difference of  $4^{\circ}$  to  $10^{\circ}$  between the flow and return pipes at the boiler. The experiment that Mr. Pennock describes, shows that it required a difference of over  $43^{\circ}$  to create a movement in the water through the tank. In all probability the area of the cross section of the tank in which he tried the experiment, is many times greater than the connecting pipes, and that the speed of the current of water which passed through the pipe was diminished in the greater width of the tank and not properly represented by the floating chip; or there may have been some defect in the arrangement which caused a slow circulation.

Mr. Ellis contends that all flue surface in boilers are useless as a means of heating water, and



argues that a portion of the water, which is immediately over the fire, remains there until it has absorbed all the heat from the iron surface that it can absorb, and that, after being thus exposed to the hottest surface, its temperature cannot be increased by contact with surface exposed to the secondary heat, which he describes as heat having less intensity than that which is given off from the fire resting on the grate; this would include all surfaces of whatever form, not directly exposed to the radiant heat of the fire.

The questions occur: What portion of the water is it that remains over the fire until it has absorbed all the heat it can: does it comprise all the water that leaves the boiler through the flow pipe? And what is the temperature of the water that has absorbed all the heat it can? In practice water frequently leaves the boiler at a temperature of 80 to 100 degrees; when this is the case, has that water already absorbed all the heat it can, and is it so hot that its temperature cannot be increased by contact with surfaces heated by secondary heat at a temperature of 600 or 700 degrees?

I take exception to these statements, and claim that where the fire and flue surface in a boiler bear a proper proportion one with the other, the flue surface is of great value as a means of economizing fuel; that a boiler so constructed will heat from a quarter to a third more water, with a given quantity of fuel, than a boiler without flue surface. It is a well known fact that from 25 to 30 per cent. of all the power on every steamship and steamboat afloat is obtained from flue surfaces. Every locomotive on our roads has from three to four times more surface in the flues than in the fire chamber; nearly every stationary boiler is similarly provided. These examples are the result of study, experience and experiments of the best engineers in the world, and it cannot be said that they know so little of the scientific application of heat as to continue to this day wasting material and occupying valuable room with flue surfaces that are useless. But it may be said that flue surfaces are all well enough for steam boilers where the fires are large and the heat intense, but they are of no avail in greenhouse boilers. The answer to this would be, that the primary object of the boiler in either case is to impart the greatest amount of heat with the least quantity of fuel. It is true the heat of the large fire is more intense, but as an offset to this, the water in the steam boiler must be heated to a temperature of 260 to

350 degrees, according to the pressure, while the water in a greenhouse boiler does not exceed 212 degrees, and varies from this to cold water. And when flue surfaces heated by this secondary heat are capable of imparting heat to water at 350 degrees, with sufficient rapidity to create steam, it is evident that the relative value of such surfaces must be far greater when the water which surrounds them is below 212 degrees. Take a familiar form of greenhouse boiler, with *the fire chamber and the flues all within the shell of the boiler, and surrounded with water*, in this the radiant heat from the burning coal is taken up by the iron surfaces of the fire chamber and imparted to the water, the flame and hot gases which escape from the fire chamber pass through and in contact with the flue surfaces, and there give off to the water heat, which would pass to the chimney but for the intervening flue surfaces. In this way the heat of the gas escaping from the outlet of the flue, is reduced to a temperature only sufficient to create a good draft in the chimney. Now suppose that instead of leading this flue through the water, we should carry it through the end of the boiler direct from the fire chamber, it would quickly become red-hot for a distance of several feet from the boiler, and the gases escaping from the end of the flue would indicate a temperature of 700 or 800 degrees. The heat required to make the flue red-hot, and the difference in the heat of the escaping gases, would be a fair indication of the heat taken up and utilized by the flue passing through water.

As to the condition of the water in the boiler, I contend that the water cannot remain over the fire until it has absorbed all the heat it can absorb, while there is colder water in the boiler or colder water entering at the return pipe with a free circulation. Any increase of the temperature of water will cause a circulation at any temperature above 40 degrees; and there is no set temperature at which it leaves the heated surfaces of the boiler when in circulation. Under favorable conditions it will circulate freely with a few degrees added to the temperature of the water entering at the return pipe; the coldest water being more dense, settles down to the low part of the boiler, and there in contact with the hot surfaces of the boiler receives the first heat, which causes it to rise; gradually, but freely it rises and envelopes other hot surfaces and acquires additional heat, and will continue to absorb heat as long as it is exposed and in

contact with surfaces at a higher temperature. This leads to the consideration of the temperature of the flue surfaces heated by secondary heat, and the amount of heat imparted to the water by such surfaces. It is well known that with a good draft and sharp fire, the heat of the gases which escape from the fire chamber will exceed 800 degrees, that by passing these gases through properly arranged flues surrounded with water the temperature may be reduced to 300 or 350 degrees without material damage to the draft, showing conclusively that the gases have lost 450 to 500 degrees of heat, and that this heat has been imparted to the water.

I agree with Mr. Ellis, that there will be a waste of fuel if the boiler is exposed; but cannot agree that it might as well stand in cold water as in the cold atmosphere. The atmosphere is a poor conductor of heat compared with water. When a blacksmith wishes to cool a bar of red-hot iron, he does not move it about in the cold air, but plunges it into cold water and waves it there, knowing that the water will be far more effective. Boilers are usually placed in a cellar or covered pit, and in a measure protected. If not sufficiently protected in this way, they should be enclosed with brick as he suggests, or covered with felting such as is in use on steam boilers.

---

#### NOTES FROM LOUISIANA.

BY B. F. H., ARCOLA, LA.

The floral department of the *Gardener's Monthly* is very interesting to one as fond of flowers as myself, but in this climate there is such a profusion, and they continue so long, that they come to be quite common place to what they are in the North, where the seasons are much shorter, and where they require so much protection through the long winters. Until 1867, I had lived in the vicinity of Cincinnati, Ohio, and part of the time in the city. Since 1836, I was raising fruit for that market, until coming here: being advanced in life, and getting tired of the long cold winters, visited the South, and was so pleased with the climate, was induced to move and buy. I am situated 72 miles north of New Orleans, on the Jackson R. R. I am engaged in the cultivation of fruit for that market.

Since living here, I have tried some fifty kind of strawberries, but have found, as yet, but four

kinds that would stand the climate and bear shipping. As it is generally in strawberry season, the weather is quite as warm as with you in June. The first season I was here, I sent my first berries the last day of March, the next year the 14th of April, and this season the last day of March, and they still are as abundant as at first, although we have not had time to pick for market since peaches began to ripen. We made our first shipment on the 25th of May. There is an abundant crop of all kinds of fruit. May Beauty, Hale's Early, Honey and Troth's Early are the first to ripen here; the Early York will be ripe next week. Pears, the Madaleine ripens the 15th of May; several others ripen the last of May. Apples have been plenty since the 15th of May. The yellow and red Chickasaw plums began to ripen the first week in May; the Wild Goose plum is now ripe; I made my first shipment of them yesterday. They produce abundantly, defy the cureulio, are of the size of the Green Gage, and ship well. I sent a large box of them to my daughter last year, to Cincinnati; they arrived in good condition. I gathered from one tree last year, two and a half bushels. Blackberries are now at their best, and in the greatest profusion.

Native grapes as far as tried, do well here. I have put out six acres of Concord, one-half of Clinton, two of Ives', and two of the Scuppernon, with small lots of new kinds. I think this climate is the home of the grape, as the poorest of the lands produce grapes in abundance, with but little attention or culture. My Concord is three years from cuttings, and loaded with fruit. One of my neighbors has four acres of Concord, four years old, after deducting value of cultivation, picking, boxes, freight and commission, netted him twelve hundred dollars. Lands well suited for grapes on the railroad can be bought at from five to ten dollars per acre.

There are many kinds of wild fruits growing here. I will name—crab apples in abundance, three kinds of whortleberries, three kinds of plums, three kinds of haw, the Muscadine and many kinds of grapes; and as to flowers, there is such a profusion from early spring to winter, that I will try to describe a few that are new to me, although I had attended many of the floral exhibitions North. There is a running sensitive plant here that is beautiful, and more sensitive than the one I have seen North; it is perennial. The root throws out some 10 or 15 vines near

the size of a delicate raspberry, full of small spines with a great profusion of foliage, but very delicate; the flower is pink, composed of fine hairs, when first opened the ends of each hair has a stamen of golden color. I will send you a section of the vine. (1) Another plant here called the Southern Butterfly, of the milk-weed family or wild cotton, grows 15 inches high, is rather spreading in habit, is entirely covered with brilliant orange colored flowers, and is very showy at a distance; is also a perennial. (2) Also a very pretty plant, said by some to be Carolina pink root; sold by druggists as a gentle purgative, or given to children for worms; has a bright scarlet flower outside, inside buff; shape and size of the *Weigelia rosea*; is also perennial. (3) Also a plant I call the Coral bean, for want of its proper name; the root grows to be 8 or 10 inches in diameter, rather more woody than the poke root, but can be cut with a sharp spade; sends up in the spring from 5 to 25 flower shoots begins to flower, when a foot high of deep scarlet color two inches long; color of stem purple without leaves, flowers all around the stem; continues until three feet. A pod forms in the core like a common bean pod, containing from 5 to 7 beans. The leaf stocks come up after it has done flowering. (4) We are cultivating a vegetable we call Tanyah, described in B. K. Bliss & Son's illustrated catalogue, on page 99, called by him *Colocasia* (*Caladium*) *esculentum*; he cultivates it for ornament, and his price for plants is from fifty cents to two dollars, according to size. We cultivate and use it as Irish potatoes; large tubers are worth here ten dollars a barrel, small ones fourteen.

Strawberries that do best here are Imperial, Wilson's Albany, Marie Stuart, and Russell's

[1. This was *Schrankia uncinata*. 2. *Asclepias tuberosa*. 3. *Spigelia marilandica*. 4. *Erythrina cristagalli*.—ED.]

## CHEMICAL POWERS OF THE SUNLIGHT.

BY GENERAL PLEASANTON, PHILADA.

*Read before Philada. Soc. for Promoting Agriculture.*

At the request of my old friend and your respected President, I have attended your meeting at this time to impart to you the results of certain experiments that I have made within the last ten years in attempts to utilize the blue color of the sky in the development of vegetable and animal life.

I may premise that for a long time I have

thought that the blue color of the sky, so permanent and so all-pervading, and yet so varying in intensity of color, according to season and latitude, must have some abiding relation and intimate connection with the living organisms on this planet.

### VIOLET RAYS UPON A GRAPERY.

Deeply impressed with this idea, in the autumn of the year 1860, I commenced the erection of a cold grapery on my farm in the western part of this city. I remembered that while a student of chemistry I was taught that in the analysis of the ray of the sun by the prism, in the year 1666, by Sir Isaac Newton, he had resolved it into the seven primary rays, viz.: red, orange, yellow, green, blue, indigo, and violet, and had discovered that these elementary rays had different indices of refraction; that for the red ray at one side of the solar spectrum being the least, while that of the violet at the opposite side thereof was the greatest, from which he deduced his celebrated doctrine of the *different refrangibility of the rays of light*; and further, that Sir John Herschel, in his subsequent investigation of the properties of light, had shown that the chemical power of the solar ray is greatest in the blue rays, which give the least light of any of the luminous prismatic radiations, but the largest quantity of solar heat, and that later experiments established the fact of the stimulating influence of the blue rays upon vegetation. Having concluded to make a practical application of the properties of the blue and violet rays of light just referred to in stimulating vegetable life, I began to inquire in every accessible direction if this stimulating quality of the blue or violet ray had ever received any practical useful application. My inquiries developed the facts that various experiments had been made in England and on the European continent, with glass colored with each of the several primary rays, but that they were so unsatisfactory in their results, that nothing useful came of them so far as any improvement in the process of developing vegetation was concerned. Finding no beaten track, I was left to grope my way as best I could under the guidance of the violet ray alone.

My grapery was finished in March, 1861. Its dimensions were 84 feet long, 26 feet wide, 16 feet high at the ridge, with a double pitched roof. It was built at the foot of a terraced garden, in the direction of N. E. to E. to S. W. by W. On three sides there was a border twelve feet wide,

and on the fourth or N. E. by E side the border was only five feet wide, being a walk of the garden. The borders inside and outside were excavated three feet six inches deep, and were filled up with the usual nutritive matter, carefully prepared for growing vines. I do not think they differed essentially from thousands of other borders which have been made in many parts of the world. The first question to be solved on the completion of the frame of the grapery, was the proportion of blue or violet glass to be used on the roof. Should too much be used, it would reduce the temperature too much, and cause a failure of the experiment; if too little it would not afford a fair test. At a venture I adopted every eighth row of glass on the roof to be violet colored, alternating the rows on opposite sides of the roof, so that the sun in its daily course should cast a beam of violet light on every leaf in the grapery. Cuttings of vines of some twenty varieties of grapes, each one year old, of the thickness of a pipe-stem, and cut close to the pots containing them, were planted in the borders inside and outside of the grapery, in the early part of April, 1861. Soon after being planted, the growth of the vines began. Those on the outside were trained through earthen pipes in the wall to the inside, and as they grew they were tied up to the wires like those which had been planted within. Very soon the vines began to attract great notice of all who saw them from the rapid growth they were making. Every day disclosed some new extension, and the gardener was kept busy in tying up the new wood which the day before he had not observed. In a few weeks after the vines had been planted, the walls and inside of the roof were closely covered with the most luxurious and healthy development of foliage and wood.

In the early part of September, 1861, Mr T. B. Buist, Sr., a noted seedsman and distinguished horticulturist, from whom I had procured the vines, having heard of their wonderful growth, visited the grapery. On entering it he seemed to be lost in amazement at what he saw; after examining it very carefully, turning to me, he said: "General, I have been cultivating plants and vines of various kinds for the last forty years; I have seen some of the best vine-ries and conservatories in England and Scotland; but I have never seen anything like this growth." He then measured some of the vines and found

them forty-five feet in length, and an inch in diameter at a distance of one foot above the ground; and these dimensions were the growth of only five months! He then remarked: "I visited last week a new grapery near Darby, the vines in which I furnished at the same time I did yours; they were of the same varieties, of like age and size when they were planted as yours; they were planted at the same time with yours. When I saw them last week they were puny, spindling plants, not more than five feet long, and scarcely increased in diameter since they were planted, and yet they have had the best possible care and attendance!"

The vines continued healthy and to grow, making an abundance of young wood during the remainder of the season of 1861.

In March of 1862, they were started to grow, having been pruned and cleaned in January of that year. The growth in the second season was, if anything, more remarkable than it had been in the previous year. Besides the formation of new wood and the display of the most luxuriant foliage, there was a wonderful number of bunches of grapes, which soon assumed the most remarkable proportions—the bunches being of extraordinary magnitude, and the grapes of unusual size and development.

In September of 1862, the same gentleman, Mr. Robert H. Buist, Sr., who had visited the grapery the year before, came again—this time accompanied by his foreman. The grapes were then beginning to color and to ripen rapidly. On entering the grapery, astonished at the wonderful display of foliage and fruit which it presented, he stood for a while in silent amazement; he then slowly walked around the grapery several times, critically examining its wonders; when taking from his pocket paper and pencil, he noted on the paper each bunch of grapes, and estimated its weight, after which aggregating the whole, he came to me and said, "General! do you know that you have 1,200 pounds of grapes in this grapery?" On my saying that I had no idea of the quantity it contained, he continued, "you have indeed that weight of fruit, but I would not dare to publish it, for no one would believe me." We may well conceive of his astonishment at this product when we are reminded that in grape-growing countries where grapes have been grown for centuries, that a period of time of from five to six years will elapse before a single bunch of grapes can be produced

from a young vine—while before him, in the second year of the growth of vines which he himself had furnished only seventeen months before, he saw this remarkable yield of the finest and choicest varieties of grapes. He might well say that an account of it would be incredible.

During the next season (1863) the vines again fruited and matured a crop of grapes estimated by comparison with the yield of the previous year to weigh about two tons; the vines were perfectly healthy and free from the usual maladies which affect the grape. By this time the grapery and its products had become partially known among cultivators, who said that such excessive crops would exhaust the vines, and that the following year there would be no fruit, as it was well known that all fruits required rest after yielding large crops; notwithstanding, new wood was formed this year for the next year's crop, which turned out to be quite as large as it had been in the season of 1863, and so on year by year the vines have continued to bear large crops of fine fruit without intermission for the last nine years. They are now healthy and strong, and as yet show no signs of decrepitude or exhaustion.

#### AN EXPERIMENT UPON PIGS.

The success of the grapery induced me to make an experiment with animal life. In the autumn of 1869 I built a piggery and introduced into the roof and three sides of it violet-colored and white glass in equal proportions—half of each kind. Separating a recent litter of Chester county pigs into two parties, I placed three sows and one barrow pig in the ordinary pen, and three other sows and one other barrow pig in the pen under the violet glass. The pigs were all about two months old. The weight of the pigs was as follows, viz.: Under the violet glass No. 1 sow, 42 pounds; No. 2, a barrow pig, 45½ pounds; No. 3, a sow, 38 pounds; No. 4, a sow, 42 pounds, their aggregate weight, 167½ pounds. The weight of the others in the common pen was as follows, viz.: No. 1, a sow, 50 pounds; No. 2, a sow, 48 pounds; No. 3, a barrow pig, 59 pounds; No. 4, a sow, 46 pounds; their aggregate weight was 203 pounds. It will be observed that each of the pigs under the violet glass was lighter in weight than the lightest in weight pig of those under the sunlight alone in the common pen. The two sets of pigs were treated exactly alike; fed with the same kinds of food at equal intervals of time, and with

equal quantities by measure at each meal, and were attended by the same man. They were put in the pens on the 3d day of November, 1869, and kept there until the 4th day of March, 1870, when they were weighed again. By some misconception of my orders, the separate weight of each pig was not had. The aggregate weight of the three sows under the violet light on the 3d of November, 1869, was 122 pounds; on the 4th of March, 1870, it was 520 pounds; increase 398 pounds.

The aggregate weight of three sows in the old pen on the 3d of November, 1869, was 144 lbs., and on the 4th of March, 1870, it was 530 lbs.; increase, 386 pounds, or 12 pounds less than those under the violet glass had gained.

The weight of the barrow pig in the common pen on the 3d of November, 1869, was 59 pounds, and on the 4th of March, 1870, it was 210 lbs.; increase of 151 pounds. The weight of the barrow pig under the violet light, on the 3d of November, 1869, was 45½ pounds, and on the 4th of March, 1870, it was 170 pounds; increase 124½ pounds. The large increase of the weight of the barrow pig in the common pen is to be attributed to his superior size and weight on being put in the same common pen with the three sows, and which enabled him to seize upon and appropriate to himself more than his share of the common food.

If the barrow pig under the violet light had increased at the rate of increase of the barrow pig in the common pen, his weight on the 4th of March, 1870, would have been only 161 84 100 pounds, instead of his actual weight of 170 lbs., showing his rate of increase of weight to have been 8 36-100 pounds more than that of the other barrow pig.

If the barrow pig under the sunshine in the common pen had increased at the rate of increase of the barrow pig under the violet glass, his weight on the 4th of March, 1870, should have been 224 42-100 pounds, instead of 210 lbs.—his actual weight at that date.

By these comparisons it seems obvious that the influence of the violet-colored glass was very marked, although it must be borne in mind that owing to the great declination of the sun during the period of the experiment and the consequent comparative feebleness of the force of the actinic or chemical rays of the blue sky at that time, the effect was not so great as it would have been at a later period of the season; but the time of

the experiment was selected for that very reason. The animals were not fed to produce fat or increase of size, but simply to ascertain, if practicable, whether by the ordinary mode of feeding usual on farms in this country, the development of stock could be hastened by exposing them in pens to the combined influence of sunlight and the transmitted rays of the blue sky.

#### EXTRAORDINARY EFFECT UPON A PUNY CALF.

My next experiment was with an Alderney bull calf, born on the 26th of January, 1870. At its birth it was so puny and feeble, that the man who attends upon the stock, a very experienced hand, told me that it could not live. I directed him to put it in one of the pens under the violet glass. It was done. In twenty-four hours a very sensible change had occurred in the animal. It had arisen on its feet, walked about the pen, took its food freely by the finger, and manifested great vivacity. In a few days its feeble condition had entirely disappeared. It began to grow, and its development was marvellous. On the 31st March, 1870, two months and five days after its birth, its rapid growth was so apparent, that as its hind quarters was then growing, I told my son to measure its height, and to note down in writing the height of the hind quarter and the time of measurement, which he did. On the 20th of the following May (1870), just fifty days afterwards, my son again measured the hind quarter, and found that in that time it had gained *exactly six inches in height, carrying its lateral development with it*. Believing the question solved, the calf was turned into the barnyard, and when mingling with the cows he manifested every symptom of full masculine vigor, though at the time he was only four months old. Since the 1st of April of this year, when he was just fourteen months old, he has been kept with my herd of cows, and has fulfilled every expectation that I had formed of him. He is now one of the best developed animals that can be found anywhere.

These, gentlemen, are the experiments about which your curiosity has been excited. If by the combination of sunlight and blue light from the sky, you can mature quadrupeds in twelve months with no greater supply of food than would be used for an immature animal in the same period, you can scarcely conceive of the immeasurable value of this discovery to an agricultural people. You would no longer have to

wait five years for the maturity of a colt; and all your animals could be produced in the greatest abundance and variety. A prominent member of the bar, a short time since, told me that his sister, who is a widow of a late distinguished general in the army, had applied blue light to the rearing of poultry, with the most remarkable success, after having heard of my experiments. In regard to the human family, its influence would be wide spread—you could not only in the temperate regions produce the early maturity of the tropics, but you could invigorate the constitutions of invalids, and develop in the young a generation, physically and intellectually, which might become a marvel to mankind. Architects would be required to so arrange the introduction of these mixed rays of light into our houses, that the occupants might derive the greatest benefit from their influence. Mankind will then not only be able to live fast, but they can live well and also live long.

#### ELECTRICITY IN VEGETATION.

The most interesting application of electricity is in nature's development of vegetation. Let us illustrate it:

Seed perfectly dried, but still retaining the vital principle, like the seed of wheat preserved for thousands of years in the mummy cases in the catacombs of Egypt, if planted in a soil of the richest alluvial deposits, also thoroughly dried, will not germinate. Why? Let us examine. The alluvial soil is composed of the debris of hills and mountains containing an extensive variety of metallic and metalloidal compounds mingled with the remains of vegetable and animal matter in a state of great comminution, washed by the rains and carried by freshets into the depressions of the surface of the earth. These various elements of the soil have different electrical attributes. In a perfectly dry state no electrical action will occur among them, but let the rain, bringing with it ammonia and carbonic acid, in however minute quantities, from the upper atmosphere, fall upon this alluvial soil, so as to moisten its mass within the influence of light, heat and air, and plant your seed within it, and what will you observe? Rapid germination of the seed. Why? The slightly acidulated, or it may be alkaline water of the rain has formed the medium to excite galvanic currents of electricity in the heterogeneous matter of the alluvial soil—the vitality of the seed is developed and vegetable life is the result.

Hence vegetable life owes its existence to electricity. Herein consists the secret of successful agriculture. If you can maintain the currents of electricity at the roots of plants by supplying the acidulated or alkaline moisture to excite them during droughts, you will secure the most abundant and unvarying crops. To do this your soil should be composed of the most varied elements, mineral, earthy, alkaline, vegetable, and animal matter in a state of greatly committed decomposition.

The poverty of soils arises from the homogeneous character of their composition. A soil altogether clayey, or composed of silicious sand, or the *debris* of limestone, or of alkaline substances exclusively, must necessarily be barren for the want of electrical excitement, which no one of the said elements will produce; but commingle them all with the addition of decomposed vegetable and animal matter, and you will form a soil which will amply reward the toil of the husbandman.

What do you suppose has produced the giant trees of California? Electricity! Since the west coast of America has been known to Europeans, and perhaps for centuries before, it has been subjected to the most devastating earthquakes. From the Straits of Magellan to the Arctic Ocean, traces of volcanic action are everywhere visible. Its mountains have been upheaved, broken, torn asunder, and sometimes, like Ossa upon Pelion, one has been superimposed on another.

All volcanic countries are noted in the temperate regions, where they produce anything, for the exuberance of their vegetable productions. *Ætna* has been famous for its large chestnut trees, which have given a name, Catania, to the town near its base.

The mineral richness of California has doubtless, by the *debris* of its mountains, carried into the valleys where grow these large trees, furnished an immense deposit of various matter, which, under the favorable circumstances of the localities, have maintained for ages a healthful electrical excitement resulting through centuries of undisturbed growth in these vegetable wonders.

#### INFLUENCE OF BLUE COLOR UPON VEGETATION.

One of the most beautiful illustrations of the mighty influence of the blue color of the sky upon vegetation is to be found in the green color of the leaves of plants. It is known that blue

and yellow when mixed produce green, which is darker when the blue is in excess over the yellow, and the reverse when the yellow predominates. Now let us observe the process of germination. Seeds are planted in the soil. At first a white worm-like thread at the lower part of the seed appears; it is white, and contains all the primary rays of light; it is the root of the plant, and remaining under the soil continues white. At the upper end of the seed also appears a white swelling, which continues to grow upward till it approaches the surface of the soil, when a change occurs in its color. This is the leaf; it absorbs yellow from the soil, which is brown (composed of yellow and black), and as it comes within the influence of the blue sky, it absorbs from it the blue light, which, mixing with the yellow already absorbed, produces at first a yellowish-green, which finally assumes the deeper tinge of green that is natural to the plant. The plant blossoms form its seeds and seed-vessels, and, having fulfilled its mission, the blue color of the leaves is eliminated, the leaves become yellow, and, absorbing the carbon of the plant, they change their color to brown; the sap-vessels of the leaves are choked by the carbon; the leaves are dead and fall to the ground. Thus the blue ray is the symbol of vitality—the yellow ray that of decay and death.

#### TROPICAL HEAT DERIVED FROM THE EARTH.

As a corollary from what has just been stated, it may be observed that the heat of the equatorial and tropical oceans is not derived from the sun. We do not heat our houses by kindling fires at the tops of our chimneys, or boil our water from above, but rather we descend into our cellars, and make our fires for that purpose in the furnaces constructed there. Besides, we know that from the surface of the water, if at rest, and from its many surfaces if agitated by winds, the rays of the sun would be reflected in all possible angles corresponding to the angles of incidence of the rays themselves, and the heat would be lost in space. Whence comes, then, this ocean heat in the tropics, finding its vent in the arctic and antarctic regions through the Gulf Stream of the Atlantic, and the Japan stream leaving the shores of northeastern Asia, and the southeastern current running along the southwestern coast of South America to the antarctic seas? Does it not come from radiation from the interior of the earth, from those great fires which, by the elastic gases and vapors engen-

dered there, in many parts of the world, upheave mountains and islands, and forming chimneys for themselves in their summits, belch out that superfluous heat, light, electricity, and magnetism, which radiation to the surface of the earth at times is inadequate to discharge? And are not these great ocean currents of heated water merely channels or flues of radiation of heat from beneath, by which, for climatic purposes, the Omnipotent Creator has devised the means of distributing this interior heat over the surface of our planet?

All admit the existence of those great forces of nature in the interior of the earth, manifested through volcanic action in those imponderable elements of heat, light, electricity and magnetism. Why are those forces there? May they not be the forces which turn the earth on its axis, and aid in propelling it around the sun? may not the frigid zones north and south furnish the cold cushions of water in the extreme depths of the ocean, of the uniform temperature of 39½° Fahrenheit, and of nearly the greatest density known to that element for the purpose of restraining and controlling the radiation of that great interior heat of the earth, which otherwise might be wasted?

#### ACCLIMATIZATION OF APPLES.

BY OLIVIA. WASHINGTON, D. C.

*Of the Philadelphia Press.*

A stranger of inquiring mind, visiting the Department of Agriculture at Washington, will notice the fruit grown in the different portions of our country, represented by models of the original in exact imitation. By the side of the "Gloria mundi" apple, weighing twenty-four ounces, grown on Capitol Hill, in this city, may be seen the wild apple of Alaska, no larger than a medium sized black currant. The observer will see at once the change produced in this fruit by an artificial process or the art of cultivation. It is found by experiment that the apple will grow in arable soil in every portion of our domain, but in every instance the kind must be adapted to that part of the country under the hand of the fruit grower. Only a few years ago it was supposed the Southern States could not produce a superior quality of apples. Time has shown the mistake was in the attempt of trying to raise the varieties not adapted to those latitudes. The Albemarle Pippin of North Carolina is the favorite apple with royalty in Europe, and

is worth twenty dollars per barrel when safely landed in London. The Albemarle Pippin of North Carolina is the same as the Newtown Pippin of more northern regions. Nothing can be found out about fruit growing by theory; everything must be learned by experiment. And thus far it is shown that the Piedmont region on the Blue Ridge of Virginia, and the hills of North Carolina, produce the best apples in the world, because the season admits of an extra month for growing, and another for maturing. In what does the best quality of an apple consist? Like a well dressed woman, a great deal can be left to the discretion of the judge, yet certain "points" of perfection must be attained else the whole matter is a failure. An apple may be sweet or sour, or any variation between, and yet it must be as crisp as an old batchelor, or tender as a husband before the honeymoon is over. When the apple is taken between the teeth the sensation should be like crushing air-cells filled with nectar.

The best apples are very heavy according to their size, especially those adapted for winter use. In the month of May apples may be seen in Washington, grown the previous year in South Carolina, as solid to the touch as when taken from the tree. These apples are considered in the highest state of perfection when they are about twelve months old. New York and Ohio heretofore have enjoyed the reputation of raising the best apples on account of the peculiar temperature of those latitudes, as well as other slighter incidental causes. It is now proved that elevation answers the same purpose as a more northern zone, because temperature of a like character is obtained, and whilst New York and Ohio suffer more or less from the frosts, Virginia and North Carolina are comparatively spared, therefore the fruit crop of the Southern country is far more reliable and certain. Whilst writing about the dear old State of North Carolina, it may be well to mention that she has a most remarkable geological surface. Commencing on her farthest limit from west to east, she gradually slopes to the sea. A plank tilted on end bears a strong resemblance to North Carolina. As you ascend this plane, it would seem as if this State was constructed for a vast orchard. On the high ridges the American apple attains perfection. A little lower, only a few miles distant, the delicious apricot, the daintiest fruit of this continent, lives its short life away. Necta-



rices, plums and pears may be raised here in quantities to supply the whole nation.

Whilst there is but a single species of apples, soil, temperature, and other causes have produced thousands of varieties. The same apple is known in different parts of the country by different names, but, like the people of the various States, there is generally some little peculiarity to mark them. Some very few varieties, like some particular men, seem to flourish equally well anywhere. In this connection may be mentioned the Wine Sap, Golden Russett and White Winter Pearmain. In Massachusetts the Baldwin apple may be seen growing, twisted and distorted, in the hard, rocky soil, yet no fault can be found with the product. Massachusetts Baldwins, like the people of that State, seem to lose certain qualities when removed from the stones; and in order to remain perfect, the Baldwin apple, like Boston people, should stay at home.

The Baldwin apple of Illinois is a very inferior production compared with its Eastern brother, and instead of being crisp, close, occupying little space, it has expanded and become porous and coarse. It has lost all its delicacy, and reminds one of those swell millionaires of the West who have no faith, knowledge, or enjoyment outside of physical comfort.

Apples are divided into summer, fall and winter varieties. They cannot be classified because they are artificially produced. The same apple will not grow in Maine that grows in Maryland, or it will be so changed that the qualities cannot be recognized. Each State has this kind of fruit, which is particularly adapted to its soil and climate. A man going from the East to the West selects grafts from his favorite trees and takes them to the new country. In the end he is sadly disappointed. Through the fourteen hundred agricultural organizations that report to the department at Washington it is ascertained in which State certain varieties flourish best. At the proper season certain kinds of apples arrive here, and in this way the apple of Texas can be compared to the apple of Maine, and in this way only can this most valuable knowledge be sown broadcast over the land. If an army needs a general for its safeguard and protection, how much more the agricultural masses need a source where certain and reliable knowledge can be obtained. We will suppose a young man intends to cultivate the earth instead of a profession for an honorable subsistence.

We must remember that we have a belt of the earth's surface unlike any other country on the face of the globe, taking into account civilization and everything else which bears upon this point. The young man chooses to emigrate; if he is wise he will come to Washington and learn all that is garnered here about the locality he intends to make his future home. He will learn the cereals, fruits, and textile plants that flourish best in the chosen retreat. He will see the insect which destroys in great part the result of the husbandman's labor. He will see the same kind of bird that will henceforth prove his friend or foe. It is true this branch of the tree of knowledge is still of infant growth, but Commissioner Capron and his efficient assistant corps are working hard to make it become just what it certainly is destined to be in the end. Congress may harass and retard this grand undertaking by withholding the proper appropriations. Congressmen may sneer in their ignorance at the "scattering of garden seeds," but the time is certain to come when this branch of the Government will rank in dignity with the proudest, and outrank in genuine usefulness every other.

In the extreme northern latitudes of our country, in the region where the Mississippi river is begun, the American apple has not flourished well, owing to the brevity of the fruitage season. Latterly the Russian apple has been introduced by means of the department at Washington, and very excellent fruit will now reward labor in these remote and thinly populated neighborhoods. It has been found by actual experiment that fruit trees flourish best, or get a foothold in the worn out lands, exhausted by tobacco and cotton, far easier than any other vegetation. With very small outlay, comparatively speaking, for fertilizers, fruits will grow when the cereals and other plants cannot be coaxed into sprouting. When the trees advance to a certain size the leaves fall, and this also enriches the earth. In a little while the orchard itself will begin to pay for the necessities of its perfection. An orchard in this part of the world is not an object of slow growth. Before the fruit grower is hardly aware of it, his infant trees begin to bud and blossom. Suppose the orchard is far removed from market. In these days of canned fruits nothing need be lost. American canned fruits are now one of the acknowledged delicacies of the world, and the demand a million

imes exceeds the supply. Even Pius IX eats brown bread and canned peaches. And here opens a glorious avenue of labor and reward to women. Only the strongest of American women can become farmers, for they have not the strength to handle the spade and other implements of labor. But the weakest can plant a tree, and whilst she is nursing her back ache and neuralgia, the tree will be growing with very small care and attention. The misguided women who are demanding the ballot, base one argument upon the fact that there are so few avenues open to subsistence to women. The avenues are open, but it is the women who halt and refuse to enter. Let three hundred starving needle-women of New York organize and petition A. T. Stewart, or any other benevolent millionaire, to colonize them and place them on some of the lands of the South that can now be had almost for the asking, and this most worthy charitable act of the nineteenth century will be accomplished. Suppose A. T. Stewart rendered each woman a little assistance each year until the trees began to be remunerative. Isn't this greater wisdom than building orphan's asylums or homes for the poor? Take care of the women and there will be fewer orphans, and no need of homes for the poor. Women of small means can make themselves independent by fruit culture. Oh! the inexpressible joy and comfort of sitting under one's own vine and fig tree. And yet this supreme pleasure can be enhanced by employing a pair of strong hands to prevent the winds of Heaven visiting our cheeks too roughly.

---

#### EDITORIAL NOTES.

##### DOMESTIC.

*Natural Manure*—It must be obvious to all that there is in most soils, deep in the earth beneath, fertilizing material of wonderful recuperative powers. We recently noticed in an old quarry amongst the "spalls," a mass of rotten rock, so poor that apparently nothing could grow, mulleins of immense size,—four or five feet with leaves as large as rhubarb leaves. All about in the cultivated ground near were mulleins, but as poor as possible. There must of course be in this material something very stimulating to the mullein; and if so to this, why not to other plants? And yet we should hesitate before hauling this rotten rock on to our ground. Yet it is evident there is a valuable secret locked up in this rock somewhere. Apropos of this we

find the following by our very intelligent friend Gregory of Marblehead, in the *Country Gentleman*:

"Four years ago I had a wall laid along the border of my garden. I had the trench for the foundation dug very deep, well down into the hard-pan, and had the hard-pan thrown into a pile separate from the loam. The loam was used in the compost heap, and the hard-pan—a half sandy, half gravelly mass, with just enough of coarse soil in it to be seen—was left to be used to fill up some path.

In the course of the summer, I noticed a plant growing on it with surprising vigor, which on examination, proved to be the common mustard, but with leaves nearly as broad and large as a cabbage—a size I had never seen surpassed in the richest soil. Beside it, and also on the hard-pan, was growing a plant of Apple of Peru, with a vigor that belonged to the richest soil. The following spring I spread the lot on the flower garden, and had a wonderful growth of flowers as the result.

A year later, one of my neighbors in another part of the town dug a ditch, that drained his land through mine, to the depth of over six feet, cutting for about the last three feet through hard-pan, and throwing this on my side of the wall, where it made a heap about three feet in depth, of apparently nearly pure gravel, a little mixed with sand. The next summer while passing that way, I stepped aside to examine the ditch, when to my surprise I found growing on the heap of hard-pan, hog weed that was nearly as high as my head. The only inference I can draw from these facts is, that under some circumstances hard-pan is an excellent manure. In each of these instance the surface soil was a strong loam that had been under good cultivation for many years. May it not be that some of the salts of the manure applied during this period, passed through the loam to the hard-pan below, and there remained, held as in a bowl? Lime, it is stated, has this tendency, making it necessary to plow deeper each year to bring it to the surface. By whatever theory they may be explained, the facts seem to prove that in this broad country of ours there must be a multitude of acres underlain by vast areas of fertilizing material. Should further experiments demonstrate this to be a fact, it must prove of immense practical value to our tilled acres, of which the best fed have the habit of calling for a little more."

*Sinking of Lime in the Earth.*—In the foregoing paragraph, Mr. Gregory refers to a fact long observed in England, that after a field has been limed, many years afterwards the lime may be found in one thin vein six, nine, or twelve inches beneath the surface. Many remarkable hypotheses have been started to account for this, but the true explanation we think is this: Our grounds are on the revolutionary battle ground of Germantown. It is no uncommon thing to dig up bullets, but they are always about *twenty inches beneath the surface*. It was clear to us at the outset, that it was not gunpowder which sent them this depth, neither could they “dissolve and crystalize again” as some of the lime explainers say, but they went down in this way. Every winter, when the ground froze, there was a slight upheaval by expansion of the earth. The lightest goes up easiest. We see this every winter on the surface. A sudden frost seems to *sink down a little*. A stone at the surface. Really it is the earth about the stone which goes the highest. When the thaw comes the bullet being the heaviest and not liquified remains still the lowest. In this way, the bullet in time *gets down to the frost line*. There can be little doubt this is the explanation of the lime puzzle. It sinks because its specific gravity is greater than the softer earth about it,—and the white seam is the frost line.

*Mexican Everbearing Strawberry*—The papers are again discussing the merits and distinctness of this and the old monthly Alpine. Charity compels us to say, that it is not only extremely difficult to distinguish these two from one another, but *any variety* of Alpine one from another in the summer or the fall. Indeed Mr. Fuller declared in an article in *Heart and Home* that there was *no difference between any of them*. Any one, however, who will note them closely when they are coming into leaf and flower in the spring, will see great differences. The advocates of their absolute identity, however, scarcely deserve to have even this justice done them; for—most of the party—have discussed their side of the question, in utter disregard of the amenities of cultivated minds. Only so recently as the issuing of Messrs. Judd & Co.'s Annual, Mr. Fuller dares to intimate that all who differed with him were bought to do so. We have always held this style of arguing—or rather of disputing—in utter contempt; still this does not prevent our saying what in justice we should say, that as the two strawberries grow side by side in our

ground after a year of growth together, it is barely possible to distinguish one kind from the other in summer time, although easy enough in the spring of the year.

*Influence of Pollen on the Immediate Quality of the Fruit.*—It has always been supposed, and we believe so taught in European text books on horticulture that cross fertilization does not affect the form or quality of the fruit impregnated, but only the pollen. We showed recently that in the Canada cross (?) between the apple and the pear, there was an undoubted mixture of qualities in the fruits. We also know that it is so, in the case of corn and squashes. It has also been suspected that it does so in grapes; and the following which we find in an exchange confirms this:

“At a late meeting of the Cincinnati Horticultural Society, were presented by Mr. E. A. Thompson, of Covington, Ky, fine bunches of the Creveling, ripe and fine for the table—very delicious. Mr. Thompson grows his Creveling in alternate rows between Hartford Prolific and Concord. The Crevelings grown by themselves lack the solid, large bunches which they make in the alternate rows, as grown by Mr. T. for the purpose of impregnation.”

*Influence of the Scion on the Stock.*—In the early volumes of the *Gardener's Monthly*, Mr. D. W. Adams and others noticed that an apple had its roots singularly modified by the graft which grew on it. The fact is important enough to be kept prominent, as the “philosophy” of the matter has not been explained. We noticed in the *Vermont Farmer*, recently, Mr. Goodale is quoted in 1863 as noticing the same facts. The *Farmer* says:

“Still further, scions have sometimes a peculiar action upon stocks in modifying their habit of growth as regards the roots. Says Goodale, (Maine Agricultural report, 1863, p. 163.) “Let a row of seedling apples be grafted, a part with the Siberian Crab apple, and a part with several free growing kinds like the Baldwin or Greening and it will be found upon lifting them a few years after grafting, that the former may have a much greater amount of roots than either of the free-growing sorts. Let part of a row of young Canada plums (our common wild plum) be budded with the better and more free-growing sorts, like Imperial Gage, Smith's Orleans, or McLaughlin, and after two or three years, upon lifting them, it will be found that the roots of those trees grafted have not, apparently, grown

at all since being budded, while those not worked have extended very much. These and similar cases I have repeatedly observed in nursery practice, and there are doubtless other influences also exerted by the stock which are not

well understood—for instance, it is said that sometimes an apple, usually free from this defect, has become what is called *watercored*, in consequence of having been grafted upon a tree, the natural fruit of which was thus affected.”

## EDITORIAL.

### THE PROPER TIME TO PLANT TREES.

In reading the excellent work of Mr. Chas. Downing on fruits, we notice that he puts great faith in the opinion of Lindley, that the fall is the best time to plant trees. It does not appear that Lindley spoke from any experience in the matter; but simply from what he conceived to be physiological reasons. Here we see, he remarks, that the tree's roots grow all winter. Hence a transplanted fall tree, will have restored its injured roots, and will be in a better condition in spring than if it had to make new roots and new leaves all at the same time. This certainly seems very reasonable; and if there were no counteracting influences all would be well.

But it does not appear from a study of Lindley's writings that he fully appreciated how much evaporation of moisture from the stems of trees there is in the winter season. Indeed how should he, for in the moist English atmosphere, there is not much. But from our stand point—where the evaporation is enormous—Lindley had not the opportunity to see what we know. We have found that not only do our trees do what Lindley says English trees do, grow their roots all winter, except when absolutely encased in frost, but even when the soil is hard frozen. Thawing their way by the aid of their internal heat, they go through the most solidly frozen block, drawing in a supply of moisture for the rapid exhalations from the leafless bark continually going on. If this power of absorbing moisture in the dead of winter were to cease, some of our hardiest trees would die in a few days under our cold wintry weather. It is just this which often interferes with the success of our fall planting. Moisture is in a small degree absorbed by old roots; but the major part is taken up by the young growing rootlets, chiefly from the ends which are spongiest and softest, if

there has not been time for the production of an abundance of these, it is hard work for the tree to get through the winter alive.

Now, if we bear in mind these two great principles, we shall not go far wrong as to the proper time to plant. We see that we have to get new rootlets; and we have to guard against excessive evaporation until we do. If we can secure enough rootlets to meet all the plant's wants through the winter, then assuredly the fall is the best time to plant trees.

Often we can secure these conditions, and often not. It is the object of this article to teach our readers who have not thought of it, how to use wise discretion in the matter.

One of the best ways is to plant *very early*. Do not wait for the fall of the leaf; but commence as soon as the first heavy fall rains have thoroughly loosened the ground. If the leaves have not all fallen, strip them off. It is no more of an injury for man to do this in the day, when a frost may and often does do it the same night. If there be much soft and immature wood, cut this back, evaporation is much more easy through this part than the harder and more mature.

Another thing in favor of fall planting, will be the selection of warm ground. This will much favor the production of rootlets. In a cold damp soil, the roots already on the tree will rather die, than new ones produce themselves. This is particularly the case with some trees which do not make young roots freely in the fall. The tulip tree, oaks, and the peach are familiar instances of this class. And again he who would have the very best success with fall planting, must guard as much as possible against hot bursts of sun, or cold wintry winds; and thus he whose place is the best protected in this respect, will have the best of it over him who has not.

Some of our readers, we suspect, will wonder why we include the sun in our list of winter enemies to the fall planted tree. But we see how it is after a winter's experience. The southern side of the fall planted tree is often scorched on that side. This is simply because the sun draws out the moisture there faster than the injured roots can supply it.

In favor of fall planting there is yet one item which we can seldom have in spring. This is in reference to the condition of the earth. It is often said that a wet day is good for planting trees, but this is a mistake. The pasty earth does not fit closely to the roots; and the roots cannot well take up moisture, unless they are in close contact with the earth. Hence a half dry soil, that will powder finely when crushed, is to be preferred. Then every little root finds the powdering soil closing in about it; and it is almost as if the root had pushed itself through in the ordinary way. It is a good thing in transplanting to have one man pounding with a rammer, as fast as the earth is being put in. In the spring, what with rain and frost, the soil is not apt to be as friable, as gardeners say, as it is in the fall of the year.

We think, with these facts before them, our readers can judge for themselves how far they can command the essentials to success in fall planting. It will be seen that an absolute rule as given by Lindley won't do; but yet there are hundreds of cases where it can and will be best to plant in fall. We all have enough to do in spring, and all we can get done in advance in fall, is great gain.

#### THE JAPAN LARCH.

The *Larix leptolepis*, or Japan Larch has this season produced cones on the grounds of the editor, and furnishes another illustration of the

fact that the plants of Japan more nearly resemble those of the United States than those of Europe. The habit of the tree is very much like the American, even to the glaucous tint of the young branchlets; and the cone is in structure like our American species. There is this striking difference between *Larix Eurozœa* and *L. Americana*, that the central axis, or as one might popularly say, the core of the cone, is strongly developed in the European. We find the woody axis up to the highest point of the scales, and often it extends to a perfect branch beyond the cone, as we see a branch beyond the apex of a pine apple. But in the American species the axis is much below the scales; so that the apex of an American cone is sunk in the mass of scales, as the calyx basin of an apple is in that fruit. The cones of the *Larix leptolepis* resemble the American in this; though they are nearly as large as the European species.

Mr. Hogg, who sent the seed from Japan, thinks this tree is the only one successfully raised from his seed now existing in this country,—but we saw an imported plant nearly as large as ours at Mr. Hunnewell's near Boston. Mr. Hogg tells us that it is from this tree that many of the curious figures which the Japanese are so fond of forming in their gardens, are made. The branches do not readily break in bending, and they are tied into position, until they resemble any bird, beast, or other thing. The advantage of employing the Larch is, that the spurs which come out of the old wood for many years, keep all the branches year after year clothed with foliage, which no other tree would do. Besides this it makes long lithe branches, sometimes making five feet in a season, which gives plenty of material for planting.

The editor's plant is not ten years old from the seed: and though all coniferæ grow slow for the first four or five years, this tree is about 25 feet high.

#### SCRAPS AND QUERIES.

THE PRINCIPLES OF WARDIAN CASES.—H. W., *Chicago, Ills.*, writes: "Having recently had my attention called to the method of conducting 'Ward's Cases,' sometimes called 'Wardian Cases,' and 'ferneries,' I am anxious to learn more of the matter. I wish to learn somewhat of the *scientific laws*

which govern vegetation in an air tight case. What is the process by which the equilibrium is sustained, and the life and growth of the plants advanced? I don't care so much for the *practical* part of it, as for the *scientific* solution. I have as yet been unable to find any one here who is able to explain the phenomena in a

atisfactory manner. I have consulted Dr. Blaney of the Rush Medical College, and Prof. Stimson of the Academy of Sciences. The editor of the *Prairie Farmer* referred me to you. If you can spare the time, I should consider it a great favor if you will afford me the desired explanation, or inform me where I can find some work which will treat the matter from a scientific stand point."

[In a true *Wardian Case*, there is very little growth; hence there is no equilibrium to be maintained in the sense in which our correspondent supposes. In a perfectly air-tight case, such as a *Wardian case* is supposed to be, a plant simply *lives*, and makes no extended growth. If it *grows*, it could only do so by the decomposition of carbonic acid, and this would cause such a dense mass of oxygen in the atmosphere of the case, that the act of growth would be its own destruction.

There are three essentials to growth,—light, heat and carbonic acid; with the two former only, the plant simply *lives*, and does not grow, hence a plant will remain an indefinite time in a closely glazed case in this way.

Fern cases are not *Wardian Cases*, nor are the plant cases often called *Wardian*. Air is partially admitted, and thus plants grow. In the case of ferns however, they have very little carbon in their structure. Any plants which are composed mainly of cellular matter, can grow when there is but a very small portion of carbonic acid in the atmosphere of the case.]

AGE OF THE LARCH.—*H. A. J., Chicago, Ill.*, writes: "Can you give me the age of the European Larch growing in the Bartram Botanic Garden, Phila., that you mentioned in 1853, as being 108 feet high and 5 feet 4 inches in circumference, and is it still standing and growing; and do you know of any other fine specimens? I am gathering what information I can on this subject, to induce tree planting on our prairies, and especially the *Larch*. Any information you can give me concerning its history, rapidity of growth, &c., will be gratefully received. This tree seems to have been entirely successful with many of our western planters, and I do not consider the time far distant, when it will play a conspicuous part in the supply of fence posts, telegraph poles, and railroad ties for the West."

[The Larch we referred to is, we believe, still in existence. We have no means of knowing its

exact age, but it is probably under 100 years old. With regard to the value of the Larch, we believe that it is equal in endurance to anything,—but it must be borne in mind that we have no statistics gathered in this country. It must be regarded as an experiment,—but still an experiment with everything in its favor. But it does not follow that Larch wood raised in this country will do what Larch wood does in Scotland, although the same tree. European trees grow and endure differently here. The oak, which in England "lasts for a thousand years," has grown and commenced its decay here within one hundred. Great numbers of European trees in the Bartram gardens, though not much over a hundred years, have some entirely disappeared or are going to decay. The magnificent Silver Fir in Germantown, not 100 years old, and which only ten years ago drew tree lovers from long distances, is a sorry looking object now. We are inclined to think the Larch and Larchwood will endure at least as long as any tree; but not to the extent it would in Scotland

LETTUCE ABOUT BOSTON.—*A Subscriber, New York*, says: "I wish to make the inquiry through the *Gardener's Monthly*, how they raise Lettuce around Boston, and if there is any reason why the same cannot be raised here

If some one acquainted with the cultivation will write an article on this subject, they will greatly oblige a New York subscriber."

DRESSING FOR PEACH TREES.—*A. R. Sprout, Picture Rocks, Pa.*, writes: That he "is using with apparent good effect, pulverized charcoal and wood ashes as a top dressing for peach trees, producing a healthy growth with deep green foliage and apparently no disease. Also as a prevention of the root or bark worms, a wood hoop around the base of trunk, diameter six inches, depth three inches, filled with ashes, charcoal, sand or dry earth.

He has planted 2,500 of the peach; has ten acres more to plant."

CALIFORNIAN NOTES.—*A Correspondent* says: "I have written you some hasty notes to mention some trees and shrubs I saw in California, I thought you might probably think worth enquiring about. An evergreen near the 'Geysers' not far from the Calistoga Springs, struck

me as being a fine thing. They call it the California Nutmeg. It has a very deep green leaf, like that of a fir, but very long. It grows like fir, and some about 15 feet high, were the highest I saw. Cut down, it sprouts at the stump freely as a chestnut.

I mentioned the Dogwood then with its fine large flower. The Spice wood with its great leaf. Brilliant white flowering Raspberry. Pink and white Azaleas, with very large and fine flowers. An evergreen Chinquepin, &c. &c.

I dare say you know the Sugar Pine that grows on the mountains there (high up), a grand tree, cones 2 feet long. It grows 300 feet and over, and produces manna—which I ate,—very sweet and delicate. Then there is what they call the Pitch Pine, straight and tall, over 300 feet high; most like the Australian with its candelabra form and deep, rich green leaf. Then the Yellow Pine, so called then there, nearly a match in size. All these three pines are high up in mountains.

The Dwarf Horse Chestnut of California clothes the side hills, and has a very fine crown in density, form and color; not over 12 or 14 feet high, covered with spikes of flowers over a foot long, mostly white, often tinted with other colors. The flowers stand erect and are very dense and nearly as large as a man's arm.

I found in Minuota and about Madison in California, native crab apples, plenty, trees 10 to 15 feet high. Also great numbers of wild Plums. Some of which I was told are nearly as large as green gages, and really good fruit; red in color. The wild plum I have known (of Pennsylvania) is red and astringent, but excellent on that account for preserving or stewing.

The Buttonwood of California is one of the grand trees of this Continent, much larger than any I ever saw here, with vast spreading crown, enormous branches, and foliage much cut and starry, like that of the European, but much more so. I was much struck with the inclination to European characteristics of many trees and shrubs in California. The Oysters have also the same tendency. Even the Blackberry flowers exhibit it, at least so they struck me, who am, however, no botanist—only an interested looker on.”

years old. Does not this completely overthrow Darwin's hypothesis of the origin of species?”

[We do not understand our correspondent, or see what relation the age of these trees has to the Darwinian theory.

In the first place, it is not so certain these trees are as old as some suppose. Mr. Josiah Hoopes, who examined the trees personally, and with very common sense eyes, noticed that these trees were still extending their leaders somewhat every year. Now when these trees are young, they grow with immense rapidity. We have known them grow six feet in one season. Supposing they only grow two or three inches a year now; that they grow four or five inches some years previous, and that for many years they grew only one foot—allow, if you like, that the average growth was but one foot per annum through the whole course of its career, and the three hundred feet tree will be but three hundred years. You see if the tree only 300 feet high grew 3000 years, it would only be *one inch a year*, which, if Mr. Hoopes is right in his statement that the straight trunk continues to grow up, is an absurdity. It surely must grow more rapidly than this.

Anyhow, Mr. Darwin knows as well as any one that there has not been much change in things for some thousands of years. Men are now pretty much as history says they were four or five thousand years ago.—and even in the matter of dogs, which occupied so conspicuous a place in Mr. Darwin's origin of species, it is very well known that dogs like our own, especially the greyhound, are carved in Egyptian figures of five thousand years ago. We do not see what our correspondent wants us to say.]

GARDENERS—*B. S. F.*, says: “I have been a constant reader of your valuable *Monthly*, and have read with great pleasure and benefit, many articles contained therein. I do not remember having ever seen an article of this character, which is the formation of a gardener's club or society for the benefit of gardeners seeking employment. By gardeners, I mean only those that would pass inspection. There are very many at this time who call themselves gardeners, but are only so called by themselves, that accept situations at a salary far below that which an experienced gardener should be able to command, and for this reason cannot do so. Now, Mr. Editor, would it not be well for you to

ORIGIN OF SPECIES—“*Orpheus*,” *Baltimore, Md.*, says: “It is generally conceded that the giant trees of California are several thousand

organize a society of gardeners, and to have all who wish to obtain responsible situations to pass an examination, the same as a doctor or any similar profession; and to appoint a certain salary for both single and married men that are pronounced capable to hold prominent positions. I have often thought over this subject, and have come to the conclusion that you are the most influential party to refer this subject to for consideration. If you consider the subject worthy thereof, you will not only oblige me, but many good gardeners in all parts of America."

[Our correspondent raises a very difficult question. It is excessively annoying to have one who is no gardener preferred to ourselves, when we feel that we have devoted our whole lives, and as we may believe with some success, to the profession. But we doubt whether any organization would correct this. Many a good physician who goes through all B. S. F. would have gardeners go through, frequently starves; while the "smart" fellow, who received his parchment only to the surprise of his fellow students, gets practice and riches. Too often an excellent gardener has other defects, which render his services unaccessible. He is often dignified, and makes no effort to let what he knows be known.

He is averse to "blowing his own horn;" but good skill requires as much advertising before it is known as the Quack's business does. Our belief is that where true gardening skill is once known, and he who possesses it has other agreeable qualities, there are very few good gardeners in the United States who will long remain unappreciated. Let him have tact enough to turn up some chance to show that he "knows how to do it," and his success is safe.

MALE AND FEMALE HEMP.—*J. K., Paris, Bourbon Co, Ky.*, writes: "It has been observed by those who cultivate hemp in this State, that the male plant dies long before the female plant. Has this been noticed before, and what is the explanation?"

[This is an accordance with Meehan's theory of sex in plants. There is less vitality or hold on life in one case than in the other; and it is the amount of nutrition which determines the vital power,—defective nutrition determines the male sex. Not only in hemp, but in every plant, male flowers or the male parts of flowers die first.]

## BOOKS, CATALOGUES, & C.

DOWNING'S SELECTED FRUIT FOR THE GARDEN AND MARKET. New York: John Wiley & Son.

It has ever seemed to us that the large work of Mr. Downing was rather a tribute to perfection than to practical utility. No one could fail to estimate the value of his labors when he wished to have on hand a description of all the fruits known; and yet everybody must have asked himself when this labor was to cease? A botanist goes on the work of a *Flora*, satisfied that he can get all the known plants, but to expect to get all the known fruits together, should be beyond human thought. For our part, we look on this multiplication of new fruits as a great evil, and have declined for some time to describe any new variety, unless satisfied that it had at least one

point of superiority over others already known. That it should be merely "good," is not enough,—and no one should be entitled to name a fruit so as to have that name recognized by pomologists, unless he is able to show wherein his fruit does differ from all others known. Of course he who discovers a new fruit, should have the right to name it *provisionally*; but it should be submitted to some one distinguished as an author in that particular line of fruits, and if after a careful examination, it is found sufficiently distinct to warrant distribution, let it go forth with his name attached, as a new plant would do. Then we might have, for instance, in pears, the "British Lion," *Hogg*; the "Spread Eagle," *Barry*; or the "Glory of the Hub," *Hovey*;—or in



apples, "Star of the West." *Warder*; "Setting Sun" *Elliott*; or "Morning Star" of *Downing*,—and so on with other fruits. We don't know whether these reforms will ever be introduced; but this work of Mr. Downing's is in the right direction. Here we have every thing weeded out, except such as have gained some reputation. The book is about the size of Mr. Downing's earlier editions—600 pages. We think the idea of giving this abstract an excellent one, and it will, no doubt, be found a profitable one for both the author and publisher.

In regard to the matter of the work, it is not our purpose to speak of it critically, as it is much as appeared in former volumes. Yet we cannot but regret that Mr. Downing has not looked at the subject of fruit culture through more modern eyes. We have as great regard as he has for Knight, and Loudon, and Van Mons, and the elder DeCandolle, and Coxe; and Kendrick in our own country: but surely a little has been learned during the last fifty years. And then, we are sorry to have to say it of Mr. Downing, he is not always

just to those who differ from him,—not intentionally unjust of course,—but no less so. For instance, in regard to the cultivation of apple orchards he says: "It is indispensable that in all young orchards the ground be kept mellow and loose," "Of two adjoining orchards, one plowed, the other kept in grass \* \* the one will have clean smooth stems \* \* the neglected one starved and sickly."

It has been the fashion with some newspaper disputants, more anxious for the success of some pet theory, than to do justice to others, to pretend that those who differed with them as to the proper way to cultivate orchards, were advocates of *neglect*: but one would hardly expect to find a writer of Mr. Downing's known generosity among this class.

In the description of fruits some errors in former editions have been corrected. Now Dutch Mignonne apple is *not* Blenheim Pippin; Striped Winter Pearmain, and McAfee's Nonsuch are united; as also are the Westbrook or Speckled with Fall Orange.

## NEW AND RARE FRUITS.

**STRAWBERRY, COWING'S SEEDLING.**—This is an Indiana variety raised by Mr. Cowings four years ago. The fruit is represented as being produced as abundantly as Wilson's Albany,—superior in size and productiveness to Downer's new seedling; "solid, excellent, robust and beautiful." In size, the berries are said to "average larger than Triomphe de Gand, Agriculturist, or Jucunda."

**THE PLOWDEN PEACH**—For some time peach growers have been exercised about a new peach which originated some sixty miles below Washington, D. C., which was said to be ripe *twenty days* before Hale's Early. As this was ten days earlier than Early York, a peach a month earlier than this old standard, seems too impossible to be true, and we have so suggested in a former number of this paper. We supposed it might be, perhaps, a sickly tree of Hale's

Early which had borne premature fruit, as diseased trees sometimes will. But we have to-day, *July the 5th*, a fruit before us from a tree budded from the original, and we can see that it is not Hale's Early, nor any illy ripened fruit, but a distinct kind, of delicious flavor. We have in our market miserable colicky Tillotson's from Florida,—if such a lot as this one from Washington could be put on the market, one's fortune would be made.

We do not yet understand how so good a peach can be *a month earlier* than Early York, and fancy there is yet something unexplained about this; but we must say that it is the best early Peach we have yet seen. The Hale's Early went out well, chiefly on the character we gave it in the *Gardener's Monthly*, and we feel this will make as good a figure in peach annals as that excellent variety did.

The fruit is of about the same size, but lighter

than Hale's Early; flesh wholly white and remarkably juicy,—and the white somewhat smooth stone free, from the flesh. The leaves are very long and very narrow,—as a botanist would say linear lanceolate,—and it belongs to the glandless section.

HERSTINE'S RASPBERRIES.—In the days when the gods of the ancients walked amongst men, and ate and drank and clothed themselves as the children of men now do, the raspberry grew only in the mountains of Greece—as a wild plant in that classic land. Mount Idæus, the scene of so many of the loves and hates of these mighty divinities and divinitesses—our own unpatented word, by the way, but as good as editress, reporteress, doctress, or lawyeress—this Mount Idæus abounded especially in raspberries, and no doubt furnished many a feast for those distinguished characters. Its location furnished its name. Linnaeus who must needs Latinize everything, gave the general name of *Rubus* to the raspberry and blackberry family, and the raspberry in particular he named *Rubus Idæus*.

But the raspberries of those days were very different from the raspberries of our time. Improvement has not confined itself to extracting a man from a monkey, as our friends Cope and Darwin assert man descended, but has given us in this fruit a pulpy, luscious berry in the place of the hard, seedy, mountain fruit of the past times; and the aforesaid gods, being immortal, must look down on us with envious sensations, when they contrast the favors we receive with what was vouchsafed to them.

Still it is not altogether by calling on Hercules that the great wagon of improvement has been made to roll along.

Our modern pomologists are not the men to wait on the slow process of "natural selection" in the development of good fruit, and in the case of the raspberry, Philadelphia horticulturists have particularly distinguished themselves in hastening the millenium when every fruit-eater expects to be happy.

Dr. W. D. Brinckle, a Philadelphian, gave the first impetus to improvement by raising a great many superb varieties, amongst which the "Orange" still ranks very high. Then Aubrey introduced, though he did not raise, the "Hornet," and some others. Parry brought out the "Philadelphia," which is still the raspberry of the whole Union. Our worthy merchant, Dub-

ring, raised the good variety which goes by his name; and "The Northern Wonder" is another excellent thing found by one of the Feltens. The most recent laborer in this inviting field, is David W. Herstine, well known to poultry fanciers as well as to horticulturists, and who, at his pretty country place at Branchtown, happily combines the pleasures of a city gentleman with the rural pastimes of the bucolic kind.

His success with seedling raspberries has been very great, and that all the world should see for themselves, he invited a goodly company from different parts of the Union, on Wednesday afternoon last, to meet there and to taste the berries and discuss their merits to their hearts' content. We noticed among the visitors, Messrs. Charles Downing of Newburg, N. Y.; P. Quinn of the New York *Tribune*, Josiah Hoopes, President of the Pennsylvania Fruit Growers' Society, Tobias Martin of Mercersburg, W. F. Bassett of Hamonton, N. J.; H. A. Dreer of Philadelphia; J. E. Mitchell and Robt. Buist, vice-presidents of the Pennsylvania Horticultural Society; Thos. Meehan of the *Gardener's Monthly* and *Weekly Press*; Gen. Pleasonton, Constant Guillon, R. C. McMurtrie, S. N. Winslow of the *Commercial List*, W. R. Wister, T. C. Andrews of New Jersey, C. P. Hayes of Philadelphia, E. Satterthwait, E. B. Reed of Chambersburg, S. W. Noble, M. McHenry of the *Practical Farmer*, Mr. Biddle of the Philadelphia Society of Agriculture, Mr. Schaeffer of the *Evening Bulletin*, Mr. Donks of Delaware county, Mayor Fox, Dr. Taylor of the *Philadelphia Press*, R. Peters of Delaware, Dr. Emerson of Philadelphia, S. B. Jenkins of Chambersburg, R. Otto of West Chester, and a few score of other gentlemen representing various departments of Agriculture.

The chief attraction was one variety named after the raiser the "Herstine." It is a large red berry, quite equal in size and beauty to the old and valued "Hornet," but bearing more abundantly than any variety known. It appeared as if there were almost as many berries as leaves on the plants, which were literally breaking down with the weight of fruit. It appeared to be the unanimous opinion of the large company present that Mr. Herstine had been very fortunate in raising so fine a kind.

There were three other kinds selected, among a large quantity of seedlings, as possessing points of great merit. These are the "Elizabeth," "Saunders," and "Ruby."

Mr H. provided an elegant entertainment for his visitors, who were highly pleased with the fruit and their reception by Mr. Herstine — *Philada. Press.*

**THE EUMELAN GRAPE.**—At a recent meeting of the American Institute Farmer's Club, a correspondent having asked for an expression of opinion about the Eumelan grape, Mr T. O. Payne of East Bridgewater, Massachusetts, said :

"Eumelan grapes began to color about the middle of August, and were good to eat on September 10th, and even before that time they would have been called ripe by many. They grew better all the month. I set their time of ripening before the Delaware, Israella, and Allen's Hybrid. With me the Hartford Prolific got its greatest goodness a few days before the Eumelan. But the Hartfords grew on an old vine while the Eumelans grew on a vine only three years old, and I doubt if the Hartfords would be

any earlier upon a vine of the same age. The Hartford Prolific ceased to grow better, and began to flatten in its taste, and to drop its berries, while the Eumelan kept on improving. My Eumelan vine (three years old), set seventy-nine clusters.

"I picked off sixty-five, leaving but fourteen to ripen, which I thought sufficient for a vine of that age, but the vine grew too vigorously, and could have ripened twenty or twenty-five bunches with an advantage. The vine had not work enough to do. In quality nothing is to be said against the Eumelan, and everything for it. It is the only black grape I have seen that is worthy of being put on a plate with the Iona, Delaware and Allen's Hybrid. A friend of mine has twenty Eumelans growing, now two years old, as healthy and handsome vines as I have ever seen. I consider the greatest danger the Eumelan is likely to suffer from, is overbearing, which grape growers will consider a good fault." — *Hammondsport Cultivist.*

## DOMESTIC INTELLIGENCE.

**DWARF VARIETIES OF ARBORVITÆ, RETINOSPORA, ETC.**—Of this class we find many varieties that have been recommended as suitable for bordering, instead of dwarf box, or for low hedges. The main difficulty, however, which will prevent any of these from becoming popular for the purpose, is their liability here of dying out at the base, and to assume a dark unsightly hue during winter.

We have tried the *Thuja ericoides* as far back as 1860; had no difficulty in propagating it rapidly, but had to abandon it as an edging plant, owing to the tendency of losing its lower branches. The *Retinospora squarrosa*, which is closely allied to the above, seems to be more free from that defect, but it also turns brown in winter. The *Tom Thumb* variety, originated in New York State, is perhaps the most desirable variety for edging, it seems to stand better than either of the first mentioned varieties, but its main, and to us, great defect, is its unsightly color during winter. This defect is lessened

when planted farther North. Cuttings inserted in the ground, as practised for box wood edgings, will strike readily. The most suitable season for the operation is end of October, or so soon as the plants have hardened their fall growth of wood. After being set out, the cuttings must be mulched and watered if the weather should be dry.—MR P. J. BERCKMAN, in *Farmer and Gardener.*

**THE BEST WINE GRAPES**—The Pleasant Valley *Fruit Recorder* says: "Such varieties as Louisiana, Rulander, Hermann, Maxatawney, Herbemont, Cunningham, Taylor, Delaware, Massasoit, among the light colored wines and Alvey and Cynthia among the red wines, will always command ready sales at good price, when once they are made in sufficient quantities, and the public have become acquainted with their merits. True, they may not produce as much as Concord or Goethe, they may need choicer locations and better handling, but we

must be willing to do this, and can afford it, when the prices they bring are so much higher. Another requisite is a light white wine, a wine which will take the place of the Catawba, fully equal to it in quality, and one that can be produced profitably at \$1 per gallon. This we think we have in the Goethe and Martha. The former produces here fully as much as Concord, is vigorous and healthy, and can be grown profitably, even at seventy-five cents per gallon. The Martha, with long pruning, will also yield abundantly, is healthy and hardy, and will, we think, flourish anywhere. These will produce the cheap white wines for the future, the drink of the people, or at least of those who prefer white wines to the Concord for a general drink, as being more smooth and delicate.

**RAMIE PRODUCTION.**—Mr. William Hall, President of the ‘Ramie Plantation Company, of Louisiana,’ states that great improvements have very recently been made in the machinery for preparing the Ramie. The plant may now be cleaned on the field, the refuse being left for manure. The fibre is then dried, becoming comparatively pure, white and silky, divested entirely of gum, and prepared for baling and spinning. The improved machinery was, unfortunately, not perfected until late in the season, when the Ramie had become harsh from a growth of eight months, the tops having been partly killed by frost. It was, therefore, found impossible to produce the fibre in bulk this season. With these improvements, and one laborer to clean the product of ten acres, Mr. Hall thinks one acre will yield at least two tons, making a product of twenty tons to the hand, estimated to be worth \$200 per ton.

Two joint stock companies for the planting and manufacture of ramie have been organized in Louisiana—one with a working capital of \$45,000, the other with a capital of \$165,000.—*New Orleans Picayune.*

**STRAWBERRIES IN MICHIGAN.**—The St. Joseph, Mich., *Herald* gives some interesting facts as to the strawberry crop of that place. Wilson’s Albany is the variety cultivated almost to the exclusion of every other, although many varieties have been tried. The first ripe fruit was found May 24. The first shipment of a crate was on May 27, but the first shipment of any considerable amount was on June 5. Up to,

but not including, June 15 the shipments from St. Joseph and Benton Harbor to Chicago aggregated 19,779 bushels, of which the steamer *Carona* carried 17,964; the other shipments are estimated. The *Herald* estimates the average price received at \$3 per bushel, making a total of nearly \$60,000 for the strawberry crop up to June 15.

#### THE COST AND PROFIT OF GRAPE CULTURE.

—*Hearth and Home*, in a late issue, gives an account of the cost of growing and selling the production of grapes from 2 73 100 acres of vineyard. The cultivator puts down the cost of cultivation from the time of gathering the grapes the previous autumn to the commencement of picking them this year, at \$233 51. This includes cultivating, hoeing and pruning, and 800 pounds of ammoniated superphosphate of lime applied to parts of the vineyard. The cost of picking, packing, and marketing, including freight and commissions, and wear and tear of crates he gives at \$287 88, making total cost for the year \$461.39. His crop of grapes was 14,500 lbs., for which he received \$1,096.76, so that he received \$635.37 profits. In this he does not make any charge for rent of land nor taxes nor for taking the grapes from the vineyard to the railway station. His vineyard contained 2,000 vines in bearing and 250 younger vines. They are mostly Concords, a few, about one-tenth, Delawares, and some Hartford Prolific, Diana, etc. His first Delawares sold at 20c. per pound; his first Concords at 10c.; his Delawares falling to 10c. and his Concords to 6c. before the close of the season. He had about 12,000 pounds of Concords and about 12,000 pounds of Delawares, the remainder being divided by some eight or nine other sorts. By this time it would seem that cost him about 3 1-5 cents to grow and market a pound of grapes; that the average gross receipts were about 7 1/2 cents per pound, and the net proceeds about 4 1/3 cents per pound; or \$232 per acre.

These grapes were marketed in the city of New York

**STRAWBERRIES IN TENNESSEE.**—Everybody is supposed to like strawberries. A failure on the part of any one to like this delicious berry denotes in the opinion of most people a natural defect of taste. Strawberries are not like other things; the largest fish is not the best, and ditto

of almost everything, including men, and especially women. But there is only one thing better than a large sized strawberry, and that is the very biggest strawberry that can be found. Strawberries are sweet children of beautiful spring, a fit expression of her balmy breath, flavored with a little zest giving acid. We have been led into these remarks by a basketful of the largest we ever saw that was left upon our table recently by W. S. Rainey, Esq., fresh from his fine garden. We congratulate Mr. Rainey on his eminent success in the garden line, as well as we do the citizens of our county on having near them such an excellent nursery as the one he possesses — *Home Journal*.

A REMARKABLE PATENT.—New York *Day Book* says: There has been a sort of mystery in the apple and pear department of the fruit-growing branch of agriculture, which has puzzled horticulturists from time immemorial; it is a certain perverseness of certain members of the two families named, with regard to “coming into bearing.” Trees, five, ten, and in some cases even fifteen years old; large and thrifty, in the highest state of health, making wood in enormous quantities yearly, and in every way demonstrating the existence of a condition, which the fruit yielding individual should show, yet no fruit buds are even seen; no blossoms put forth in the spring; and years roll on, disappointing the anxious expectant, till at last he makes up his mind these trees are some abnormal creation in the pear or apple family, which never will yield fruit, and he finally ceases to expect it. We have seen splendid looking trees, of the apple and pear families, fifteen years old that never showed a blossom. All sorts of speculations have been offered by theorists as to the cause of this barrenness, and it is now, we believe, the settled opinion that the vitality of the tree is expended in making wood, leaving nothing to produce the formation of fruit buds. We have seen large pear orchards ten or fifteen years old, one third of the trees of which never bore a single specimen, yet all of them in fine condition, in point of growth and health.

Various modes of treatment have been suggested to meet these cases of barrenness. Root pruning has been found in some cases to change the habits of the tree, and cause the formation of fruit buds, but this pruning of roots is a very damaging remedy. It is like partial starvation,

stopping the supply of food to the tree by cutting off a thousand feeders. It is attended with danger, as the draft upon the reduced vitality of the tree will be too great. The pruning of the roots should be followed by the pruning of the top. The head of the tree should be reduced to as great a degree as the roots, if this system of destroying the feeding agencies of the tree should be adopted.

But, as we have stated at the opening of this article, a remarkable patent has been applied for, and will be introduced to the fruit growing world in a few months, which will astonish horticulturists. It is a discovery of an application by which the pear or apple tree may be thrown into bearing at a very early age, and kept loaded with fruit steadily, year after year. The principle by which this result is produced, we are not at liberty to make known, but that it is correct we have the best of evidence. There are now a large number of trees in full bloom in the pear and apple department, which never showed the sign of a flower till this application was made. To prove the correctness of the principle, any tree in the pear or apple line, of four or five years of age or upwards, which has never blossomed, can be made to show blossoms on one half of the head of the tree, while none appear on the other half. The proof of the efficacy of this treatment is on hand. The application is not in the slightest degree injurious to the tree, as its continued state of high health, under the yearly yield of large crops of fruit demonstrates. Any fruit grower can make the application. It is done instantly, and costs nothing except the cost of the patent right.

PEACHES IN UTAH.—For several years dried peaches have been one of the great staples of Utah, in domestic traffic, sometimes having commanded as high a price 50 cents per lb.—but prices have sadly declined, and have gone down to from 5 to 20 cents. This has proved a great discouragement in this great industry, insomuch that many are cutting down and otherwise destroying orchards of peach trees. In most cases these trees are valueless on account of age, disease, or poor size or quality of fruit, and it would be wise, when the tree is not diseased, to cut away the tops and allow new shoots to grow.

These should be budded with the best of peaches; those of large size and good flavor.

These, by annual pruning as we have elsewhere

recommended, the tree will become vigorous, enduring, and continue to produce crops of large fruit, which when ripe, peeled and dried nicely, will bring a good price and remunerate the producer.

One reason of the price going so low, is the fact that our peaches are generally so small and poor, and another is the reduced price of goods, merchandise, and most other articles of importation and produce.

Last year there was quite a demand East for Utah dried peaches, and this is likely to continue and increase, and if we will go to work, even now, and thin out the tops of our peach trees, removing small and decaying limbs, thereby taking away half the fruit, the remainder will be much larger and better,—now let this be peeled, well cured, and sent to Salt Lake City, the owners will be likely to realize nearly or quite 25 cents per lb., making the produce of our valueless peach orchards quite an item.

We would advise fruit growers in future, to peel all peaches that are to be dried, if of a size to be worth handling.—*Utah Pomologist.*

PLASTER FOR STRAWBERRIES.—Mrs. H. C. Freeman, an extensive fruit grower near Cobden, applied plaster of Paris to her strawberry plants last year. The result was a remarkable growth of vines, and is now followed with a splendid show of fruit; and what is a little remarkable, some days later than vines not plastered. Should this produce the same result on further trial, it will work a revolution in the culture of this fruit, more especially if the phosphates should succeed in the experiments now being made in regard to the insects. Plaster can be had in Chicago at \$11 per ton, in barrels, ground ready for use.

In this connection it is natural to talk about clover, as essential to the fruit grower and farmer of Illinois. We are liable to run after hobbies and leave out the most essential. We may suppose that the phosphates have all the new values attached to them, and that plaster will do wonders for the strawberry plant, yet we know that a crop of clover in bloom turned under, has magic in it, and that it not only supplies plant food, but that it does very much more in changing the mechanical condition of those finely comminuted clay soils of the south part of the State, thus underlocks their fertility. Clover for soiling, when pasturage is so unreliable, cannot be ignored. When a man tells me that his

soil is worn out, I simply tell him that he has locked up its fertility by his improvidence, and clover plaster and deep culture is the key that will unlock it. A crop of clover in the bloom turned under, will so change the mechanical texture of the soil as to insure large crops, and though the phosphates may have certain economic values, the clover cannot be ignored, and should have the first place in our system of tillage.—*Chicago Tribune.*

BUGGING.—Bugging, or catching the curculio, as it is called, is just now an active industry, and the little "Turk" is getting the worst of it. Wheel machines with wide muslin aprons and rubber bumpers bring the little rascals down from their perch, when they are secured; while the chip traps of Mr. Ransom cheats them by offering a hiding place which leads to sure destruction. Dr. Hull, with his theory on the habits of this insect, has had succumb to the plain facts of the St. Joseph investigation, while the entomologists have been shown that plain facts are worth more than volumes of scientific theories. There is no war between the jarring process and the chip traps, for both are practical and valuable, but sharp-eyed fruit growers, who had their property to defend against insect foes, have beaten the men of books and scientific theories in the war of the curculio, and may now safely cry "Eureka," or in plain English, "we know the habits of the enemy, and are enabled to apply a remedy." We shall now see the plum restored to the market so soon as the trees can be grown to bear the fruit, for the battle between the orchardist and curculio has been fought, and the latter worsted, though not driven entirely from the field.

The jarring and sheet process did not cover the entire field of defence, for in jarring many of the insects take wing or fall outside of the sheets, and thus save themselves for the time; but it would appear that most of these prefer to crawl back toward the tree and secret themselves for the day, and at night go up the tree in order to feed on the fruit or to lay their eggs, as the night is the time when they do the most mischief; and it also accounts for the fact that we seldom see them at work, as we have only been in the habit of looking for them in the daytime. In going toward the tree it is natural that they should hide under the chips or pieces of bark placed there for the purpose, and are thus caught

and destroyed. That they winter over mainly in the woods, and seek for a hiding place, is certain, for they come into the orchard from that direction in great numbers. Some days they are caught in large numbers in one orchard, while the neighboring orchard may be quite free from them.

It would appear that Dr. Hull was mistaken in many of his supposed facts in regard to the habits of this very destructive insect, and that to other fruit growers is due the credit of a more practical explanation of their real habits and more efficient remedies. The Doctor held that the insect would only fly when the thermometer was at 70 or upwards. Practically, this was a most important error, as it is now shown that they fly at all times, but more especially in the night. He also suggested that the chip traps would be useful only in the season; but this is found not to hold good, as I found many persons as successful in trapping as in jarring, while some parties were mostly relying upon the former plan. The Doctor's plan of jarring is a good one, so far as it goes, but could not reach all the insects.

The cost of the cureulio catcher is about two dollars, to which is added about fifteen yards of muslin sheeting, which, with the amount expended in the labor of preparing the ground about the base of the trees, say for a space of 20

feet on each side, is certain in its results; but a large number of persons are using both plans with an untiring energy that bids fair to prevent any serious inroad on the crop. This year a little thinning of the fruit might do more good than harm; but this appears to make no difference in the war of extermination, and in every orchard that I visited the machines were busy.

The prediction that Southern Illinois had seen its last crop of peaches is not likely to be fulfilled, at least this year, for never has such a crop been presented to the eye as at this time, and nothing but the "rot," yet to come between the orchardist and his customers, can cut short the supply. There are many instances in which it is not convenient to use the chips, as recommended by Mr. Ransom. Grass, weeds, and rubbish must be all removed, or the work is imperfect. For this reason few are prepared for a thorough trial, and had better rely on the sheets and jarring process. I saw in many instances that the ground had been so imperfectly prepared that but little was accomplished, while in other instances the success had been the most gratifying. I say this much to guard against premature failure. How much of the science of the book, as regards agriculture, must be laid aside with the rubbish of the ages is not certain; but no doubt there is a large amount of it.—*Chicago Tribune.*

## FOREIGN INTELLIGENCE.

**BOUGAINVILLEAS**—These are amongst the most beautiful plants in the vegetable kingdom; but very difficult to flower. We do not know of any flowering in American hothouses, though the plant is often met with. A correspondent of *Gardener's Chronicle* thus describes his mode of treating them:

"I will now proceed to give a few plain directions for their treatment, which, if followed out, will not fail to produce blooms. If they are to be seen in their full beauty, they must be planted out, and allowed to fully develop themselves. Then we can get beautiful branches of bloom from 3 to 6 feet long. I would recommend any

one receiving a young plant to proceed as follows:—If small, give it a shift, and plunge it in a cucumber or melon house, or a pine pit, with plenty of bottom heat. Shift on as often as the pot becomes filled with roots. It will fill a 13 inch pot with roots in the course of one summer. Train out the branches to their full length, and withhold water about August for the purpose of thoroughly ripening the wood. Stand the plant away in a warm corner of the stove for the winter, only giving sufficient water to prevent its leaves from dropping off. Early in the spring, prepare a pit for it, 3 feet wide and 6 feet long, and larger in proportion if more than one are to

be planted in it. This may be prepared just in the same way as a pit for cucumbers or melons, with a hollow chamber under it, and two or more pipes running underneath for bottom heat. Plant out in this bed in good friable soil, consisting of leaf mould, rotten dung, and sandy loam, with a little sand and peat, and charcoal if obtainable. Water sufficient to settle the soil, which keep a little moist through the growing season. Be careful to dry off and ripen the wood thoroughly before autumn, then keep the plants dry till January, when they will begin to show bloom, and when they may be gradually moistened by giving water in a sufficient quantity to wet all the soil. I have never seen them bloom better than in several cases where they have been planted out at one end of a cucumber or melon house, and where they have been subjected to about the same treatment as these plants, with their roots growing in the same bed with them."

**FLOWER MARKET FOR THE LONDON POOR.**—The "Flaneur" of the *Hackney and Kingsland Gazette*, affords his readers a bit of cheerful information as follows: The love of flowers is indissolubly connected with the human soul, whether it be in the lordly Belgravian or the lowly Bethnal-Greenian. The dahlia and tulip shows—albeit they used to be held on Sunday morning in or about the Birdage Walk—evinced such an affection for nature and its beauties as put in the shade the more gaudy shows of Chiswick and Regent's Park. Spenser affirmed that "entire affection hateth nicer hands," and he was right. Full of the knowledge of this fact, and to aid the poor to make "a sunshine in the shady place," Miss Burdett Coutts is about to inaugurate a Flower Market in Crab tree Row, abutting on to the Hackney Road, and contiguous to the Fish Market, sacrificing, in her benevolence, about £6,000 worth of building land thereby. Upon the ground, which it is intended to plant with trees, a fountain will be erected, and directions are given, I understand, to her manager of Columbia Market to receive offers from persons wishing to lay out plants and flowers for sale thereon—free of rent. I dare say many a sneer will pass in regard to the analogy between fish and flowers; and wise shakes of empty heads will doubtless attest their owners' opinions that it will never answer. Time will tell. Persistence in the cause of good will sur-

mount all difficulty; but, swim or sink, sneered at or not, the noble lady, in the language of Massinger—

"———Well deserves  
Her name—the MAID OF HONOR! May she stand,  
To all posterity, a fair example  
For noble minds to imitate!"

**DEPTH OF RAIN IN VARIOUS CLIMATES.**—In Lombardy nearly nine inches of rain have been known to fall in one day, and twelve inches in Calcutta, or nearly half the mean annual quantity of rain on the east coast of England. During one single storm, which Castlenau witnessed at Petras, on the Amazon, there fell not less than thirty inches of rain—nearly as much as the annual supply of our west coast. The hollow trunk of an enormous tree in an exposed situation gave the French traveller the means of accurate measurement.—*The Tropical World, Hartwig.*

**THE OLDEST TREE IN EUROPE.**—The oldest tree on record in Europe, is asserted to be the cypress of Somma, in Lombardy, Italy. This tree is believed to have been in existence at the time of Julius Cæsar, forty-two years before Christ, and is therefore 1,911 years old. It is 106 feet in height, and 20 feet in circumference at one foot from the ground. Napoleon, when laying down his plan for the great road over the Simplon, diverged from a straight line to avoid injuring this tree.

**TRANSPLANTING A LARGE TREE.**—At Elveden Hall, the seat of the Maharajah Dhuleep Singh, considerable interest has been excited by the successful removal of a very large tree, under the superintendence of Mr. Barron, of the Elvaston Nurseries, Derby. The remarkably fine specimen of purple beech thus transplanted is nearly 50 feet high, the diameter of the branches 58 feet, and the circumference of the stem at about a foot from the ground 7 feet 8 inches. The mass of soil and undisturbed roots measured 16 feet by 14 feet, the roots extending 6 feet beyond, and the whole weighed considerably over 20 tons. A platform of strong timber was constructed underneath, and the tree was raised upon rollers laid on planks, by means of powerful screw-jacks. This being done, the tree was drawn on to its new site with the aid of pulley blocks of unusual size, being maintained throughout in an upright position.

**THE CHANGEABLE FORGET-ME-NOT.**—All the Forget-me-nots have been tried as pot plants in the alpine house, and only one of them proves to be well adapted for the purpose, and this hap-



pens to be the best of the Forget-me-nots for any purpose. *Myosotis dissitiflora* should be grown in pots one whole season out of doors to make a pretty specimen to flower in the house in spring. If well done, it forms a dense cushion of bright green leafage quite covered with its lovely flowers, which at first are of a most delicate pink hue, but afterwards acquire a tint of palest azure. If flowered early in a warm house, the flowers are at first pure white. In either of these conditions it is a gem of the first water.—*The Gardener's Magazine*.

**DWARF FRENCH BEANS.**—Dwarf French Beans are most valuable, provided the right sorts are grown. For small gardens one variety will be quite sufficient, and that variety should be *Negro Long-podded*, which is undoubtedly the best flavored and the heaviest cropper. There are several other very good sorts, and if more than one kind is wanted, *Canterbury Early White* and *Dark Dun* can be recommended. Haricot Beans are not worth growing for use in a green state, and for use, when ripe, they can be purchased much cheaper than they can be grown in this country. A warm position should be selected for French beans, especially in the northern parts of the country, because, unlike the peas and many other vegetables, they must have a moderate degree of heat to enable them to grow and bear well. The soil should also be rich, and the beans gathered as fast as they are large enough for use, because when they are allowed to remain upon the plants for a length of time afterwards, they not only become too old and tough for use, but they check the growth of the plants and put a stop to their productive powers. For dry seasons the varieties belonging to this section are undoubtedly the best, and most profitable vegetables that can be grown in gardens of all sizes. The drought does not affect them very seriously, although they do not of course remain in full bearing in summers like that of last year so long as they would in seasons in which they could enjoy a greater amount of moisture, both at the roots and overhead.

It is a very common falling to sow dwarf beans almost as thick in the rows as mustard and cress, under the belief that it is necessary to do so. A much greater fallacy could not well exist, for a row in which each plant has sufficient room will bear a much heavier crop than a similar row with three times the number of plants in it. It is a good plan to sow in double rows and to al-

low a space of three inches between the two rows, and of six inches between the plants in each row. Two feet must be allowed between the rows to admit of the crop being gathered with any degree of comfort; but a greater return will be harvested when three feet is allowed, provided the soil has been manured recently or has not been too much impoverished by the previous crop.—*The Gardener's Magazine*.

**SIZE OF ONIONS IN ENGLAND.**—In December last I trenched a piece of ground 25 yards square, to the depth of two feet, just deep enough to bring three inches of clay to the surface. After it had remained in a rough state for six weeks I forked in a good quantity of strong manure—principally refuse from the garden—and on the 10th of March sowed the seed in drills 18 inches apart. One-half of the ground I sowed with the Nuneham Park, the seeds of my own saving; the other half I sowed with Danvers' Yellow and Giant Rocco.

To-day (August 15th.) I have measured some bulbs of the Nuneham Park, and I find that they are fully 13 inches in circumference. The largest of Giant Rocco are 11 inches in circumference, and Danvers' Yellow 10 inches. They have not had a drop of water except that which has fallen from the clouds, and we have only had very little here.—*Cor. of London Journal of Horticulture*.

**THE OLDEST ROSE TREE**—The oldest of all rose-bushes is said to be one which is trained upon one side of the cathedral of Hildesheim, in Germany. The root is buried under the crypt, below the choir. The stem is a foot thick, and half a dozen branches nearly cover the eastern side of the church, bearing countless flowers in summer. Its age is unknown, but documents exist which prove that the Bishop Hezilo, nearly a thousand years ago, protected it by a stone roof, which is still extant.

**A NUT-TREE WITH A COLLAR ON**—A story has been going the rounds about a filbert tree which grew up through the hole of a millstone, filled it, and ultimately hoisted it off the ground, and wore it like a rattle around its trunk, although it was five and a half feet diameter, and seven inches thick. Some are sceptical about this story; but, nevertheless, growing trees have a great lifting power, as may be proved by sight any day in the cemetery at Old Cambridge, where a small tree which has apparently sprung from

a seed inclosed in a heavy tombstone has grown through a chink between two stones, lifted the heavy superincumbent masses of stone some inches, and pushed a stout iron railing off the perpendicular by the force of its growth. — *Gardener's Weekly*.

**DAPHNE MEZEREUM** — It is not generally known that there are at least four varieties of this common shrub. The typical plant (or that which we regard as such) as met with in our woods usually presents flowers of a fine deep pink color. This form of plant is subject to a few variations, the result of soil and climate perhaps, but the range of variation comprises only two or three shades of pink. The red variety, called *rubrum*, is less pleasing than the deep pink, but still very pretty. The white variety, called *album* surpasses all the rest, and for its size and season is the best hardy shrub known. As a wilding, it is extremely scarce; as a garden plant it is by no means plentiful; as "a thing of beauty and a joy forever," it may be said to be comparatively unknown. If any one were to ask me to convey an idea of its appearance when in flower, I should proceed in this way: You know the double-flowering cherry, one of the most cheerful and bonny of the many trees that fill our gardens with snowy garlands in spring? Yes. The white mezezon is a counterpart of that in miniature, and if there is a shade of difference as to their respective merits, the mezezon is without question the prettiest of the two. It is, however, unfair to make a hard comparison, for the cherry is a noble tree and the Daphne a tiny bush — *The Gardener's Magazine*.

**ANEMONES IN POTS.** — All the small growing and early flowering anemones make lovely pot plants for the alpine house, and ought so to be grown in every garden where the best of the herbaceous and alpine flowers are appreciated. It has been one of my special pleasures since the 1st of March to have a daily peep at the anemones, some of them presenting their large mauve-colored or intense scarlet flowers over a cushion of elegant and ample leafage, others dotting their neat green tufts with delicate blush, rose, or white flowers. So extremely pretty are they, even now that their flowering is nearly over, that the hyacinths in the same house afford me far less pleasure. It is no small advantage in their favor that they require but little attention to ensure the most agreeable re-

sults, and, unlike the *Myosotis* recommended for the house, need not be grown in pots during the summer; in fact, will do far better in the border. If taken up and potted when they are dying down naturally, and kept in a frame or pit until the end of a year, they will then be sufficiently established to throw up their leaves and flowers abundantly as the days lengthen and the spring is promised. As to the most suitable varieties, there can be no doubt at all, but we must not, in this note touch the large question of species and nomenclature. Rather let us select them by their trade names, because those names afford the surest indications of them for the purposes of the garden. I find in Ware's catalogue the following spring flowering kinds that are adapted for the alpine house, viz.: *apennina alba*, white flowers; *coronaria*, various colors; *pulsatilla*, puce; *ranunculoides*, yellow; *nemorosa*, white; *nemorosa rosea fl. pl.*, double rose; *stellata* in three varieties, perfect models of pot plants for the alpine house; *fulgens*, brilliant scarlet; *thalictroides*, white. As it is not possible for all our readers who value pot plants to purchase and cultivate all that are recommended, the best advice that can be offered to such as tread their way timidly is to begin with *A. stellata* and *A. fulgens*, for they are the very best for pots, and so showy that they might be safely grown in thousands for Covent Garden Market. — *The Gardener's Magazine*.

**LILIES AT THE LONDON SHOWS.** — A London correspondent of the *Dublin Record* thus writes:

"A remarkable hybrid lily was exhibited at the meeting of the Royal Horticultural Society on the 3rd inst. It was a true hybrid, between *L. auratum* and *L. lancifolium speciosum*, and had petals similar to those of the *L. lancifolium* type, but broader and smoother, and consequently with the flowers much less reflexed. In color the flowers were white, and had not the golden rays peculiar to *L. auratum*, the flower was exquisitely fragrant, and the foliage was intermediate between the two, though perhaps partaking rather more of that of *L. auratum*. It was exhibited by Mr. George Thomson, Stanstead Park Gardens, Emsworth, Hants, and awarded a first class certificate. Mr. George F. Wilson, the treasurer of the Royal Horticultural Society, who deserves much praise for his efforts in classifying the various specimens and varieties of lilies in cultivation, received the

same award for a double form of *Lilium trigynum*, with several rows of petals, which very much interested horticulturists. This is a very much superior double flower to that of the common white lily, *L. candidum*, to be occasionally met with in gardens. Mr. C. Turner, of Slough, also received the same award for a very fine va-

riety of *L. auratum*, densely spotted with deep purple, and having that color also as a shade to the golden bands. Mr. W. Bull, King's Road, Chelsea, also had three nice varieties of *L. auratum*, one of them nearly pure white, and named *Virginialis*; and Mr. Wilson also had *L. Leichlinii*, having yellow flowers with pale spots.

## HORTICULTURAL NOTICES.

### PENNSYLVANIA HORTICULTURAL SOCIETY.

#### JUNE MEETING.

Successful as was the previous meeting of the Pennsylvania Horticultural Society, the June meeting—the last until September—eclipsed all, both in the number and character of the visitors, and the quality of the fruits and flowers on exhibition. We can only furnish a brief account of a few of the leading points which struck us particularly, as an hour in such a place, and amidst so many thousands of people, is entirely to limited a time to do full justice to it.

Amongst the flowers the Roses, cut specimens, were the leading attraction. In Dreer's collection we noted as an excellent variety, Elize Morrell, a pale rosy-cupped variety—a class of hybrid perpetuals we prefer. Josephine Beaubarnais is another older one, something like it, but darker. Amongst the Bourbon roses was Madame St. Charles, a beauty almost equal to a hybrid perpetual. The old Souvenir d'un Amie—a tea of great beauty, but too rarely seen. Another pretty tea rose is Mont Plaiser, a yellow between Gloire de Dijon and Marechal Neil.

Mr. C. Bellett, gardener to L. Vandusen, had also roses, many of which were of superior size. Imagine Anna de Diesbach and Lord Raglan five inches across.

In G. N. Earle's roses we are reminded by a fine Sombriol to note, that it is one of the hardest of these half hardy Noisettes.

Mr. Earle is also our best amateur in Lily culture, and exhibited a collection of some 20 varieties of the old orange variety. Color seems a type of the species, the differences here were chiefly in the shading, sizes and spotting—they were all of varying tints of orange.

H. A. Dreer had some remarkably pretty Gloxinias. Every one knows that a few years

ago the Gloxinia sported into a tubular section, with upright flowers; now we have some with nodding tubular flowers. Hieroglyphic, Rose d'Amour and Hermine were pretty of this class. Another, Panthere, was spotted on the inside like a fox glove.

Dreer also had some very well grown Fuchsias. They were all 8 or 6 inch pots, and yet were two feet high, and well proportioned. Starlight, Roderic Dhu and Purple Prince were very distinct kinds. Also some nice fancy Pelargoniums, Prince Charlie and Cloth of Silver being particularly nice.

Amongst Mr. W. H. Harris' plants was an exceedingly well grown plant of the Fern, *Polystichum angulare*, also of the variegated *Cobæa scandens*.

Mr. Hugh Graham had a large number of fine specimens of many rare plants, some very pretty orchids, especially a *Cypripedium barbatum*, with six flowers; and an *Epidendrum virescens* with twelve. *Philodendron pertuosum*, with its curious leaves and delicious fruit; *Acostus Zebrius*, with its singular velvety leaf.

Charles Crawford had an *Amaryllis alba striata*, with a flower on a stem two feet high; and another plant of the Geranium, General Lee. There is no question about this being the most beautiful zonale or bedding Geranium out. It has an immense number of rosy scarlet flowers in a compact head, which seem to bloom altogether instead of a few at a time as so many of these Geraniums do.

Mr. Gebhard Huster had as usual a very nice collection of hot and greenhouse plants.

Mr. Alexander Newett, gardener to H. Pratt McKean, Esq., had some magnificent Pelargoniums, measuring about three feet high by three feet across. Much care and skill must have been devoted to their culture. There are always

some rare and beautiful orchids in this collection, to-day there were *Cattleya Mossie* with four flowers, *Maxillaria tenuifolia* with 50; *Brassia verrucosa*, six spikes of 12 flowers each, which is very fine for this species; also a very well flowered plant of *Laelia purpurascens*.

Mr. T. J. Mackenzie had a plant of *Sanchesia nobilis* coming into flower and the very pretty variegated plant, *Polkmonium variegatum*. He exhibited also a curious thing from Costa Rica, brought by M. Lachaume. It was a *Bilbergia* with a stem about eighteen inches thick, but yet not more than three feet high; and the hard scaly flower bracts gave the plant a carved stony character, as if it might have been a fossil,—a petrified organism of some past age.

In Mrs. Bissett's lot was a very nice plant of the new and beautiful *Peperomia maculosa*.

Mr. Geo. Huster, gardener to Alex. Cummings, Esq., had chiefly *Caladiums*, very well grown, among his plants.

Sweet Williams of a peculiar breed, were the chief attraction in Mr. David Ferguson's lot, and a well flowered *Plumiera* in the collection of Mr. Thos. Smith, gardener to Matthew Baird, Esq., caused many enquiries as to the name and history of so curious a thing.

Mr. Henry A. Gibson contributed an *Agave Chiapensis* in flower. This is a very rare and beautiful species. The leaves were about 3 feet long and two inches broad, and the flower cup rose to five feet. The flowers were greenish, as in the common century plant.

In Mr. Buist's collection we always expect to find rare plants. Now he had a fair specimen of the *Acalypha tricolor* and *Lantana Don Calmcy*, a pretty white with yellow eye; several orchids, particularly *Epidendrum verrucosa*, a *Cypripedium barbatum*, about the same as Mr. Newett's and an *Oncidium sphacellatum*, which had a three feet spike and 36 flowers. The best specimen of *Clerodendron Balfouri*, notwithstanding the many good plants which have been exhibited, was also here.

In regard to fruits, the Strawberries were very fine, and would have puzzled even a strawberry king to decide which variety on exhibition to specially admit to royal favors. Wm. Parry had 20 kinds. His Boyden's 30, a very large dark red, had many admirers. The Kentucky, a large red wedge shaped fruit, was barely ripe. It is valued as a late one. Triumph of America, a light scarlet, and very regular conical fruit, was in this and almost all the collections, from

which it would seem to be popular. The Romeyn was flat, and cockscomb, and rather darker than we have before seen it. *Triomphe de Gand* did not seem so much like Romeyn Seedling as the plant growing would lead one to expect. All the fruit in this collection was large and fine, and it was difficult to decide which would be considered the best looking, though probably Boyden's 30 would be so considered by most persons.

In Satterthwait's collection, besides most of the kinds named above, were some excellent *Juncundas*, so regular and beautiful, that probably Knox himself would kneel before them.

Dreer had in his collection, some Dr. Nicaise, very large and cockscomb-like; and some Napoleon III. something similar, but the seed fewer and closer set. Dr. Nicaise appeared to be the largest berries shown; but the numerous rifts in the fruit would prevent their being so heavy as some other berries. We found Napoleon III. quite a favorite with many growers.

Mr. D. W. Herstine had some remarkably fine kinds, amongst which Bonte de St. Julien, was especially attractive.

John Mitchell had remarkably fine *Triomphe de Gands*.

Satterthwait had many plates of cherries, Belle de Orleans being the best. He also astonished the multitude with lots of Cucumbers 20 inches long.

But perhaps the most interesting part of the exhibition to a fruit grower, was the grapes from Miss Hettie Trimble of West Chester, who has not only shown that fruit culture will pay, but that a woman can do it. Such fine bunches as these we think were never exhibited here in June. The bunch of Bowood Muscat was about 14 inches long by 6 inches wide, the berries being very large; and the Black Hamburg, Muscat Trouveron and Muscat Hamburg being proportionately fine.

Mr. Felten had some Early Richmond and Early May cherries, to show their distinctions. The former had stems, but about an inch long; the Early May had stems double this, and the fruit a little darker. Chas. Lippincott had perhaps the best cherries, exhibited in the shape of a plate of May Dukes. In the vegetable line Dreer's Hanson Cabbage Lettuce was very showy and attractive. Several different sets of varieties of Asparagus were exhibited; but unless the "proof of the pudding is in the eating," we could see no difference.





PINUS PINASTIS

*Table Mountain Pine*

*Pinus pinaster* L. *Pinus pinaster* L.

# The Gardener's Monthly.

DEVOTED TO

*Horticulture, Arboriculture, Botany and Rural Affairs.*

EDITED BY THOMAS MEEHAN.

---

*Old Series, Vol. XIII. SEPTEMBER, 1871. New Series, Vol. IV. No. 9.*

---

## HINTS FOR SEPTEMBER.

### FLOWER GARDEN AND PLEASURE GROUND.

There is not so much enjoyment in summer as in spring flowers. After the total absence of floral beauty during winter, the spring blossoms are doubly welcome—and then the season of the year renders them enjoyable beyond anything that the heats of summer will allow. From now till November the hardy flower roots will be sought for as amongst the most interesting of spring flowers

Unless very well acquainted with the varieties of Hyacinths and other bulbs, it is best to leave the selection of the kinds to the dealer. The best manure for all kinds of bulbs is rotten cow manure. Half rotten stable manure, or rank matter of any kind, is not good. Very rich garden soil, without manure, is better than to have this matter fresh.

Of *Tulips* there are many classes. The single dwarf varieties are very early; the double ones of the same class come next. The Parrot Tulips, so called from the singular warty edges of the petals, are the next earliest, and then the Tulip so well known for its large, full cups of all colors.

The next most popular bulb is the *Narcissus*, of which there are only white and yellow varieties—but these so varied in shade and shape as to afford a dozen or more of single and double kinds.

The *Crocus* is another popular bulb, as there are so many shades of color, white, yellow, blue, and the many shades between, they make gorgeous masses in the spring flower garden. They have a beautiful effect when placed in clumps on the lawn, where the flowers come through

and expand before the grass begins to grow. The sloping sides of a terrace are often made to blaze with beauty in this way; and besides, the extra warmth of these terrace banks, when full to the sun, make the roots flower much earlier than they will in the level garden ground. Crown Imperials have been much improved of late years, and there are now some dozen or more of varieties. But the old Red and the old Yellow are good things to have at any rate.

The *Snowdrop* is, perhaps, the earliest to flower of all bulbs, being, in Philadelphia, often out by the 1st of March. There are the double and the single both desirable—but the last we think the prettiest. They should be planted where they are to remain several years, as the after-removal, as with other bulbs, is not favorable to an abundant bloom.

*Persian Iris*, *Ranunculus*, and *Anemone*, are very popular and beautiful bulbs in Europe, but do not reach anything like the same perfection here.

Among the miscellaneous hardy bulbs, which flower early and are very desirable, are Japan Lilies of all varieties, and all kinds of Lilies, although they are scarcely to be ranked with spring flowers—many of them, indeed, not opening till July.

Then there is the *Allium moly*, two kinds, yellow and white; *Camassia esculenta*, a plant of the Squill family, and very pretty; *Erythronium*, white and yellow; *Leucojum aestivum*, and *L. vernum* with white flowers; various *Ornithogalum*; the American *Pancreatium*; *Scillas* of various kinds, especially *S. Sibirica*; *Zephyranthus atamasco*, and we may add the various *Ponias*. These are all hardy, and really good things.

The *Lily of the Valley* can be treated as a bulb by planting out beds in the fall, and will always be admired when well grown. Like the *Snow-drop*, however, it does not like frequent changes of locality. It prefers a good top dressing to a transplanting.

Preparing for spring, also, many flower seeds should be sown in September. The *Pansy*, especially, everybody has, as it is one of the most cheerful and loved of all spring flowers. *Wall-flowers*, *Carnations* and *Hollyhocks* should also be sown. The young seedlings must be protected in winter; but this is easily effected by drawing a little earth over the plants, entirely covering them. Next to snow, earth is the best plant protector. In sowing seeds remember that, in all cases, it is best to sow on a little elevation rather than on a full level with the ground.

As the planting season arrives, it is as well to repeat what we have often remarked, that the relative advantages of spring and fall planting are about evenly balanced. Failures follow all seasons. *How to plant* is of far more importance than *when to plant*; and the selection of stock to plant, of far more importance than the time when it is done. A tree that has been once or twice before transplanted, and again carefully and intelligently taken up, may be successfully removed at either planting season, with the odds of perhaps one hundred to five in its favor. But a tree never before transplanted—such, in fact, as a tree from the woods, or left standing in the nursery from the seed bed, is very risky at any time, and depends rather on the weather following transplanting for the first few weeks for any probability of success. In selecting trees for planting, then, be very particular to ascertain that they have an abundance of fibrous roots, and are carefully removed. In this region, we would plant evergreens at once, after or in prospect of the first good rain. Deciduous trees we would plant just before the final fall of the leaf, shortening off the ends of those shoots that were not quite mature. After the 15th of October we would not plant evergreens, nor deciduous trees after the first of November. Early or not at all should be the motto.

Propagation of stock for next year's budding should proceed vigorously. The best way to propagate all the common kinds of bedding plants, is to take a frame or hand-glass and set it on a bed of very sandy soil, made in a shady place in the open air. The sand should be fine

and sharp, and there is, perhaps, nothing better than river sand for this purpose. The glass may be whitewashed on the inside, so as to afford additional security against injury from the sun's rays. Into this bed of sand, cuttings of half-ripened wood of the desirable plants may be set, and after putting in, slightly watered. Even very rare plants often do better this way than when under treatment in a regular propagating house. In making cuttings, it is best to cut the shoot just under a bud,—they root better, and are not so likely to rot off and decay. A cutting of about three eyes is long enough for most strong growing things, such as geraniums, fuchsias, &c.

Small growing things, of course, will take more buds to the one cutting. From one to three inches is, however, long enough for most cuttings. They should be inserted about one-third of their length under the sand, which latter should be pressed firmly against the row of cuttings with a flat piece of board,—not, however, hard enough to force the particles of sand into the young and tender bark, which is often the first step to decay. For a few cuttings, they may be inserted with a dibble; but where many are to be put in, it saves time to mark a line on the sand with a rule or straight edge, and then cut down a face into the sand, say one or two inches deep, when the cuttings can be set against the face like box-edging.

All amateurs should practice the art of propagating plants. There is nothing connected with gardening more interesting.

Many kinds of bedding plants of succulent or sub-fleshy growth, can be taken up from the flower beds on the approach of frost, and cut in, say one-half, and packed thickly in boxes of soil, and kept in a rather dry and cool cellar through the winter. Such fine plants make a much better show in the beds the next year than the plants of the present season's striking. A cellar is one of the most useful appendages to a garden. Were we to have only one choice, we should prefer a cellar to a greenhouse for its general usefulness.

We have had many inquiries recently about cold pits for the protection of half-hardy plants through the winter, and in reply, reprint the following from one of our back volumes:

Those who have no greenhouse, and yet are desirous of preserving many half-hardy plant through the winter, employ *cold pits*. We reproduce from a former volume directions for making them:



Choose the dryest situation in the garden, and sink about five feet deep. It is important that no water can be retained at the bottom. The pit may be of any length required, and about five feet wide, so as to accommodate six feet sash. The inside of the pit may be built up of boards, or, if something more durable and substantial is required, brick or stone. The body of the frame may be built up a few feet above the level of the surrounding soil, and the earth which comes from the pit be employed in banking up to the upper level of the frame. Shelving should be made for the inside so as to extend from the base of the front to nearly the top of the back, on which to place the plants in pots. In the space which will then be under the staging, hard wooded and deciduous plants, as lemon verbenas, fuchsias, &c., may be safely stored, while the more succulent kinds are shelved overhead. The plants to be preserved in such a pit should be potted early, and be well established and healthy before being pitted; much of success depends on this. The less water they can be made to live on without withering through the winter the better will they keep. Straw mats must be employed to cover the glass when freezing time commences, and when the thermometer is likely to fall below 20°, straw or litter should be thrown over. Board shutters are also excellent, as it keeps the snow out from the straw and litter, which sometimes makes the mats very awkward to uncover when we would like to give air. Very little light or air will be required through the winter when the plants are not growing. If a good fall of snow cover the pit, it may lie on undisturbed two weeks or more without injury. When a warm dry day offers, the sashes may be raised if convenient, to dry up the damp. Many kinds of border plants can be kept over winter this way with little trouble.

#### FRUIT GARDEN.

The planting of the Pear, Apple, Plum and Cherry will soon be in season; Peaches, Apricots and Grape Vines, except south of the Potomac being for the most part left till spring. Choose a dry piece of ground. If not naturally dry, it is best to throw the earth up into banks or ridges and plant on them. This is cheaper and better than underdraining. In planting, if the roots appear deep, cut away some of the deeper ones, and shorten some of the top of the tree at the same time. This is particularly true

of dwarf Pears, which are often grafted on rather long Quince stocks. Cut away all of the Quince root but about six inches, and if this should be found to leave few roots, cut away the top correspondingly. Most of the failures with dwarf Pears come from bad Quince roots, so deep in the ground the lower parts decay, and this decay gradually communicates upwards until the whole system becomes diseased. The more tenacious the subsoil the more necessary is it to attend to this matter. We spoke of pruning in proportion to injury. It will be found that all trees are a little injured by removal, therefore all trees should be a little pruned at transplanting.

In preparing for planting trees, the soil should be stirred up at least two feet in depth. Of course, the trees should be planted in the holes only so deep as they stood in the ground before, rather higher, if anything, as the soil will settle. Good common soil may be filled in the holes if the natural soil is very bad; but anything applied as manure may be stirred in the surface soil after the trees are planted.

Some talk, in preparing an orchard, about making "one large hole" for all the trees. This seems witty, but it is an expense which very few orchards will ever repay. Water is likely to stand in the deep holes we recommend; but in such cases we would, rather than go the expense of subsoiling the whole orchard or underdraining, plant higher than they grew before—higher than the surrounding soil, mounding the earth, as it were, above the level. No water will ever stand here. And the money usually spent on making "one big hole" of the "whole" orchard, or in underdraining, we would spend in annually surface dressing the ground.

Trees that have long stems exposed to hot suns, or drying winds, become what gardeners call "hidebound." That is, the old bark becomes indurated,—cannot expand, and the tree suffers much in consequence. Such an evil is usually indicated by grey lichens which feed on the decaying bark. In these cases a washing of weak lye or of lime water is very useful; indeed, where the bark is healthy, it is beneficial, thus to wash the trees, as many eggs of insects are thereby destroyed.

The old practice of slitting hidebound Cherry and other trees with a knife, had much more sense in it, than some of our leading minds are ready to admit.

## HOT AND GREENHOUSE.

In the greenhouse, repairing and thorough cleansing must not be delayed. Painters say this is the most advantageous month to paint wood-work. Whenever the night temperature falls to 40°, any tender plants in pots should be housed, without waiting for the "first week in October." Things nearly hardy, as Azalea, Rhododendrons, Oranges, &c., do best out "to the last."

Any desirable plant for forcing, that may be growing in the open border, if potted early in the month, will do very well for that purpose. *Weigelia rosea* does excellently this way, as also does *Jasminum nudiflorum*, *Forsythia viridissima*, many *Spiræas* and Persian Lilacs. Roses and other things intended to be forced early, should have as much air, and be kept as dry as possible without injury. Hyacinths and other bulbs should also be potted as soon in the month as they are obtained; the former are best planted an inch deep. The earlier bulbs are potted the finer they flower—you may get *catalogues* of any number of kinds or colors, at the *auction marts*. If you get ten per cent. as represented, when they flower, you will be favored.

*Mignonette*, *Rhodanthe Manglesii*, and similar ornamental annuals essential for winter blooming in well-kept houses, should be sown at once. Many things for next season's flowering, must not now be forgotten. The pansy, *calceolaria* and *cineraria*, are in this class. Plants of these that have been kept over the summer, will require a re-division, and kept in a close frame a few days afterwards, till they get re-established. Propagation of all things will still require constant attention. It should always be an aim to possess one duplicate plant as a provision against accidents. In many cases, young plants are preferable to old ones—so that the old ones may be destroyed when these are obtained.

In the hothouse, the *Æschynanthus* will soon be the chief ornament of this division. Their number has increased so that they have become quite a feature. If the pots seem full of roots, they may still have another shift. They prefer very fibrous peat; or, if that cannot be had, turfy loam mixed with a portion of coarse moss. They will, however, do pretty well in small pots. *Achimenes* and *Gloxinias*, as they go out of flower, should be kept dryer and cooler. Look well after a good stock of *pentas*, *cestrum* and *habrothamnus*; they will go far towards keeping up the interest of the department in winter.

*Justicias*, and acanthaceous plants generally, will probably require another shift, if fine specimens are desired. The atmosphere, if the house be light, can scarcely be too moist for them. *Plumbago rosea* is one of the most valuable stove plants we know for winter flowering; it requires a strong heat. *Clerodendrons* as they go out of flower, should be kept in a very airy situation, and rather dry, preparatory to being cut down, and treated like a *Pelargonium* for another year. Many *Begonias* will be past their best flowering stage: very little watering serves them; they are very liable to damp off by incaution in this respect.

It is difficult to lay down rules for orchidæa, so much depending on the circumstances under which they are grown. Those which have finished their growth—as many *Dendrobiums*, *Oncidiums*, *Catasetums*, &c., whose flowers appear just before new growth—should have their supplies of moisture gradually lessened. The temperature, also, is better gradually lowered a few degrees, and they should be allowed more light than usual. The period when they are about completing their growth is the most critical, as any check at this time spoils the prospect of much blossom for next season. Those which flower from the young growth, as *Catleya*, *Laelia*, *Broughtonia*, &c., will require their moisture and heat rather increased than otherwise till after their flowering. *Vandas*, *angræcums*, *saccolabiums* and other strong rooting aerial kinds, will require constant humidity, until it is evident, from the point of their roots, that they desire to stop growing. We are often asked "how often orchids require to be syringed?" If the situation in which they are growing be favorable,—that is retains in it atmospheres a regular humidity,—they will require very little attention; in many cases not requiring the syringe once a week. Where this cannot be effected, the syringe must be oftener applied. As a rule, I think no better one could be offered, than to syringe orchids just so much as will barely keep moss attached to their block, and baskets green and growing. The real terrestrial orchids will require no moisture at all after they have completed their growths, until they show signs of pushing again. Care against checks in temperature and humidity is one of the secrets of successful orchid growing. Those which are at rest do well in a temperature of 60° at the lowest. Those which are growing well should be kept at about 80°.

## VEGETABLE GARDEN.

Earth up Celery as it grows, not letting the soil get to the heart, or it will rot. Soap suds, or other manure water, helps it wonderfully at this season. Dig and house Potatoes. Too large a pile will heat, and any way they keep best when cool, and with some soil mixed through the heap. Sow Red-top Turnip for main crop; rich soil is essential. Transplant

Endive; this also likes a rich loamy soil. It does not do well on sandy soil. Sow Radish and Lettuce for fall crops. Sow Cauliflower and Early York Cabbage about the middle of the month. Onions sown in fall make fine early bulbs for next year. Sow prickly Spinach in very rich soil, for use through the winter and early spring.

## COMMUNICATIONS.

## NEW MODE OF GRAFTING.

BY MR. J. H. CREIGHTON, DEL. O.

I will state an experiment that proved successful with me this spring in grafting a pear tree of pretty large size, and which I hope will prove useful in grafting large trees without so much expense and time as is generally necessary.

I used a knife-blade  $\frac{1}{4}$ -inch broad, with which I make a stab obliquely into the side of a large limb or body of the tree, the knife making a sharp angle with the tree passing into the wood and between the wood and bark as near as I can, so that when the knife is pushed in as far as I design, it is hid by the bark about an inch and a quarter, and the bark very little broken or cracked except in a very large tree. The graft is so sharpened that it slips in where the knife came out, and just fits with the slope mostly on the side next the tree. The cut being oblique, the perpendicular fiber of bark binds the graft tight. The inner bark of the tree and graft has abundant opportunity to unite all along the sloping side of graft and next the wood of the tree; and as the whole end of the graft is entirely covered, there is no place for evaporation. The grafts were only in tolerable order. The time was April 1st. A little wax was used to make sure the tightness of the union. They nearly every one grew. They were put in in one-fifth the time you could put on a bud or graft. They can be put in almost as fast as the end of the graft can be sloped off. If only one in ten should grow, still a large tree could be worked over in this way much faster than the common way. Whether this process can be successful later in the season, I do not yet know, but will try it.

I fear now that I have not described it as accurately as it should be, but it is pretty hard to do so in every particular without an engraving. It differs from the French spur budding in this very important particular—the insertion is slightly oblique so that a portion of strong thick bark made more tense by the graft being wedged under,—it presses on the graft, keeping it solid and nearly closing up the wound. And then another advantage is, that as the body of the limb or tree emerges during the summer, there is no perpendicular cut to gape open; there is, it is true, an incision, but it is very small, and not within half an inch of where the graft and tree begin to unite.

## THE MONOCOTYLEDON THE UNIVERSAL TYPE OF SEEDS.

BY THOMAS MEEHAN.

*Read before the American Association for the Advancement of Science, at Indianapolis, August 18, 1871.*

It must be evident to the readers of my paper at the Chicago meeting of the Association, on "*Adnation in Coniferæ*," that the observations there detailed could scarcely be accounted for if the belief be true which is generally held by botanists, *that the leaf originates at the node from which it seems to spring*. It is not, however, an object with me to attack existing theories or establish new ones, but simply to present facts as I see them. If I suggest a meaning to the facts, it is to excite thought in others, as facts are of no value unless some one makes use of them. The origin of the leaf will no doubt prove a question which will, in time, take care of itself. But this generalization cannot be avoided by the readers

of that paper, that the whole plant is originally an unity, and that the subsequent formation of elementary organs and their complete development or absorption into one or another, is the result of varying phases of nutrition. The leaves in *Coniferae* were found to be free or united with the stem, in proportion to the vigor of the central axis. Following up this subject, I now offer some facts which will show that all seeds are primarily monocotyledonous, and that division is a subsequent act depending on circumstances, which do not exist at first commencement of the seed growth.

It is well known that in some species of coniferous plants the number of cotyledons vary. I have noticed in addition to this, that whether the cotyledons are few or many, *there is no increase in the whole cotyledonous mass*. In the Norway Spruce, *Abies cæclsa*, there are sometimes as many as ten cotyledons, at others only two,—in the latter case they are broad and ovate, while in the former they are narrow and hair pike. In short, when in the two leaved state it is not possible to note any difference between a seedling Norway Spruce, and a Chinese Arborvitæ (*Biota orientalis*), except by the lighter shade of green. The two-leaved condition is not common, but specimens of threes and others I exhibited to Drs Torrey and Gray, at the Troy meeting. Any one who will examine sprouting seeds of the Norway Spruce, will agree to the proposition, that *the cotyledons are not original and separate creations, but a divided unity*.

My next observations were on some acorns of *Quercus agrifolia*. The division into cotyledons was numerous and irregular. Cut across vertically, some represented the letter C, others the letter N, and again with four cotyledons the letter M. Here again it was clear that, however the form and number of the cotyledons, *there was no increase of the original cotyledon mass*. Examining sprouting peach kernels, the variations in form and number were of the most remarkable character. I need not repeat them in detail here, as they are reported in the April and May *Proceedings of the Academy of Natural Sciences of Philadelphia*. In addition to the fact of no increase in the whole cotyledon mass, it was here clear that when the cotyledons were duplicated, the duplications at least were subsequent to the original ones.

Still, so far nothing had been seen to indicate when the first pair of cotyledons were formed.

*Quercus macrocarpa* and *Quercus palustris* were silent to my questions; of a large number I found no variation whatever, each mass was divided smoothly and exactly into two cotyledons. *Quercus robur*, the English oak, however, gave some curious evidence. Two germs under one seed coat were numerous, and often three, and the cotyledons took on a variety of forms; but there was never any more increase in the cotyledonous mass than if but two lobes had been formed, and there was no more rule in the division than there would be in the sudden breakage of a piece of glass. A detailed account of these will also be found in the May *Proceedings of the Academy of Natural Sciences of Philadelphia*. *Quercus rubra*, the American red oak, furnished the one link wanting to connect the first division into lobes with the other phenomena. All the acorns examined had three or four sutures on the cotyledon mass, and extending all along the longitudinal surface externally, without any reference to cotyledonal divisions. These sutures extended sometimes but a line in depth, at others almost to the centre of the mass; always accompanied by the inner membrane, as is the case in ruminated seeds. The whole mass was divided only in two parts in any that I examined of this species, *but the division was always in the direction of the suture*. Hence each cotyledon was very irregular. Sometimes one-third the mass only went to one, while the other had two-thirds of the whole mass. It was easier to burst in the weaker line of resistance,—but the interest for us is to note that originally the cotyledon mass was an unit—then the sutures or fissures were formed; and ultimately the two divisions of the lobes followed in their direction. *The division was the last condition, not the first*.

I know how much we should guard against generalizing on a limited supply of facts, but it requires an effort to believe that oaks, pines and peaches, as we have seen primordially monocotyledonous, are in this respect different from other so-called dicotyledonous plants; and if we grant that all seeds are primarily monocotyledonous, may we not ask, *why in any case are they divided?* We have seen that there is no increase of mass in the division,—the same amount is furnished in one, as in many. Would it in any way injure the Indian corn seed to have its mass divided into two lobes? or would not the plantlet be as well provided for, if the acorn were in one solid mass?

Division would seem to be a necessity occurring subsequent to organization, and existing from the position of the plumule alone. In monocotyledons as we know them, the plumule is directed parallel to, or away from the cotyledonous mass; when of course on this theory it remains an undivided mass. But in dicotyledonous seeds, the plumule is directed towards the apex of the mass; and as we know in the case of roots against stone walls, or mushrooms under paving stones, the disposition in the growing force of plants is to go right forward, turning neither to the right nor to the left; so in this mass of matter the development of the germ would make easy work of the division, and no doubt often at so early a stage as to give the impression we have hitherto been under, that the division is a primary and essential process.

#### BOTANY BAY, NEW SOUTH WALES.

BY MR. W. T. HARDING, NONANTUM HILL NURSERY, BRIGITON, MASS.

As we walked along the beach of Botany Bay, listening to the sad sea waves as they grandly rolled in from the bosom of the South Pacific, and bringing nearer and nearer to Sydney many a richly freighted merchantman from distant lands, who on returning would bear away more auriferous treasures than the 'navy of Tarshish, with the navy of Hiram, once in three years,' were wont to carry. Then, probably, was the 'golden age' we hear and read of now; at any rate it was not in this year of grace, for time and place have changed since then to California and Australia, where 'rushes' and 'stampedes' are frequently made to the modern 'diggings.' I could not but feel the force of the fact, that Solomon had shown great wisdom in leaving so much of the golden harvest to be gathered by the lucky diggers of to-day; and perhaps there was wisdom too in concealing so much of the 'dust' from me (I have tried hard to think so) while 'pursuing fortune's slidd'ry ba.' Nevertheless I feel thankful to Him who has revealed many a treasure when searching for 'the hidden mysteries of nature and science.' As I know you, Mr. Editor, to be a 'man after my own heart,' and rich in the possession of those 'sympathies which makes the world akin,' you would have felt much as the writer did under similar circumstances, as he gazed at the scene, and trod the soil so sacred to the memory of three 'good

and true men,' who have left us, namely, Captain Cook, Sir Joseph Banks, and Dr. Solander, to whom we are indebted for most of the plants which adorn and decorate the conservatories now.

As I look back along the vistas of time, it is pleasure to think of, even now, that I have been a votary at the shrine of 'Flora,' at the far off floral 'Mecca' of Botany Bay.

At Sydney there is an excellent and well arranged botanical garden, containing a collection of every kind of fruit trees, forest trees, shrubs and herbaceous plants from various parts of the world, as far as could be collected; but unfortunately was not so well kept as it was previous to the gold discoveries; and like its sister garden at Melbourne, was suffering for want of labor. I will not weary you with a description of Sydney, which has often been described by more able pens than mine, any further than to say it is a well built, populous and busy city. So please follow me again, and I will lead you into the 'bush'

Having attracted the attention of an old settler, who rejoiced in the name of 'Commodore' Palmer, while examining some specimens of Alga, picked up on the sands, who informed me that he was an old 'man o'war's man,' and in the course of some of his voyages, had frequently sailed through vast fields of sea-weeds, so thickly woven together as to make it difficult to pass through. But what astonished him the most, was to find it growing upon the trees, some hundreds of miles from the ocean, and especially so about where he lived, it grew a full fathom or more in length; and seriously assured me it was a fact of which he would be pleased to convince me, if I could only shape my course with him, when returning to his section. My intentions were to travel as far as Bathurst, having some business matters to attend to there, and from thence on to Moreton Bay, so was pleased to accept his offer to 'show me the sights' on our way thither.

A church clock struck three in the morning as we left Sydney, seated upon a heavy laden dray, and drawn by ten stout oxen, and were soon winding our way through the forest glades, and moved along through scenes 'so charming,' wonderfully romantic, and so strangely in contrast with anything previously witnessed, admiring the magnificent old trees, whose lofty tops waived some hundreds of feet above the beautiful and bril-

liantly colored shrubs and flowers beneath. The Moreton Bay Chestnut, *Castanospermum Australis*, were handsome trees, with here and there the odd looking grass trees, *Xanthorrhoea hastata*, interspersed with clumps of the peculiar fleecy looking *Stenochilus incanus*, which the "Commodore" called "wool bushes." *Stackhousia linearifolia* we saw in quantities for the first time, also a pretty evergreen climber, *Secamone elliptica*. We passed through dense thickets composed of *Billardia fusiformis*, *Clematis indivisa*, *Kennedya*s, *Hardenbergias*, and *Chorozemas*, clinging to bushes of *Pittosporum revolutum*, *Elodendrum integrifolium*, *Pommaderis acuminata*, *Acacia saligna*, *A. longifolia*, *A. ciliata*, and many other kinds. The humble looking, and sweet scented *Bulbina suavis*, gave out a delightful perfume as we pushed through the jungle so thickly matted and interlaced together, as almost to exclude the light. Emerging from the tangled shades, we entered a more open country, and halted for the night by a water course in a pleasant valley. Several finely grown specimens of *Corypha australis*, or Cabbage palms, averaging from fifty to sixty feet high; also some good sized *Bosscea scolopendriums*, or plank plant, a singular looking leguminous shrub, in full bloom were plentiful around. Very conspicuous and pretty were two *Blandfordias*, *grandiflora* and *nobilis*, and *Thelymetra stelkata*, with fine tufts of the rush like *Nyris altissima*, from ten to fourteen feet high, were very attractive as they gently waved with the wind on each side of the stream.

On the fifth day out, we entered one of the most beautiful glens imaginable, and so richly adorned with ferns, herbaceous plants, shrubs and trees. I believe all the *Zichias* were here, having counted nine species. *Sollya heterophylla* hung in graceful festoons from tree to tree, mixed with *Clitorea ternata major*, *Pronaya elegans*, *Zylothora grandiflora*, and *Morinda jasminoides*. Some lovely orchids we noticed mostly in flower, and cosily nestled in the trees around, such as *Cymbidium reflexum*, *Sacochilus parviflorus*, *Dendrobium Schemannii*, *D. miniatum*, and *D. cassythoides*, *Cleisostoma tridentatum*, and several others. Of terrestrial kinds we saw numbers of *Habenaria*, *Thelymitra carnea*, *Diuris aurea*, and *Periostylis grandiflora*, (grand indeed) with *Maedonaldia cyanea*. Of ferns, many and beautiful were the fronds we gathered and carefully dried for the

herbarium, such as *Northochloena pumila*, and *N. distans*, *Dicksonia davaloides*, *Lomaria lanceolata*, *Drynaria irioides*, *Nephrolepis obliterata*, *Glichenia flabbalata*, *Davalia pyxidata*, *Schizaea bifida*, *Lindsaea trapeziformis*, *Pteris fulcata*, *Adiantum formosum*, *Blechnium levigatum*, and *Polypodium tennellum*.

Reluctantly we left the scene that so forcibly reminded us that "many a flower is born to blush unseen, and waste its sweetness in the desert air."

Our course for some distance was along a fertile valley, where the trees were more thinly scattered, and mostly *Eucalyptus* species, growing to enormous sizes, averaging from fifty to seventy-five feet in circumference, and from three to four hundred high. *Hibiscus splendens* and *Indigofera sylvatica*, formed very pretty clumps, the former often from twelve to fourteen feet high, and the latter frequently attaining twelve feet.

The grass seemed to grow greener and more luxuriant as we approached the "Commodore's" section, which was located in a veritable oasis, well adapted for stock raising and wool growing. I was somewhat astonished at the knowledge or instinct of the dogs as they suddenly sprang from out of the thickets and bushes, miles away from home, where they had concealed themselves, and were evidently awaiting their master's return; and as they met, seemed "to greet with friendships warmest smiles," both man and beast. Dusty and travel-stained as all were, I could not but notice a remarkable sanatory change in the "Commodore's" features after allowing the faithful creatures to "swab his figure head," or rather to lick "the human face divine," an operation he seemed to enjoy, and willingly submit to. We have often heard of "go in to the dogs," which seemed absolutely so in this instance, for such a pack of "mongrel hounds and puppy dogs, and curs of low degree," were surely never seen before.

Satisfaction and good nature were plainly written on every wrinkle time had scored upon the old "Commodore's" face as he shook hands with his crew, who seemed heartily pleased to welcome the old hero home again. It was nearly noon when we reached the homestead, which consisted of several huts, barns, stables and sheds, snugly located beneath the trees and evergreen climbers, and were fortunately in time to partake of a good and substantial meal, not

"mutton and damper," nor "damper and mutton," the squatters every day bill of fare, but a haunch of Kangaroo, well served and relished. The cook was an "old tar," in fact all hands were, or had been sailors, men who had seen hard service, good specimens of the old school "man o'war's men."

The "Commodore," to make good his promise, after dinner, undertook to pilot me to where the "sea weeds were growing upon the trees, a full fathom or more in length." Not doubting his veracity in the least, although somewhat dubious about what he meant by sea weeds, we started in search of such an unheard of curiosity before, and had not proceeded far within a grove of white and blue gum trees, before my attention was called to a sight which astonished me indeed. Pointing to the trees he said, "there, do you believe it now?" I must admit that I was rather puzzled for the moment, and before replying, went forward for a closer examination, when to my surprise and delight I had discovered in the "sea weeds" magnificent specimens of *Platyercium grande*, firmly attached to the trees, with fronds measuring a full fathom or more.

It was Saturday night at sea, and in accordance with ancient usages and customs, it was Saturday night in the old seafarers cabin in the "bush," and was kept up as in days of yore. The "Commodore" sang his best song, "the Death of Nelson," as heretofore, which he assured me he had never omitted doing for more than forty years, every Saturday night. After each had done their best at singing some old sea ballad, your correspondent was called upon for the next song, and willingly complying, sang them one of Dibden's nautical effusions.

Here a sheer hulk is laid now; poor Tom Bowline,  
The darling of our crew, &c."

which fairly brought down the house, and tears to the "Commodore's" eyes, as he pronounced it to be the best song mortal ever sang, with the exception of his, "The death of Nelson."

Happy and contented, all retired for the night and arose refreshed with the sun on the Sabbath morning. All hands in the "Commodore's" service that could be spared from their duties, and some from the neighboring stations gathered at the quarters, and in social conversation awaited the hour when divine service commenced, according to the time honored and beautiful liturgy of the Episcopal church. Prayers being over, one of Dr Doddridge's sermons was read

and attentively listened to, and the service concluded by singing a metrical selection from the 108th Psalm, beginning with the words,

"Oh God my heart is fully bent  
To magnify thy name."

Fond memories oft return, and with pleasant recollections of the past, revert to that quiet Sabbath morning when, within the deep recesses of antipodian forests, we worshipped God. Ever passing "time waits for no man," and admonishes us to linger not, so bidding adieu to our hospitable entertainers, we unwillingly left them; but had not proceeded far before we were overtaken by the "Commodore," who accompanied us several miles on our way. On reaching a group of *Ficus macrophylla*, thick with an undergrowth of *Banksias*, *Dryandrias*, and *Buonapartias*, we seated ourselves upon a log, one of the fallen "giants of the forest," when "the ancient mariner" asked me as a last and parting favor to oblige him by singing "Tom Bowline," as he would most likely never hear it again. Of course I did, while the old man drew nearer to my side, and passing my hand within his, listened to the song as re-echoed through the silent wilderness. His big heart was too full to sing me his song further than the first line, "T'was in Trafalgar's Bay," when he broke down completely, and slipping off the log bid me wait a moment; moving a few paces and fumbling in his pockets, for something, he stepped up to me and placed in my hand a something as a "keepsake" to remind me of him when far away. I gave him one also with similar injunctions, and for the last time bid each other farewell. When out of sight, curiosity led me to examine the "keepsake" which was firmly tied up in a piece of blue serge cloth, where it had probably remained for many years. On opening it, attached to a blue watered silk ribbon, was a heavy gold watch key and seal, on the latter was engraved a ship in full sail, riding on the waves, with the motto beneath "such is life."

#### FRUIT CULTURE AT WODENETHE.

BY "VIATOR," NEWBURG, N. Y.

Several gentlemen from the northern part of this State, with some Western horticulturists, were very much struck in visiting the celebrated place of Mr. Sargent, at Fishkill, to see the new varieties of apricots, nectarines, and peaches, by which the season of each of these fruits has been prolonged several months.

It may not be generally known to your readers that Mr. Rivers, the celebrated horticulturist in England, has by dint of much patience and many experiments succeeded in raising seedlings (apricots and nectarines) by which the season commencing *now* is carried into October, though heretofore it lasted only about a month.

Mr. Sargent gave us ripe apricots from bushes imported this Spring, and assured us he could do the same through the next *three months*, and the same with nectarines, plums, and peaches. The plants are all grown as bushes, beautifully trained, and the varieties we thought most promising, were seedlings Nos. 5, 7, 15, 17, and 23 among the apricots. And Pineapple, Lord Napier, Albert Victor, Large Elruge, and Victoria among the nectarines. The finest of the new peaches were Early Albert, Early Beatrice, Early Rivers, Early Silver, fruiting in June and July; Lord and Lady Palmerston, Prince and Princess of Wales, the nectarine peach Alexandra Noblesse, Dagmar, Royal George, and Seedlings Nos. 34, 42, &c., for midsummer and autumn.

The plum season has been very much lengthened by the new Green Gages, Brabys and Bryansons, and also by Seedlings Nos. 1, 3, 4, 6, 7, and Early Prolific.

Among the new things of interest on this highly cultivated place, is a new *Herbaceous* border with two hundred varieties, and a rock and stump garden, more artistic than any we have seen in our rambles; with all the new alpine flowers (300 varieties) recommended by Mr. Robinson in his charming book on Alpines, and imported from Backhouse & Son's celebrated nursery, in York, England.

#### TO DESTROY THE ORANGE RUST ON THE BLACKBERRY.

BY MR. ISIDOR BUSH, BUSHBERG VINEYARDS, MISSOURI.

The orange colored fungus (*uredo ruborum*) mentioned in your last number, (*Gardener's Monthly*, July, 1871, page 211) also made its appearance in spring 1870, on our Lawton and Kittatiny blackberries. I asked Mr. Riley for a remedy, and he stated, same as you do, that he believed 'there was no other available remedy than the complete destruction, root and branch, of every infected plant,' (*Ann. Entomologist*, June, 1870, p. 245). But this spring Mr. Riley had the kindness to show me a letter from a

friend, stating that he believes to have found a remedy, which consists in sprinkling the infected plants with fresh slacked lime. This year the orange colored rust had appeared even worse than the previous one; we cut off some of the most infected branches, sprinkled the balance, wherever rust was visible, with fresh lime-wash, and are glad to bear testimony that it put an effectual stop to its spread, and even the plants which were so affected are now bearing a fair crop of fruit.

#### NEW AND BEAUTIFUL EVERGREENS. BY WALTER ELDER, LANDSCAPE GARDENER, PHILAD'A.

It is as surprising as it is pleasing to an ornamental planter to see the numerous and diversified species and varieties of lately introduced evergreen trees and shrubs of great beauty, now in some nurseries, and which will soon revolutionize the embellishing of pleasure grounds. Their foliage are of various sizes, forms and shades of green, and many are tipped, spotted, and splashed with golden yellow and white. Some are dwarf creepers; some are suited to make beautiful hedges, and others for gigantic ornamental standards. Many improvers do not yet know that *Cephalotaxus*, *Cryptomeria*, *Libocedrus*, *Retinospora*, *Thujiopsis*, &c. *Biota*, *Buxus*, *Euonymus*, *Juniperus*, *Ilex*, *Thuja*, &c., have got great increase in varieties of late years. *Retinospora ericoides* and *Thuja nana nova* and *Tom Thumb* are now used as edgings for parterres, and make a diversity with *Boxwood*. Our native dwarf *Kalmias* and *Andromedas* would also make fine edgings for large flower beds; their foliage is comely, and they bloom beautifully in spring, before many of the flowers.

The *Rhododendron* is now successfully cultivated, and the numerous improved varieties are splendid and various in their beautiful blossoms. The *Kalmia latifolia* might also be successfully cultivated, and improved varieties may be produced from it, which might vie with *Rhododendron* in the beauty of their foliage and loveliness of their blossoms; there may come crimsons, scarlets, pinks, and whites of various shades. What a splendor they and *Rhododendrons* would give to pleasure grounds in spring when in full bloom; the like of which has not yet been seen upon our hemisphere.

We would earnestly advise all improvers to



get an assortment of the new evergreens along with the old species to embellish their pleasure grounds with, so as to keep pace with our horticultural progress. If the plants are small, they may be set in nursery rows upon a rich cultivated piece of land, and if kept free of weeds, they will make such growths of roots and branches in two years as to be fit to set out upon the open lawn as standards.

#### NOTES FROM ALTON.

BY MR. E. A. RIEHL, ALTON, ILL.

In the *Gardener's Monthly*, which is just received, I see some things on which I think I can give you a little information which I think you would like, and some may be of benefit to your readers, hence I have taken pen in hand to write these few hasty lines.

#### NECTARINES FROM PEACH TREES.

First, about that Nectarine which somebody in South Carolina picked from a peach tree, and which you say is the first instance of the kind on record. I would say that on my father's place near St. Louis, there was, some 25 or 30 years ago, a tree in a row of seedling peaches, itself grown from a peach seed, and that produced both peaches and nectarines; the majority of the fruits were Nectarines, but some limbs produced Peaches.

#### DESTRUCTION OF COLORADO POTATO BEETLE.

Now as to your ideas about the Colorado beetle, I would say, that your proposition to kill them by rolling is not practicable, for not only is the potato plant very soft, as you say, and would be considerably damaged, but the cultivated earth would not, I think, offer resistance enough to mash the larvæ, much less the perfect beetle; and it is of the greatest importance to kill the beetle when they first appear, and before they deposit their eggs, for not only do they feed on the young potato plants and do great damage, but the young larvæ are very ravenous and will in a few days eat up the plants if they are not checked. The method of poisoning with Paris green is the easiest and cheapest method that I know of, and could I manage all the insects that plague the horticulturist and farmer, as easily and cheaply, I would soon be rich. At present few persons dilute the poison enough. I use one part Paris green by measure to 25 parts of plaster, and I find that is just as efficient as when we used one to six. There is now more

money to be made in growing potatoes than there ever was before, for most people have a great dread of a little extra work, and as a consequence, potatoes bring a much greater price than formerly, much greater than the extra trouble would justify. I applied the poison three times to my early crop, and I know that the cost of poison and labor in putting it on, is less than \$5 per acre.

#### LIME FOR BLACKBERRY RUST.

I see *Colman's Rural World* says, "Quicklime" will kill the yellow fungus on blackberry and raspberry plants. May be air slacked lime is meant, if not, I should think it better than quicklime.

We are having exceedingly dry weather, and a very abundant fruit crop.

#### HYDRANGEA OTAKSA AND HYDRANGEA STELLATA PROLIFERA.

BY MR. GEO. SUCH, SOUTH AMBOY, N. J.

There seems to be a good deal of confusion regarding *Hydrangea Otaksa*. Having seen a colored illustration of this plant in the *Revue Horticole*, we concluded that it was an admirable novelty, and so imported stock from Belgium at once. We afterwards had a small plant from Philadelphia.

Having taken cuttings very freely from our Belgian plants, we saw no flowers last summer; but lately have had a bloom which seems to differ in no respect from that of the old *Hydrangea Hortensia* of our gardens. Having sent out this great novelty to many customers, the position is decidedly annoying. Neither is our Philadelphia plant correctly named, being most probably *Hydrangea stellata prolifera*, or very nearly related to it. But the confusion does not exist in this country alone. The *H. Otaksa* figured in the *Flora Japonica* has small flowers of a delicate blue color. As figured in the *Flore des Serres*, the flowers are larger and are rose colored, instead of blue.

The illustration of *H. Otaksa* in the *Revue Horticole* was taken from a plant exhibited by M. Lierval, a french florist. The head of bloom is represented as immense, the color of the flowers being violet rose. Two flowers, given to show the natural size, are nearly two and a half inches in diameter. The sepals constituting the flower are variable in numbers, being sometimes four and sometimes five. The foliage greatly resembles that of the garden Hydrangea.

According to Siebold this plant originated in China. It has not been long in Japan, and is comparatively rare in the gardens of that country. Siebold also states that it has a bushy growth reaching a height of 5 or 6 feet, and that in Japan the flowers are almost always blue. The time of flowering is from June till the end of September.

The *Hydrangea Otaksa* sent us from Philadelphia has flowers of a semi-double appearance, which consist of about ten sepals. The flowers are hardly more than an inch in diameter, of a rosy color fading off to greenish white at the centre. The leaves are nearly round, but sharply pointed at the tips and sharply serrated about the edges of the upper half. In fact the whole plant is very much like *Hydrangea stellata prolifera*, as figured in the last volume of the *Flore des Serres*.

#### RAISING SEEDLINGS OF TREES.

##### FRUITS, &c.

J. M. PHILA.

To be universally successful in raising seedlings is very rare. To be tolerably successful requires much experience, and the mode leading to the best results is often disputed. To the nurseryman who has had some years experience in the matter, the question of what will grow and what will not, and the time to sow the seeds is not so much the puzzling question as to the uninitiated.

To be on the paying side requires more good judgment than hard work. Some few years ago it was looked upon as something next to an impossibility to raise seedlings here in our hot climate, but the experience following the encouragement of a protective policy of the government has demonstrated that the mountain is not near as large as was surmised. The raising of fruit stocks, cherries, plums and peaches is mainly done in our own country. The practice of the growers is to sow them in the fall as soon after gathered as possible. A great many persons keep them mixed in soil exposed to the weather all winter and sow them early in spring. My experience would lead me to expect the best results with cherries and plums from fall sowing, but with peaches they seem to do equally as well sown in the spring, with tree and shrub seeds, a great many will only grow by fall sowing; and in the majority of cases it is best done then. I would sow in fall, Maples, Mag-

holias, Horse Chestnuts, Buckthorn, Tulip Tree, Sour Gum, Sweet Gum, Bird Cherry, Catalpa, Deciduous Cypress, Judas Tree, Linden, Mahonia, &c. In the spring can be sown Laburnum, Spiræas, Furze, Paulownia, Eleagnus, Altheas, Elm, Birch, Wisterias, Ampelopsis, Koleruteria, Nettle Tree, Honey Locust, Larch, Osage Orange, Mulberry, and many others, as well as seeds of Pines, Spruces, and all coniferous plants.

Many of those enumerated for fall sowing, such as Maples and Magnolias, will grow very well if sown in spring, but will not make as large plants in one year as will those sown in the fall. Seeds of Yews, Ash, Halesia, Dogwood, Box, Pyracantha, Ostrya, as well as very late spring sown deciduous trees, &c., usually remain in the ground two years before growing (as will sometimes cherry and plum when sown late in spring). These should be sown in spring, the ground kept clean all summer, and in the following spring the seeds will grow. It is essential with almost all seeds to guard their young growth from the hot sun. A good plan and a very successful one is to cover the whole bed after sowing with corn stalks or light brush wood, keeping it on until the seedlings are strong enough to stand the sun. With Cherries, Plums, Horse Chestnuts, Maples, and those which soon make a strong growth, this covering can be taken off in June or July, doing it gradually as they seem able to bear it. Sometimes where the covering is light and the seedlings not close together, it is an advantage to retain the covering all the summer, removing it only in the fall. Where it is desired to grow evergreens from seed largely, the plan is usually to erect an arbor of laths nailed near enough together to exclude much of the sun's rays, admitting at the same time plenty of air, two essential points. Millions of such seedlings are now raised here, and that this is done and the plants sold as low as European imported ones, show how thoroughly the business is understood and made reliable by our nurserymen.

#### PROPER DEPTH TO SOW SEED.

BY "MOXOW," CINCINNATI, OHIO.

I have been much interested in the discussion going on in your magazine, in reference to the principles of hot water heating,—and when I get a hot house I think I shall profit by what I have read. But I have none just now, though I have a pretty fair fruit and vegetable garden in

which I take some pride. I ought to say besides that I keep no regular gardener, but my coachman who has many handy notions, does all the work that I do not do mornings and evenings myself. I usually sow all my seeds, and my man does all the hoeing and cleaning, and keeps things in order generally.

In my seed sowing this year, some of the results were so remarkable, that I thought they might interest some of your readers. I had been reading a piece in one of our local papers, which I thought very sensible, and of which the following is an extract, as well perhaps as the pith of the whole thing:

"In planting, whatever the depth of tillage, keep the seed near the surface. Nature knows no way of getting the seeds of grains far below the surface, in using them for seeds. We shall find ourselves doing well in taking observation of natural processes for effecting reproductions. In general I think it will be found best that the seed of grains be placed only about as far below the surface as to bring their covering to the common level, when there is enough of it to secure germination—the ground being in proper condition for planting, with promising weather in anticipation."—*Countryman*.

I have always had pretty fair success with my seeds; but on this occasion, I sowed my vegetables in a somewhat different way from what I had done before. The ground had been forked over—thanks to the past advice of the *Gardener's Monthly*. We never dig it any more, and this saves half the labor. I stretched the garden line, and sowed the seed right on the track of it, then drew earth with the rake over the line of the seed, and with my feet, trod the whole length of the line over the seed. I had sown my radishes, lettuce, beets, carrots and salads, when I was called away unexpectedly, and, not being able to attend to the seed sowing next morning before I went to my city labors, got my man to finish sowing the balance of my seeds, without thinking to give him specific instructions. These he sowed in the usual way; a line stretched a shallow drill with the hoe, the seed sown, and the earth again drawn in lightly, the way in fact that all seeds are generally sown. A remarkably dry spell followed, and plants of all kinds had a hard time of it. But all the seeds surface sown and trodden in, as I have named above, grew without a single exception, and not one seed, that I could see, failed to grow. Of those that my man sowed in the usual way, not one came up, but

some bush beans. I was glad in one sense that this happened, though the loss of our parsnips in particular will be felt in the kitchen; for it led me to see that the seedsman, though I think seeds are really bad sometimes when sent out, are not always to blame. In this case the seed papers had Landreth's stamps on them, and if it had not been for the excellent growth of those sown on the surface and tramped in, I should most likely have concluded the whole thing a fraud. In future I shall sow everything on the surface; and perhaps this leaf from my experience book may be of use to others.

---

#### BRIEF NOTES ON GENERAL PLEASANTON'S PAPER.

BY "A GARDENER," DUCHESS CO., N. Y.

So many notices of Gen. Pleasanton's experiments have appeared in the public papers that I was anxious to see the whole article, and was particularly pleased to find it in full in the last *Gardener's Monthly*. Yet there are a few statements therein which appear very extraordinary, and with your permission, I will advert to a few of them.

In the first place, it appears that the grape house was 84 feet long by 26 feet wide, which gives an area of 2184 square feet, yet Mr. Buist says there are 1200 pounds of grapes from plants seventeen months old. This is more than half a pound to the square foot (60 100) and supposing each bunch to average one pound, we should have a bunch hanging within every two feet of the space the house contained. I should like to ask Mr. Buist whether he is prepared to sustain this statement? But the subsequent year's figures are still more extraordinary. We have now *two tons*. This gives *two and three hundredths of a pound* to each square foot, and allowing the average weight to be one and a half pounds per bunch, and the average diameter nine inches, we have the remarkable spectacle of a mass of grapes, *each bunch touching one another over the whole surface of the house!* Through which it would be impossible to see scarcely a leaf on the other side. Is Mr. Buist prepared to vouch for this also? Now when we reflect how easy it would have been for either Mr. Buist or General Pleasanton to have cut one bunch, weighed it, and then multiplied by whole number, and thus obtained an approximate weight

I am astonished at such loose statements in a matter of scientific import. Mr. Buist speaks of another gardener whose plants were no larger at the end of the year than they were at the beginning, though the same vines as those of General Pleasanton's. Did he expect General P.'s vines to be the same as these. In this region we expect grapes to do better than this, though we have no blue glass to aid us.

*The experiment on pigs* is no more satisfactory. General Pleasanton attempts to explain away the fact of the barrow pig under the common glass beating the blue light pig by saying that he was stronger than the sow pigs in his company, and thus fighting for more food, had more, and thus gained an advantage. But my experience always has been that a sow shows a barrow pig no mercy, and is always and in all cases the conqueror. I never saw or heard of a sow small or large, which was not able to hold her own against the most disagreeable barrow that might be with them, moreover the very small difference in the weights where favorable, is so small as to be in sinking contrast with the wonderful crop in the graperies.

*The calf illustration* is still less to the point. Thousands of puny calves have been born, which very intelligent men thought would not live, but which have become the pride of the herd for all. As to electricity this is beyond me; supposing that it has some influence on vegetation, I have never without a considerable degree of guessing, been able to understand what that influence is, nor do I think General Pleasanton's ideas make it much clearer. Both very light limestone soils, as well as very dark peaty soils, are equally productive. As for the giant trees of California owing any of their size to electricity, the General seems to forget that these trees are confined to one species of *sequoia*. The myriads of others are no larger than ours, notwithstanding his idea of the superior power of Californian electricity,—and again I am at a loss to understand his theory of heating the ocean. He says the sun has nothing to do with heating water, and illustrates it by saying we do not kindle fires at the top of our chimneys, or boil our water from above. Truly we do not, but yet when the sun boils the General on a hot summer's day, the boiling really does come from above. But keeping ourselves to the water question, the General will find that any vessel of water, no matter how large that vessel may be, when entirely detached from his terrestrial

source of heat, when exposed to the summer's sun, will get warm for all. The General has entirely forgot that water is an absorbent of heat and that it will take up an immense amount from any warm atmospheric current floating over it. The water in our hot water boilers does not come into immediate contact with the heat generated from the coals. But the iron does, and the water takes it from the iron, and this is how it gets warmed. As to the water being heated by the earth in the tropics, we might look for the same phenomenon in the arctic regions, for the hot springs of Iceland would show that a pretty heavy degree of heat was not far from the surface. I can conceive that there is a small amount of earth heat which may get into water, and that ice will thaw from beneath in consequence. I can imagine even that a pound of water entirely confined by ice, would continually get warmer by this earth heat; but this to the extent of the heated waters of Central America, from which our gulf stream emanates, by the rush of cold water to take the place of that flowing north, is out of the question altogether. I must say that for a scientific paper with the celebrity this one has acquired, I am astonished at the weakness of the facts brought to sustain it.

### THE WATERMELON.

BY T. A. C.—D.

The last of the gay summer sisterhood blushing,  
Ascends her green throne where the fruit clusters vie,  
And rejoices at eve when Apollo is flushing  
With sapphire and rose tint, the stream and the sky.

No more o'er the grain fields the zephyrs are playing  
With light and with shadow in hurried career;  
And though there is scarcely a green leaf decaying,  
The field is a desert, rough, yellow and sere.

'Tis the reign of Pomona whose treasures are glowing,  
Ripe, ruddy and juicy, on long pendant boughs;  
'Tis the time of tall grass which the laborers are mowing  
While the hay scented zephyrs are fanning their brow

But the glory of August not quite so capricious,  
Yet red as a girl's lip, and cool as a well,  
Is the green coated melon, so plump and delicious,  
With the brown mottled seeds in their roscate cells

I ask not a peach like the cheek of a maiden,  
Downy and soft as a Georgian's may be;  
I care not for boughs with their gold apples laden,  
When the heart of a melon is blushing for me.

If this life has a care, 'tis not then that I know it;  
If the day oppress others, for me it is bland,  
I seem to be Ariel, Puck, or a poet,  
Who feasts with Queen Mab in her own fairy land

I make the sweet melon my favorite topic,  
Thou chief of the offspring of sun and of dew!

In spite of bananas, the pride of the tropic,  
Or famed Chiromays the boast of Peru.

Give us cool "Mountain Sweets" from New Jersey, nor  
ask us

To sigh for the grapes of some orient land,  
The peaches of Persia; the figs of Damascus,  
Or the idolized fruits of remote Samarcand.

I have shaken ripe oranges oft, where they fell on  
Floridian flowers; I have dreamed of the date;  
But dearer to me is the dew tempered melon,  
Fresh from the sand of my loved native State.

Old State, ever dear to the farmer and florist,  
I love thy broad grain fields and worm fences too;  
Rosy laurels that light the green eaves of the forest,  
Where the pines scatter diamonds from rain drops or dew.

And truly, that man so unlucky I pity,  
Who never has seen the grand spectacle, when  
The fruit saturnalia reigns in our city—  
The loved of Pomona, the city of Penn.

The poet may sing of the orient speices,  
Or Barbary's dates in their palmy array,  
But the huge rosy melon in cold juicy slices,  
Is the Helicon fount of a hot summer day,

Where I bathe the dry wings of the spirit and sprinkling  
Sweet drops on the pathway of dusty old care,  
I hold father Time from his villainous wrinkling  
Of features that never had graces to spare.

[Not quite sure that we have permission to use the author's name in full, as it was not attached to it,—we have only indicated it. We may perhaps be pardoned for adding that his personal friends will recognize a leader in American science whose place it would be very hard to fill.

It is, we think, the only poem which the Watermelon has ever inspired. It should be no less worthy of this distinction, than some of the meaner fruits of the old world.—ED.]

#### EDITORIAL NOTES.

##### FOREIGN.

*Changing Aspects of Gardening.*—It is often said that American gardening is not like English,—that much of ours is simply for profit, or for the mere love of gaiety and show on our grounds, rather than from fine taste and love of the subject; but it appears that English gardening to-day, is not the gardening of a generation ago. An English paper says: "The decay of floriculture is mourned by some. Its aspects may have changed to some extent, for the pure florist of yore is now being rapidly merged into the horticulturist; but the spirit of old is yet abroad among us, and in its own good time will give us abundant indications of its activity and success."

It is well, we think, for our commercial men to recognize these facts and to always operate

in the nature of something new, than to be endeavoring to lead people back to a love of past styles.

*Instincts of Animals.*—Mr. Darwin, in his recent work on man, has some curious illustrations of his position that the mental capacities of all animal nature differ only in degree. We note a curious instance of this in an English magazine, the "*Leisure Hour.*"

"An Indian officer saw some crows sitting near a young dog, watching him whilst engaged with a bone. Having apparently concerted the plan, one of them alighted, stepped up, and took a peck at the dog's tail: the dog, irritated, made a snap at the bully, on which a comrade, who appears to have been ready, made a dash and went off with the prize. It will be remarked that it was a *young* dog that became the dupe of this artifice. An old one would probably have had some repeated experience of the trick. He would have put his paw on the bone before turning around."

*Adulteration of Seeds.*—It became so general a thing to adulterate seeds in England, that the law interfered. A fine of \$250 is now imposed on such practices.

*Remedy for Grasshoppers.*—An Australian correspondent of *London Gardener's Chronicle*, asserts that the grasshopper greedily devours the leaves of the common *Larkspur*, but that the *Larkspur* has its revenge in destroying the grasshopper in turn. This, as the papers say, is "important if true."

##### DOMESTIC.

*The Martha Grape*, Mr. Hussman says requires to be pruned longer than some other kinds. We notice that the Hammondsport folks report the same thing.

*To have Hardy Trees.*—*The Country Gentleman* says: "It is well known to some horticulturists, that one of the best modes of rendering half tender shrubs hardy, is to plant them on mounds where the soil is made by mixing cobble-stone and earth, so as to favor early maturity."

We wonder whether this has been actually tried, or is merely imagined by "some horticulturists." Our own experience is, that if a tree suffers from drought in summer, it is very likely to be injured even by a light winter. A mound is just the place to risk this injury. We should have more faith in shelter from winds than dry mounds; of course, in low wet situations,

feeding roots are apt to rot, and thus the plant is starved as much as if dried upon a mound, and the same injury follows. All these extreme views are dangerous. As a rule—*all other requisites to good health being equal*—the tree which holds its leaves the longest, will prove the hardiest.

*Honey Locust Hedges.*—We noticed some months since, an excellent Locust hedge on the grounds of Smith, Clark & Powell, Syracuse, N. Y. The *Prairie Farmer* notes another good one in the West. It says:

“At a recent visit to the farm of A. R. Whitney, the celebrated orchardist at Franklin Grove, Lee Co., we were greatly pleased with the appearance of a young hedge of honey locust. The hedge was some sixty rods in length, the elevation of the ground varying considerably along the line. The plants had been set two years in land that had not been plowed, the sod being turned over twice the width of a spade. Every plant was very thrifty and strong, and the hedge row presented an evenness that we have seldom seen in a hedge of osage.”

*New Vegetables.*—While doing something for improved fruits, trees and flowers, we must not forget the more essential vegetable. Sometime ago we noted in the Proceedings of that excellent Horticultural Society, the Montgomery, of Dayton, O., that the members had been experimenting with new varieties, and here are some of the results:

“Mr. Mumma, of Dayton, said he had a new tomato that was peculiarly striped and variegated; would report on it next year.

Mr. Elliott recommended the Yorkshire Hero pea; and of sweet corn he said Brill's was the earliest, then Crosby's; of seven varieties tested, he gave the preference to Brill's.

Mr. Ritz, of Plainville, said the White German Dwarf Wax Bean was a decided acquisition. He had brought from Europe seeds of a new red sugar beet which he would distribute gratuitously to members of the Society. He regarded Crosby's early sweet corn as the best early of good size.

Mr. Campbell thought the Black Dwarf Wax Bean, the best he had tested; the white might be preferable on account of color.

Col. Richmond spoke of the Brazilian sweet potato as an excellent variety; also the Southern Queen—five specimens exhibited.

Mr. Elliott called attention to the Student

Parsnip as the best in flavor; the Hollow Crown next. Several other members commended the Student variety; it does not grow quite as deep or long as the common. He inquired about the Egyptian dark red beet.

Mr. Bateham said he received seeds of this and several other new beets from the Agricultural Department at Washington, the past spring, but from last year's trial he would not plant one of them again; he prefers the Bassano to all others for summer use, and the Long Blood for winter.

Mr. Ritz spoke of the value of sugar beets as winter food for milk cows, making the butter as fine in color as that of summer.

Mr. Elliott commended the Early Horn Carrot as deserving more general cultivation.”

*Profits of Black Cap Raspberries.*—People do not seem to want inferior fruit, though it be early and cheap. The Black Cap raspberry has fallen low in popular estimation. They were hawked about Philadelphia this season at six cents per quart. It appears to have been worse in New York. Mr. Quinn says in the *N. Y. Tribune*, “that the New York market was overstocked with them through the whole season. Thousands of crates were sold for less than six cents a quart. This would make a loss to the grower of more than four cents on every quart sold. It costs at least ten cents a quart to raise and market raspberries, and when such fruit is sold at six cents and under, it is high time to change the crop, and grow instead corn or potatoes.”

*Varying Measures* in different States are something of a nuisance. In New Hampshire the law provides that 62 pounds constitute a bushel of potatoes, and 32 pounds a bushel of oats; but sales may be otherwise made by special agreement.

*Close Pruning Grapes.*—Mr. M. Pike, of Alton, Illinois, is a very successful grape grower. At one of the meetings of the Alton, Illinois, Horticultural Society he gave his experience, and said “I am satisfied that the majority of grape growers over-crop their vineyards. I have been each year reducing the wood in my vineyard, until now my Catawba canes are not more than three and a half feet long, and but *one* cane, and I am getting just as near the ground as possible, for the reason among others, that they are easily laid down for protection through the winter.

Last year my Catawba vines made the heavy

est growth of wood and produced the largest bunches of fruit of any in my vineyard ; probably 15 per cent. more than my Concords. They ripened up well (they were not merely colored) under this system of the succession of leaves. I

grow three leaves of different ages. The original leaf is the most valuable one. I then grow two additional ones. You may have the succession of leaves very early by pinching early. I do no summer pruning."

## EDITORIAL.

### THE EFFECT OF SOD IN KEEPING SOIL COOL.

It is well known to our readers that we have repeatedly stated as the result of our own experience with the thermometer, that soil is cooler in the heat of summer under sod than under a clean surface ; and we have based much of our opposition to clean surface culture of trees, next to actual observation, that *care*d for trees in grass are healthiest, on this result of our thermometrical experience. We have also several times requested those who really felt desirous of knowing, to test this matter for themselves. One would suppose that any one with a practical turn of mind would be glad to do it, as it would take at best but a few minutes. Especially would one think that those who take so much time to write learned articles on fruit culture, would spare a few moments to devote to so important an experiment as this. But it seems not so.

A contemporary must have astonished its readers by copying in its July number the following from Johnson :

"The effect of sod on the temperature of the soil, was studied by Malaguti and Durocher. They observed that it hindered the warming of the soil to about the same extent as a layer of earth three inches deep."

We have some hope that our contemporary will now tell its readers, that in America, the writers for the *Gardener's Monthly* have found still more striking results than these Italians found. The difference here, is a six inch instead of three.

Our friend having got this far into the waters of conviction, that the old theory of fruit culture is wrong, we shall soon expect to see it make the decisive plunge. Hundreds have gone before it, and have not found the change so very

severe. We say this for its encouragement ; or is it possible that our contemporary will advocate that our hot sun-roasted earth, is a benefit to a fruit tree. Which horn will it seize ?

### PINUS PUNGENS.

(See *Platc.*)

It is said to be a disgrace to cultivators that they go abroad for novelties to decorate their grounds, while they neglect the showy things at their own doors. But yet we think this is as it should be. There is no use in bestowing care and attention on things which we can see every day without it ; and the rare things which come from so many miles away we naturally encourage and protect if we would enjoy them at all. But in the case of very rare native plants it is different. Here we have to search around for them if we would enjoy their beauty, as if they came from some foreign land. So we figure in this No. one of our rarest trees, which though it is found through the whole Allegheny range, not one in a hundred of our lovers of rare trees ever saw.

It is not only rare, but perhaps one of the most beautiful of our native pines. The habit is graceful, and in the spring the male flowers are of a deep purple. The cones which succeed are the largest of this section of Pines, which grow east of the Mississippi. Indeed it is well worthy of culture for the striking cones alone. We have never seen large trees except on the barren hills where they grow naturally, but even here they make trunks fifty feet high, and six or seven feet in diameter ; and we should judge the rate of growth would be about the same as the Scotch Pine. The trees in cultivation have been mostly imported from Europe ; but we believe Messrs. Douglas, of Waukegan, Hoopes of West Chester, and perhaps some others in a

smaller way are getting up stocks from native seeds.

---

#### HORNET RASPBERRY.

In a recent call on the editor of the *German-town Telegraph*, we were delighted with the great beauty and productiveness of this fruit. If any one could always get fruit like this, little more would be desired in a raspberry. This soil is certainly very well adapted to the raspberry,—a low piece of ground, which had been thoroughly under-drained,—a rich, cool, dry soil—the raspberry needs nothing more. It is quite likely that such healthy canes as these would stand the winter without any protection; but Major Freas regards the labor of laying down the canes carefully and covering them with earth, as so trifling, that he always does it,—and certainly the magnificent results warrants the care he gives them.

We have heard it stated that the Hornet and Northumberland Fillbasket, are one and the same; but without ever putting them side by side, we have an impression that the Fillbasket produces more at once than the other, while the Hornet is best for families who prefer to have good fruit in a succession of many days.

---

#### THE LAWRENCE PEAR.

Our Eastern Pomologists are fond of building up their faith with Beurre d'Anjou for their chief corner stone. We do not care to say anything against this excellent variety; but we must say that as year by year goes away, we are gradually coming to think that the one thing needful for us in the Middle States, is the Lawrence pear. We should be sorry to be bound down to one variety,—we could not do without the Bartlett and Seckel, and—begging pardon of those who would limit us to six or so—a few score of other varieties. But amongst them all of whatever kind, should be the *Lawrence*. The tree, to be sure, is not so vigorous a grower as some other kinds, but then it is hardy and healthy; others may equal it in this respect, but none more so. Then with a little manœuvring one can have them to eat pretty early in winter,—or by setting all manœuvres aside, have the fruit all winter; and this is a grand point, for where are all our other winter fruits here? We have on our list “to be recommended” Glout Morceau, Eastern Beurre, Winter Nelis, and Vicar of Winkfield. We see a few of the latter oc-

asionally, though with a somewhat dubious reputation; but we rarely see the others, though trees are plenty in our grounds, and though we hesitate whether to cut into the Vicars, the abundant Lawrences are always seized without any hesitation. But this is not all for the Lawrence. It is a grand bottler: not only all winter, but all summer, till fruits come again we can have them in prime condition this way. Some varieties will keep; but they have a somewhat turnipy suggestion when the eating time comes; but a Lawrence is a Lawrence, whether fresh or canned, or bottled,—and in this respect it is perhaps equalled by no pear, except possibly the Bartlett.

We write feelingly on this subject from having just finished a can of them, while crossing a wild western country, where, notwithstanding the Eastern wonder as to what becomes of all the trees hardly a tree, fruit, shade or ornamental is to be seen. How people can go through this life and leave such luxuries as these Lawrence pears behind them without a care or thought, is more than we can comprehend, but we trust it will not be so always.

Possibly there may be something in the way in which Pears are canned which add to their excellence. These bear the brand of Richardson & Robbins, Dover, Del., well known for their superior productions in this line; but we have had experience with this variety before, to know that a very great degree of the merit belongs to the variety itself.

---

#### MAGNOLIA AURICULATA.

Examining recently a flower of *Magnolia auriculata*, we were reminded of a fact we often thought to note, namely: the unfortunate inaccuracy of that beautiful work—Michaux & Nuttall's *Sylva Americana*. It would be difficult to find so many errors in any modern botanical work as occurs in these standard authors of the past age. In the plates of *Magnolia* the leaves are tolerably accurate, but the floral organs are mostly wide of the mark. The petal of *M. tripetala* is totally unlike the reality; while the flower of *M. acuminata* has no resemblance to that species. It is charitable to suppose that a flower of *M. acuminata* was taken in mistake by the artist.

The long spatulate petals of *M. auriculata* are very much like those of *M. tripetala*, but are rather blunted. The flower is sweeter, and of a purer white than *M. tripetala*, and the foliage is of a deeper green and lighter texture than that species. Considering that it is not on the whole a better thing than *M. tripetala*, it is astonishing that it should be about the scarcest of the genus.



## SCRAPS AND QUERIES.

SWEET AND SOUR APPLES.—An esteemed correspondent writes: "I notice you repeat the story again, or rather copy it, that the sweet and sour apple was made so by splitting buds of two kinds, and making them grow together. Do you believe it possible to do it? I do not, and cannot until some positive proof—not assertion is given. As to Mr. Arby Blodgett having produced the sweet and sour apple, it is very doubtful, and I believe the origin is much older than Mr. Blodgett. I can recollect of hearing of it since I was quite young, and I saw it asserted, not long since, that it was over a hundred years old."

Sweet and sour apples on one tree or in one fruit, have been known for 100 years, and perhaps many more; and no doubt such varieties may originate from seed, or from natural variation—as well as by embryonic inarching. But granting this, why might not Mr. Blodgett have raised another? There are different grades of sweetness and sourness, and we have nowhere seen it stated that this particular apple of Mr. Blodgett's is the same as the one or ones of the last century. It may or may not be—we only say that there is no evidence that they are the same. In regard to the other question, "do we believe it possible that halved buds will unite in this way?" we reply, *we do*. The writer did not think so until he tried it for himself, which, as we understand it, none of the gentlemen who *believe* it cannot be done have tried. Twelve grafts each of *Red Astrachan* and *Rhode Island Greening* were taken, halved, and set accurately together. *Three of these grew*, and are growing. *To all appearance*, the experiment was a success. In each case, only one shoot came from the spliced buds. It is possible that the embryonic point in one half died, but it does not *appear to have done so*. It is too early yet to say whether any result will appear in the fruit; but it seems to be the best way in all these disputed matters, which can be repeated, to try them over again as we are doing.]

AN EVERGREEN ENEMY.—*J. C. W., Fishkill, N. Y.*: "Enclosed, find a few samples of this year's seedling Norway Spruce, which has been cut off by the thick fleshy white or yellow-

ish grub. They work just under the surface of the ground; the very tender plants they cut off as keenly as though they were cut off with a knife. The older ones, say 2 and 3 or more years old, they strip off all the bark from the top of the ground to the extremity of the root. Now can you tell me any remedy. When I prepared the beds last spring, I sowed cattle salt to the rate of about 10 bushel to the acre, but it does not seem to do any good. Last year they destroyed thousands for us. Last year we used wood-ashes, but without any apparent good. They do not seem to have any choice as to what kind they work on, except Pine, which they do not seem to trouble."

[This is the larvæ of the *Melolontha philophaga*. It is some satisfaction that they are troublesome only every third year. We do not know any remedy. In our own case, we have saved valuable things by taking them up, putting at once in pots of water, and replanting elsewhere from the pail to the earth. Even in the hottest and driest weather this has been done with entire success.]

THE PEACH CROP.—There is good news for the lovers of peaches, which means good news to everybody. The Peach Growers' Association of Delaware met at Dover last week. Their estimate of this yield for this year, the most reliable of any that can be had, is that the crop will reach 3,315,000 baskets, which is more than double the crop in that State last year. Peaches are already beginning to come to market, and they will soon be here in quality and price that will bring them into general use. They have come to be an almost indispensable fruit.

MESSRS. VILMORIN, ANDRIEUX & Co. OF PARIS.—We learn by a note from this firm, that their losses by the French and Paris troubles have been remarkably small. Their city stores escaped the fires, though all around them burned. They are prepared to do business the same as heretofore.

EARLY FRUIT ON LATE TREES.—*W. F. B., Hamonton, N. J.*, writes: "I shall send you,

in care of Brinckloe & Marot, to-morrow, a specimen outside the ordinary course of nature, in the shape of early peaches. The two larger sized and dark colored ones I have just picked from the same tree as the small green one, and the other small one is Hale's Early, which grew within a few feet of it. The variety is ordinarily a few days later than Early York, and most of the fruit will be so this year. The branch which produced the early ones is two inches or more in diameter, and most of the fruit on it is ripening now; but some smaller branches growing from it have small green fruit like the balance on the trees.

Some years since, while living in Massachusetts, I had several quince trees of the pear variety, which always produced late, green looking fruit; but one season I observed a branch loaded with very large, fine yellow fruit, and upon investigation, ascertained that the borers had been at work in the base of the limb, and stopped the return of the sap.

I should expect to find some such disturbance in this case, but for the fact that a portion of the sub branches have green fruit "

[We are unable to give any explanation of this, in view of the fact that our correspondent is himself aware of the precocious effects of injuries to the circulation. We should, but for this fact, have attributed the early ripening to this. Nothing probably but a careful watching of the whole process by some one on the spot will explain it; and it is well worth watching, as some new idea of value to the fruit growers may be the result ]

SOWING NUT TREES.—S, writes: "Can you spare a few moments of your valuable time to answer a few questions. We want to know the best manner in detail of germinating seed of Butternut, Black Walnut and Chestnut (Am. Sweet). Also Horse Chestnut.

1. How they should be treated after gathering in autumn?

2. If put in sand, how wet should it be?

3. Is it good to plant in autumn, here, also at the West?

4. How deep to plant?

5. What portion of good nuts ought to germinate?"

[Keep them from drying in the sun; dry in a cool barn or shed.

2. Almost dry,—or as one might say, barely damp.

3. We have seen success follow as well in spring sown as in fall sown,—and failure in both. Too much water, or too little at the germinating stage is an injury, and only great care can guard against this. This will follow from any season's planting.

4. Quarter to half an inch.

5. All should grow, but the moisture question decides it practically: some years all will grow, at others only a portion. When grown in the open air, it is not possible to have the elements under such perfect control that all will do well.]

SPONTANEOUS GROWTHS.—S. says: "I want to see some time an article from your pen on the subject of Spontaneous growth, as our Western friends call the phenomena connected with the spontaneous growth of trees, &c., on the prairies. In Iowa, I have seen thousands, or at least hundreds of acres, thickly covered (mass of them) with hazel-nut bushes, and am told that as soon as fire is perceived running over, that at once these hazel bushes put in an appearance. This on ground that has been in sod—the good Lord alone knows how long. A hazel-nut can't remain sound in the ground hundreds of years. Neither will a hickory or walnut; yet these trees "come." Neither can dormant roots remain in growing condition for any such time. Do they come for earth, air, water? Are they *created*? Is it not a subject of sufficient interest for scientific investigation?"

I confess that I feel a great deal of interest in this subject and wonder somebody does not go to the bottom of it. Where is there a better man than yourself?"

[The facts are not always as represented. Hazel may spring up as observed; but the plants which *were there* before the fire, had not been observed. The grass was killed by the fire, but the hazel roots *were not*; having now all the nourishment instead of part, they grew more luxuriantly than before the fire, and hence better observed. If the hazel-nuts are in the soil, *waiting for the fire*, why don't they plough them up when turning down the prairie sod? Surely they are large enough to be seen! The fact is this idea of the long vitality of seeds in the soil, waiting for ages to get a chance to grow, is one of the grossest of delusions: and only that scientific men, in some things so careful of facts, are in other things the most credulous of mortals. The idea would have never gone beyond those who see mysteries in every wind that blows.]

FRUIT IN LIVINGSTON CO., N. Y.—*A Correspondent* says: "Apples in this county a failure. Fair crops I understand in Niagara Co. and Orleans Co., (of Baldwins) and pretty good crop in Wayne Co.

Pear trees full to overbearing all through this part of the State—good size and fine."

GROWTH OF ENGLISH ALDER IN TEXAS.—*A Correspondent from Texas* says: "That the English Alder seems to take remarkably to the prairies of that country. He has a growth of eight or ten feet a season from it.

ALPINE HOUSES.—*A correspondent* enquires what these are. It has been found very difficult to grow plants from mountain regions in our gardens in a general way; because the summers are hot and dry, while the mountainous climates are usually moist and cool. Hence in Europe they have greenhouses made so as to be moist and cool in summer, and they call them Alpine houses. There are none in this country so far as we know.

LANDSCAPE GARDENING.—By a card in our advertising column it will be seen that Mr. Copeland has established an office in Philadelphia. Mr. C. is well known as the author of one of the best works on landscape gardening, and he will find Philadelphians amongst the best patrons of this beautiful art.

CRUSHING THE COLORADO POTATO BEETLE.—*Chas. E. Bessey, Ames, Iowa*, says: "I notice in the July number of the *Monthly*, a proposed remedy for the *Doryphora 10-lineata* which to people acquainted with the habits and powers of endurance of the insect seems almost absurd. *Cantharides* may be killed, perhaps by the method you suggest, but I venture to say that in the case of the *Doryphora*, the remedy would be far worse than the beetle itself.

The mature insects are provided with an exceedingly hard coat, rendering it somewhat difficult to crush them on ordinary soil—even with a hoe or spade; in fact I have frequently stepped upon them with my whole weight when on the ordinary soil of the potato field, and the only effect was, that they were forced into the earth from which they soon came apparently not at all hurt. They have the habit of feigning death as soon as touched, dropping from the vines and curling up in the best manner to resist injury from crushing or any other cause.

So far hand picking and then burning has been the only *sure remedy*, but this is slow and very expensive. Paris Green is largely used, but your objections to it are well taken. Our chief and only hope is in the natural enemies of the depredator, and of these the number is not small. The "Lady Bug," "Soldier Bug," and various others are beginning to reduce the numbers of the pest in this State quite materially. Something can be accomplished by a proper selection of the varieties of potatoes. On this last point see my article in *Western Pomologist* for July.

I send eggs—larvæ and perfect insects, male and female—the *smaller* being males.

MOVING LARGE TREES.—*An Iowa City Correspondent* writes: "I have two evergreens, a Pine and a Balsam Fir, twelve years set, and are twenty feet high. I am desirous to move them on to a lawn, 100 feet distant. Can it be done successfully? If so, how, and what time? Any suggestions would be thankfully received."

[Such very large evergreens are best prepared a year before. Dig a circle any time during spring or summer about 6 feet from the trunk, and about two feet deep, cutting under the top roots if possible, and then filling up the trench with the earth taken out. The following spring the tree may be removed by opening the same trench. Fibrous roots will then be made. It is not necessary to care for a ball of earth on removal by this process. Keep the fibres from drying by winds, and hammer in the earth tightly at transplanting, and there will be little risk of failure.]

DUPLICATION OF NURSERY NAMES IN DIRECTORIES.—*James Ford* writes: "Enclosed find two envelopes, both received by me, although you will see some little difference in the address. In the *Western Rural Annual*, 1871, Chicago, list of Nurseries, Indiana, I find James Fad, Princeton. Having frequently of late received two circulars from one person addressed as the two envelopes. I have taken pains to inquire for James Fad, but can find no such name in the nursery business. I suppose therefore that the editor of *Western Annual*, (or some one) has made the mistake from my name alone.

I think, Mr. Mehan, if you will notice the above in the *Monthly*, you will oblige many of the trade who are sending out their circulars, and me also, as one list is sufficient."

A good Directory is badly wanted. The principle adopted by some compilers of charging two dollars for every name inserted will never get up a good one. A better plan would be to compile one honestly, and trust to the recompense by the sale of it,—just as any other commercial directory-maker would do. The *Western Rural* does not charge to get into its list; but if it did, would the duplication of names by bad orthography add to its revenues?]

TO CORRESPONDENTS AND INQUIRERS.—The Editor's absence in the West for a few weeks is the occasion of some delay in answering a few inquiries. These shall have early attention in future numbers.

NEW BOOK ON TREES.—We see it announced that Mr Bryant is about to issue a book on tree culture. He has had wide experience, and no doubt will make up an excellent work.

CATALOGUES.—As the planting season approaches we are daily receiving numerous Trade Lists and Catalogues Wholesale and Retail. It is pleasing to note the enterprise of our Nurserymen, their Catalogues being replete with all the new and rare trees, plants, &c., as well as with kinds more generally known.

We find on our table the following: C. L. Allen & Co., Wholesale Bulbs; Stark & Barnett, wholesale general list; H. M. Thompson, general list; Hoopes, Bros. & Thomas, semi-annual trade list, general stock; Peter Henderson & Co., retail bulbs, rustic work, designs, &c; Sears, Henry & Co., general wholesale list; H. M. Engle & Son, general wholesale list; A. H. Vail & Co., retail nursery stock; Thomas Mehan, general wholesale list; Merrell & Coleman, trade list nursery stock; T. T. Southwick & Co., wholesale trade list; Will & Clark, wholesale fruits, evergreens, &c; J. M. Jordan, wholesale trade

list, wire goods, &c; A. & J. Hammond, trade list fruits, &c; E. Snyder, retail list nursery stock; Peters & Hatch, wholesale greenhouse and ornamental stock; E. C. Peirson, wholesale fruits, &c; Thos. H. Payne, wholesale and retail stock; Wood & Hall, wholesale nursery stock, implements, &c; Bird & Gray, wholesale fruits, stocks, &c., also retail list; S. L. Gaar & Cox, descriptive list general nursery stock; Lindley M. Ferris & Son, wholesale fruits, ornamentals, &c.; Otto & Achelis, wholesale trade list evergreens, fruits, &c.; R. J. Halliday, trade list winter blooming plants, &c.; Robt. Douglas & Sons, wholesale evergreen seedlings, seed, &c; Gould Bros., wholesale roses, bulbs, border plants, shrubs, trees, &c; James Vick, bulbs, seeds, baskets, &c., retail; John J. Kreider, fruits, potatoes, &c.; E. Ware Sylvester, new peaches, fruits, &c., Wood & Hall, bass bark; Burrow & Wood, fruits, evergreens and ornamental, wholesale; W. F. Heikes, wholesale general list; Ellwanger & Barry, retail bulb list; Storrs, Harrison & Co., wholesale general list; E. J. Evans & Co., retail list of field and garden seeds; Burkholder & Meals, wholesale general list; Maxwell, Pratt & Co., wholesale general list; P. H. Foster, wholesale list of seedlings, &c.; Stuart & Humphreys, trade list fruits, trees, &c.; E. Moody & Son, wholesale fruits, stocks, trees, &c.; T. B. Yale & Co., wholesale roses, fruits, trees; Storrs, Harrison & Co., chestnut circular; Louis Van Houtte, retail bulbs, &c.; Ellwanger & Barry, wholesale general list; Dr. H. Schroder, wholesale fruits; H. A. Dreer, flower and vegetable seed; Peter Henderson, wholesale greenhouse plants; L. Kauffman, fruit stocks, trees, &c.; T. C. Maxwell & Co., wholesale trade list fruits, ornamentals, &c.; J. Jenkins, wholesale nursery list; E. T. Dickinson, wholesale fruits, roses, &c., F. L. Perry, wholesale fruits and roses; T. S. Hubbard & Co., wholesale grapes; Dr. John E. Ennis, list of special stock, evergreens, &c.

## NEW AND RARE FRUITS.

PLOWDEN'S SEEDLING PEACH.—Dr. Swasey writes: "Somebody is wrong about the Plowden's Seedling Peach. Who is it?"

In your August number you say that it belongs to the *glandless* section" and that the leaves are

very long and narrow. Enclosed I send you a leaf just taken from one of five trees received direct, last spring, from J. B. Clagget of Washington, D. C. These trees are all alike, and its leaves have small *globose* glands, fully as large

and prominent as the yellow Rareripe or the Crawford as you will see by the leaf sent, which is an average as to both shape and gland. Are my trees wrong or are you mistaken?"

[There is some confusion about this peach which we cannot unravel. Mr. Claggett brought the peach himself to our office, which was as described in the *Gardener's Monthly* at the time. It was *not* Hale's Early. The leaves were long, slender and tapering, sharply but finely serrate, and *glandless*. We have since noticed that a body of good fruit men at Washington, of whom Mr. W. Saunders was one, has pronounced it nothing but Hale's Early,—but Hale's Early is a glandular variety. Now comes a leaf also said to have been received from Mr. Claggett, which is broadly lanceolate, rather crenate than serrate, and glandular; and *not* the leaf as we received it. Something wrong somewhere, but where we do not know.

DR. WYLIE'S HYBRID GRAPES.—As the first Horticultural Magazine to call attention to Dr. Wylie's efforts to improve the grape by hybridization, we have watched the development of these seedlings with much interest. We have now before us a set of bunches, which affords us much pleasure to testify to their excellence. Peter Wylie is a white variety of strong and vigorous habits, Janie Wylie is between Clinton and a foreign variety, and to us has a peculiar flavor, highly agreeable, and by which we think it could be alone distinguished from any other grape. No. 38 we suppose has not been named yet. It is of Delaware character, and excellent. A new variety, fruited for the first time this year, is a large black berry, but in the writer's absence had somewhat fermented; and we are thus unable to speak definitely about it; but its appearance was very promising.

Dr. Wylie deserves great credit for his persistent effort to improve the grape in this way. His success in producing first class varieties is alone a reward; but besides it sets at rest the problem about hybridization better than perhaps any other experiment that has been tried. There have been some doubts as to whether other so called hybrids were really so, but none we believe about these.

PEACH, YELLOW ST. JOHN.—Dr Swasey says in *Southern Horticulturist*, that this is "far ahead of every thing else as a market fruit in the South," and that "its career of popularity is

just beginning." It was grown many years ago by a Mr. Fleitas, of Mississippi City, who called it St. John. It has also been distributed as "*May Beauty*,"—not certain that it was the same as May Beauty. Dr. Swasey distributed it as Yellow St. John. It is described in some works as Flavus St. John, and in others as Flatus St. John.

STRAWBERRY, DR. WARDER.—Dr. Warder is the name of a seedling Strawberry raised by Louis Ritz, Plainfield Ohio, which has received the \$50 silver cup of the Cincinnati Horticultural Society.—CHAS. DOWNING.

LAURA BEVERLY GRAPE.—You have a notice of this grape in your last number as being a distinct variety; but a plant sent me by D. W. Beadle, of St. Catharines, has proved to be Crevelling, and Mr Beadle informs me that they have proved identical.—CHAS. DOWNING.

PEACH BEATRICE.—S. G. Bilyeu, of Littleton, Halifax Co., N. C., exhibited to the editor of the *Agriculturist*, on June 19th, a specimen of a new early peach called Beatrice. This is a seedling by the celebrated Thomas Rivers, of Sawbridgeworth, England. Upon the grounds of Mr. Bilyeu, Beatrice is at least 20 days earlier than Hale's Early. Like all early peaches, it is small, but it has a very high color, is very fragrant and of good quality for a very early variety. The specimens presented had been picked for five days, and were in perfectly good condition, and would seem to warrant Mr. Bilyeu's claim, that they possess superior shipping qualities.

DENTON PLUM.—*J. B. K., Denton, Md.*, writes: "I send you by to-day's Express, a small box of the Denton Plum. The fruit, as you will observe, belongs to that of the wild plum (*Prunus Americana*); this though is a variety that for several years past, by its sure and abundant crop, has attracted considerable local attention. The tree from which I hurriedly gathered these now not fully ripened specimens, is small yet, but has at least one and a half bushels of fruit on it this season, and had it not been for the timely 'put in' of the curculio, there doubtless would have been another bushel. The much hated insect aided some little in thinning

the crop, but the thought occurred to me, while working near the tree, that the 'bug gave up in despair ere its work was completed.' They may not be fully ripened up when you receive them, but I need not tell you what to do with them. Do you not think it better to have one and a half bushels of these on a single tree, than one and a half dozen trees of the larger and finer kinds without perhaps a specimen to the tree? I no-

tice several small orchards planted in this country of the same species; they pay in market, which seems to be the grand lever in American enterprise."

[Well worthy of all our correspondent says of it. We do not, however, feel sure that it is distinct from the Golden Miser or Golden Cherry, — but even if the same, it should be more cultivated than it is.]

## NEW AND RARE PLANTS.

**Sium Helenianum**—NEW EDIBLE PLANT.—In the recently issued number of *Hooker's Icones Plantarum* (Part 2, Williams and Norgate), among a number of plants for the most part of purely botanical interest, is a notice of an edible umbelliferous plant, *Sium Helenianum*, sent from St. Helena by Mr. Mellis, and concerning which Dr. Hooker writes as follows: "The green stems, like pieces of bamboo, are brought to the market of St. Helena for sale, and are eaten raw under the name of 'Jellico.' It was originally discovered by Roxburgh early in this century, and has not been gathered by any subsequent collector except Mr. Mellis, who has sent to the Royal Gardens a dried specimen, living plants, seeds, and a bundle of the stems as sold in the market. *Sium Helenianum* is another instance of the curious fact that herbaceous plants are often represented by frutescent or arborescent allies in insular localities." This is borne out by other umbelliferous plants found in St. Helena, Madeira, &c, as well as by the arborescent composites of the former islet, &c. *Lichtenstenia Burchelli*, another arborescent umbellifer from St. Helena, is at first sight very similar to the plant above described, and seems to have been mistaken for it by Burchell, who in a note attached to his specimens calls it *Angelica*.

**ADIANTUM VEITCHII**.—A distinct and fine Fern, introduced from Peru.

It is extremely ornamental, attracting the eye by its rigid character and the symmetry of its growth; and we recommend it as a most desirable evergreen Fern for a warm greenhouse or intermediate stove.

The young fronds are very beautiful, being of a fine red color, that of the mature fronds being of a pale green.

The largest pinnules measure about an inch in their longer, and half an inch in their shorter diameter, and are set stiffly on the plane of the fronds.

The full-sized fronds attain an average length of 1 foot.

**BEGONIA CHELSONI**.—This is one of the finest of the flowering Begonias. It is a hybrid, raised at Veitch's Nursery, between *B. Bolivensis* and *B. Sedeni*, both now so well known.

It is very free in growth, and of good habit. The flowers are of a bright glossy red color, and of very large size. The plant continues in bloom from May to November.

As a decorative plant it cannot fail to be most extensively grown, and it will form an excellent companion to the *B. Sedeni* sent out last year.

It has received First-class Certificates both at the Royal Horticultural Society's Exhibitions and the Royal Botanic.

**CROTON JOHANNIS**.—Of all the recent introductions of this very beautiful class of plants, we consider *C. Johannis* one of the most elegant and distinct.

The leaves attain a length of 20 to 24 inches, and are of a glossy green color, the centre and margins being bright orange yellow.

The plant is of very graceful habit, and we can with confidence pronounce it to be exceedingly valuable both for dinner table decoration and for exhibition purposes.

It has been named after the late Mr. J. G. Veitch, by whom it was discovered during his trip to the South Sea Islands. Whenever exhibited it has received First Prizes.

A very excellent wood cut is given in the *Gardener's Chronicle*, May 13th, 1871.

**CROTON MULTICOLOR.**—One of the most distinct of the many fine varieties of Croton, found by the late Mr. J. G. Veitch in the South Sea Islands.

The leaves attain a length of 7 to 9 inches, are very irregular in shape, oblong spatulate, tapering at the base, and irregularly contracted in the centre.

The young leaves are of a light green, blotched with yellow, but turning with age on the upper surface into a glossy green, puckered and irregularly blotched with yellow, reddish yellow, and red, the midrib crimson, the secondary veins yellowish, the under surface being red.

It has received its name from the great diversity of its coloring.

**CROTON HOOKERII.**—Another of the beautiful South Sea Island Crotons brought home by the late Mr. J. G. Veitch.

It forms a handsome compact growing shrub, with broadly ovate lanceolate leaves, abruptly tapering or rounded at the base.

The upper surface of the foliage is of a beautiful dark shining green, broken at the base with a broad blotch of golden yellow, and with irregular projections of the same color running from the midrib towards the margin, the midrib being golden yellow, as are also the young stems and leafstalks.

The Editors of the *Gardener's Chronicle*, when describing the whole of Veitch's Collection of Crotons in 1868, p. 943, thus speak of *C. Hookerii*—"This variety is marked much in the same way as the Milkmaid Holly."

It has been exhibited on various occasions, and has received numerous First-class Certificates.

**DIEFFENBACHIA BOWMANII.**—This fine plant was discovered by the late Mr. Bowman during his trip to South Brazil, and was described by him as being "as far superior to all Dieffenbachias as *Maranta Veitchii* is to all the *Marantas*."

The leaves, which attain an immense size, are of a pleasing light green color, spotted with dark green, or rather black green spots, thus giving the plant a very distinct and striking appearance. They attain a length of from 2 to 2½ feet, and an average width of 1 foot, thus proving it to be a most useful exhibition or decorative plant. It has received First-class Certificates both from the Royal Horticultural and the Royal Botanic Societies.

It has given Veitch satisfaction to be able to associate with this fine introduction the name of its discoverer, who unfortunately lost his life whilst carrying out his researches in South America.

**DRACÆNA MAGNIFICA.**—It is probably the most handsome of the *Dracænas* brought home from the South Sea Islands by the late Mr. J. G. Veitch, and it is considered as being far superior to any variety which has as yet been introduced.

It is very free in growth, and the leaves, which have a spiral growth, attain a length of 1½ to 2 feet, and a width of 8 to 10 inches.

They are of a beautiful bronzy pink color, changing when old into a somewhat darker shade. The leaf-stalks are nearly purple.

This truly magnificent *Dracæna* has been exhibited in Paris, Hamburg, and at the leading English Exhibitions, where it always obtained first-class honors, and was universally acknowledged to be well worthy of the name it has received.

**DRACÆNA PORPHYPHYLLA.**—This is another of the fine *Dracænas* discovered by the late Mr. J. G. Veitch, and we can with confidence recommend it in all respects as a first class plant.

In the review of the new plants exhibited during the past year, the Editor of the *Gardener's Chronicle* refers to this fine species in the following terms (see *Gardener's Chronicle* of January 7th, 1871, page 6):—

"Of foliage plants of shrubby character, we specially single out, as the best plant of this class shown during the year, *Dracæna porphyphylla*, a South Sea Island species, of noble habit, with bold, erect, broadly oblong leaves, which are of a fine deep bronzy hue, and remarkable for the contrast presented by the glaucous hue of the under surface."

It was exhibited at the Royal Horticultural Society, on 2d November, 1870, and received a First class Certificate.

**NEPENTHES SEDENII.**—This really pretty variety is a cross between an unnamed species with deep colored pitchers, and *N. distillatoria*. The pitchers are produced in great profusion, even on very small plants; they are of medium size, the surface being light green, and very densely covered with dark red spots. It is of dwarf and very neat habit, and we can highly recommend it to all lovers of this beautiful class of plants. It was awarded a First-class Certificate at the Royal Horticultural Society's Exhibition on June 8th, 1870.

**PANDANUS VEITCHII**—This magnificent Pandanus was discovered by the late Mr. J. G. Veitch during his journey through the South Sea Islands, from whence he brought so many beautiful and interesting plants.

Messrs. Veitch say: "We consider it to be one of the best plants we have ever had the pleasure of offering to the public, and can, with confidence, recommend it as being very far superior, either as an exhibition plant, or for decoration, to any other Pandanus yet known."

The leaves are slightly serrated, of a light green color, beautifully striped with broad bands and lines of pure white. They average 2 feet in length by 3 inches in width, growing erect from the stem, but towards the end gracefully curving, thus giving the plant a most elegant appearance, and showing itself to be perfectly distinct in habit as well as in coloring.

It has been exhibited at St. Petersburg, Paris, Hamburg, and at the leading London and County exhibitions, where it has always received the highest awards and been universally admired.

**RHODODENDRON BROOKII GRACILIS.**—This is one of the freest blooming of all the yellow flowering Bornean varieties of Rhododendrons.

It is quite distinct from the species known as *R. Brookii*, being much more graceful in habit, and flowering more freely. The leaves are light green, contrasting well with the pale yellow flowers, which are of large size, and produced in compact trusses of from ten to twelve flowers in each.

The plant blooms in quite a young state.

For the introduction of this fine novelty we are indebted to Mr. Thomas Lobb, who sent it to Messrs. Veitch from Borneo.

**TODEA WILKESIANA**—Messrs. Veitch say it gives as great pleasure to be now in a position to offer this beautiful miniature Tree Fern for the first time.

For a correct description of this elegant Fern, we feel we cannot do better than refer to the wood cut and description published by Mr. Moore, in the *Gardener's Chronicle* of June 11th, 1870, where he says:—

"The trunk is from 18 to 20 inches high, and 1½ inch in diameter, crowned at the summit by from ten to twelve spreading fronds, of a broadly lanceolate outline, and 2 feet or upwards in length. The pinnæ are sessile, oblong lanceolate, spreading. The pinnules are oblong obtuse, dentate, and pellucid. Messrs. Veitch's parent plant has already a stem of a foot or more in height, and about an inch in diameter, which slender tree like habit gives it quite a distinct aspect among its allies, which include some of the most lovely of cultivated Ferns."

It has been exhibited at the Royal Horticultural Society's Shows, and received a First-class Certificate.

## DOMESTIC INTELLIGENCE.

**A PEACH TREE DISEASE.**—I am very industriously pursuing my fruit culture experiment, and have just encountered my first discouraging incident. I have lost four peach trees; one planted out in the spring of 1870, and three put out in the spring of 1868.

The first of these that died I discovered to be affected in January or February. The trunk and branches were yet green, while the roots were entirely dead. I found gum exuding from the bark of the roots, looking as though the grub had been at work, but I could not find one.



The other two that died I noticed only a few days since. At my first pruning they appeared as healthy as they could be. After flowering and much of the fruit setting, I observed in them a rather sickly appearance, and upon closer scrutiny found the branches green, the flowers drying and the fruit wilting. The bark nearly around the trunk, from the ground up to the first branches, was entirely dead, while the roots and bark at the base nearly up to the surface of the ground, remained alive, presenting a healthy appearance. Digging up the trees showed the ground to be in the best possible condition.

We submitted the above letter, with accompanying specimens of disease, to our Entomological friend, Prof Steele, for investigation, and in response, have been favored with the following interesting and satisfactory.

REPLY.—It is evident that the trees were killed by a somewhat new disease scientifically termed *Sucus obstructio*, but generally known in the localities where it prevails as "peach tree rot." It is to the peach tree about what "fire blight" is to the pear, and "root rot" is to the apple; a disease but little understood, and consequently the subject of a thousand theories.

The most plausible theory in our mind, makes "peach tree rot" arise from a fungus which obtains a footing in the bark of the tree, near the earth line, and sending its roots and spores inward finally deranges the circulation and stops the flow of the sap. On subjecting bark taken from the base of an infected tree to microscopical examination, we find it a complete fungoid net-work. The specimen sent, as referred to in the foregoing, proved to be of that character, and the black specks with white border, which without the aid of microscope would naturally be mistaken for insect eggs, turned out to be perfectly developed fungoid growths, sending innumerable roots entirely through the bark.—Abbreviated from *Farmer and Register*, Edited by P. J. Berckmans.

DAVIS'S SEEDLING POTATO.—This potato although not a new variety, is not extensively cultivated, at least we have never met it until our recent visit to Manhattan. Our attention was more particularly attracted to it by its unusual weight, and its beautiful external appearance. It is a deep red potato, skin smooth, eyes very broad and not quite so deep as in the Peachblow, the principal eye upon the seed end being of a

uniform triangular shape, and deeper than its fellows, general shape round, somewhat flattened on two sides, flesh white and very solid, and remarkably free from cavities; about as prolific as the Peachblow, and, to our taste, superior in eating qualities. A specimen we have before us, measuring only eight and three-quarter inches in circumference, weighs nine ounces. It is a late potato, and a good keeper. It is grown quite extensively in Riley county. We pronounce it a valuable acquisition.—*Kansas Farmer*.

PLANTS FOR EDGING.—The Dwarf Box has been heretofore the plant most commonly used for edging flower beds and walks; but in our climate it suffers so badly in winter, unless constantly covered with snow, that it often presents in spring a very unsightly appearance. By the introduction of the dwarf growing varieties of arborvitæ we are made quite independent, and have in them an admirable substitute for the dwarf box.

The varieties known as *Ericoides* or Heath-leaved, Tom Thumb, Hoopes' Dwarf and Booth's Dwarf, are all finely adapted to this purpose, being naturally of a dwarf habit, and admitting of being trimmed to any desired form or height. In addition to these qualities, they are quite hardy, never suffering from our most severe winters.

These plants grow slowly, and full grown specimen plants are held at high prices, but small plants, such as are most desirable for planting for edging purposes, can be obtained at much lower rates. We think plants of Tom Thumb, six inches high, are sold for six dollars per hundred, and Hoopes' and Booth's Dwarf for ten. In those parts of the country where the snow does not remain all the winter at a sufficient depth to protect the box, these hardy evergreens will be found a most charming substitute.—*Canada Farmer*.

BARREN APPLE TREES—HOW TO MAKE THEM BEAR.—"Through the kindness of the Hon John Whittlesey, the *Herald* is able to lay the following important fact before our readers:

First, the Northern Spy, Red Astrachan, and a number of other choice varieties of apples, have failed through this region to bear apples, although ten or fifteen years old. Two years ago, Dr. Hull, of Alton, delivered a lecture at

Benton Harbor, in which he recommended root pruning. Mr. O. A. Winchester, of St Joseph, of Archer & Co.'s Nursery, had ten Northern Spy apple trees, thirteen or more years old, which had never blossomed or borne a crop. After the lecture, though late in the season, he directed his man to root prune one tree, and half root prune another. Last year no favorable results appeared, probably from the lateness of the root pruning. This year, the tree which was root pruned all around, is full of blossoms, while that side of the tree half root pruned alone is full of blossoms, the un-root pruned side having none at all. Every other Northern Spy apple tree, as usual, contains no blossoms.

This single fact should lead our orchardists to try the experiment this season. Now is the time to begin, and the work of root pruning should be finished by the first of June.'

PROFIT OF EARLY CUCUMBERS.—Nicholas Pierro, a German gardener near Minneapolis, sold nearly \$30 worth of cucumbers in one day, the fore part of July, from one hundred hills. They were, of course, started under glass, and were watered during the dry weather. He goes over his vines three times each week, but the above was the heaviest sale of the season's picking.—*Small Fruit Recorder*.

PURPLE BEECH.—Mr. J. H. Hall, says in *Bulletin of the Torrey Bot. Club*: The finest copper Beech probably in the country, grows at Throgg's Neck, on the grounds of Mr. Van Schaick. It is enormous in size; very beautiful and graceful in shape, of charmingly colored foliage. I think the diameter of the trunk at the height of a man's head, must be six feet.

PHYLLOTAXIS; OR THE LAW OF THE ARRANGEMENT OF LEAVES.—One of the most remarkable instances of the prevalence of law in the natural world, is shown in the arrangement of the leaves of plants

Where the leaves are not opposite, it is found that they grow in spiral rows around the stem, at certain regular distances from one another.

If we fasten a thread upon the base of a vine-leaf, and wind it around the shoot, we shall find that the next leaf, above the one from which we started, is half way around the stem, and that the *second* is directly above the one from which

we began to reckon. This series may therefore be represented by the fraction  $\frac{1}{2}$ , in which the numerator shows that we have made *one* circuit around the stem, and the denominator that there are *two* leaves within the circuit; beginning to count with the leaf above the one from which we started.

In another plant *three* leaves will be found in *one* circuit, the first leaf being *one-third* of the distance around the stem, the second *two-thirds*, and the third completes the circuit. This series is therefore represented by the fraction  $\frac{1}{3}$ .

Other plants, as the pear and currant, have a series of *five* leaves making *two* circuits, the first leaf in the spiral row being placed at *two-fifths* of the distance around the stem from the leaf assumed as the starting point, the second, *four-fifths*, the third, *six-fifths*, and so on. This series is, therefore, indicated by the fraction 2-5. Other plants have a series of *eight* leaves in *three* circuits, and some *thirteen* in *eight* circuits.

Taking now into view these several systems, they may be represented by the following fractional series, viz.,  $\frac{1}{2}$ ,  $\frac{1}{3}$ , 2-5,  $\frac{2}{3}$ , 5-13, etc.

This series expands according to the law that any one of the terms, after the second, is equal to the sum of the numerators of the two next preceding terms divided by the sum of their denominators.

We have, therefore, the curious fact that a mathematical series expresses one of the fixed laws of organic growth.—*Wood's Botany*.

HUMBLE BEES.—Boys think it glorious fun to fight humble bees, but they should not be encouraged in the warfare. Humble bees, like all other hymenoptera, play an important part in the great field of nature. The vein winged insects which fly from flower to flower, do not injure or destroy the flowers, but make them productive by disturbing their pollen. They also rid us of innumerable noxious caterpillars and other insects, which they convert into wholesome food for their offspring.

The ordinary honey bee performs its work well in the fertilization of white clover, but its proboscis is not long enough to enable it to reach the nectaries of red clover. For the fertilization of red clover, we must rely to a great extent upon the humble bee.

Darwin has called attention to the intimate connection between the number of cats in a given district and the yield of red clover seed. The

mice destroy humble bees, and the cats destroy the mice; therefore, the more cats the more humble bees, and the more humble bees the greater is the red clover yield. In order to make red clover grow more abundantly in New Zealand than it does, some enterprising gentlemen are talking of importing colonies of humble bees from England. Our young friends will

thus see how earnestly the humble bee is desired in countries where he works not. Then should we not protect what we have, and which performs such an important services in our fragrant meadows? We think so, even if it does interfere with the wild pleasures of careless boyhood. —*Turf, Field and Farm.*

## FOREIGN INTELLIGENCE.

**RASPBERRIES.**—A fruit requiring special gathering for market, and it ought only to be sent there in water-tight vessels, as the juices run out. It is often an unsatisfactory article both for buyer and seller, as the first named often questions whether all the juice the fruit is swimming in when it reaches London was not gathered with it from the bushes; and certainly there is every scope for increasing the quantity by the same means as are adopted with milk; but as this is not our purpose, we may say that although the Strawberry, as before remarked, dislikes a calcareous soil, this plant luxuriates in one, and the best examples of good cultivation I have met with are of this kind; depth of soil and a little more moisture than most other kinds of fruit delight in, are also requisite to enable the plant to ripen off its later fruit to advantage.—*Journal of Horticulture.*

**REVIVIFYING AN OLD MUSHROOM BED**—From Mr. W. P. Ayres, of Nottingham, we have received a quantity of very fine mushrooms, the produce of an old bed that, under ordinary management, would by this time have been destroyed. It appears that some weeks ago one of Mr. Ayres's beds, which had borne well, began, after the fashion of old mushroom beds, to become exhausted; but, instead of destroying it, he firmed down the bed, filled up with all the interstices, and gave it a thorough dose of water, farm yard liquid manure, salt, and guano, heated to about 80°. The result was that the bed began to bear better than it did before. The liquid was of course in a highly diluted state, and given so abundantly, that every part of the bed was saturated with it. These facts are worth the attention of all mushroom growers.—*Gardener's Weekly.*

**IMPORTANT TO THE NURSERY AND SEED TRADES**—The following information may perhaps be of service to seedsmen and nurserymen who receive orders by post unaccompanied with remittances: "A dealer residing in a provincial town was recently sued in the City of London Court for a small amount; but, while not disputing the claim, the debtor set up the plea that the goods had by him having been ordered by post, he could only be sued in the district in which the orders were posted; and it seems he was right, for he carried the day. As it would be hardly worth while to take all the trouble that might be necessary to compel payment under such circumstances, it is clear that small transactions between parties residing at a distance from each other can only be safely carried on when cash payments are the order of the day. As the law now stands, ingenious individuals who happen not to be overburdened with honesty may carry on a system of fraud without running much risk. We can only hope that performers in this line will go ahead vigorously while they have the chance, and thus draw the attention of our law makers to the necessity for a little law-mending in this direction."

**CAUTION TO NURSERYMEN AND OTHERS.**—“Our readers,” says the *Sussex Express*, “have got pretty well acquainted with the gentry who advertise for agricultural produce, garden stuff, game, poultry, anything, indeed, which they can hope to obtain without paying for it; but there has lately been a novelty contrived in their mode of operating. The original plan was to give a London address, get the goods sent to a London railway station, deferring payment on some pretext or other, and, of course, when they had ob-

tained possession, the swindlers disappeared. The improved scheme is to give an apparently local name—some well known Sussex or Kent name—and give a local address. A couple of rooms are taken in some country town in the name adopted, advertisements are freely issued, shoals of letters, we are told, pour in, the replies are in the most business like form, and then an addition to the country address appears as an additional place of business, in or near London. This is not all. In one case we are assured, however, a still stranger device was used. A check was actually sent drawn on a well known bank in the City, but when it was presented it was returned, marked 'refer to drawer.' This could not be done."

**BAILLON'S L'HISTOIRE DE PLANTES**—We are informed that an English edition of this work, with the original illustrations, will be published shortly by Messrs. L. Reeve & Co. The first volume is expected to appear in the autumn.

**A WORCESTER FRUIT FARM.**—We learn from *Berrow's Worcester Journal* that Mr Vardon, who is described as a "shrewd, clever, and accomplished man," has worked out the idea of a fruit farm on a magnificent scale, near Pershore. His estate is 250 acres. Of this about 140 are planted with fruit trees. These include 60,000 gooseberry bushes, 100,000 currant trees, and about 6,000 plum trees, to say nothing of hundreds of pear and apple trees, and other "gigantic vegetables," as the French call them. Along with his neighbors in the Pershore district, Mr Varden has a fine crop of plums this year. The particular plum which is grown near London having been a comparative failure, the Pershore growers get the benefit of large crops and good prices. The extent of the farm may be imagined when we mention that for weeks Mr. Varden has sent off four or five tons of fruit a day. One lot of currants sent away on one day to one customer weighed seven tons.

**THE LARGEST ROSE TREE.**—The largest rose bush is a white *Banksia*—so called after lady Banks—in the Marine Garden at London, which was sent there, the first of its kind, in 1812, by Boupland. Its numerous branches, some of which measure eighteen inches in circumference, cover an immense wall to a width of nearly six-

ty feet, and at times, in early Spring, as many as fifty thousand flowers have been counted on this queen of all roses.

**ANNOUNCEMENT OF FRUIT DICTIONARY.**—We are informed that a very valuable dictionary of fruit trees, from the pen of M. Andre Lurz, Antwerp, is in progress; indeed, a part of it comprising three large volumes, on pears, apples, quinces, and medlars, is already complete. Each fruit is treated in an elaborate manner, and to the mode of its culture is prefixed a brief yet complete history. Besides several types of each variety, 915 varieties of pears are described, and each description is accompanied by a woodcut.

**GROUND LEVELLING AND PRACTICAL GARDEN PLOTTING.**—To draw and transfer to the ground the design, draw the inside circle, and divide it into five equal parts. With point *f* as centre, draw circles *k* and *z*, as shown by the thick and dotted lines; draw corresponding circles from points, *a*, *b*, *c*, and *e*. Again from point *f* draw arcs *h* and *g*, also draw corresponding arcs from points *a*, *b*, *c*, and *e*. Where the lines cut each other are the corners of the beds. From centre *r* draw circle *s*.

To transfer *fig.* 40 to the ground. Find the centre of the piece of ground upon which it is intended to trace the design, and insert a peg, as at point *r*. Lay the diameter line *a d*, making *r* the centre. The diameter line *a d* is 40 feet long. From the peg at centre *r*, with a line 20 feet long, trace circle *a b c d e f*; divide the circle into five equal parts, to get the centres from which the design is traced. The best and surest way to do so, is to form a pentagon inside the circle in the same manner as described in *fig.* 12. It is done thus on the ground:—From the peg at point *a* with a string equal in length to the diameter—that is, 40 feet long, trace an arc from the peg at point *d* to point *t*; then from the peg at point *d*, with the same radius, trace an arc from peg *a* to *t*. Where the two arcs cut each other at point *t* insert a peg, then divide the diameter line into five equal parts, as 1, 2, 3, 4, 5; as the line is 40 feet in length, each division will be 8 feet—that is, from the peg at point *a* measure 8 feet, and insert a peg as at point 1; from the peg at point 1 measure 8 feet, and insert a peg as at point 2, &c. From the peg at point *t*

—that is, where the two arcs traced from pegs *a* and *d* cut each other—lay a line passing through the second point or division and cutting the circle at point *f*; then lay a line from peg *f* to peg *a*, which will be one side of the polygon. Apply the line five times to the circle, and insert a peg at each point, as at point *a*, *b*, *c*, *e* and *f*. From the peg at centre *r*, with a string 39 feet long, trace circle *s*; from the peg at point *f*, with a string 19 feet 3 inches long, trace circle *k*, as shown by the thick and dotted line; reduce the string 4 feet and trace circle *i*, also shown by the thick and dotted line. From the pegs at

points *a*, *b*, *c*, and *e*, with the same lengths of string, trace corresponding circles to *k* and *i*. From the peg at point *f*, with a string 8 feet long, trace arc *h*; reduce the string 1 foot and trace arc *g*; trace corresponding arcs from the pegs at points *a*, *b*, *c*, *e*. From centre peg *r*, with a string 2 feet 6 inches long, trace the circle in the centre. Where the lines cut each other are the corners of the beds, marked *w*; *w* being walks — M. O'DONNELL, Gardener to E. Leeming, Esq., Spring Grove, Richmond, in *London Journal of Horticulture*.

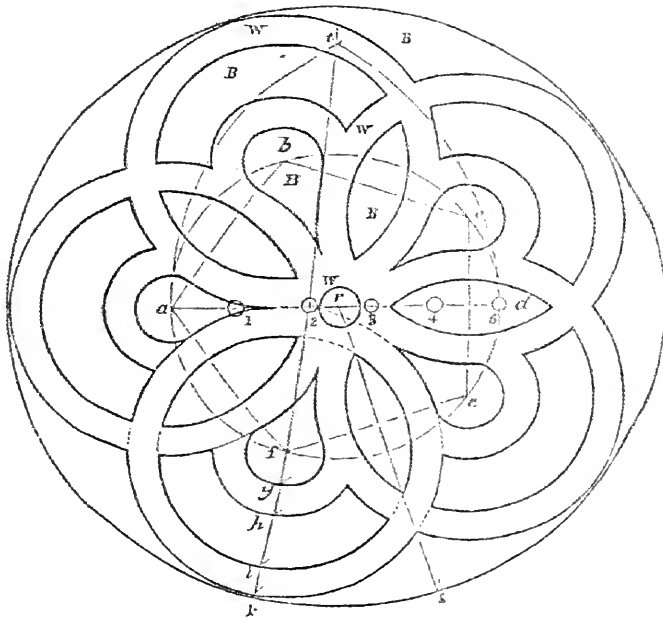

**CALADIUM ROOTS — Wintering *Caladiums*.**—**C.**—The corms can either be allowed to remain in the old soil or be shaken out and buried in dry silver sand. Wintering them in the soil in which they were grown the previous season is in the majority of cases preferable. The most important matter in connexion with wintering them, is to dry the plants off early, and also to withhold the water immediately, or before they begin to show signs of dying down, as, when watered until the greater part of the foliage is dead, the soil remains moist for a long time after the growth has ceased, and the corms perish in consequence. The soil should become quite dry by the time three-parts of the leaves are dead, and the pots containing the corms should

be placed in a temperature of between 55° and 70°, and it is useless to attempt to winter them in a lower temperature than the minimum here given. The pots should be overhauled two or three times during the winter, and the corms carefully examined, but without disturbing the soil more than can be helped. If any of the corms evince the slightest signs of decay, all in the same pot should be shaken out, and all traces of decay removed with a flat piece of stick, and the wounds dressed with powdered charcoal or dry silver-sand. The corms should then be placed on a shelf to dry for a week or ten days, and then be buried in dry sand. This remedy seldom fails in arresting the progress of the disease. We sometimes meet with directions for

syringing the outside of the pots and the surface of the soil occasionally during the season of rest; but the advice is bad, for moistening the soil in the slightest degree at that period is neither necessary nor desirable. A temperature of 50° will suit the fern named admirably.

**EARLY TULIPS.**—Doubtless these showy flowers will some day or other be grown extensively by all classes, but at the present day they are neither grown nor appreciated one-tenth part so extensively as they should be; one-hundredth part would perhaps be nearer the mark, for it is quite a rare occurrence to meet with a few beds of tulips even in gardens of considerable pretensions, instead of their occupying a position in the parterre worthy of their merits. Here we grow large numbers of spring flowering bulbs of all kinds, but the tulips, taking all things into consideration, are the most useful, and they are grown by thousands. Crocuses and Hyacinths are very well for flower-garden decorations, but the flowers of the first named are of such a short duration that their beauty is past almost as soon as they are expanded; whilst the latter are hardly showy enough for the time of year in which they are in flower, besides being expensive. The stock also requires a regular renewal of purchase, as the bulbs degenerate very rapidly, and after the third year are of very little use. On the other hand, with moderately careful attention the stock of tulips will increase, so that, after the purchase of the stock in the first instance, no further outlay is required excepting when the cultivator is anxious to add other varieties to his list. The collection here comprises examples of all the best kinds for outdoor work and when the flower garden is at its best, no arguments from me are wanted to convince those who see it that in the tulip the flower gardener has a most valuable aid. To describe the magnificence of the display which tulips, when properly arranged with respect to the heights and colors, are capable of producing is impossible, and I will not attempt it.

We have adopted a plan somewhat different to that pursued in many gardens, and instead of planting the bulbs thickly in beds by themselves, we first plant the beds with such things as white Arabis, yellow Alyssum, blue Forget-me-nots, &c., and then plant the bulbs between the other

things, at a distance of nine or ten inches apart. Each bed is filled with one color, or at the most, two colors; and beds filled with plants producing yellow flowers are filled with scarlet flowered tulips; with white flowering plants, rose and pink tulips; blue flowering plants, yellow tulips; pink-flowering plants, white tulips, and so on; and the effect produced is at once most effective and pleasing. The advantages of employing them with other classes of plants are many, and so obvious that they do not require any lengthened explanation. In the first place, the beds have a more cheerful aspect throughout the winter, when the surface is carpeted with green foliage; secondly, the foliage of the carpeting plants affords a very efficient protection from the cold winds just as the young leaves are peeping above the surface of the soil; and thirdly, the brilliancy of the flowers is brought out to better advantage by the groundwork of white, yellow, pink and crimson, in much the same manner as the appearance of precious stones is increased by their golden settings. The carpet serves a fourth purpose, for it not only keeps the beds gay until the time for filling them with the summer bedders, but it keeps the old flower stems out of sight, and the bulbs are able to complete their growth without being an eye-sore to any one.—*The Gardener's Magazine.*

**WINTER CARE OF PEARS.**—Make a point of regularly examining every week all the choice kinds of fruits that may be approaching ripeness or which are found not to be keeping well, so that everything may be used at the proper time, for the finest pears are worthless enough if allowed to become over-ripe before being used, and the same is the case with many varieties of Apples. Also look over the whole stock as often as time can be spared, removing any fruit that exhibits symptoms of decay, and put them aside for immediate use. Any of the choicer kinds of Pears that do not appear to ripen properly in the fruit-room, should be removed to a warm dry room for a few days. This will be found to greatly improve them. Keep the fruit as dry and cool as possible, and if the frost is excluded the fruit-room can hardly be too cool when the object is to preserve the fruit plump and sound for a long time.—*London Journal of Horticulture.*

# The Gardener's Monthly.

DEVOTED TO

*Horticulture, Arboriculture, Botany and Rural Affairs.*

EDITED BY THOMAS MEEHAN.

---

Old Series, Vol. XIII. OCTOBER, 1871. New Series, Vol. IV. No. 10.

---

## HINTS FOR OCTOBER.

### FLOWER GARDEN AND PLEASURE GROUND.

While other sections of the Union have been pretty well dried out, we of Pennsylvania and some of the adjoining States have been very well supplied with rain, and our garden and grounds never presented a fresher or more joyous appearance than they have done this season. Yet we have had our seasons when gardening was hard work. Everything dried where it was planted. But so nice and so cheerful have everything been the past season, that we should be quite willing to have a hot dry time two years in succession if we could only have every third year one like this. In the hot dry regions which we have visited this year, we have heard people say it is no use to have gardens—"nothing will do in our hot place." Let them look at our glorious gardens here this year, and those which we have had; and "seeing take up heart again." In one respect it is to our good that we have this occasional hot experience. There has been too much copying after European gardening. We should have a style of our own and plants to correspond,—and we need just such weather to teach us to do it. The proper plants to use in our gardens are those which are adapted to hot dry climates; and in preparing a stock of plants for next year let this be borne in mind. Among supposed hot-house plants which we have seen tried out this year with great success, are two very beautiful climbing plants. One *Stigmaphyllon ciliatum* has lemon yellow flowers about an inch across, very much resembling the pretty Crape Myrtle of the South. The other is a sort of Passion flower, *Tucsonia levis*. The blossoms are of a vermilion color. Both of these main-

tain a succession of flowers from June till frost.

Arrangements must now be made for protecting half hardy plants which we use to adorn our summer grounds. The *Pampas Grass* is particularly one of these,—no place of any pretensions being complete without them. Some take them up and keep in a pit or cellar; but it is best to leave them in the open ground. Dry leaves or shavings should be packed in well through the plant, and then a dry goods box thrown over all to *keep things dry*. The beautiful *Tritoma uvaria* is best served in the same way. The latter is said to be hardy without any protection at all, but it does very much better served in this way.

The *Caladium esculentum* is another plant which for its large shield-like leaves is now coming into general use for garden decoration. These roots can be kept like potatoes through the winter if the place where they are kept is not dry enough to make them shrivel, or too cold; but cold damp places easily rot them. *Gladiolus Tigridia* and Tuberose roots do in similar places,—that is a little warm and dry. In regard to the Tuberose, it is now believed that if they are dried off after digging in a rather warm instead of a cool place, they will flower the better for it. Some take up or protect Japan Lily roots, but they are quite hardy, and indeed are better for no protection of that kind. Japan Lilies have not generally been cultivated successfully. It is found that in very rich soil they become diseased; a poor soil suits them best. October is the best month to plant Japan Lilies. Tulips, Hyacinths and other hardy Dutch bulbs are also in season for planting. So pretty and so cheap, it is surprising they are not more cul-

tivated. We quite agree with the following paragraph which we find in Mr. Vick's bulb catalogue:

"The Hardy or Holland Bulbs, as they are often called, because mostly imported from Holland, where they are grown extensively and thrive better than in any other country, are almost the only ornament of the garden in very early spring. Commencing with the little Snow-drop, in this section in March or early April, followed by the Crocus, Hyacinth and Tulip, they make a most interesting succession during the months of April and May, when but for them the garden would be bare enough. In addition to this they are unrivalled for culture in the house during the winter months. As nearly all can be grown in so many ways—in pots, or baskets of sand and moss, or in vessels of water—they are an almost endless source of interest and amusement in every stage of growth. With a little moss from the woods or swamps, a few quarts of sand, some pots, or a shallow box or two and a few dozen Crocuses, Early Tulips, Hyacinths and Narcissus, any one is prepared for a pleasant little winter garden. Of course, a few Hyacinth Glasses are desirable, but not essential. Very pretty boxes can be made with a little taste and patience, and some sticks and bark from the woods."

In addition to the kinds above named, the *Anemone* and *Ranunculus* are beautiful spring flowers for all who have rotten cow manure to fertilize the ground with,—and will give the beds a little protection from the severest weather. We are also very partial to the old *Crown Imperial*, of which there are now several varieties of red and yellow.

Many kinds of hardy annuals flower much better next spring, when sown at this season of the year. A warm, rich border should be chosen, and the seed put in at once. Early in spring they must be transplanted to the desired position in the flower border.

Few things are more valued in winter than a bunch of Sweet Violets. A few may now be potted, and they will flower in the window towards spring; or a small bed of them may be made in a frame, which should be protected by a mat from severe frost. To have Pansies flower early and profusely in spring, they may be planted out in a frame, as recommended for the Violet.

Herbaceous hardy border flowers are often propagated in the fall by dividing the roots; but,

unless it is convenient to protect the newly-made plants through the winter, it is better to defer this till spring, as the frost draws out of the ground and destroys many. Where it is now resorted to, a thick mulching of leaves or litter should be placed over the young stock when transplanted.

Chrysanthemums now in flower should have their names and colors rectified, against the time when in spring they may have to be replanted, when they can be re-arranged with accuracy and satisfaction, according to the owner's taste.

Amongst the pretty effects which we have seen this year, have been several attempts at forming winter gardens of evergreens. It was suggested in England a few years ago, that the massing system of growing flowers in summer was objectionable in this, that it left the beds naked through the winter. To remedy this, they had a reserve garden of evergreens from which the plants were taken every year after the frost had killed the flowers, and set in the places where the flowers were. This makes the flower garden look green at least during the summer season. This reserve garden of evergreens is usually put into an out of the way place, and does not look very inviting in the summer time. In the case we have reference to, the reserve garden had the evergreens set rather wide apart, and the spaces between filled with *Coleus*, *Achyranthus*, and other colored and variegated leaves. The effect was very pretty indeed.

#### FRUIT GARDEN.

In this department of the *Gardener's Monthly*, we never care to be controversial; but to give simply practical facts which cannot be disputed, or to make suggestions which have been so well the result of practical observation that they cannot be gainsayed if ever they are put to the test. But we notice occasionally that even intelligent men profess to believe that in this department of the *Monthly* we recommend growing fruit trees by neglecting them in grass.

Recently a gentleman well known for his successful establishment of the town of Vineland, took occasion to warn the people against our "theory" of "growing trees in grass,"—and as we have recently seen, Mr Charles Downing thought it worth while to give a side hit at those who advocate "neglecting trees in grass." No careful reader of our magazine could ever imag-



ine us to teach such neglect. We have before stated how we should "neglect" an orchard; but we will give it again to avoid mistake.

We feel that the advice constantly given to subsoil and underdrain, and manure to the extent of hundreds of dollars per acre is too costly to follow, and of little use after it is taken. If we were going to *prepare* a piece of ground for an orchard, we should manure it heavily and put in a crop of Potatoes; then in October manure again lightly and put in Rye. On this, in April, we should sow Red Clover. The Rye off we should then consider it ready to plant trees. For Apples, Pears, Plums or Cherries, we should mark out the rows ten feet apart, and for the trees ten feet from each other. This will be twice as thick as they will be required when full grown, but they grow much better when thick together; and they will bear more than enough fruit to pay for the room they occupy, before the time comes to cut every other one away. We say the rows ten feet apart, but every fourth row should be twelve feet to afford room to get between the blocks with a cart.

Plant as early as in October as possible, but it can be continued until the approach of frost. To plant, a hole can be dug in the stubble just large enough to hold the roots without cramping them. We should tread in the soil and trim in the head very severely. The next spring we should just break the crust formed by the winter rains about the tree, and then leave everything to grow as it might. The clover will be ready to cut in June or July. The twelve feet rows may be done by machine, the rest by hand. Hay enough will be made to pay for all the labor in one year and a little more. After the hay has been hauled off, bring back some rich earth of any kind, and spread about a quarter or half an inch thick over the surface of the ground disturbed in making the hole. This will keep the grass from growing very strong just over the roots. Keep on this way annually, every two or three years giving the whole surface of the orchard a top dressing for the sake of the grass, and it will be found to be the most profitable way of making the orchard ground pay for itself, until the fruit crops come in, that one can adopt. The trees also will be models of health and vigor, and when they commence to bear will do so regularly and abundantly. This is an epitome of what the *Gardener's Monthly* has taught, opposed as it has been by the excellent men of the old school of culture. No one who follows it will ever abandon it for

any other. It is costless comparatively, from the first to the last; and pays its way at every step.

The dwarfed fruit trees we would plant on the same system, but six instead of ten feet apart. Few soils are *too wet* for fruit trees. Only in wet soils plant on the surface, and throw up the earth over them from between so as to make a ditch or furrow to carry away the surface water. On the plan of annual surface dressings which we have outlined, the feeding roots will thus always keep above the level of standing water; and when they can do this, it will not hurt the trees though the *tap roots* are immersed in water for half the year.

### GREENHOUSE.

Bulbs for flowering in pots should be planted at once. Four or five inch pots are suitable. One Hyacinth and about three Tulips are sufficient for each. After potting, plunge the pots over their rims in sand under the greenhouse stage, letting them remain there until the pots have become well filled with roots, before bringing them on to the shelves to force.

The taste for cut flowers is considerably increasing, and one of the greatest demands on a greenhouse in winter, is from the best hall of the head of the household for room and table decorations. Beautiful specimen plants are not so highly valued as those which will afford plenty of bloom for cutting. The various kinds of Zonale Geraniums are very good for this purpose. The following also comprises very useful plants for this purpose: Bouvardia Lecantha, Calla Ethiopica, Cestrum aurantiacum, Habrothamnus elegans, Chorozema varium, Chinese Primroses, especially the double white, Daphne indica, Poinsetta pulcherrima, Euphorbia splendens, Heliotrope, Mignonette, Sweet Alyssum, Catalonian Jasmine, Yellow Jasmine, Mahernia odorata, Stevia serrata, Violets, Roses, Cinerarias and Brompton stocks. Tuberoses that flower late may be carefully taken up and potted, and will last till over Christmas; and many things may be taken out of the ground and slightly forced. The common white Lily is good for this purpose, also Deutzias, Philadelphuses, and Tamarix. The common green Euonymus japonicus is also worth potting, to make a lively green for mixing with other things.

Many kinds of annuals also come well into play; amongst other things, Phlox Drummondii,

Sweet Alyssum, *Collinsia bicolor*, *Schizanthus*, *Mignonette* and *Nemophila* are essential.

In taking up things from the ground for potting, care should be taken to have the pots well drained, with pieces of potsherd over the hole. The more rapidly water passes through the soil the better plants will grow. Pots could be made without holes, and the water would all go through the porous sides in time; but that is too slow a way, so we make a hole to admit of its more rapid escape, and we place the broken pots over the hole to make a vacuum, which assists the objects of the hole. In very small pots, or with plants which have strong enough roots to rapidly absorb all the moisture they get, and speedily ask for more, "croeking" is not necessary.

To watch for the first appearance of insects of all kinds, is one of the chief points of immediate interest in plant culture. If they once become numerous, it is often better to throw away a plant entirely than to doctor it after the old methods.

For winter flowering, it is a good idea to keep an eye to those things which are near their natural season of blooming, instead of the more hazardous one of forcing things on that ought not naturally to bloom for months afterwards. We have the natural system pretty well recognized as the correct principle in landscape gardening, and it might as well be introduced into this department also. Roses, of course, cannot be dispensed with; but even here the free blooming Tea and China Roses are infinitely preferable to the Mosses and Perpetuals often attempted. Roses intended for blooming, may be pruned in now about one-third of their strong shoots, and have their weaker ones cut out. As soon as the buds show an inclination to burst, the plants may be repotted in a rich loamy soil, in well drained pots. Oxalises make beautiful objects in the early spring, if potted now. A rich sandy soil suits them well. Three or four bulbs are enough for one pot. They do not do well too thick together. *O. Bowiei*, *O. flava*, and *O. versicolor*, are well known and popular species.

All succulents may be kept in the driest part of the house, and get little water through the winter. The flat leaved or *Epiphyllum* section is an exception. *E. truncatum* blooms through the latter part of the winter, and so must be kept growing.

## VEGETABLE GARDEN.

Celery as it grows will require earthing up, and Endive successively blanched; but the main business of the month will be preparations for housing the root crops for the winter. Beets are generally the first thing attended to, they being the most easily injured by frost; Carrots, Salsafy and Parsnips following. The latter are never really good until they have been well frozen; and many leave them entirely in the ground, taking them up as wanted for use. We prefer taking them all up and packing them in sand or half dried loam, in a shed or cellar, which can be kept just above freezing point; yet the cooler the better. If suffered to be in heaps they heat and soon rot. In the same situation Endive and Cape Brocoli may be preserved to the end of the year—they are taken up with a small quantity of earth adhering to them, and placed side-by-side together. Tomatoes, if dug up also, and suspended, roots upward, in such a situation, will keep good a long time; but this must be done before the least frost has touched them. It is a wise plan to sow a little more Early York Cabbage early in the month, as in fine mild winters the September sowing grows too forward when protected. A very slight protection is better for them than any elaborate affair, the sun principally injuring them. The same remarks apply to Lettuce intended to be kept over winter for spring use, though the sun is less destructive to them than to the cabbage.

Forcing vegetables, wherever the least command of heat can be had, is the most interesting and useful part of gardening. It is not by any means what it is often considered, an operation by which you pay a dollar for a mouthful. The Asparagus, Sea Kale, Lettuce, Radish and Cauliflower can be had for months earlier than in the open ground, wherever a regular temperature of 55° can be obtained, with, of course, the proper amount of air, moisture, &c. Asparagus can be had under a greenhouse stage, though of course the tops will not be so green, nor will it be much else but indifferent under such circumstances, as it would be in the full light.

Radishes require an abundance of air, and Lettuce light. Cauliflowers, if kept for some months with all the light and air possible, at a temperature of 50 or 55°, may have it gradually raised to 60 or 65°, and even 70°, and thus come

into use in February, when there is no vegetable more desirable.

Cucumbers, Tomatoes and Beans require a temperature of at least 65° degrees to begin with. If a temperature of 70 can be maintained in the coldest weather, a few of these might be sown

by the end of the month, which will produce some very acceptable dishes about New Year's day. Rhubarb, if carefully taken up at the fall of the leaf and potted, and put into boxes, will also come forward well if put under the stage in a house of the last temperature.

## COMMUNICATIONS.

### CALIFORNIA CONIFERÆ.

BY PROF. BOLANDER.

Commencing in the southern part of the State, we meet in her littoral belt, a little north of San Diego, a small species of pine, known to Botanists as *Pinus Torreyana*. I have thus far, not been able to learn its vernacular name.

The trees are small and few in number; they resemble most the so-called Digger Pine (*P. Sabiniana*), of our interior valleys. The leaves are in fives and pretty long.

The seeds are about as large as those of *P. Coulterii*. The locality mentioned is the only one known. It has not been tested long enough in our gardens to know what may be expected of it as an ornamental tree. In a practical point of view, it is unimportant.

Going northwards and keeping close to the sea coast, we find at San Simeon Bay, at Monterey and at a place a little south of Pescadero the so-called Monterey pine (*P. insignis*). The latter named place is its most northern limit. It seems to occur only on the immediate coast, on bituminous slate. Monterey is the oldest sea-port and the oldest point where Botanists began their labors in California. Already, towards the close of last century, it was visited by Menzies, an English Botanist. Our species in question, being variable in the form of its cones, and the form of cones being one of the chief characters relied upon in a botanical description, gave rise to quite a number of synonyms.

In Capt. Beechey's work, we find it figured under the name *P. Sinclarii*. Later it is again described by Loiseleur and called *P. Californica*. Don described it even twice, calling it one time *P. radiata* and another time *P. tuberculata*. The name *P. insignis* given to our species by Douglas, who visited Monterey in 1830 or 1832,

is the one now generally used. The name cannot be considered as settled; for according to the laws of nomenclature adopted by Botanists, it must retain its first name: *P. Sinclarii*.

This species attains a height of eighty to one hundred and twenty-five feet, and a thickness of two to four feet. In old age, its shape is very irregular and anything but beautiful. Its cones, three to five in a whorl, are persistent for many years. The leaves are in threes. Its timber is of little value, when better can be had. In dry protected places it is pretty durable; but exposed to the vicissitudes of climate, it perishes soon. The tree, when young, is undoubtedly beautiful. It is extensively found in our gardens and is known to every one as the Monterey pine.

Mixed with the species just treated of, we find another two-leaved one, *P. muricata*. The vernacular name in the southern portion of the State, is Bishop pine; in the northern, pitch pine. It occurs near San Luis Obispo at an altitude of three thousand feet; near the Mission La Purissima, where it forms a small grove; near Monterey, as just mentioned, sparingly; near Tomales Bay, scattered over hills; facing the ocean; near Point Arenas, also at the Albion River, extending northward to the Ten Mile River, (Mendocino county). Its cones are in whorls of two to four, persistent for many years. Some trees two and one half feet in diameter, had cones on the lower branches, partially overgrown by the bark. In some trees, we find a series of cones of twenty-five or thirty years. This species has not yet found its way into our gardens. When young, it is beautiful and apparently of a quick growth. The old tree is irregular in outline, mostly weather beaten and unsightly. It attains a height of fifty to eighty feet. Its wood is fit for fuel only.

At the Allion River *P. muricata* is mixed with another two-leaved species of pine, *P. contorta*—Dougl. (*P. Bolanderi*, Pall) It attains a height of thirty to fifty feet. On the upper drier portions of the so-called plains of that region, it bears cones when it is about five feet high, and one or two inches thick. The cones, several in a whorl, are also persistent for many years. Its small size and slender, upright branches, its short and densely set bright green leaves, render it desirable for ornamental purposes. It evidently requires a sandy soil, whether wet or dry; it grows in both as its natural haunts. In the vicinity of Fort Bragg, this species forms a perfect barrier and shelter against wind and drifting sand. Nature here hints at a remedy for us. This species used with the Monterey pine and cypress, would protect our city from drifting sand and fix the sand and soil. The people in that section of country have no vernacular name for it. In any other point the tree is unimportant. It extends along the coast northward up to Alaska. On the Sierras it occurs between three thousand to eleven thousand feet, descending, however, gradually to the north. This gradual descendance of all of our trees on the Sierras towards the north, is readily explained, yes, it is self evident. On the Sierras, opposite Visalia, our Big trees set in at eight thousand feet altitude; the Mariposa Big tree is found to be six thousand five hundred, and the Calaveras four thousand seven hundred feet above the level of the ocean. On the Sierras, *P. contorta* or twisted pine grows on the banks of streams, on wet and moist flats and in the higher portions of the mountains on moraines. Here it attains a height of one hundred and fifty to two hundred feet, and a thickness of three to four feet. Its outline is strictly cylindrical. Its wood is, owing to the frequent storms on the mountains, twisted and therefore hard to split. It is principally used for building log houses and railway ties. The vernacular name applied is Tamarack. The application undoubtedly arose from the resemblance in form and habitat this species presents with our eastern Larch (*Larix Americana*, Tamarack, *Huckmatack*), growing chiefly, if not exclusively, in swamps. The identity of the coast and mountain form is not altogether safely established.

Receding from the coast towards the east, we meet on dry hillsides, a small tree, generally known as *P. tuberculata*. It attains a height of twenty to forty feet, and a thickness of ten to

twenty inches. Its outline is conical. The leaves are in threes, and the cones persistent. In gardens it does well, and as an ornamental tree preferable to the Monterey Pine. I have not been able to learn its vernacular name. Being small and unsightly in its natural haunts, farmers never made any use of it, and therefore give it no vernacular name. It occurs on the coast mountains on the road to Santa Cruz, on the Oakland hills, on the mountains around Ukiah, on the Red Mountain, Humboldt county; also near Forest Hill, at Cape Horn (C. P. R. R.), and further up near Alta in the dry slopes of the canon of the American river. In most cases this small tree forms a small grove by itself.

After the trees have attained a height of twenty to forty feet, they die and decay.

Continuing our march eastward, we next meet, although sparingly at first, our well known Yellow Pine (*P. ponderosa*). This species attains a height of one hundred and fifty to two hundred and fifty feet. Its form is cylindrical in outline. The branches are short and generally deflexed. The leaves are in threes and cones deciduous, falling every winter to the ground, after they have opened (about the first of September,) their scales to allow the seeds to be spread by the winds. In gardens it cannot be called an object of great beauty. But on the higher mountains, where it develops its full colossal growth, it is certainly a grand object to behold, and I can well see why Douglas called it *ponderosa*: the mighty. Generally speaking, its timber is rather inferior, being too coarsely grained, and therefore subject to early decay. It must be mentioned, however, that there is considerable difference in the quality of the wood in different localities; yes, even in trees standing side by side. The timber from Truckee, so called Truckee Pine, belongs entirely to this species. The species in question, is one of most widely distributed trees of the western coast of North America. It grows on all higher and drier points of the coast ranges, and it descends even into their dry gravelly valleys, as is the case a little north of Ukiah, Mendocino county. It occurs on the Sierras from one thousand five hundred to nine thousand feet in great abundance. In fact it is the principal component of that mighty belt of timber, extending from south to north, along the western slope of the Sierras, between two thousand to seven thousand feet, a belt of timber whose equal cannot anywhere else

be found. It extends from the Colorado north throughout the Rocky Mountains, and occurs also in the higher mountain ranges of the Great Basin. Its northern limit is unknown. This immense diffusion over so large a territory, exhibiting so many different expositions and climatic differences, must naturally cause a great variation in form and size of the tree and in the quality of its timber. Its very botanical history proves this assertion; for there are few trees that have more synonyms than the one in question. Besides the name above given, there are the following synonyms: *P. Engelmanni*, *P. brachyptera*, *P. Benthamii*, *P. deflexa*, and *P. Jeffreyi*. The cones of trees in a dense forest are usually small, while those of isolated trees, standing in alpine meadows or on bare rocky slopes of mountains, or on wide sandy plains (Mono Lake) are from four to six times larger. This larger size of the cone is perhaps due to the intense reaction of the atmosphere, caused by bare rocks, wet meadows and dry sand. Considering the quick radiation of heat in such localities towards evening and shortly after sunset, which cools the air and causes a heavy dew-fall, we may be able to understand this phenomenon.

Ascending the highest points of the Coast Ranges, we meet the well known Sugar Pine, *P. Lambertiana*. But the Sugar Pine of the Coast Ranges is not that colossal structure of the higher or rather middle Sierras. Its beauty, size and length of cones are inferior. This tree yields an excellent timber, and attains a height of one hundred and fifty to two hundred feet, the outline is cylindrical, the branches are short, dense and much divided into spray. A characteristic exception, make the topmost branches, which spread in a loose irregular manner, almost horizontally. These are the cone bearing branches, which attract the attention of everybody by their clusters of pendulent cones, fifteen to eighteen inches long. The cones open about September to emit their seeds, and fall then themselves during winter to the ground. This noble tree has its leaves in fives; they are comparatively short, and of a glaucous green color. It ranges throughout the entire length of the Sierras, north to the Columbia river, between four thousand to ten thousand feet. I have not yet observed it in any of our gardens. The resinous matter exuding from burnt spots of the trunk, hardens into a whitish mass, sweet as sugar.

Descending into the more easterly valleys of

the Coast ranges, we meet a very peculiar pine, the Digger Pine, (*P. Sabinana*.) This species attains the height of forty to sixty feet, and a thickness of two to three feet. Its outline is irregular, the trunk is generally low. Its branches are characterized by a few main leaders, and by the paucity of their spray. The foliage is light and quite glaucous green. The leaves are in threes, and the cones persistent, although not to the extent of some other species. The seed is the largest of all our pines. The testa of its seed is very hard and bony. This species occurs in the driest portions of valleys and hillsides, even up to four thousand feet of the Sierras. It forms very seldom small groves. On account of its irregular form, it is not a desirable tree for gardens. Its wood is useless, except for fuel.

In similar localities, we find growing with the Digger pine, although less frequently, another pine, *P. Coulterii*. This species attains the height of thirty to fifty feet, and a thickness of two to three feet. It has a broad oval outline. The branches and branchlets are thick and clumsy and few in number. The leaves are very long, bright green, and in threes; the cone is the largest produced by our pines. It occurs at pass Tejon, on the Santa Lucia mountains and at Mount Diablo. In our garden it does well.

[We are indebted for this valuable essay to the *California Horticulturist*, a new and ably edited magazine.—ED.]

---

#### ADDRESS.

BY MARSHALL P. WILDER.

Delivered at the Thirteenth Session of the American Pomological Society, held in Richmond, Va., September 6th, 7th and 8th, 1871.

*Gentlemen and Friends of the Am. Pom. Society.*

Twenty-three years have nearly elapsed since the organization of this Society, in the City of New York. Held as our meetings have been, in different and widely distant parts of our country, I deem it proper very briefly to allude to its history, objects and progress. Especially is this desirable as a means of information to such southern portions of our Union as may not have been conversant with the proceedings of the Society. Its object is to advance that most interesting and delightful pursuit, the cultivation of fruits; to promote and perpetuate a cordial spirit of intercourse between pomologists; to compare fruits, and opinions concerning them; to settle doubtful points in pomology, and to

establish a standard for every section of this great Western Continent. How well this has been done, the Society need no better testimonial than is furnished by its published transactions, the wide-spread influence it has exerted, not only in our own, but other portions of the world, and especially by this grand assemblage of American fruits and American men. Many of the noble men who aided in the establishment of this Society, have ceased from their labors,—Downing, Prince, Saul, Hodge, Bergen, Underhill, of New York; Brinckle, of Pennsylvania; Walker, French, Crapo and Lovett, of Massachusetts; Monson, of Connecticut; Ernst, of Ohio; Hancock and Reid, of New Jersey; Kennicott, of Illinois; Eaton, of Rhode Island; White, of Georgia; Pierce, of the District of Columbia. These, and other associates of fair fame, have gone to their reward; but we rejoice that some still live who, from the earlier years of our history, have distinguished themselves as the untiring friends of our institution; who, by their efficient services and wise counsels, have contributed to its prosperity, some of whom are here to-day to rejoice with us in the progress of our science and the perpetuity of our institution.

Nor would we forget the eminent services and devotion of others of later days, to whom we are under equal obligations for the extension and influence of our Society, whose efforts have brought together the cultivators of fruits from the most distant portions of our country, thus making our institution what it was designed by its founders to be,—a truly national association, where the knowledge of one becomes the property of all; an association that should constitute a compendium of experience, and where, without regard to religious creed or sectional prejudice, a community of interest, enterprise and action might be established for the promotion of a great source of national wealth and human happiness.

In order to promote the convenience of all, to distribute its favors and increase its influence, the Society has wisely held its sessions in different and distant States of the Union. New York, Pennsylvania, Ohio, Massachusetts and Missouri have extended hospitalities to the Society, and some of these States have been repeatedly favored with the presence of its members, and the privilege of listening to their discussions. And now I congratulate you most sincerely upon the auspicious circumstances which enable us to

meet in this City, among our southern brethren, who have honored us with so cordial a welcome, and so large a representation of her men and her resources, here, in the capital of Virginia,—a State so renowned as the mother of presidents, and the home of some of the most distinguished patrons of American agriculture, among whom may be named Washington, Jefferson and others, who will ever be remembered as benefactors of their race.

I have so often addressed you on topics connected with the practical labors of our calling, that it can scarcely be anticipated that I should have anything new to offer for your consideration, especially in the presence of so many whose research and experience is fully equal to my own. I know, too, how precious our time is, and I should not attempt it were it not a duty enjoined by the Constitution of our Society. This duty will be performed in as brief a manner as its importance will permit. I would therefore suggest that it is desirable for us to gather up for future use the lessons which have been acquired by the experience of the past. We have been so busy in accumulating knowledge in the various branches of our culture, that we have had no time to look back and to systematize the inferences and deductions to be drawn from our operations. But we believe the time has now come when we should pause, and survey the field, and make a review of the lessons which science has taught; for science is but a statement of these lessons,—experience systematized and trained for progress. It is the grains of sand that roll up the mountain, the drops of water that make the ocean, and it is lesson upon lesson, fact upon fact, which must build up the science we wish to create. Nothing in the present age astonishes us more than the wonderful power of association,—the centralization of thought and action for the promotion of particular objects, thus collecting the experience of individuals, and diffusing this knowledge for the benefit of the world. How clearly is this seen in the operation of our own Society; how great the changes, and how rapid the progress since its formation! Then its list of members was 107; now its roll contains the names of 311 persons. Then its sphere of operations was limited by the boundaries of a few States; now its field extends from ocean to ocean, from the Provinces to the Gulf, and wherever the foot of civilization rests in our broad domain. Nor is it too much to say, that in this space of time more progress has

been made in the science of pomology than in the whole period since the settlement of our country. Never before was the interest so engrossing, or so widely extended. By publications, correspondence, and the remarkable facilities for interchange and intercourse, the enterprise of cultivators is kept constantly on the alert; and instead of useless discussions of other subjects, the pomologist finds all his time occupied in efforts for improvement.

How surprising the changes which have taken place during the existence of this Society! States and sections of the Union which were scarcely known by name, now contribute noble fruits to grace our exhibitions, and noble men to join us in efforts for the promotion of the public good; and by the wonderful achievements of science and the golden chain of commerce, a reciprocal exchange is made of our fruits, distances are almost annihilated, and where fruits were only to be seen in our markets at their peculiar season, they are now found throughout the entire circle of the year. And by the arts of preservation, the seasons of our fruits are further prolonged, until those of winter even linger in the lap of summer. Thus our choicest varieties are successively matured; thus distant markets are brought near together, so that the apple, the pear and the grape from the South and West meet in the Northern clime of New England in midsummer; and California, Kansas, Nebraska and Illinois compete at the same time with Virginia, the Carolinas and Georgia, in our Northern markets.

#### LESSONS OF EXPERIENCE.

##### 1. THE INFLUENCE OF WARM, DRY SEASONS.

Among the lessons which we have learned we may mention as settled and acknowledge principles, the following:

The observations of the last few years, under the influence of warm, dry seasons, would appear to have established the principle that such weather (without excessive drought), especially in the earlier part of the summer, is more favorable to the perfection and ripening of fruits, particularly grapes, than cold wet seasons. The fact is prominently shown in California, as we have witnessed by personal observation; and is especially to be seen in the cultivation of the grape there, and also in Europe, and in our Northern States, where, under the influence of such seasons, neither the vine nor its fruit is affected by disease of any kind. These conditions

we have noticed are also peculiarly advantageous for the formation of fruit-buds, and the storing up of the necessary perfected food for a future crop, and for the ripening of the wood, so necessary that it may endure the winter with safety.

##### 2. DRAINING OF FRUIT LANDS.

In conformity with the foregoing remarks, we see the importance of thorough *draining* of our fruit lands, which produces in soils not naturally possessing them, the conditions of warmth and dryness which we have named, thus rendering the condition of the earth, in respect to warmth and dryness, analogous to that of the air, of the importance of which we have before spoken. Besides these advantages is the thorough aeration of the soil, whereby it is enabled to absorb fertilizing matter from the atmosphere, rain, and snow, and the moisture evaporated from the springs below. Thus, paradoxical as it may seem, the same means which guard against excessive wet, also serve to supply moisture in excessive droughts. How aptly does the poet describe this condition:

"In grounds by art made dry, the watery bane  
Which mars the wholesome fruit is turned to use,<sup>1</sup>  
And drains, while drawing noxious vapors off,  
Serve also to diffuse a full supply."

##### 3. PREPARATION AND CULTIVATION OF THE SOIL.

It seems scarcely necessary in this presence to say that thorough preparation and enrichment of such soils as are not already rich, is essential. Ordinary farm culture will not produce the highest class of fruits; they must have garden culture, and with this they never fail. After this thorough preparation, the cleaner the culture the better, at least in our older States, where the soils have been depleted by cropping. But one of the lessons which experience has taught us most impressively is that, contrary to our former views, this after cultivation should be shallow so as not to injure the roots, but to preserve them near the surface.

##### 4. MANURES AND THEIR APPLICATION.

The subject of manures is a most important one, and every year becomes more so. The supply of manure in the older part of our country is unequal to the demand, and every year increases the disparity. What would be our feelings if the supply of wheat, on which we depend for our daily bread, were inadequate to the demand? Yet men are not more dependent for life upon their daily bread than are our fruit

crops upon the food which is supplied to them in the form of manure of one kind or another. To supply this want we shall be compelled to rely in great measure upon artificial fertilizers, and chemistry has not yet taught us, as it will doubtless in the future how to supply the wants of our fruit crops with certainty and abundance. But we cannot too often or too forcibly impress upon the minds of all cultivators the sacred duty of saving every particle of fertilizing material, and applying it in such manner as will produce the utmost effect. And on this last point the lesson which experience has taught us is, that manure applied to fruit-trees should be either in the form of a top-dressing or as near the surface as is consistent with the composition of the soil, and the preservation of its fertilizing elements.

#### 5. MULCHING.

While on this subject we will add as another of the lessons of experience, which may be said to be fixed, the advantage of mulching for dry seasons and soils, whereby the temperature and moisture of the soils are kept uniform, and the fertilizing elements in a soluble state, an essential condition for the production of perfect fruit.

#### 6. THINNING OF FRUIT.

This is another lesson which we have learned, and the necessity of which we have often endeavored to impress upon cultivators, and which every successive season teaches with stronger emphasis. It is absolutely necessary for all who send fruit to market to send large fruit, and the markets are constantly and progressively requiring large, and fine fruit. Even the Seekel pear which once commanded in Boston market the highest price, will not now, unless of extra size, sell for any more than, if as much, as common varieties of larger size. A medium-sized fruit, or even one of smaller size, may be more economical for use, but until some decided change in the preferences of the majority of purchasers shall take place, large fruit will sell better than small. To produce this, the fruit must not only have good cultivation but must be thinned, and we agree with Mr. Meehan, that "one-half the trees which bear fruit every year would be benefited by having one-half the fruit taken off as soon as it is well set, and that the overbearing of a tree will in a few years destroy it." We may lay it down as a certain rule, that excessive production is always at the expense of both quantity and quality, if not in the same season then in

succeeding ones, for when branch is contending with branch, leaf with leaf, and fruit with fruit, for its supply of light and food, it would indeed be an anomaly in nature if this should not result in permanent injury to the trees as well as to the annual crop.

#### 7. INSECTS AND DISEASES.

The subject of insects and diseases is daily attracting more attention, for their depredations are daily becoming a greater evil, and the importance of entomological investigations is every day more plainly seen. It is less than fifty years since Dr. Harris first published his work on "Insects Injurious to Vegetation," and great is the debt of gratitude which we owe to him and to the succeeding investigators who have given their lives to studying the habits of these little "creeping things which be upon the earth," that they may teach us how to destroy those which prey upon our trees, and to distinguish our friends from our foes. Every plant imported from abroad brings with it a new insect or disease, and the dissemination of new plants and varieties, without which there can be no progress in horticulture, inevitably disseminates their insect enemies. On this subject the words of Edmund Burke are appropriate: "The most vigilant superintendence, the most prompt activity, which has no such day as to-morrow in its calendar, are necessary to the farmer;" and we may add still more to the fruit grower, and tenfold more necessary in combating our insect enemies. The neglect of battling with these vile creatures is the great bane to successful cultivation; but as long as moral evil exists in the world, so long may we expect there will be evil in the natural world, and he who is not willing to contend against both is not worthy of the name either of cultivator or of Christian.

We belong to that class who have faith in the ultimate triumph of good over evil in the moral world, and our faith is not less strong that the insect plagues shall if not exterminated, at least be subdued, so that the labor of keeping them so far in check, that no material harm shall be caused by them will be comparatively easy. We have discovered means for preventing the ravages of the currant-worm, cecidius, canker-worm, caterpillar, melon-bug and aphid, and the mildew and other diseases of our vines. If we can do this, is it not reasonable to suppose that we can discover remedies for, or the means of preventing, all the diseases and depredations



that vegetation is liable to? Is it consistent with that Divine economy, so benevolent in all its ways and works, to believe that this fair creation has been spread out only to be destroyed; that seed-time should be promised and the harvest withheld; and from year to year our hopes deferred and our hearts made sick? Is it in harmony with that Divine Providence which created all things and pronounced them very good?

If any one say it is of no use to contend with these hordes of vile creatures, or the disappointments upon which all culture is incident, let him remember that it is the mission of life to struggle against and overcome them. Instead of fretting and groaning over these evils, let us battle with them and conquer them. Thus shall we gather the rich fruits of our industry, and, "Where some would find thorns but to torture the flesh, We'll pluck the ripe clusters our souls to refresh."

But some one replies, let nature do all this, let nature perform her perfect work; true, but nature brings us weeds, thistles and thorns, insects injurious to vegetation as well as those that are useful; and we were placed in this world, not merely to assist nature, but to meet with and overcome the obstacles which she sometimes places in our path,—to elevate her to the highest and noblest purposes of her creation.

Many of the difficulties and privations we endure, if met and conquered, will prove blessings in disguise. It is labor of mind as well as body, it is work, work, work, that makes men strong. Work is the great engine that moulds and moves the intellect, enterprise and destiny of the world—work is the greatest temporal boon bestowed on man—work is the heaven-appointed means of advancement to a higher state of perfection; and in no profession is this more apparent than in the calling of the pomologist. This idea is well expressed in the following lines, illustrative of the blessings of labor:

"The first man and the first of men,  
Were tillers of the soil;  
And that was mercy's mandate then  
Which destined man to toil."

If man can seize the lightning in his hand and make it work for him on earth, air or water; if he can descend into the secret laboratory of Nature, and learn the constituents of soils and manures, and their adaptation to each other; if he can learn how she prepares the appropriate food for all vegetable life, from the humblest plant clinging close to the bosom of earth, only

blooming to die, to the lofty Sequoia rearing its head to heaven and braving the tempests for thousands of years; if the physician can discover the agents which generate disease in the animal kingdom, and prescribe antidotes and remedies for each, may not the cultivator acquire a knowledge of the diseases which affect his trees and plants, and how to cure them?

Is there any element in nature which man cannot make subservient to his use? Is there any disease for which nature has not provided a remedy? Is there any enemy to vegetation that cannot be overcome? True, there are many things of which we know but little, and which require long and careful study, but there are others which are well established, and which one fact may demonstrate as well as a thousand.

#### S. SHELTER.

The necessity of shelter was not as soon perceived as some of the other lessons which I have named; yet, with perhaps the exception of a few favored spots, its importance is year by year becoming more generally appreciated, especially on our open prairies and in the northern and north-western portions of our country. The fact is established, that the removal of forests diminishes the quantity of rain, increases the evaporation of moisture, reduces the temperature, and subjects our fruits to greater vicissitudes, so that the peach and many of our finest pears can no longer be cultivated at the North except in gardens or sheltered places. The importance of shelter was well understood as long ago as the time of Quintinye, who, in his work on gardening, gives full directions for planting trees for shelter. This was in a country long settled and denuded of its forests; and though our ancestors, planting fruit-trees in a virgin soil, thickly covered with wood, failed to perceive its necessity, we, in our older States, who have come to much the same conditions as existed in the time of Quintinye, experience the same want.

There may be exceptions to this rule, as in the South, where the fruit season is warm and dry, producing similar conditions to those afforded by shelter under glass. We may find varieties, and probably shall, adapted to exposed situations; but at present the larger majority of our finer fruits will be benefited by the shelter of belts of forest trees. We are glad, therefore, to see the recognition of the advantages of forest trees on the part of the managers of our Pacific

railways, not only as affording shelter, but as collecting moisture from the atmosphere, and so rendering available vast regions previously uninhabitable from drought. This good work has already been commenced on the line of the Kansas Pacific Railroad.

#### 9. METEOROLOGY.

Besides the lessons which experience has already taught us, permit me to mention one which pomologists ought to learn, and which, from present indications, I have no doubt they will learn. The pomologist should have a better knowledge of the science of meteorology than we now possess. The action of light and heat; the influence of the winds, of frost, fog, water, and the electrical condition of the air and earth, have a most important bearing; and we believe that when our science shall have attained to its greatest perfection, there will be a discreet classification of fruits, assigning to each its proper soil, location and aspect. We must not expect to alter the laws of nature, but to conform to them. We do not expect to restore the lost Pleiad, nor do we expect to find any supernatural means whereby improvement and progress can be attained, without mental or physical exertion, but we should endeavor to understand some of the workings of that mysterious machine which generates and perpetuates all vegetable life. True, the "wind bloweth where it listeth," as of old, but it seems probable, if not certain, from the investigations made at Washington, that man can not only tell from whence it will come and where it will blow, but where the sun will shed its rays and the clouds diffuse their showers, and the time may come when the laws which govern the weather may be settled with nearly as much certainty as those which now govern the calculations of the astronomer.

What wonders has science wrought in modern times, but these are only the rudiments of that great plan which Providence has established for the happiness of mankind. "These are but parts of His ways" which we now see, glimmerings of that boundless exhibition of power, wisdom and goodness which shall culminate in the perfection of all created things.

#### 10. ORIGINATING NEW VARIETIES.

I commend to you again, as I have done in my former addresses, and shall continue to do while I live, the important and benevolent work of originating new varieties of fruit, both as a means of improvement, and as a substitute for

those which have experienced the decline incident to all things of human origin. Our country, and in fact the whole world, has been so thoroughly explored, that we can scarcely expect to discover any very important addition to accidental varieties. Our main source of improvement, therefore, is to be found in the production of new kinds from seed, and I again urge upon you the great importance of continuing your efforts in this most interesting and hopeful department of labor. The acquisitions already made give promise of still richer rewards to him who will work with Nature in compelling her to yield to his solicitations for still greater improvement. Much has already been done, but this branch of science is still in its infancy, and opens to the pomologist a broad field for enterprise. It may require time, and patience, and care to produce a superior variety, but we have the most cheering assurance of the time when every section of our country shall possess fruits adapted to its own locality. There is no better illustration of what can be accomplished, than what has been done, in the production of the various and excellent American fruits, which have been raised since the establishment of our Society. If each member should originate one good variety, adapted to a wide extent of territory, or even to his own section, he would become a public benefactor. Think of the number of persons in the United States who are now engaged in the growth of fruits. Should each one produce one good variety, a not impossible thing, we should have varieties enough to endure for centuries, adapted to every soil and location in our vast territory.

Let any one visit the nurseries established by Mr. Clapp, in Massachusetts, the originator of the Clapp's Favorite pear, and see the many seedling trees now just coming into bearing, and he cannot but be delighted, as we have been, with witnessing these trees in their youthful vigor, and studying the various forms into which the Bartlett, the Flemish Beauty, the Beurre d'Anjou, the Urbaniste, the Beurre Clairgeau, the Beurre Bose, and other standard varieties have been changed, and he cannot but admit that the daily opportunity for such study would be an ample recompense for all the trouble and expense of raising such trees. But besides this gratification, is the probability of raising a new variety, which, in one point or another, shall be superior to any before acquired, and which shall be a blessing to the nation. Does any one

object, that fruits adapted to cultivation through the country are few and far between? Let him raise a variety which shall be better adapted to his own locality than any before known. Let us have Favorites for Virginia and Georgia, and for all and every State in our nation. If I could feel that I had been the means of inducing our members, or other cultivators, to raise new fruits worthy to bear their names, I should feel that I had lived for a useful purpose.

The importance of producing new varieties from seed is no longer questioned. The fact, that the seed of good varieties will generally produce good offspring, is now well established. These are, however, the natural results which have been derived from fruits already improved; and we can offer no better proofs of the advantages of artificial impregnation than the multitude of improved varieties which have been produced in the vegetable kingdom by this process.

We have learned many of the laws which govern hybridization, and the more we become acquainted with this most interesting art, the more we work with Nature in these efforts for her improvement, the more we shall admire this most perfect and beautiful illustration of the great fundamental law, which has been established from the beginning of time, for the improvement of men, animals and plants. Well did Linnæus exclaim, when overwhelmed with the discovery of an unknown principle in this most interesting study, "I have seen God passing by;" and well may the contemplation of this law inspire us with the same reverence and delight, and,

"Like conductors, raise  
Our spirits upward on their flight sublime,  
Up to the dreaded Invisible, to pour  
Our grateful homage out in silent praise."

Let us go on then developing the wonderful resources of this art. Go on, persevere, and you will leave a rich inheritance to your heirs. Go on, and the time will come when every man shall sit under his vine and fruit-tree, when all our hillsides shall rejoice in the burden of the vintage, our valleys teem with the golden fruits of the orchard, and the passing breeze become vocal with songs of gratitude and praise for these benefactions to posterity.

The increasing interest in the cultivation of fruit at the South induces me to offer a few suggestions in regard to the best means of obtaining varieties suited to that region. Of apples and peaches a large number of superior varieties

have already been produced at the South perfectly adapted to that climate; but the supply of fine varieties of the pear is yet inadequate, especially of late-keeping varieties, as the latest kinds grown at the North cannot, when grown in the Gulf States, be preserved beyond autumn. To supply this deficiency, we would recommend the trial of such varieties as refuse to ripen at the North—Chaumontelle, the Colmar and its sub-varieties, Beurre Rance, Bergamot Fortunee—which appear to need a longer season than ours to arrive at maturity. These and seedlings from these offer, we think, the best prospect for a supply of late pears in the warmer parts of our country. We would also recommend a trial of the sorts used at the North for cooking, as some of these have proved fine dessert pears in the South. And probably some of the fine old varieties which have decayed at the East, and show signs of the same fate at the West, may, in more genial climates, have their existence so far prolonged as to be among the most desirable.

#### THE SOCIETY'S CATALOGUE.

Allow me again to commend to your consideration the value and importance of our Catalogue of Fruits. The completion of this work, by embodying the fruits of the Southern and Pacific States, is yet to be accomplished. This has been delayed from unavoidable circumstances, but we hope is now to be done, so that the basis of American Pomology can be established for the generations which are to succeed us. The work is indeed great, but it is a duty that devolves on us, as the representatives of that science which the Society has in charge. In proceeding with it, however, we find ourselves met by a difficulty not anticipated at the beginning of our work, arising from the unparalleled expansion of our country. In the few years since our catalogue was commenced, several new States and Territories have been organized, and if such expansion continues, as it undoubtedly will, it will be difficult to bring the catalogue, on its present plan, into any reasonable limits. On this point I hope to hear from the chairman of General Fruit Committee, to whom, more than to any one else, we are indebted for the progress already made, and I commend the subject to the thoughtful consideration of all the members of the Society, and especially invite the co-operation of every State in collecting and transmitting to him the information necessary to the completion of our work.

### THE INCREASING IMPORTANCE OF FRUIT CULTURE.

The importance and value of our calling in developing the resources of our country, in the occupation of unimproved lands, adorning our homesteads, enhancing the value of real estate, multiplying the blessing and comforts of life, and promoting a great source of national wealth, cannot be too highly appreciated. The more I reflect upon the progress we have made, the more am I confirmed in the belief that this branch of culture will ere long become second only to the growth of the bread and meat of our country. The enormous production of strawberries and other small fruits, the millions upon millions of baskets of peaches,—not to speak of the apples and pears and other fruits that are now annually produced,—give promise that the time is fast approaching when all classes of society may enjoy this health preserving condiment as a portion of their daily food. Nor can I refrain from referring once more to the benign influence which our employment has upon the moral and religious instincts of the heart, the refinement of taste and the welfare of society. Whatever pleasure may be derived from other pursuits, there is surely none that has afforded stronger evidence of a high and progressive state of civilization or a more ennobling influence, than the culture of fruits. "This," says General Dearbon, "must have been the step in the march of civilization, while the method of ameliorating their character and multiplying the varieties may be considered as taking precedence of all human efforts in the industrial arts."

From the day when God gave our father in Eden trees, "pleasant to the sight and good for food," down to Solomon, who said, "I made me gardens and orchards, and I planted in them trees of all kind of fruits," and through the successive generations of men, the cultivation of trees and plants has been the criterion of taste and refinement. No object of attachment is more naturally allied to the instincts of the soul, and truly did Emerson remark, "he who knows what sweets and virtues are in the ground, and how to come at these enchantments, is the rich and royal man." And what greater benefactions can you leave for posterity than these memorials which shall live and grow, which shall tell of your love of the most beautiful works of nature, kindred and home, when you are slumbering in the grave? Far better these for the perpetuation of your memory, and

the benefit of the advancing millions of coming time, than all the monumental shafts and pillars of polished marble that ever graced the hero's tomb.

### DECEASED MEMBERS.

Since my last report on the decease of members, three of the founders of this Society have been removed by death, "like fruits fully ripened in their season." I allude to Dr. Alfred S. Monson of New Haven, Connecticut. Dr. R. T. Underhill of Croton Point, New York, and Dr. Eben Wright of Dedham, Massachusetts, all three of whom were present and took part in the proceedings of the first meeting, twenty-three years ago.

Dr. Alfred S. Monson died, May 22, 1870, at New Haven, Connecticut, at the advanced age of seventy-four, universally respected and beloved. He was one of the signers of the circular calling the convention which resulted in the organization of our association; was the first vice-president from Connecticut; and on that occasion read a most able and instructive paper "on the deterioration of certain fruits, and of parasitic agents injurious to vegetation." This paper may be found in the published Transactions of the Society, and gives evidence of the careful investigation and research of its author. Dr. Monson possessed a highly appreciative mind, a refined taste and a great capacity for enjoyment. Hence his love for fruits and flowers, which was a ruling passion with him through life. He was the first president of the New Haven Horticultural Society, established in 1831,—one of the earliest in this country,—and was a frequent writer on subjects connected with horticulture and rural arts. His address before that society in 1843 is full of wisdom and beautiful illustrations. His memory will ever be revered and honored by all who knew him.

Dr. R. T. Underhill was also one of the founders of our Society, and his name is borne on the call for its first meeting. He commenced his pomological pursuits at Croton Point about forty-five years ago, the grape, of which he planted a large vineyard, being a specialty. His experiments commenced with foreign varieties, but these proving a failure he turned his attention to the cultivation of the Isabella and Catawba, then but little known, and so great was his success that for many years he and his brother, with whom he was associated, sent more of these varieties to the New York market than

were received from all other sources. He also commenced the manufacture of wine, and at the time of his death had about fifty acres of vineyard, and was also very successful in the cultivation of the plum, of which he gave an account at our last meeting. He was a leading member of the American Institute, and was one of the founders of the Agricultural and Horticultural Society of Westchester County, of which he was the first president. Dr. Underhill was a gentleman of the old school, courteous in deportment and refined in his tastes, and although his age prevented his frequent attendance of our meetings, his interest in our pursuits never declined. As a proof of his fidelity, he came to our last meeting in Philadelphia and although at the age of about eighty years, took part in our discussions as he had done in the beginning.

Dr. Eben Wright of Dedham, Massachusetts, another of the signers of the call for the first meeting of this Society, died at his home, where he had carried on his pomological researches during his life. He had long been interested in horticultural pursuits, being an early member of the Massachusetts Horticultural Society, and for a long course of years corresponding secretary and vice-president. For many years he was chairman of the Fruit Committee of this Society for Massachusetts in which capacity he made many interesting reports, which may be found among our published Transactions. He paid special attention to the apple, of which he had a large and choice collection of varieties; and through his critical observation he became remarkably well versed in the knowledge of this fruit, and introduced several fine varieties to notice. He was a modest and unassuming man, of the strictest integrity, and died as he had lived, universally respected and beloved.

Nor can I close this sad record without adding the name of M. S. Frierson, Columbia, Tenn., who died March 28, 1870. Mr. Frierson was the vice-president of this Society from Tennessee. He attended our last meeting, and his noble bearing and gentlemanly deportment will long be remembered by all who were present with him. He was by profession a lawyer, and at the time of his death was in practice as an old counsellor at Columbia. But what most concerns us is his high interest in pomological pursuits, which was strikingly evinced by the part which he took in the discussions of the Society; his remarks being always valuable, interesting and to the point. He was much interest-

ed in fruit culture, and had given particular attention to the hybridization of the nectarine and the pear, with the special view of producing late keeping varieties of the latter. His experiments were evidently based upon truly scientific knowledge, and at the time of his death, had already been the means of producing some valuable new fruits. In a letter written but a few months before his death he says, in speaking of his experiments, "they may turn out nothing, still the taste it give my girls" (who had aided him in conducting them) "for such amusement is worth more than the trouble. The seeds will be carefully planted, and we will wait and see." Noble sentiment! but the fruition of his hopes was transferred to another world, leaving us to wait and see the further results which they may produce here.

These associates have gone to their reward. Their seats in this Society are forever vacant, but their efforts for the advancement of our cause in the early history of our Society will be appreciated more and more as time moves on.

#### CONCLUSION.

With the deepest sense of gratitude do I rejoice in the presence of a few of the founders of this Society, whose lives have been prolonged to this day. Ere long all those who were present at its first meeting, and he who by your indulgence has occupied this chair so long, will vacate their seats. Others will fill the places which we now occupy, but our Society, and the cause it seeks to promote, will live on to bless the generations which shall succeed us.

Long may the members of this Society meet together as friends and mutual helpers, dispensing and receiving good, and may your efforts for promoting this beautiful of all arts, this health preserving and life prolonging industry, be crowned with continued success. May the Society go on conferring blessings on our country until every hearth-stone and fireside shall be gladdened with the golden fruits of summer and autumn, until thanksgiving and the perfume of the orchard shall ascend together like incense from the altar of every family in our broad land, and the whole world realize, as in the beginning, the blissful fruition of dwelling in the "Garden of the Lord." And when at last the chain of friendship which has bound so many of us together in labor and in love shall be broken; when the last link shall be sundered and the fruits of this world shall delight us no more;

when the culture, training and sorrows of earth shall culminate in the purity, perfection and bliss of heaven, may we all sit down together at that feast of immortal fruits,

"Where life fills the wine-cup and love makes it clear,  
Where Gilead's balm in its freshness shall flow  
O'er the wounds which the pruning-knife gave us  
below."

#### THE HANSON LETTUCE.

BY W. P. PODEBURY, GENEVA, N. Y.

The Hanson Lettuce, mentioned in the *Gardeners Monthly* is, if correctly named, the *Large India*, not *Curled India*, also known as the *Gray Lettuce*, in Tennessee. A first-class lettuce for summer, but not early; not equal to Malta, either in earliness, size or flavor. It will stand the summer heat perhaps equal to Grand Admiral, but no better in quality. I have tested this myself from seed supplied by Mr. Dreer, and know it to be correct what I state, and write you this so as market gardeners, &c., may not be deceived in snapping for such a treasure for an early Lettuce.

#### EUCHARI AMAZONICA.

BY MR. J. TAPLIN, MANAGER TO GEO. SUCH, S. AMBOY, N. J.

This is one of the most beautiful flowers grown, and also one of the easiest to manage; but yet I am so often told it is difficult to flower. This I deny, for I always found it one of the freest flowering plants grown. As a proof, I may mention our plants are now blooming the sixth time since the beginning of last November. I believe trouble with many growers is they do not give it liberal treatment enough, the plants are starved and rested too much, as a proof of which, I may mention a recent writer in the *English Gardener's Chronicle* states, "that by resting the *Euchari*, it may be induced to flower twice or more in the year. The only rest I give the plants, is keeping them a trifle drier a short time before I wish them to flower in the winter, but then not dry enough to lose any of the leaves.

The plant is a native of the hot, moist, rich vallies of South America, and growing near rivers, should teach us that it certainly is never rested in its natural condition. A plant collector from those parts, recently informed us that the plants were in flower at all seasons; it made a growth and then flowered. I can vouch for

the truth of this statement, having proved it in cultivation for a number of years. My system of cultivation is to give plenty of heat, abundance of water, both to root and over foliage, with occasional waterings with manure water. A good rich open soil with plenty of drainage, and after large strong plants are obtained, (which under this treatment will be from small ones, in two years,) disturb the roots as little as possible. For large specimens I prefer frames from 10 inches to a foot deep, and eighteen inches to two feet wide. The plants will stand a strong heat with a slight shade from bright sunshine. I have grown and flowered them in four inch pots, placed directly on the troughs of hot-water pipes, troughs of course kept filled with water, and frequently at a temperature of 120°. I may mention that although it will grow and flower in this climate in any glass structure in the summer, it requires a warm house in the winter, the temperature must never fall below 55°; from 60 to 70° will grow it to perfection.

#### HYACINTHS.

BY JAMES VICK, JR., ROCHESTER, N. Y.

The Hyacinth is one of the most beautiful and fragrant of the Bulbous Flowers, and particularly desirable for house culture. Even half a dozen grown in pots and flowering during the winter, will afford more pleasure to the "loved ones at home" than the same amount of money spent in any other way. With how much pleasurable anxiety they watch the shooting forth of the bright leaves, the rising of the stately column; while the opening of the bud makes a joyful thanksgiving of the most dreary winter's day. A very small pot will answer for the Hyacinth. Some prefer to plant three or four in a large pot, and this will make a very pretty ornament. Cover only the lower half of the bulbs with soil, press them down until they are nearly covered, then water until the soil is moistened thoroughly, and set the pots in a cool dark cellar. The roots will there form, with but little growth of top. Here they may remain for several weeks, and a pot or two can be taken into a warm, light room, for flowering, a week or ten days apart, and a succession of flowers obtained during most of the winter. When Hyacinths are planted in the garden, and well covered, the roots get a good start in the fall and winter; and it is very important in flowering them in the house that a growth of roots should be first

encouraged in the way recommended. When placed in glasses of water for flowering, the base of the bulb should not quite touch the water. Fill the glasses with well water, and as soon as the flower buds appear, sprinkle the plant frequently with rain water. Set them away for about two weeks in a cool, dark room, until roots are formed; then remove to a light, moderately warm room, and give plenty of light and air. Keep Hyacinths in the coldest room you have, anything above freezing will answer, and near the light. Flowers of the Hyacinth are often ruined by bringing them into a very hot, dry unventilated room. Our plan is to keep a stand containing our stock of Hyacinths in the parlor, which is kept most of the time but a few degrees above freezing. From this room they are taken as needed—one or two of each color—to the sitting room, or the dining room, for special occasions, but always returned to their cool quarters for the night. By this method they not only flower well, but keep in bloom a long time. Change the water occasionally, if it becomes discolored.

The choice named varieties grow best in glasses and pots, and single are more reliable than double sorts for house culture, while they are in every respect as desirable. Some of the double varieties, however, do well, and for the sake of variety it is a good plan to select a few.

Hyacinths should be planted in the garden in September, October and November. Make the soil deep, mellow, and tolerably rich, and see that the water has a chance to drain off. The beds should be narrow, so that all parts can be reached from the alleys or walks. Set the bulbs five or six inches apart and four deep. Before winter sets in, cover the beds with leaves or manure to help keep out the frost. This should be removed as soon as hard frosts are over—in this latitude, the middle of March. For beds of early flowers on the lawn, nothing excels the Hyacinth. A very pretty arrangement for a round

or oval bed, is one or more rows all around of white, then red and rose about an equal number, and the centre filled with blue. Where beds are small and so near together that they can all be seen at once, it is well to fill each one with a separate color.

Hyacinth flowers may be cut freely, without injury to the bulbs. Indeed, all flower stalks should be removed as soon as the flowers begin to fade. In about five or six weeks after flowering, and when the leaves are becoming yellow, the bulbs may be taken up, dried and packed away in paper bags or boxes, for planting again in the fall. If the beds are needed for other flowers, as is generally the case, the bulbs may be removed in about two weeks after the flowers have faded. In this case, after removing the flower stems, if this has not been done before, lay the bulbs on a dry bed in the garden, and cover them with a little earth, leaving the leaves exposed. Here they can remain until the leaves have ripened, when they are ready to be packed away for fall planting, or can remain where they are until needed.

Hyacinths will usually commence flowering in this latitude the latter part of March, and by choosing the *Early* and *Late* varieties, a good show of blossoms can be secured for at least a month or six weeks. The *Late* varieties are mostly *double* and are from two to three weeks later than the *Early* sorts. For the convenience of planters, I have designated the *Late* as well as the *Low* and *Tall* flowering kinds. Those not noted as *Late*, are *Early*. This will be found a great help in planting. The *Low* sorts throw up a stem five or six inches in height, and the trusses are usually globular and compact. The *Tall* sorts have a flower stem from six to ten inches or more in height, and the trusses are usually more loose. The colors are so classified that no description will be needed with each variety.

## EDITORIAL.

### TRAVELLING RECOLLECTIONS.

Day by day as the eternal wheel of editorial duty goes round, rolling over the same road, and gathering up the same dust, it is but human nature to wish to drive over fresh fields and pastures new. And we are blest,—for if there were

no heart yearnings, the numerous invitations of respected friends, flowing into us from a hundred streams, would find a welcome home in even the stony breast of an anchorite.

In this frame of mind we settled in our editorial chair one lazy day last mid-summer, mu-

sing as to what lovely parts of our great continent we should neglect to see, when a note came from our brother Editor of the *Horticulturist*, inviting our perplexed individuality to take a ride with him into our Western territories. It seemed just the thing to avoid offence to our friends. If we went here and not there, we were to catch nettles.—while if we visited this party and not that, it was pretty well understood that we were to be initiated into the not very inviting pickling business. And a trip to the country where we had no friends—where there would be no one to smother us with kindness, or kiss away our breath with those courtesies and attentions which sit so heavily on the lips of an editor,—the idea was charming. Here we were to go on a journey of over six thousand miles, through a district of country, of enormous extent, extending from latitude 42° down to 34°, and taking in Arkansas, Kansas, Colorado, Wyoming, Nebraska, Iowa, Missouri, Kentucky and Illinois; and we remembered how much we had read about, but had never seen,—the glorious sights and scenes which others saw—the birds and beasts, and bogs and flowers,—the rocks and hills, and silvery lakes and rushing streams,—we made up our minds to sacrifice gardening for one season, and look at nature in her uncultivated garb.

So one fine morning, after carefully locking up Loudon, and Repton, and Whately, and Downing, and the *History of Gardening amongst the Chaldeans*,—and striving to forget that the score of excellent living landscape gardeners of our country ever were born, “we,” that is this portion of the *Gardener's Monthly*, took “our” seat on a Philadelphia and New York train, bound for the Rocky Mountains or any where else that fate or Williams chose to carry us. In New York we found a company of some twenty, who, if not exactly all agricultural editors, as our friend of the *Agriculturist* says none of them were, were at least ladies and gentlemen whom it would profit some agricultural editors to associate with. We found on the train, the Junior Mr. Tucker of the *Country Gentleman*, with his well known correspondent “*Daisy Eyebright*,” S. W. Noyes, Editor of the *Massachusetts Ploughman*; R. P. Eaton, Editor of the *New England Farmer*; J. R. Dodge Editor of the *Reports of the Department of Agriculture*, Washington, D.C.; D. S. Hall, Junior Editor of *Western Rural*; besides the agricultural Editors of the leading New York daily papers. In addition, the

*Prarie Farmer*, *Germantown Telegraph*, *Wilmington Commercial*, *Chicago Tribune*, *Phrenological Journal*, *Smithsonian Institution*, and other papers were represented by their correspondents, amongst whom were the names well known to our readers of Josiah Hoopes, Dr. Warder, William Canby, M. L. Dunlap and B. K. Bliss.

It is not our purpose to speak of New Jersey, the great vegetable garden of New York, nor the New York and Erie Railroad, with its delightful scenery and superb traveling arrangements; nor of the Bee Line R. R. line from Cleveland to Louisville, which took us through as rich and beautiful a country as any part of the Union east the Mississippi can boast of,—we have so often before given our impressions of these parts of the world; but we purpose to start our notes from Louisville, trusting that from here out we may have some recollections of novel interest to our readers.

Louisville itself will always have a hold in the traveler's memory, through possessing in the Galt House one of the finest and best managed hotels in the world; while the City commends itself to the general public, by an immense amount of business enterprise, joined to very low prices for living expenses,—a state of things not usual in thriving American towns. The prices of fruits, vegetables and provisions in the public markets, astonished the Eastern visitors, and especially those from New York; while the evidences of prosperity in the improving streets, beautiful suburban residences, and well kept gardens, were highly gratifying to those of us who labor to bring about enthusiasm in all these things. There were few yards or small gardens without an abundance of roses,—while magnificent *Magnolia grandifloras*, with their broad dark evergreen leaves, made a grateful shade for many a parlor window. There appears to be as many varieties amongst these seedlings as amongst other kinds of trees. Some have very narrow leaves, and other broad ones,—while the under surfaces of some are dark and rusty, and others deep green. Again there are great differences in the time of flowering, some coming out quite late in the season. In Louisville, much attention is given to window and roof gardening. Some of the houses fronting the business streets, were a mass of blossoms from garret to basement, and must do much to enliven and make cheerful the dry walks of trade,—while to the visitor they furnish material for many pleasant recollections.



## PROFESSOR PORTER'S PEAR ORCHARD.

An innumerable number of paragraphs are going about the papers, that Professor Porter of the "Maryland Agricultural College" has pronounced "Meehan's theory of fruit culture a terrible failure, that Professor P. considers the trees 'gone,' and that he now intends to plough up and cultivate them as people did in the good old times." It is a surprising fact, that if people had tolerable success in the "good old times," people should ever want to try "Meehan's system" or any other system. Moreover, if the trees are "gone," it requires some courage to go to the spirit land or any system whatever to bring them back. We have not such faith in the powers of fruit culture here, as to bring "down" trees already "gone up."

However, we are willing to believe that there is here, as there always has been when our opinions have been referred to, a vast amount of exaggeration, by people who, like Mr. Downing, speak of "neglected" culture when referring to what we recommend,—still it is likely that some one has here been endeavoring to follow our recommendations, and has failed of success; and we think it will serve the cause of fruit culture if he will give us an account of his orchard,—when he planted, how he planted, when he put it down in grass, what grass he used, when he mowed the grass, when he applied the top dressing, how often they were top dressed, with what were they top dressed, what insects, if any, existed in the orchard, what diseases, how were the fruit thinned, how were the trees pruned,—or any little facts which may enable one to understand the exact treatment; and finally it would be very interesting to know what symptoms accompanied their final taking off.

We do not suppose that the most perfect system ever devised will make fruit culture one of the exact sciences, any more than we may expect people who try to observe the exact laws of health never to die before old age takes them; but yet such a failure as this ought to teach us some valuable lessons,—and we should be very glad for the sake of fruit culture to have the particulars.

## LOOKING AT THE ROOT OF THINGS.

In almost all meetings where Mr. Wm. Saunders attends, all who are present note how continually he strives to impress on his hearers the necessity of looking deeper into the principles of culture

than they evidently do. We often wish that cultivators would weigh well this excellent advice. For want of this valuable habit, an immense amount of useful information brought out at horticultural meetings, is rendered nearly worthless. Indeed this knowledge is often turned to baneful practices.

As an illustration of how this may be done, we may refer to a discussion on Hale's Early Peach, which took place at Richmond. Some one remarked, what is already well known, that this variety is much more subject to the rot than many other kinds. The fruit seldom remains on long enough to mature. It rots when half ripe. Many gentlemen remarked that it had rotted very badly with them, but after letting the orchards go down to grass, there was rot no more. The idea spread, and others stated that this treatment had been found excellent with other varieties than Hale's Early.

It was evident from the tone of all these discussions, that many would run away with the idea that grass was a sovereign remedy for the rot in the Peach. But the truth is, that in the cases referred to, grass was but the means to an end, and we may say but one means to an end,—and there will be plenty of cases where the same means, the same collective causes being absent, would not have the same result. Indeed, many cases, no doubt, could be cited wherein grass would not result in the same way; and we have now in our mind a case of a lot of Hale's Early near Chambersburg, Pa., where this grass treatment did not have any effect whatever on staying this much dreaded peach disease.

Perhaps we may understand better what this article tends to teach, by looking at a crop of corn under different circumstances. We have, in our mind a piece of land divided into two by a cart road. The quality is the same naturally, but two different kinds of manure were applied to each last spring. One grew amazingly, the other was not near as tall; but while the latter produced about sixty bushels of corn to the acre, the other yielded only forty. The smallest plants yielded the most grain. We note this continually in trees as well as in cereal crops; and we arrive at this general principle, that there is an antagonism between fruit and leaves, between grain and stalk, and that we cannot have the one without some loss to the other. And yet we have another principle equally true, that it is impossible to have healthy fruit without a due balance of healthy foliage. Here are two antag-

onistic principles working one against another; and he is the successful cultivator who knows how to keep these opposing principles each to its proper work.

Thus, as Mr. Saunders has once well put a case, it may be that from some peculiarity of the soil, there will be a greater tendency to produce leaves than flowers, even after a plant has arrived at a bearing age, than it should do. There are other cases where, even if they do produce flowers or fruit, there is more nutrition passes into the leaves and branches than is desirable to a perfect fruit, and this fruit is in consequence so weakened in its vitality as to be an easy prey to disease. And it is here that we see how grass may have an influence in remedying this state of things. The nutritive conditions are altered, and newer and better balance being accomplished, health results. But supposing that

this want of accordance did not exist? Allowing that the peach flower and the peach leaf were both governed by the best conditions of success, and that we had all the fruit we wished, and as good as we had a right to expect, it is more than likely that a crop of grass thrown in, by disturbing the balance, would be highly injurious, and no good cultivator would do this, unless he accompanied this treatment with something else which will maintain the proper balance of the principles we have referred to.

Thus, we would have our readers bear in mind, that the reason why anything is done, is far more important than how the thing is done,—and that the course of practice which would result in success under some circumstances, under others would be disastrous in its consequences.

---

## SCRAPS AND QUERIES.

THE GARDENER'S MONTHLY FOR 1872.—The publishers desire with the approaching close of the year, to remind the readers that they have a claim on them to extend the circulation of the magazine. It is now the *oldest horticultural magazine* in the United States, so far as being continuously under the same editorial control is concerned. The editor though at the head of one of the largest nursery businesses in the country, does not thrust it forward in the magazine. The immense advertising patronage of the *Gardener's Monthly* shows how well the editor, though a nurseryman, has the confidence of others in the same trade. At the same time the increasing experience which the school of a large nursery brings day by day, is given in the *Monthly* for the benefit of its readers.

In the publishers' own department they point with pride to the immense amount of reading matter they give for *two dollars*, greater they believe than is given by *any other magazine in the world*. They believe also that they have steadily increased the attractions of the magazine, without even promising to do so. No extraneous methods have ever been adopted to push the magazine on an unwilling public; but the whole has been left to quiet public appreciation. Without intending to reflect on any of

the other excellent horticultural journals, we may be pardoned for saying, that we have no unwilling readers, and that the cheerfulness with which every one sends us cash in advance for their annual subscriptions is the secret of the *Monthly's* great success.

The publishers further remark that the *colored plates* which they occasionally give is *no part of the subscription price*. These are the *premiums which we give for getting us new subscribers*. We are going on the mutual plan.

We hope that as nearly as possible, every one will remit us with their own, at least one new subscription before the close of the year.

---

NAMES OF PLANTS.—*Mrs. Sara C. T., Carbon Cliff, Rock Island Co., Ill.*—"If you will permit me again to appear as an enquirer, I shall be glad to know the names of the enclosed specimens.

I have read somewhere that sulphate of ammonia is a superior fertilizer for plants, if so, how should it be used, and in what proportions? I have used aqua ammonia, about a teaspoonful to every pail of water and thought it beneficial, but the torrid heat of the present summer has so thwarted the utmost cure, that one is left in doubt of the true effect of anything before un-

tried. Fuchsias have suffered severely, surviving with a stunted growth and shriveled flowers only through the mitigation of screens and frequent syringing. Now that cooler autumn days are near, any information how to recall them to a vigorous growth would be very acceptable.

What strawberry should be planted with the Colfax to make that variety productive?

It is a pleasure to acknowledge the debt I owe the *Gardener's Monthly* for the many happy and profitable hours spent among its pages and, I look forward to many more in the future."

[The broad leaved plant is *Begonia manicata*. The very small succulent one *Pilea muscosa*, the artillery plant. The gold veined leaf is the Japan variegated Honeysuckle.

The sulphate of ammonia is usually applied in about the same proportion as you used. Maure water, however, from any kind of stable manure, but particularly cow manure, is quite as good, and seldom is so risky as the one referred to, which, if given in over doses is highly injurious.

The Fuchsias are of course done for this year: but next spring give them a severe pruning, cut the half of them away, and after the young growth has made a half inch, repot into smaller pots than they grew in this year; and after a month or six weeks shift again into larger ones.

Do not plant the Colfax or any kind of strawberry that requires artificial fertilization. There are now quite as good hermaphrodites as any of the pistillate class. Every one of these should now be erased from all good strawberry lists. If however, you have good reason for not following this advice plant a few Albany Seedlings, Other hermaphrodites would do, but you are more likely to find this variety.]

A FRUIT LIST FOR MARYLAND—*S. R. C., Port Deposit*, says: "If not asking too much, will you please publish in October No. a list of fruit suitable for this section, Apples, Pears, Peaches, Cherries, &c., &c. Also small fruits. We are about eight (8) miles from Pennsylvania line"

[To give a fruit list is a "terrible temptation" one gets roundly abused by the friends of some hobby horse or another. However, an editor must risk these blows. Supposing you want fruit for market we should try the following Apples: Red Astrachan, Primate, Early Joe, Jonathan, Rawle's Janet, Smith's Cider, Maiden's Blush, Summer Hagloe, Porter, and probably a first rate southern apple, the Shockley, would do well up to your line. We should also try some of the

pretty looking apples, such as Chenango Strawberry, Carolina Red June, Ben Davis, Red Winter Pearmain and Winesap, though we do not know, from our own experience, that they have extensively borne fruit in Maryland.

*Pears*—Bloodgood, Bartlett, Tyson, Buffum, Beurre d'Anjou, Howell, Seekel, Sheldon, Lawrence and Duchess d'Angouleme. If not early ones enough, add Manning's Elizabeth.

*Peaches*—Crawford's Early and Crawford's Late, Early York, Oldmixon Free, Oldmixon Cling, Stump the World, Smock, Ward's Late.

*Cherries*.—Black Tartarian, Early Purple Guigue, Early Richmond, Yellow Spanish, May Duke.

*Grapes*.—If not in very favorable circumstances the Concord and Clinton will best take care of themselves; but if you can give a very dry soil, and with surface manure occasionally you may try Delaware, Eumelan, Iona, Martha, and Maxatauney.

VARIEGATED MAPLES.—*W. P., Cinnaminson, N. J.*, writes: "I have recently noticed a large Maple tree growing in the woods about thirty feet high, with leaves yellow or light color around the edges, and green in the center or middle part. Inclosed I send a few as a sample; thought perhaps they might be worth propagating, either by budding or seed."

[Many grand additions to our ornamental trees might be made by selecting the best of the many variations in our woods. As a general rule, the whole family of Maples, bud very readily on the common silver Maple; and thus we have at hand a cheap stock for any pretty variations in this class of plants.]

GRAPE LEAF INSECT.—An "Old Subscriber" sends leaves covered with little horn-like brown processes a quarter of an inch long. These enclose the larvæ of the grape midge, a small dipterous fly, of the genus *Cecidomyia*. These are the little gnats which are so troublesome in the autumn. There are many species, but the particular one which produced these we do not know.

TICKETS TO EXHIBITIONS.—We have a large number of complimentaries from friends—in two instances accompanied by railroad passes to at-

tend. We are sorry that we have been unable to accept; but hereby tender our best thanks for the kind remembrances.

NAME OF PLANT.—A correspondent of the *Gardener's Monthly* who has committed the not unusual offence of not signing his name to his letter, sends us the following, containing a branch and flower of *Sophora Japonica*, a beautiful tree, quite hardy the United States: "Inclosed I send you some flowers and leaves taken from a tree raised from seeds that I brought from Rome, Italy, ten years ago. I shall be pleased if you will diagnose it and send me the name at your leisure. If you wish any of the seeds, notify me, and I will send them to you this fall when ripe."

MONSTROSITY IN INDIAN CORN.—E. S. C. writes: "I send you a singular vegetable curiosity—a *lusus nature* which is certainly interesting. This little unfruitful ear of corn was found enclosed with an ordinary large ear of corn, occupying the centre of the cob, with the long silken threads wound around it as you see it now. At first, however, they were much longer and exceedingly soft and delicate.

[This is a very interesting case. The young ear which grew inside of the other cob, is about three inches long and about a quarter of an inch wide; and the silky pistils, several inches in length are wound around as on a spool. All are arranged to twine in one direction; and what gave it this uniform direction would be a very interesting bit of knowledge to a physiologist. It is not uncommon for one fruit to develop inside of another fruit. A pear, has been known to grow inside of another pear, but this arrangement of the pistils indicates a twisting of the axis, which we think has not before been recognized.

BUNAPARTIAS—CORRECTION FROM MR. HARDING.—"In the September number of the *Monthly*, under the caption of "Botany Bay, New South Wales," either you or I, the printer, or more likely still, his unbotanical "devil," "have erred and strayed" from facts, where it reads that "on reaching a group of *Ficus macrophylla* thick with an undergrowth of *Banksias*, *Driandrias* and *Bunapartias*," (a Bromeliaceous plant) I am made to mention, which is evidently an error, as I never saw it there, and have but once

met with it, *B. gracilis*, in its wild state in Mexico; although well acquainted with both it, and *B. juncea*, two odd looking plants, and well worth growing with collections of *Crassulacæ*, *Cactacæ*, *Liliacæ* and *Amaryllidacæ*, which embrace plants of peculiar structure, and really are in every sense natural curiosities. There are pleasures untasted in store for the florist, and virtuosos; and all whose tastes are cultivated and refined, who love the beauties of His creative power in the cultivation of such like plants which well deserve a *good* space in every greenhouse, where they would delight and reward with true pleasures the owners of such rare beauties. Why don't the nurserymen introduce them? There is money in the undertaking.

RAISING NEW FLOWERS—B. D., *Bardstown, Kentucky*, asks:—"Will you please tell me how the new varieties of flowers are produced? When I was a girl, there was but one kind of fish geranium, a brilliant red, and now I have eight kinds in my garden. This may seem a simple question to you, and perhaps to other readers of your interesting magazine; but circumstances made us drop the *Monthly* after the first year, and it is only this year that we have been able to resume it again. The kindness you show in answering such inquiries in the magazine, leads me to hope I may get some notice for my inquiry."

[We always answer these inquiries with pleasure. They enable us better to feel the public pulse than we can do any other way, and thus our great horticultural patients' wants are better understood.

About the new varieties:—There is in all plants a tendency to vary, within certain limits. In raising seedlings, those which show the most tendency to change are selected, and seed again saved from these, and in the course of a few generations they have wandered a long way from the original.

This is improvement by selection; but much is also done by cross-breeding. Two varieties being obtained, the pollen from one flower is carried to the pistil of the other flower, and the seed thus produced brings a race intermediate between the two. It is singular to note, however, that the tendency to variation operates also here together with the fertilizing influence; if there were more of this variation, the flowers from a cross-bred union would be all exactly

alike intermediate between the two; but instead of this, there will be no two exactly like.

Cross-breeding is, therefore, generally preferred by improvers, as they have two laws working together for change at the same time.

GERMANTOWN, TENNESSEE.—We again remind our friends that it is dangerous to abbreviate Pennsylvania to "Penn.," when addressing the Editor at Germantown. It is so much like *Tenn.* in manuscript, that continual delays occur. We have now a letter before us just received from Little Rock, Arkansas, dated May 29th. Pa. is best.

DISEASE IN PINE TREES.—*S. B. T., Baltimore, Md.*, writes: "On my country place, I have some white Pines about 20 years planted, some of which have the tips of the leaves brown. This usually commences about mid-summer, and the result is a very unsightly looking object. Have you seen any thing like this, and do you know any cure?"

[This is not uncommon with the white Pine, and arises from an attack of fungus at the root. You will find the soil full of a whitish fibre, which attacks the roots of the Pine tree. It is highly probable that this fungus penetrates the sap vessels, and that it goes up into the leaves for the purpose of there producing the spores which is to reproduce itself. At any rate, it has been found that if the soil about the tree is taken out

and new soil put in, the new soil and perhaps the admission of fresh air destroys this thready fungus, and afterwards the disease in the leaf disappears. This shows conclusively the connection between the fungus at the root and the dead parts in the leaves. Mr. Alfred Cope, near Philadelphia, has perfectly succeeded in renovating a bad specimen of white Pine in this way.]

NAME OF PLANT—*R. B. D., Rochester, N. Y.*—"Enclosed please find a piece of a plant which we wish you to give us the name of. It has been sold here as a native of Siberia, being a perfectly hardy creeping plant also adapted to grow on trellises. We are unacquainted with the plant ourselves, and would like some information about it, as we think it would be desirable to use in the making of wreaths, crosses and other floral designs. Your reply through the columns of your paper will oblige.

Can you tell us also if it is to be found in this country in a wild state?"

[This is *Lycopodium lucidulum*, a native of the United States, and largely used by the florists of New York and Philadelphia, for "stuffing" bouquets. It grows in dense shady woods, and no doubt would make a pretty plant for room culture, if a glass be used over it to keep moist air about it, and a short trellis to keep it from falling about. We have not, however, seen it cultivated. For florists' use, it is brought from the interior in barrels, and sold by those who deal in florists' articles.]

## NEW AND RARE FRUITS.

SEEDLING GOOSEBERRY FROM S.S. MERCERON—This was a branch that was 18 inches long, and had thirty gooseberries on, which weighed *half a pound*. Four to an ounce is pretty good for America, though not much in England, where one berry often comes near that weight. If it was certain that this was an American variety, it would be one of the most valuable fruits ever brought before the American public; for it is the fault of our popular kinds that they are too small. Unfortunately, we cannot tell just now whether it is or not, for there is nothing that will distinguish the two species when they are out of flower; for though the American species was named *Ribes rotundifolia* by Michaux,

from an idea that the leaf was rounder than the European *R. grosularia*, we could never see that it was. The flowers, however, appear distinct. In the English, the calyx sepals are reflexed, and the petals small, heart shaped inclining to wedge shaped; while the American has barely spreading calyx segments, and the petals are longish claws.

The general aspects of this one of Mr. Merce-ron's, inclines us to the belief that it is American; and if it proves so, as we have said, Mr M. has a valuable thing.

IMPROVEMENT IN SIBERIAN CRAB APPLES.—The superior hardiness of this species of apple

have rendered them marked objects for improvement with our northwestern Pomologists. Except for vinegar or for jelly, the old varieties have been of little value culinarily; although as ornaments of gardens one or two have been grown on most grounds. A marked improvement has, however, been made in their quality, and some are quite eatable. At the recent meeting at Richmond, some Minnesota seedlings were exhibited which contained amongst them as much variation from sour to sweet and in other degrees of difference as the genuine apple. Some of these were tolerably good to eat. We are reminded of this by having before us the Marengo Crab, from C. Andrews, and from Messrs. Herendeen & Jones, which is much superior in quality to the Transcendent, and this is a well known and popular kind. In size and flavor none of these crabs come up to the general apple of gardens; but the evidences are encouraging that they may one day do so, while the great hardiness will always be a point in their favor.

APPLE, COOPER'S EARLY WHITE.—This variety seems to be unknown in the East; but in the West it is one of the most profitable apples grown. The crop it bears is wonderful. It commences to bear three or four years after setting out, and the trees nearly break down under the load. It has somewhat the appearance of the old Hawthornden, which has never been very popular in this country. Its quality and uses are about the same.

NEW PEACHES.—*Lady Parham*.—Size, medium; shape, oblong, slightly one-sided; skin, white, seldom showing any red; flesh, white, with some red near the stone, juicy, vinous and highly flavored; freestone; flowers, small; glands, reniform; season of maturity, end of September and lasts until October 15th; tree, a vigorous and open grower, very prolific; quality, very good. It was originated by the late Thomas Afleck, Esq., during his residence in Louisiana. A very desirable late variety.

*Picquet's Late*.—Size, large to very large, often measuring twelve inches in circumference; form, round or somewhat flattened, and a little one-sided; skin, yellow, with a deep red cheek; flesh, yellow; buttery, rich, sweet and perfumed with a slight apricot flavor; freestone; quality, best; flowers, large; glands, reniform; season

of maturity, end of August, and continues some years until September 15th.

This variety originated with Antoine Picquet, Esq., of Belair, Ga., and was first disseminated in 1861. Its magnificent size, extra quality, and maturing at a season when peaches are scarce here, form a combination of qualities seldom found in a fruit. It has been extensively tried throughout the country and everywhere has sustained its good points. Tree, a rather compact grower.—*Rural Carolinian*.

THE BUFF APPLE.—This is a handsome and popular apple, grown extensively in North Carolina, Georgia, and other portions of the South. The fruit is of the largest size, roundish and sometimes somewhat ribbed and angular; skin, thick; color, yellow, thickly striped and shaded with dull red, with greenish and russet spots; stem, rather short, in a medium cavity; calyx, large, in an irregular basin; flesh, yellowish, tender, sub-acid; quality, good, under favorable conditions, but sometimes indifferent; season of maturity, October, but will keep till March. The size and beauty of the Buff makes it a favorite in our markets. The finest specimens we have seen come from North Carolina.—*Rural Carolinian*.

GRAPE, ELLWANGER & BARRY'S NO. 19.—We received a bunch of this last year, but the berries had all dropped from the stems before we saw them, and a good opinion of them could not be given. A bunch before us now gives promise of the highest excellence. Among apples and pears there are two classes, sweet and sour in the former, sugary and sub-acid among the latter. We think some such distinction should be made among grapes. If there were, we should class this with the sub-acid, though sour would not do to give to a class of grapes after the celebrated fox story. However, the acidity here is of a pleasing, refreshing nature, and we are glad to record our opinion that this promises to be one of our most popular varieties.

NEW FRUITS AT THE AMERICAN POMOLOGICAL SOCIETY.—It is to the praise of the recent meeting at Richmond that the new Fruit Committee exhibited so much conservatism. Unless new fruits are in some respects better than old ones, why should they be named and disseminated? They appeared to have spent no great

enthusiasm over any exhibited ; from which we gather that there was nothing particularly "supreme" introduced on this occasion

PEAR FROM H. A. JACKSON, CINCINNATI, OHIO.—If this is not an old kind, Mr. J. proposes to call it The Hoagland ; but they were in a state of decay when they reached us, and not recognizable.

"PARKS' CLING PEACH"—A large, handsome and good clingstone peach to succeed the White Heath Cling in ripening has long been a decided desideratum with Southern peach culturists. Perhaps it has been found in the "Parks' Cling." Let our fruitmen test it as soon as possible, and report results.—ED. SO. HORT.

The Parks originated in the grounds of Mr. A. L. Parks, at Alton, from a chance seed.

This is a magnificent looking peach, and in point of beauty is not surpassed by any of the earlier peaches. Specimens were exhibited at the late fair of the Illinois State Agricultural Society, that measured eleven inches in circumference. The tree last year, and again this, bore well ; leaves with globose glands ; fruit of the largest size and heavy, broader than deep.

Suture deep, extending quite around the fruit, dividing it equally ; skin not very downy, light creamy yellow, mostly covered with red ; flesh also of a light cream color, stained with red, but deeper red at the stone ; very juicy but not of the highest flavor ; ripens eight to ten days later than Heath Cling.—*Western Paper.*

## NEW AND RARE PLANTS.

ADIANTUM VEITCHII. (Moore.)—A distinct and fine Fern introduced by Messrs. Veitch from Peru.

It is extremely ornamental, attracting the eye by its rigid character and the symmetry of its growth, and we recommend it as a most desirable evergreen Fern for a warm greenhouse or intermediate stove.

The young fronds are very beautiful, being of a fine red color—that of the mature fronds being of a pale green.

The largest pinnules measure about an inch in their longer and half-an-inch in their shorter diameter, and are set stiffly on the plane of the fronds.

BEGONIA CHIELSONI. (Hort. Veitch.)—This is one of the finest of the flowering Begonias. It is a hybrid raised at Veitch's Nursery between *B. Boliviansis* and *B. Sedeni*, both now so well known.

It is very free in growth, and of good habit. The flowers are of a bright glossy red color, and of very large size. The plant continues in bloom from May to November.

As a decorative plant it cannot fail to be most extensively grown, and it will form an excellent companion to the *B. Sedeni* sent out last year.

DIEFFENBACHIA BOWMANI. (Hort., Veitch.)

—This fine plant was discovered by the late Mr. Bowman during his trip to South Brazil, and was described by him as being "far superior to all Dieffenbachias, as *Maranta Veitchii* is to all the Marantas."

The leaves, which attain an immense size, are of a pleasing light green color, spotted with dark green, or rather black green spots, thus giving the plant a very distinct and striking appearance ; they attain a length of from 2 to 2½ feet, and an average width of 1 foot, thus proving it to be a most useful exhibition or decorative plant.

NEPENTHES SEDENI (Hort., Veitch.)—This really pretty variety is a cross between an unnamed species with deep colored pitchers and *N. distillatoria*. The pitchers are produced in great profusion, even on very small plants ; they are of medium size, the surface being light green, and very densely covered with dark red spots. It is of dwarf and very neat habit, and we can highly recommend it to all lovers of this beautiful class of plants.

CYPRIPEDIUM (REICHENBACHI) LONGIFOLIUM.—A striking Orchid, discovered on the Cordilleras of Chiriqui at an elevation from 5,000 to 8,000 feet, and thus described by Professor

Reichenbach in the *Gardeners' Chronicle*, 1869, page 1206 :

"The flowers remind one very much of *Selenipedium dariense*. It is easily distinguished by the two angles at the inner base of the channeled claw or unguis of the lip. *Selenipedium Hartwegii* stands even nearer, yet it appears to be very distinct by its much larger and longer bracts, and by an open channel of the unguis of the lip, and by some discrepancies in the lip. Our plant appears to have the habit of the old *Selenipedium caudatum*. The inflorescence has

bracts very much like those of *Heliconias*. The flowers are greenish, very shiny outside; the dorsal sepal is very nearly oblong—triangular, with a brownish border. The inferior sepal is much broader and longer, or even quite as long, as the lip. The petals have a broad sub cordate base, and taper into a tail, greenish, with white borders, and two brown streaks at the base and brown at the ends, these tails being much shorter than those of the long tailed species. The lip is highly curious, for the basilar margins of the unguis overlap one another, so that there is no channel left."

## DOMESTIC INTELLIGENCE.

**RIPENING AND DECAY OF FRUIT.**—It is now satisfactorily demonstrated that the green coloring matter of the leaves of plants is what decomposes carbonic acid under the influence of light, and that the yellow and red parts do not give rise to this decomposition. But although apparently deprived of this green, and assuming a brown, yellow or purple color, there may still be a partial action retained. This assimilation of green leaves, in the reduction of carbonic acid, gives cause to the disengagement of oxygen, when exposed to the light, and although there are various shades of color, green predominates and is the normal color.

The ripening process in fruit develops itself in three stages, which are distinguished not only by physical but chemical features.

The fruit during the first stage is generally of a green color, and acts on the atmosphere in the same manner as the leaves in the decomposition of carbonic acid and the liberation of oxygen under the influence of light. As it matures, its second stage, the green color of the fruit is replaced by yellow, red or brown; and the vegetable matter so changed by the action of the same process as to be no longer able to decompose carbonic acid, but absolutely develops it by the combination of its carbon with the oxygen of the air.

A species of slow combustion takes place in the cellular tissue, acting upon the soluble matter found therein; the astringent tannin is first destroyed and the acid follows—a kind of saccharine fermentation, giving softness and flavor to the fruit; and in this stage it is eaten.

But as the final object is to liberate the seed, the third stage of decomposition sets in, if not delayed or prevented by the proper attention. Being now in a condition to admit air to the cellular tissue, and generate sugar, which gives rise to vinous or alcoholic fermentation and product of others, and that peculiar aroma. This action continued, destroys the structure of the fruit or its tissues, resulting in what we call rotting.

Some one may say—every one knows that apples, &c., are first green, then ripen, and finally rot, and what more do we want to know now, if we are told about carbonic gas and oxygen?

Still chemistry is a science of natural changes and combinations. What's the use of chemistry? Much every way. To become acquainted as to how these natural laws act, is a desirable step and worthy of study; and although an eclipse will take place, no one but an astronomer, acquainted with the motions of the planets, can calculate when and in what latitude and longitude the total eclipse will fall, or how much of it will be seen in given places. True, they are no nearer the sun or moon than the commonest laborer; yet study has given them a knowledge that is useful, hence it is that a chemical reason may be given in the ordinary terms for chemical (natural) changes in the process of the ripening of fruit.—J. S., in *Lancaster Farmer*.

**VARIETIES OF THE FIG.**—The nomenclature of the fig is somewhat confused, and some difficulty exists in attaining a correct list of syno-



nym. The following varieties we have found the most desirable :

*Black Genoa*.—Size medium ; long, tapering near the stem ; skin dark purple, covered with bloom ; pulp bright red, very good.

*Black Ischia*.—Medium size, round ; skin dark purple, nearly black at maturity ; pulp deep red ; very prolific and excellent.

*Brown Turkey*.—(Synonyms, Lee's Perpetual, Brown Italian, Jerusalem, Murray, Howick, Walton, Common Purple, Brown Naples, Large Sugar Fig, etc., etc.) From its numerous synonyms, it shows its great popularity. Fruit, medium, oblong pyriform ; skin dark brown, pulp red, very sweet and excellent. This is, unquestionably, the most prolific variety for this section. It produces very large and regular crops and is well adapted for drying.

*Brunswick*.—(Synonyms, Madonna, Constantinople, John Mann Fig, Brown Hamburg, Hanover, Bayswater, etc., etc.) Fruit very large, pyriform ; skin violet brown in sun, pale greenish violet in the shade ; flesh reddish, with occasionally a hollow centre when grown in a very rich soil ; very rich and excellent ; a prolific bearer.

*Green Ischia*.—(Synonyms, Green Italian, White Ischia, Green Red Withers, etc.) Fruit of medium size, round obovate ; skin pale green, very thin ; pulp deep red ; very rich and well flavored ; a very desirable variety, and quite prolific.

*Celestial*.—(Synonyms, Small Sugar Fig, Small Violet) Size very small ; skin purplish, with much bloom ; pulp pale pink, very sweet and excellent ; matures early, and when fully matured, may be eaten without peeling ; dries very easily, but is rather small for that purpose ; very hardy and prolific.

*Lemon*.—(Synonyms, Yellow Ischia, Cyprus, Des Deux Saisons a Fruits Jaunes, etc.) Medium roundish ; skin pale yellow ; pulp red, delicate and rich ; a very good variety, moderately productive.

*Marseilles*.—(Synonyms, White Marseilles, White Naples, Pockock, Standard, etc.) Size, medium, round obovate ; skin very pale yellowish white ; flesh white, rather dry, but sweet. This variety is extensively grown near Marseilles and along the coast of the Mediterranean, for drying purposes, and can be recommended for that purpose here. It is not a desirable variety for open field culture in the interior, but thrives remarkably well on the sea coast. This

variety is said to be the same as that grown near Smyrna, and from which the best figs of commerce are produced.

*Nerii*.—Skin pale greenish yellow ; fruit small, pulp red, very delicate and of excellent flavor ; it is not very productive in open field culture.

Of the varieties not so well known, but deserving of mention, the following are desirable for amateur culture :

*Angelique*.—(Synonyms, Mellite, White Coucourell, etc.) Fruit small, yellow, pulp white sweet ; very early and moderately productive.

*Early Lemon*.—(Synonyms, Jaune Hative.) Similar to Lemon, but ripens a week or ten days earlier.

*Madeleine*.—Is a small white fig, very sweet, but not very productive.

*Pregussata*.—Size medium, brown ; pulp deep red, flavor good.

*Superfine de la Saussaye*.—A medium fig, round and much enlarged towards the stem ; skin brown ; very sweet and good ; leaves deeply lobed.

*Violette Ronde*.—Fruit medium, skin violet, pulp deep red, very sweet, and moderately productive.

We have several other varieties in our collection, but they are either inferior, unproductive, or doubtless only synonyms of some of the foregoing described varieties.—P. J. BERCKMANS, in *Rural Carolinian*.

A SUBSTITUTE FOR COFFEE.—From chemical analysis it appears that the seeds of the asparagus when dried, parched and ground, make a full flavored coffee, but little inferior to Mocha, containing in common with tea and coffee, the principle called taurine. Dry the asparagus berries well, after being thoroughly ripened, then rub them on a sieve, thus the seeds are readily separated. — *Journal of Health*.

CLOSE PRUNING GRAPES.—Mr. M. Pike, of Alton, Illinois, is a very successful grape grower. At one of the meetings of the Alton, Ill., Horticultural Society he gave his experience, and said :

"I am satisfied that the majority of grape growers over-crop their vineyards. I have been each year reducing the wood in my vineyard until now my Catawba canes are not more than three and a half feet long, and but one cane, and I am getting just as near the ground as possible,

for the reason, among others, that they are easily laid down for protection through the winter.

Last year my Catawba vines made the heaviest growth of wood and produced the largest bunches of fruit of any in my vineyard; probably 15 per cent. more than my Concords. They

ripened up well (they were not merely colored) under this system of the succession of leaves. I grow three leaves of different ages. The original leaf is the most valuable one. I then grow two additional ones. You may have the succession of leaves very early by pinching early. I do no summer pruning."

## FOREIGN INTELLIGENCE.

**POT VINES.**—In the following paper I will relate what has been my successful experience in growing pot-vines with limited convenience in one place for several years, and although I may not describe anything uncommon, my remarks may prove of interest to some of your readers.

It is usual in many gardens during spring to have one, two, or perhaps, even three, hotbed frames put up in the course of the season. In the first of these, then, among the other things a lot of vine eyes are inserted in a pan in the usual manner. As they become nicely rooted, they are placed singly in small pots. They are still kept in a corner of the frame, and grown on. As they advance they are encouraged in similar quarters, and by and by, perhaps, shifted into a fresh frame where there is a greater heat

They are kept as long as possible under such circumstances, and about the middle of May, or when the bedding plants are getting out of hand they are transferred into ordinary sized cold frames. In these a row of plants is set along the front of the frames, almost as close together as the pots will stand. A few pieces of strong cord are tacked tightly across the frame to act as a trellis to keep the canes off the ground, and at a regular distance from the glass. When placed in these quarters, the vines are encouraged as much as possible by good attendance, shutting up early to husband sun heat, and I have often seen many canes with roots and tops "as sound as a bell," produced in this way by the end of the season.

Canes thus grown may not be nearly so good looking nor so strong as those reared in bottom heat in houses by themselves, or in other hot-houses, all through the season, but for their size they are often by far the best; for second sized canes with good sound roots and well ripened stems produce often better crops of Grapes than others twice the size and apparently sound enough. I could prove this by an instance

under my own observation at the present time.

These canes in the cold frames in a good season can be ripened to perfection. The sashes, according to the weather, can be moved at convenience, and any amount of air can be given. When their full season of growth is over it is generally the plan to take them away to a back place and plunge the pots in cold ashes to insure the roots from being injured by too sudden changes of temperature, till the time arrived for their being put into the forcing pit, which was generally in November. They have always done well, producing very good dishes of Grapes in May.

This plan of growing young canes would certainly not be resorted to if I had better conveniences, but in many cases we have to make the most of things as they are. In this instance, there is a small stove for fruiting the vines in, but not another for growing a young lot of vines. I have known of other cases in which good fruiting pot vines could have been reared in a similar way, but the attempt was not made.—ROBERT MACKELLER, in *London Journal of Horticulture*.

**HIMALAYAN RHODODENDRONS IN IRELAND.**—I fear I am rather late in suggesting to your readers to look at a few of the Himalayan Rhododendrons which have bloomed the last spring with especial beauty at our Botanic gardens, and elsewhere in the neighborhood of Dublin. I may also notice another species from a warmer climate than those, and which has been greatly admired within a few days of the time I write, at our Trinity College Botanic Gardens. In a greenhouse at Mr. Gray's, at Temple Hill, near Blackrock, a bush which may almost be called a tree, of *R. Nuttali*, produced several fine trusses of its lovely white bloom after spending the autumn and winter plunged in the open ground and unprotected, till it was brought in, when about to flower. Another and a still finer specimen,

from the conservatory of Captain Coote, at Farnley, Knockmaroon, near the Phoenix Park, attracted universal attention at the recent exhibition of our Royal Horticultural Society.

In Glasnevin and Trinity College Gardens, *R. Edgeworthii* has this spring formed a prominent feature. In its nature parasitical, its many long branches bear to be twisted and intertwined into a roundish or other form, in which way the flowers show to much advantage; and they have a quality with which I believe few of the family are endowed, that of admitting a delicious perfume. In Dr. Hooker's celebrated work on the Sikkim-Himalaya Rhododendrons, he gives a fine coloring of this tree, and describes it as delighting to grow on the limbs of pine trees.

There is now in bloom at both these gardens, of somewhat different habit, and to my eye still more handsome than the others, if not the most so of the numerous family, *R. Dalhousiæ*. This also is loose or straggling in its habit of growth, but its branches are not so pliant as those of *Edgeworthii*. The flowers, which are large, and waxy, and white, or creamy white, are strongly perfumed, somewhat with the odor of the lemon. In size, color, and general appearance, they resemble, as Dr. Hooker describes them, the Bourbon lily, *Lilium candidum*. *Rhododendron ciliatum* is also another Sikkim Himalayan species, which has for several years luxuriantly bloomed in the open air and very early in spring, or rather at the close of winter, at the northerly side of the Fern-house at Glasnevin. Whilst those which I first named command admiration from every lover of beautiful plants, this latter has to me a peculiar charm. In the autumn of I believe, the year 1854, which was followed by a very severe winter and spring, two seedlings of this shrub, then new in Scotland, were there given to me by one anxious to test their power of bearing the climate of Malahide, where I then had a garden. He bound me to leave them for a year without protection; and naturally I watched their progress with interest, which was rewarded by very early blossom, almost before the snow had melted from protecting the stems. Again, last autumn, two young plants of this now well known species were sent to me, with two seedlings of *Edgeworthii*, to try how they would live in a frame at rear of my dwelling here. All so far look well, and one or two have flowered; and though the texture of the foliage be such as does not suit the smoky air of Dublin

uncovered, I hope and expect to see them enjoy many a month, and years, in their new abode. Why shall not each of the kinds I name suit for culture under glass in this or another city?

The last species to which I now refer is that called *R. Javanicum*, from a warmer climate than any of the others, though I know not the particular locality in Java which is its especial home. For weeks one of the finest, if not the finest, specimen in Ireland, has been in flower in the College Gardens here. Orange red is the color given, and it seems correctly, to the fine trusses of its bloom. Though the conservatory in which this shrub has for years lived be partially heated in severe weather, frost to some degrees often makes its way within it. As is my wont, I merely offer some results of personal observation, inviting others to enjoy what gives refined pleasure to myself. I try not to ape scientific learning where I have it not, and which perhaps, consistently with my capacity and main pursuits, I ought not to cultivate or possess: I still remember my school day lesson of Horace—'Let not the cobbler venture beyond his last'—

'Ne sutor ultra crepidam.'

But even half-learned ignorance knows that the *Rhododendron* family are generally easy of culture. By grafting and layering, and seed, and sometimes, under a skillful hand, by cuttings, an infinite number, if there be such a thing, can be obtained of these most ornamental evergreens.—*Gardeners' Record*.

— — —

*SALVIA HEERII*.—Seeing *Salvia Gesneræflora* so highly commended in the last copy of the *Record*, induces me to speak of the merits of *Salvia Heerii*, which I grow for Conservatory decoration, and which I prefer to *S. Gesneræflora* as it is a much freer bloomer, and stands very much longer when in flower. My mode of cultivation is as follows:—Strike cuttings in heat in March, potting them as soon as they are rooted, in thumb pots, and stop them at every joint as they grow. I plant them out on a south border the first week of June, keeping them regularly stopped and watered to the end of September, when I pot them in ten and twelve-inch pots. The compost which I find to suit them best is two parts good turfy loam, one part decayed cow manure, and one part leaf mould, with the necessary quantity of sharp sand. After potting, the plants get a good watering, and are still kept out of doors until the end of October. The

plants I want to bloom in February are removed to a peach-house where the frost is kept out. The first week of January they get some heat, say 40° at night and 50° to 55° by day, with sun heat. I do not stop the first lot of plants after potting them, but allow them to grow on until they bloom. When the pots get full of roots they must be kept liberally supplied with liquid manure, and syringed every bright morning until the flowers begin to expand. In the first week of February, I have them three feet through, grand specimens, with green foliage, covered with beautiful racemes of brilliant scarlet flowers, and are generally admired by all who see them, as well as being so useful for cut flowers. The plants I want to bloom in April I stop twice after potting, and keep them in a cold pit until the end of February, when they are removed to a vinery just started, and treated just the same as the first lot. I also grow *Salvia splendens* in the same way. I have it in bloom in November and December; it is also well worth growing.—T. RORKE, Gardener at Killakee, in *Gardeners' Record*.

GRAPES FOR EXHIBITION.—On reading the proceedings of the Fruit Committee at the Royal Horticultural Society's Meeting, September 21st, page 226, I came to the conclusion that a few notes on early and late Grapes would not be out of place, and I invite the attention of the committees of horticultural societies holding their exhibitions in autumn.

I would make a distinct class for such fine exhibition Grapes as Meredith's Alicante and Lady Downe's among the black varieties, as, unless this be done, the different varieties of Hamburgs cannot have justice. I would also have a distinct class for the Muscats and Trebbiano among white Grapes, so as to give the Royal Muscadine, the Sweetwaters, and the like a chance of winning a prize.

In support of this view I would ask, is the flavor of the Alicante and Lady Downe's in August, September, or October to be compared to the taste of the Hamburgs? Also, is the flavor of the Muscats and Trebbiano to be compared with that of the Royal Muscadine or Sweetwater? These questions should answer themselves.

I do not for a moment wish to disparage the fine qualities of the Alicante and Lady Downe's, leaving out the newer late sorts, for I am perfectly aware of their usefulness, but I say they

are not to be compared with the Hamburgs for flavor now; and were the judges to taste, undoubtedly there would be many exhibitors disappointed, for, instead, as is generally the case now, of the award being given to the fine large bunches, well colored though they might be, it would go to the Hamburgs, they being ripe and fit for table (or they should be so when shown), which cannot be the case with the Alicante and Lady Downe's. To me it seems a sin that such fine bunches as I have seen shown in September should be cut, for, the taste being insipid, they are worthless.

I am fully aware that Grapes must be ripened and colored by the end of September or beginning of October, or they stand but a small chance of coloring, unless it should prove such a favorable autumn as the present. But Grapes require to hang a certain time after they are colored. Thus, the Hamburgs colored by the end of July are not ready for cutting till the end of August, and those colored a month later are not at their best yet. Above all, the Alicante should hang till February to bring out its flavor, and the same applies, or nearly so, to the Lady Downe's. Of course, I do not say they cannot be eaten till then, but I do say they are not at their best till the time I have mentioned.

Next, as to the white Grapes. The Muscats are undoubtedly the finest winter Grapes for those who have vineries and heat enough for them, but their flavor in August, September, and October is not equal to that of the Royal Muscadine, Buckland Sweetwater, and Foster's Seedling. The Muscats require a high heat to ripen them, and they must be ripened early, but they should not in any case be cut before Christmas.

I now give the names of a few good Grapes, black and white, for exhibiting. Of the black there is none to excel the Black Hamburg as a show Grape, but a far superior Grape for flavor, though ripening at the same time, is Pope's Hamburg [Frankenthal]. This is a beautiful Grape, and no one should be without it where quality is considered. It has a very thin skin, a delicious flavor, and will hang till Christmas without deteriorating. Trentham Black is also good for exhibiting, but unless ripened, say, in July, it should not be cut till November; in fact, this is the best of the Hamburgs for keeping.

Of the whites, the best early is the Royal Muscadine. This is a very early Grape, and a good keeper. Ripened in a late house it will hang

well till Christmas. Foster's White Seedling is also a keeping Grape of good flavor. All the above can be grown well with ordinary care and with but little fire heat.

The Alicante and Lady Downe's are both too well known to say more than that they are (leaving out the recent additions, such as Mrs. Pince), the best late Grapes, but they are not fit to be exhibited till the new year comes in, because, till then, we have plenty of far superior flavored Grapes, and no matter how fine a bunch of Grapes may look if the yare acid or inferior to the palate. The Muscat of Alexandria, Trebbiano, and White Lady Downe's are, as I said before, good for late work, till then there is nothing to equal the Muscadines or Sweetwaters.

As it is now, some time since I saw this subject discussed, I hope this short paper will be the means of eliciting a few remarks from some of your correspondents.—STEPHEN CASTLE, Bent Hill Gardens, Prestwich, in *Journal of Horticulture*.

AMERICAN POTATOES IN ENGLAND.—Singularly enough, we are just now getting from many of our best cultivators an unanimous expression of opinion with reference to these American potatoes that is far from being commendatory. Indeed, the opinions thus expressed fairly enough lead to the opinion that these gentlemen believe the favor of the multitude has gone on the wrong tack, and that loads of money has been and is now being spent by potato cultivators in the purchase of these new varieties, that might be better employed in the purchase of some of the fine new and improved home-raised kinds, that are in every sense first rate. From Sawbridge-worth, from Kent, from Woodstock, and many other parts, the testimonies have come against the pretensions of the Early Roses, and Goodrichs, the Climaxs, and Reds; the one and the other acknowledge their fairly prolific qualities, but denouncing the attempts to set them up as fit to satisfy the cultivated tastes of English palates. Herein lies the real point of ultimate value, as, unless any new variety possesses relatively qualities superior to our old established kinds, the introduction of it can be of no service. Two years' growth of the "Rose" and the "Red," *alias* "Flourball," has convinced me that they do not exceed in the production of quantity plenty of our own kinds, and the trial last year of several other of the American kinds amidst a collection of some hundred sorts of potatoes, leads to the conclusion also that my opinion as

to prolificacy is correct. In the matter of earliness we gain nothing whatever, in the matter of keeping qualities we gain nothing, and in the matter of table quality we gain nothing, but actually loose. What, then, do we gain by the introduction of these foreign potatoes? I am compelled in the interests of horticultural truth to say, Nothing!

As respects the adaptability of the American varieties for exhibition, a point of some importance now with potato connoisseurs, I feel that they have but little chance of being placed with first honors, if put into competition with our best English varieties. The bulk of them are remarkable for the quality of eyes they possess, and Climax, for instance, is in this respect a veritable beast. The only two kinds that I could at all commend for exhibition are Gleason's Late, a beautifully marked variety, and for show purposes worth half a dozen of the others, and Prolific, a large, flattish, round white kind, that will make a useful addition, if the tubers are not too large. The objectionable taste that leads judges (heaven save the mark!) to award prizes to the biggest tubers only, without reference to other points, is simply disgusting. No one who possessed any knowledge of what constitutes a good potato would commit so grave an error.

If I wished to partake of a melon, I should scarcely be satisfied with the flavor and texture of a squash; and, by the same rule, if I desire to have a dish of good flavored potatoes for my table, I must grow kinds that will suit my palate, and not sorts that yield plenty of tubers, but none fit to eat. It is easy for some gardeners to plead that they have so many bushels required for the house consumption, and that to get them they must grow sorts that produce the most in bulk. Such reasoning will not do for me. Potatoes are intended to form a portion of the dietary of intelligent, sensible beings; and gardeners should understand, as a primary consideration, that quality is the foremost consideration with their employers, and not mere abundance. Just as a pound of rumpsteak is far more preferable to treble that quantity from off the shin of beef; so is a dish of truly good potatoes more to be desired than three dishes of some coarse kind the texture of which is grainy and hard, and the flavor absent. As we value our characters as intelligent horticulturists, let us hope that, in grasping too eagerly after the shadow, quantity, we loose not the substance, quality, flavor, and goodness.—*The Gardener's Magazine*.

## HORTICULTURAL NOTICES.

## AMERICAN POMOLOGICAL SOCIETY.

We give in this number the address in full of President Wilder, at Richmond, and shall, in future numbers, revert to many matters of great interest which occupied a share of the Convention's time. This address of Mr. Wilder's is conceded to be one of his best efforts, and it will be read with profit by all. To us, particularly, it is welcome as indicating the first great turn in the tide of erroneous notions of fruit growing, against which we have battled so long. The President lays great stress on the necessity for good culture before any success can be had with fruit trees. There is little doubt but that the great enemy of fruit culture is starvation; and that there is no greater aid to starvation than cutting away the surface roots at a period when every effort is necessary to supply the tree with nourishment. When a tree is young, and its small roots are near the stem, close to which the plough or cultivator does not go, we do not see the injury; and the manure which people give to root and other crops makes the tree grow, and thus we imagine the system a good one; but when the roots grow away from the stem, and are not by it protected, the injury by loss of roots is immense. No orchards where this plan has been in operation has continued productive for a very long time.

It is pleasant to us to notice that Mr. Wilder admits that we were wrong in our past notions, and that it is the true philosophy to keep the feeding roots as near as possible to the surface, and not by barbarous modes of culture, cut them away while engaged in their assimilating duties.

We feel that our cause is nearly won, and that ere long we shall not find one but who "always believed" that a cool surface, surface roots, and surface and regular manuring, are the essential elements of good culture.

—————  
 ACADEMY OF NATURAL SCIENCES,  
 PHILADELPHIA, September 19, 1871.

Dr. Genth presented fresh specimens of *Lespedeza striata* from North Carolina. This was called Japan clover, from the fact of its having been supposed to be an introduction from that country. There is no evidence that it is of Japanese origin; but the same plant is found in Japan, where it has been long known, while it has not been observed in the South, so far as certainly known, prior to the rebellion. Now it has taken posses-

sion of hundreds of acres, where it has crowded out every other species of vegetation. Dr. Genth spoke of it as forming a dense green carpet under pine forests, as well as enduring the hot sun under the driest times.

Dr. Leidy presented some specimens of the mushrooms which had been cooked and eaten by a Philadelphia family a few days before, and had resulted in the death of one young lady and the severe sickness of all the rest. The only person who did not partake of the mushrooms was the only one who escaped, showing clearly the agency of the mushroom in the case. The young lady who died, perceived no symptoms of sickness till five or six hours after, when she was suddenly taken ill on the street, and was carried to a drug store, where she soon after died.

The specimens exhibited by Dr. Leidy were about four inches high and the cap about three inches wide. The stems were slender, about half an inch thick, with a bulbous base, which, as also the upper part of the cap and the *gills beneath*, were of a clear papery white. The odor is repulsive; and it is a surprise that any one should use them as the genuine mushrooms. They usually grow in woods and shady places. Dr. Leidy supposed it to be the *Agaricus vernus*, of which there is a figure in Buillard's Flora of France. In that country it appears in spring, from whence its specific name. The French author refers to its deadly properties, and remarks that many persons have paid a heavy penalty through mistaking it for the true mushroom. After handling, Dr. Leidy, had by accidently touching his eyes, caused a slight inflammation in them.

Mr. Isaac Burk called the attention of the Academy to the direction of the spiral growth in the flowers of *Spiranthes cernua* and *S. gracilis*. In both these species he exhibited specimens in which some of the spirals were to the right and some to the left. Mr. Thomas Meehan remarked that this interesting subject was beginning to attract attention in other quarters. Mr. H. W. Ravenel, of Aiken, South Carolina, had recently noticed that in some *cucurbitaceous* plants the spiral growth was indifferently to the right or to the left in the same plant.

Mr. Thomas Meehan exhibited a young spike (cob) of corn, sent to him from Louisville, Ky., represented as having been found in the interior of another of the usual character. He remarked that it was not unusual for this phenomenon to occur. Pears have been known to develop inside of other pears, and it was still more common for a rose to develop from the centre of another rose; but the chief interest in this case was that the long silky pistils had wound or been wound round the central axis as regularly as thread round a spool. Sprouting in such an abnormal and unfavorable position inside of another cob, we should expect to see this a tangled mass. He failed to understand the peculiar law of development in this case.

# The Gardener's Monthly.

DEVOTED TO

*Horticulture, Arboriculture, Botany and Rural Affairs.*

EDITED BY THOMAS MEEHAN.

---

*Old Series, Vol. XIII. NOVEMBER, 1871. New Series, Vol. IV. No. 11.*

---

## HINTS FOR NOVEMBER.

### FLOWER GARDEN AND PLEASURE GROUND.

It is now so well understood that we may have an immense addition to our list of hardy evergreens if we will only shelter them, that we expect all those who love these varied winter favorites will take measures this season to plant shelter belts in exposed places, or else to set the common hardy trees like Norway and Hemlock Spruce, and Scotch, Austrian and White Pines thickly about, so that the rarer ones can be put between them.

Almost all young trees are tenderer than they are when older. It is therefore no test of the hardiness of some rare thing, that a small plant is killed in the winter. Silver Firs almost always gets killed back for a few years in this section, unless protected, but yet gain a little in strength. After they are ten years old they will endure our hardest weather. So Spanish Chestnuts, English Walnuts, and many others, will die back considerably, until they get strength. Therefore, protect any valued young plant, if possible, no matter how hardy its reputation may be.

Every one who has dug up a potato knows that when the tuber has finished its growth, all between it and the parent stalk dies. If the potato were to remain undisturbed till spring, frost and other things of course uninjuring it, it would push up from the place where it stood, and a new set of potatoes push out, and the space between them and the original, get wider every year. So year after year there would be this continual progression.—a wandering away from the first centre, until in time the living plant might be a mile away from the original spot which gave it birth.

Something of this kind goes on in all herbaceous plants,—a part progresses, and a part dies every year. It is for the want of this knowledge that so many friends lose these plants. Though all herbaceous plants move in some such manner, they do not all go directly under ground, but make bunched stocks just above ground. In their native places of growth they manage to get covered with decaying leaves from the woods or shifting sands on the plains, but in cultivation nothing of this kind can be naturally accomplished, and unless art comes to aid the plant they soon die away. An Auricula, a Primrose, or a Carnation is a good illustration of this. In the two former a new crown is formed on the top of the old one, and as the lower parts in time die away, unless new earth is drawn up, success with such flowers will not be great. The best plan is to take up and replant every few years, or cover the running parts above ground with earth, so that they may have a chance to get new roots from the advancing stocks. This is noticed here at this season to show that earth is the natural covering for herbaceous plants, and therefore one of the surest ways of preserving them safe through winter is to draw earth over them. In the spring they can be unearthed and then divided and set a trifle deeper than before, which is all they want. We are often asked how to preserve Carnations, Chrysanthemums, Pansies, Phloxes, Hollyhocks and so forth, safe till spring. The principles here laid down will explain the practice.

Pampas Grass, Tritoma uvarias and other half hardy things do much better when left out all winter and protected. The best protection is a dry-goods box filled with leaves. Many

plants might be saved in this way, and the increased beauty of the plants would pay well for the trouble. These ugly boxes may be objectionable, but probably the time may come when it will be thought worth while to have neat cases made expressly for them.

As soon as the ground gets caked with the first real frost, herbaceous plants should be protected. Though hardy, they will repay this extra care,—mostly natives of woods or grassy places in their native state, they expect a covering of leaves or dry grass. We find dry leaves the best material for the purpose, a few inches is a sufficient depth, —a little soil being thrown on to prevent the leaves blowing away. Where such material is not at hand, the common garden soil may be drawn over them, as before recommended in these pages.

The planting of trees will still continue to engage our attention at every favorable opportunity. Many prefer at this season to remove trees in the winter by the "frozen ball" system. There is nothing gained by this practice. To those unacquainted with this mode of planting, we may as well describe it. Just before frost is expected, a trench is dug around a tree a few feet from its base, leaving the tree so, that with a rope at the top, it can be easily drawn over. A hole is then dug for it in the situation desired. When the "ball" has become frozen through around the tree, it is removed to the prepared hole; and, when a thaw comes, the soil is filled in around it. We have said there is nothing gained by it, and there are many disadvantages. If the tree has been removed a "time or two" before, as most nursery trees have, it will have an abundance of fibres near the stem, and can be successfully removed without much regard to the "ball of earth," either in fall or spring. If it has never been removed before, that is a tree growing naturally, it will have no fibres at its base, and so no "ball of earth" can preserve them; so that a tree which can be moved successfully on this freezing system, can be as successfully done without it. The disadvantages of it are that it exposes the injured roots for a long time to the injurious action of the frost and the elements, besides the frequency of the operation being improperly done by several attempts being made at its completion. We have given the system a fair trial, and have done with it. The main object should be to preserve all the roots possible with the tree, keep them moist and preserve from injury, then go ahead and don't wait for frost.

## FRUIT GARDEN.

Passing a fruit stand in Philadelphia this 6th day of October 1871, we asked the price of some tolerable fair Duchesse d'Angouleme Pears, and were told that for twenty-five cents we might take one of the coveted fruit away. As this would probably make \$20 per bushel, we could not but reflect on the present phase of fruit culture, and what it ought to be, if it was properly understood. There have not been less than 200,000 dwarf pear trees, with at least as many standards set out on the average for each year during the past thirty years,—say *twelve millions* of pear trees, and yet to get a decent Duchess pear in one of our principal cities in October, we have to pay 25 cents. We know what some horticultural writers would say,—we know what some horticultural editors have done. They have started the cry that pears are a failure; that they will not do well in the climate of the United States. What an absurdity! There is scarcely an old city in the Union which cannot show its old pear trees annually loaded with its fruits. Throughout the whole of Pennsylvania especially, trees may be here and there seen which annually bear until the branches become quite recurved, like a weeping willow with the load of fruit. Nine-tenths of the twelve millions are probably dead; but it was not the climate which killed them. It was barbarous modes of culture, and we expect when our instructions are carefully followed for their culture, pear growing will be found one of the most remunerative of crops. Remember the rule—keep the roots near the surface, and annually top dress. In choosing pear trees take those which have a light sappy looking bark. Bark bound things will stand a year without moving. If they are in this condition any age will do well from a one or two to a ten year old tree,—but generally a two or three year old will do best. Shorten half the wood at transplanting, and be sure to have the earth hammered tightly in. The heel and toe business makes but poor work, a heavy hammer is best.

In choosing Dwarf Pears, select those that have been budded close to the ground, as when they are replanted the stocks should be buried an inch below the pear scion, which prevents the attacks of the quince borer. If a long stem has to be buried, the usual consequences of deep planting result, and do as much injury as the quince borer. Also in choosing, select, if possible, plants that have been raised from cuttings,



for layered stocks have almost always a long deep tap-looking root, on which dwarf pears do not do well. If we have to use such dwarf pear trees, better shorten some of this long trunk root before planting. Never plant what appears to be the stem of a tree far beneath the surface, under any circumstances, for disease will be most probably an ultimate consequence.

Apples, Quinces, and Plums should be examined before frost sets in, and if any borers have effected a lodgment—a jack-knife and a strong piece of wire are all the implements necessary; a man will go over several hundred trees a day. It is a cheap way of preserving trees. If many of the remedies proposed by correspondents in our paper have been tried and found effectual, such as tobaccostems, etc., there will be few borers to deal with in the examination, but the best plan is to put a piece of paper round the stems, tie, and then gas-tar it. This serves for two years, and not only keeps out the insects, but is a safeguard against mice, which are so apt to girdle trees under the snow in severe weather.

In cultivating Raspberries on a large scale, they do best in hills, as the cultivator keeps them from crowding each other so much. For garden culture they are better in rows, the suckers to be kept hoed out occasionally as they grow; enough only being left that will be required for fruiting next year. Where canes are required for new plantations, of course a portion of the crop must be sacrificed to the suckers.

Strawberries are much better when protected through the winter, no matter how "hardy" they may be. Very coarse strawy manure is the best material, which can be raked off in early spring. A few inches is sufficient, just enough to keep the sun off when frozen, which all our readers know by this time is the chief cause of loss by frost.

#### VEGETABLE GARDEN.

It is little use to attempt to grow vegetables well, unless the soil is well treated. They may be and are grown on thin soils, not only at a great expense for manure, and at a great risk of dying out in a dry season, and of having the roots rotted out in a wet one. In those parts where the frost has not yet been severe enough to injure the celery crop, it may have another earthing up. Care must be exercised in the operation not to let the earth get into the hearts of the plants, or

they will be liable to rot. Where the plant has evidently finished its growth for the season, measures should be taken to preserve it through the winter. For family use, it is probably as well to let it stay where it is growing, covering the soil with leaves, litter or manure, to keep out the frost, so that it can be taken up as wanted. Where large quantities are frequently required, it is better to take it up and put it in a smaller compass, still protecting it in any way that may be readily accessible. It always keeps best in the natural soil, where it is cool and moist and free from frost, and whatever mode of protection is resorted to, these facts should be kept in view. Beets, turnips, and other root crops, will also require protection. They are best divested of their foliage and packed in layers of sand in a cool cellar. Parsnips are best left in the soil as long as possible. If any are wanted for late spring use, they may be left out to freeze in the soil, and will be much improved thereby. Cabbage is preserved in a variety of ways. If a few dozen only, they may be hung up by the roots in a cool cellar, or buried in the soil, heads downward, to keep out the rain, or laid on their sides as thickly as they can be placed, nearly covered with soil, and then completely covered with corn stalks, litter, or any protecting material. The main object in protecting all these kinds of vegetables is to prevent their growth by keeping them as cool as possible, and to prevent shrivelling by keeping them moist. Cabbage plants, lettuce, and spinach sown last September, will require a slight protection. This is usually done by scattering straw loosely over. The intention is principally to check the frequent thawings, which draw the plants out of the ground.

In making new vegetable gardens, a south-east aspect should be chosen, as far as practicable. Earliness in the crops is a very great desideratum, and such an aspect favors this point materially. Too great a slope is objectionable, as inducing to great a run of water in heavy rains. The plots for the crops should be laid off in squares or parallelograms, for convenience in digging, and the edges of the walks set with box edging. If water can be introduced, it is a great convenience.

Sometimes broccoli does not head before there is danger of frosts, especially if growing vigorously. If taken up with small balls of earth, and set in a damp cellar, they will still perfect the selves.

Asparagus beds, after the tops have been cleared off, are better covered with litter or stable manure. The plants shoot easier for it next season.

When the ground becomes frozen, or no other work offers, preparation can always be made for advancing prospective work when it arrives. Bean-poles may be made; and if the ends are charred, and then dipped in coal tar, the commonest material will be rendered nearly equal to the best cedar.

### HOT AND GREENHOUSE.

Plants stored away for the winter in cold pits, require more care for the first month or so than at any other time through the winter season. Many of them have unripened shoots, or shed many of their leaves, and unless these be cut off and removed, gangrene and decay commit distressing havoc. Air should be given at every opportunity, and nothing omitted that will, in any way, tend to harden the plants, and send vegetation to rest. No more water should be given than just sufficient to prevent withering, and the temperature should be kept as near 40° as possible, and every chance taken to render the air about the plants dry. When frost actually does come, no further care than protection from its embraces will then be required. Plants so hardened, may stay covered up for weeks, without any light or air, and secure from the slightest injury. Mice constitute the most troublesome enemy in a pit closed for any length of time; but we have, as yet, found nothing better than the recommendation given in back volumes, namely, to take peas and soak them twenty-four hours in water, then roll in arsenic and sow in a pot, as if in the regular way of seed-sowing. A few pots so prepared, should be placed in the pit before permanently closing up. The mice usually make for these pots at their first entrance to the pits. If placed on the soil, they seem to guess your secret, and will not "bite."

Plants in cellars need much the same care as those in pits. Avoid heat and dampness; frequently however, plants suffer in cellars through getting too dry. They should be looked over, at any rate, once a month, and a little water given, if likely to become entirely dry.

Plants in windows and rooms usually suffer from excessive waterings,—very dry air about

them,—too great a heat, or too much shade. As much as possible, room plants should be selected for their indifference to these requirements. Succulents, such as Cactuses, Mesembryanthemums, Rocheas, Crassulas, Aloes, &c, care not how dry the room, but they demand all the sunlight possible. Camellias, Chinese Primroses, Azaleas, *Dicentra spectabilis*, Polyanthuses, Violets, Hyacinths, &c., do not mind a little shade; but they abhor a high temperature. Others again, while disliking heat, want light; of these, are *Calceolarias*, *Cinerarias*, Geraniums, Pelargoniums, Pansies, Daisies, Tree Carnations, perpetual blooming Pinks, Roses and the like. 'Leaf plants,' for the most part, like a close, moist atmosphere, and a moderate degree of heat to do well. For these, glass partitions and closely glazed cases are usually employed. A great error in the growth of plants in these cases, is to suppose they require no air. The closeness is to secure a moist atmosphere, not to exclude the air. Whenever, therefore, the temperature is low, and little evaporation going on, the opportunity should be seized to air the cases; a few moments are sufficient. A very pretty plant arrangement made in parlors that have bay windows; the whole window may be closed off from the main part of the room by a sash, and filled with plants. Some on the floor,—some on shelves, and some pendant from the roof. A common oil lamp will be quite sufficient, with the usual window shutters, to keep out frost during the night or extra severe weather, while the regular day temperature of the room will suffice for that time. When the lamp is burning, provision should be made for the admission of fresh air from the room at the bottom of the case, and for the exit of consumed air at the top of the case. This is best accomplished by a tube to and from the lamp.

It must, however, be remarked that the fumes of burning gas is highly injurious to vegetation, and any adaptation of heating by it will fail, unless provision be made to lead the fumes away. With this precaution, gas-lights in towns and where it can be had cheaply, would be very useful in heating small parlor plant cabinets.

To those who have larger plant cabinets or small conservatories, connections with heaters or hot water from kitchen ranges will suggest themselves. This is often done. The great error we have often noticed is, that the heat is led to the back only, when it should be continued

right to the front or coldest part of the house.

When heaters are employed, the oxygen of the air is usually defective, and, besides, the air is very dry and ungenial to healthy vegetation. Evaporating pans around the mouth of the air flues should be used in such cases,—syringing done at frequent intervals, and pure fresh air given whenever a warm out-door spell furnishes the opportunity.

The most critical season to these plants is fast approaching. A very common error, especially in houses heated by smoke flues, is, to keep the temperature too high. Unless the house be heated by hot water, a temperature of 55° will do perfectly well. The absorbed property of heated bricks, in flues, is so great, that the excessive waterings necessary to replace the moisture they absorb is more injurious to the plants than a moderately low temperature. In a house heated by hot water, a temperature of 65° may be maintained with advantage. The house will be very

gay with *Habrothamnus*, *Cestrum*s, *Begonias*, *Pentas*, *Plumbagoes*, and so on, and the syringe must be kept in daily requisition. It is highly of advantage to put a little sulphur, lime water, or soft soap into the syringing water occasionally, as the red spider, mealy bug, or scale, respectively, may make their appearance; this, with a vigorous use of one's eyes and fingers at times will keep them pretty well in check. *Orchideæ*, those of them which bloom on finishing their growths, will begin to add considerably to the attractions of the hot-house. As any come into flower, they should have less water at each time, but be watered more frequently than they have been accustomed to: a very slight "dewing" with the syringe is all that is required. Heavy waterings and high temperature, together, destroy more orchids than many would dream of. Still atmospheric moisture must be retained for them in any case.

## COMMUNICATIONS.

### RECOLLECTIONS OF SOUTH AUSTRALIA, OCEANICA.

BY MR. W. T. HARDING, NONANTUM HILL NURSERY, BRIGHTON, MASS.

"Loud roar'd the dreadful thunder,  
The rain a deluge showers,  
The skies were rent asunder  
By lightning's vivid powers."

As the thirsty earth, so long dry and parched, was receiving its annual supply, for the rainy season had fairly set in, and all nature was freely imbibing and drinking to such a degree as to be literally "half seas over," for "the waters of the flood were upon the earth," and the river Torrens was madly rushing down to Spencer's Gulf to co-mingle with the mighty deep; many a weary mile had we traveled along the bed of the dried up river, and many a sweet flower, "so beautiful and fair," had we culled while passing through where now was a roaring, surging stream, coursing along with a fearful velocity, and carrying with it reck and *debris* of every kind. Unfortunately, your correspondent was on the wrong side of the stream, as was often the case with him, and could see no possible means of getting across, for in those days, away

from the settlements, bridges were few and far between.

The forest scenery was wild in the extreme, and more rugged and broken was the earth's surface than any we had previously passed over. Cheerless and uncomfortable indeed was our condition, as weary and wet we sought shelter and rest within the hollow of a huge old gum tree, *Eucalyptus resinifera*, which measured sixteen feet across, from side to side, and upwards of sixty feet high within. The shades of night were gathering gloomily around us as we entered our darkened chamber, glad to escape from the pitiless storm that raged so violently without. Such a day and such a night, I shall ever remember until life's last lingering hour.

Thoroughly wet to the skin, as all were, and overcome with fatigue, we huddled closely together, and were soon wandering in dreams.

We could not have slept long ere I was awakened by a fearful howl, which I fancied came from some part of the tree, and not far from where we had stretched ourselves to sleep, I felt somewhat startled for the moment, and between sleeping and waking, tried to persuade myself that it was only "the base fabric of

vision," or some imaginary echoes of dreamland, that had disturbed my slumbers; so tucking in my wet rug closer, endeavored to sleep again, but could not. The storm had suddenly abated, and as the moon peered through the scudding clouds like "a glimmering light in the east," "made darkness visible." Now fully awakened, so wet and chilly, with my extremities benumbed with cold, I tried to endure it as philosophically as possible until morning, while my companions seemed happily oblivious to all! "the ills that flesh is heir to," and soundly slept on. The light seemed to increase each moment as the moon's rays streamed in through the opening in the side of the tree, when I looked around and fancied I saw a most fearful looking object, like a human skeleton sitting before me, and with such fierce and sparkling eyes, set in a savage and wolf-like visage, fixed upon me. Cold chills crept over me as I looked at the "graveyard ghoul," and thought some strange hallucination possessed me; or was I demented, or was it some optical delusion, or what could it be or mean? for with all my short comings, and with my sins many times multiplied, what had I done to be viz-a-viz with such a ghastly spectre, and in "such a questionable shape," or why haunt a poor gardener like me? I changed my position to get a better sight of the object and satisfy myself as to whether it was "a spirit of health or goblin damned," when the wolf-like head moved from the skeleton shoulders, and showing its teeth, quick as a lightning flash darted by. Heavens defend us! I exclaimed, what can it mean? as I sprang to my feet, and stumbling over my sleeping companions awoke them, as I fled from the spot. Terror stricken as they were on awaking so abruptly from their quiet slumbers, to find themselves in so strange a place, and in such close companionship with a human skeleton, you may imagine how hastily they tumbled out "neck and crop" from the charnel house they had lodged in. I do not know whether my hair stood erect or not; but of this I am certain, that I felt a strange prickly sensation about the roots of my capillary covering as I sat down on the wet soil and breathed more freely again.

Dull, heavy, opaque looking clouds were rolling rapidly above and gave indications of an approaching storm, as the wind swept with hurricane gusts through the tree tops, which now and again broke down with a fearful crash, and disturbed the noisy parrots and screaming cocka-

toos, as with a yell, some frightened animal fled through the forest with that unerring instinct its creator had endowed it with, to the more open glades. Howl answered howl, which seemed to echo and re-echo again on all sides, as "the darkness covered the face of the earth," and the rain-drops began to patter against the trees. Flash after flash, and peal after peal reverberated in rapid succession as the "storm fiend" seem to revel in his carnival of destruction. O never to be forgotten night, when "deserted by the waning moon, and skies proclaim night's cheerless noon." The question seemed to apply to me so forcibly, "what art thou man, that thou art mindful of Him?" In terrible suspense the night was passed alone, exposed to all the fury of the storm, and not knowing where our companions were, but fearing the worst, anxiously looked for the morrow. The storm seemed to have spent its fury as daylight appeared, when our ears were gladdened with the welcome sounds of C-o-o-o o e-e-e-e, (an aboriginal call, which the whites imitated when hailing one another in the distance,) which was answered again and again, as our little band gathered, happy to meet again. "Watchman, what of the night?" was the enquiry of each other,

As hand grasped hand in friendship firm and true,  
And told of how he smelted the brimstone burning  
blue.

When through the tree the ghastly goblin flew,  
And yelled, I want you all, both him and you,  
Each Christian, Heathen, Turk and Jew.

Two of the party, with a serious gravity, solemnly declared they had both seen and heard the ghost several times during the night after they left the tree, and while the storm was raging in its wildest fury, the spectre of death had appeared, and beckoning with its skeleton arms, bid them to come.

Byron, somewhere, says "Fiction is strange, but truth is more strange," and incredulous as the story may seem to the strong-minded unbelievers in ghost or spectral apparitions, and I was one of them. I will here acknowledge that the experience I had so recently had, almost committed me to a belief in "Spiritualism." How could I doubt what I had so plainly seen and heard, and more especially so when corroborated by others, who saw the same supernatural visitor take of its head, when first seen, and as they rushed from its presence, roll its skull after them? Why, it was really wicked to doubt it. Ghost, spirit, hob-goblin, or whatever it might

be, I was completely non-plused with what I believed I had seen. Such a phantom, I have since thought, would make a good stock ghost or spectre for a spiritualists convention, and would have been a match for "the evil one," as pictured in the old editions of "Bunyan's Pilgrim's Progress."

There are those "who love darkness rather than light," and spirits, like bats and owls, naturally hide between sun-rise and sun-set. Tombstones and old sepulchral monuments were capital places for them to hide in during the daytime, we thought in our younger days.

The sun's beams were glistening through the dripping trees and gave light and warmth again to the world, so we proposed to settle the ghost question at once, by returning to the weird old gum tree, we so suddenly and summarily made our exit from, and with day in our favor, see for ourselves, and ascertain who or what his ghostship was. On nearing the spacious opening in the tree, at the entrance lay a veritable human skull we had stumbled over when we rushed out, and further in at the opposite side, the sad and sickening sight of "a skeleton form was mouldering there," in a sitting posture. Some poor creature had perished there years ago, unwept for, unloved, and alone. The bony structure remained much as the spirit had left it, (with the exception of the head and feet,) but was completely anatomised by the ants, which literally swarm in Australia.

Near by, lay an old pocket knife, closed, with the trade mark of a hammer, between two stars, over the word Sheffield, stamped in the blade, and a small pocket bible, which crumbled into dust when touched, and had no doubt been a comfort to him while resting in "the valley," ere he entered "the shadow of death." In a niche or recess, behind where the poor creature slept his last sleep, which time and decay had worn out in the tree, was the lair or nest of a dingo or native dog, in which snugly lay two fat little pups, which the mother was nursing when we intruded upon her, and as she crouched down with her head upon a level with, or rather where the human head had been, made up the "goblin grim" that had caused us such unnecessary alarm. The morning's meal was soon made, as hunger had sharpened our appetites, which we appeased with some grilled parrots, paroquets, cockatoos, and love birds, "And was not that a dainty dish to set before a King?" Yes, I will answer for you, and only fit for a

Kingly stomach, for I do not believe that any subject of royalty ever made a meal of any flesh more extremely better than cockatoo meat. And now, Mr. Editor, I venture to give you *one* word of "advice gratis." If you are ever invited to partake of any, *don't*. Shortly after we started in search of a ford, or some means of crossing the river, and found ourselves surrounded by acres, or miles more correctly speaking, of those abominable nuisances, the giant nettles, *Urtica gigas*, *U. ferox*, the latter a terrible pest, especially in New Zealand, and growing as dense as a cane brake; from thirty to forty feet high. With the nettles, and nearly as high, grew a pretty star work, bearing white flowers and silvery leaves. *Aster gyrophila*. Unyielding and unbending thickets of olive bushes, *Olea paniculata*, with numerous varieties of *Isopogon* and *Admanthos canata*, hedgehog bushes, or *Hakea echinata* and *H. acanthophyllum*, combined with *Banksia serrata*, to dispute our passage through, and sorely tortured us with their thorns and spines. Such a phlebotomising and botanising expedition, I should think seldom fell to the lot of any poor bewildered travelers before, as lacerated and torn we endeavored to find a way out. The thorn and nettle maze, however, terminated very abruptly, with a deep sand barren, which showed the course of the stream in its sinuous windings for some distance beyond. After walking several hours we entered the woods again, nearer to where the river poured out through a deep rocky gorge, the perpendicular sides of which were covered with the broom-like *Jacksonia scoparia*, and several kinds of pretty *Gompholobium*, of which *G. marginatum* and *G. venustum* were most abundant. Large clusters of the stagshorn fern, *Platycterium alceiorne*, seemed to luxuriate everywhere; upon the rock sides, on the trees, and the soil, and seemed able to live everywhere. Some fine and handsome *Stenocarpus Cunninghamii*, a beautiful foliaged evergreen, and in all respects a remarkable and singular tree; with a few specimens of *S. saliqua*, large patches of *Swainsonia galaxifolia*, *S. Grayana*, and the pretty *Tetratheca verticillata*, and *Trichinum alopecuroideum*, a very curious spotted flower, which appears to be covered with very fine hairs, or floss silk. Fringe myrtles, or *Verticordias*, *Zanthosia rotundifolia* and *Z. hirsuta*, *Mirabelia speciosa*, and *M. Baxterii*, grew as under brush, beneath the more stately forest trees. *Flindersia Australis*, or Australian Mahogany tree, was exceedingly fine in proportion, and of good ap-

pearance as an ornamental tree; their average girth was about thirty feet, and in height two hundred feet.

Calatree *enpressiformis*, a handsome conifer, was here and there scattered about. I consider it one of the most beautiful evergreen trees, with which the country is so well supplied. Serious as our case appeared but a short time before, we were fortunate in discovering a bridge, in the form of a mighty old gum tree, that lay stretched across the chasm. Rotten and decaying as it was, with the bark falling off in large pieces, we ventured one at a time, to cross over, and reach the other side, and "then praised the bridge that carried us safely over," and thought of the promise made. "He shall deliver thee in six troubles, yea in seven, there shall no evil touch thee." Our course was now made as direct as possible towards Adelaide City, the capital of South Australia. The heavy rains had made traveling disagreeable and fatiguing, and much of the way for some distance was submerged, and seemed more adapted for Saurians, or some such amphibious creatures to wallow in, than the poor half drowned bipeds, who floundered through it as best they could.

The nights were cold, and as we sat shivering in the fork of a tree, or stretched our weary limbs on some fallen trunk trying to sleep, or more frequently our "lodgings were on the cold ground," the heavenly arch was thickly studded with its celestial gems, radiant and brightly shone the constellations that form the "Southern Cross," and the face of "the sweet silver light bonny moon" seemed to look at us with the same old familiar features I remembered when a child, and pitied the poor man in it. Immutable old friend, there seemed to have been no change with thee, but how different was the case with me, since I first gazed at thy shining countenance?

Instinctively memory seemed to take me back to the "valley and the village church," and "the old house at home," so near to the churchyard, where the minds eye looking beneath the old Yew trees could see the long row of graves where my ancestors quietly slumbered for several centuries, and thought there could be no possibility of adding another little mound to the number, with the writer beneath, sick as I was, it seemed so unlikely then. As "many a cloudy morning, oft brings a shining day," and cheers us with the change, such was the effect it had upon us as the clouds unveiled the sun, and we

caught a glimpse of Mount Lofty looming in the distance, and but a few miles from Adelaide, where friends were anxiously awaiting our return. We observed *Acacia cultriformis*, *Delwynia cricæfolia*, and *D. floribunda*, two elegant little shrubs, with *Clerodendron costatum*, *Pandanus paniculata*, *Dracæna nutans*, *Crinum angustifolia*, *C. Australasicum*, *Beekea camphorata*, *Corypha Australis*, with the beautiful *Cela-carpus cynanus* in the back ground, produce the most charming effect in a mixed group, I ever saw promiscuously growing in a state of nature before. You, for one, would have admired the sight, familiar as you are with the subjects herein named. And what a pleasant meeting it would have been for all the good readers of the *Monthly* to have met their kind Editor there, on the other side of the globe, where "Flora" has so lavishly displayed her charms. Pleasant looking homesteads, good farms, orchards, well filled with fruit trees, and gardens ablaze with flowers, gave indications that we were nearing the end of our journey; and as we hastened onwards, arrived in time to see the novel sight of a rowing match take place, and "the annual regatta," sail along Hindley Street, in the City of Adelaide, South Australia, where for the present I must leave you.

#### HEATER FOR PLANT CASE.

BY "TEXIAN," LAVACA, TEXAS.

Below I send you an outline drawing of a heater for a plant case, which may prove useful to amateurs for the propagation or protection of plants. Your lady readers, especially, will like it as a means of experiment or recreation. Its cleanliness, easy management, and economy are its recommendations. The idea was first suggested by an invalid in an old number of the *Albany Cultivator*. But he used alcohol, which is too high priced for economy, and I believe my double boiler to be a great improvement. Petroleum lamp oil makes a powerful heater. I found a large sized burner attached to a plant case two and a half feet square, to heat the sand 100° Fahr. with a moderate flame, outside temperature was 50° Fahr.; had the wick been turned up higher, the heat would have been considerably increased. The lamp requires no attention for hours, when once the flame is properly regulated.

The boilers are set in the middle of the frame, and should be made of copper. The reservoir

should be made of that metal or zinc, as tin is soon rusted into holes. The bottom of the reservoir must be at least eighteen inches from the ground or floor, to allow room for the lamp and boilers beneath. The smoke flue should be perfectly tight, as the gases from the lamp are very injurious to plants. If used in the open air, it is necessary to protect the smoke flue and lamp from winds, else the flame will be blown out.

A is the lamp, made of tin or copper; 1 is the tube, 2 the thumb screw for regulating the wick, 3 a perforated ventilator, and 4 a deflector; all of these are purchased with a lamp burner, and with very little change can be attached to the heating lamp made of tin or copper.

B is a cylindrical enclosure around the flame, to prevent loss of heat. At 7 and 7 it can be attached to or disconnected from the boilers by

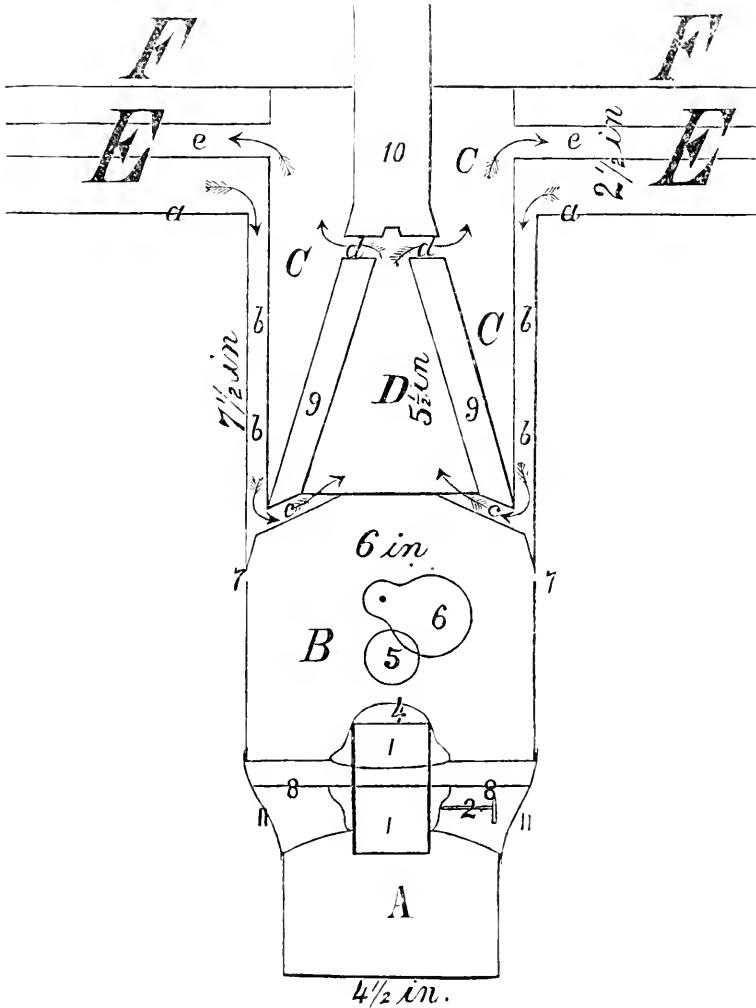

means of pins or rivets like a lantern bottom. 5 is an opening through which the lamp can be lighted or inspected at pleasure, and 6 is a flat button covering the same.

A and B are fastened permanently together by means of three narrow side braces, 11 and 11. Between A and B is a flat circular piece of sheet metal, (8 and 8) so closely fitting to the tube 1

that the flame cannot reach the lamp; above and below it, between A and B, is an open space, thus the lamp is kept cool, no matter how hot the flame. So many accidents have occurred from the use of coal oil, that I believe these precautions necessary.

C C C is a cylindrical boiler 6 inches in diameter, and 7 1/2 inches high; it is soldered water

tight to the bottom of the reservoir *E*, near the point *a*. The bottom of this boiler is not flat, but is shaped like an inverted funnel; this inclined surface is soldered to the outer wall, a half inch above the point 7, and reaches up towards 10, so as to form a part of the smoke flue; within it and a half inch distant, is

*D*, another boiler, shaped like a frustum of a cone, it is full 4 inches in diameter at the base, and  $5\frac{1}{2}$  inches high; at the top, a small cover is soldered on which hermetically seals it; at *c c* and *d d* are half inch tubes connecting it with the outer boiler *C* (it is more convenient to first solder *d d*, and afterwards *c c*). Between *C* and *D* is a circular space (9 and 9) which forms a part of the smoke flue.

*E* and *E* is the main reservoir of water, and is as wide and long as the plant case, and rests on the lower frame work of the same. It is lined with sheet metal, which is tacked to the sides of the plant case some 6 or 8 inches above the bottom. It should be supplied with water by means of a copper or zinc pipe, with an elbow reaching to the outside; a faucet in the bottom of boiler *C* is useful to draw off the water. By adding a kettle of hot water from the stove, time can be saved in heating.

*F* is the sand box or "bench;" the bottom of this should be of tongued and grooved boards, to prevent the sand from falling through and filling up the tubes and boilers. It can be supported by a rib of metal strongly soldered  $2\frac{1}{2}$  inches from the bottom of *E*, or by sheet metal supports,  $2\frac{1}{2}$  inches long, made fast by solder.

The flame strikes against the bottom of the boiler *D*, and spreading to every side, the heated air and smoke is carried off by the flue 9; in its ascent, it comes in contact with the inclined sides of the outer boiler *C*, and heats it also. The heated water in *D*, as it rises, is carried off by the tubes *d d*, and its place is supplied by pressure of heavier (colder) water through the tubes *c c*.

The heated water in *C* is carried off by the four long tubes *c c*, to the remote corners of the reservoir *E*, and its place is supplied by colder water descending in the circular space *b b b b*.

I should have explained that the circular space *b b b b* is formed by constructing loose cylinders, reaching from the top of *E* to the bottom of *C*, ( $8\frac{1}{2}$  inches) and  $\frac{1}{2}$  inch smaller than the outer boiler, with punched or notched openings at the base, and having the four tubes *c c* soldered into it near the top. If the water in

the reservoir could always be at the same height, these tubes should be very near the top; but as this is impracticable, they had better be near "low water mark."

### THE ENGLISH SPARROWS.

BY E. M., HARRISBURG, O.

I have been told lately, that in Brooklyn, N. Y., several years ago, that the park and street trees were so badly infested with worms, as almost to entirely defoliate the trees and render them disgusting objects, instead of objects of beauty and utility; and that the citizens sent to England and imported a quantity of the English Sparrows, and naturalized them in their grounds and along their streets, and that they have multiplied rapidly, and entirely rid their grounds of those disgusting pests. As I believe the Editor is a countryman of these birds, will you please to tell me and others interested, what you know of them, their habits, management, and how to best provide for them? whether they are in any way troublesome or not, and the good they would be likely to accomplish in orchards and ornamental grounds where insects abound? The time has come that we must avail ourselves of every available object for our relief from insects.

[It is true that the Parks in Brooklyn, and some in New York, have been cleared of insects, and this is true in a great degree of some of the Parks in Philadelphia, although here many of the few birds at first imported, wandered off into the country, and therefore the few left have not been numerous enough to do much. There is not the slightest doubt but that the English Sparrow is the most powerful antagonist these insects have yet met with. That is insects of the caterpillar kind. As for the curculio and those insects which chiefly work at night, the English Sparrow will not help you one bit against them. They will simply give you green trees, where you want nice summer shade—very nice matters for town and suburban gardens.

As for fruit and grain they are ravenous on them,—taking all they can get. They not only expect to be paid for the good they undoubtedly do in destroying insects, but wish to be their own judge and jury as to the compensation they are to receive.

On the whole, we favor the birds. We accept their assistance in our great battle with the insects, which are near over-matching our hor-



ticultural operations; and when the time comes for them to put on airs, as come it will, "a new departure" can much more easily be inaugurated for them than for other troublesome things.—ED.]

### NOTES ON THE SEASON.

BY A. HUIDEKOPER, MEADVILLE, PA

In Western Pennsylvania the season has been characterized by a warm and dry summer preceded by an unusually dry and warm spring. We had a pretty severe frost as late as the 30th of June and an early frost on the 8th of September. The result of the dryness and warmth has been that game and domestic birds have raised their broods with success, and farm products, with the exception of the apple crop, have generally been good in quantity and fair in quality; potatoes especially have been large and sound, and the yield abundant.

On our hill orchards we get a good crop of peaches about once in three years. Our farmers will do better when for their late ripening seedling they substitute Early York and Old Mixon, if the borer be kept off, can be relied on under ordinary circumstances for twelve or fifteen years of productiveness.

The pear crop, in proportion to the number of trees, has this year, I think, been better than the apple crop, and the fruit fair and satisfactory. After several years of exemption, I note on my own trees two cases of blight. The one very slight on a Bloodgood tree growing in sod, and a somewhat worse case on a Belle Lucrative tree under high culture on well drained ground. The last named tree made a very luxuriant growth last season, notwithstanding it bore a full crop of fruit. Theorists may draw their own conclusions, but to me the frozen sap theory seems the most probable explanation of the evil.

Grapes—when wild vines are reported as found in Vermont and Mississippi measuring a foot or more in diameter, some persons imagine that such size is the result of centuries of development. To show how rapid may be the growth of a vine, I may mention that about thirty years ago I planted a vine of the variety known as "Franklin" to run on my porch. When set out it was small, about half an inch in diameter, and to day it measures nineteen inches in circumference. I reluctantly sacrifice it this fall, giving a Delaware vine its place, on the same principle that a plank road or a turnpike is made to give way in the progress of events to a railroad. In

my grapery last fall I had the surface soil changed to the depth of about four inches, and the good effects have been quite marked. With watering and shade, soil in a vinery seems to lose its life. When removed and exposed for a winter, it re-acquires it, and forms good material for dressing flower beds. Of the foreign grapes it seems hardly worth while to grow any longer Sweetwaters and Chasselas grapes, when from the newer varieties we can get such superb looking fruit with little or no sacrifice in its quality.

Every berry of the Buckland Sweetwater this year with me has been of a fine amber color, and the bunches though not very large, perfect in shape, the fruit being luscious and sweet. The Golden Hamburg has produced larger clusters and larger berries, many of the latter an inch or more in diameter. The fruit has less substance to it than Buckland, but when the berries are "golden" I do not find it deficient in sweetness or flavor. It is, however, a poor grape to keep after maturity, and I look forward to the later novelty, the Golden Champion, as likely to supplant it, if the latter equals the reports we get of it from abroad, Muscat Hamburg.—This grape like the Troveron has behind its sweetness a base of acidity. It hangs well and dries into raisins. It fertilizes a full compliment of berries, but uneven in size, like the Muscat of Alexandria, the principal fruit stems of the two varieties being much alike. I think it would be improved by artificial impregnation. A branch of this variety interlocked itself this year in my vinery with those of a Black Hamburg. On this branch I noticed the fruit was much finer than on the rest of the vine. The clusters weighed about a pound and a quarter each and the berries were all large, uniform in size, and ripened more uniformly than those situated differently.

Of out-door grapes, the Delaware this year takes the lead, ripening the middle of September Israella, Christine, Miles, and some other early Isabella varieties are eatable now, while Maxatawney lacks a week or two of maturity.

I see that the "Department of Agriculture" does us the favor in vol. for 1869 to classify many of the varieties of grapes now in the catalogues. It may be an interesting question to ask, Do grapes ever change in their seedlings from one variety to another? We know, to begin with, that the seedling fruit is often quite different both in color and quality from that of the parent vine. Then we have natural and artificial hybrids and seedlings from these instead of

producing a new class revert back to that of one of the parents

To fortify my question, before some critic attacks, permit me to refer to the note in Downing's large edition on "Sheppard's Delaware," which the author reports as raised in 1853, from a seed of the Catawba, the *vine* and fruit being similar in all respects to the Delaware. Mr. G. W. Campbell, at page 81, of *Gardener's Monthly*, vol. 1871, speaks of a Delaware Seedling with thick, heavy foliage and a strong habit of growth. This looks a little as though the thin leaved *res-tivalis* and the robust *labrusca* had a tendency to overleap family boundaries.

Next year, if living, I hope to report on some of the English and French novelties. Do you know any cultivator in this country who has the *Fintindo*? I should like to get it.

---

#### NEW BULBS.

BY WALTER ELDER, PHILADELPHIA.

Your readers will likely observe, by the advertising columns of the *Monthly* that our seedsmen and nurserymen have got their importations of flowering bulbs, from north Europe, consisting of Crocus, Hyacinth, Tulip, Narcissus, Snowdrops, Lily, Crown Imperial, &c., besides all the choice species for growing in glasshouses. We have received the catalogues of our leading dealers in this country and Europe, from all of which, we learn that last summer was very favorable for the maturing of the bulbs, and that large numbers of new and superior varieties of every species are sent out this year for the first time, and as many of the old inferior varieties have been discarded. Purchasers, we think, may rely upon getting sound bulbs and choice varieties.

Among the wonders in bulb culture, are the Golden Lily of Japan (*Lilium auratum*), I have seen it in its full prime the past two summers in Dreer's collections. Many of the bulbs bore six blooms, nine inches in diameter and very fragrant. Thos. J. Mackenzie, exotic florist of Philadelphia, has the *Lilium tigrinum flore pleno* or the double tigerlily, of large size and splendid appearance. Louis Van Houtte, of Ghent, acquaints us of the new lily, *Lilium tigrinum splendens Leopoldii*, which has produced a great excitement in Europe by the great size and dazzling colors and superb markings of the blooms. His new varieties of *Amaryllis* are most splendid and have won many prizes in Europe the past two years.

#### THE BEECH TREES OF HOLLAND.

BY J. N. L., PHILADELPHIA.

I believe the following, by a correspondent of the Philadelphia *Press*, "Letters from an Architect in Europe" would have an interest for the readers of the *Monthly*:

"Just before I reached the double row of houses which mainly form the village of Zeist, I saw on my right hand an iron gateway, and beyond that gateway the finest *tree lined lane*, without exception, that I have any recollection of. The trees were tall beeches, from eighteen to twenty feet apart, and extending back from the road perhaps rather more than a furlong. There was a path about eight feet wide, grass on either side of it, and the whole so completely hedged in by smaller trees and shrubbery that no direct light was admitted. Probably you have never seen a forest entirely of beeches. Such forests are common here, and when grass is kept growing under them the effect is most wonderful. The first sight I had of a beech forest, which was at Haarlem, was really enrapturing, notwithstanding it was on a cloudy day. Now this lane that I tell you of was all filled with a diffused green light, filtered through the several strata of pale green leaves, and producing an exquisite gossamery effect that sent a sudden thrill of joy and sweet surprise to the delighted eye.

What cathedral builder more triumphant in results than is the man who takes such straight saplings as once these were, carefully plants them in extended rows on level ground, and as heedfully waits upon them year after year, until they shall have attained that strength and vigor that their future course and perfect uprightness is assured. What cathedral builder has found stone for his columns, for his walls and grained ceiling, so satisfying to the eye and free from imitation to the sight, so perfectly pleasing in fact, as he who lined this lane with beech trunks. And where the glass stainer that has filled the stone cathedral with such a spiritual glow as comes through this fibrous greenness.

---

#### DESTRUCTION OF THE POTATO BEETLE.

BY "RURAL PASTOR," EANVILLE, ILLS.

Allow a little criticism with regard to your article on the "Destruction of the Potato Beetle," in your July number. You recommend rolling,

but the process would be like trying to flatten bullets by rolling them in a bed of ashes. The heaviest roller would not crush them on plowed ground. I have often tried to kill them with my foot, but unless the ground is very hard they would bed into it and then soon come up again for their work. I have watched their habits closely in three different States, and as they will soon be upon you, a few remarks may not be out of place: for if you are as ready to receive them as we now are, they need not be greatly dreaded after all. They love some kinds much better than others, as for instance they prefer the Early York to the Early Rose, and will leave the Peach Blow till the last.

*Plant early* and you can give your potatoes a good start before the bugs get over their spring stupor.

*Plant early kinds* for there are three distinct crops of bugs, and generally they come in countless numbers to take the latest kinds.

*Hand pick*, if not very bad. See if there are many of the lady bug or lady bird as it is sometimes called. If they are plenty, they will take care of your potatoes for you. They are a little red bug with dark spots, and eat their eggs most voraciously. If necessary to use other means, take *one pound of Paris Green to thirty pounds of common plaster and mix thoroughly*, and apply when the dew is on, and you will slaughter them by hundreds of thousands. The plaster is good for your potatoes and you don't get green enough to hurt anything. Apply as often as the vines need it, and you need have no fears as to the result. I have saved acres of potatoes this summer by recommending this plan in our village paper. When the bugs come, plant as *little ground as possible*, enrich it highly and use ashes and salt to counteract any tendency to rot, and then you may laugh at the "destruction which wasteth at noonday."

---

#### LETTER FROM ROCHESTER.

I am not much given to writing, except in a business way, but, while sending my subscription for the new year to the publishers, take the occasion to say a good word to the Editor in praise of the good work the magazine is doing in the way of increasing the taste for gardening. It pains me to hear agent after agent, as they come in, complain that the people they travel among care little for the beauties of this world—that so long as they can get a potato or cabbage

for dinner, or an apple to make "sass" to eat with their bread, the people generally care for nothing else.

How to me these people seem like the beast which perisheth! Give it its belly full, and a little mire to wallow in, and it will go through the world of no use but for the fat which it leaves behind it. So these people scrimp and screw, and lay by their money, making no home beautiful, exciting no intellectual culture or elevated aspirations amongst their sons and daughters; and they die, leaving hundreds of dollars to be wasted by the piggish brood they have brought up.

I often think if these people, who see no good in plants, trees or flowers, who have no aspirations beyond something to eat or something to sell, had a hand in the making of this world, what a miserable, dreary place it would be! And when I drive through the country, and see here and there one or two pretty places, which, perhaps, some loving woman's hand has made a paradise, in spite of her lord's growling about the money it costs, I thank heaven that, though woman was the means of the thorns and thistles of life springing up for us, she is yet left to bring more than paradise to us when she can have her way.

And you, good friend Editor, long may you live to help her, and to encourage those of the sterner sex to look on these things in a more rational light. And perhaps I may say a word to my brother nurserymen, many of whom do not exhibit so much the spirit of taste and culture which they might do. They have the material at hand, at little cost, and they might, by a very little display of gardening about them, set an example which would spread about them. I am pleased to know that, of late years, there is much improvement in this respect.

Thirty years ago, a hoggish looking hole would be called a nursery—perhaps merely because trees were sold from the spot; but such relics of the barbarous past are dying away with the stage coaches and other incidents of the last generation, happily to be replaced by better things.

But I find that I have written on farther than I intended, and will conclude with best wishes for the continued prosperity of the magazine.

[We are not sure that this was intended for publication; but the sentiments are too good for our private ears alone.—ED.]

## IMPROVEMENT IN SEEDLING PEACHES.

BY MR. LORIN BLODGETT, PHILADA.

I have been interested by finding two recent crops of seedling Peach trees, grown in my garden, develop some qualities that lead me to hope for good autumn peaches at some early day, in place of the few and poor ones now to be found. And I have put some *average specimens*, both of size and crowded growth, on the tables at the Exhibition, not as attractions, but as illustrations.

My first production was a year ago, and this year I have three or four trees, bearing five to eight bushels each, of October peaches, yet so very soft and delicate, when fully ripe, as to be properly characterized as melting peaches. They are small—the worst fault they have—but perfectly sweet, and perfectly melting in flesh. Two are white fleshed, one yellow, but all freestones, and all characterized by a singularly slender twig, small leaf, and small branches, with a remarkable crowding of blossoms and of perfect fruit. I never saw such abundant and persistent bearing, nor so many peaches ripening perfectly on a tree.

My friend, Dr. Emerson, pronounced them descendants of a class known formerly here as "Willow peaches," which were good, but small in fruit, very great bearers, late in ripening, and tender in flesh as these. It is a peculiarity of all of them that, when fully ripe, the skin will peel off with the greatest ease from the whole peach. And the "Willow" peach was also, he says, remarkable for following close to the parent in all seedlings grown from it.

I really think some good cultivator might get us good autumn peaches from this "Willow" stock. A little larger, firmer and brighter in color is all the change desired. The productiveness, absence of acidity, and perfect tenderness cannot be excelled, as I hope to prove by specimens sent you as soon as they perfectly ripen.—*Sept. 12th.*

Since the above we have received from Mr. B., under date of Sept. 26th, the following:—

I have for many years felt an interest in growing seedling peaches, and some years ago got some very early peaches, in a colder climate, but I had no expectations of succeeding here, where October peaches are usually so unpromising, as well as so scarce. But I have, this year, some 25 trees bearing, most of them for the first time,

—a few bore last year, and I send you a few specimens as illustrations.

I am not certain that any one of them is worth propagating as a market peach, but two or three are singularly valuable for any use—the most delicate, digestible, prolific and thoroughly excellent for dessert peaches that I have ever found. They are too small and too soft for market purposes; but it is singular to what an extent the prolific element is apparent, all being loaded with fruit, and all the larger ones are very superior for putting up in any form.

My friend, Dr. Emerson, recognizes a class in them called the "Willow" peach, a persistent if not indigenous peach, said to come nearly true from seed. Nos. 5, 6, 12 and 14, are of this class. Nos. 5 and 14 being exactly alike, and all having very slender twigs, pendant "ropes" of fruit, small leaves, &c.

I only send you these to give some proof that attention to seedlings may yet give us good peaches from September 15th to the last of October—the season in which our peach market is almost wholly bare of good peaches. The "Garden peach" is one that has been developed for this season; and on my first trial I have got six or seven trees (out of 30) that I would not spare on any consideration. From the time the market supply ceased, say the middle of September, I have had a great surplus, and shall have until November 1st, and all from not over twenty trees.

A few of the numbers that I do not enclose, as Nos. 12, 13, 15, 18, 19 and 20, are mere duplicates of what I send—12 being a white, melting peach, gone a week ago; 13 and 15 white clingstones, not ripe; and 18 and 19 large white clingstone, ripe and gone. About five only were absolutely worthless.

[The peaches sent were mostly of the highest excellence. The result is truly remarkable. Well as we know that any can get good fruit by a little care in the selection of seedlings, we had no idea that there was room for so much superiority. Some of these we think superior to the best of our late ones now grown; and we hope, another year, Mr. Blodgett will select one of the best to name and distribute.—ED.]

## NOTES ON SOME TEXAS GRAPES.

BY PROF. BUCKLEY.

By to-day's mail, I send you specimens of *Vitis rupestris* Schult., and of my *V. montana*.

The last has its fruit now ripe, but I cannot send it to you retaining its characteristics. The berries are from one-half to three-quarters of an inch in diameter; black, skin very thin, pulp juicy, slightly acid, tinged with red; racemes three to five inches long—generally about three; shouldered, berries thickly placed, yet not too much crowded.

The racemes of *rupestris* as it fruited here this summer are about three inches long, berries densely crowded. They did not arrive at maturity. You can see from the leaves that the two grapes are very distinct; the leaves of the mountain grapes being more like those of the Mustang, yet they are not so densely tomentose beneath as the new berry. Those of Montana I think become more pubescent with age. I have both of these grapes in cultivation, and intend that others shall also cultivate them, that the proof may be certain and admitted by all, that *V. montana* is a good species.

I shall also prove that the Post-Oak grape (*V. Lencuceumii*) is very distinct from the *Labrusca*. I am inclined to believe that the *Isabella* was derived from the Post-Oak grape. Its whole fructification is very distinct from the *Labrusca*. Dr. McRee, an old botanist of Wilmington, North Carolina, told me that the gardener of the Gibbs family (from whom the *Isabella* is said to have originated), told him that the *Isabella* was not a seedling found in the Carolinas, as has been represented, but that it was obtained from the French or Spanish of Louisiana or the West Indies. I write from memory. I published an account of it in the *Horticulturist* of 1858 or 1859, when J. Jay Smith edited it.

I know that few if any of our Northern botanists or fruit-growers will admit this, but time will determine the truth, and all will acknowledge that the Post-Oak is a very distinct species, as everybody does in Texas.

[It is clear that histories were too readily made up in the past time. Scientific men, accustomed to a rigid and strict examination of facts, are too apt to believe that the rest of mankind are like themselves. Hence they take up too readily statements of other people who have either deceived themselves or been deceived by others. In regard to the history of grapes we are all familiar with tales which have been subsequently found incorrect, and we have little doubt about the correctness of Mr. Buck-

ley's investigations in regard to the origin of the *Isabella* grape.

In Dr. Asa Gray's excellent "Manual of Botany," so usually strict in its facts and statements that it will long live as a monument of striking accuracy, yet appears the statement that the Scuppernon or Muscadine grape is the *parent of the Catawba*. Surely some one must have misinformed the good Doctor here.

As to the new Texas species of grape, it is likely the characters are as good as many often employed, but the time will probably come when the facts of variations are better understood, when but two or three species will be recognized for the whole American continent. They vary like blackberries. Ed.]

### HOT WATER CIRCULATION.

BY A. L. PENNOCK, PHILA.

In the August *Monthly*, Mr. Hitchings' remarks seem to require an explanation of my article in the June number.

The figures taken by me, 212° for the flow and 80° for the return, were merely given to illustrate my argument. I also did not intend to say that 43° difference was necessary to create circulation, although there was that difference in the tank experiment. When a boiler is first fired up, we always expect a cold return-pipe, unless something is wrong in the circulation. After the water becomes well heated and in full motion, the return pipe is much warmer, and much less difference in the temperature is required to keep up a circulation. A ball rolling down a hill will continue the same speed, although the descent is but slight towards the bottom. The area of the cross section of the tank was many times greater than the connecting pipes, as Mr. Hitchings supposes, but probably the speed of the current was properly represented by the chip, for in no case did it touch the side of the tank.

My idea is that the greater the difference of temperature between the flow and return, everything else being the same, the more rapid is the circulation. The current may be impeded by great length of pipe or in various ways, but let those hindrances be the same in each case, and the speed will be the greatest with the greatest difference in the temperature of the flow and return; and certainly if the water has lost the most heat, the house has received it. I believe accurate experiments will sustain this view.

I fully agree with Mr. Hitchings, that the secondary heat should be used both for economy and safety. I have known two green-houses burned down, supposed to be by the heat after passing through the boiler, and I have taken down the boiler where the wood-work was charred ten feet from it, but I cannot agree with him when he talks about 300 or 350 degrees escaping after the secondary heat is used. My experience is, that no such waste of heat is necessary.

#### SPORTS IN VEGETATION.

BY MR. A. FENDLER, ST. LOUIS, MO.

Last summer I met with some remarkable sports in vegetation. On several stalks of Indian corn in my field, I found the tassel or male flower bear the grain. The ear which ordinarily develops laterally was wanting, but was represented by the central spike of the male flower; the lateral spikelets of the latter also had grains on them, though more scattered.

Several plants of the commonly cultivated climbing rose being rather in my way, I pruned them several times very severely during spring and early part of summer. In consequence of this pruning, as I suppose, they produced roses of a small size, still double, but having the outer petals of a lively green, and the more central ones of a white color, instead of their natural red color. *Tecoma grandiflora* I tried to raise from seeds, but got only one plant that came up to the original in regard to size and shape of flower. All the rest of the seedlings resembled very much our *Tecoma radicans* of the woods. A similar experience I had with plants raised from seeds of the large-flowered Lilac (Charles X.), only one of the seedlings producing very large flowers. Three plants of

*Yucca angustifolia*, which I raised from seeds, proved each of them to be twins, indicating two separate embryos under one seed-covering, the same as you had occasion to observe in the Osage Orange.

[The writer noticed this year ears of corn which had developed in the usual way, but were on large stalks, which had from four to six nodes or joints, instead of being set down (sessile) on the stalk as in the usual way. The occurrence of grains along the male raceme is not at all uncommon; but the lesson it teaches is not often thought of. It is that there is nothing organically distinct—primarily speaking—between the female and male flowers; but that in the early stages of the flower's existence it is so constituted that by subsequent laws it may be converted into either sex. What is known as Meehan's Theory (see *Proceedings of American Association*), attributes this to varying powers of nutrition,—the most favorably nourished germ becoming a female flower.

It has been supposed that the *Tecoma* or *Bignonia grandiflora* of Japan, is but a variety of *S. radicans*. Mr. Fendler's note shows they are essentially the same.

Dr. Engelman has recently called the writer's attention to the fact that in a German scientific work a figure of an *Euphorbiaceous* plant exists in which the two embryos under one testaceous envelope had inarched together as noted in the Osage Orange referred to. A multiplication of embryos appears to have been noticed some time back in the orange family (*aurantiaceous plants*), and by the writer recently in oaks and peach kernels, but the inarching together of the two developing germs does not seem to be so common.—ED.]

## EDITORIAL.

### RECOLLECTIONS OF TRAVEL.

By the kind courtesy of the officers of the Louisville and Nashville Railroad, we were taken over one of the most beautiful regions of country it is possible to conceive of. Wooded hills and deep ravines, bold rocks and the beautiful contrasts of occasional level bays of land; tortuous windings, and then magnificent views of bold expanses,—these and many more fol-

lowed each other in such rapid succession that the ever-changing variety so much dwelt on by the landscape gardener as the especial prerogative of his art, was here ready-made to hand. The varied sensations of the beholder are no less striking than the scenes themselves. Now the railroad carries us along the surface of a rocky ledge, from whence, like some superior race of beings, we can look down on less fa-

vored mortals below, and again we come to the base of some elevated site on which, like humble suppliants for mercy, we look up in awe. The Mammoth Cave was our destination. That is a curiosity; and for the merely curious, a rare and wonderful sight; but to us a sacrifice of a hundred miles of travel in these subterrestrial regions would be cheap in exchange for a half-hour glimpse of this never-to-be-forgotten railroad ride.

It was the wonder of some of our Eastern friends that man had not made more of a country so beautiful and so grand as this. The soil was not so very rich, to be sure—thousands of acres in the West were worth double in productiveness to any of these. But then look at the rocky hills of Massachusetts and see what has been made of them there! Why, even the fruit trees have been made to feel so much at home that they seem as if almost to prefer rock to the mellowest of soils! You need do little more than blow out a hole in the solid granite with gunpowder, and fill in the chunks about the tree roots, and lo and behold! the fruits there! Why could not these people do better than they did? Here the grapes grow wild on the forest hills, and apples were so abundant as to be offered at twenty-five cents per bushel. Why were not the people improving these advantages? Why instead were crowds getting in at almost every railroad station, off for some barbaque or festival, or passing away their time in picnics or frolicing, as we saw them from the cars in almost every dale or hill? It seemed a hopeless puzzle to Northern eyes, as no doubt do the peculiar phases of Northern society to Southern ones; but it seemed to us that a good principle underlied all this apparent extravagance, and which, when properly directed and cultivated, would redound to the good of gardening and to the encouragement of those arts and sciences on which gardening so much depends. The Northern type of civilization tends to make one battle strongly with the elements and with all its surroundings. The great struggle for life individualizes the man, and leads him to look on everything from his own personal standpoint. Society in a great measure loses its charms, and it is seldom until he has achieved wealth that he seeks a very large circle to share his joys or sorrows with. To him one place is nearly as good as another,—wherever his personal ends can be served, that world is his home.

It requires no stretch of imagination to un-

derstand how fatal this tendency is to gardening. One may sell his home to-morrow. Why beautify and adorn what other eyes may feast on? Flowers and fine gardens depend for much of their enjoyment on the visits of friends who can share the pleasures with us. But if we have no friends why fix the garden?

But in the Southern man the local feeling predominates. You may live with a Northern man a year without ever knowing what State bore him, or who were his neighbors or his people; but the Southern man takes pride in his State, in his neighbors, his home and his lands. He will starve on one hundred acres rather than sell fifty and be rich on the balance. His neighbors' affairs interest him, and he feels simply as one of a large circle of acquaintances and friends. Of course this type of civilization has its weaknesses as well as that of its fellow-type of the North; at the same time it has its good points; and we could not fail to admire and appreciate them. With a little more of self on one side of the line, and a little more of the social feeling on the other, we should feel we were in the very centre of the finest field for true gardening culture and refinement.

The vegetation of this part of Kentucky is not as luxuriant as that of many other sections of the State, and yet the timber of the worst part of it, that in which the great caves are situated, and which is called Barren county, is by no means poor, and does not seem at all worthy of its county name. Oak and hickory of considerable size abound, and the Helianthums, Asters and Eupatoriums of the woods are as luxuriant as can be anywhere seen. Many beautiful flowers well worthy of garden culture abound. Amongst these was seen for the first time in bloom the northern representative of the Century plant,—*Agave Virginica*. This plant is a nearly ally of the *Tuberosa*, and the flowers possess a fragrance as delicate, but not so strong. They are greenish white, with very pure white anthers—not particularly conspicuous, but quite as worthy of admiration as the *Mignonette* or other sweet but inconspicuous flowering plants. Here also was the *Coccoloba Carolinensis*, a vine of the *Smilax* family, but covered in autumn with long racemes of scarlet berries, equal to the *Holly* in brilliancy and beauty. There appears, however, to be two sexes of this, and, as only one will bear berries, one may have to get two plants to get the satisfaction desired.

The most charming sight in this section of the country is *Andromeda arborea*, which was then in full bloom. We have no hesitation in saying, that as they were here seen, there is no white flowering plant which can equal it in graceful beauty. In some open places near the Diamond Cave they formed pyramids of from ten to twenty feet high, and the long slender racemes of flowers covered the whole bush from the apex to the ground. These racemes are about *eighteen inches long*, first rounded over downwards in a regular curve, and then turn upwards again when about two-thirds of their length has been reached. The plant is in cultivation in some nurseries, but has not yet found its way into general demand.

It is interesting to note how some things seem to improve by culture, while others seem to deteriorate. In regard to this *Andromeda*, it seems strange that in the many years of our acquaintance with this plant in gardens, we should never have been struck with its great beauty. On the other hand, in these deep woods and steep hill-sides were thousands of the Red snowberry, *Symphoricarpos racemosus*, not one of which but had a sort of mangy, disagreeable appearance; and yet as we grow it, it is one of the best things we have.

Our view of sixteen miles under ground, over rocks and stones of mammoth size, and sailing over lakes squatting in the slush of a mudscow under ground in the big cave, did not add much to our knowledge of gardening or the natural sciences; while the unfortunate result was to blister the feet and stiffen the joints of the whole party, so that at daylight on the morrow, when our agricultural, botanical and scientific excursion was to start for a ten-mile excursion on foot, only Mr. W. M. Canby and the writer were ready for the march. The breakfast which we had paid for over night at the Great Cave Hotel was also *non est*,—and the sleepers who had paid \$4 per day for the glorious privilege of snoring on the ball-room floor, had not awakened. Thus it was that “two solitary travelers” might have been seen one fine morning in August, wandering alone through the woods in the mountains of Kentucky. That morning was hot and dry, and so were the travelers; for with water in barrels at twenty-five cents per glass, and all the rest of the water underground, there was no opportunity to indulge in even those creature comforts usually so cheering to the wild-wood rambler. But for

all, we question whether there were two happier beings in the whole State than the couple aforesaid, and long will that day's excursion be remembered.

We have said that there was no scientific interest in the Cave, but yet it was not wholly so. We had been taught that the inhabitants of these caves were eyeless, *because* they had no use for eyes. It may be that some things in caves have no eyes, but our ardent young entomologist, C. M. Dodge, can testify to the fact that it was as hard work to catch his cave grasshopper as it would be to catch the common grasshopper above ground. These little colorless, spidery-looking things were ever on the alert to get out of the way at the first effort of the hand to go down on them. Again, the writer while sagely scanning the floor of the mudscow in order to find a rib whereon to place his boot, and thus endeavor to keep the slush from running in, fancied he saw an eyeless fish in the lake outside. A half dozen lamps were soon directed to the spot. It proved to be a crustacean, and it was interesting to note how it went from one side to the other on the sandy shore as the lamp was directed towards him. His lobster-ship was finally bottled in alcohol, and it will be for the zoologists of the Philadelphia Academy of Natural Sciences to decide finally whether those eyes are really good for anything, or whether our own eyes on that occasion deceived us.

#### RARE TREES.

MR. A. D. BROWN'S—FORMERLY R. S. FIELDS'S,  
PRINCETON, N. J.

It is one of the best features, perhaps, of American institutions, that land ceases to remain for a long time in the possession of one family; but for all this it is disastrous very often to gardening. The labors of a life-time which, under European auspices, would continue to give pleasure and profit to thousands, are here often swept wholly away in a single year. It is therefore with double pleasure that we find an American place to change hands, and the new proprietor continuing on the good work began by his predecessor.

One of these fortunate changes is the passing of the property of the late R. S. Fields, Esq., of Princeton, N. J., into the hands of Mr. A. D. Brown. The excellent specimens of rare trees and shrubs which made this place so famous, have in this gentleman found a worthy



lover, and one whose cultivated taste will still add to the renown of this celebrated place. So many errors have been found in regard to the trees really growing here—many reported as “doing well” or “not doing well,” which certainly were never growing here, that the public had come to believe that much less exists than really does, and it gave the writer much pleasure to spend a few hours there recently, and to note how really rich the collection is. Some have now reached a size sufficient to judge of what their final effects in the landscape will be. It was particularly pleasing to note how well the *Libocedrus decurrens* maintains its character for great beauty when grown up. Its rich dark-green fern-like fronds give the tree a richness which no other similar plant possesses. *Cupressus Lawsoniana* exhibits a tendency to get thin at the base, but its slender flexuose habit is very pleasing. *Thujaopsis borealis*, as it grows very large, seems inclined to have a graceful habit in striking contrast with its full, dense, massive appearance when young. It approaches in this respect the Lawson cypress. We are inclined to place this second in value to the *Libocedrus decurrens*. There is but one large specimen of *Thuja gigantea* here, but it is very much in appearance like the common American, except that it has broader fronds and a more regular and more vigorous habit, and perhaps a livelier green. There is a beautiful *Retinispora* here which was not recognized. The branches droop and are cord-like as in *Biota pendula*, and which will, we think, be more desirable than that. There are several very large specimens of the weeping arborvitæ here; but they are too brown and dingy to be very attractive. Some fine specimens of *Retinispora pisifera aurea*, and of *R. obtusa* show how grandly they will serve as ornaments in our choicest grounds. *Retinispora obtusa* especially ought to be as common as the Siberian arborvitæ. It is an exquisitely beautiful plant of the arborvitæ family. In the *Picea* or Fir family, are some very handsome specimens of *P. Nordmanniana*, which is undoubtedly the finest of the whole family. Its heavy dark green and shining masses of foliage render it strikingly conspicuous, and Mr. Brown well remarked that when its golden growth was pushing in the spring nothing could possibly be more beautiful. *Picea pichta*, with its light sea green, is also very attractive, though hardly so full at the base as the Nordmann Silver Fir. The *P. pin-*

*sapo* here is a lovely specimen; as also is the Cephalonian *P. Cephalonica*. The common Balsam Fir, which so often gets poor when it gets old, has here clothed itself with regal purple, so to speak. If ever it exhibited majestic proportions it is truly here. The *Piceas grandis, nobilis*, and one which seems to be *Parsonsiana*, are smaller than the rest, but give promise of great success as beautiful trees. Amongst the rare spruces are several *Morindas*, a beautiful Oriental and an *Abies Williamsonii*, about four feet high. This is more robust than our common Hemlock, and has downy shoots. This is yet too small to show its final character. *A. Douglassii* does pretty well.

The Pine family does not seem to have been a favorite with Mr. Field, or else they have disappeared after planting. There are very few of the rarer ones about. There is a plant about four feet high, of the *Pinus Fremontiana* or *monacantha*, and which some botanists have supposed to be the same as *P. edulis*, the *Pin-yon* of New Mexico; but there is something different in the general aspect of this specimen from the *P. edulis* as recently seen by the writer in the Rocky Mountains, and we should not be surprised if it does not yet turn out to have as good specific characters as *P. ponderosa* or *P. taeda* have from *P. rigida*, which after all is not much. There is here a large tree of the Austrian Pine, which has very slender cones, not more than an inch thick and about three inches long. Mr. Brown should send it to England and get it described as a new species. There is also a magnificent row of white Pines about thirty years old, branched nearly to the ground, and perhaps fifty feet high. There has been some prejudice against the white Pine, on the ground that the snow breaks the branches in winter; but this must be only when enervated in some way. These sturdy fellows will stand the battle and the breeze from the most hostile elements of nature. There are several very large *Pinus excelsa* here, with keen silvery-like foliage, which every one who sees admires.

The *Yew* family is beautifully represented. Handsomer specimens of *Taxus baccata* we have never seen. The plants were densely studded with coral berries, which were well relieved by dark green foliage about them. The yellow-berried variety was strikingly well favored. It is hard to concede to this greater beauty than to the common Red one, but the writer is almost persuaded to think about this as Mr.

Brown does. There are many handsomer specimens of the Yellow, Irish, *erecta*, Short-leaved, American, and others, all distinct enough to rank as species, as Mr. Darwin would say, only that we happen to know the parents from which they sprung. Indeed, the philosophers have brought things to this, that a "species" is to be defined as a variety of whose origin we are ignorant, while "variety" is a variety whose history we know. We must not overlook to notice in the Yew family *Torreya myristica*, the California Nutmeg, about five feet high, and the two *Cephalotaxus*—*C. Fortunei* and *C. drupacea*. The last is very well named, for the plants here are covered by pleasant tasting drupes, about the size and appearance of copper-plums. It has been supposed that *C. Fortunei* is but a male form of the latter, and the plants here give color to this, for it has never produced any fruit, though covered with male buds; but there appears to be indications of male flowers among the female—a point which Mr. Brown will watch and decide another year.

Among the Junipers are some very fine specimens of *Juniperus oblonga pendula*, and some of the trailing alpine forms, some of which have spread over many scores of square feet, forming circles of great beauty.

There are many other species here, of which

more can be said in future years; but all these we have named have proved themselves of permanent value, and ought to enter at once into the regular trade-stock of our leading nurseries.

It must be borne in mind, however, that Mr. Field, in laying out his grounds, used large numbers of common Deciduous and Evergreen trees in the regular way of landscape gardening. These have grown up, and make a *good protection from wind*, which is, as we have said in other places, the *sine qua non* of successful evergreen culture.

It must be worth a great deal to see the Rhododendrons here when they are in blossom. These have had beds made for them in the woods and in the old belts around corners, by mixing up Jersey peat deeply and thoroughly through the soil. No more care has been used here than is used in England to grow these *American plants*, and the success is quite as great as in that country. The cry that Americans cannot raise Rhododendrons will soon be heard no more.

Mrs. Brown is an ardent lover of the Rose, and well acquainted with the merits of all the leading varieties, and we imagine this famous place will in the future be as much admired for its patronage of the Queen of flowers, as it has been for its rare specimens of beautiful trees.

## SCRAPS AND QUERIES.

A HORTICULTURAL DIRECTORY.—A sense of fairness induces us to give entire the following long extract from the *Boston Journal of Horticulture*:

"The *Gardener's Monthly*, in reply to a correspondent who has had circulars addressed to him under two different names, says, 'A good directory is badly wanted. The principle adopted by some compilers of charging two dollars for every name inserted will never get up a good one. A better plan would be to compile one honestly, and trust to the recompense by the sale of it, just as any other commercial directory maker would do.'

Now, if the editor of the *Gardener's Monthly* means to intimate that the directory which we have for some months published, and which has with every issue become more popular, is not honestly compiled, we do not hesitate to pronounce such an intimation false, and especially unbecoming in the only person whose name has

been admitted to the list without charge. All that we have ever claimed for it is, that every name in it is that of a person or firm actually engaged in the business advertised; and so far as this list is used, no person need fear wasting his time and circulars by sending two to the same concern under different directions; and we also claim as our own the plan of giving the "specialty" adopted in the different branches of the nursery business, and kindred occupations. It is very plain that a directory which should afford anything like the information given by mercantile agencies would probably cost nearer fifty than two dollars a year, which not many nurserymen would be willing to pay. Many of the leading nurserymen in the United States have pronounced our directory an excellent idea, and worth far more than its cost; and the same opinion would, no doubt, have been entertained by the *Gardener's Monthly*, if it had only happened to originate the idea, instead of ourselves."

If it is "honest" to call a list of advertisers at \$2 per line "a directory," of course our intimation is "false." The richness of the comparison with a mercantile agency will be appreciated by those who are acquainted with the standing of some of the names in the list.

Perhaps the *Gardener's Monthly* ought not to express an honest opinion, when a person employed on it has his name, unsolicited by him, inserted among the paying few. But we may say that not \$2 nor \$2,000 ever purchased an opinion from us, however, "unbecoming" such a course may seem to our contemporary. We must be allowed to repeat, that if an "honest" directory—that is, not a mere list of 240 advertisers; but of about three thousand nurserymen, seedsmen and florists, which America contains, were compiled without regard to whether the persons paid a fee or not, as all honest directories are compiled,—such a true directory would be willingly paid for by the whole community interested in such matters. As to the list of our Boston friend, we cannot see that it amounts to much more at \$2 per line, than the list of one hundred and fifteen advertisers, which, with their addresses in full, the *Gardener's Monthly* gave in the September number for nothing.

PROF. PORTER'S PEAR ORCHARD.—This orchard, which those who are fonder of a "little fun" than of carefully investigating facts, asserted was to "annihilate Meehan's theory," turns out as we expected, not to have been planted on "Meehan's theory" at all. We have not received from Prof. Porter the facts we desired in behalf of fruit culture to get; but we find our friend of the *Agriculturist* supplying some of what we want. It says, "this orchard was planted at the same time as Mr. Peters, (9 years, Ed. *G. M.*) and for six years was thoroughly cultivated." By "thoroughly cultivating," every one understands the *Agriculturist* to mean ploughing or harrowing up the surface roots of trees; and if six years of such treatment is to be considered as "Meehan's treatment," we may as well give up writing in the English language.

The *Agriculturist* knows very well that we have never recommended any pear trees to be "thoroughly cultivated" for six years before going in grass, nor even one year; but that our system calls for grass and top dressing annually from the start. But we suppose the *Agriculturist*

and the other papers thought they could get off a good joke at our expense, which if it had not been at the expense of so much truth, we should have no objection to.

FRIENDLY CRITICISM.—Friend *Monthly*, about one of the first things I noticed upon my return from Europe, was your proposed remedy for the Colorado Potato Beetle, and of course I had to have a good laugh over it. You certainly could not have had your reflecting cap on when you wrote the article, and I am glad to see that you have been properly taken to task. In an ordinary potato field, by which I mean, one that is well ploughed, you may whirl around on your heel with a perfect beetle under it, and not kill the hard-shelled rascal; and in addition to the objections offered by Mr. Riehl and Mr. Bessey, you must recollect that the roller would press heaviest on the top of the furrow where the vines grow, and lightest at the bottom of the furrow, to which most of the insects would roll. You also seem to forget (in suggesting the roller remedy for grasshoppers), that it is just as easy for these pests to skip on one side of your horses and let them go by, as it is to keep hopping in front of them; and you entirely underrate the mental calibre of the hoppers, in supposing that they would not—the majority of them—get out of the way.

In answer to J. C. W., Fishkill, N. Y., on page 275, you refer certain white grubs to "*Melolontha philophaga*," which is very much as though I should refer a certain species of vine sent me for identification to "*Vitacea vitis*." I suppose you mean the common white grub or larva of the May Beetle (*Lechnosterna quercina* Knoch). But why not say so? Come, come, friend *Monthly*, what, with endorsing copied articles, which decry the "men of books and scientific theories;" and what, with this other sloppy work, we shall begin to think you are getting unscientific!

Yours ever,

C. V. RILEY.

[Thanks for our friend's criticisms. We have inserted all that has been sent us, as we always do, whether for or against any idea advanced by ourselves or any of our correspondents, as we have no theory to defend in any case, but simply desire to serve the truth as it may be in horticulture. It does not follow, however, that because we insert objections without comment, we

always agree with their assumed force. For instance, in regard to this potato beetle business, we stated that certain insects of a tolerably hard shell character, in this section, were killed by crushing; and we suggested the possibility of doing the same with the potato beetle. It is possible that on some very soft light soil, a roller could have no effect, but we are quite sure on many soils it would crush the hardest beetle among them all. Certainly it would crush the larvæ, and that would perhaps do as well. In regard to the *direction* of the roller, Mr. R. would go in the same way as the furrows ran. Really, we should not have thought of this. In this part of the world, if an average man had been directed to use the roller for the purpose suggested, he would run *across* the furrows.

As for the grasshoppers, we thought that possibly some roller *arrangement* could be adopted. We meant merely to suggest the main idea—not point out the details. The writer is quite sure he could carry out the idea, if he had them to deal with. No doubt they would jump to the side of the horses; but *possibly* a sloping line of muslin on each side of the horses, which the writer can see readily how to fix, would lead most of the jumpers down where the roller could crush them.

Thanks also for the correction in regard to the name of the white grub. In the writer's younger days his studies in Botany and Entomology went along together, until it became evident, that time would not allow of excellence in each. Usually we hand our entomological notes to a friend versed in the modern history. In this case we trusted to our youthful knowledge, when the insect was *Scarabæus Melolonthæ*, eventually it became *Melolontha philophaga*, and now it seems, *Lachnosterna quercina*. It shows that Entomology is like Botany,—new classifying systems make new names. We should have inserted our friend's letter as we did the others, without comment; but it seems that if we do not put up the umbrella when the first light shower or two falls, it is sure to pour down on us afterwards. We add this for fear that our explanations may keep back these "friendly criticisms," which we hope rather to often receive.

PRESIDENT BERCKMANS.—It is pleasant to note the increasing influence of our best Horticulturists in public affairs. Better "rub than rust," is an excellent motto, and we like to see

the rust rubbing off our best men. Mr. P. J. Berckmans has already placed himself among the leaders of the nursery trade in the South. The *Farmer and Gardener*, of which he is the horticultural editor, is going along swimmingly, since he took hold of it; and now he has been elected to, and accepted the presidency of the Cotton States' Mechanical and Agricultural Association. The whole horticultural community will be glad to hear of his increasing honors; knowing how well they suit him.

EAR OF CORN ON THE TASSLE.—*E. H. B., Galena Ills., Sep. 28th*, writes: "A few days ago I sent you a Double Dahlia. To day I send you an ear of Pop Corn. There were no husks around it, and it is just as it grew on the top of the stalk. Our county fair is in progress. We have a fine display and a bright clear day, after a heavy frost last night."

[The cases of double flowers are not uncommon, and an explanation of some cases are offered in Meehan's paper on "Fasciation."]

The ear of corn is rare—the only instance on record. A few grains are often seen among the male flowers; but here is a *perfect* ear of two hundred grains. The sheath or husk around the ear physiologists tell us, is for the purpose of "protecting the tender ear from injury when young," but this ear has done as well without, as others have with it. There are often arising facts which throw doubt on the reasoning often given for the "uses" of organs.]

GROWTH ON A COLEUS.—*H. A. D., Phila.:* "Can you assign any cause for the peculiar growth-like tendrils on the Coleus. A friend says the whole bed was effected in this way, twining around the plants and actually destroying them."

[This is a parasite of the convolvulus family, called *Cuscuta chlorantha*. The seeds germinate in the earth, and soon after the plant finds some other thing to cling to, when the root dies, and the parasite feeds wholly on the plant it attaches itself too. It is not particular what soft succulent vegetation it feeds on; and is often seen on course weeds like a mass of yellow cotton thread. If taken in time, and cut away as soon as it appears, it can be readily kept under.]

BERGAMOT D'ETE PEAR.—Leroy says that this pear was described in the curious catalogue of

Le Lectier, so far back as 1628, under the name of Milan de La Beuveriere. Beuveriere is a tract of land situated near Anjon. He thinks it is the most ancient pear in cultivation. This, however, has been claimed for the English Autumn Bergamot, which some of the old books say has come down from the "time of Julius Cæsar."

**NEW DISEASE IN THE PEACH.**—In a recent paragraph we credited the extract to the *Farmer and Gardener*. The article originally appeared in the agricultural department of the *Mobile Register*, which is ably managed by Col. Langdon.

**CORRUGATED HOT WATER BOILER.**—Mr. J. G. Wilson sends us accounts of his patent corrugated hot water boiler, which so far as we can judge from the sketch sent, is a very good thing.

**COARSE GRASS ON A LAWN.**—An old Subscriber, *Phila.*, asks: "I have a large grass plot in a very good exposure, in town; it has been regularly mown and watered all summer, and looked beautifully until lately, when a reddish colored grass has made its appearance in patches all over it. Is that grass what is called Red top, and how can it be distinguished? An answer in your magazine will much oblige an old subscriber."

[Red-top, *Agrostis rubra*, does not flower so late. Yours is probably a worse trouble in the *Crab Grass*, a species of *Panicum*. The best remedy for your case would probably be a good coat of rich top dressing next spring, then a good raking with a fine rake, then sow with green grass and white clover—rolling the whole down well. The crab grass may be crowded out.

**SOUR AND SWEET APPLES.**—The *Country Gentleman* says:

"We are surprised to find so scientific and common sense a journal as the *Gardener's Monthly* favoring this notion, because the editor had halved two grafts and made both grow together. In this there is not the slightest difficulty—no more than in grafting a Tallman Sweeting on a Greening stock. They will unite in precisely the same way that the two may be grafted, but one side will be Greening without mixture, and the other will be Tallman Sweet without mixture. The notion that the halving is to ramify through all the branches, shoots, petioles, peduncles and germs, could not well be more ridiculous. It

must be borne in mind, that the halving or grafting two shoots together is totally distinct from halving two delicate buds together by cutting them with mathematical accuracy through the axis."

It so happens that the *Gardener's Monthly* does not favor the notion because the editor halved two grafts; but for other reasons which have been given, and with which the reader is familiar. The editor's "grafting" was but an incident given with the others. Moreover, the *Gardener's Monthly* has claimed nothing for the "two halved shoots," but for the *eye which was on those shoots*. These "two delicate buds" were "cut through with mathematical accuracy through the axis," and they have grown. Beyond this we have said nothing. We do not know whether they will produce sweet or sour apples, or what they will do. We intend to wait and see, and do not know why an experiment like this should not be tried, merely because the *Country Gentleman* knows so well that it is ridiculous.

We have never "favored" the idea to the extent suggested. All we have done is to show that it is not impossible; and to ask those interested to *experiment*. In the language of our respected contemporary, "It is easy to manufacture opinions for others, and then exhibit one's skill in demolishing them."

**PLOWDEN PEACH.**—*F. R. Mc.*, *Chillicothe, O.*, says: "I send you leaves taken from a Plowden Peach, purchased from J. B. Claggett last fall. I am considerably confused about this peach, and I do hope you will probe it to the bottom, and if nothing but Hale's Early, let the public know it."

[These leaves are the same as those sent us from Mississippi, which the growers there—good judges—say is *not* Hale's Early,—but they are not the same as those sent us by the disseminator of the peach, Mr. Claggett himself, last spring.

**APIOS TUBEROSA.**—*E. E. T.*, *Omaha, Neb.*, thus speaketh about this pretty vine, which is pretty well spread all over the United States: "Accompanying this, I send you the tuber of a very pretty climber, which grows wild along my creek. The flowers are of a not very brilliant rose color, in racemes of 3 and 4 inches in length of the pea kind (I was going to make a drawing of the flowers, but could not spare the time), not

very strong, but very sweet scented, and grows among the grasses and weeds, from 8 to 12 feet, rapid and spreading; would make a splendid climber, I think, by good culture. Seeds did not set, so cannot send them. Please give me name of plant." [*Abies tuberosa*.]

KEEPING COLEUS THROUGH WINTER.—*J. H. P., Grant City, Mo.*, asks: "I have a few Co-

leus, and I want to know what care they require through the winter?"

[They require a temperature not less than 65° to do well. Their other treatment is not different from any ordinary plant. Florists generally save only a few of each variety, in a high temperature; and from these they propagate new ones in February and March, after which the old ones are thrown away.]

## BOOKS, CATALOGUES, &C.

EVERY WOMAN HER OWN FLOWER GARDENER. By Mrs. S. O. Johnson—"Daisy Eyebright." New York: Published by H. S. Williams.

Under her pen name, Mrs. Johnson has for some years been favorably known as one of the writers for the *Country Gentleman*, and what she has written there and elsewhere has been very favorably received by the horticultural community. There are learned and scientific writers who cater to the wants of learned and scientific communities; and most of these writers forget that there is a large class who scarcely understand the alphabet of Gardening. To these, what is written is as so much Greek. Again, most of these writers are men, while many garden amateurs are women; and however womanly a man may be in his nature, he is incapable of so well understanding what a woman wants to know in her gardening operations as a woman who has first been through all the little difficulties which they still experience.

This work appears to be designed to meet just such a want as this. It would not be fair to criticise it from a higher standpoint. Then it might be in keeping with its pretensions to point out the errors and faults which might exist, but it makes no such pretensions; gives us not even the usual apologetic preface with which so many authors accustom themselves to beg the pity of the merciless critic in advance of his reading of their books.

We can only say, therefore, that though the lady who studies this work will no doubt find much to unlearn in time, there are thousands of facts and little hints about every-day plants and flowers that it will profit any lady to know; and it will no doubt command ready purchasers amongst the numerous class of beginners for whom it is intended.

In reading through, we notice that at page 130 the author gives the *Gardener's Monthly* a credit which certainly does not belong to it. Some one recommended to get bottomless boxes eighteen inches long and ten to twelve inches wide, sink them in the ground to their level, fill in with manure, and water to make the manure ferment, and then plunge in the pots, putting a few panes of window-glass on, and thus make a small hot-bed. It is possible that some one has tried this,—we should fear the small amount of manure would not give out much palpable heat to make up for all the trouble,—at any rate, the idea does not belong to the *Gardener's Monthly*, though we have to thank the author for the honor intended us.

The work is in handsome paper covers—we suppose to keep it within a moderate price. It is worth we think a better appearance.

THE SUB-TROPICAL GARDEN. By W. Robinson. London: John Murray. 1871.

HARDY FLOWERS. By the same Author. London: Fred. Warne & Co. 1871.

Mr. Robinson is very well known in this country by his *Parks and Pleasure-Grounds*, which perhaps have had a wider range of reading than any work not actually republished in this country. In a notice of that work, which we gave on its appearance, we dwelt somewhat severely on the use of cuts which appeared to us to have been taken by wholesale from a French work of Dubreuil. We have since learned that Mr. R. did this by the consent of the publishers of that work, and after paying a full value for them. There was nothing in the work to indicate that Mr. R. had acted thus honorably. Perhaps, in a work intended for English readers, it was not necessary, as very

few Englishmen trouble themselves to read the works of any country but their own; but to Americans, who gather their information from any and all sources, and numbers of whom no doubt are familiar with this French work, it was a different affair. We are sorry Mr. R. was charged with plagiarism which he did not deserve, but the fault was hardly our own.

The beautiful books now before us well maintain the good reputation of "Parks, &c." The *Tropical Garden* gives some general directions for arranging grounds with the view of introducing this style of gardening, and then describes fully all the plants which will serve this purpose in the open air of England.

This style of gardening is particularly adapted to America, and many more plants would come into use for us than Mr. R. has named. This book ought to be popular here.

"Hardy Flowers" is also a welcome phrase to Americans, where outdoor gardening is the leading feature of our horticulture. The style of the book is the same as the other, namely: histories and descriptions of the leading flowers of the British gardens. As in the other case, Americans could add much to the list, and a few named as hardy there will not prove so here; but no American who loves hardy flowers but will find pleasure and profit in the perusal. Both books are in the beautiful style of the author's former works.

AMERICAN NATURALIST. Published at the Peabody Academy of Science, Salem, Mass. September number.

This is a double one, in order to give a full report of the recent meeting of the American Association at Indianapolis. In this it performs a highly useful task. An immense amount of useful information is brought out by these scientific societies, of which the world in general seldom knows. The paper is read—or perhaps a short speech made in reference to the paper—and a few of these are published twelve months afterwards in a volume of "Proceedings," which only members get, the majority of whom perhaps are not interested in the great part of the papers issued. Moreover, others who are interested outside of the society get hold of the author's idea, and before the papers are published some other one manages to "discover" and put in a better light the originator's sentiments, and the credit therefor is lost. A serial of this kind, which gives us at once the substance of

these meetings, renders a double service—a service to authors and to the public, which is ultimately to benefit by the discoveries of science. There is in the *Naturalist* also a feature which makes their account of the proceedings of even more value than the published volumes of the society, namely: a report of the discussions which the papers occasioned, and which are often of more importance than the papers themselves.

To illustrate how well the *Naturalist* has done this, we give below the remarks made on the reading of the paper on the *Monocotyledon the primary type of seeds*, by the editor of this magazine, which has already been given in our September number:

"Prof. Gray remarked that he was not disposed now, in the absence of Mr. Meehan, and upon the consideration of a paper upon a wholly independent topic, to discuss the author's views upon "Adnation in Coniferæ;" but Mr. Meehan was well aware that they were not quite consistent with the ordinary vegetable morphology. It was more agreeable to be able to say that Mr. Meehan's conclusions, that the apparently polycotyledonous embryo of many coniferæ is only dicotyledonous, must undoubtedly be regarded as correct. This view was satisfactorily proved by Duchartre, ten or fifteen years ago, and is adopted by Parlatore in the elaboration of Coniferæ for De Candolle's *Prodromus*, published three or four years ago. But Prof. Gray thought that the appearances in the embryo of oaks, which Mr. Meehan had brought up as evidence that the dicotyledonous embryo was a mere deviation of the monocotyledonous, and especially that the two cotyledons originated as it were from the splitting up of one, would not be regarded by botanists as in any degree convincing. He presumed that Mr. Meehan perceives that it directly follows from this doctrine that in all opposite leaves the two are organically one, and he would leave to him the undertaking of reconstructing morphology and phyllotaxis upon such a basis.

Dr. T. G. Hilgard remarked that the whole question came back to the laws of phyllotaxy. The very fact of these "genetic" numbers, as he had called them, required the second element to be derived from the first one; as all radial organs must be derived from their predecessors. The fact itself was apparent in the far too much neglected phenomena of cryptogamous *developments* (or "embryology" of authors.) The moss-spore proper (apart from the *Chlorosperma* as true moss-spores), develops into a true land (or aquatic) Conifera. The latter bears a bud at the ends of its thread-like "prothallium." Each of its cells is generated out of a preceding one. A terminal cell enlarges into a conical leaf. Out of that leaf springs the second, at its base. It is in fact only on the supposition of radial organs generating their

successors at the side of the *rift*—at the centre alternating from either border (as in the case of the pod-leaves, producing fertile ovules), that the whole of phyllotaxic phenomena, and of organic numbers in general, becomes explicable. The production of new elements, however, takes place in a very embryonic condition. Cotyledons already formed do not *divide*. Lobes of fissures, folds, etc., of cotyledons are no divisions, but are due to unequal enlargement. New elements are not formed by division, but by sprouting.”

This gives the reader of the paper a much better idea of the paper itself than if it were merely read in a general way. Professor Asa Gray points out difficulties in the author's suggestions, but not as great as he could himself have shown had he been present. For instance, there are many cotyledons which are bent down or curved round themselves, and manifestly these could not have divided in the particular way that the oaks and beeches *certainly did*. But because there are difficulties here, it ought not to weigh against the *positive and ascertained* facts in the other cases. Moreover, Professor Hilgard subsequently showed that in spite of the law of phyllotaxis as we *now* understand it, the unity of origin was more philosophical than Professor Gray believed. Dr. Gray admits that several cotyledons in *coniferae* are formed by the splitting up of two.—and why the two may not originate by the splitting up of one it is hard to conceive.

There is no attempt made in the author's paper to show *when* the division into lobes takes place. As Professor Hilgard says, it must if at all take place when the mass is in a very embryonic condition, and the author would have suggested this in the paper if it had been thought possible that scientific readers would not have seen it for themselves. Indeed, it is quite possible that the difficulty about the incurved cotyledons might be solved by the divided portions growing after the divisions, which had, if at all, occurred at a very early stage.

The author of the paper is as conscious as Professor Gray that morphology and phyllotaxis

as we now understand them, seem to offer no explanation of the phenomena he recorded, but if they fail to explain them it is surely not the author's fault, nor should it be incumbent on him to reconstruct these sciences, merely because he offers the facts within his observation for the consideration of others. It rather seems the place of science to take care of the facts, than for facts to tremble at the feet of science. What Professor Gray says in regard to the paper on *Adaptation in Coniferae* is undoubtedly true. The views there entertained are not quite consistent with the ordinary vegetable morphology; and yet there was no statement made in that paper which was not sustained by actual specimens of plants exhibited at the reading. Ordinary morphology failed to explain them, and the author's own suggestions were merely offered as hypothesis until “ordinary morphology” could do better.

It is strange how slow ordinary science is to give way to facts! In that paper at Chicago, it was shown that *Thuja cricoides* must be a development from the American arborvitæ. The law of this development was clearly given. *Since that time*, “Tom Thumb” and other similar forms have been directly raised from arborvitæ, and this fact is within the knowledge of all the leading horticulturists of the country; yet “ordinary morphology” clings to the impossibility of the case, and a leading European botanist has even ignored the whole of this direct evidence, and named Tom Thumb as a species of *Retinispora*! After all, it is gratifying that leading scientists show so conservative a disposition. New doctrines should be received only on the most overwhelming testimony, and it would have perhaps been better for science in its present shape if such excellent men as Professor Gray had been at the head of things in the last generation.

But we are wandering from the main point, the *American Naturalist*, and will briefly say that there is no one who wishes to keep pace with the progress of American science but will find an interest in its pages.



## NEW AND RARE FRUITS.

**PRIDE OF THE SOUTH APPLE.**—We have been presented by the originator, Mr. Lewis, with several specimens of this new Seedling winter apple, and from what we can see of the fruit, and learn of its history and habits we are inclined to believe the variety will prove a valuable one for Southern culture.—*Southern Gardener.*

**THE COLUMBIA PLUM**—According to Dr. E. S. Hull, who has grown this variety for many years near Alton, in South Illinois, this plum is round, fully two inches in diameter, and near Alton ripens in August. It is only of the second quality either for cooking or for eating, fetching \$10 or \$12 per bushel when the best varieties command \$16. Near Albany, N. Y., it is extensively raised, but throughout the Western States it is comparatively unknown. According to the same authority, although the *Cerculo oviposits* in this plum as freely as in others, yet the larva that hatches out from its egg is almost invariably drowned out by the exuberant flow of juice that is peculiar to this variety.

**THE MURPHY APPLE.**—A superb dish of the above variety was exhibited at the rooms of the Mass. Horticultural Society, by Fearing Burr, Esq., January 16th. Its brilliant appearance attracted attention, the color being a deep crimson blotch and streaks upon a cherry ground, fading upon the shady side to a bright yellow. The quality of the fruit is very good, tender, juicy, a sprightly sub-acid, not equal to the Northern Spy in character, but much superior to the Baldwin. Mr. Burr stated that he has had the variety in bearing many years, that its habits are all good, and it bears regularly and abundantly. The size is above medium, and the shape pretty uniform as given in the outline, the deep setting of the stem, however, making it to appear more obovate in the outline than it is in reality. Its beauty and good qualities combined make it a very desirable variety.—*Boston Cultivator.*

**THE MINER OR HINCKLEY PLUM.**—This has been very extensively grown near Galena, Ill., for the last thirty-four years, and has lately been introduced into Wisconsin. It is a deep red, round plum, about one and a half inches in diameter, of a firm texture, and with a rather

tough and thick skin. In these regions it ripens from the last of September to the beginning of October; and we were informed at Galena that it can be kept through the winter by simply scalding it with hot water, placing in any convenient open vessel, and then covering it with the liquor with which it had been scalded. Owing to the firmness of the flesh, it bears transportation remarkably well, and it is said to meet with a ready sale in the Galena market.—*Western Paper.*

**THE MARENGO WINTER CRAB.**—A number of nurserymen—among those foremost in the business in the Northwest—have paid considerable attention to Siberian apples for a number of years past, with a view of testing them. Among these fruits the varieties known as the Marengo Winter Crab—Nos. 1 and 2—are, after several years of careful trial in various parts of the West and Northwest, confidently recommended as valuable acquisitions to our list of hardy fruits. Specimens of these apples have come under our notice for several years, and it is not surprising that there should be a large and increasing demand for them from Maine to Minnesota.—*Western Rural.*

**FAY'S JOE APPLE.**—This is a new variety, supposed to be a hybrid between Early Joe and Siberian Crab, specimens of which we have received from Charles Andrews, Esq., of Marengo, Ill. Mr. Andrews is a well known enthusiastic fruit grower, and knowing our love and desire to see all new things in the way of fruits and flowers, sends us this, saying "it was raised by L. Woodward, of Marengo." The fruit is about the size of Early Joe, oblate, yellow, grained with broken stripes of carmine red, flesh white, granular, like sharp sand, moistened with acid water to the palate, good when you are educated to it, as is said of eating saur kraut.—F. R. ELLIOTT.

**EARLY PENNOCK APPLE.**—We have specimens of the Early Pennock before us as we write, received from R. W. Furnas, Esq., of Nebraska, for name. It has been frequently confounded with summer Queen but is at once detected from that variety by its more yellow red, in its more

broken stripes, and also by its more white and less valuable flesh. It is, however, a showy fruit and a good bearer and hence a very profitable market sort, for the people at large care nothing for quality. It is only size and show that sells.—F. R. ELLIOTT.

**THE MINER AND WILD GOOSE PLUM.**—The Wild Goose had its origin in Tennessee, on Cumberland river; whereas the "Miner," Downing says, originated with Mr. Miner, of Lancaster, Penna. Fruit medium, oblong, pointed at apex; skin dark, purplish red, with a fine bloom; flesh soft, juicy, vinous; adheres to the stone. With this, agree, the plate and description in *Tilton's Journal of Horticulture*, Vol. 5, p. 139, for 1869, in a communication from D. L. Adair, of Hawesville, Kentucky. Some of our Western friends have taken great pains to ascertain whether the Miner and Wild Goose are distinct varieties or not, and have, I think, shown that they are quite different; for which see *Western Pomologist* for 1870 and 1871.—Cor. of *Rural Carolinian*.

**FLOWDEN PEACH.**—We have from Mr. Claggett more leaves and branches of this peach. They are of the same long tapering form as those Mr. C. exhibited to us in the spring; but some of them are crenate, and some serrate,—some with glands and some without, showing that in

these usually permanent characters this one is variable. There are none of them abruptly pointed, like the Mississippi one; but even this may be also variable. On the whole of the facts so far as we are able to judge of them, we are inclined to believe but one variety has been disseminated; and that the variety is not Hale's Early. This is also the opinion of one, if not of two good peach men in Mississippi, who have fruited it there. For ourselves, having seen but one fruit, we should not like to decide this point positively, though from that one we supposed it was quite distinct.

**PARK'S CLING PEACH.**—We have some peaches from Mr. Riehl, Alton, Ills., but no note about them. They correspond to the description of Park's Cling at page 313, and well deserve all that is said about them there. They came in excellent order, showing how well they will carry to market. We have put one away to "keep," and it seems as good to-day, Oct. 15th, as when received a month ago. A peach that will keep like an apple ought to be a pretty good thing.

**COWING'S STRAWBERRY.**—Noticed in the August *Monthly*. We have leaves of this variety from Mr. Cowing. The leaflets are four and a half inches long, and three and a half wide, showing by this, that it is a vigorous growing variety.

## NEW AND RARE PLANTS.

**THUNIA BENSONIÆ.**—One of the most beautiful of the many recently introduced Orchids, and, like its congeners the *T. alba* (the *Phajus albus* of old), of very easy growth.

It is another of the fine plants for which we are indebted to Colonel Benson, who found it at Rangoon. As a species, it resembles the *Phajus albus* in everything except size and color, the flowers being 2 to 3 inches broad, sepals and petals pale reddish purple, white towards the centre, lip large, white at base, deep purple beyond, with yellow crested disc.—VEITCH.

**DENDROBIUM CRASSINODA.**—One of the most remarkable Dendrobies hitherto discovered, whether we take the singularly-formed stems, or its distinct and beautiful flowers.

The former are produced from 9 to 18 inches in length, and formed throughout of swollen internodes, closely set together, giving them the appearance of rows of large beads.

The flowers are 2 to 2½ inches in diameter, abundantly produced from the upper nodes, white, with broad rosy tips to the sepals, petals and lip, and a large bright yellow disc to the latter.

This is another of the many beautiful plants sent to Veitch by Colonel Benson, who discovered it on the Arrakan Mountains at an elevation of 2,500 feet.

**VANDA DENSONIANA.**—Veitch is indebted to Colonel Benson for this lovely Vanda, and it must certainly rank amongst the most striking

of his discoveries. A figure of this beautiful Orchid will be found in *Curtis's Botanical Magazine* for Dec., 1869, and we give the following description by Professor Reichenbach, taken from the *Gardeners' Chronicle* of the same year, page 528:

"The white Burmese Vanda was one of the secret treasures of the Royal Exotic Nursery for a while. It has just flowered, and Messrs. Veitch have kindly placed in our hands the beautiful spolia of this striking novelty. The habit of the plant may be compared to that of *Vanda Bensoni*, though, as far as our recollection goes, the new one is much stronger. The leaves, Mr. Veitch informs us, are wider; they

are ligulate, unequally bilobed at the attenuate apex, and very shining. Our inflorescence is four-flowered, the flowers larger than those of *Vanda Bensoni*. \* \* \* \* \* There can be no doubt that this lovely plant will create a sensation amongst amateurs. We need scarcely say that it is one of Colonel Benson's most striking discoveries, though we should not care to be appointed the modern Paris to decide which was the loveliest amongst the Bensonian fairies.

"We have dedicated this Vanda to Lady Londesborough, naming it *V. Denisoniana*, in appreciation of Lord Londesborough's great and generous love for Orchids."

## DOMESTIC INTELLIGENCE.

**TERRIBLE RESULTS OF MEEHAN'S SURFACE ROOT CULTURE OF PEARS.**—We recently paid a visit to the pear orchard of Edwin Middleton, near Darby, Delaware County, and from what we saw there, have felt somewhat disposed to announce to the public, that the key has at last turned, and the *secret* of profitable pear culture been found out. We have always had the greatest faith in *results*; and when we see in so many localities, that pear growing for profit has proved a failure, although conducted on the most approved system in the books, and then turn to Middleton's orchard and see the *pears*, one is inclined to believe there must be something in his system. This orchard is fortunately in the vicinity of a lumber yard, from which to obtain props to prop up the limbs and prevent them breaking with the load of fruit. These props, from 8 to 16 and 18 feet long, we found scattered all over the orchard, wherever the fruit was near the full size; and some of the topmost boughs to which props could not be adjusted, had in several cases broke down with the weight.

The secret of success appears to be heavy mulching, on a circumference of some 18 to 20 feet around each tree. This was mostly soft meadow hay, but in some cases loose and partially decomposed straw, to the thickness of about *six inches*. This acts, of course, to keep the soil damp, and the temperature even and regular. It rather disfigures a handsome lawn in front of the mansion, to see it covered with hay; but as our friend Middleton believes in *pears*, and the practical and useful, rather than

the ornamental, the latter has been somewhat sacrificed.

The varieties cultivated are chiefly Bartlett, which, of fine size and appearance, as fast as in eating order, are engaged mostly at the Continental, Philadelphia, and have been for years delivered there daily during the pear season.—After Bartlett, and coming in profit successively, we found the reliance was chiefly on Seekel and Lawrence, as of fine quality, always commanding a ready sale. Trees of these varieties we saw literally loaded with fine fruit. There were also Leech's King-sessing, the original tree of which is in the immediate vicinity—Flemish Beauty, but not so large and fine as we have seen elsewhere. This variety seems to have the fatality everywhere in this section, of losing its leaves prematurely, but is a very luscious and sprightly pear. There were also in the orchard, Beurre d'Anjou, Beurre Clairgeau, Howell, Duchesse d'Angoulême, Louise Bonne de Jersey, and several other kinds. Most of the trees are standards.

One other advantage of the mulching, besides shading the ground is, that fruit is not bruised in dropping, which, when many bushels are gathered daily, is a great saving of time.

After gathering, the pears are taken into a dry cellar, having a mortar floor, around the sides of which shelving is erected about 4 feet high. The bottom of this is composed of slats, on which is laid first, cheap wall paper, then two or three inches of sawdust, on which the pears are placed thickly, but in a single layer.

Over these layers of pears a simple covering of wall paper is laid, to absorb any moisture from the cellar. These covers are readily lifted off, and the ripe pears for city daily selected out, and the places filled up with others. They are taken to the city in baskets, on a spring wagon and have a popularity among the guests of the Continental, from being uniformly fair and of high quality.

E. Middleton has this season been more than usually troubled with wasps and other insects

stinging the fruit and causing rot in places. Observing some time back in the *Practical Farmer*, wide mouth bottles containing sweetened water, recommended to be suspended on the branches through the orchard, he has caught many quarts of insects in this way, and without them, considers his loss would have been quite serious.

On the whole, we recommend those who have not succeeded satisfactorily in pear growing, to visit this orchard and see what results have been accomplished — *Practical Farmer*.

## FOREIGN INTELLIGENCE.

THE QUEEN OF AUTUMN.—We have not seen the chrysanthemum cultivated as it deserves to be in ninety-nine gardens out of every hundred we have visited. It is certainly one of the most "popular" of all flowers, yet its "homes" are far separated, and thousands of people who profess to love flowers could not now present a friend with a single flower or the promise of one. The bedding plants are no longer attractive, the plant-houses everywhere are filled, the craving for flowers is as active as ever, and yet where amongst the thousands of gardens in the suburbs of London, to say nothing of other great centres, shall we find one in which the chrysanthemum has the place of honor to which it is entitled by sheer merit and usefulness? There can be but one answer, and it is "Nowhere." This, however, must be qualified with the observation that a select few of the choicest floricultural spirits here and there *do* appreciate it and bestow upon it the small amount of care it requires and deserves. Our correspondent, Mr. James, of Isleworth, has furnished the best lesson perhaps of the value of the chrysanthemum in a private garden, and the more to be commended, doubtless, because he has not only communicated his routine of cultivation to the readers of the *Gardener's Magazine*, but has presented proofs of his skill in the beautiful specimens he has exhibited at South Kensington. Those who cultivate the chrysanthemum with zeal equal to that of Mr. James are few and far between, yet we ought to be able to count them by hundreds, for in its season, it has no competitor, and may be truly designated the Queen of Autumn. That we do not meet with chrysanthemums in conser-

vatories and sheltered borders, except as rarities, is perhaps to be ascribed in part to a prejudice against them founded on ignorance, but in part also, no doubt, to the immense absorption of glass, labor and admiration by the ordinary run of bedding plants, which have become a conspiracy of usurpers, claiming and obtaining all the strength of almost every garden for their presentation and keeping. Nevertheless, the gloom that has suddenly fallen on the gardens that were but lately gay with bedding plants, renders the chrysanthemum "conspicuous by its absence," and it would be a delightful relief from the dreariness that prevails, could we see in the conservatory, and the more suitable of the plant-houses for the intrusion of visitors, well-grown specimen chrysanthemums mixed with other plants, or, better still, such a solid phalax as Mr. Forsyth will presently invite the public to behold, in the only trade exhibition of the flower that the metropolis can now boast of. The numerous exhibitions by Chrysanthemum societies in all the great trading towns tend to diffuse a knowledge of the plant and promote an appreciation of its beauty; but the impressions made do not spread far, else we should hear of many more exhibitions than we do in rural districts far removed from great towns, where the need of November flowers is fully as great, and the poverty of the gardens even more noticeable.—*The Gardener's Magazine*.

AZALEA ARGENTEA.—This beautiful dwarf Japanese species is exactly suited for the margin or front row of a bed of plants, or for grouping in small beds. Its bright rosy purple flowers are very abundant and effective in the Spring.

## HORTICULTURAL NOTICES.

## THE AMERICAN POMOLOGICAL SOCIETY.

In our last we offered a few remarks as to the general success which attended the Richmond meeting. In the details the meeting was chiefly confined to the discussion of the wants of varieties of fruits adapted to the Southern States. A motion was made and carried to make the bi-annual contributions four dollars; and another to petition Congress to aid the Society by an appropriation. A resolution to petition Congress to aid in the distillation of liquor from peaches was voted down as not properly within the province of a Pomological Society. A rather long discussion took place on the Red Astrachan apple, the salient point of which was that it was too strong a grower on rich soils, and hence was a long time in coming into bearing under such circumstances. The apples which received the greatest encouragement for the South and Southwest were Red Astrachan, American Summer Pearmain, Early Harvest, Summer Queen, Caroline Red June, Common Pearmain, Manjum, Gilpin, Shockley, Winesap, Rawle's Janet, Maiden's Blush and Loudon Pippin. Others generally praised, but more cautiously, were Red Margaret or Striped June, Autumn Sweet Bough, White Winter Pearmain, Carter's Bloom, Carolina Greening, Buckingham (Syn. Salem), Taunton, Ben Davis, Junaluskie, Nickajack, Pryor's Red, Stevenson's Winter, Yates, Mason's Stranger, for Virginia.

The discussion on Pears was quite lively, and in regard to Belle Lucrative, the Society came in for a share of vituperation for ever having recommended it so highly, but the general opinion seemed to be that it deserved all that was said of it in former years, but had deteriorated since, though some of the speakers still thought it one of the very best grown. Those deemed generally acceptable were Bartletts, Bloodgood, Seckel, Howell, Beurre d'Anjou, Beurre Clairgeau, Duchesse d'Angouleme, Lawrence, Onondaga, Sheldon. Others receiving pretty general praise were Buflam, Doyenne d'Ete, Flemish Beauty, Kingessing, Rostiezer, Beurre Bose, Beurre Diel, Beurre Superfin, Doyenne Boussock. Urlaniste, also, was tolerably well spoken of.

In strawberries the enthusiasm for Wilson's Albany was quite wild. The following had

general praise: Barnes Mammoth Agricultu, st. Longworth's Prolific, Triomphe de Gand Seth Boyden, Charles Downing, Kentucky, Wilder, Seedling Eliza, Green Prolific.

The Peach was pretty thoroughly discussed. The most favored were perhaps Yellow St. John, Early Tillotson, Amelia, Large York, Crawford's Early, Troth's Early Columbia, Susquehanna, Stump the World, Grosse Mignonne, Chinese Cling, Lemon Cling, Heath Cling, Old Mixon Cling. Some kinds less known, and which received favorable mention, were Eaton, Indian Blood Cling, Lady Parham, Baldwin's Late, Picquets Late. Hale's Early raised quite an animated discussion, many regarding it as worthless, others praising it highly, under different phases of culture.

In Grapes, the Delaware, Concord and Clinton were favored with most compliments; and Norton's Virginia, Ives, and Rogers No. 5, had considerable commendation. Many other grapes were named, but as opinions seemed about equally divided we do not name them. The varieties of the Muscadine grape (Scuppernong section) were all well spoken of as profitable for cooking and vinous purposes.

Of the large number of new seedlings offered, none received from the committee the encomium of "best" which would entitle them to a distinguished place in public estimation. There were some remarkable grapes, however, from Dr. A. P. Wylie, on which the correspondent of the *Philadelphia Press* makes the following remarks:

"Among the most interesting matters connected with the exhibition of fruits, is a collection of grapes by Mr. Wylie, of Chester, South Carolina. The public at large are not able to appreciate the great value of this gentleman's labors as well as they might do, from the fact that he is not a fruit-grower for market, and therefore has no pecuniary interest in the work in which he is engaged. He experiments solely from a love of science and interest in the strange character of the results. A nurseryman, on the other hand, has an interest in money in the process of any new variety of fruits he may get, and thus the public soon hears and knows all about it.

In the South are two grapes, the Clinton and Scuppernong, which, though good grapes, are not as high in eating qualities as one could

wish. The European grape does not grow well in the open air. Dr. W. supposed that by hybridization he could mix the quality of the foreign with the hardiness and vigor of the native, and thus get perfection. Others have attempted this; but their results seem rather the effect of accident. Rogers, of Salem, Massachusetts, once produced some, but it was never repeated, nor any minute details preserved which would invest his experiments with scientific interest.

But Dr. Wylie has persevered year after year for now nearly twenty years, marking down exactly the parentage of each, and continually producing something valuable. Here, at this meeting, he had a large variety of seedlings, almost all of which, by repeated selections, most grape-eaters would consider superior even to the famed grapes of Italy or the Rhine. Some of the scientific results are very curious. For instance, year after year, he placed the pollen of the European grape on the flowers of the Scuppernong, but it had no more effect than so much earth. The Scuppernong refused to be a parent to the European grape, nor would it reproduce any better when the other American species were tried. Not even our common fox grape had any effect on the reproductive organs.

But when the Scuppernong was employed as a male parent, and its pollen introduced to the other species, a mongrel race was produced, and when the pollen of this mongrel race was introduced back again to the Scuppernong, then it was effective, and new varieties could be raised from the Scuppernong in this way. Thus the female Scuppernong grape will not intercross with the male flowers of any other grape, but it will do so with a mongrel male, which is the progeny of a male of its own species.

This curious discovery is puzzling the physiologists exceedingly, but the general public, which does not bother itself so much with laws as with their practical results, are more taken with the luscious fruit which the Doctor has produced.

In regard to the large premiums offered by the Virginia Societies, Nebraska carried away the \$100 offered for the best general collection of fruits. The premiums were subsequently donated to the Pomological Society. Kansas had a remarkably fine collection of Apples, which would perhaps have given Nebraska some trouble if the one in charge had thought to include other fruits according to the requirements of the schedule. As it was, the fifty-dollar premium for apples was awarded to Kansas.

The show of fruit was altogether magnificent, and except at the annual exhibition of the

Pennsylvania Horticultural Society, we doubt whether any such a fine exhibition was ever made as here.

Among the items of interest was a contrivance by Mr. Wier for destroying the codling moth. It is made up of pieces of shingle screwed together. The moth deposits its eggs between the faces, and between these "upper and nether millstones" the larvæ is crushed and destroyed. It appeared to us better than either woollen waste or heavy bands. Col. Hardee, of Florida, also introduced an idea, that insects could be destroyed in an orchard by concussion. Two pounds of powder exploded in an orchard would destroy the curculio and the larvæ of other insects.

In regard to practical discussions on fruit culture in general, there was but one evening devoted to it. It was chiefly confined to the Pear and its diseases. Messrs. W. Saunders, Professor Taylor, Dr. Housely, Wier, Smith, Lemoy and Meehan took part in it. Mr. Saunders had found washing the stems of Pear trees with lime and sulphur to have a good effect in rendering them healthy. He thought the fire blight in the pear was the result of fungoid action, and that these external applications might have a good result in destroying these diseases. Mr. Meehan favored the fungoid theory of fire blight. Dr. Housely and Mr. Wier attributed it to sudden atmospheric changes which must be injurious to vegetation. Mr. Brown Smith mentioned the case of a friend who insisted that the seeds of a kind of blight were in the seedling pears the previous year, but who was a little suspicious of the soundness of his theory when he was informed that the plants were only *four months old*. He still believes in his "theory," however, but he don't understand how it is that the plants cannot yet be a year old, and he thinks Mr. Smith's facts must be wrong somewhere.

The meeting is to be held in 1873 in Boston, which will be the 25th anniversary of the Society. The authorities of the city of Richmond and the members of the Horticultural and Agricultural Societies behaved in the most handsome manner to the members and delegates to the Convention. Rides were provided to different points, and the whole wound up with a superb banquet, which was largely attended. We visited the leading cemeteries and public gardens in the vicinity, and were much gratified by the excellent condition of the trees and stock of Franklin Davis & Co.'s nurseries, as well as those of Allen & Johnson.

#### PENNSYLVANIA HORTICULTURAL SOCIETY.

The annual meeting of the Pennsylvania Horticultural Society was, as the show-bills would this time truly say, "an immense attraction." We made full notes for the *Monthly*, but they are crowded over for this month, but will appear in our next.







# The Gardener's Monthly.

DEVOTED TO

*Horticulture, Arboriculture, Botany and Rural Affairs.*

EDITED BY THOMAS MEEHAN.

*Old Series, Vol. XIII. DECEMBER, 1871. New Series, Vol. IV. No. 12.*

## HINTS FOR DECEMBER.

### FLOWER GARDEN AND PLEASURE GROUND.

There are many beautiful plants which we can enjoy if we only take care to keep them from the sun in winter. The Evergreen Ivy is one of this class. In Pennsylvania it will rarely live on the south side of a building without some injury: while on the northern side, it is usually able to get through. This shows that it is not a question of the thermometer, for it is much colder on the north side of a house than on the south; but it is rather through the more rapid escape of moisture on that side. But the lesson is of value in teaching us to shade any valuable broad-leaved plant which we may have. The Japan Euonymus, the Oregon grape or *Nehemia aquifolia*, the Rhododendron, and other similar things all do very well in this section of the country, if anything be scattered lightly over to prevent injury from the sun. Mr. Rand, who has given these matters much close attention, reports that in Mass. the English Ivy is not hardy there; but we think if placed in selected spots away from the winter's sun, they might do better than is supposed. In trials of this kind the green-leaved forms should be selected, as these are more hardy than the variegated ones.

Since Mr. Robinson's works and the writings of other leaders in horticulture have called attention to the great beauty of the more tropical styles of northern gardening, there is much demand for this class of plants. One landscape gardener tells us he makes great use of the *Yuccas* for this purpose: as its sword-like evergreen leaves have a pretty effect in winter as well as in summer. The *Yucca filamentosa* is the one employed chiefly. There are other species still

rare, which will no doubt become very useful for this purpose, also when they become cheap and common, of these are *Y. repens*, *Y. gloriosa*, and *Y. angustifolia*.

We have frequently urged the importance of planting places very thickly at first, in order both to produce an immediate effect, and also because the shelter which one another affords makes the trees grow with greater health and vigor, than when exposed singly to the force of wind and sun. At this season no better employment can be found than in thinning out these thick planted places. It will of course require much judgment: but one fond of trees, and the effects which they produce, will not be much at a loss. Sometimes it is hard to bring oneself to cut down a tree which one has watched grow for so many years: but it often must be done if we would preserve the symmetry and beauty of our places. When there is any question as to the proper tree to be taken away, the size of the place may help one to decide. A tree which will in time occupy much space can be more easily spared from a small place than one which will never transgress a limited space. Indeed, except for the purpose of rapid growth to nurse more valuable trees, large growing things should not be tolerated in small places. The green grass which is the charm of all gardens soon departs when large trees are about.

Of course, this talk about thinning out, brings us to another great winter employment, that of pruning. There is no very great amount of science required for this, and yet some judgment is necessary. This is often done with little more reason than a boy has for whittling a chip—merely to have something to do. For notwith-

standing the many papers that have been written "on the philosophy of pruning," the naked question, "What is the best time to prune trees?" is one with which the gardener is continually bored. The keen-edged gardeners give the cutting reply, "any time when your knife is sharp;" but the more good natured say, "It depends on what you want to cut for." The street cutter "wants to keep the tree head low," and cuts down to make them branch lower; cutting in winter does not have this effect, so that unless one has some other object to combine with it, such as to clean the tree of bark scales or the larva of other insects, or the giving of employment to some half-starved tree carpenter, the work might as well be left undone. If you want a branch to push strongly at the point where you cut a part away, *prune in winter*. If your tree has branches crossing each other, or has half dead branches, or anything tending to spoil the form or symmetry of your tree, prune in winter; but as a rule the less pruning is done the healthier will be your trees, for it may be accepted as a rule in gardening that all pruning, whether in winter or summer, is a blow struck at the vitality of the plant.

Sometimes we have to sacrifice a good object to gain some other point. So in hedges. The plants are usually trees. To devitalize them and keep them bushy is our great object. The principal pruning is therefore in summer. The winter pruning is simply to keep them in shape. There is, however, one kind of pruning which just suits both the principle and the season, namely, thinning out where thick planting has been adopted, as it is now by all who want a new place to look well without waiting too long for the charm.

Nothing "pays" like surface dressings of manure or good soil to evergreens and ornamental trees. Life is too short for mere natural growth. It is a pardonable vice to wish for large trees. Put on two inches of good stuff, and see how they will go ahead.

The winter's experience will no doubt show how much the comforts and pleasure of a place will be added to by liberal planting, and while the sad experience is on one is the time to decide on the details. Good resolutions put off, like death-bed repentances, generally end in smoke. Odd-pells will offer through the winter season to get ready soils and manure for spring uses.

Very few understand that an occasional change of soil is very beneficial to flowers in beds,

though all know how important it is to flowers in pots. There is nothing better than surface soil from an old pasture, taken off about two inches deep, and thrown into a heap with about one sixth part old hot bed dung to partially decay. In addition to this "staple" item, smaller quantity of different matters should be gathered together for peculiar cases, or particular plants. Peat, for instance, will be found very useful for many kinds of plants. This is not, as is often supposed, mere black sand; but a spongy, fibrous substance from the surface of bogs and boggy wastes. Sand should be collected sharp and clean; the washings from turnpike ditches are as good as anything. Leaf mould is best got already well decayed from the woods. That one makes for himself from rotten leaves is seldom good for anything; it is always sour and and seems "indigestible" to vegetation. A load or so of well-decayed cow-manure is a good thing for the gardener to have by him, as all those plants that dislike our hot summers, and want a cool soil to grow in, prefer it to any other manure. A small pile of hot bed manure is almost indispensable to the garden.

Much will, in many places, be required for dressing of the lawn, which too often is really starved for want of nutriment. The modern practice of using mowers, and leaving the short grass to serve as a mulch is a little good; but not near enough to keep the grass in good heart. A top dressing every other year, or every three years, will be of great benefit to the best made lawn. This top dressing may not be of rich or expensive materials. The scouring of ditches will do. Indeed this kind of material is the better, as more of it can be used; and thus shallow places, which often exist in lawns of some pretensions, may be filled up. We have seen good lawns made in this way from rough places, as bad as if the grass had been sown on a piece of ploughed ground, without any rolling or harrowing down. The grass sown comes through the filled up places, and a smooth lawn in this way can often be had without the trouble and annoyance of ploughing up and seeding down again, a practice which is often employed where the work was not in the first instance well done.

#### GREENHOUSE.

Many suppose that if plants in windows get light, that is enough; but there is nothing so good as sunlight. This is even of more conse-

quence than heat. Flowers will generally be in greater proportion in a window at 55° than in a much higher temperature without the sunlight. Most of the old fashioned window plants are still among the best. For instance Mignonette, Sweet Alyssum, Zonale Geraniums, Cupheas, Fuchsias, Violets, Roses, Plectranthus, Chinese Primroses, Lobelias, Oxalis, *Solanum semi-baccatum* or "Jerusalem Cherry," (of which the dwarfed kind *S. capsicastrum* is an improvement,) Catalonian Jasmines, Daphnes, Sweet Olive, Laurustinus, and where there is a little knowledge, Camellia and Azalea are still among the best.

Year by year the demand for cut flowers increases, and it is far more important in these days that a gardener keep his employer's table and family in these, than to have the nice specimen plants so much in fashion some years ago.

To have plants bloom freely at this season, heat, moisture and fresh air are essential. It is even good economy to lose some heat in order to gain the advantage of opening ventilators or windows, if the weather outside be not favorable enough without. The Camellia, Azalea, Daphne, Stevia, Poinsettia, Euphorbia, Violets, Tree Carnation, Lopezia, Eupatorium, Cineraria, Perennial Candytuft, Deutzia gracilis, Tea and Noisette Roses, Epiphyllum truncatum, Hermannia odorata, Acacia, Bletia, Scarlet Geraniums, Strelitzia, Chorizema, and most kinds Australian plants, Verbenas, Bouvardia, Heliotrope, are a few of the best things to grow for cutting, that occur to us as we write. The temperature should not often be below 55° to be secure of a good bloom.

We ought perhaps to add the Rose to this list. It is, however, not a free plant to flower in the winter, unless an abundance of light can be afforded. Even then some classes of Roses are unfit for it. Only the Tea class and some of the Noisettes will do; there are not many of this last,—Lamarque being one of the few to do well. Cels, Safrano, Triomphe de Luxemburg, Homer and Madame Russel are about the best. The Camellia and Azalea are particularly valuable for cutting. The whites are the most popular for this purpose, principally the old Double White and candidissima; the last comes into flower a little later than the other kind. In cutting these, only the flowers are taken off, and artificial stems in the shape of small wires are given to them. The common white azalea, *Azalea indica alba* is also very popular among white flowers.

The Camellia is very apt to drop its buds if the atmosphere is too dry; but generally dropping follows any check to the roots by which the regular flow of moisture to the bud is stopped. This may be either too little or too much water; if too little, of course there is not enough moisture; if too much the fibres are liable to have their points injured, and thus are unable to draw moisture to the bud. Usually the last bad results follow from over potting. With a large mass of soil, water is apt to not pass readily away, when the soil "sours," as it is termed. A pot full of roots will seldom drop the Camellia buds for any other cause than too little water.

A great enemy of the Camellia is the Red Spider. The leaves indicate its presence generally by a brown tinge, when the pocket lens, which every gardener of course carries, readily detects. All plants are more or less liable to these insects, as well as to green fly, mealy bug and scale. The best way to keep them down is by a free use of the syringe in fine days, using water in which some sulphur has been strewn. Tobacco smoke is still the best cure for aphids. Scale is a very troublesome pest; water heated to 130° is still the best. This injures very tender leaves; but the scale is rarely on such, it usually keeps to the branches or on thick leathery leaves.

*Tree Carnations*,—these also now indispensable winter flowering plants, want a very light place to do well. They do not generally care about very large pots—about five or six inches—but they are very much benefited by rich manure water.

The Calla Lily is now extremely popular. This also loves light. It must have a good supply of water, and good soil to flower well.

Towards spring the *Cineraria* comes in remarkably well for cutting. This is a "queer" plant. It is one of the easiest to suffer from frost, and yet will not do well in a high temperature. It also requires much light, and to be very near the glass. So also of the *Pansy* and *Violet*, although some frost will not hurt these.

If *Pelargoniums* are wanted to flower well next May and June, they should be attended to, and grow well through the winter. They want a rather warm house to keep them growing, and should be pinched back as they grow, to keep them bushy.

A good supply of young *Fuchsias* should be coming on now—re-pot as their roots fill each pot, let them not want for moisture or light; do not pinch off their tops, but let them grow rap-

idly. The temperature in which they are grown should not exceed 55°. A turfy loam, moderately enriched with well decayed manure, and well drained with charcoal, suits them admirably.

*Australian and Cape Plants* are the chief ornaments of the greenhouse at this time. The *Acacia*, amongst the principal; will, like the *Camellia*, requires more water while flowering; in deed, most plants which produce flowers, before they make a new growth, require more water as they flower. On the other hand, most plants which flower on the young wood at or near the completion of its growth, take less. The *Correa* is another beautiful tribe, but does not do well in most collections; it is generally grown in a peaty soil; we observed that where it seems to succeed well, the growers use a considerable portion of loam in their compost for it. This is consistent with our own experience, and we are inclined to the opinion that more loam should be used with the peat for hard-wooded plants than is generally done in this country. As soon as any Cape or hard-wooded plant has ceased to flower, it should be repotted, if it require it; many prefer waiting till the plants are placed in summer quarters before this is done, and some in the fall. We prefer before they commence to grow, whatever the season may be, as the roots being then in their most active state immediately penetrate the new soil, and before it becomes sour or sodden by frequent waterings, reap whatever advantages the air it contains when fresh may afford them. Some greenhouses are rendered very gay in February and March by having young plants of *Verbena*, *Petunia*, and other

bedding-out plants potted at this time into large pots, and encouraged to grow.

#### VEGETABLE GARDEN.

Very little can be done now in this department, except by way of preparation for another year.

Manure can be placed on the ground wherever required, and Asparagus beds, if not already done, should have a slight covering of it. Bean poles, Pea-brush, and stakes of all kinds should be got now, the tool-house gone over and put in order, and everything kept in good order and studiously in its place. When the season of operations commences, there will then be nothing to hold back the attention.

Where there can be heat of 60° commanded, Bush Beans can be easily grown in pots, and can be gathered in two months from time of sowing.

If there is abundance of leaves or manure at command, and small frames, beds may be put up for early spring salads, at the end of the month.

Radishes and Lettuces are, however, very impatient of too much heat; they will come on well if the temperature be kept at 45°. When it goes above that, the sashes should be lifted entirely off.

The same remarks apply to the Potato and the Early Horn Carrot.

Cauliflowers in frames require all the air possible. Never allow them to become dry; this is the cause of many failures by way of "buttoning off."

## COMMUNICATIONS.

### THE ORGANIC IDENTIFY OF THE ALBUMEN AND ENDOSPERM OF ALL PHANEROGAMOUS PLANTS.

BY T. C. HILGARD, M. D.

*Read before the American Association for the Advancement of Science.*

All seeds of the flowering plants (the net-leaved, blade-leaved and the pine tribes) are collectively described as consisting of a *germ* or "embryo," enclosed with *two separate seed-coats*.

A great many seeds, like those of the mustard, nasturtium, buckeye, bladder-nut, the ailanthus, sumach, china-tree, orange, canella gum pod-

gumbo, hibiscus, cocoa-bean, almond, pea and rose tribes, the brazil-nut, walnut, chestnut; the cockle-bur, sun flower, and melon all conform to this description, and the natural tribes to which they belong form a connected region of the flowering plants generally speaking.

It is likewise understood that a great many seeds have their germ proper imbedded in a bulky, nutritive lump called the "*albumen*;" which thus forms the main bulk of the seed, *e.g.*, of the ivory-nut, the date-kernel, the cocoo-nut, the pepper, paw-paw and nutmeg, and all the

grains no less than the well-known coffee-bean. In water, the latter will swell and protrude its stubble-like embryo out of one end of its horny, enveloping mass, or "albumen."

It has, however, hitherto remained an unnoticed fact that all seeds which have two so-called seed-coats, are alike *destitute of an "albumen;"* and that all seeds *provided with an albumen,* have only one *solitary seed-coat, aside from the albumen itself.\**

In many other seeds, as in those of the Osage Orange (*Maclura*) and several *Cactaceæ*, etc., the albumen is thinned out, in some places, into a so-called "endopleura" or interior seed coat, while in other parts of the seed the sheet of this self-same "internal seed-coat" thickens up into a bulky albumen, conformably to the configuration of the germ it encloses and of the *testa* which contains both.

An inspection of the *immature seed* of all the so-called *æ-albuminous forms*, *i. e.* those which, like the pea-nut, peach, and almond, are destitute of an albumen, discloses the fact, that in this juvenile condition, all these seeds, have, like all the rest (*viz.* the "albuminous seeds") a large *succulent albumen zone*, wherein the germ ("embryo sac" etc.) is developed, at the expense of the former. During the process of ripening, in all the *nutty*, or "*æ-albuminous*" seeds, the primitive albumen becomes gradually *exhausted*, leaving its entire cell-tissue compressed and empty behind, as the delicate endopleura or internal seed-coat. In all the other seeds, on the contrary, this succulent albumen-zone remains the storehouse for the germinating seed to draw its substance from. In the honey-locust and the allied coffee-nut tree (*Gymnocladus*) in germination, the flinty albumen dissolves into a sort of gum-like gum arabic.

In point of fact, the "endopleura" and the "albumen" are one *identical organ*.

This evident identity of the original albumen and subsequent second seed-coat, settles at once the old and perplexed question about the erroneously supposed "*gymnospermism*," whether of Labiate, Codifereæ, and their allies, the Taxineæ, Gnetaceæ, Casuarineæ, and Cycadeæ.

Since we now know, what *parts* all seeds con-

*sist of*, these tribes are by no means to be considered as "abnormally" or even "monstrously" organized (as a prevalent theory still holds) but that *e. g.* all the *edible pine-nuts* contain, each, a *complete seed*: which loosely adheres to the capsule (like the mature cocoa-nut kernel) and is encased within a one-seeded pistil, as in the case *e. g.* with all grasses, grains and the knot-weeds; their true ovules being mostly sessile (as in the entire orders of *Polygonaceæ* and *Nyctaginaceæ*, with only few exceptions) and considerably coherent with the true pistil (or stigmatiferous "utricle"). In the above mentioned coniferous tribes, these one-seeded pistils are provided with a previous, "open" stigma; a case correspondingly represented in the duck-weeds (*Lemnaceæ*) which however have their seeds borne upon a *funiculus*.

The seed itself, of *Conifereæ*, is a complete one, consisting (1) of a germ; (2) an (oily) albumen and (3) one thin, brown, membranaceous seed-coat (the *testa*), readily separating from the utricle or nut-shell which surrounds it, as in the well-known cases of the pine nuts of California, Italy and that of the Switzerland (*Pinus cembra*).

Thus, it is clear that the *pine-scales* are only a woody cup or *cup*, of indurated "saucers" or involucre (as with acorns) that arise in the axils of delicate and sometimes colored bracts. Similar involucreal crops we find in the harsh cones of the alder, and in the sterile aments of the wild hemp tribe.

The wing-like appendages of the pine-nuts represent so many *palae* or *floral chaff* (like that of grains and bulrushes, etc.).

In the remarkable case of *Welwitschia*, the "kettle-drum pine" of western tropical Africa, no such indurated scales, but only the purpureous bracts, as are those of flowering larch-trees, are developed. The true *perianth*—judging by Dr. J. D. Hooker's plate viii—being here a delicate, foliaceous two-winged one, epigynously concrete with the nut, as is the chaff of pines and two-seeded capsules of *Araucariæ*. Nevertheless, the same identical organ is erroneously styled "a pericarp" on the preceding plates, by a *lapsus calami* of the same author, on the uncritical bias of so-called "gymnospermism."\* The so-called gymnosperms have *closed pistils!*

\*The *testa*, or exterior seed-coat, frequently exhibits a diversified structure of external and internal surfaces. In the seed of the magnolia, that of the grape, etc., the exterior surface of the otherwise bony seed-coat, which encloses the albumen, is fleshy; as is the entire *testa* of the blue cohosh (*Caulophyllum*).

\*The untenable theory, here referred to, considers the *pine-scale* as a "pistil;" destitute, however, of any of the *distinctive attributes* of a pistil, being without a suture, without a stigma, and without any fructification through its instrumentality.

It is thus clear, that there is no "break" in the vegetable kingdom: all forms uniting into a complete, connected and harmonious system of mutual typical affinities or correlations, to be discussed in detail in a subsequent paper.

### AMARYLLIS.

BY A. G., READING, PA.

The leaves of these are often spoiled by an appearance of scarlet on the underside, which in time destroys their life. I tried to find the cause of it, thinking that either extreme of over watering, or under watering might do it. Seeing them this summer more than usually affected, and thinking from some evidences of thin places in the leaf, that it might be the work of an insect I took the leaf to a gentleman who is in the practice of examining subjects with the microscope, who discovered the minute, but formidable depredator. Its nature was between that of a louse and a worm, having a longish body, half a dozen legs, two horns, two prominent eyes, and a knawing apparatus. Under one microscope it resembled a midge in size, under the other it appeared to be nearly half an inch in length. It could not be discerned without the aid of a powerful glass. By the small yet wonderful effects of such as these, are the florists best efforts defeated. They can be exterminated by washing the leaf with a sponge wet with soap-suds or tobacco-water. I found, before knowing the cause, that where the leaves of the *Amaryllis* were washed once a week, they seldom presented this red appearance.

The true (one-seeded, *pluri-ovulate*) pistil, or "utricle," was wrongly regarded as an (abnormally "naked") "ovule" with an *abnormally rostrate* "exostome," viz. the (open) stigma! Next follows (after this *pseudo* "testa") the true seed-coat under the denomination of an "endopleura,"—and an "*albumen*" besides, which contains the embryo.

The true solitary seed-coat adhering to the pistil, the shrunken albumen will often be found lying loose inside.

The contended fruit of the well known yew tree contains (1) an embryo imbedded within (2) an albumen, which is surrounded (3) by a tawny seed-coat. The latter loosely adheres to a thickish *capsule*, which is itself covered by a *thick, calycine layer*!—in the exact likeness of an acorn, a hazelnut, or the nut of the sweet gale (*Myrica*; the wax-myrtle or bayberry) which indeed seems to reproduce the true (*epigynous*) structure of the former on a reduced scale; as the (Composite) *Polymnia Uredalis* or "nutted

The cup of the yew tree thus remains to be properly interpreted as a fleshy cup partly of dry scales, like those of the acorn and wax-myrtle on the one, and the succulent uphorbia-involucres on the other hand.

### THE RATIONALE OF HOT-WATER CIRCULATION.

BY MR. T. D. FISH.

That heat is a mode of motion, has passed into an axiom in natural philosophy, and appears to be a matter of everyday experience. We speak and write of caloric as the driving force of the universe. Heat and motion have become well nigh convertible terms. Exhibit the results of heat and you reveal motion; extinguish or lessen it, and the result is rest. Such, at least, is a brief mode of stating the common belief. Nevertheless, it seems but one side of a truth. The springs of motion are not wholly laid in either heat or cold, using these terms in a popular sense. Were matter of one uniform temperature, that uniformity would prove the grave of motion. Immobility would be the unalterable condition of a world of one uniform temperature. Rest is the nett product of uniformity; motion everywhere, and at all times, treads in hot haste on the heels of diversity. The great movements we see around us reveal the force of nature striving after an impossible equality of heat. In this great contest heat and cold are the racers; they run round circular courses that have no end. It is even difficult at times to know with certainty which takes the initiative. Of more moment is it to be assured that both run on without ceasing. Heat and cold are but opposite sides—the negative and positive poles of the same great force. Certainly both are needed to complete the line of motion, and to knit its parts together in a circle of warming force. And the force and speed of the motion will be as the sum of the extreme difference of temperature between any two points that come within circulating range. The greater the disparity, the more energetic the motion; or, in other words, the more work to be done, the greater the force brought forth to do it. And the worker is not only, nor perhaps chiefly, caloric, but the want of it; or rather—and to write with more exactness—motion comes and is sustained by an endless series of exchanges between more heat and less heat. While these diversities exist, motion continues. It is less due possibly to the active agency of caloric than it may seem. If heat give wings to air or water at one end of the scale, it relatively adds to their weight at the other. For every molecule lifted by caloric, others are pushed forward and onward by gravitation. Caloric does not drag matter along

like some fiery steed with invisible rider, but rather is it a sort of outrider to clear the way for heavier matters being pushed forward by the force of gravity, or the striving for uniformity. Nature is provident of force; she never sets caloric, or aught else, to lift, drag, or drive anything that can find its way to where it is wanted without its aid. In the heating of the world she raises her stores up into the air, or carries them across the surface of the water, at the highest possible levels consistent with her objects. But her returns are placed at the lowest points. By these arrangements gravitation does useful work in the distribution of heat. A vigorous flow of hot air or water once established, the return streams take care of themselves. Elastic fluids, impelled by the force of natural laws, reach the highest points first. From this maximum altitude the descent is simple and easy; it is a mere falling from a higher to a lower point, or rather, like running down hill. At every step of the journey downwards fresh momentum is gained, and the bite of friction is less felt as a hindrance; and finally, the return stream, parting with its heat all the way, contracting in bulk, and growing in weight, plunges into the boiler or source of heat, to be at once prepared for a new round of distribution. But a point or two of considerable moment ought to be noted here; one is, that the hot water cannot remain in the boiler if we would have it so; the general opinion is, that it is driven out by caloric. But this can hardly be the case, else would all the pots on our fires suddenly boil dry, but they do not under ordinary heat; they boil without overflowing, but our boilers overflow long before they reach boiling point—in fact they ought never to boil. The chief reason for this extreme sensitiveness to motion is the great weight of cold water pressing upon the negative or cold limb of our boilers, if I may so put it. No sooner is the normal strength of the water broken by the levity induced by heat than the strong cold waters rush in, and possibly push so sharply upon the warm water as to help it forward and upwards out of the boilers. There is thus a compound action; the dual forces—levity and weight, heat and cold—act simultaneously to induce motion. There is even a third force developed, which is somewhat difficult to describe. It will be understood if I call it the upward bound or rush of heat. Caloric in its hot tract seems ever to aim at its source—the sun. It hits straight at that mark, and recks not of side issues. Leave several ways

open for caloric, and it will always take the highest road. In a current of hot water there are doubtless limits to this law. Beyond a certain height the weight of the water in vertical columns would probably check the energy of the ascending force, but within the limits of horticultural heating this rule may be held as absolute, that the higher the flow-pipe the greater the force of the current. By converting the return or lower pipe into the flow we lose this strong natural help to a vigorous circulation. One other point requires notice. The highest part of the boiler ought to be the hottest, the heating of the water should be cumulative from bottom upwards; if the circulation is rapid, as it ought to be, the boiler kept free of sediment, and the furnace is wisely adjusted, the return current will keep the base of the boiler cool. Our chief concern is to keep the crown hot. In our anxiety to save fragments of fuel we often lose sight of this one thing most needful. By multiplying flues on the crowns of boilers we keep its head cool. Better far waste some caloric up chimney than drag a languid stream of black smoke and spent flame to play around the flow-pipe. The fire here should burn its fiercest, and give its last sharp spur to the departing water, telling it in unmistakable terms to be off about its master's business, that of heating the houses. That last fillip at starting not only gives a spurt to the flowing stream, but it creates a vacuum or levity, which the whole weight of the returning column bounds forward to fill up. Hence it follows that unless on very short routes indeed, or under abnormal pressure, the greater the difference of temperature between the flow and return pipes, the swifter and the more powerful the circulation. For it must be obvious that were the return pipe to become as hot as the flow, we should lose the great force of gravity as an aid to circulation. But the smallest differences tell upon motion, and in all ordinary arrangements it may be accepted as an axiom that the return water reaches the boiler wholly by its own gravity. We have been invited to follow nature, and I have adverted to certain examples. But in all such cases it is needful to guard against analogies being taken for identities. Nature's actual modes of heating are somewhat different from ours, though her great systems of distribution are the same. Water is heated from above downwards, the air from below upwards. We find it most profitable to heat water as nature does air—by suspending it over the fire or source of heat

but because in this point we may diverge from nature, that is no reason why her grand order of heating by hot-water should be set aside or reversed. Having provided the hot-water stream by the best means at our command, we shall get the most heat out of it with the least expenditure of fuel or force by following nature's mode of distribution. It is utterly impossible to gain aught by making the lowest pipe the flow, unless our pots, teakettles and boilers can be made hottest at the bottom—and even then we should gain a loss by the chance. Since writing the foregoing I have read the Rev. J. M. Taylor's second letter (pp. 775, 776). I am not sure that I understand it; but this much is certain, that any mode of heating horticultural buildings that requires the water to be kept boiling to bring out its merits is impracticable and useless. It cannot be done, if we would—it ought not, if we could. How the arrangements illustrated in the *Gardener's Chronicle* by Mr. Cannell, which we were assured resulted in keeping the flow and return pipes at nearly equal temperatures, can likewise fulfil the conditions described in this sentence, I cannot divine. Having gained a high level for the water, he prudently keeps it until the water has acquired all the weight by condensation that the cooling process can give it; he then gives it at its final plunge into the bottom of the boiler all the advantage which altitude, perpendicularity, and directness of descent can confer on it as a motive power! If this were, or is so, then the return pipe would be almost cold. But, on the contrary, force up the whole mass of cold water by the aid of caloric in opposition to the laws and ways of nature, the hottest water will still be found at the highest point, that is, just at the upper end of the return pipe: and instead of being kept there or sent on a circuitous journey to exhaust its heat, it at once returns to the boiler warm, that is, assuming, for the nonce, that the circulation flows as the arrow-heads indicate, which, however, I by no means admit. I pass no opinion at present on the suggestion to raise the flow-pipe at starting above the level of the return, so that it may dip into it; nor the other suggestion to raise, flow and return to the same level. The Rev. J. M. Taylor seems to attribute undue importance to the verticality of the return-pipe. But the gravitation is from the highest point, how or where-ever placed, and the friction of water in pipes of such bore as is mostly used for heating is but little. As far as I understand this

gentleman, I agree with him on the importance of gravitation as an aid to circulation; but I don't see how the arrangements suggested can strengthen its force. On the contrary, they seem to me to neutralise or hinder it.

[We give the above excellent paper from the *London Gardener's Chronicle*. Mr. Fish is one of the best known of English gardeners, and it will be seen his explanation is substantially the same as those given by us in the *Gardener's Monthly*, and which so much interested our correspondents. —ED.]

#### FLOWERS IN FURNACE-HEATED ROOMS.

BY A. G.

Knowing that some persons are discouraged from cultivating flowers in furnace-heated rooms for fear of the dry atmosphere, we wish to assure them that many beautiful flowers can be so cultivated; providing care is taken to have them *thoroughly watered overhead once a week*, and regularly at other times, according to the habits of the plants.

In a large window where there was plenty of light, almost verging into sunlight, which, in the spring, came in at one corner, we have seen blooming, Amaryllis, Begonias, Bouvardias, Cactus, varieties of Geraniums, Poinsettia, Anemone-thecas, Alliums, Ixias, Jonquils, Nerica, or Iris, Waltonias, Valottas, Callas, Petunias, Bramble or Bridal Rose, &c. Some of these were forwarded in direct sunlight, with the same heat, but not all. Generally speaking, the plants were healthy and thrifty. Saucers of water were also placed among them to impart moisture.

Roses, Hyacinths, Heliotropes and Verbenas did not do so well. The Hyacinths occasionally were fine, when planted in pots. In glasses they did not develope. Fuchsias did well in a stairway window, getting a moderate share of the heat. When trimmed and potted at New Years, and allowed full growth afterward, they were very fine.

#### GOOSEBERRY MILDEW.

BY MR. W. H. MILLS, ONTARIO, CANADA.

At the last stated meeting of our Association, held at Hamilton, I was requested to give some explanation of gooseberry mildew. I had not given the subject those close microscopical observations which I have since done. These are quite at your service in case you feel disposed to



include them in your annual report: they are as follows:

I have frequently been defeated in securing a crop of gooseberries of the foreign sorts free from fungus. These frequent failures, and the request before mentioned, determined me to proceed to a more searching study of the phenomena connected with its last development; therefore, on the 5th day of July last, I placed minute pieces of the fungus (taken from a berry just plucked) on the field of a powerful microscope commencing at its lowest diameter, and from thence gradually increasing its power. I found this fungus to be composed of a well organized cryptogamous plant, exhibiting a vegetable growth many degrees lower in the organic scale than the berry from which it derived its supply of food. It consisted of a dense net work of a filamentous texture, interwoven in every conceivable way; along these filaments of threads were disposed vast numbers of minute seed vessels or conceptacles, each containing from 4 to 8 sporangia, within which lay numerous germs. Now, these conceptacles were constantly maturing, bursting open and sending forth germ life to the air in vast numbers invisible to the naked eye, possessing the power to increase to a marvellous extent and in a very short space of time. It is quite credible that in this way it might soon form an environment in which the surface of every berry and leaf would become bathed, for by the slightest motion of the air these germs are wafted. When we consider them capable of sustaining vitality under extreme heat or cold (for this has been verified by the experiments of both German and English scientists in their recent experiments to test spontaneous generation), it would almost appear from this to be law that the more elementary the organic structure the more difficult it becomes to destroy its vital properties under extreme conditions.

Now, our gooseberry cryptogam increase its size and form by extension of cilia on extremely fine threads, branching, overlapping, and reaching in all directions, where food is most abundant and suitable, not unlike the spread of mushroom spawn, so that in fact the depth of net work or the density of disease, but acts as a mere scavenger in the removal of matter unsuitable for the development of higher organic forms. It can only lay hold of refuse matter. I consider fungi as important in the economy of nature as the higher organic forms, and I would not willingly be guilty of charging those simple struc-

tures with the crime of creating disease on the more complex organism any more than I would the crow for the death of the horse upon which he feeds.

Mr. J. N. Jones, of Charleston, ten years ago, observed that before a "fungus made its appearance, and before any trace of it could be observed under a high magnifying power, the surface put on a peculiar glazed appearance." Now, this in the case of the gooseberry, arises from its own exudation becoming condensed upon the surface. Fruits, like leaves, undergo continual evaporation. If from any cause this exuded gooseberry vapor which contains the elements of sugar, becomes condensed at the surface, it forms into a glaze (constituting the essential food), which soon becomes, when exposed to the action of sunlight and air, chemically decomposed; the thickness of the glaze will depend upon the quantity of vapor and period of condensation I have observed that when mildew makes its appearance, both fruit and leaf often appear affected, condensation taking place when the air becomes suddenly raised in temperature; all cold bodies which it surrounds are at once converted into condensers in the same way as a tumbler of ice-water will condense aqueous vapor held in the air, and deposit it upon its outer surface on a hot day. The operation of this same law would cause the berry (all other things being favorable) to be covered by its excretions, which deposit would differ in point of quality, essence, and chemical composition, from ordinary air condensation, and also to an appreciable extent in one variety of gooseberry from another.

I cannot now dwell on any further explanation of this, but must proceed to explain the further appearance of things under the microscope. Upon submitting a small section of tissues of the inside of the skin of the berry, I also observed it to contain a net-work of filaments, with their conceptacles attached, same as that which overlay the berry; but no doubt the juices of the skin of the berry had by this time become involved in the chemical change. I am therefore satisfied that fungus does in no manner act as a parasite; but that its sporules do nothing more than seize upon and take advantage of the most favorable conditions presented to them, feeding upon such excrementitious matters wholly unfit to supply the requirements of the fruit.

Frequent syringing of the leaves and fruit at critical changes of atmospheric temperature, with

warm water, might possibly remove the food of the fungus, or make it unsuitable. It is a mere suggestion, worth a trial however.

[This excellent paper by one of our correspondents was read before the Fruit Grower's Society of Ontario, and has already appeared in the *Ontario Farmer*.—ED.]

### ORCHID CULTIVATION—No. 1.

BY MR. JAMES TAPLIN, MANAGER TO GEORGE SUCH, ESQ., SOUTH AMBOY, N. J.

In this series of short articles on Orchids, I don't intend giving a list of all known varieties, or to describe and illustrate expensive hothouses for growing these plants extensively, but simply to describe a few varieties which may be grown by any one having a small collection of plants. Many people are deterred from attempting Orchid growing by fancied difficulties, to such a few practical hints may be of service, and I have little doubt in a few years these beautiful plants will be grown by hundreds who are now satisfied if they can obtain a few flowers from their Fuchsias, Geraniums, &c.

This article I shall devote to a few lines on "Lycaste Skinneri," this being one of the most easy to grow and flower, is very handsome, and lasts a long time in flower: this is a South American variety or rather species, of which there are many varieties both in size of flower and color. The same plant often flowers twice in the year and lasts a long time in perfection. We have a plant that has been in bloom over two months and there are more buds coming out so that will probably last until the end of November. These plants are recommended for winter flowering, but we have them in flower at all seasons.

The Lycaste are best grown in pots, half filled with crocks, to secure good drainage, and potted in fibre from peat, from which the fine soil has been sifted, to which add some live sphagnum moss, and a little white sand. It is not necessary to raise the soil for these above the level of the pot, but do not bury any part of the bulbs; there is not any part of the year fixed for repotting, but the proper time is, when it is making young shoots and roots. They require abundance of water while growing, less when growth is complete, and never water over the flowers or they will decay and the young shoots may do so if water lodge in the heart.

These plants will grow and flower well in any

house not lower than 45°, with a slight shade from bright sun from March to October. The plants will also last a very long time in flower in a setting-room. Frequent sponging the leaves of these and all Orchids is necessary, if only to remove dust.

### THE CRINUM.

BY A. G., READING, PA.

Having had a share of experience in blooming two Crinums this summer, I give it for the entertainment of those interested in the cultivation of bulbs.

The largest of these was a *Crinum amabile*, purchased 5 or 6 years ago of R. Buist, Sr., of Philadelphia. It was treated with the earth-mixture recommended in his work on the "Cultivation of Flowers," viz.: 3 parts loam, 1 part woods-earth, 1 part sand, 1 part well-rotted manure. It thrived, grew large and made a beautiful plant, resembling young Indian corn, except in the length of its leaves, which are much greater. They formed a circle of green 4 or 5 feet in diameter, and 1½ to 2 feet in height.

Still, with all its vigor and beauty, it did not bloom. One florist said they were seldom seen in bloom: an amateur said give it rest; the book said it was an evergreen: one gentleman, who had possessed them for years, said they had bloomed but a few times. None of this was encouraging, and my friend almost concluded to part with her's. So last May my friend and myself held consultation in regard to its further treatment. It had received but little care during the previous winter, and had lost its finest leaves; altogether it was an unpromising subject. Reviewing its "ungrateful behavior" after being treated with "distinguished consideration," transferred to the parlor for heat, and having the size of its lodgings increased from year to year until within the two last, it became evident that it had no immediate intention of blooming. We thought it *might* need more room, so as there was, apparently, but little hope of it, it was planted without ceremony in a queer looking old wash tub, a little under the medium size, in as rich earth as we could get together in a short time, part of it had been in a prepared hyacinth bed. It was somewhat clayey and stiff. We stood the tub on 3 pillars made of brick, and set it near a small tree where it would receive only the morning sun. It remained quiet for several weeks, during which there

was a good deal of rain; it had also some watering. It then started new leaves, and in about 2 months, to the amazement of its owner, it sent up a big purple bud. This surprising appearance was made on the 9th of August; in 3 days it was several inches out of the bulb, and in a week showed the first blossom of 30. The general shape of the flowers resembled that of the *Amaryllis*, or white garden lily, but with a much smaller tube, and greater recurve of the petals, which were narrow. Inside, the color was a purple-pinkish white; outside of a maroon purple, shading lighter to the edges of the petals so as to leave a border of white around them. This border added much to the beauty. It emitted a fine spicy fragrance, and from description (I was absent at the blooming) formed a stately looking plant with its stem encircled with blossoms opening in gradual succession. The flowers lasted several weeks. The plant was an object of much interest to those who were observing it daily; though some made "invidious comparisons" and asserted that the blue *Agapanthus* or African Blue Lily was the prettiest. Any one not familiar with the latter, or its white variety, have still a pleasure in store. Those owned by the writer have had as many as 70 flowers in the crown.

In trying to trace the causes of the "late graciousness" of the *Crinum*, we concluded them to be, the writer's "wholesome neglect," the heat of this and the preceding summer, and the increased room for its roots which are large, long and very numerous.

The second, and smaller *Crinum*, was entrusted to my care by a friend, to whom it had been brought from San Domingo. It was there called the Egyptian Lily. She had been in possession of it a year without its showing much growth. During the first summer it was in my care the weather was very warm; it grew finely and increased in size. In the fall it was put into a large pot, with the same earth mixture given to the larger one. It was soon after returned to its owner. It died down during the winter, and was subject to severe cold several times, which destroyed other plants in the same apartment. It started growth again in the spring; and when warm weather came it was taken out of doors, and the pot sunk in a tan walk under the shade of a grape-arbor.

About the first of July I again took charge of it, and placed it where it received the sun during part of the day, most of it in the afternoon.

Having been in the shade the leaves blanched a little in the sun, and being weak were inclined to break; but it soon showed more vigorous growth and having sent up an offset that also grew well.

It was not top dressed nor any stimulent given except a small quantity of manure water. Towards the last of August it was set where it received the morning sun, and kept, comparatively, dry; more by accident than design, however. About this time I took off the offset, or young one, and by dint of care and slow approaches, got it out without very much disturbance of the roots. It was soon watered again with a liberal hand. About a week afterward, as I was walking round it (for the leaves demand a place for themselves), somewhat apprehensive that removing the offset had retarded its blooming, if such an unusual manifestation might be looked for, I suddenly discovered the shining-green tip of a bud. This was on the 9th of September (the 9th being favored by the 2 *Crinums*). The weather soon after becoming cool, it did not progress as well as the largest one. On the 5th of October the bud sheath opened. The stem sheath resemble that of the *Amaryllis*, except that the bud sheath is very large in proportion to the bulb.

On the evening of the 8th, the two first flowers opened, the stem being then  $27\frac{1}{2}$  inches high, having grown in one day  $2\frac{1}{4}$  inches, on the last  $1\frac{1}{4}$ , and topped by 7 blossoms. The flower is white inside, outside of a purple pink from the centre of each of the 6 petals to their points. They are not recurved, but remain nearly straight; the stamens are white, the anther looking like a curled up worm. The pistil is of a dark purplish pink more than half way up to the centre of the flower. After the pistils had separated they closed again so as to form more of a tube but were not in appearance like the *C. amabile*.

It is a novel and singular flower, and handsome; emitting some fragrance also.

These would be stately plants for the conservatory, portico or lawn, especially if indulged in luxuriant growth, by ample room for the roots, and development of the leaves.

◆◆◆◆◆  
LAWRENCE PEAR.

BY I. F. B. CHESTNUT HILL, PA.

I read with much pleasure your editorial on this pear, and if you will pardon me, I will add

a few thoughts to deepen the favorable impression which you have already made.

I consider the Lawrence so valuable, possessing so much excellence, that if I were limited to one kind this would be my choice.

Its quality is not surpassed by any pear that we know of,—rich, sweet, juicy and melting. It is just the right size, neither too large nor too small: beautiful in appearance, a handsome shape; deep lemon color, and a fine smooth skin. It does not, like many other varieties, decay first inside, but any defect is at once seen on the surface; this I think very important, for how mortifying to send a basket of fine looking pears to a friend and then ascertain that they were all decayed inside. I would not have one tree of this sort no matter how good it might be in other respects.

The Lawrence bears most profusely every year; there is no better bearer, not even the *Beurre d'Anjou*. It is much less subject to insects than any pear I know of. As it ripens late, about the middle of October, it seems too hard and unpalatable for wasps, bees, &c., that prey so much on the *Bartlett* and *Seckel*.

Then it is not so liable to be blown from the tree by equinoctial storms or the high winds of autumn. There is no pear like it, to cling to the branch amidst the fury of the tempest.

It is so easily ripened,—or rather it will ripen itself,—not in a hurry as some other kinds do. You have only to put them in a drawer in a cool dark place, where the thermometer is about 50°, and the work is done.

#### THE LATE FIRES PHILOSOPHICALLY CONSIDERED.

BY MR. J. JAY SMITH, GERMANTOWN, PA.

MR. EDITOR.—We have heard much of the late fires in Michigan, &c., and if we had one man of a scientific turn in our political cabinet, we might see an approach to a paternal government. But as things go in America, all is politics. What will promote the interests of the party? Shall any of us live to see the day when a partisan legislator will vote for the good of his country, if it is inaugurated by the other side? I almost despair of seeing it.

But there is a common sense view take of our late misfortunes. We formerly laughed at Espy for wishing us to make fires to produce rains, by burning forests. Philosophy tells us to plant forests for this purpose, not to burn them, and this

having been ascertained, our government will be very derelict if it suffers the late terrible events to pass without some concerted action. The defalcation money of a public officer or two would alone supply sufficient means to plant a whole State. We find our rulers negligent and timid, where they should be imperious; selling forests and giving them to be cut down, when they should be planting others; a most vital matter neglected, which, when once carried out, would convey to every mind a greater idea of our wisdom and forethought than anything we could possibly do.

Trees render the atmosphere more uniformly moist. They do so by partly extracting moisture from the winds as they pass by, and partly by hindering the sun and winds from taking away that which they already possess. By means of the cool, which is the result of the evaporation from the multiplied surface of the foliage, they temper the hotter winds which are passing over them, and so induce them to part with a portion of their wet. By rendering the atmosphere more uniformly moist, they temper the heat and cold of the different seasons. Trees also cause the rainfall to be distributed more equally in time throughout the year. They bring down the atmospheric moisture in more frequent and gentle showers; whereas in a country denuded of wood, this goes on increasing, until, from electrical and other causes, it is precipitated in floods, to the accompaniment of wind and lightning.

Trees again, by inducing frequent and prolonged gentle showers, economize the water of a country, and so make it more available for existing vegetation and for its future extension. They also, by chemical action and friction against each other and the winds, add to the atmospheric electricity and they modify sunlight. They rob it of most of its chemical and many of its colored rays, and then reflect it, thus softened upon surrounding objects. They, by absorbing and radiating heat, modify it and give it new properties, in virtue of which it acts differently on us from what it does when it falls on us from the sun. Trees again, by their chemical action on the air, and on the ground in which they grow, prepare a soil for plants which require a richer food, but which are more useful to man in his daily life. In India, villages out in the open prairie suffer more from cholera, and diseases are more deadly than in villages which are well wooded. A paternal government should

look into these matters. Experts would readily supply a list of trees suited to wooding great spaces of country, and the writer cannot but think the public lands granted to an honest company would be quite as well bestowed as upon

speculators, whose sole anxiety is to fill their own pockets and let posterity take care of itself. Is there any hope of waking up politicians? None, but by a grant of land to be paid for by so many millions of trees planted.

## EDITORIAL.

### TRAVELING RECOLLECTIONS.

Our route from Louisville to St. Louis was selected so as to afford us a ride through the most beautiful portion of Illinois rather than to hurry along by the shortest cut,—hence it took us over the Alton and Terre Haute line through Indianapolis. In order to take us to Indianapolis from St. Louis, the officers of the Jeffersonville and Indianapolis company kindly placed their road at our disposal,—a kindness the more appreciated, as, going over their section in the night time, we were unable to speak personally of the many matters of interest we had heard connected with the line.

The ride through Central Illinois, over the Terre Haute road, enabled us to see how rich and prosperous is this portion of the State. What strikes a stranger particularly is the great beauty and prominence of the school-houses. Every town, no matter how small, seems to take pride in making the school-house excel all others in taste and general interest. Charleston, a small town of about 3600, has three of these schools. Things generally seem very prosperous in this region. Farms, within a quarter of a mile of Charleston, bought 20 years ago for \$1 per acre, now bring \$50, which is an increase which ought to satisfy any reasonable man. We found here pork brought the farmer about 3½ cents per lb., stock cattle about 3, and hay about \$8 per ton.

It strikes a stranger as somewhat remarkable, that with the many hundreds of millions of Osage Orange plants which have been sold in the West, so few good ones are to be seen any where from the railroad cars, while wretched things are abundant. It seemed that the management was not understood. At the East are far better specimens than any to be seen about here, except one at Panama, which was beautiful. Most growers seemed to depend on "plashing" at some future time, to thicken the body of the hedge. This seems as if it ought to do,—but after a few

years, as we saw in some instances the hedges, so treated, are not by any means worthy of imitation. If the Western leaders of agricultural thought would urge as the proper treatment closer planting, say 3 inches apart, and regular *June* pruning as the *only* proper practice for good hedges, we should have more hope for live fencing in Illinois than we have now. Of course, there must be many good hedges some where in Illinois,—but it is evident from this railroad experience, that the general hedge planter does not know enough about them to imitate them. The general public, we believe, will see better Osage Orange fences along the line of the Pennsylvania railroad, between Harrisburg and Lancaster, than along any of the Western railroad lines.

The short stay of our party at St. Louis, of course included a visit to the Missouri Botanical Gardens of Mr. Shaw, for few persons from any part of the world go through St. Louis without seeing them. Our readers are very familiar with this beautiful place, if not from personal visits at least by the several notices in our magazine. We never visit this charming spot without regretting that no other cities have their Henry Shaws to so intelligently encourage horticulture and botanical science as St. Louis has.

The Tower Grove Park belonging to the city, and the land originally the gift of Mr. Shaw, is situated near the Botanic Garden. The tract is long and narrow, and the system has been adopted of having, for two-thirds of the distance, a wide straight drive through the centre, broken by three large oval turn-outs. The other third, in order to have a variety of scenery, will have the main drive led around nearer the boundary. The foot walks are led about in various directions, and variety aimed at by keeping different classes of trees in the different sections of the ground. The main drive is 45 feet wide. The European Plane and the Tulip tree are abundantly employed as trees for the grand avenue.

In the planting of the Park, the nursery system was chiefly employed to prepare the trees. As soon as the ground was set apart for the Park, a piece was appropriated for a nursery, and small trees bought at various American nurseries, were set out, and were growing while the grounds were being laid out. The result of this is to have the plants fresh to hand when ready to move, and they grow without any failures. Even the tulip tree, usually thought capricious in removal, was here a universal success, none of them dying, and many of them small when put out, were now from 5 to 8 feet high in 15 months. Mr. Shaw, who is Park Controller, is proud, and justly so, of his success in this matter. He will be able to keep the whole expenditure within the original appropriation of \$340,000 for the park improvement, a result not often achieved by public officers.

The Lafayette Park, a tract of twenty acres, several miles nearer the heart of the city, and finished two or three years ago, is also a beautiful spot. It is very popular with the citizens, as it well deserves to be. St. Louis seems fortunate in its park enterprise.

Our party were handsomely received by the St. Louis Agricultural Association at the fair ground. Col. Colman, of the *Rural World*, takes a great interest in the success of this society, and we are indebted to him for many valuable facts and much information about rural affairs, given during our short stay here. There has been much difference of opinion as to the usefulness of horticultural and agricultural societies traveling from place to place,—or to have one permanent place for holding meetings. The experience of this society is in favor of the permanent plan. The beautiful buildings and grounds of this society must of themselves excite a favorable influence on agricultural progress, and such as no wandering show could do.

From St. Louis, our course was taken to the Indian Territory. Mr. E. A. Ford, the General Agent of the Atlantic Pacific Railroad, took charge of the party, and devoted himself to furthering the object of our journey with a courtesy and kindness which will long be remembered. This road will go through to Southern California, and expects to do the chief part of the Texas cattle trade. At our visit the road had entered the Cherokee country a considerable distance and the track was being rapidly laid at the rate of several miles a day. Some of our party undertook spike driving—"just to say" and so on,

—but it struck us that in their cases the pen was certainly mightier—not merely than the sword,—but of the sledgehammer also,—especially with the thermometer at 98°, and such a sun as it seemed to us no other than an Arkansas prairie could furnish. The immense stock-yards, and numerous herds of cattle driving over these plains by the Texas drovers, furnished a notable charm was the great beauty of the scenery, and of the numerous wild flowers which adorned the land. Here, for the first time, we saw living flowers with which we had before only an herbarium acquaintance. The *Callirhoe* especially attracts by the vermilion tint of its flowers. If color is to follow the same law of affinity as Darwin claims for species, it would be hard to tell the parent of this beautiful plant, for in all the wild prairies there is nothing which has a tint like unto it. The great charm of this part of the country is the high lands which border this large Arkansas prairie. The outlines are so beautifully marked, and the trees so remarkably grouped on the rises and depressions of the land, that a finished landscape gardener could scarcely design any thing superior. This beauty is though, no doubt, heightened by the immensity of the plain which rises and stretches away so suddenly from it. The entrance to the Indian territory by the railroad is through a particularly grand part of this beautiful scenery,—and though we have seen grander and more imposing views than these, there be none likely to make a more lasting impression on the writer's memory than this. It is to be hoped that some day this beautiful country will pass out of the hands of the race now in legal possession of it. It is a hopeless task to make these Indians the equals of the white race in their love of the arts and sciences. Some of them had small gardens with corn, potatoes and beans, which the women cultivate,—but the men appeared to have no activity whatever. True, we did not reach the most populous portion of the territory, but from the little we saw, it seemed hopeless material to make gardeners out of. We should like to see this land change hands, though, of course, humanely, justly and kindly. That the Indian race will die out eventually, is clear—but nevertheless do we hope that the dying hours of this unfortunate people may not be embittered more than is needful to our own security.

The country leading from St. Louis to the territory is not as rich as some others,—but it

must be better adapted to some things than to others. The woods are almost wholly filled with Post Oak, *Quercus obtusiloba*. We have never seen this tree more than of medium size in the east.—but here it was as large as our average oak. If this will grow here better than trees of its own kind elsewhere, it shows that the soil will produce excellence in some things. Missouri has already known that this is the case with hemp and with the castor oil plant; and it will, no doubt, be found that some things will take well to this newly opened region.

About Springfield we found many agriculturists, of some years' standing, who spoke with much enthusiasm of their ability to grow to superior excellence any of the average farm crops of the Eastern States. The railroad company offers peculiarly favorable terms to actual settlers, and no doubt the country will rapidly fill up.

#### DESCRIPTION OF CARROTS.

People who see vegetables often wonder how to distinguish one variety from another, and yet they have marks of difference, as varied as plants or fruits. We are led to these remarks by noting how Messrs. Vilmorin, of Paris, distinguish their carrots. For instance, we suppose, them to be all growing side by side, in the same ground together, there will be difference in the sizes, forms, and colors of the roots. Taking size for example, and let one inch represent the smallest

carrot, or "Early Very Short," "Early Short Horn" would be 2 inches, "Early Half-long Scarlet," 3 inches; "Early Half-long Scarlet varieties," 3 inches; "Early Half-long Scarlet Stamp Root," 3 inches; "Long Red Surry," 4 inches; "White Large Short Vosges," 3 inches; "Flander's Pale Red," 3 inches; "Long Scarlet Altringham," 4 inches; "Long Orange Green Top" or "Orange Belgian," 6 inches, with 2 above ground; "White Green Top" or "White Belgian," 5 inches, with 2 above ground. The growing above ground seems to be a peculiarity of these Belgian Carrots.

The Altringham is conical at the surface of the ground, and has a long narrow root, nearly cylindrical; the Flander's Pale Red is wide and flat at the top, and tapers just like the Parsnip; the Long Red Surry tapers slightly—intermediate between the other two. The Long Red Surry and the Long Scarlet Altringham may be mistaken for one another in size and form; but on being cut across, the pale yellowish center is star shaped in the Surry, and quite round in the Altringham.

In the short carrots there are distinctions in the form of the roots. The Early Half-long Scarlet is the only one which tapers sharply to a point. The others are more or less blunt at the apex,—the Early Short Horn being blunt like a tumbler. These characters will be useful to seedsmen and others interested in getting true kinds.

## SCRAPS AND QUERIES.

**BUSINESS NOTICE**—It seems necessary to repeat occasionally that Mr. Meehan has no business connection with the *Gardener's Monthly*. Letters for him personally should be addressed to Germantown, Pa. If sent to the office of the *Monthly* it may be a week or more before he receives them. On the other hand, letters intended for Brinckloe & Marot, in reference to advertising or other matters, are often seriously delayed by being sent to Mr. Meehan at Germantown. Mr. M. is simply engaged as editor, and has no connection with the publishing or ownership of the magazine.

**GRAPE GROWING FOR PROFIT.**—A New York

correspondent, who, some years ago, made a heavy business of growing hothouse grapes for profit, and had a reputation all over the country for making very profitable returns from it, astonished us the other day by a letter, in which he says "Grape growing under glass as a source of profit is played out in New York. Up to 3 years ago I did very well, but since then so much rubbish has appeared in market that the price of good fruits has been ruinously low, and I have had to abandon it."

**MAURANDIA BARCLAYANA.**—*Mrs. Sara C. T., Carbon Cliff, Ills.*—Will you be so kind as to give, through the *Gardener's Monthly*, the name

of the enclosed flower. It is a wildling, and so beautiful as a hanging basket plant, that I very much wish to know it by name.

[This is *Maurandia Barclayana*. It is a native of Mexico, and as a wildling in your vicinity is but a chance seed that has fallen accidentally some way. It is known about Philadelphia as the "Barclayana Vine"—a stupid vulgarism as *Maurandia* is just as easy to remember or speak. The plant belongs to the same natural family of plants as the common snapdragon of gardens, which you will readily see by comparing the seed vessels one with another. The one you send is purplish-blue,—but there is another species called *M. semperflorens*, which is rose-colored,—and there is also a white one. In their own country they are perennials,—but here they can be treated as annuals,—the seed, if sown early in spring, will flower the same year. Florists, however, usually grow them from cuttings in the autumn or winter,—such plants bloom about June and continue till frost. The *Maurandia* are among the best vines for the summer decoration of our gardens.]

SILVERY WHITE SPRUCE.—*G. P. L., Oregon, Mo.*, writes:—"Enclosed please find a sprig of spruce, the name of which I have in vain endeavored to obtain for 3 years. I first thought it to be 'White Spruce,' but it looks so very different from that variety, and is so much more beautiful that it must be something else.

"My specimen is about 8 feet high, and for the last 3 years has grown at the rate of 18 inches each year. The branches are perfectly horizontal, the color is very light silvery gray, and during winter changes to light green; it is perfectly hardy. By giving me the name in the *Gardener's Monthly* you will much oblige me."

[The *Abies alba*, or White Spruce, is a very valuable plant in regard to the tint of its foliage, sometimes gray at others dark green. Indeed, we have little doubt but the Red, Black and White Spruces are all forms of one thing. This one is remarkably beautiful and worth propagating as a distinct form. In other things beautiful varieties have thus been selected and named. There are a score of Arborvites, and might be of Pines and Spruces. The White Spruce grows very readily from cuttings,—but they are easiest raised from layers. Notch the branches in June or July, and bury the notched part four inches under ground, and roots enough to make a new

plant will appear within two years, when the branch may be cut off and suffered to depend on its own resources.]

A GRASS FOR LAWN.—"Perplex." *Darby, Pa.*, writes:—"Enclosed is a grass which please name for me. I send it to you for the reason that a patch on my lawn bore it, and it has been so beautiful all summer I wish to order seed enough to lay down a new piece I wish to make. In early spring this patch on my lawn was the first to get green, and it became very shining in the sun,—and while parts of the lawn have been brown during the summer time, this has always been green. I have looked for a flower all summer to get the name, but I suppose the scythe kept them down, and this is the first I have seen."

[The piece sent is a *Muhlenbergia* of some kind, and cannot be the grass which our correspondent praises. No good lawn could ever be made of this grass. It is, no doubt, growing with the others. The praises our correspondent bestows on his "green" patch probably belongs to *Lolium perenne*, the rye grass.]

FRUIT INSECTS IN CALIFORNIA.—A correspondent from Yolo County, Cal., writes:—"I see by occasional extracts from your eastern papers, that you think in fruit culture here we are in Paradise, with no evil serpent to tempt us to swear. After a four years' experience of the Pacific, I certainly do think we can do as well, on the whole, as any of your newer States or Territories,—but do not think we have no enemies. I say this from having had a terrible time the past summer digging out borers from my apple and plum trees. I do not know whether these insects are the same as your apple borer or not,—they seem fatter, but I suppose they are the same."

CHIMONANTHUS FRAGRANS.—This plant is closely allied to the *Calycanthus* or Sweet Shrub; but it flowers before the leaves. Branches cut off in the middle of winter, and kept in water in a warm atmosphere, will open in a few days, and fill the air of the room with delicious fragrance. It seems quite hardy in this region.

PORTRAIT OF J. S. DOWNER.—The catalogue of Messrs. J. S. Downer & Sons, of Fairview, Ky., contains a steel plate engraving of the senior member of the firm. It is an excellent likeness



of this distinguished pomologist, to whom we are indebted for so many valuable rare and good fruits.

SOIL FOR MAGNOLIA GLAUCA.—A "*Rochester Nurseryman*" says:—"I notice in the nurseries east of this they succeed pretty well with *Magnolia glauca*. How do they grow it? Put it where I will, about here, they always fail. Traveling through Philadelphia last summer, I noticed about Camden they always grew in swamps, and I suppose they must be near water to do well."

[We fear our correspondent is not a close reader of the *Gardener's Monthly*, for it has been shown several times that the reason this plant is found in swamps is not that it particularly likes swamps, but because the seeds will not germinate readily any where else. Of course the tree has to remain where the seeds sprout. Every botanical collector knows that when he finds an occasional tree not in a swamp, it is always larger and healthier than one that is, and this is always the case with those cultivated in gardens,—they are much better than wild trees. As a general rule we may say that any soil that will suit an ordinary garden tree, will do for the *Magnolia glauca*.]

PRONUNCIATION OF CAMELLIA.—"*A Gardener*," *Baltimore, Md.*, inquires:—"Will you say in your next *Monthly* how this word should be pronounced? I was corrected by a lady recently who insisted it should be called *Camellia* making the second syllable *mel* instead of *me*. This is so opposed to the general way, that will you please decide between us?"

[It should be *mel*, but universal custom is against it. Some botanists think the name of the Priest in whose honor this plant was named, was *Kamel*,—not *Camellus*. This is more likely to be the case from the very fact of the general pronunciation, which would then be correct. The original name has probably been altered or was given under a misunderstanding, while the individual has been more honored in the pronunciation, than in the orthography, of his name. *Camellia* is so common it is not likely any attempt to correct would succeed.]

THE NEW VOLUME OF THE GARDENER'S MONTHLY.—The publishers would again remind the reader that *subscriptions* are *invariably in ad-*

*vance*, and are now due. This seems unusual to many who have had experience with similar papers, and may be annoying to some. But this annoyance, if any, will be removed when we explain that it is for *each* subscriber's benefit. We thus have no losses, and are consequently able to give as much as we do for *two dollars* per year. On the ordinary plan we should have to charge \$2.50 per year to give the same paper we do now. All our old subscribers well understand this,—we mention it for those who have been with us only during the past year. We should be obliged by all renewing their subscriptions as early as possible.

ERROR IN AUCUBA JAPONICA.—A *New Jersey Correspondent* calls our attention to *Hearth and Home* describing this shrub as a "pretty vine from Japan." But this was, no doubt, an error of haste, for Messrs. Thurber and Hogg, both of whom, we believe, are connected with the paper, stand among our best botanical authorities. Hasty magazine writing is liable to these slips. We notice what might be understood as a similar error of our own, when we referred *Cocculus Carolinus* to the "Smilax family." It was our intention to give a popular idea of how the plant grew, and the manner of a *Smilax* was in our mind. The plant itself really belongs to the Moon-seed family—very far removed from the *Smilax*.

RELATIVE FERTILITY OF AMERICAN AND ENGLISH STRAWBERRIES.—"*A Gardener*," *Baltimore, Md.*—"Is there any reason why English strawberries should not be as productive as American varieties? I find a general belief that they are not, and the fact that a variety is English seems enough to condemn it when I propose their importation. Excuse my ignorance. I am but a year old in the country."

[There is no reason why some kinds from abroad may not beat any American. They have not hitherto done this, though a French kind, the *Vicomtesse Hericart* was not far behind. Import by all means. They may be as good in the future, though the past have not been.]

FAY'S WATER-PROOF FELTING.—We have before us specimens of this new article, and are very much pleased with its appearance. Instead of the coarse appearance of regular tar felt, it more resembles fine leather. It can be used also

as flooring in the place of oil-cloth, and for decorating walls if need be in the place of paper, as it will bear washing and can be kept clean. For neat flooring for tasteful greenhouses or conservatories we should judge it would be very useful.

NOTES ON GRAPES.—Mr. F. R. Elliott contributed a valuable chapter to the *Germantown Telegraph*, giving his last year's experience of grapes at Cleveland, Ohio. He has notes on the Miles, Hartford, Telegraph, Black Hawk, Winslow, Eumelan, Adirondack, Isabella, Alvey, Creveling, Ives, Sherman, To Kalon, Elsinburg, Ontario, Senasque, Concord, Rogers' Hybrids, Othello, Canada, Delaware, Walter, Iona, Mottled, Catawba, Allen's Hybrid, Maxatawney, Martha, Rebecca, Cuyahoga and Croton. He gives unqualified praise to three only: Concord, Croton and Catawba, all the rest have serious faults. He somewhat favors Miles, Hartford, Telegraph, Adirondack, Elsinburg, Delaware,—we believe we may say, and Maxatawney. We judge that he regards all the others as hardly worth planting.

Mr. Elliott's experience is very valuable,—but it is to be regretted that he should mar it by reflections on the opinions of others, because they found reason to praise grapes which have not done as well with him as with them. They reported what they saw, and probably were as honest in their remarks as Mr. Elliott is in his. Mr. Elliott's opinions are held deservedly in high esteem, and it is because we would add to their force that we offer criticism in the hope that he may profit by it. As there is nothing in the article reflecting on any opinion of ours, we feel that we can suggest this without any suspicion on our motives.

BOUSSINGAULTIA LACHAUMII.—In our report of the last fall's meeting of the Pennsylvania Horticultural Society, we noted while penciling down the novel items, that this plant then in flower, was not a *Boussingaultia* at all, but "*Talinum purpureum*." Since then, critically examining it, we find that it is a variegated form of the common Cuban *Talinum patens*.

CATERPILLARS IN A COLD GRAPERY.—*A Subscriber, Allegheny, Pa.*—We have been bothered all summer with caterpillars, large and small, on our vines in the cold grapery. Is there any other remedy than picking off and stamping out?

[There are other remedies, but this is the easiest, cheapest and most effectual.]

EUCHARIS AMAZONICA—CORRECTION IN MR. TAPLIN'S ARTICLE.—There is an error or two in my *Eucharis* article which was probably my careless writing. First, *Eucharis* was spelt without the final *s*; and on the second column, tenth line, it should read "for large specimens I prefer *pans* instead of frames."

DESTROYING RED SPIDER—*A. H. C., Janesville, Wis.*—The red spider on house plants is best destroyed by laying the plant on its sides in the open air, and using a hand syringe on them as powerfully as the plant will bear. If a little sulphur be used in the water, and the water a little greasy, it is still better.

THE CHICAGO AGRICULTURAL JOURNALS AND FLORISTS.—Sympathy comes the sweetest when it is prompt on the heels of disaster. A monthly is not allowed this facility of expression. But we can congratulate the *public* that the *Prairie Farmer* has not been burned up however much it may have been burned out, and the public will not forget the enterprise of the men who, though personally losing all, naked as they came into the literary world, stand up to serve them as ardently and as well as they ever did before. This is among the marvels of journalism. The *Western Rural* has also appeared. We have heard nothing of what the seedsmen and florists are doing.

CALIFORNIA SUN-FLOWER.—Some of our exchanges are mirthful at the idea of the Californians growing the sunflower for the sake of its root. But they, no doubt, have the Jerusalem artichoke, which is a sunflower, and has roots which make pretty good eating when properly cooked.

EFFECTS OF SOD ON THE TEMPERATURE OF THE SOIL.—Under this head, in our August No., we copied a quotation from Johnson in the *Boston Journal of Horticulture*, showing the great difference in temperature under sod and clean surface; and, as our readers will remember, mildly suggesting that its readers would probably be astonished that no credit should be given to the writers of the *Gardener's Monthly* who have so long labored in this field. Whereat the *Boston journal* waxeth very wroth, and wishes

“the Editor of the *Gardener's Monthly* were as amiable in his journal as he is in personal intercourse.” We wish he “were.” Unfortunately public duty often stands in the way of personal desire; and in the matter of the *Journal of Horticulture* we remember how it commenced its career by an insidious slur on “magazines conducted by persons connected with horticultural establishments, which made the projection of a high-toned journal necessary.” Thus the editor “were” necessitated to show occasionally that unfit as he might be to manage a magazine, other papers were no better than his own.

We have not said much on this matter lately, because the tale has told its own story; and, public duty being satisfied, we have let our feelings of personal regard for friends interested in the magazine have their natural sway. We are very sorry to have hurt their feelings here, but we really did not know that any credit had ever been given to any writer in the *Gardener's Monthly* for any such experiment as those quoted from Malaguti and Durocher; and if the page where it appeared is referred to, we will make the honorable amende.

NOTES FROM PROFESSOR ASA GRAY.—*Catawba and Scuppernon Grapes*.—In any edition of my Manual as late as 1868, the error about Catawba grape is corrected, and that put under *V. labrusca*. See page 212.

*Tecoma grandiflora* from Japan is surely most distinct. What our friend Mr. Fendler must have had is a variety of *T. radicans* which is often grown under the name of *T. grandiflora*.

*Physiological Questions*.—As to the matters we are at issue about,—it is not the facts that I object to or distrust, but certain theoretical interpretations of the facts.

BROWALLIA.—*Mrs. H. E. G. A., Whitewater, Wis.*, writes:—“Please send me the *Gardener's Monthly* until the money enclosed is exhausted. I have forgotten the subscription price. I used to take it before the war. Also, I would like to know the names of the enclosed flowers. The blue one I suppose to be *Browallia*, but have raised it for a *Campanula* until it blossomed. The other grew where I supposed *Nemophila* was planted. It cannot be *Bartonia* for I have *Bartonia* elsewhere, with great white veined, thistle-like leaves.”

[The blue flower is correctly named *Browallia*—*B. elata*. There is a very pretty white variety of it in cultivation now. The golden flower is what was once called *Bartonia*, but that name properly belongs to a little wild plant of the Gentian family. It is now called *Mentzelia*. This species grows naturally in the vicinity of Pike's Peak, where the writer gathered fine specimens this season.]

## NEW AND RARE FRUITS.

NEW FRENCH PEAR—BEURRE DE L'ASSOMPTION.—Mr. Rivers thus speaks in the *London Journal of Horticulture*, of this fine French pear:—“I have to-day (Sept. 25th) eaten one of the finest pears of the month. It is large, and in color much like the Brockworth Park. One figure in the ‘*Dictionnaire de Pomologie*’ is like that given of this sort in the ‘*Year-Book*’; another in the same book differs from it widely. The French and English descriptions of it do not vary much. The former is, ‘*Peau jaune citron, ponctuée, strie de roux, largement marbrée et tachée de même, vers l'œil et le peduncle*’; the latter, ‘*Skin smooth, pale yellow, slightly flushed and streaked with crimson on the exposed side.*’”

“In France this sort ripens in August, here in September, and this year late. The habit of the tree is robust, much like Williams' Bon Chretien, of which I should think it a seedling, and it is marvellously fertile. There is none of the Williams' musk in its flavor, but a rich, pleasant, vinous, sugary taste. It seems as if this pear is a twin of the Brockworth Park pear, and if so, a very worthy sister or brother.

“The Beurre de l'Assomption was raised at Nantes, and was introduced with another very large pear raised at Lyons, called *Souvenir du Congres*. This has much the habit of the former and seems to be also a descendant of Williams' Bon Chretien, but it has hitherto proved coarse; it is, however, larger than Williams', more ro-

bust in habit, and if it bear well it will prove a valuable market pear.”

NEW FRENCH STRAWBERRIES.—Verdier is out with a set of new strawberries. He thinks that after the success which Dr. Nicaise's Seedlings met with, he is warranted in sending out another set by the same raiser, besides two others, one by Berger the other by Watile. These are called Anna de Rothschild, Auguste Nicaise, Berthe Montjoie, Docteur Mareve, Duc de Ma-

genta, L'Indispensable, Madame Nicaise, Marie Nicaise.

DIOSPYROS KAKI—THE JAPANESE PERSIMMON.—The *Hearth and Home* has a pretty cut of this from a specimen grown on the grounds of James Hogg. It is in many respects like our persimmon but later and sweeter. Like our's, some have to be partially decayed before good enough to eat, while others are eatable soon after they are ripe.

## NEW AND RARE PLANTS.

PAVIA MACROSTACHYA.—*See Frontispiece.*—Under this name we give this month a plate of one of the oldest of cultivated plants, and yet one comparatively unknown to the mass of cultivators. At the same time, there is nothing either new or old that will compare with it in picturesque beauty. About midsummer, when it is in full bloom, it is indisputably the monarch of the floral world.

We have used the name on our plate of *Pavia macrostachya*, because this is the one by which it is generally known in horticulture; with botanists, however, the name is obsolete. The common Horse Chestnut is an *Æsculus*. *Pavia* was at one time supposed to be a distinct genus—chiefly because the capsules are smooth, while *Æsculus* is prickly. But the *Pavia* (Buckeye) and the *Æsculus* (Horse Chestnut) are now all placed in the last family. Michaux named our plant *Æsculus macrostachya*; but Walter had previously called it *Æsculus parviflora*,—and, as priority is a fixed law in Botany, the last is the correct name.

In general, it is known as the “Dwarf Horse Chestnut.” Mature plants reach about ten feet high, but six is the general average. It may be grown as a bush—allowing the suckers which it numerously produces to remain,—or it will succeed admirably on a single stem, when it makes a large umbrella-like head, which, when surmounted with its numerous panicles of bloom, is more attractive than when grown any other way. It is a very useful plant in this, that while it grows best as all things do in rich soil in open places, it will also do pretty well in shade. Wild, it grows in rather shady places in

Kentucky, Georgia and North Carolina; but is probably hardy even in the coldest parts of Canada.

In nurseries, it is propagated chiefly by suckers which it plentifully produces. They may be grown from seed; but these sprout at once, sometimes before they drop from the trees; and when placed in the earth, often rot. In their native places, the seed sprouts amongst the dead leaves, where it is just damp, but never wet,—and these conditions must be secured to raise the nuts in gardens.

NEW ROSES OF 1871.—Eugene Verdier of Paris, is out with a list of new Roses, of these he recommends very highly among the class of Tea Roses, *Belle Maconnaise*, large double pale rose; *Coquette de Lyon*, a canary yellow; *Freres Soupert et Notting*, a fine full flower, yellow, edged with carmine; *Hortensia*, rosy, with a shade of yellow; *Le Florifere*, a well formed flower, white, changing to salmon; *Mad. Azelie Imbert*, salmon yellow; *Mad. Bernard*, bright rose, a fine double well formed flower; *Mad. Gaillard*, salmon yellow, a grand, full, well formed flower; *Mad. Emilie Dupuy*, yellow, changing to salmon; *Victor Pulliot*, white, changing to yellow. Among the Hybrid Perpetuals, *Virgile* is termed a rosy salmon, of a new shade.

CLIMBING HYBRID PERPETUAL ROSES.—This is a new class of Roses, introduced during the few past years. Their entire hardiness will recommend them to Americans, though few of the hybrid perpetuals flower very freely in the fall. We have used Baron Prevost in this way

for some years, but never had a flower after July. Princess Louise Victoria is spoken of as a good one in the new class.

LOMARIA GIBBA CRISPA.—This is a very beautiful variety of Fern, and is thus described by Mr. Moore in the *Gardeners' Chronicle*, 1868, p. 682 :

"Two distinct and very interesting varieties of *Lomaria gibba* have lately been observed in cultivation. One, which may be distinguished by the name of *crispa*, is apparently of dwarfish habit, and so densely leafy and wavy, that the edges of the pinnae have a decidedly crisped appearance."

BEGONIA ROSEFLORA.—This is one of the many beautiful Begonias discovered by the late Mr. Pearce in the Andes of Peru.

Coming from an elevation of 12,000 feet, it is admirably suited for a cool greenhouse, and is very nearly, if not quite hardy, and may be safely planted in sheltered situations.

It is a stemless species, supporting from three to five flowers, of a bright rose color, as large as those of *B. Veitchii*. We may add that it is a deciduous variety like the *B. Veitchii*. It is figured in the *Botanical Magazine* for December, 1867.

BEGONIA SEDENI—*Garden Hybrid*.—One of the finest hybrid flowering Begonias ever raised. It is a cross between an unnamed species and *B. Boliviana*, but with larger leaves. The flowers are of the richest magenta color, and of a large size. The plant continues a long time in bloom.

BEGONIA VEITCHII.—This beautiful plant differs in all respects from any other Begonia yet known, being quite hardy, and producing large bright scarlet flowers.

The following descriptions will convey the best idea of its character and habit :

In the *Botanical Magazine* for September, 1867, tab. 5,663, Dr. Hooker says : "Of all the species of Begonia known, this is, I think, the finest. With the habit of *Saxifraga ciliata*, immense flowers of a vivid vermilion cinnebar red, that no colorist can reproduce, it adds the novel feature of being hardy in certain parts of England, at any rate, if not in all. It was discovered by Messrs. Veitch's collector, Mr. Pearce, near Cuzco, in Peru, at an elevation of

12,500 feet, and the plants grown in Mr. Veitch's establishments have already given proof sufficient of their hardihood, by withstanding a temperature of 25° Fahr. with absolute impunity."

In the *Gardeners' Chronicle* of July 13th, 1867, page 734, we read : "It is difficult to imagine a more vivid color than the flowers (2 to 2½ inches in diameter) of this superb species present, which are further amongst the largest of the genus, and sweet scented.

"As a species *Begonia Veitchii* resembles *B. cinnabarina*, but is a far finer plant, of a totally different habit, and resembling a *Saxifraga* of the *ciliata* group in mode of growth and foliage."

CLEMATIS JOHN GOULD VEITCH—*Double Blue Flowered*.—We cannot too strongly recommend this magnificent double blue flowering Clematis as a most valuable addition to our hardy climbers. It is a profuse bloomer, producing very double flowers of a large size, and of a beautiful light blue color. It thrives remarkably well when planted out of doors, or as a conservatory climber. It was imported direct from Japan. Veitch exhibited this plant at the International Exhibition at Paris in 1867, and again at the International Exhibition held at Ghent in March, 1868, as well as at the Royal Horticultural Society's Show, held April 21st, 1868, where it was universally admired, and considered one of the best and most striking novelties of recent introduction, and it invariably received the highest possible awards.—*Gardeners' Chronicle*.

MUSA ENSETTE, THE GREAT BANANA OF ABYSSINIA.—This magnificent plant is without doubt the finest and most effective of all plants yet used for summer out door gardening. It is so hardy that, planted in rich soil, it grows freely during the summer months in the open air, and requires to be wintered only in a cool house. Its immense leaves attain a length of 8 to 10 feet, are of a beautiful dark green, the mid rib being bright crimson, forming an admirable and striking contrast. It attains altogether an average height of 12 to 15 feet.

We cannot too strongly recommend this splendid plant, which will be more extensively cultivated the more it becomes known; it is also admirably adapted for cultivation as an ornamental plant for conservatory decoration.

**ECHIEVERIA GLAUCO-METALLICA.**—A very distinct hybrid between *E. metallica* and *glabra*, and one which will be a valuable addition to this popular class of summer bedding plants. The leaves are nearly as large as those of *E. metallica*, and in color are intermediate between both parents, having the deep glaucous green of the one, but with the bronzy hue of the other.

One of its great recommendations is that, unlike the *E. metallica*, it always remains stemless, and it is by far the most showy and largest-leaved of all the dwarf kinds. It is a very free grower.

**RETINOSPORA FILIFERA.**—One of the most striking and unique hardy novelties ever offered. It is very difficult to give any adequate description of this beautiful plant, which has a pyramidal and exceedingly graceful habit, its great

peculiarity consisting in its numerous drooping shoots, which frequently attain a length of 10 to 12 inches without branching, and then becoming tufted or crested, giving the plant an elegant tasselled appearance, its beautiful bright glaucous green foliage rendering it the more striking. It is from Japan, and perfectly hardy.

**RETINOSPORA FILICOIDES.**—A most beautiful and very distinct hardy Conifer, introduced by Veitch from Japan, through Mr. J. G. Veitch. It is probably the most beautiful of any of the varieties as yet imported. The foliage is of a rich bright green, very *dense*, and having an exquisite Fern like character; the habit of the plant is excellent, and being perfectly hardy, we are confident that as it becomes known it cannot fail to find a place in the most select collections.—VIETCH.

## DOMESTIC INTELLIGENCE.

**HALE'S EARLY PEACH.**—We referred in our last to the discussion on Hale's Early, at the recent meeting at Richmond. The following full report is from the *Rural New Yorker*:

"Berckmans (Ga.)—It does not rot with us; we regard it the best early peach ever originated. It received \*\* for Georgia, District of Columbia, Kansas and South Carolina.

Langdon (Ala.)—After having high hopes for it in Southern Alabama, Louisiana and Mississippi, it has proved a dead failure. It commences rotting before ripening and we get no crop. In Middle Alabama and Northern Mississippi it has done well.

Quinn (N. J.)—It is losing ground in New Jersey and growers are giving it up; also in Delaware on the peninsula. It rots badly.

Berckmans (Ga.)—I have received reports from nearly every part of Georgia, and it seems to do well generally. Locality has much to do with its rotting. In Arkansas, on rolling lands, it does nicely. In our market the early peaches were all excellent and all Hale's. Ten days after, when the later varieties came in, peaches were wormy and imperfect. It is excellent for market and especially for shipping. Three years ago we got \$20 per half bushel for it in New York City.

Weir (Ill.)—Where the peach rot is prevalent, I suggest that growers add four pounds of sulphur to a half bushel of unslaked lime; slake the lime and strew it over the tree and on the ground under the tree just before the peaches begin or are expected to begin to rot.

Dr. Howsley (Kan.)—In Kansas it is one of the most valuable peaches we have. It goes into market and sells at a high price weeks before it is fit to eat. Mine stand on soil embedded in shale or gravel. It is the most popular and profitable peach we have.

Flagg (Ill.)—It has no rival, for there is no peach that ripens at the same time. It is liable to rot with us, but no more so than other varieties having the same consistency of flesh. If it does not rot on the trees, it rots in the boxes after it is shipped to such an extent as to render it very uncertain as a market fruit. Its extreme earliness has induced extensive planting, and if rot can be prevented it is valuable.

Lamosy (Va.)—It is very much liked—like many a good man with a bad name—when thoroughly understood. It is a hardy and vigorous grower; bloom hardy, and stands when Tillotson dies. So soon as they commence coloring they commence to rot. Having watched them pretty carefully, I came to the conclusion that

the rotting was due to an excessive flow of sap, and resolved to check their growth by allowing grass to grow among them; the result was I secured a good crop wherever the grass grew; but wherever cleanly cultivated, either by myself or my neighbors, it failed. I made money by allowing the grass to grow.

Wilder (Mass.)—Of course we do not cultivate it in open grounds in Massachusetts, but it is excellent for forcing; nothing can be finer; did not rot this year.

Meehan (Pa.)—When Hale's Early was first promulgated, Parry, of New Jersey, planted largely of it and clean cultivated it thoroughly. It rotted badly, and he designed to cut up the trees; but before he got ready to do so the weeds had got a start in the orchard, and to his astonishment he got a good crop of excellent fruit.

Masters (Neb.)—It has not been fully tested in Nebraska; but the finest peaches grown in Nebraska were grown on trees planted in prairie sod, without cultivation; those grown on cultivated grounds have rotted. The best way to grow peaches, I am satisfied, is to grow them in grass.

Earle (Ill.)—The experience of the Southwestern fruit growers is that rot in Hale's Early peach, as in all other kinds of fruit, is due to the injuries of the curculio. When grown free from such injuries they do not rot.

Berekmans (Ga.)—There are plenty of curculios all over the South, and yet we do not have rot.

Chamberlain (Va.)—Hale's Early is the only peach that has rotted with us this season. It has been entirely free from curculio—especially so this season. It rots invariably.

Schley (Savannah, Ga.)—On our coast it is the earliest peach and largest; it is hardy. We had it ripe this year, May 28. There were many specimens punctured by the curculio and yet none rotted. There are many peaches I cannot grow that do grow in Middle and Southern Georgia.

McIntosh (Ohio)—It rotted badly with us.

LATE ROSE POTATO.—Messrs. Thorburn say of this new potato: "In its color, habits of growth and general appearance, it resembles its parent, the Early Rose, but has superiority to that variety in the following particulars:

1st. It is of much better quality for table use, being white fleshed and fine grained, cooking

very dry and mealy. It has a peculiar, rich and delicate flavor, not surpassed by any variety we have ever tested.

2d. Its yield is enormous, from 250 to 300 bushels per acre. On the same soil and under the same treatment, the Early Rose yielded less than 100 bushels per acre.

3d. Its keeping quality is unsurpassed. In the same cellar, at planting time, when the Early Rose were so badly sprouted and wilted as to be unfit for table use, this seedling had not sprouted, and the tubers were as crisp and solid as when first dug. They remained in good condition for cooking until the new crop of Early Rose came upon the table.

'They also grow in a compact cluster in the hill, making them very easily dug. They ripen about with the Orono, or Jackson White, thus having the whole season to grow in.'

THE OSAGE ORANGE.—This tree is altogether too valuable to discard. I have seen it withstand twenty-six degrees below zero, and I believe it will be hardy all over Iowa, if it is not cut and pruned too much. Being naturally a tree, not a bush, it will not bear this. It is the most enduring timber I know of, and the tree is both beautiful and cleanly, with its bright, glossy leaves and large fruit. I have seen Osage grape stakes that had been set nine years, as good as the day they were put in the ground. It is largely used by the Southern Indians for making bows; from which the French called it *Bois d'Arc*, and which the Texans have corrupted into *Bodock*. For buggy felines and shafts, carriage poles, or any other purpose for which small timber is required tough, elastic and enduring, it has no equal that I know of. It is cheap, too, and may be bought for a dollar or two a thousand plants. They ought to be set close together, trimmed up to one stalk, and never after be cut down at all.—*Rural World*.

A NEW WAY TO MAKE FRUIT TREES.—Mr. Sullivan Hutchinson, of Bristol, N. H., received letters patent last May for a new and novel invention for making productive fruit trees in a single year from fruit bearing limbs. Limbs that can be spared from trees that bear desirable fruit are transformed into independent trees which will bear right along, just as though they had not been severed from the parent stock, and in a short time become fine thrifty trees, retain

ing the habits of the trees from which they were taken. This is what Mr Hutchinson claims his invention will do. From the imperfect description we have had of the process, it is impossible to give a very clear idea of how the thing is done. Into the limb, however, which is intended for the future tree, small roots are grafted just above where the limb is severed. Below these roots the branch is girdled. About and below the roots is placed a box filled with earth. This operation is performed in the spring. During the summer the roots grow and life is thus established between them and the limb above.—In autumn the limb is severed at the place where it was girdled, and set in the ground in the same way any young tree would be. The next year, according to Mr. Hutchinson's statement, this new tree will bear fruit just as though it had not been cut from the parent tree.

To what extent this operation may be carried, and how successful it may prove, remains to be seen. We have no doubt Mr. Hutchinson has demonstrated that the new trees will produce fruit at once, but we suppose sufficient time has not elapsed since his experiments commenced to determine what effect early bearing may have upon their future growth. That a young tree can bear fruit to any extent and at the same time put on a vigorous and thrifty growth, is not in accordance with our observation. And we suspect that Mr. Hutchinson will fail to produce very healthy trees from the application of his new discovery. We shall expect in a few years to hear that his trees have died; or at any rate that they have become so feeble that they will cease both to produce fruit and to grow. If it shall prove otherwise, the discovery is an important one.

Experiments to a considerable extent have been made in Bristol and New Hampton, and we hear that farmers in various parts of the State are buying town and farm rights with the intention of testing the practicability of this new system of producing early bearing fruit trees. If successful, a complete revolution in our manner of obtaining apple trees will be the result. Instead of buying trees from the nursery which require from ten to twenty years to come into bearing condition, the limbs from our old trees will be converted into new ones that will give us fruit at once. While we have no great expectations in regard to this new process, we have thought it of sufficient importance to call the attention of our readers to it, who can

for themselves make such inquiries and investigations as the subject would seem to merit.—*The People.*

TRANSPLANTING EVERGREENS.—Broad-leaved Evergreens, such as Magnolia (*grandiflora*), *Olea fragrans*, Magnolia *fuscata*, Cape Jasmine, Holly, English Laurel, Wild Olive, "Mock-Orange," (*Cerasus*.) Sweet and Sour Orange, etc., etc., should be transplanted just when they begin to grow vigorously in the early spring.

The same rule applies to the resinous Evergreens, such as Deodar Cedar, Japan Cedar, our common Juniper, White Pine, etc., etc. But deciduous trees of all kinds can only be safely moved when quiet and dormant. It seems hardly necessary to mention these well known facts to the readers of the *South Land*; but some recent observations have led us to believe that many otherwise intelligent people are strangely lacking in a knowledge of the commonest laws of vegetable physiology.

We have seen Magnolias dug up from the swamps in mid-winter, with ten or twelve feet of luxuriantly leafy top, and a clump of collar roots about as large as a child's head, and with no fibres whatever. These trees were hauled, on a sharp, drying day in an open cart and dumped down on the lawn, where they lay in sun and frost, for days and nights, (uncovered,) and were then planted, with a sublime faith in the miraculous and recuperative power of nature.

Of course, not one in ten thousand of such trees can possibly grow; and so, almost daily, time, money and hope are thrown away, in "town and country."

Magnolias, Hollies, etc., if lifted in the spring, carefully cut off at the ground and skilfully planted, are almost sure to live; and though this plan requires nerve and hopefulness, we feel quite assured that it is the best way to secure success.—*South Land.*

THE INSECT WORLD.—Every female insect, with the single exception of a few social species, such as honey bees, and perhaps ants and white ants (*Termites*), perish in the course of the same season, after laying their first and only batch of eggs. Their race is then run, the goal is then reached, and they retire from the course, to give place to that new generation of the same species.—*American Entomologist.*



## FOREIGN INTELLIGENCE.

**WILLOW BARK.**—A writer in the "English Philosophical Transactions," Vol. 53, says that the bark of the *Salix alba*, or white willow will cure intermittent fevers, and he recommends it as a substitute for Peruvian bark. Vanquelin affirms that it possesses all the properties of the cinchona or Jesuit bark, namely, that of precipitating isinglass, and throwing down sulphate of iron, green, and acetate of copper, brownish. White willow bark, therefore, as it unites the bitter and astringent principles, or tastes, must be suitable as a febrifuge.

The bark of the *Salix caprea*, in its green state has been manufactured into paper, pasteboard, etc., and the twigs are well adapted for willow work. The bark is also used for tanning various kinds of leather. In some countries the common people make shoes of the bark as they do in Sweden from oak bark. It is used to dye linen yarn black. The wood makes the best charcoal, and is highly esteemed in the manufacture of gunpowder. The catkins afford very early food for bees. Every bee keeper ought to plant this and other early flowering varieties of willow near his apiary.

**VICTORIA REGIA.**—The weight capable of being borne by the leaves of this wonderful plant is the subject of a communication from Mr. Sowerby, of the Royal Botanic Gardens, Regent's Park, to a recent number of *Land and Water*, in which he says: "Although we are all familiar with the wonderful tales told by voyagers on the Amazon, of the buoyant power of the leaf of *Victoria regia*, now a common and well known water plant, I have not seen recorded the actual weight supported: it may therefore interest your readers to mention an experiment made here last week: A leaf was selected, the worst but one of eight on the plant, as we did not like to destroy the best; it was, however, pretty perfect, only a few holes within six inches of the margin; diameter five feet six inches. On this leaf I placed a wheel three feet six inches in diameter, with eight spokes made of thin wood, and a small foot-board, on which I stood and floated 'high and dry;' the wheel was necessary to distribute the pressure over a considerable portion of the surface, the texture of the leaf being exceedingly tender (the foot-board did not touch the leaf, but rested on the spokes of

the wheel). I have no doubt that if the wheel had been of the same diameter as the leaf it would have served as a life-raft for a small family, as the next experiment will show. The wheel and footboard were removed from the leaf and its surface left quite free; we then gradually spread over the surface shell gravel previously weighed out in lots of half cwt.; basketful after basketful was shovelled on up to 3 cwt., when the gardeners standing by would not believe their own eyes, and began feeling under the leaf, thinking their must be some other support than water.—but no, the leaf floated quite free,—another 20 lbs., and another, and another, was thrown on, and yet the good ship remained seaworthy and no signs of foundering; 426 lb. called water began to leak in through the holes; the excitement, or perhaps, the heat of the 'stove' in which we worked, made us rather hasty and unsteady in loading cargo, the weight of which was augmented by the leakage, and an unlucky cast tilted the leaf on one side, the water rushed over, it crumpled up like a sheet of paper and sank in deep water, carrying with it a load of 436 lbs. (besides water). This is the greatest weight I have yet seen a leaf support; and the weight now on the plant may be considered equal to 1½ tons.

**THE BEST HOTHOUSE GRAPE.**—At the recent meeting of the Royal Horticultural Society for the best single dish of black grapes, there was a very excellent competition. Mr. W. Coleman, gardener to Earl Somers, Eastnor Castle, Leicestershire, who exhibits magnificent examples of Black Hamburgh, the bunches weighing over 4 lbs., perfect in bunch and berry. These are the finest examples in the Exhibition, and are awarded the first prize. Mr. Smith, gardener, Exton Park, Oakham, is placed second, with smaller but very fine examples of the same; and Mr. C. Turner, Slough, the third, with small bunches, but well-finished examples of the same variety. Mr. J. Ratty, gardener to J. Schölefeld, Esq., Turville Park, Henley-on-Thames, stages good examples of Black Prince. Mr. Colegrave also exhibits.

**PRODUCTS OF THE ANDES.**—To an elevation of 10 000 feet the eastern slope of the Andes, in Bolivia, is covered with lofty forest trees. The

potato, banana, Indian corn, wheat, barley, and rice are among the products. Corn sometimes produces 200 bushels to the acre, and wheat seventy bushels. Cochabamba supplies great quantities of wheat to the cold districts of La Paz and Potosi. Of the fruits there are found oranges, lemons, olives, figs, pineapples, pears, apples, plums, chirimoyas, pomegranates, peaches, and in fact, almost every variety of fruit. Cinnamon of excellent quality is found; it grows wild in great abundance. Tobacco, equal to that of Cuba, is extensively grown in Santa Cruz and the Beni province. "Coca" or betel is very extensively cultivated in the Yungas valley. The chocolate of the Beni has no superior in the

world. The coffee of the Yungas valley is largely cultivated.

**STEWED SPINACH.**—Half a peck of Spinach, one ounce of butter, and four tablespoonfuls of cream. Pick and wash the spinach well; put it into a pan with a small tea-cupful of boiling water, and a tablespoonful of salt; boil it gently till tender; pour it into a sieve to drain, pressing out the water; then beat it in a bowl with a wooden spoon, or potato-masher; return it into the pan; add the butter and cream; season with pepper and salt, and serve with sippets of toasted bread, and a few poached eggs.—*Gardener's Record.*

## HORTICULTURAL NOTICES.

### ACADEMY OF NATURAL SCIENCES.

At the stated meeting of the Academy of Natural Sciences of Philadelphia, on November 7th, the following matters of interest to horticulturists occurred:

Mr. Thomas Meehan said, that in passing through a wood, he was struck in the face by seeds of the *Hamamelis Virginica*, or common Witch Hazel, with as much force as if from spent shot from a gun. The stinging sensation continued for perhaps a minute. Not knowing before, that these capsules possessed any projecting power, he gathered a quantity, in order to ascertain the cause of the projecting force, and to measure its power. Laying the capsules on the floor he found the seeds were thrown generally four or six feet, and in one instance as much as twelve feet away. The cause of this immense projecting power he found to be simply in the contraction of the horny albumen which surrounded the seed. The seeds were oval, and in a smooth bony envelope, and when the albuminous coat by contraction had burst, and expanded enough to get just beyond the middle, where the seed narrowed again, the contraction of the albumen caused the seed to slip out, just as we would squeeze out a smooth tapering stone between the finger and the thumb.

Dr. Joseph Leidy remarked that this was in many respects an interesting plant. The seed vessels took exactly a year to mature. As soon as the leaves fell the blossoms opened, and at the

same time next fall, when the last year's capsules were opening, the new flowers appeared.

Dr. Joseph Carson stated that he had found the phenomenon which characterizes the squirting cucumber, also due to a mechanical force.

The mass of seeds inside were enveloped in an elastic sac. Between this sac and the external cuticle, was a mass of cellular matter filled with moisture, which was conveyed through the sac to the interior by endosmic power. As the seeds grew the sac was distended to its utmost capacity; and when the fruit was detached from its parent stem, an opening was made into the sac, when, just as in the bursting of any distended bladder, the sac contracted, and forced the seeds and cellular matter out through the orifice.

### PENNSYLVANIA FRUIT GROWERS' SOCIETY.

The annual meeting of this association will be held in Horticultural Hall, Philadelphia, commencing January 17th, 1872. Efforts are now being made to have representatives present from the different State organizations throughout the country; and we cordially invite pomologists from every section to be with us, and participate in the discussions. Able addresses will be delivered by prominent horticulturists, and the exercises will be of the most interesting character.

JOSIAH HOOPES, PRES'T.

ALEX. HARRIS, *Rec. Sec.*  
THOS. MEEHAN, *Cor. Sec.*

# ILLUSTRATIONS.



Frontispiece.....	Pavia macrostachya	
Colored Plate—February.....	Bouvardia Vreelandi.	
April.....	Salway Peach.	
June.....	Dendrobium nobile	
September.....	Pinus pungens	

C.

Centaurea Clementei.....		92
--------------------------	--	----

G.

Gardens, Rose, Plan of.....		87
Ground Leveling and Practical Gardening.....		287

H.

Heater for Plant Case (Outline Drawing of).....		329
---	--	-----

P.

Plan of Rose Garden.....		87
Plant Case, Heater for.....		329
Practical Gardening, Ground Leveling and.....		287

R.

Rose Gardens, Plan of.....		87
Rustic Work, Use for Tree Trimmings in.....		20

S.

Solanum Ciliatum.....		126
-----------------------	--	-----

T.

Tree Trimmings, Use for in Rustic Work.....		2
---	--	---

INDEX.—VOL. XIII.

2.	Apple, Old Adam, 121	Blight and Insect Composit'n, 149	Catalogue, The Society's, 391
About Cabbages, 110	" " Pride of the South, 247	Bliss' Strawberry Show, 210	Catalogues, SS. 2'S
Academy of Natural Sciences, 320	" " Pyra, 124	Blood-leaved Beech, 205	" of European Firms, 124
378	" " Seedling, 124	" " " English Oak, 206	" " " 124
Acclimatization, 21	" " Speckled, 25	" " " Hazelnut, 205	Catalpa, The, 216
" of Apples, 233	" " Staynann's Summer, 215	" " " Maple, 206	Caterpillars in a Cold Grapery, 370
Acer Japonica, 20	" " Trees, Barron, How to make them Bear, 253	" " " Peach, 206	" " " Plants, 206
" " Poly morphum, 29	" " " on Ridges, 210	" " " " 206	Caution to Nurserymen and others, 285
" " Pseudo Platanus, 29	" " Wealthy, 27	Bloomdale, Azaleas and Rhododendrons of, 195	Cave, A Mushroom, 127
Achimenes (Encordia) Negligens, 184	Apples, Acclimatization of, 236	Boiler, Corrugated Hot Water, 343	Cement for Iron, A Strong, 127
Acorus Japonicus Variegatus, 139	" " Etowah Seedling, 214	Boilers, 113, 224	Centaurea Clementei, 92
Address by Marshall P. Wilde, 295	" " Late Blooming, 23	" " and Circulation, 172	Changeable Forget-Me-Not, The, 232
Adiantum Veitchii, 280, 313	" " Siberian Crab, Improvement in, 211	" " Hot Water, 1, 103, 144, 173	Change in the Habits of Bees, 187
After the Pirates, 33	" " Sour & Sweet, 181, 275, 343	Bonsingaultia Lichnoides, 370	Changes, F feet of, 29
Age of the Larch, 212	" " " Speckled, 124	Boston Lettuce, about, 242	Changing the Colors of Flowers, 15
Agricultural Association, Atlanta, 212	Arboreal Etinospora, &c., Dwarf varieties of, 247	" " " Pears at, 23	Chemical Powers of the sunlight, 231
" " Journals and Florists, the Chicago, 370	Aristolochia Sipho, Propagating, 211	" " Potanic Garden at Brussels, 15	Cherries at Dr. Hall's, 217
Agriculture, Egyptian, 15	Arnold's Grapes, 53	" " " Bay, New South Wales, 23	Chicago, Berghley Park, 151
" " the Commissioner of, 24	Arrangement of a Flower Bed, 119	Bougainvilleas, 251	" " Buffalo, The, 150
Akroyden, Gooseberry Show at, 188, 222	" " Leaves, Phyllotaxis, or the, 283	Bouvardia Davidsonii, 211	" " Governor Wood, 156
Alder, English in Texas, Growth of, 177	Asparagus and Mashrooms, 101	" " Vreelandii, (with plate), 50	Chicago Agricultural Journals and Florists, The, 370
Alpine Houses, 277	" " in Soup, 24	Bouvardias, Propagating, 24	China, Woods of, 21
" " Strawberries, 155	" " Siding, 23	Branched Trusses in Geraniums, 180	Chinese Water Lilly, 144
Alternanthera Amabilis-Fidebor, 181	" " Varieties of, 90	Brugmansia or Datura Sanguinea, 153	Chrysanthemums, 139
Alton, Ills., Notes from, 267	Asphodel, Yellow, The, 182	Bryssels, Botanic Garden at, 15	Cider, 5
Althea, Splendid varieties of, 209	Atlanta Agricultural Association, 212	Bud Variations, 43	Circulation, Boilers and, 172
Amaryllis, 308	Aucuba Japonica, Error in, 339	Buffalo Cherry, 151	" " " The Rationale of, 355
American and English Strawberries, Relative Fertility of, 359	August, Greenhouse and Conservatory in, 222	Buff Apple, The, 312	" " of Hot Water, 144, 183, 199, 204
" " Horticultural Annual, 1-4	Australia, Reminiscences of, 131	Buffum Pear, Planting the, 122	City Lawns, Fruit Trees on, 181
" " Naturalist, 315	Autumnal Foliage, Color in, 60, 99	Bugging, 250	Clematis Patens, John Gould Veitch, 132
" " Entomological Society, 91, 212, 222, 320, 371	Autumn, The Queen of, 259	Bulbs, New, 332	" " John Gould Veitch, 373
" " Entomological Society, New Fruits at, 312	Azalea Amena, 351	Burghey Park Cherry, 151	Climate of Port Lavacca, Texas, 149
" " Botches in England, 1, 319	Azaleas and Rhododendrons of Bloomdale, 195	Burlington Grape, 56	Chimatos, Depth of Rain in Variations, 252
" " Seedling Deciduous Trees, Beauties of Fore & Clumpsof, in Spring, 14	B. B.	Business Notice, 367	Climbing Hybrid Perpetual Roses, 372
Andes, Products of the, 377	Baillon's L'histoire des Plantes, 253	Buonapartias, Correction from Mr. Harlung, 510	Close Pruning Grapes, 315
Anemone Japonica, 55	Banana, the Great, of Abyssinia—Musa Ensete, 373	Cabbage Head, The, 170	Coal Gas and the Roots of Trees, 23
Anemones in Pots, 251	Bark, Willow, 377	Cabbages, About, 116	Coarse Grass on a Lawn, 343
Announcement of Fruit Dictionary, 286	Barren Apple Trees, How to make them Bear, 283	Cactus, The Orange, 59	Codling Moth, The, 59, 90, 165, 178
Antigonon Sepotius, 286	Bear, Sava, 55	" " Snow, 22	Coffee, A Substitute for, 315
Apios Tuberosa, 217, 353	Bears, Dwarf French, 253	Caladium Culture in England, 159	Cogswell Pearmain Apple, 214
Apple, A New Crab, Muckle's Beauty, 28	Beatrice Peach, 279	" " Roots, 287	Colerus, Growth on a, 312
" " Bull, The, 312	Beauties of American Forest, Clumps of Deciduous Trees in Spring, 14	California, Confere, 293	" " keeping through Winter, 241
" " Cooper's Early White, 312	Beautiful Fruit, 4	" " Evergreens, 93	Colfax Strawberry, 21
" " Early Pennock, 337	Beeding Geraniums, 191	" " Fruit Insects in, 565	Collar on Nut Tree with a, 251
" " Fay's Joe, 347	Beech, Blood leaved, 266	" " Hoopes' Trip to, 91	Colorado Potato Beetle, Crush, ing the, 277
" " Fernway or Fallowa, 102, 122	" " Purple, 284	" " Horticulturist, 88	" " " Destruction of the, 208
" " Fulton, 57	" " Three of Holland, The, 332	" " Lecture on Horticulture in, 116	Colored lights on Plants, 207
" " Gerbilich, 151	Bees, Change in Habits of, 187	" " Pitcher Plant, 119	" " Plates, Our, 56, 91
" " Haas, The, 214	" " Humble, 284	" " Sunflower, 370	Color in Autumnal Foliage, 60, 99
" " Hottenstein, 125	Belonia Chesoni, 280, 313	Californian Flower for Name, 182	Columbia Plum, The, 347
" " Insects, 91	" " Rosalora, 373	" " Notes, 212	Commissioner of Agriculture, The, 51
" " Marengo Winter Crab, The, 347	" " Soudan, 373	Callipyche Aurantica, 184	Communications and Brief Notes, 212
" " Monte Bello, 157	" " Veitchii, 373	Camellia, Pronunciation of, 369	Compass Plant, Notes on the, 293
" " Murray, The, 317	Bergamot, President, 312	Can Gardeners claim a Month's Notice? 296	Conclusion, 303
" " Oldberg Siberian Crab, The, 152	Bergamot D'Or Pear, 312	Carrots, Description of, 267	Confere, California, 293
	Best Hot-house Grape, The, 377	Castor Oil Pumee, 21	Conservatory, Delytra Spectabilis for the, 221
	Burr of L'Assomption, Pear, New French, 374	Catalogue of C. L. Allen & Co., N. Y., 56	" " Rhododendrons for the, 188
	" " Wenzel Pear, 214	" " Ellwanger & Barry, 150	Continental Journals, Notes from, 15
	Bignonia Grandiflora, 29	" " Grasses, 88	Cooper's Early White Apple, 312
	Blackberry, Orange East on the, C. DeGray, 296	" " A Japan Nursery, 88	
	" " East, 211		



# THE GARDENER'S MONTHLY.

<p>Grapes, New Foreign, 41            " Notes on, 370            " Texas, Notes on some, 334            Grasses, Fertilization of, 158            Grass for Lawn, A, 368            " Thick, A Protection Against Drouth, 94            Cray, Prof. Asa, Notes from, 371            Gray's School and Field Book, 87            Green's, Horace, Essays, 25            Greenhouse, 291            " and Conservatory in August, 222            " " Plant Cabinets, 2            " " Hot and, 260            " " Roofs, Pitch of, 123            Greenhouses, 37, 68            Ground Levelling and Practical Garden Plotting, 286            " Pine, 22            Growth of English Alder in Texas, 277            " on a Colcus, 342            Growths, Spontaneous, 276            Gunnera Chilensis, or Scabra, 153</p>	<p>Hyacinthus Princeps, 185            Hybridizing on Pollen, Curious Results of, 123            Hybridizing, 24            Hybrid Pear, A Supposed, 156            " Perpetual Roses, Climbing, 372            Hybrids and Varieties, 122            " Grape Seedlings and, 80            Hydrangea, Japanese, The, 25            " Otaka, 28, 267            " Paniculata Grandiflora, 28            " Stellata Prolifera, 153, 267</p>	<p>Leptosiphera Roseus, 58            Lessons of Experience, 297            Letter from Rochester, 333            " Mr. Douglass, 118            Lettuce about Boston, 242            Libocedrus, Decurrens and Thuja Gigantea, 182            Lilies at the London Shows, 254            " Chinese Water, 144            Liliium Auratum, 190            " Trigynum, 186, 189            L'illustration Horticole, 123, 151            Locust, The Yellow, 24            Lomaria Gibba Crispa, 373            Lombardy Poplar Tree, The, 13            London Gardeners in the Olden Time, 158            " Poor, Flower Market for the, 232            " Pride, 118            " Lilies at the, 254            Looking at the Root of Things, 307            Lost Exchanges, 213            Louisiana, Notes from, 230            Love of Flowers in New York, 96</p>	<p>Mushroom Cave, A, 127            Mushrooms, Asparagus and, 101            Muskinnellon, New, 119            My Ten Rod Farm, 123</p>
<b>N.</b>			
<p>Name, California Flower for, 182            " of Plant, 118, 119, 310, 311            " Plant for, 212            Names of Plants, 22, 308            Naming Fruits, 218            Nankeen Cotton, The, 165            National Exposition of 1876, The, 224            Native Country of the Verbena, 211            " Georgian Potato, 154            Natural Sciences, Academy of, 320            378            Nature, Rhododendron, in, 8            Nepenthes Sedenii, 282, 313            Nerine Undulata, 127            New and Beautiful Evergreens, 266            " Bullis, 332            " Crab Apple, A, 28            " Crimson Flowered Mignonette, 92            " Disease in the Peach, 343            " Double Wisteria, 152            " Edible Plant—Sium Helianum, 280            " Firms, 212            " Flowers, Raising, 310            " Foreign Grapes, 44            " French Pear—Beurre de L'Assomption, 371            " " Strawberry, 372            " Fruits at the American Pomological Society, 312            " Fuchsia, 121            " Grape, A, 26            " " from Ellwanger &amp; Barry, 27            " Hickory, A, 90            " Mode of Grafting, 261            " Musk Melon, 119            " Peach, A, Park's Cling, 56            " Peaches, 312            " Pear—Broekworth Park, 57            " " Earle's Russett, 125            " Roses of 1871, 372            " South Wales, Botany Bay, 263            " Strawberry, Monarch of the West, 152            " Varieties of Potatoes from the Seed Ball, On the Raising of, 39            " " Originating, 300            " Monthly, the, 369            " Way to make Fruit Trees Bear, A, 375            " York, Love of Flowers in, 96</p>			
<b>O.</b>			
<p>Norway Spruce Seed, Sowing, 210            Note on Growing Violets, 6            " Potatoes, 13            Notes by Miss A. G., 144            " Californian, 242            " Communications and Brief, 212            " Editorial, 81, 176, 204, 238, 271            " from Alton, Ills., 266            " " Continental Journals, 15            " " Prof. Asa Gray, 371            " " Jacksonville, Fla., 181            " " Louisiana, 230            " " Meadville, Pa., 172            " Gardening, 64            " on Gen. Pleasanton's Paper, Brief, 269            " on Grapes, 370            " on some Texas Grapes, 334            " on the Compass Plant, 201            " " Season, 334            Notice, Business, 367            Nurseries, Knox, 31            Nurseryman, Death of a, 21</p>			

# THE GARDENER'S MONTHLY.

<p>Nurserymen and Others, Caution to, 285                      " Our Future, 149                      Nursery, Mr. Meehan's, 54                      " Names in Directories, Duplication of, 277                      Nut Trees, Sowing, 276                      " Tree with a Collar on, 253</p> <p style="text-align: center;"><b>O.</b></p> <p>Oak Roots, Pear on, 121                      Oblong Siberian Crab Apple, The, 152                      Ohio, Fruit in, 182                      Oil for Insects, 90                      Old Adam Apple, 124                      Oldest Rose Tree, The, 253                      " Tree in Europe, The, 252                      Onions in England, Size of, 253                      Orange Cactus, The Blackberry, Rust on the, 266                      " To Destroy, 266                      Orangefield Red Currant, 125                      Orchard, Productive Pear, 93                      " Prof. Porter's Pear, 307, 341                      Orchard Culture, 201                      " Cultivation, No. 1., 362                      Oregon, Grapes in, 216                      Organic Identity of the Albumen and Endopleura of all Phanerogam Plants, The, 356                      Originating New Varieties, 300                      Origin of souchette Raspberry, 181                      " Species, 243                      Osage Orange Hedge, Transplanting an, 91                      " The, 375                      Ouachita Grape, The, 27                      Outlines and Description of Seedling Fruits, 180                      Overdoing the Strawberry Trade, 146                      Oxalis Lasiandra, 122</p> <p style="text-align: center;"><b>P.</b></p> <p>Pandanus Veitchii, 282                      Pardee's Seedling Pear, 214                      Parkman Francis, Professor of Horticulture, 212                      Park's Cling Peach, 56, 313, 348                      Passiflora Arborea, 56                      Patent, A Remarkable, 249                      " Laws and Seedling Fruits, 22                      Pavement, Tar, The Manufacture of, 157                      Pavia Macrostachia, 372                      Peach, Beatrice, 279                      " Blood-leaved, 206                      " Free Mason, 26                      " Hale's Early, 374                      " Hutchinson, 31                      " New Disease in the, 343                      " Park's Cling, A New, 56, 313, 348                      " Plowden, 215, 343, 345                      " Plowden's Seedling, 278                      " Salway, The, (with plate), 117                      " Tree Disease, A, 282                      " Trees, Dressing for, 242                      " " the Yellows in, 144                      " Yellow St. John, 279                      Peaches, A Grape Vine Bearing, 133                      " Fortune's Double Flowering, 25                      " in Utah, 249                      " in Virginia, 182                      " Crop, The, 275                      " Mammoth, 30                      " New, 312                      " Seedling, Improvement of, 344                      Peak's Emperor Strawberry, 22                      Pear, Beaucot d'Ete, 312                      " Beurre de L'Assomption New French, 371</p>	<p>Pear, Beurre Woronzou, 214                      " Culture, 118                      " Dava's Hovey, 124                      " from H. A. Jackson, Cincinnati, O., 313                      " Lawrence, The, 274, 363                      " New, Brockworth Park, 57                      " Earle's Russett, 125                      " on Oak Roots, 121                      Orchard, Productive, 93, 320                      " Prof. Porter's, 307, 341                      " Pardee's Seedling, 214                      " Planting the Buifum, 122                      " Prickly, 316                      " Sheppard, 214                      " St. Francis Seigner, 214                      " Supposed Hybrid, A, 156                      " Trees, Fire Blight in, 54                      " Pruning, 53                      Pears, 69, 104, 175                      " at Boston, 23                      " Disease in, 6                      " for Market, 54                      " How to Grow, 196                      " Terrible Results of Meehan's Surface Root Culture of, 349                      " Value of some, 119                      " Winter Care of, 288                      Pearmain Apple, Cogswell, 214                      Penna. Fruit Growers' Society of, 31, 378                      " Horticultural Society, 31, 128, 158, 191, 224, 253, 352                      " " " May Meeting, 190                      Pennock, Early, Apple, 347                      Peoples Fruit, The, 78                      Persimmon—Diospyros Napi, the Japanese, 372                      Philadelphus, Double, 23                      Phyllotaxis, or the Law of the Arrangement of Leaves, 284                      Picea Frazeri, 89                      " Pichta, 24                      Pierson, Stephen, Death of, 118                      Pig, An Experiment upon a, 233                      Pine, Ground, 22                      " Trees, Disease in, 311                      Pink Blossoms from a White Germanium, 121                      Pinus Pungens, 273                      Pirates, After the, 53                      Pirater Plant, California, 149                      Pitch of Greenhouse Roofs, 123                      Plant Cabinets, Greenhouse and, 2                      " Case, Heater for, 329                      " Food, Manures or, 111                      " for Name, 212                      " Name of, 118, 119, 310, 311                      " New Edible—Sium Heleianum, 2-0                      " Inhaberogamous, the Organic Identity of the Albumen and Endopleura of all, 356                      " Rice Paper, 30                      Planting the Buifum Pear, 122                      Plants, Colored Lights on, 207                      " Blood-leaved, 206                      " Diseases of, 15                      " for Edging, 283                      " Names of, 22, 308                      " of scripture, An Abstract of Remarks upon the, 141                      Plaster for Strawberries, 250                      Plates, Our Colored, 56, 91                      Pleasanton's Gen., Paper, Brief Notes on, 269                      Plowden Peach, The, 245, 343, 345                      Plowden's Seedling Peach, 278                      Pluma, Columbia, The, 347                      " Denton, 279                      " Insects, 15                      " Minor and Wild Goose, The, 31                      " or Hinckley, The, 347</p>	<p>Plum Trees, To Keep the Curcution from, 144                      " Weeping, 123                      Pollen, Curious Results of Hybridization in, 123                      Polymnia Edulis, 15                      Pomace, Castor Oil, 21                      Pomological Society, American, 91, 212, 222, 351                      Poplar Tree, The Lombardy, 13                      Poplars, Purple Leaved, 24                      Population of Geneva, 123                      Port Lavaca, Tex., Climate of, 149                      Portrait of J. S. Downer, 368                      Potato Beetle, Colorado, Destruction of the, 208, 332                      " " " Crushing the, 277                      " Davis' Seedling, 283                      " in France, Introduction of the, 95                      " Native Georgian, 153                      Potatoes, American, in England, 61, 319                      " from the Seed Ball, the Raising of new Varieties of, 39                      " Late Rose, 375                      " Note on, 13                      Pot Plants for Summer Exhibition, Best, 63                      " Vines, 158, 316                      Pats, Anemones in, 254                      Practical Poultry Keeper, The, 183                      Preparation and Cultivation of the Soil, 297                      Preserving Fruit, 155                      President Beckmans, 342                      " Wilder Strawberry, 27                      Prickly Pear, 216                      Pride of the South Apple, 247                      Principle of Wardian Cases, The, 241                      Proceedings of Fruit Grower's Society of Pa., 25                      Products of the Andes, 377                      Production, How to Make Popular, 163                      " Ramie, 248                      Professor Porter's Pear Orchard, 307, 311                      Profit of Early Cucumbers, 284                      " Grape Culture, The cost and, 228                      " Grape Growing for, 367                      Promises of the Monthly, The, 52                      Pronunciation of Camellia, 369                      Propagating Aristolochia Siphon, 211                      " Bouvardias, 24                      " Irish Junipers, 24                      Proper Depth to Sow Seed, 268                      " Time to Plant Trees, The, 240                      Pruning Evergreens, 90                      " Hemlocks and Evergreens, 120                      " Pear Trees, 53                      " with Reference to Fruit Production, 79                      Purple Beech, 284                      " Leaved Poplars, 24                      Pyle Apple, 124</p> <p style="text-align: center;"><b>Q.</b></p> <p>Queen of Autumn, The, 350                      Quince, A Sweet, 57                      Quinces, 122</p> <p style="text-align: center;"><b>R.</b></p> <p>Raishes of Russia, The, 24                      Railway Cars, Heating, 122                      Rain in Various Climates Depth of, 252                      " of, 252                      Raising New Flowers, 310                      Ramie Production, 215                      Rare Trees, 338</p>	<p>Raspberries, 285                      " Herstine's, 246                      Raspberry, Hornet, 274                      " Souchetti's, Origin of, 181                      Recollections of South Australia, Oceania, 325                      " of Travel, 336                      " of Van Diemen's Land, Oceania, 166                      " Traveling, 16, 48, 84, 305 365                      Red Spider, Destroying, 370                      Remarkable Patent, A, 219                      Remarks on the Daphne Cneorum, 39                      Reminiscences of Australia, 131                      Retinospora, Arhorvite, &amp;c., Dwarf Varieties of, 247                      " Fitticoidee, 374                      " Filifera, 374                      Revivifying an Old Mushroom Bed, 255                      Rhododendron Bruckii Gracilis, 282                      Rhododendrons and American Plants, 184                      " Azaleas and, of Bloomsdale, 195                      " for the Conservatory, 188                      " Himalayan, in Ireland, 316                      " in Nature, 8                      Rice Paper Plant, 30                      Ripening and Decay of Fruit, 314                      " of Wood, Dryness of Soil an Aid to the, 75                      Rochester, Letter from, 333                      Road Making, etc., 53                      Robinson's Parks and Gardens of Europe, 55                      Rocky Mountain Evergreens, 55                      Root of Things, Looking at the, 307                      Roots and Water, 179                      " Caladium, 287                      " of Trees, Coal Gas and, 23                      " Vitality of, 221                      Rose, The, 60                      " Garden, 87                      " Tree, the Largest, 286                      " " Oldest, 283                      Roses, Climbing Hybrid Perpetual, 372                      " New, of 1871, 371                      Rural Carolinian, Credit to the, 91                      Ruralist, The, 213                      Russia the Radishes of, 24                      Rust, Blackberry, 211                      Rustic Trees, 72</p> <p style="text-align: center;"><b>S.</b></p> <p>Salisbury or Ginko Tree, 123                      Salting Asparagus, 23                      Salvia Heerii, 317                      Salway Peach, The, (with plate), 117                      Saponaria Ocyroides, 188                      Scabra or Gunnera Chilensis, 153                      Scarlet Laburnum, 62                      Screws, To fix, in Old Holes, 199                      scripture, Plants of, An Abstract of Remarks upon the, 111                      Season, Notes on the, 331                      Seed, Egg Plant, 280                      " Keeping, 143                      " Norway Spruce, Sowing, 210                      " Proper Depth to Sow, 268                      Seedling Apple, 21                      " Fruits, Patent Laws and, 22                      " Geraniums, 80                      " Gooseberry from S. S. Mercer, 311</p>
---	--	---	--

# THE GARDENER'S MONTHLY.

<p>Seedling Peaches, Improvement in, 314  " Peach, Plowden's, 278  Seedlings of Trees, Fruits, &amp;c., Raising, 268  Seeds, Early Germination of, 147  " The Monocotyledon, the Universal Type of, 261  Seedsman, Trial of a, 91  Shelter, 299  " for Rare Trees, 208  Sheppard Pear, 214  Shows, Lilies at the London, 251  Siberian Crab Apples, Improvement in, 311  Sieva Bean, 55  Silvery White Spruce, 368  Sinkholes, Utilizing, 209  Siuna Heienannu—New Edible Plant, 280  Size of Onions in England, 233  Small, Garden, Laying out a, 129  Snow Cactus, the, 22  Society's Catalogue, the, 361  Sod, the Effect of, in Keeping Soil Cool, 273  " Effects of, on the Temperature of the Soil, 376  Soil for <i>Magnolia glauca</i>, 369  <i>Solanum Chilianum</i>, 126, 171  Soucheit, Mr., Death of, 148  soucheitii Raspberry, Origin of, 181  Soup, Asparagus in, 24  Sour and Sweet, and Speckled Apples, 124  " Apples, 181  South Anstralia, Oceania, Recollections of, 325  Sowing Norway spruce seed, 210  " Nut Trees, 276  Sparrows, English, 330  Species, Origin of, 247  Speckled Apple, 26  Spinach, Stewed, 7  <i>Spirea Japonica</i>, 126  Spontaneous growth, 276  Sports in Vegetation, 336  Stayman's Summer Apple, 215  St. Francis seigner Pear, 214  St. Louis, Tower Grove Park, 21  Strawberries, Alpine, 155  " American and English Relative Fertility of, 369  " in Michigan, 248  " in Tennessee, 248  " of Dr. Nicaise, 156  " Plaster for, 250  Strawberry, Colfax, 21  " Cowling's, 348  " Seedling, 245  " Dr. Warder, 279  " Exhibition at Vine-land, N. J., 224  " Late, 119  " Monarch of the West, New, 152</p>	<p>Strawberry, New French, 372  " Peak's Emperor, 22  " President Wilder, 27  " Snow, Bliss', 210  " Trade, Overdoing the, 146  " Vicentese Hericart de Thury, 156  " Rare, 338  " Rustic, 72  " Shelter for Rare, 208  " Sowing Nut, 276  " The Proper Time to Plant, 240  " Transplanting, 201  " Willow, 99  Trial of a Seedsman, 91  <i>Tritoma Uvaria</i>, 210  Tropical Heat Derived from the Earth, 235  Tulips, Early, 288</p> <p style="text-align: center;"><b>U.</b></p> <p>Unger, M., Death of, 18  Utah, Peaches in, 249  Utilizing Sinkholes, 209  Use for Tree Trimmings, 20  Uses of Fungus, 78</p> <p style="text-align: center;"><b>V.</b></p> <p>Value of Some Pears, 119  <i>Vanda Cœrulescens</i>, 153  " <i>Denisoniana</i>, 153, 348  Van Dieman's Land, Oceania, Recollections of, 166  Van Houtte's, <i>Flores des Serres</i>, 152  Variations, Bud, 43  Variegated Maples, 309  Varieties, Hybrids and, 122  " of <i>Althea</i>, Splendid, 200  " of Asparagus, 90  " of the Fig, 314  Vegetable Garden, 36, 67, 99, 131, 162, 195, 226, 261, 292, 323, 356  Vegetables, How to Cook, 64  Vegetation, Electricity in, 234  " Sports in, 336  Veitch, Jno., Gould, 189  " Death of, 158  Verbena, Native Country of the, 211  <i>Viburnum Plicatum</i>, 21  Vicentese Hericart de Thury Strawberry, 156  <i>Victoria Regia</i>, 377  Vilmorin, Andreux &amp; Co., of Paris, 275  " M., Death of, 118  Vine, A Giant Grapes, 216  " Mildew of Europe, The, 54  Vine-land, N. J., Strawberry Exhibition at, 224  " Weekly, 123  Vines, Pot, 158, 136  Violet Rays upon a Grapery, 231  Violets, Note on Growing, 6</p>	<p>Virginia, Grape Culture in, 55  " Peaches in, 182  Vitality of Evergreen Seeds, 21  " of Roots, 221</p> <p style="text-align: center;"><b>W.</b></p> <p>Warder, Dr., Strawberry, 279  Wardian Cases, the Principles of, 241  Worm, Dry Seasons, Influence of, 297  Water Cress, English, 5  " Lilies, Chinese, 144  " Roots and, 179  Watermelon, The, 270  Waukegan, Ills., Discoveries of Ancient Bones at, 41  Wealthy Apple, The, 27  Weeping Plum, 123  Well Ripened Tomatoes 42  Western Farmer, 25  West, Manuring in the, 211  What I know about Farming, 183  White Geranium, Pink Blossoms from a, 121  " Flowered Larch, 145  " Spruce, Silvery, 368  Wilder, Mar-hall P., Address of, 235  Wild Goose Plum, the Wilder and, 348  Willow Bark, 377  " Trees, 99  Willows Hating Water, 211  Wine Grapes, the Best, 217  Winter Care of Pears, 288  " Evergreens for, 40  " Flowers, 133  " Keeping Coleus through, 344  Wire Fences, 121  Wisteria, New Double, 152  " Sincensis, Flowering of a, 121  " Large, 62  Wodenetha, Fruit Culture at, 265  Woods of China, 21  Worcester Co., Mass., Horticultural Society, 182  " Fruit Farm, A, 286  World, the Insect, 376  Writing for Copies of the Monthly, 89  Wylie's, Dr., Hybrid Grape, 55, 279</p> <p style="text-align: center;"><b>X.</b></p> <p><i>Xanthoeceras Sorbifolia</i>, 153</p> <p style="text-align: center;"><b>Y.</b></p> <p>Yellow Asphodel, The, 182  " Locust, The, 24  " St. John Peach, 279  Yellows in Peach Trees, The, 144  Young, Gardening for the, 8  Yews, the Golden and Silver, 165</p>
---	---	---

END OF VOLUME XIII.











