



3 2044 105 179 634

Library
Arnold Arboretum



of

Harvard University

THE GARDENS' BULLETIN SINGAPORE

VOL. XXXII

1979

CONTENTS

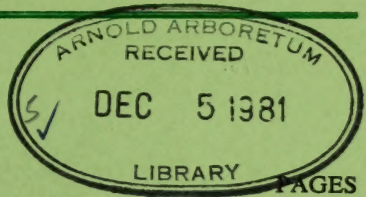

CATHERINE WOON & HSUAN KENG:

Observations on Stamens of the Dipterocarpaceae 1

Y. C. WEE: Check list of Mosses of Singapore 56

S. C. CHIN: The Limestone Hill Flora of Malaya II 64

*Published by Botanic Gardens
Parks & Recreation Department
Singapore*

Printed by Amsterdam Type Printers, Singapore.

GARDENS' BULLETIN

EDITORIAL BOARD

- Chairman:* Y.K. Wong, B.Sc. (Hons.) (Singapore), M.A. (Oxon),
M.S.I. Biol.
- Editor:* H. Singh, B.Sc. (Hons.) (Singapore), M.S. (Hawaii),
M.S.I. Biol.
- Members:* S.E. Chua, B.S.A., M.S.A. (Toronto), Ph.D. (Singapore),
M.I. Biol., M.S.I. Biol.
- C.H. Kee, B.Sc. ((Hons.), Dip. Bus. Admin.,
Cert. Edu. (Singapore), M.S.I. Biol.
- H. Keng, B.A., M.Sc. (China), Ph.D. (California),
M.S.I. Biol.
- S.Y. Ng, B.Sc. (Hons.) M.Sc. (Singapore),
Dip. Hort. Sc. (New Zealand).
- Secretary and
Business Manager:* K.K. Phua, B.Sc. (Hons.) (Singapore), M.S.I. Biol.

The Gardens' Bulletin is a publication of the Parks and Recreation Department, Singapore. Neither the Department nor the Editorial Board is responsible for the opinion expressed by the authors.

The price of the Journal is \$15.50 per number. For overseas orders, an additional \$1.60 to cover overseas postage and registered post fee is chargeable for every copy of the Journal. Overseas subscribers are requested to make payment in Bank Drafts or International Money Orders to the Commissioner of Parks and Recreation, Singapore.

All correspondence concerning advertisements and exchange should be addressed to:—

The Business Manager,
Gardens' Bulletin,
Parks and Recreation Department,
Ministry of National Development,
19th Floor, National Development Building,
Maxwell Road,
Singapore.

THE GARDENS' BULLETIN SINGAPORE

VOL. XXXII

1979

CONTENTS

PAGES

CATHERINE WOON & HSUAN KENG:

Observations on Stamens of the Dipterocarpaceae 1

Y. C. WEE: Check list of Mosses of Singapore 56

S. C. CHIN: The Limestone Hill Flora of Malaya II 64

*Published by Botanic Gardens
Parks & Recreation Department
Singapore*

Printed by Amsterdam Type Printers, Singapore.

THE GARDENS BULLETIN

*Waterfalls
at the Shangri-La Hotel*



Just another creation by ...
GARDEN & LANDSCAPE CENTRE



LANDSCAPE CONSULTANTS
LANDSCAPE CONTRACTORS
GARDEN MAINTENANCE SERVICE

617, BUKIT TIMAH ROAD, 7.5Km., SINGAPORE 10. TEL. - 669954/672821.

PHOTOGRAPH BY ...

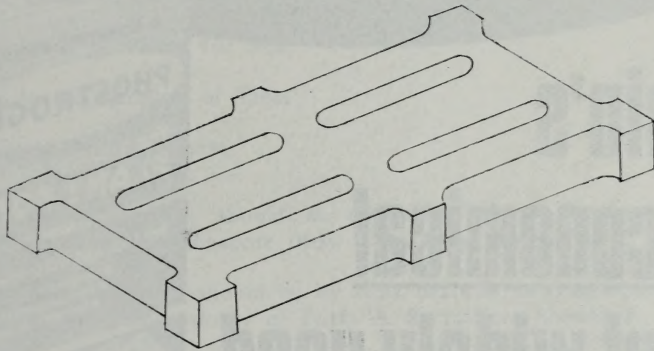

Pre-cast reinforced concrete slab
(with abutting corners)
Size: 670 mm x 300 mm x 65 mm
Reinforcement 10 mm \varnothing MS BAR

The above type of slab is used for
aeration in carparks, footpath & gardens.

卓金木工程

TOH KIM BOCK (GENERAL CONTRACTOR)

348G, Blk 1, Balestier Hill Shopping Centre

Singapore 1130

Tel: 2535319 & 2535329

HYDROPONICS .

USE —

PHOSTROGEN

is Britain's
most economical
and most widely used
garden plant food

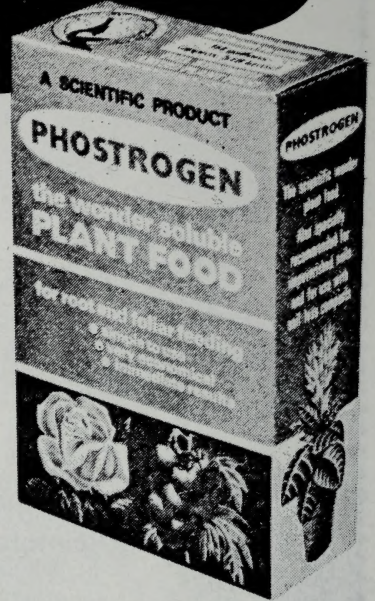

Because*

* **IT SAVES YOU** the need to buy one plant food for root feeding and another for foliar feeding—it is highly successful for both, and as top dressing.

* **IT SAVES YOU** the need to buy separate plant foods for different subjects—it is a scientifically balanced all-purpose plant food—excellent as a starter solution for seeds and seedlings, for flowers, vegetables, shrubs, lawns and even established trees, and also for pot plants.

* **IT SAVES YOU** a great deal of money—you obtain far more gallons of full strength solution per penny than from any other soluble or liquid Plant Food.

* **IT SAVES YOU** labour—you just water it in at the rate of one level teaspoon to a 2 gallon watering can—no smell, no trouble.

* **IT SAVES YOU** worry about impoverished soils—it is a scientific soil restorer derived from a formula for growing plants without soil—HYDROPONICS CULTURE.

* **IT SAVES YOU** waiting time—it works fast, showing a noticeable improvement after just one application.

TRY IT YOURSELF — YOU WILL NEVER BE SATISFIED WITH ANY OTHER PLANT FOOD

FURTHER INFORMATION AND FREE BROCHURES ARE AVAILABLE FROM:

Sole Agents: **THE GARDEN SUPPLY CENTRE**

617, Bukit Timah Road, 4¼ m.s., Singapore, 10.

Telephone: 669954/672821

PARKS AND RECREATION DEPARTMENT

PUBLICATIONS FOR SALE

TITLE	PRICE PER COPY*
<input type="checkbox"/> Selected Plants & Planting for a Greener Singapore	\$0.60
<input type="checkbox"/> Selected Plants & Planting for a Garden City — Forty Shrubs	\$1.20
<input type="checkbox"/> Selected Plants & Planting for a Garden City — Forty Climbers	\$3.00
<input type="checkbox"/> Pictorial Guide to the Singapore Botanic Gardens	\$2.00
<input type="checkbox"/> A Revised List of Plants for Sale	\$0.30
<input type="checkbox"/> A Guide to the Aeration of Trees	\$1.00
<input type="checkbox"/> Bukit Timah Nature Reserve	\$0.60

Requests for the publications should be addressed to the Commissioner of Parks & Recreation, Maxwell Road, Singapore 0106, Republic of Singapore.

For overseas orders, payment should be by bank draft or International Money Order and made payable to the Commissioner of Parks & Recreation, Singapore.

* Prices quoted are in Singapore Dollars.
For overseas orders — postage extra.

HAI JOO CONTRACTOR CO.

41, JALAN BINCHANG,
SINGAPORE, 2057.

WE PROVIDE SERVICES FOR ALL KINDS OF
HORTICULTURAL WORK

- PLANTING
- TURFING
- MAINTENANCE OF
LANDSCAPE WORKS

OBSERVATIONS ON STAMENS OF THE DIPTEROCARPACEAE

by

CATHERINE WOON AND HSUAN KENG

Department of Botany

University of Singapore

CONTENTS

	<i>Pages</i>
Introduction	2
Materials and methods	2
Description of stamens	3
Generalisations and discussion	42
Appendix: A list of voucher herbarium specimens for studies	52

A. INTRODUCTION

The Dipterocarpaceae are a medium-sized family of approximately 15 genera and 580 species (Airy-Shaw, 1973). They are distributed over a large area of tropical Africa and the Indo-Malayan region from India, Ceylon, Indo-China, S.W. China to Malesia. In Malesia, according to Symington (1943) there are 14 genera and 168 species in the Malay Peninsula, 13 genera and 276 species in Borneo, 11 genera and 52 species in the Philippines, and 3 genera and 5 species in New Guinea.

The distribution of this family is interesting because it links the flora of tropical Asia with that of tropical Africa where 2 genera *Monotes* and *Marquesia* are present. Croizat (1952, p. 423) suggested that the dipterocarps are most certainly of Gondwanic origin, and they evolved and migrated from the continental mass that once occupied part of the Indian Ocean 100–500 million years ago. They later broke up into 2 major taxa, the Dipterocarpoideae, mostly confined to the continental Asia and Malesia, and the Monotoideae, restricted to Africa. They occur in areas which have had a relatively stable geology since the Cretaceous, probably the time of their origin (Meijer, 1974).

This family is especially noted for its many valuable timbers such as Meranti (*Shorea*), Keruing (*Dipterocarpus*) from Malaya, Serayas and Lauans (*Shorea* and *Parashorea*) from Borneo and the Philippines.

The existing schemes of classification of the Dipterocarpaceae are largely based on the gross morphology. It is hoped that the comparative studies of the stamens of various genera of dipterocarps, together with the information gathered from wood, pollens, cytology, embryogeny, phytochemistry and others, might eventually contribute towards a natural classification of the family.

This is an excerpt of the senior author's Honours' dissertation entitled "Comparative studies on the stamens and pollen grains of the Dipterocarpaceae", Department of Botany, University of Singapore, 1977–78. She wishes to thank Professor A.N. Rao of the Department for providing all the facilities, and to thank the Directors and Curators of the Herbarium of the Botanic Gardens, Singapore, the Forest Research Institute, Kepong, Malaya and the Forest department, Kuching, Sarawak, for having kindly supplied flowering materials for this study. Her thanks are also due to Mr. D. Teow for making photographs, and to Mr. J. Wee for advice on microtechniques.

B. MATERIALS AND METHODS

The study includes stamens of 42 species belonging to 13 genera of the Asiatic subfamily Dipterocarpoideae. The number of species investigated in each genus was as follows:

1. *Anisoptera* (2)
2. *Cotylelobium* (2)
3. *Dipterocarpus* (3)
4. *Doona* (2)

5. *Dryobalanops* (2)
6. *Hopea* (7)
7. *Neobalanocarpus* (1)
8. *Parashorea* (2)
9. *Pentacme* (1)
10. *Shorea* (15)
11. *Upuna* (1)
12. *Vateria* (1)
13. *Vatica* (3)

Dried flowers and flower buds were obtained from the herbarium specimens. A list of the voucher specimens are given at the end.

The dried flowers and buds were soaked and boiled in water till soft. The indehiscent stamens were then removed from the flowers under a dissecting microscope, using fine needles and forceps. The method of clearing was by modification of Foster's clearing techniques (1949). Serial sections of the flower buds to show the transverse sections of *Neobalanocarpus heimii* and *Shorea parvifolia* were obtained by the paraffin method (Johansen, 1940). Sections were cut by means of the rotary microtome and these were stained with a combination of Safranin and Fast-green.

This study of the stamens is based on representative species of most of the genera of the family. Descriptions of the genera are presented in alphabetical order. Only in the genus *Shorea*, four sections (Symington, 1943) are further described separately. The general description for each genus presented is based on and confined to the representative species investigated. For *Shorea*, the general features for each section is also described based on the species studied.

C. DESCRIPTION OF STAMENS

Descriptions of the stamens include the general morphology, dimensions, and vasculature. Different parts of the stamen, such as the anthers, filaments and appendages to the connectives are also measured and described. The total lengths of the stamens include the appendages unless otherwise stated. The measurements were made in millimetres or in microns. Illustrations of the stamens of the species examined are prepared based on the revived herbarium materials, cleared in dilute sodium hydroxide and preserved in xylene. Details of the stamen (e.g. hairs and vasculature) are observed under the high magnification of a compound microscope.

1. ANISOPTERA KORTH.

About 13 species; East India, South East Asia to West Malesia. The following 2 species have been studied:

- (1) *Anisoptera curtisii* Dyer (Section *Pilosae*) (Fig. 1, a-d; Fig. 2, b-c);
- (2) *Anisoptera laevis* Ridl. (Section *Glabrae*) (Fig. 1, e-i; Fig. 2, a).

FIG 1

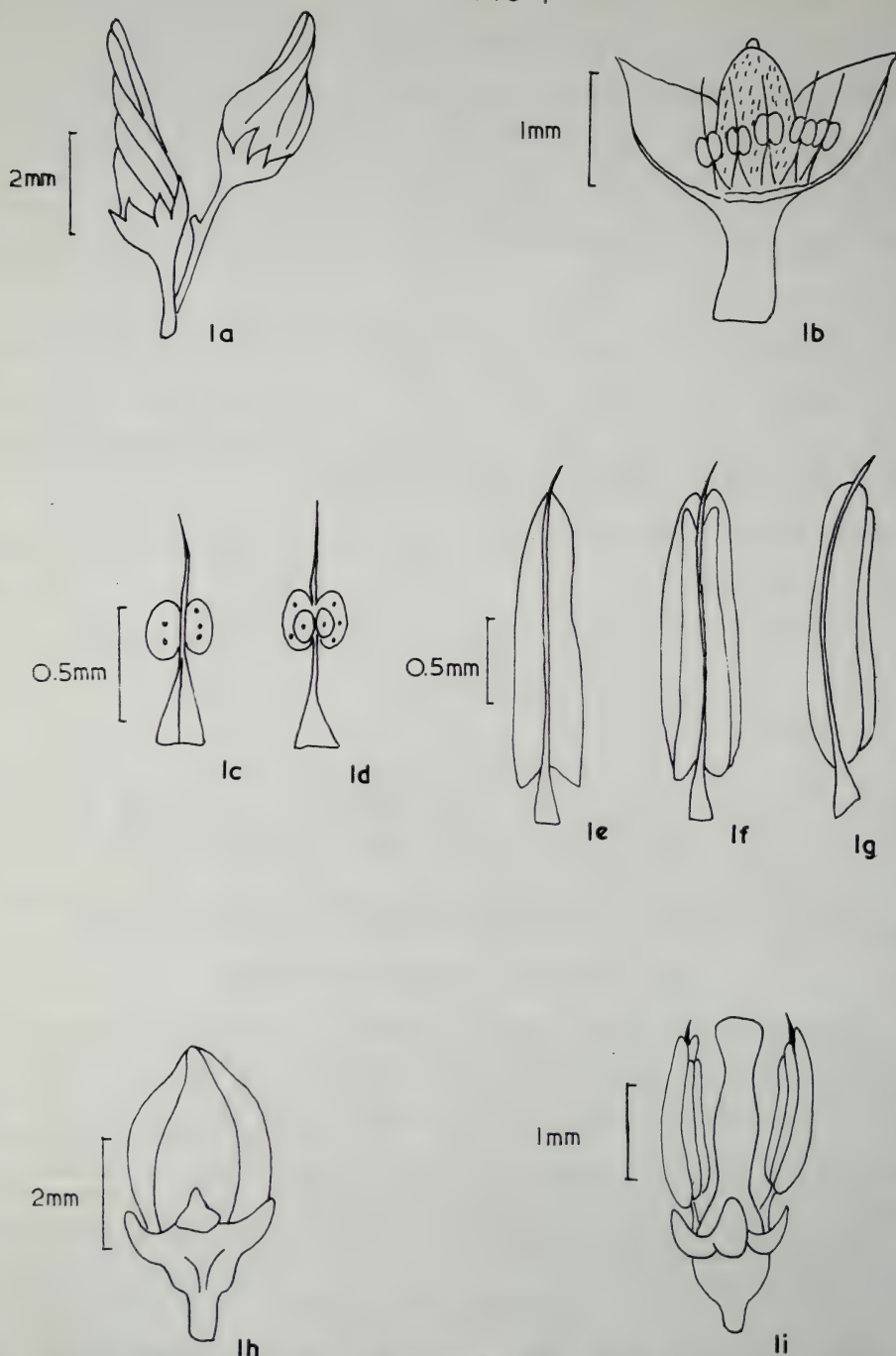
**ANISOPTERA**

A. curtisii a. flower bud. b. flower with parts of perianth removed to show arrangement of stamens. c. abaxial view of stamen. d. adaxial view of stamen. *A. laevis* e. abaxial view of stamen. f. adaxial view of stamen. g. oblique lateral view of stamen. h. flower bud. i. flower with perianth removed to show arrangement of stamens.

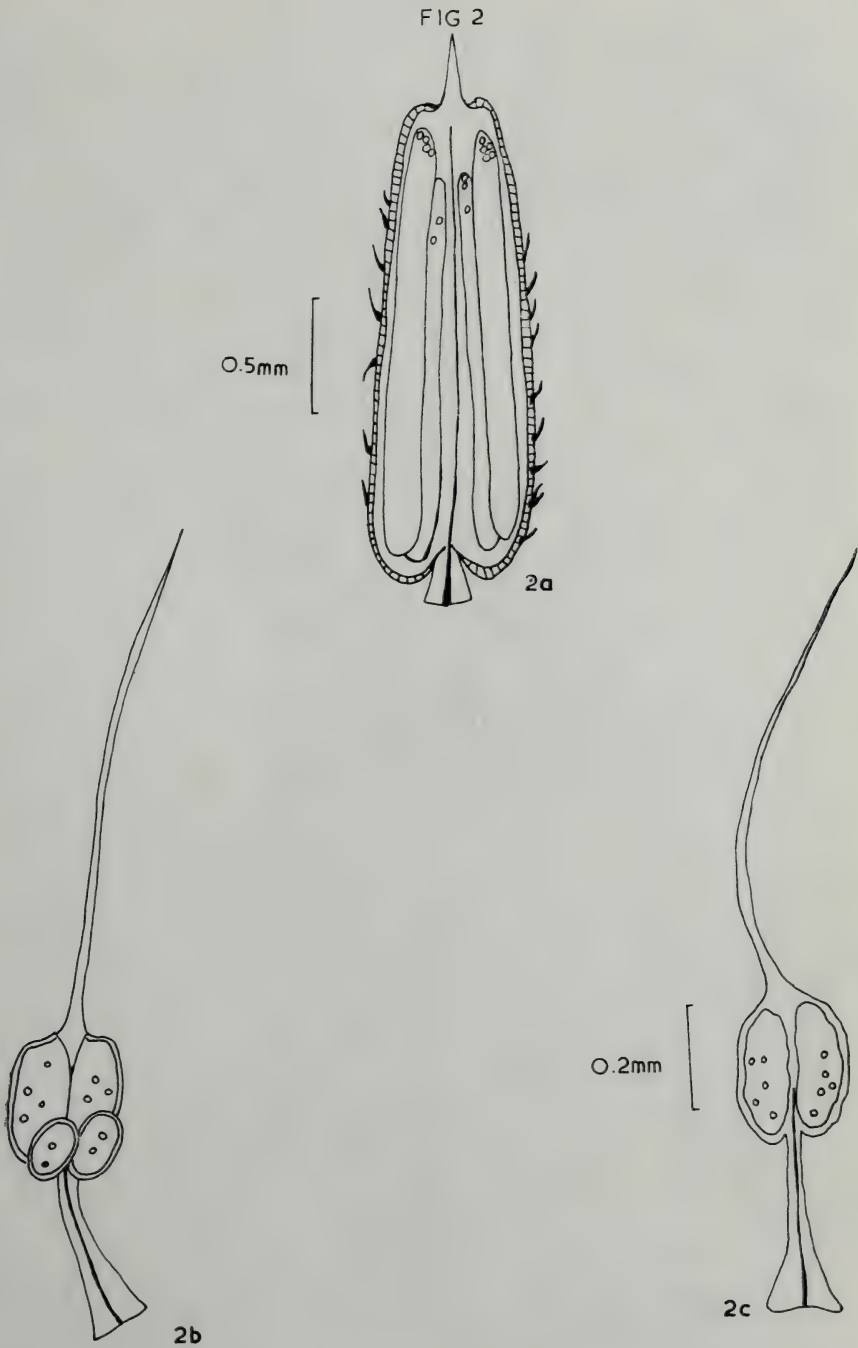

ANISOPTERA

Stamens. x 100

a. *A. laevis* : abaxial view. b. *A. curtisii* : adaxial view. c. *A. curtisii* : abaxial view.

FIG 3

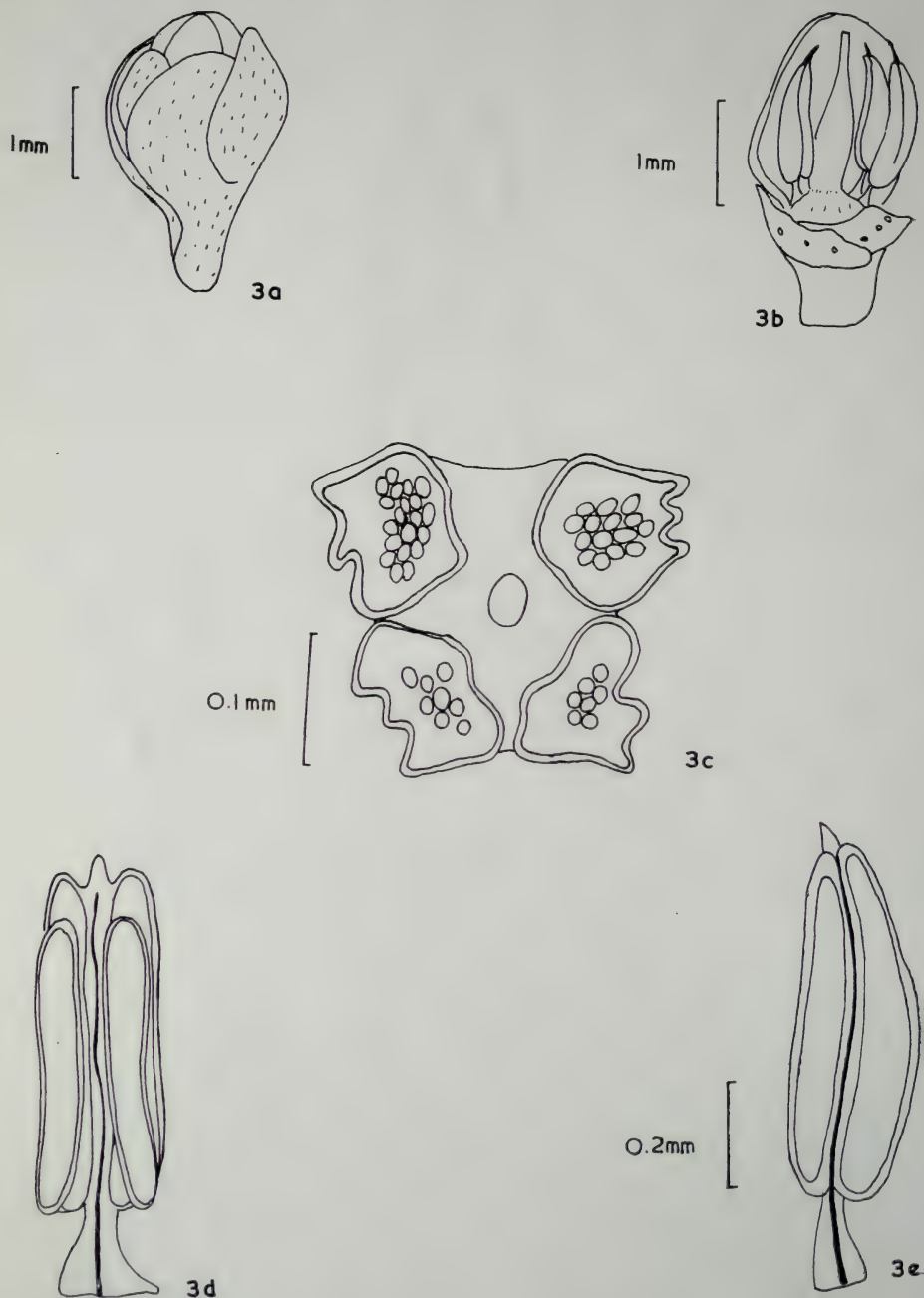
*NEOBALANOCARPUS*

N. heimii (= *Balanocarpus heimii*) a. flower bud. b. flower with perianth removed to show arrangement of stamens. c. transverse section of stamen. d. adaxial view of stamen. e. lateral view of stamen.

FIG 4

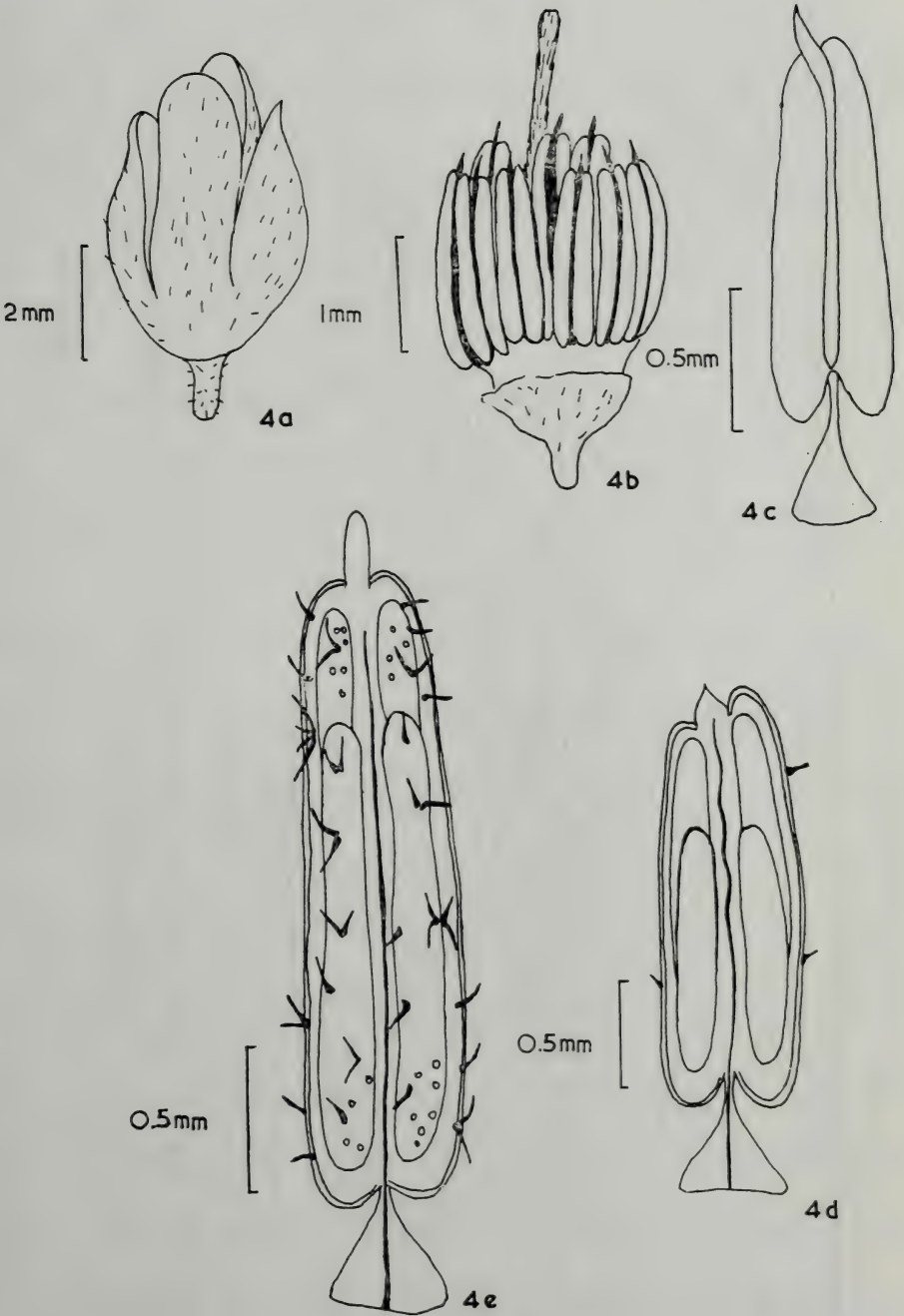

COTYLELOBIUM

C. malayanum a. flower bud. b. flower with perianth removed to show arrangement of stamens. c. abaxial view of stamen. d. stamen x 100. *C. burckii* e. stamen x 100.

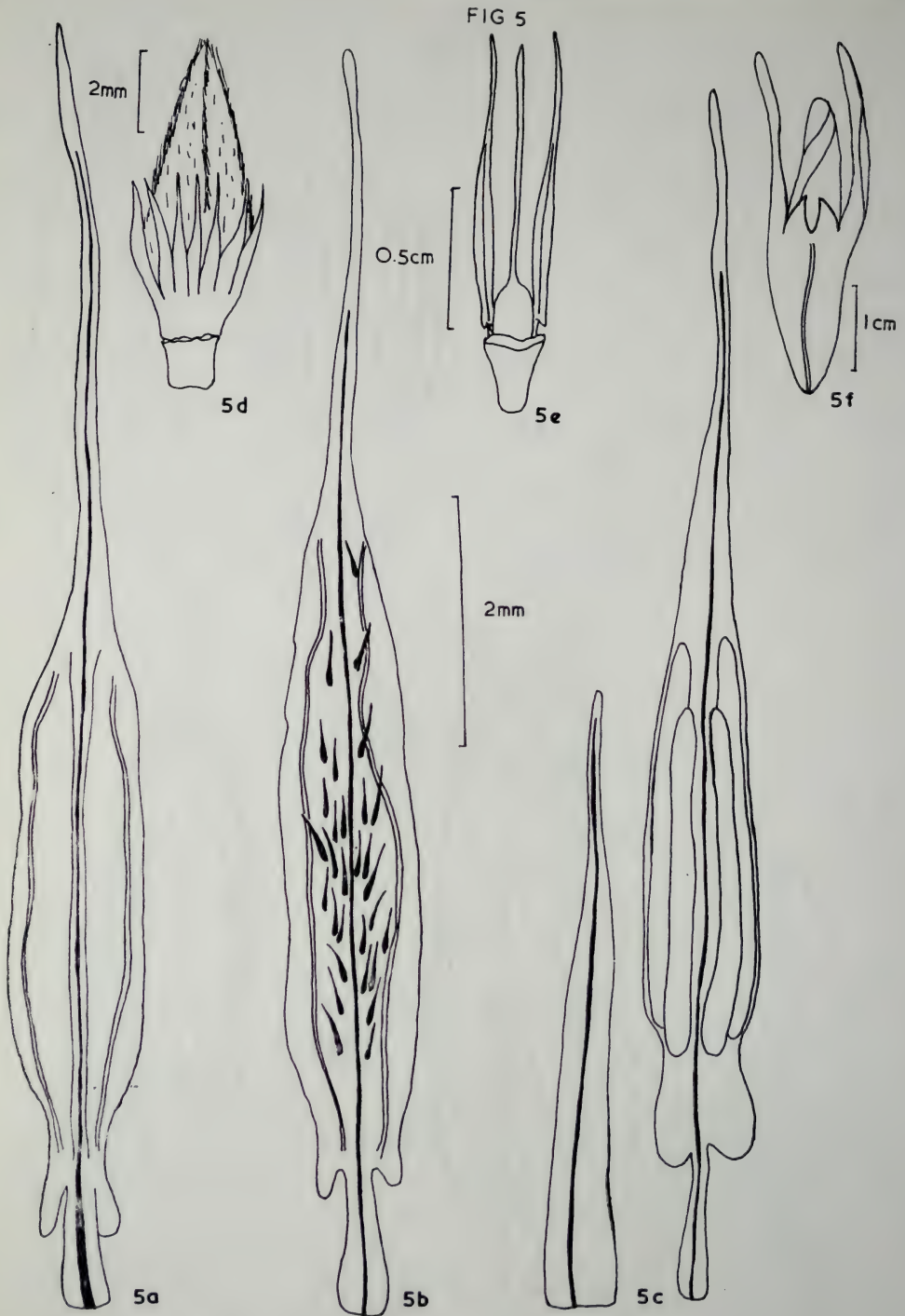

DIPTEROCARPUS

D. gracilis a. stamen : adaxial view.

D. kunstleri b. stamen : abaxial view. e. flower with perianth removed to show position of stamens.

D. oblongifolius c. staminode and adaxial view of stamen. d. flower with perianth and stamens removed to show ring of staminodes. f. flower bud.

Stamens: 15–30 in number, arranged in 2 or 3 whorls; glabrous; unequal, outer stamens shorter than the inner ones.

Filaments: short, compressed; gradually attenuate above.

Anthers: 4 loculed; locules linear-oblong (Section *Glabrae*) or broadly elliptic-ovoid (Section *Pilosae*); unequal, abaxial anther sacs larger than adaxial ones.

Appendages: short acuminate tip or a very long, subulate awn; glabrous.

Vasculature: single vascular bundle between the anther sacs ending near the base of appendage to connective.

2. *COTYLELOBIUM* PIERRE

About 5 species; Ceylon and West Malesia. The following 2 species have been studied:

(1) *Cotylelobium burckii* (Heim) Heim (Fig. 4, e);

(2) *Cotylelobium malayanum* V. Sl. (Fig. 4, a-d).

Stamens: 15 in number, arranged in 2 whorls; unequal, inner 5 slightly longer than the outer ones.

Filaments: short, dilate at the base, more or less deltoid.

Anthers: 4 loculed; the locules linear-oblong; unequal, abaxial anther sacs longer than the adaxial pair; hispid.

Appendages: connective prolonged apically to a short mucro, often bent to one side, subulate or conic, glabrous.

Vasculature: single vascular bundle between the anther sacs, ending near the appendage to connective.

3. *DIPTEROCARPUS* GAERTN. f.

About 76 species; India, Ceylon to West Malesia. The following 3 species have been studied:

(1) *Dipterocarpus gracilis* Bl. (Fig. 5, a);

(2) *Dipterocarpus kunstleri* King (Fig. 5, b & e);

(3) *Dipterocarpus oblongifolius* Bl. (Fig. 5, c, d & f).

Stamens: 15–36 in number, arranged in 2–3 whorls; hypogynous; sometimes an outer ring of staminodes present.

Filaments: short, compressed, gradually or abruptly tapering above to broad base.

Anthers: 4 loculed; the locules linear-oblong, vertically orientated, unequal, introrse, dehiscing laterally; the basal portion of the anthers with sterile tissue, fleshy, usually auriculate.

Appendages: appendage erect, long and tapering, produced from apical sterile tissues of anthers; glabrous.

Vasculature: single vascular bundle between the anther sacs, usually ending within the appendage. Staminodes also supplied by a single vascular trace.

4. *DOONA* THW.

Over 10 species; endemic to Ceylon. The following 2 species have been studied:

- (1) *Doona gardneri* Thw. (Fig. 6, a, b, e, f, g; Fig. 7, a-c);
- (2) *Doona macrophylla* Thw. (Fig. 6, c, d, h, i; Fig. 7, d).

Stamens: 15 in number; arranged in 2 whorls around the ovary, all exceeding the style.

Filaments: compressed, loricata, tapering gradually above.

Anthers: 4 loculed, the locules fusiform or elongated; unequal, abaxial anther sacs slightly longer than adaxial pair; latrorse; dehiscing longitudinally.

Appendages: appendage stout, fleshy, clavate.

Vasculature: single vascular bundle between the anther sacs, branching out within the appendage.

5. *DRYOBALANOPS* GAERTN. f.

About 9 species, confined to Sumatra, Malaya and Borneo. The following 2 species have been studied:

- (1) *Dryobalanops aromatica* Gaertn. f. (Fig. 8, a-f; Fig. 9, a);
- (2) *Dryobalanops oblongifolia* Dyer. (Fig. 8, g-i; Fig. 9, b).

Stamens: 30 in number, arranged compactly in 3 whorls; unequal, the innermost whorl longest; hypogynous.

Filaments: long, compressed, applanate; tapering abruptly above, connate at the base.

Anthers: 4 loculed; the locules linear-oblong, apiculate at both ends; unequal, the abaxial anther sacs much longer than the adaxial pair; introrse; dehiscing longitudinally.

Appendages: acumen short, erect, stout, cuspidate; exceeding the anther apex.

Vasculature: staminal bundle in *D. oblongifolia* branches out to give rise to 3 vascular traces. Each stamen is served by single vascular trace which ends near the appendage to connective.

6. *HOPEA* ROXB.

Over 90 species, South India to South China and the Malay Islands. The following 6 species have been studied:

- (1) *Hopea apiculata* Sym. (Fig. 10, a, b, c; Fig. 12, e);
- (2) *Hopea beccariana* Burck. (Fig. 10, d, e, f; Fig. 12, b);

FIG 6

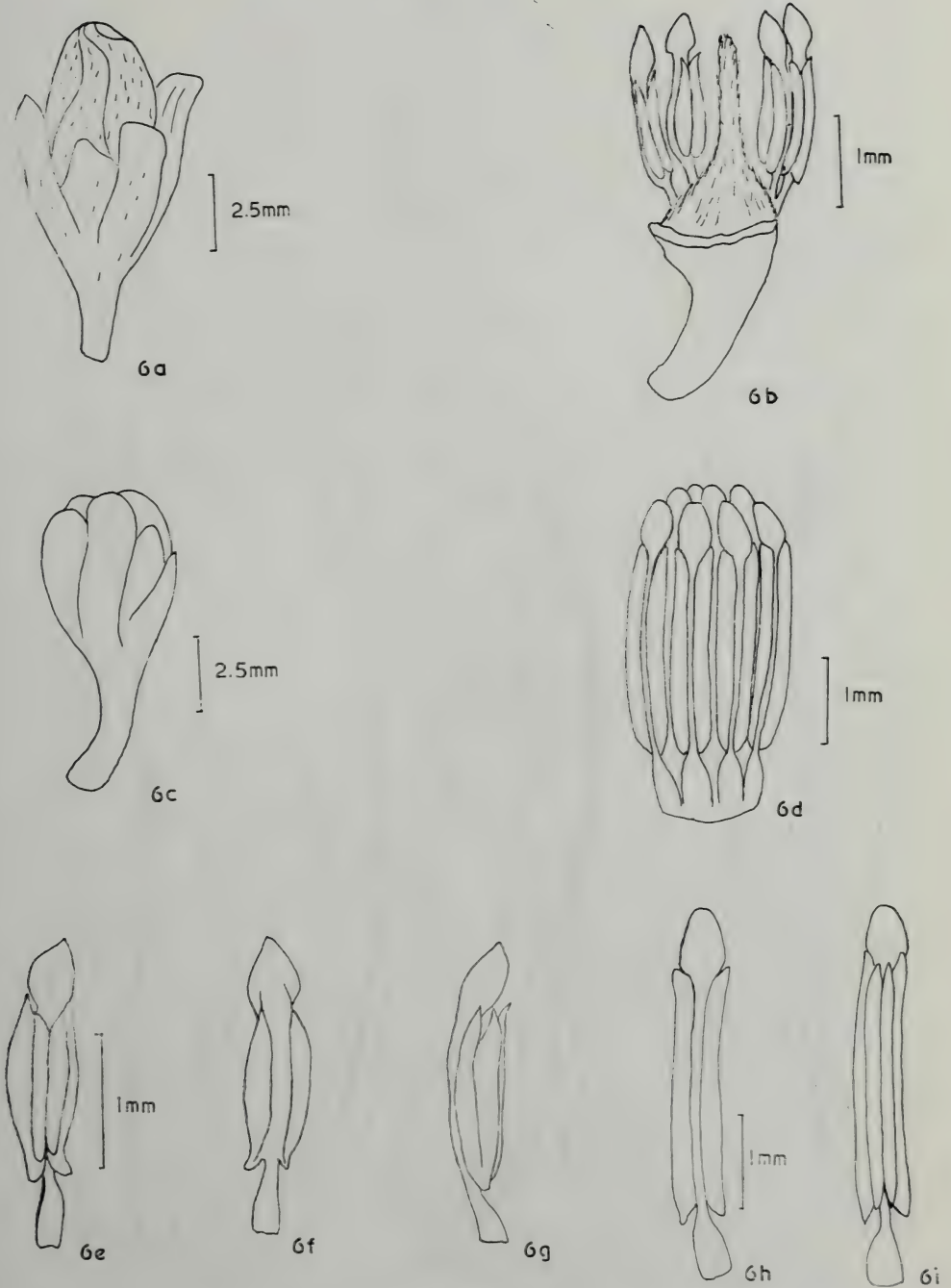

DOONA

D. gardneri a. flower bud. b. flower with perianth removed to show position of stamens. e. adaxial view of stamen. f. abaxial view of stamen. g. lateral view of stamen.

D. macrophylla c. flower bud. d. flower with perianth removed to show arrangement of stamens. h. abaxial view of stamen. i. adaxial view of stamen.

FIG 7

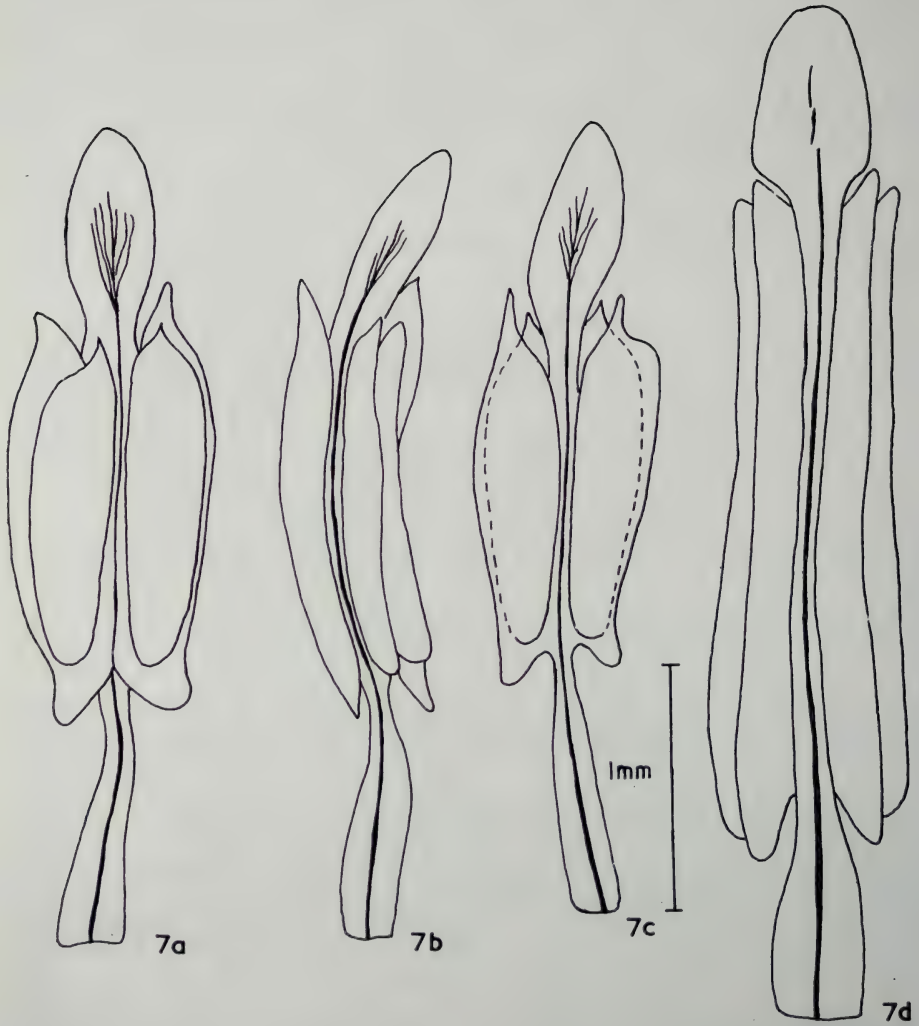
*DOONA*

D. gardneri a. adaxial view of stamen. b. lateral view of stamen. c. abaxial view of stamen.
D. macrophylla d. abaxial view of stamen.

FIG 8

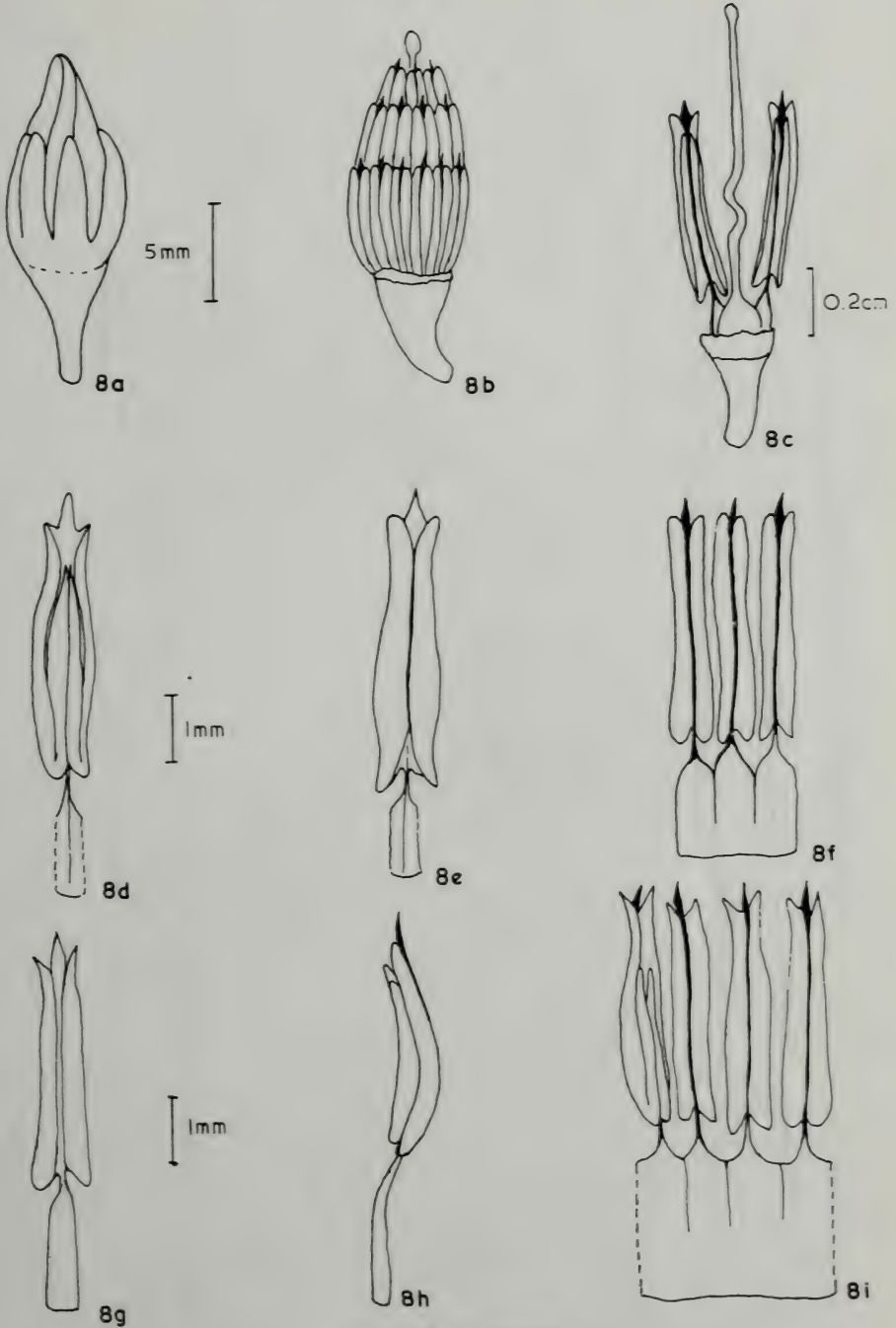

DRYOBALANOPS

D. aromatica a. flower bud. b., c. flower with perianth removed to show position of stamens. d. stamen : adaxial view. e. stamen : abaxial view f. partial whorl of stamens with connate filaments.
D. oblongifolia g. abaxial view of stamen. h. lateral view of stamen. i. partial whorl of stamens with connate filaments.

FIG 9

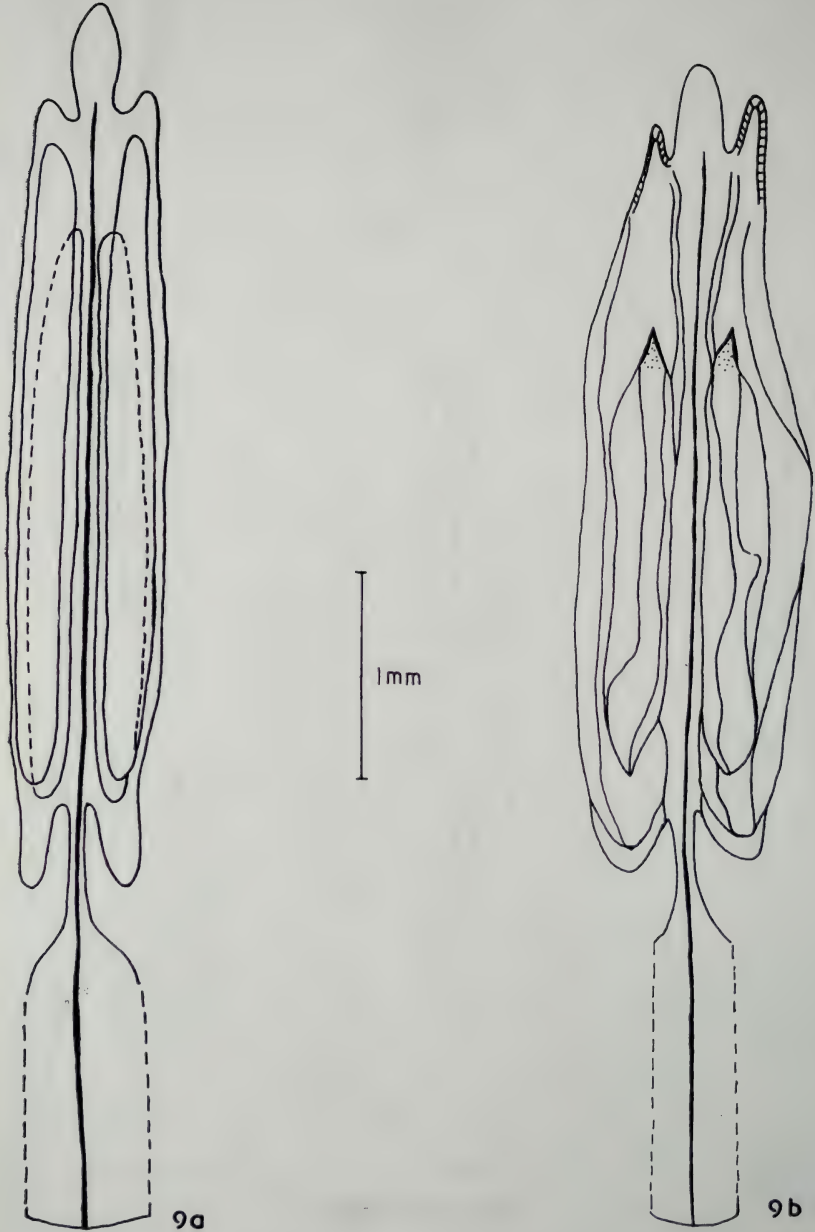

DRYOBALANOPS

Stamens. x 100

a. *D. aromatica* : adaxial view. b. *D. oblongifolia* : adaxial view.

FIG 10

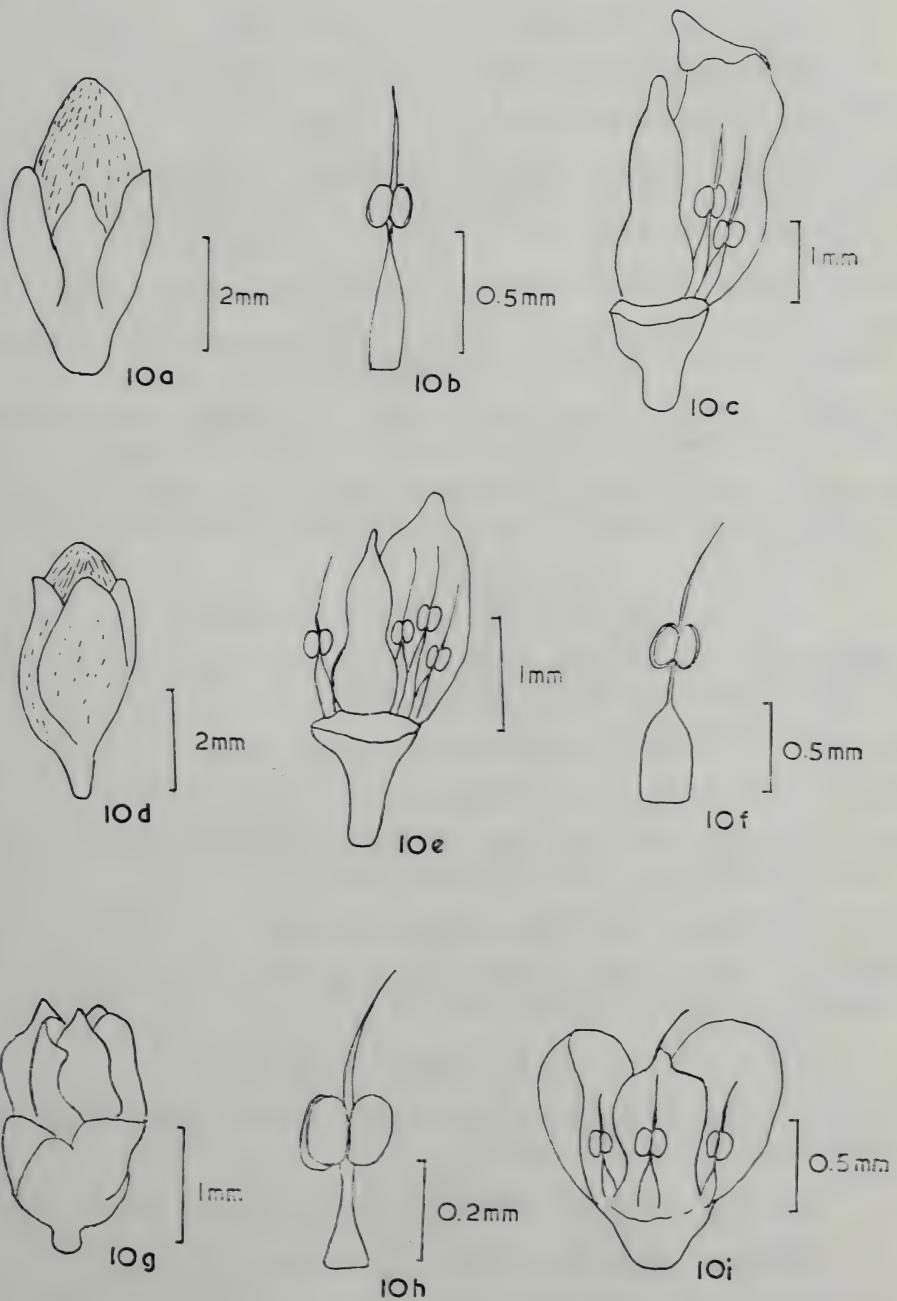

HOPEA

H. apiculata a. flower bud. b. stamen — abaxial view. c. flower with parts of perianth removed to show arrangement of stamens.
H. beccariana d. flower bud. e. flower with parts of perianth removed to show arrangement of stamens. f. stamen — adaxial view.
H. minima g. flower bud. h. stamen — abaxial view. i. flower with parts of perianth removed to show arrangement of stamens.

- (3) *Hopea minima* Sym. (= *Balanocarpus curtisii* King) (Fig. 10, g, h, i; Fig. 12, d);
- (4) *Hopea nutans* Ridl. (Fig. 11, j, k, l; Fig. 12, a);
- (5) *Hopea odorata* Roxb. (Fig. 11, m, n, o; Fig. 12, c);
- (6) *Hopea sangal* Korth. (Fig. 11, p, q, r; Fig. 12, f).

Stamens: similar to *Shorea*, especially the Meranti Pa'ang group; long appendages present, sometimes minutely setose; usually 15 in number (but 10 in *H. sangal*), arranged in 2 whorls; unequal, usually epipetalous.

Filaments: broad, compressed; abruptly narrowed towards the anthers.

Anthers: 4 loculed; the locules ovate or subglobose; equal or unequal, the abaxial anther sacs larger than the adaxial ones.

Appendages: usually at least twice as long as the anthers, produced apically into a long, slender, subulate awn, glabrous or minutely setose.

Vasculature: stamens supplied with single vascular trace; traces of epipetalous staminal bundles fused with the vascular bundle in the corolla tube at the base.

7. *NEOBALANOCARPUS** P.S. ASHTON

One species; endemic to the Malay Peninsula. The type species, *Neobalanocarpus heimii* Ashton (Fig. 3, a-e) has been studied.

Stamens: 15 in number, not exceeding the length of style.

Filaments: short, compressed, deltoid.

Anthers: 4 loculed; the locules linear-oblong; unequal, the abaxial pair longer than the adaxial pair; dehiscent longitudinally.

Appendages: acumen short, blunt, projecting apically.

Vasculature: single vascular bundle between the anther-sacs, ending near the base of appendage to the connective.

8. *PARASHOREA* KURZ

Over 10 species, in South East Asia and the Western Malay Islands. The following 2 species have been studied:

- (1) *Parashorea malaanonan* (Blanco) Merr. (Fig. 13, a-d; Fig. 14, a);
- (2) *Parashorea stellata* Kurtz (Fig. 13, e-h; Fig. 14, b).

**Neobalanocarpus* is a new genus recently established by Dr P. S. Ashton (in Gard. Bull. Singapore 31: 27, 1978). It contains only one species, *N. heimii* (King) Ashton, formerly known as *Balanocarpus heimii* King. The genus *Balanocarpus* (excluding this Malayan species) with about 15 species, occurring from India to West Malesia, has been reduced to *Hopea* by Bole (in Kew Bull. 1951, p. 146).

FIG II

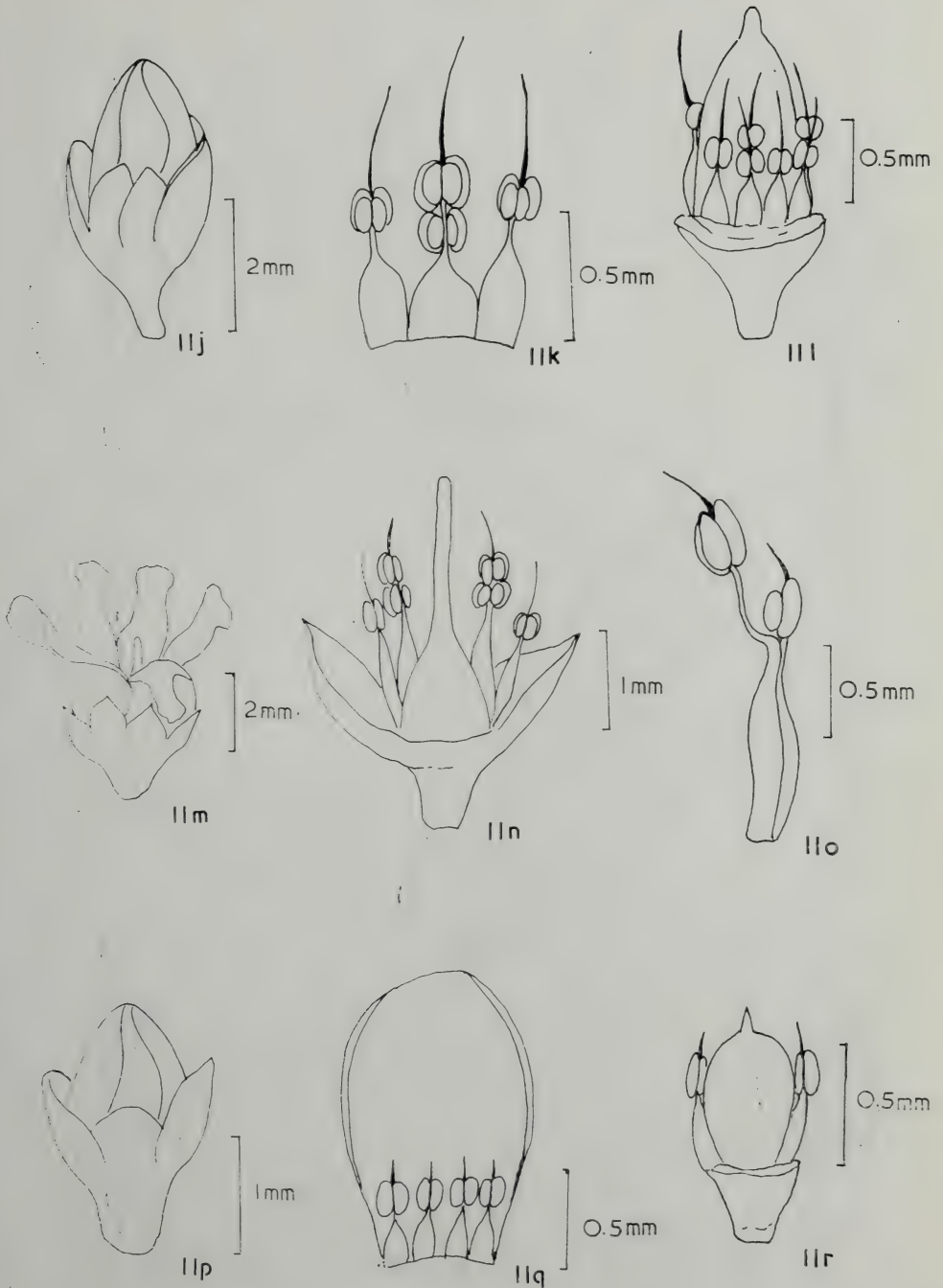

HOPEA

H. nutans j. flower bud. k. single and double stamens alternating. l. flower with perianth removed to show arrangement of stamens.
H. odorata m. flower. n. flower with perianth removed to show arrangement of stamens. o. lateral view of stamens.
H. sangal p. flower bud. q. petal with epipetalous stamens. r. flower with perianth removed to show position of stamens.

FIG 12

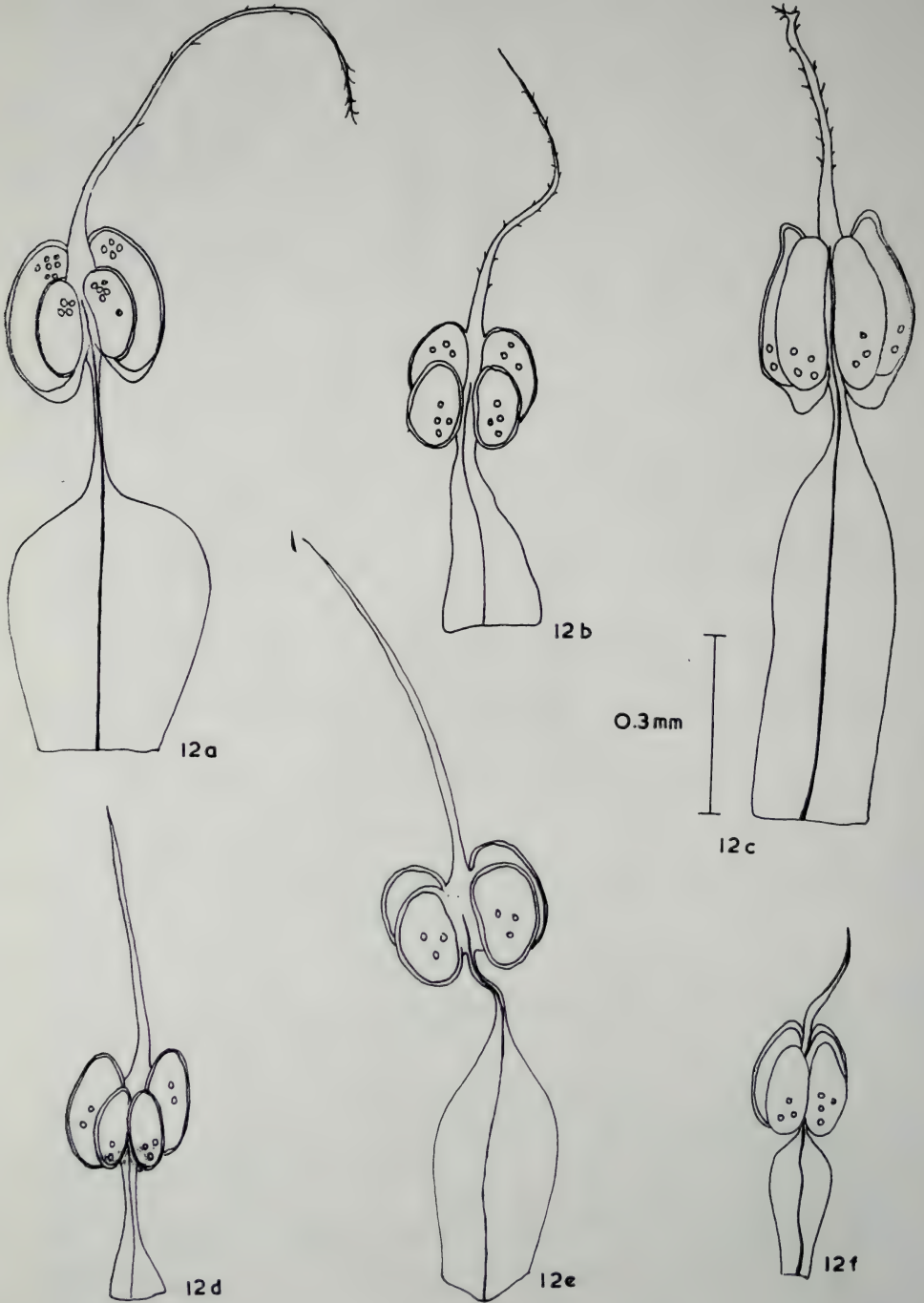

HOPEA

Stamens. x 100 : adaxial views.

- a. *H. nutans* b. *H. beccariana* c. *H. odorata* d. *H. minima* e. *H. apiculata*
 f. *H. sangal*

FIG 13.

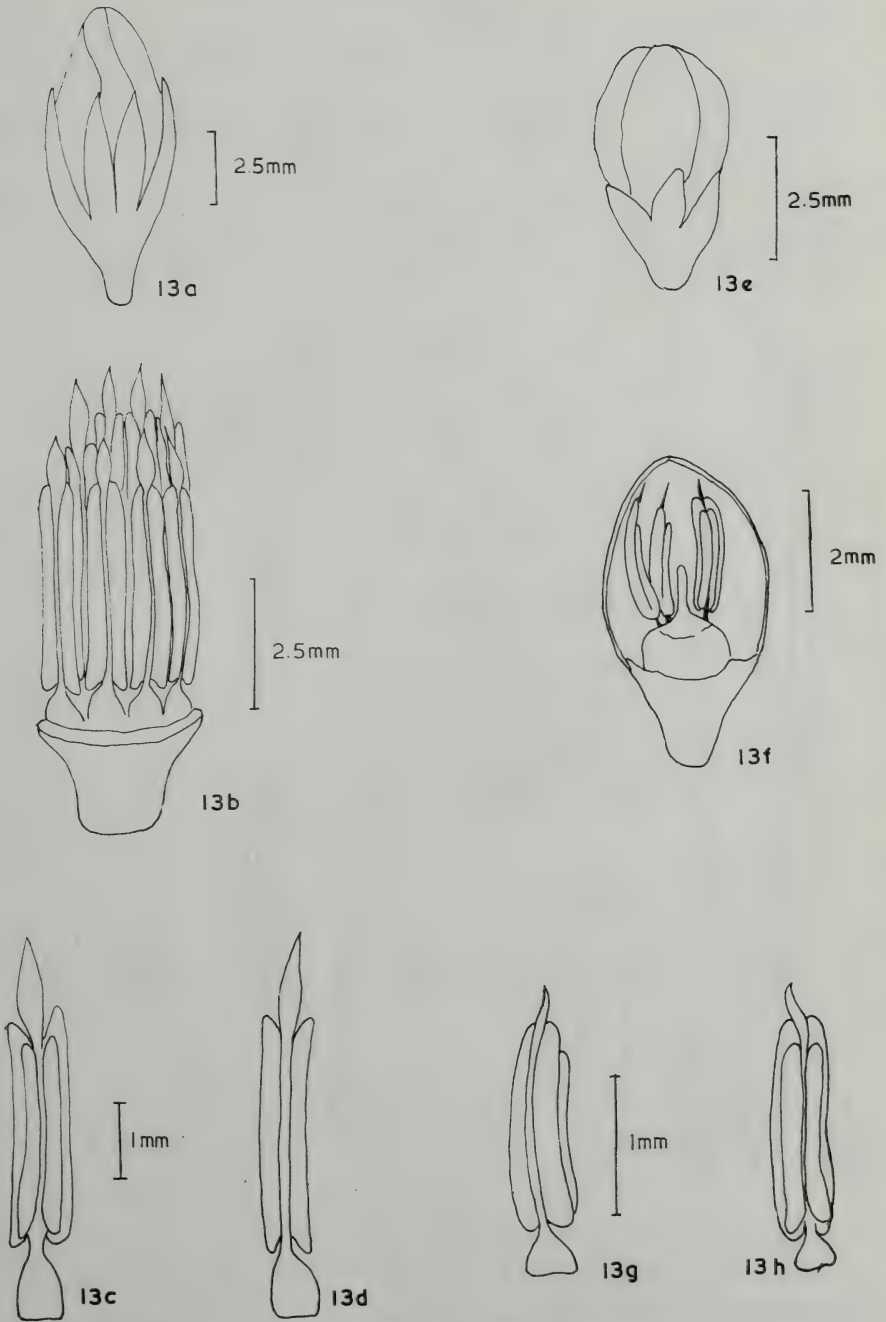

PARASHOREA

P. malaanonan a. flower bud. b. flower with perianth removed to show arrangement of stamens. c. adaxial view of stamen. d. abaxial view of stamen.
P. stellata e. flower bud. f. flower with parts of perianth removed to show position of stamens. g. oblique abaxial view of stamen. h. adaxial view of stamen.

FIG 14

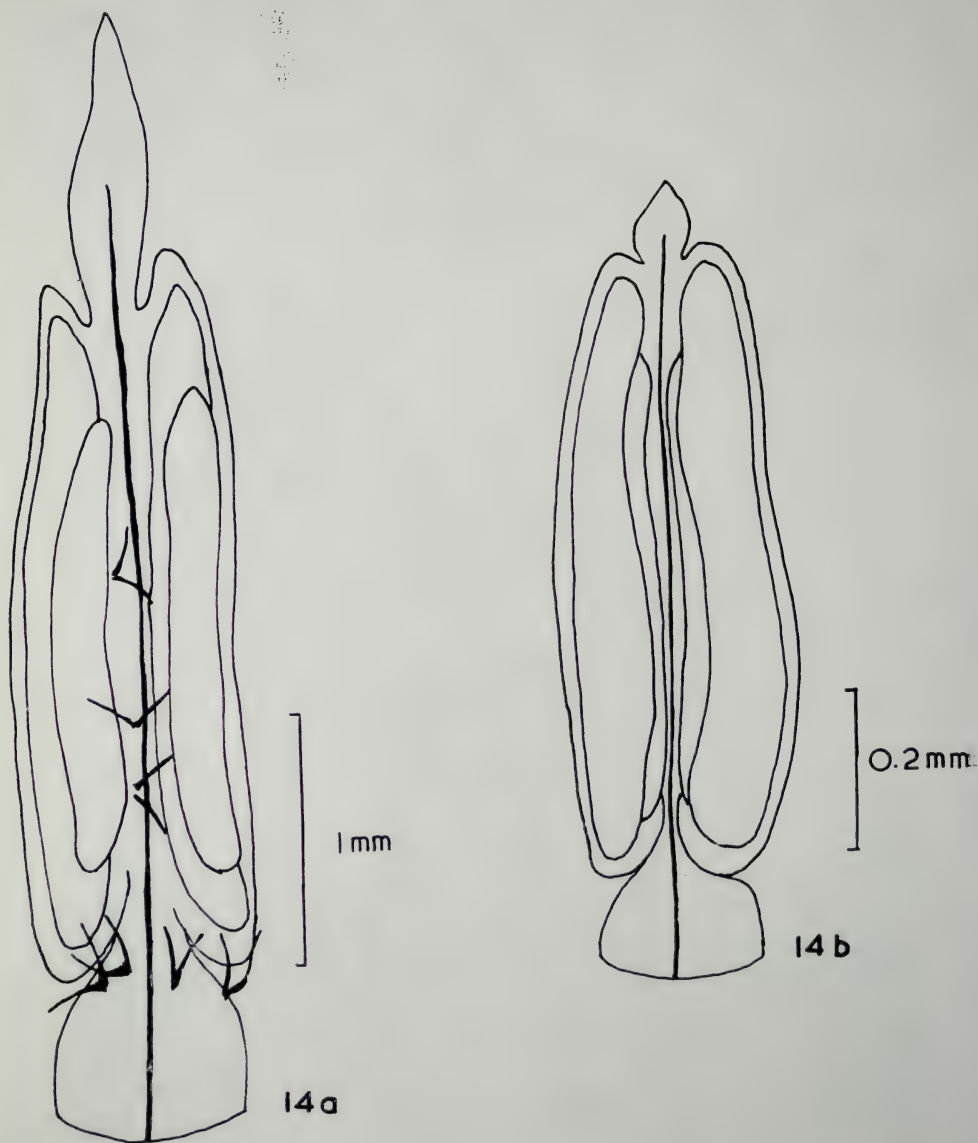
*PARASHOREA*

Stamens. x 100

a. *P. malaanonan* b. *P. stellata*

Stamens: 15, in 2 whorls (10 + 5); unequal.

Filaments: short, compressed, expanded at base; narrowing abruptly above; sometimes hispid on the shoulders.

Anthers: 4 loculed; the locules linear-oblong; unequal, the abaxial pair longer than the adaxial pair; dehiscing longitudinally.

Appendages: erect and short or long and clavate, tapering to pointed apex.

Vasculature: single vascular bundle between the anther sacs; continuing into (*P. malaanonan*) or ending near (*P. stellata*) the appendage to the connective.

9. *PENTACME* A. DC.

3 species, South East Asia and the Philippine Islands. The following one species has been examined;

Pentacme malayana King (Fig. 15, a-e).

Stamens: 15 in number, in 2 whorls; equal; with 5 apical projections from the anthers and the connective.

Filaments: long and compressed; tapering gradually towards the top.

Anthers: 4 loculed; the locules linear-oblong; equal; with acute to filiform apices; base broad with a small appendage.

Appendages: awl-like, recurved.

Vasculature: thick vascular bundle runs medially through the connective, ending at the base of the appendage to connective.

10. *SHOREA* ROXB. EX GAERTN.

Over 200 species, Ceylon to South China and the Malay Islands. 15 species have been studied. They are belonging to the following 4 groups:

(10a) The Balau group;

(10b) The Meranti Pa'ang group;

(10c) The Meranti Damar Hitam group;

(10d) The Red Meranti group.

Stamens: 10-50 or more in number, in one to several whorls; unequal, the outer stamens usually shorter than the inner ones; sometimes epipetalous.

Filaments: usually broad and flattened, sometimes ligulate, gibbous or fused at the base, gradually or abruptly tapering above to form connective of anthers; sometimes barbate on the shoulders.

Anthers: mostly 4 loculed but 2 loculed in the *Meranti Damar Hitam* group; the locules elliptic-ovate or oblong; abaxial locules larger than the adaxial locules.

Appendages: connective usually produced into a long, filiform acumen of various lengths; erect or reflexed and projecting abaxially, sometimes apically; setose, pubescent or glabrous.

Vasculature: a single vascular trace usually runs medially through the filament ending near the base of appendage to connective or in some species of the Red Meranti group, the single vascular trace branches, thus there are 3 short traces in the connective. In the case of stamens whose filaments are fused at the base, the staminal bundle originates from the central stele of the flower, branching out to give rise to 3 or several vascular strands, each strand entering a single stamen.

(10a) *The Balau group of Shorea*

For this group, the following 3 species have been examined:

- (1) *Shorea exelliptica* Meijer (Fig. 16, a-g; Fig. 18, c);
- (2) *Shorea foxworthyi* Sym (Fig. 17, j-m; Fig. 18, a);
- (3) *Shorea seminis* (de Vriese) V. S1. (Fig. 17, h, i; Fig. 18, b).

Stamens: 30-45 in number, arranged in 3 whorls; of 3 different lengths, the innermost whorl the longest.

Filaments: compressed; the base broad or narrow; filaments of different whorls radially fused at the base into bundles; shoulders of the filaments are barbate.

Anthers: 4 loculed; the locules elliptic to oblong; unequal, the abaxial anther sacs larger than the adaxial ones; basifixed, adnate to the filament; dehiscent longitudinally; sometimes barbate.

Appendages: short and blunt, less than the length of anthers, projecting abaxially; setose or barbate, bristles long.

Vasculature: staminal bundles are present, each branching out to give rise to 3 vascular strands, each trace entering a single filament.

(10b) *The Meranti Pa'ang group of Shorea*

For this group, the following species have been examined:

- (1) *Shorea gratissima* Dyer (Fig. 19, h; Fig. 21, a);
- (2) *Shorea resinosa* Foxw. (Fig. 19, a-g; Fig. 21, b);
- (3) *Shorea talura* Roxb. (Fig. 20, i-n; Fig. 21, c).

Stamens: 15 to 30 in number, usually 15 in 2 whorls; dimorphic, longer and shorter stamens arranged alternately, sometimes epipetalous.

Filaments: compressed and flattened; gradually or abruptly narrowed towards the anthers; the base narrow or broad.

Anthers: 4 loculed; the locules oblong; unequal, abaxial anther sacs usually larger than adaxial ones; basifixed, adnate to filament; dehiscent longitudinally.

FIG 15

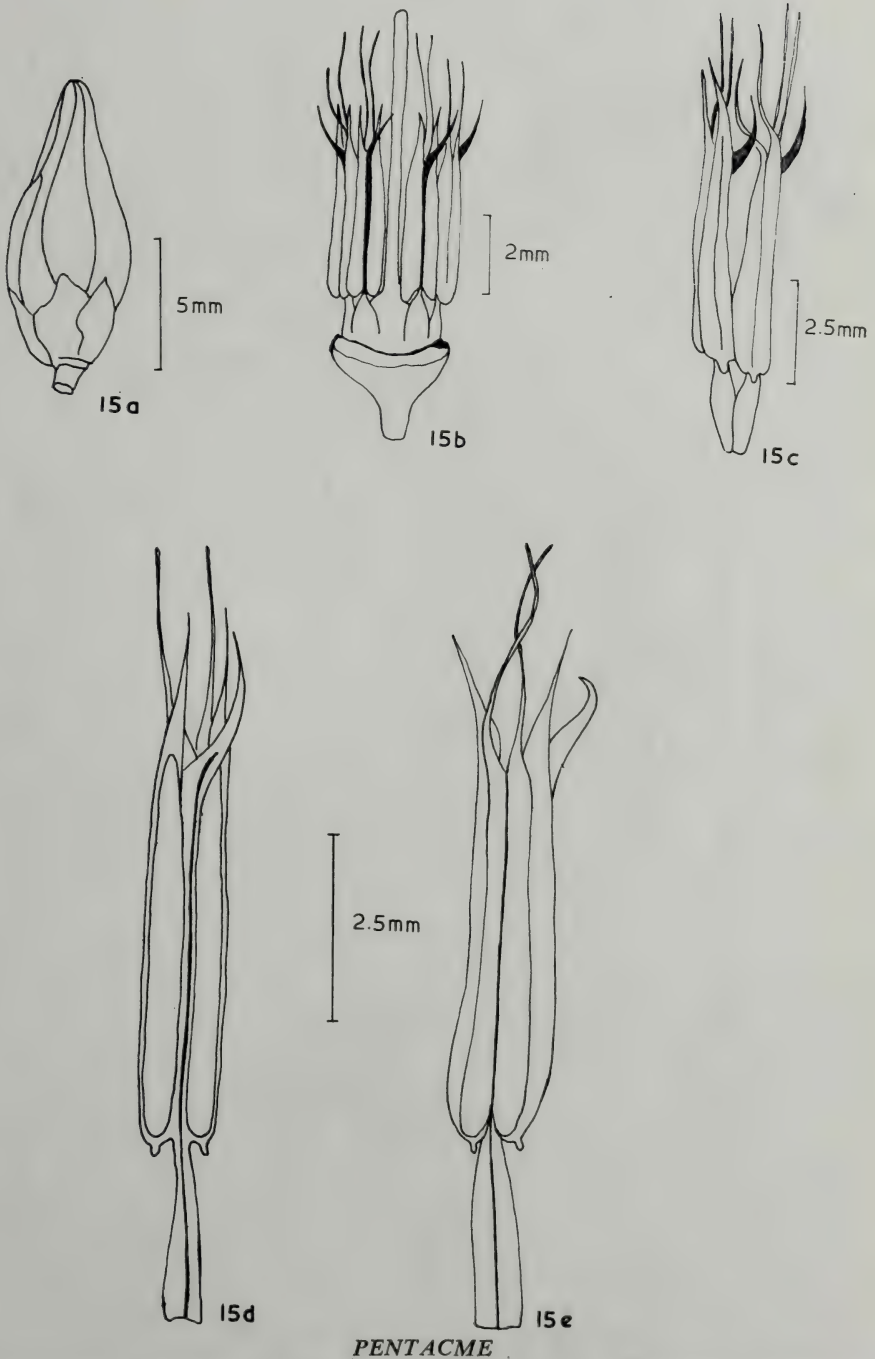

P. malayana a. flower bud. b. flower with perianth removed showing position of stamens. c. lateral view of stamens. Stamens. x 100
d. abaxial view of stamen. e. adaxial view of stamen.

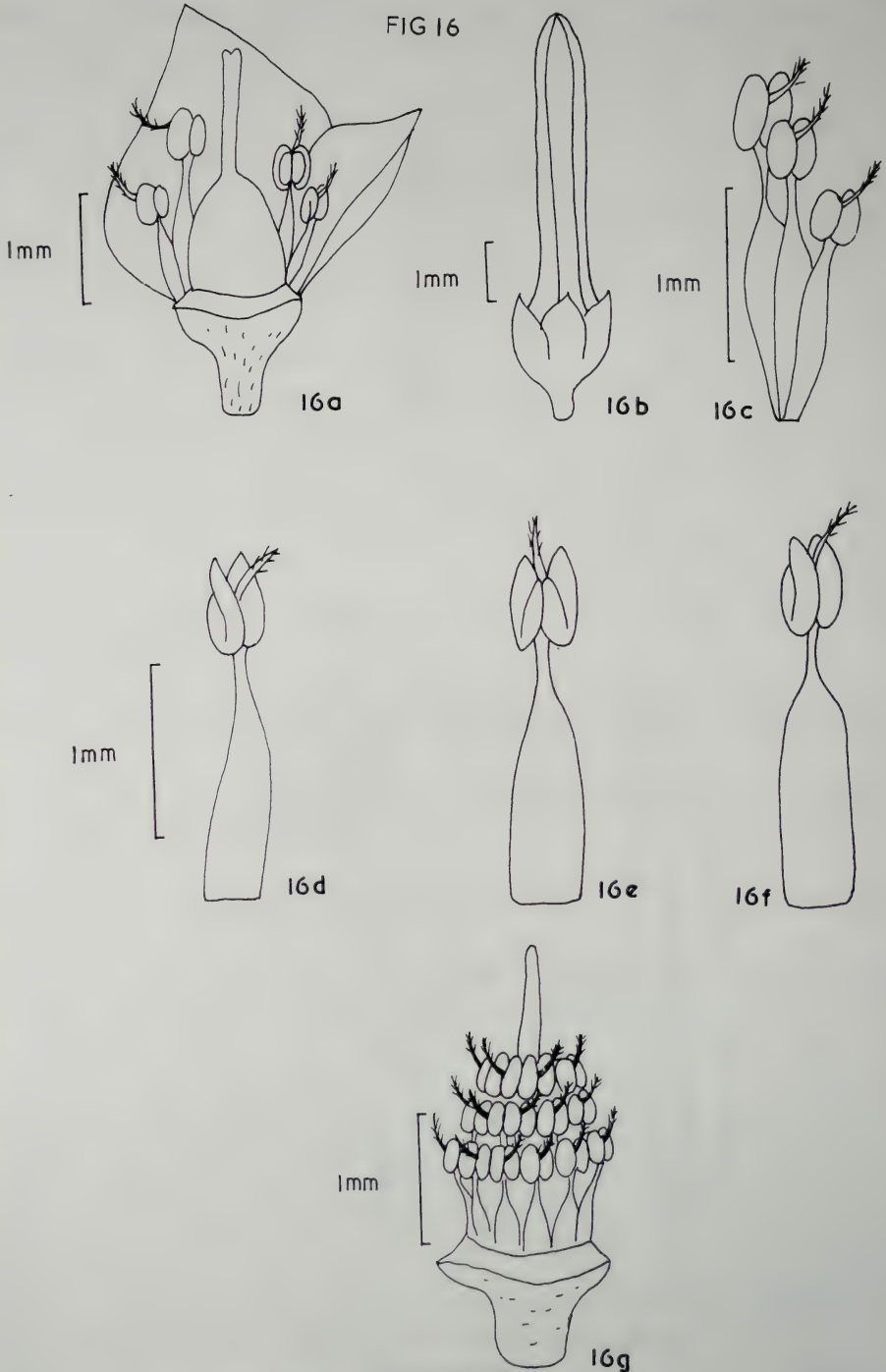

THE BALAU GROUP OF SHOREA

S. exelliptica a. flower with parts of perianth removed showing arrangement of stamens. b. flower bud. c. stamens of different whorls with filaments connate at base. d. lateral view of stamen. e. adaxial view of stamen. f. abaxial view of stamen. g. flower with perianth removed showing complete arrangement of stamens.

FIG 17

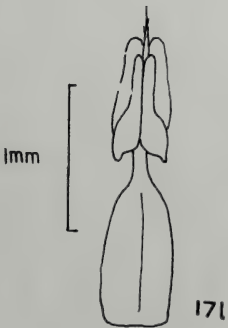
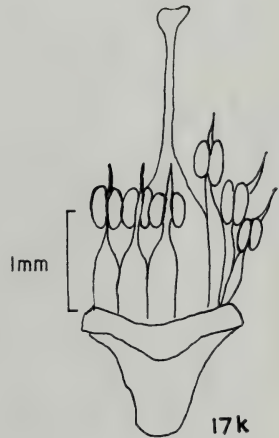
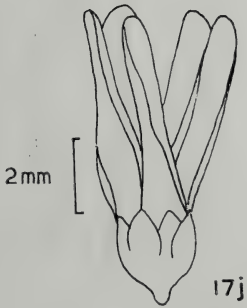
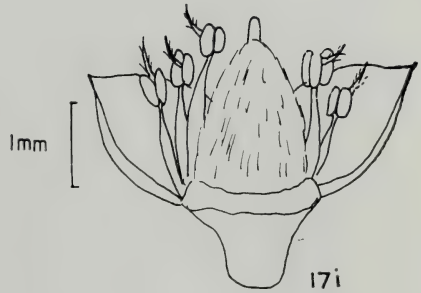
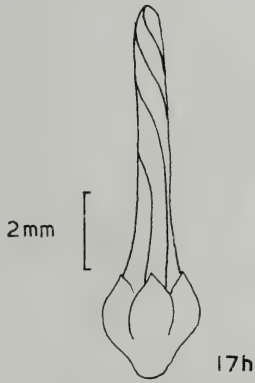

THE BALAU GROUP OF SHOREA

S. seminis h. flower bud. i. flower with parts of perianth removed showing position of stamens.

S. foxworthyi j. flower bud. k. flower with perianth removed showing position of stamens. l. adaxial view of stamen. m. abaxial view of stamen.

FIG 18

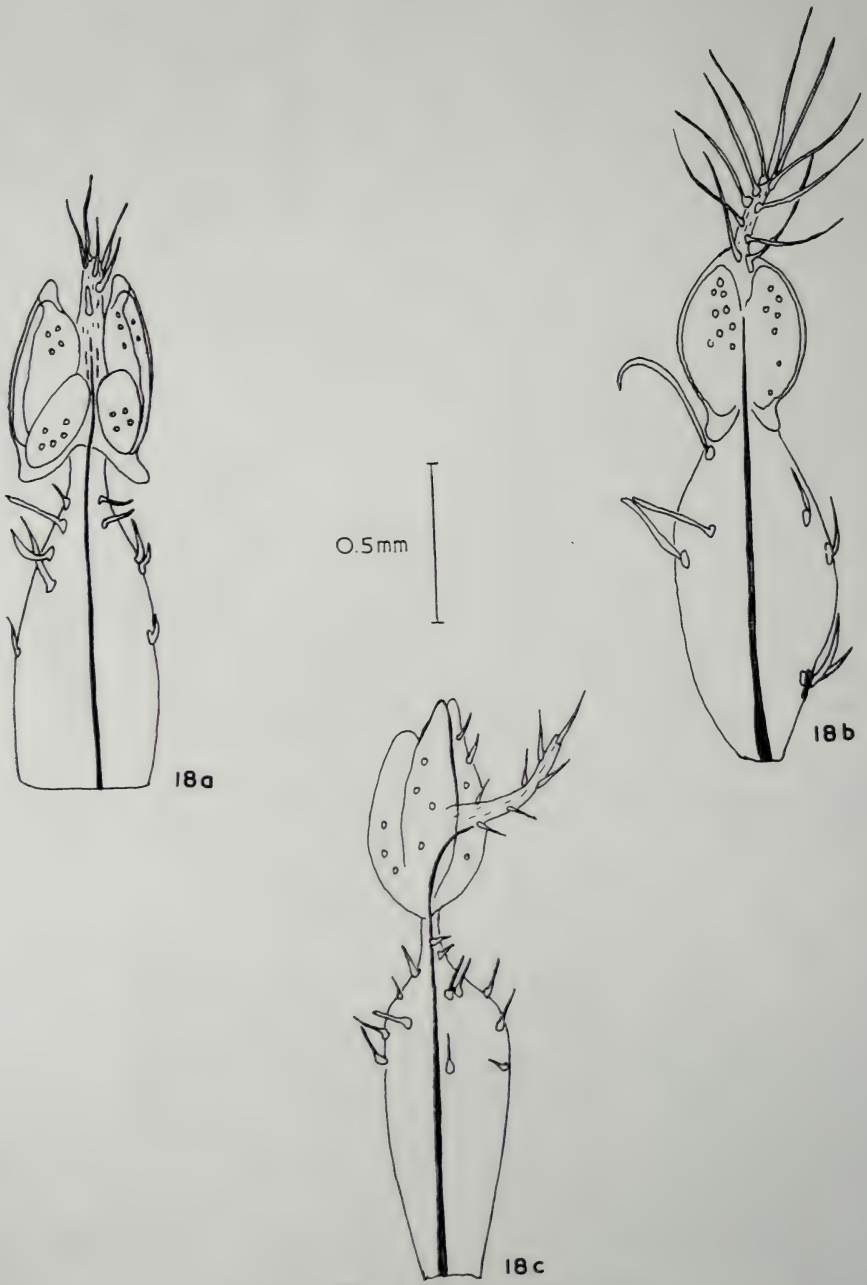

THE BALAU GROUP OF SHOREA

Stamens. x 100

a. *S. foxworthyi* b. *S. seminis* c. *S. exelliptica*

FIG 19

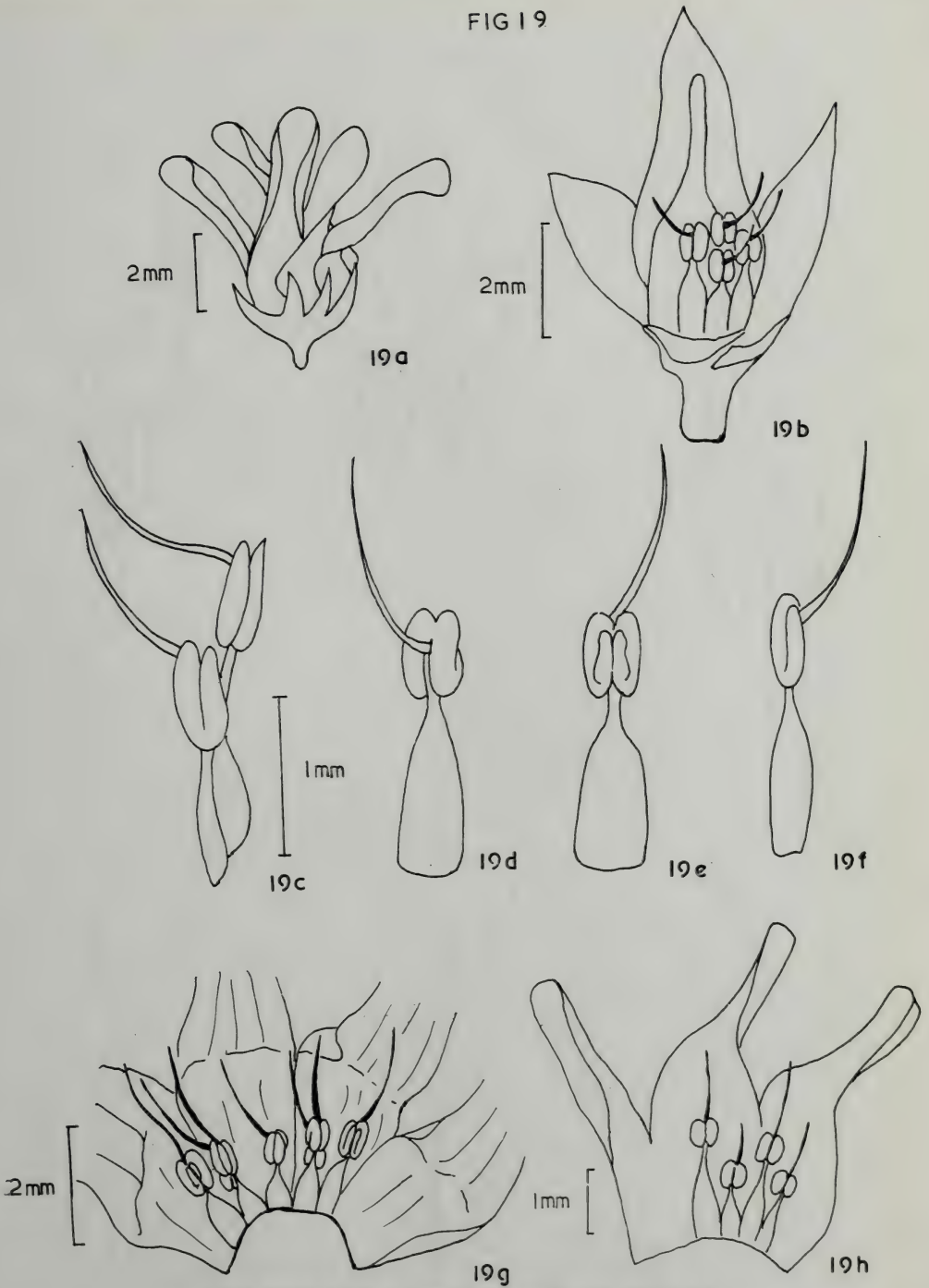

THE MERANTI PA'ANG GROUP OF SHOREA

S. resinosa a. flower bud. b. flower with parts of perianth removed showing stamens. c. lateral view of stamens of 2 different whorls. d. abaxial view of stamens. e. adaxial view of stamens. f. lateral view of stamens. g. part of corolla with epipetalous stamens.
S. gratissima h. part of corolla with epipetalous stamens.

FIG 20

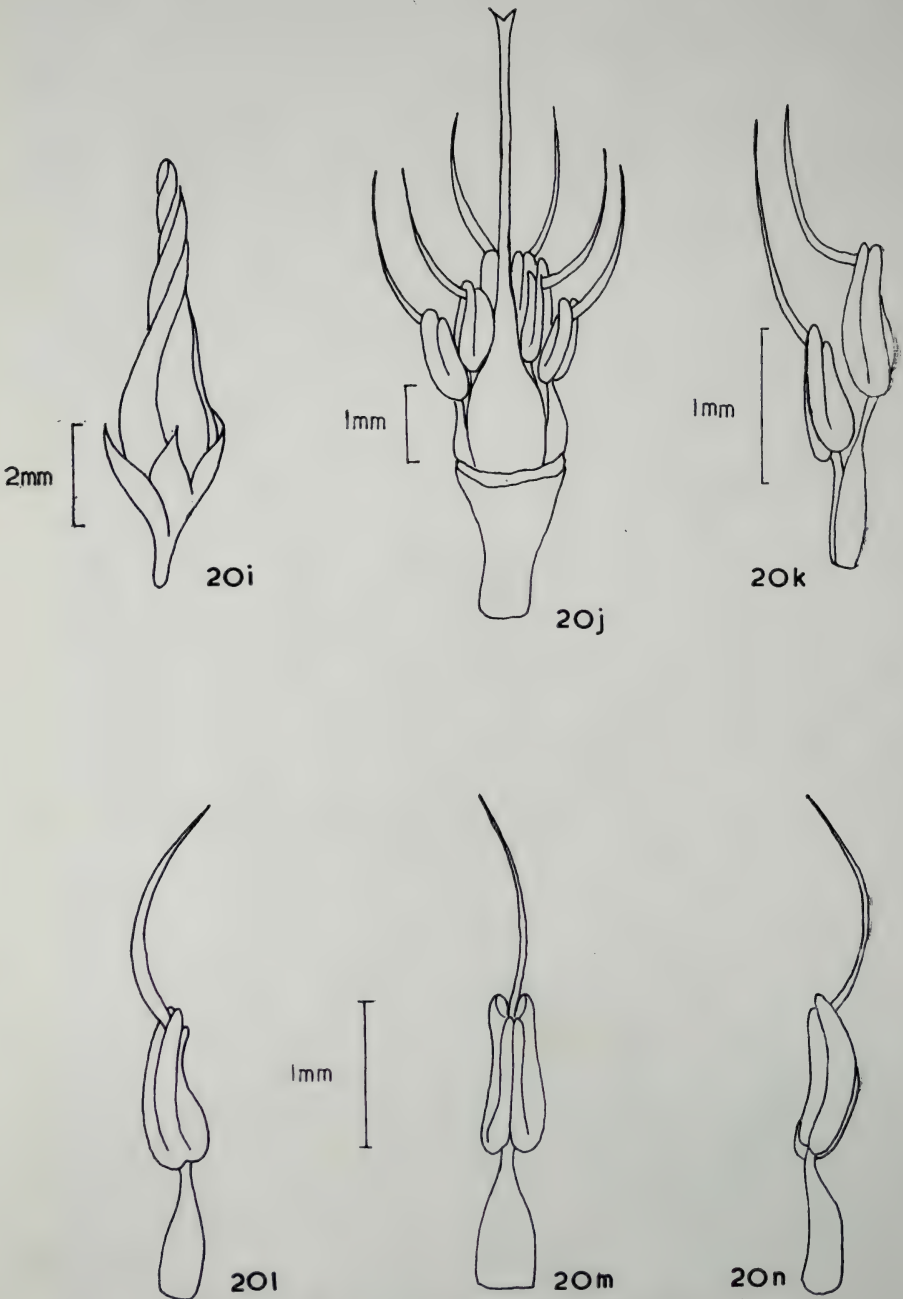

THE MERANTI PA'ANG GROUP OF SHOREA

S. talura i. flower bud. j. flower with perianth removed showing arrangement of stamens. k. lateral view of stamen of 2 different whorls. l. oblique abaxial view of stamen. m. adaxial view of stamen. n. lateral view of stamen.

FIG 21

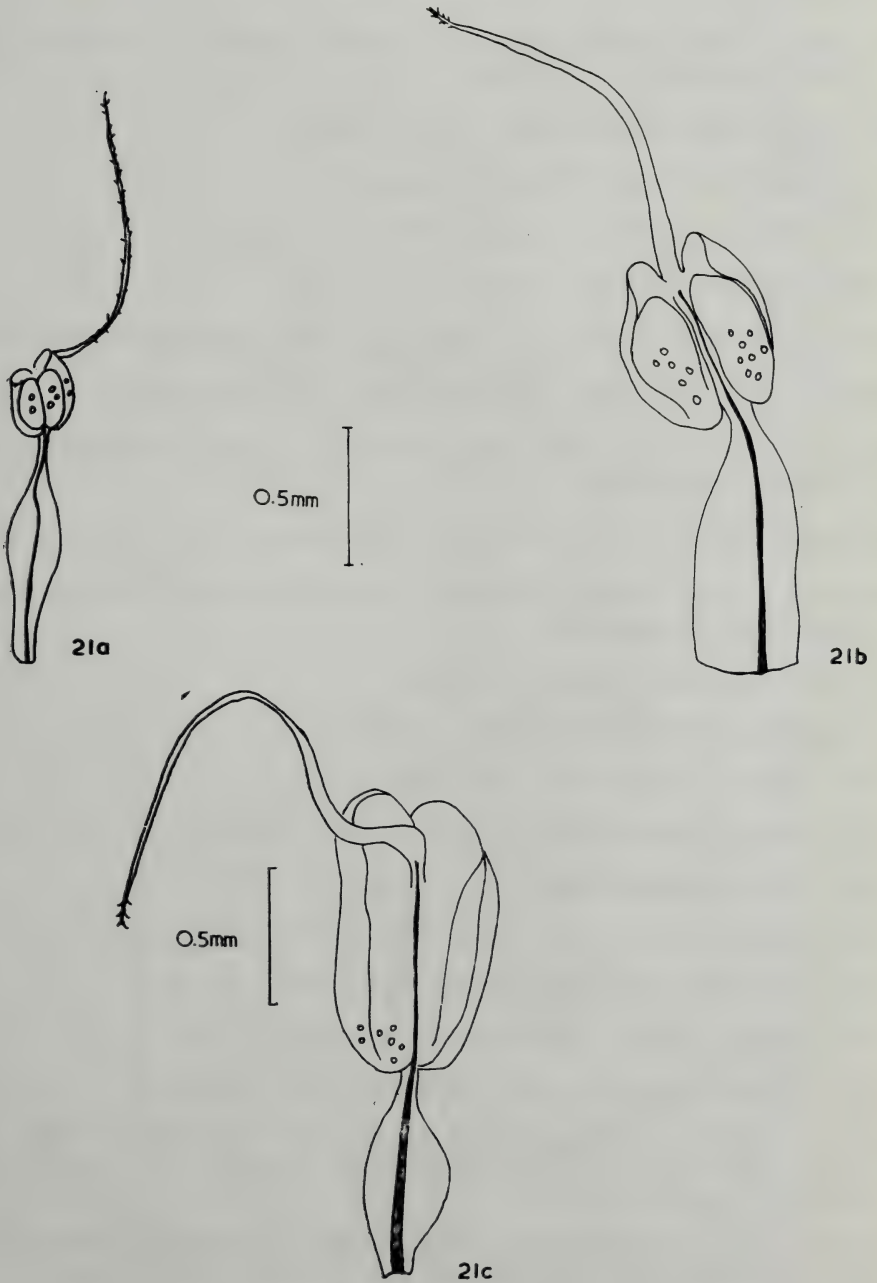

THE MERANTI PA'ANG GROUP OF SHOREA

Stamens. x 100

a. *S. gratissima* b. *S. resinosa* c. *S. talura*

Appendages: awn-like, nearly 2 to 3 times longer than the anthers; projecting abaxially; usually reflexed, long, curving, filiform; sometimes sparsely setose towards the tip.

Vasculature: single vascular trace runs medially through the filament, ending near the appendage to connective.

(10c) *The Meranti Damar Hitam group of Shorea*

The following 2 species have been examined:

- (1) *Shorea maxima* (King) Sym. (Fig. 22, a, b, c);
- (2) *Shorea resina-nigra* Foxw. (Fig. 22, d, e, f).

Stamens: 10–15 in number, in 2 whorls (10 + 5), of equal or unequal lengths.

Filaments: broad throughout its length, compressed and applanate.

Anthers: 2 loculed (4 in other groups of *Shorea*), equal; locules elliptic-oblong, dehiscent longitudinally.

Appendages: as long as or shorter than the anthers; acumen stout or slender.

Vasculature: single vascular trace runs medially through the broad filament, ending near the appendage.

(10d) *The Red Meranti group of Shorea*

The following 7 species have been studied:

- (1) *Shorea curtisii* Dyer ex King (Fig. 27, d);
- (2) *Shorea hemsleyana* (King) King ex Foxw. (Fig. 23, a-g; Fig. 26, c);
- (3) *Shorea kunstleri* King (Fig. 24, h, i; Fig. 27, f.);
- (4) *Shorea lepidota* (Korth.) Bl. (Fig. 25, r-u; Fig. 26, a);
- (5) *Shorea leprosula* Miq. (Fig. 25, o, p, q; Fig. 26, b);
- (6) *Shorea parvifolia* Dyer (Fig. 24, j, k; Fig. 27, e);
- (7) *Shorea sericea* Dyer (Fig. 24, l, m, n; Fig. 27, g).

Stamens: usually 15 in number, in 2 whorls; the 5 inner stamens longer than the 10 outer stamens; sometimes 40–50 in number (as in *S. sericea* Dyer) in several rows or in clusters.

Filaments: long and compressed, tapering above, broadened and gibbous at the base, sometimes narrow and twisted (e.g. *S. sericea* Dyer).

Anthers: 4 loculed, the locules elliptic, subglobose or ovoid; unequal, abaxial anther sacs slightly larger than the adaxial pair.

Appendages: of various lengths, either shorter or longer than the anthers, apex pointed or blunt, slender, glabrous.

FIG 22

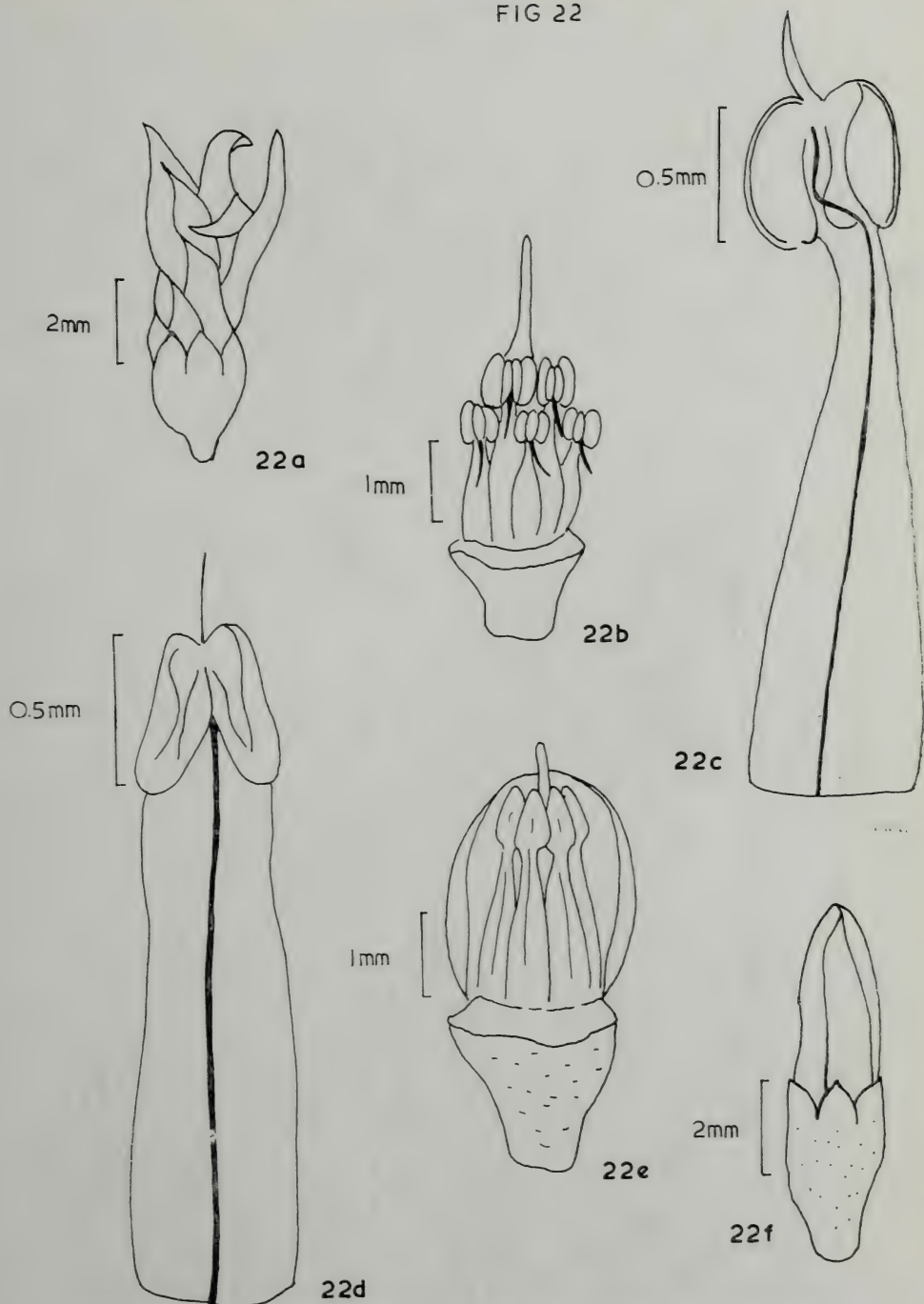

THE MERANTI DAMAR HITAM GROUP OF SHOREA

S. maxima a. flower bud. b. flower with perianth removed showing arrangement of stamens. c. stamen. x 100 : adaxial view.

S. resinosa-nigra d. stamen. x 100 : adaxial view. e. flower with parts of perianth removed showing arrangement of stamens. f. flower bud.

FIG 23

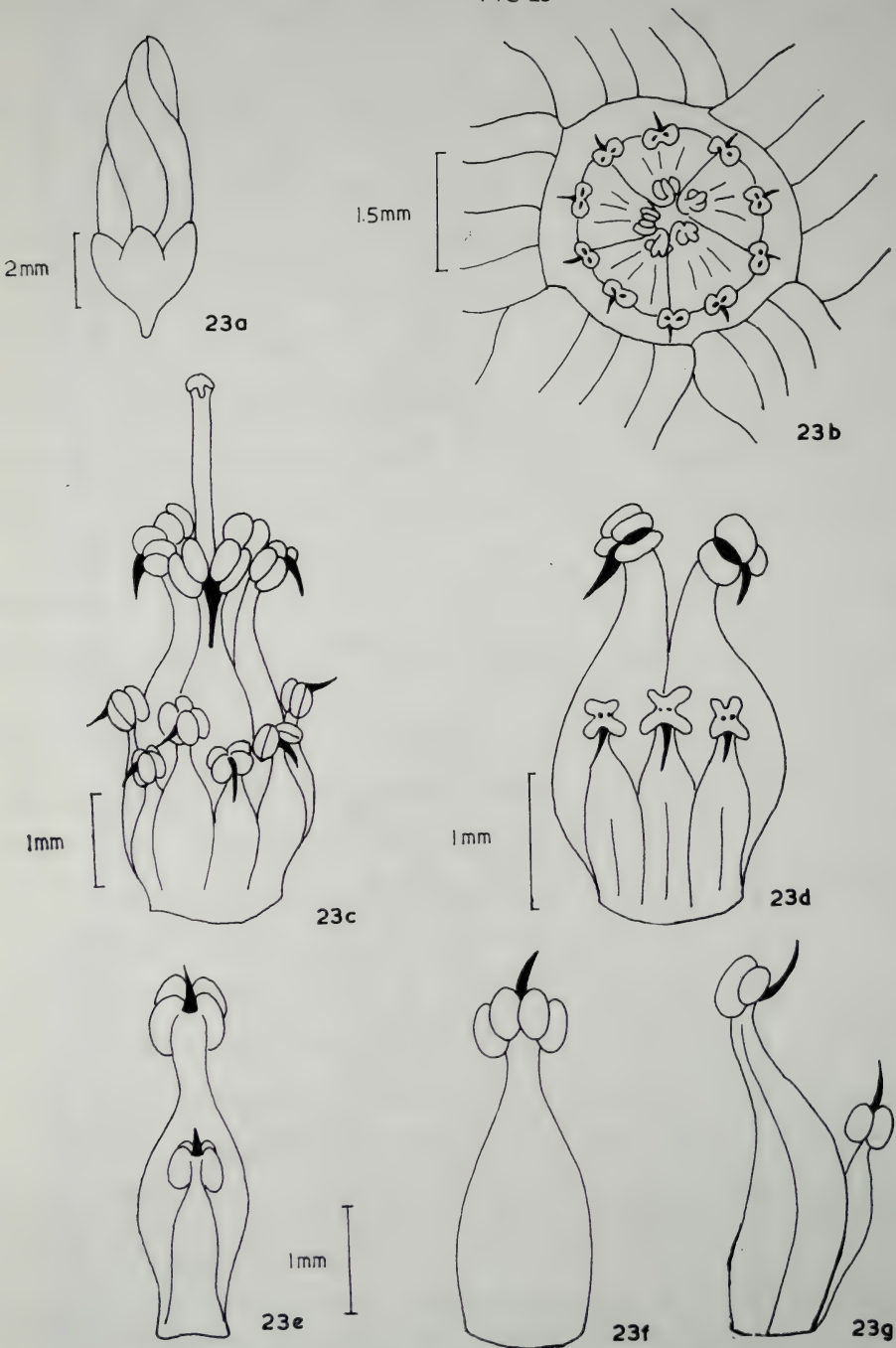

THE RED MERANTI GROUP OF SHOREA

S. hemsleyana a. flower bud. b. top view of flower showing arrangement of stamens. c. flower with perianth removed showing stamen whorls. d. stamens of 2 different whorls of different lengths. e. abaxial view of stamens. f. adaxial view of stamens. g. lateral view of stamens of different whorls with filaments fused at base.

FIG 24

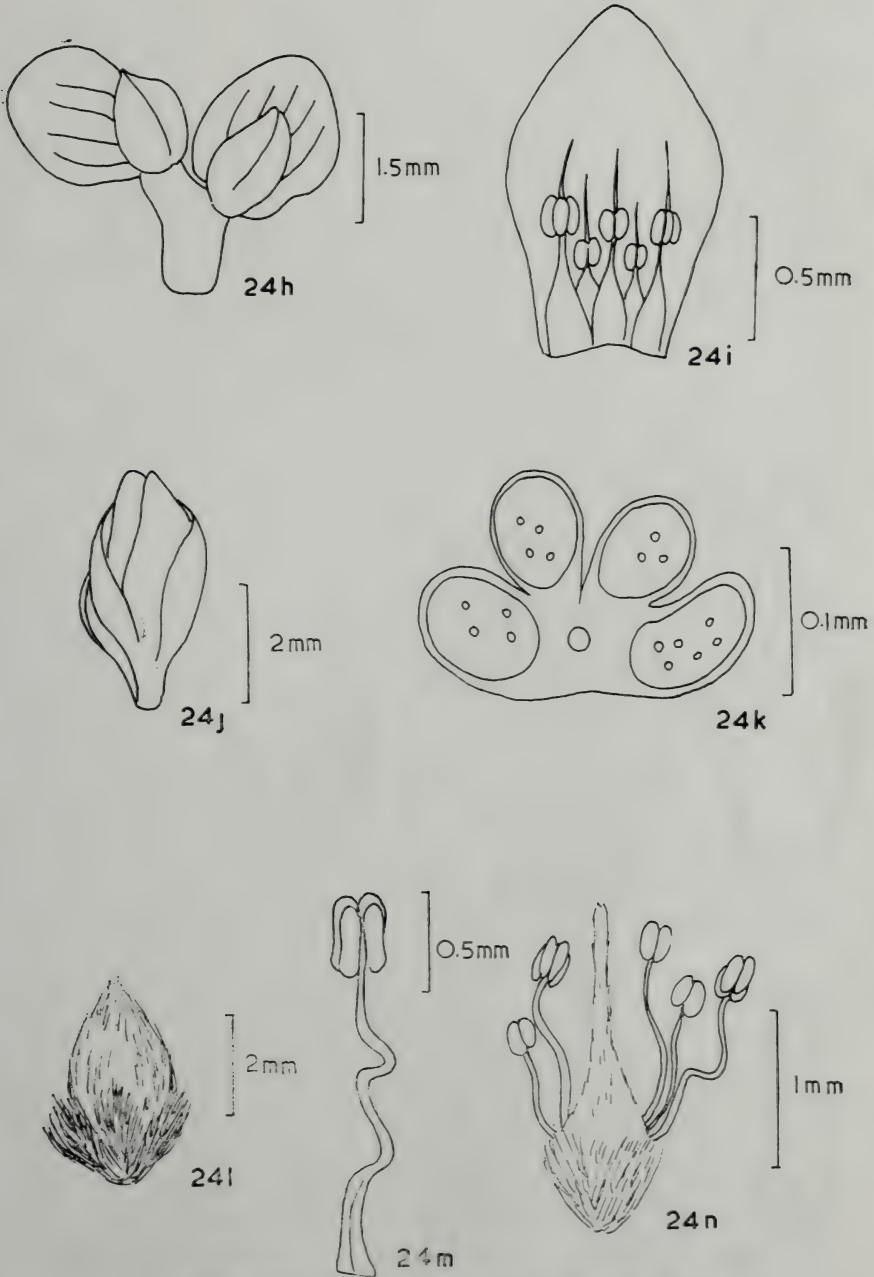

THE RED MERANTI GROUP OF SHOREA

S. kunstleri h. flower bud. i. single petal showing epipetalous stamens.
S. parvifolia j. flower bud. k. transverse section of anthers.
S. sericea l. flower bud. m. stamen with twisted filament. n. flower with perianth removed showing arrangement of stamens.

FIG 25

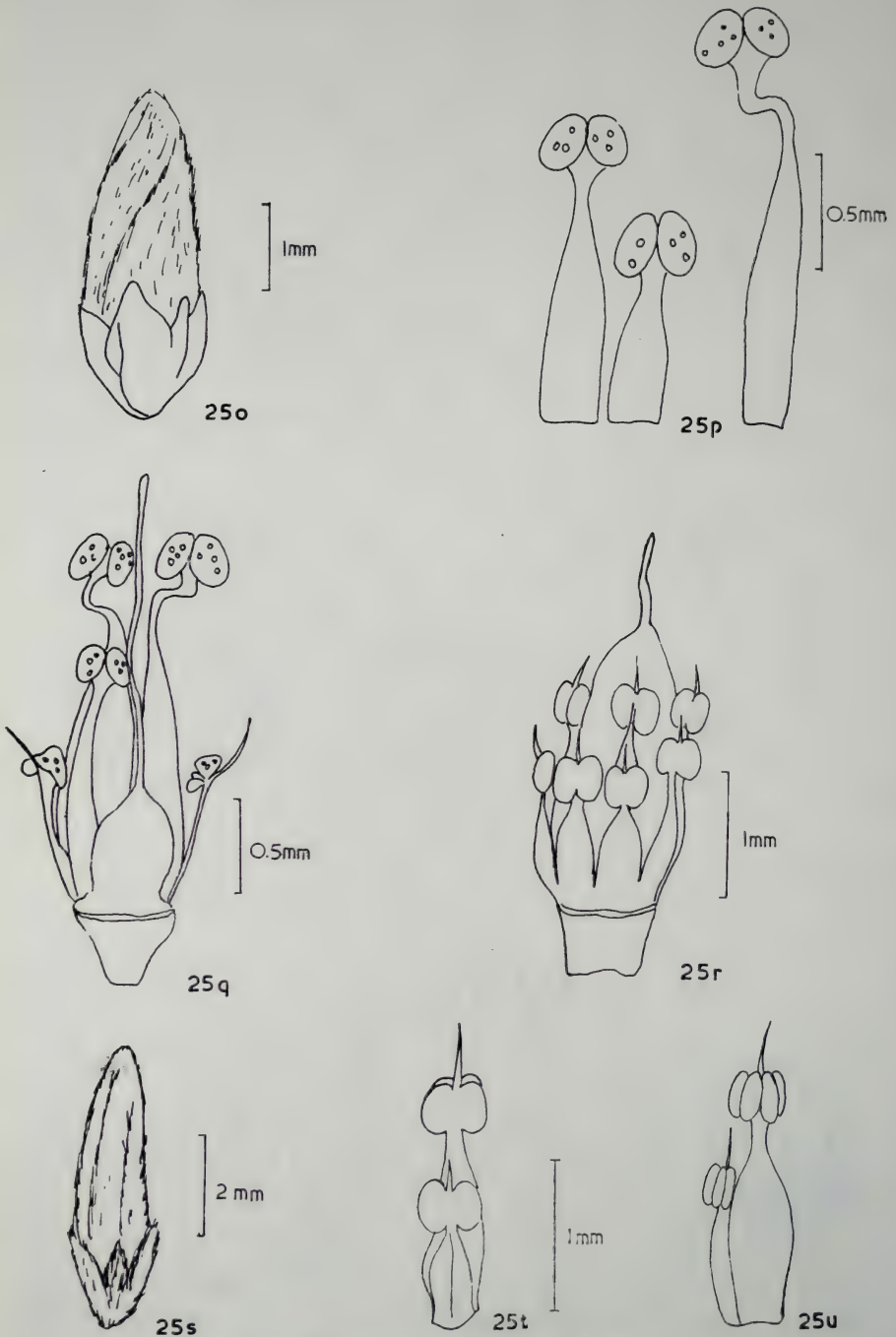

THE RED MERANTI GROUP OF SHOREA

S. leprosula o. flower bud. p. stamens of 3 unequal verticalities. q. flower with perianth removed showing arrangement of stamens.

S. lepidota r. flower with perianth removed showing arrangement of stamens.

s. flower bud. t. abaxial view of stamens. u. adaxial view of stamens.

FIG 26

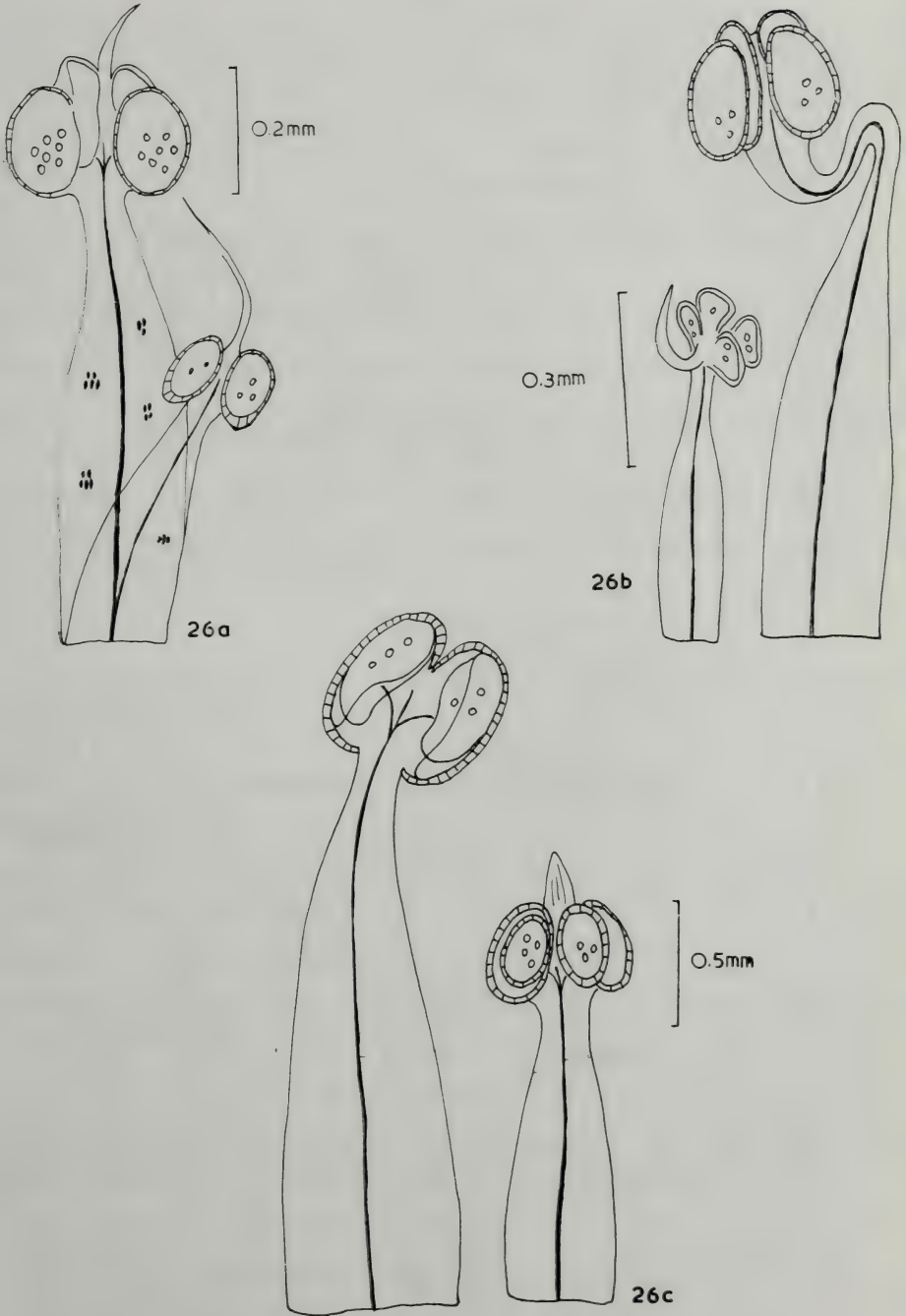

THE RED MERANTI GROUP OF SHOREA

Stamens. x 100

a. *S. lepidota* : abaxial view. b. *S. leprosula* : abaxial view. c. *S. hemsleyana* : adaxial view.

FIG 27

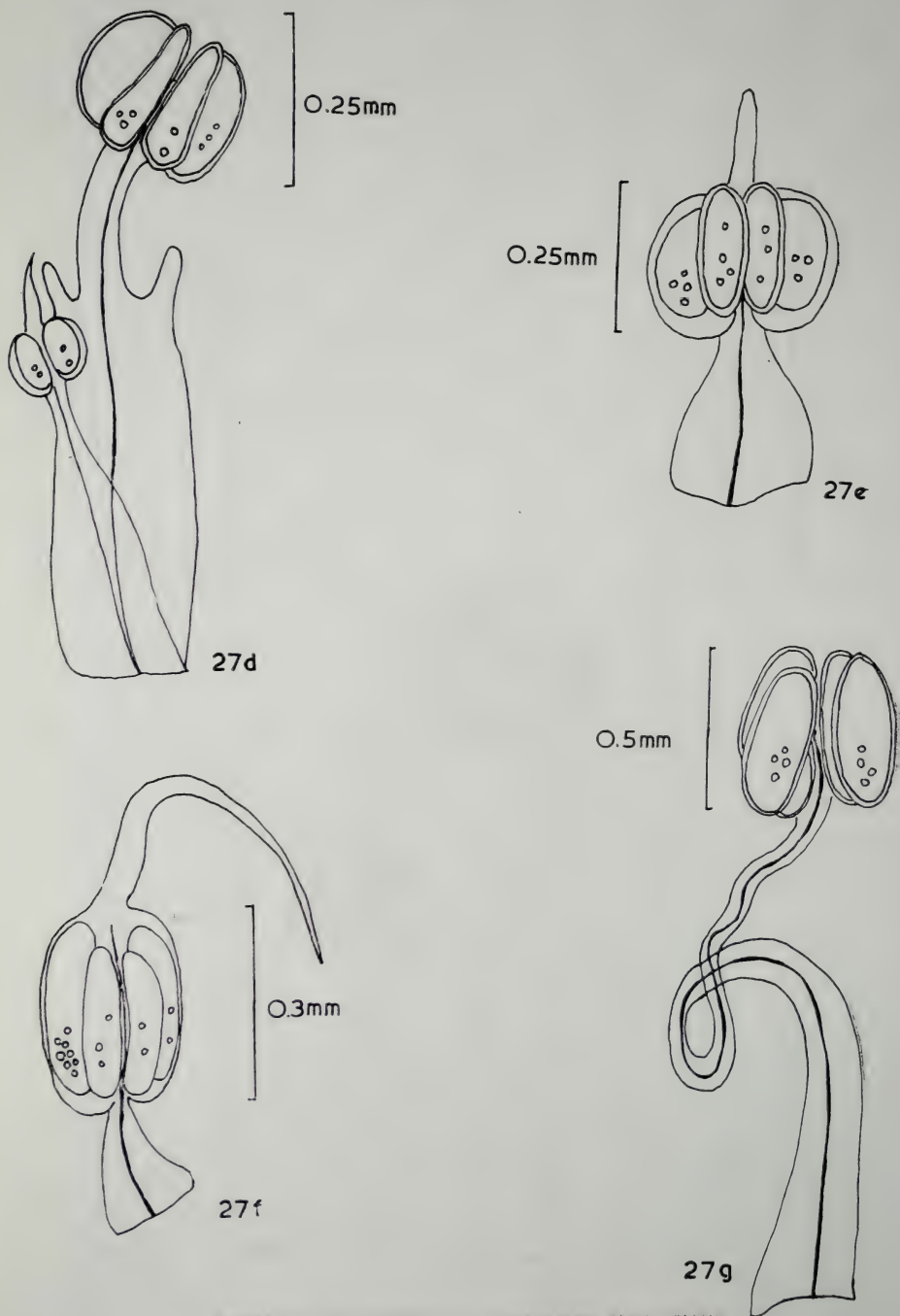

THE RED MERANTI GROUP OF SHOREA

d. *S. curtisii* : adaxial view. e. *S. parvifolia* : adaxial view. f. *S. kunstleri* : adaxial view. g. *S. sericea* : adaxial view.

Vasculature: single vascular trace runs medially through the stamens, ending near the appendage to connective; sometimes within the connective region, the single vascular bundle branches into 3 strands as in *S. hemsleyana* and *S. lepidota*. In *S. sericea*, a staminal bundle branches into 5 vascular traces, each trace serving a single stamen.

11. *UPUNA* SYMINGTON

Monotypic, confined to Borneo. The type species has been studied:
Upuna borneensis Sym. (Fig. 28, a-f).

Stamens: 25–30 in number, arranged in several rows; innermost stamens longest.

Filaments: long, compressed, tapering above; base broad.

Anthers: 0.2mm–0.3mm; anther sacs ovate; unequal, abaxial anther sacs larger than adaxial ones; dehiscing longitudinally.

Appendages: long, about 3 times the length of anthers; filiform, glabrous.

Vasculature: single vascular bundle runs medially through the stamen, ending near the appendage to connective.

12. *VATERIA* LINN.

Over 20 species, Seychelles, South India to Ceylon; only the following one species has been studied:
Vateria indica Linn. (Fig. 29, a-g).

Stamens: numerous, arranged in whorls around the style.

Filaments: very short.

Anthers: 2 to 4 loculed; anther sacs linear-oblong, unequal, abaxial anther sacs longer than adaxial pair.

Appendages: flattened, subulate.

Vasculature: single vascular bundle runs medially through the stamen, ending near the appendage.

13. *VATICA* LINN.

About 80 species; South India, Ceylon, Thailand, Indo China, Hainan and the Malay Islands. The following 3 species have been studied:

- (1) *Vatica nitens* King (Fig. 30, h, i, j; Fig. 31, d);
- (2) *Vatica ridleyana* Brandis (Fig. 30, a-d; Fig. 31, c);
- (3) *Vatica wallichii* Dyer (Fig. 30, e, f, g; Fig. 31, a, b).

Stamens: 15 in number; short, glabrous, arranged in 2 whorls; inner stamens longer than outer stamens.

Filaments: short in outer stamens, long in inner stamens, upper portion broad, constricted in the middle, broadened at the base.

FIG 28

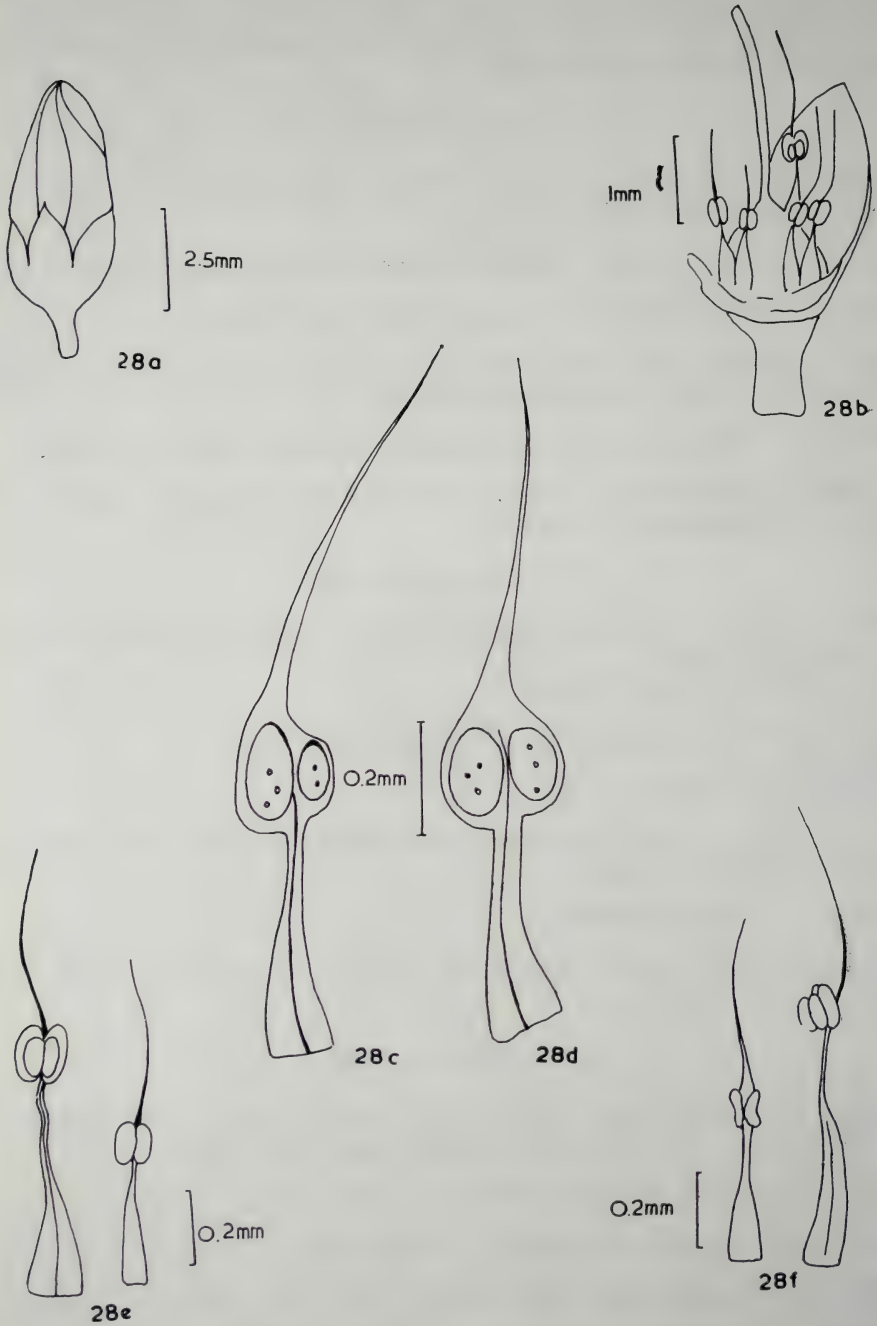

UPUNA

U. borneensis a. flower bud. b. flower with perianth removed showing arrangement of stamens. c. lateral view of stamens. d. abaxial view of stamens. e-f. stamens of different lengths.

FIG 29

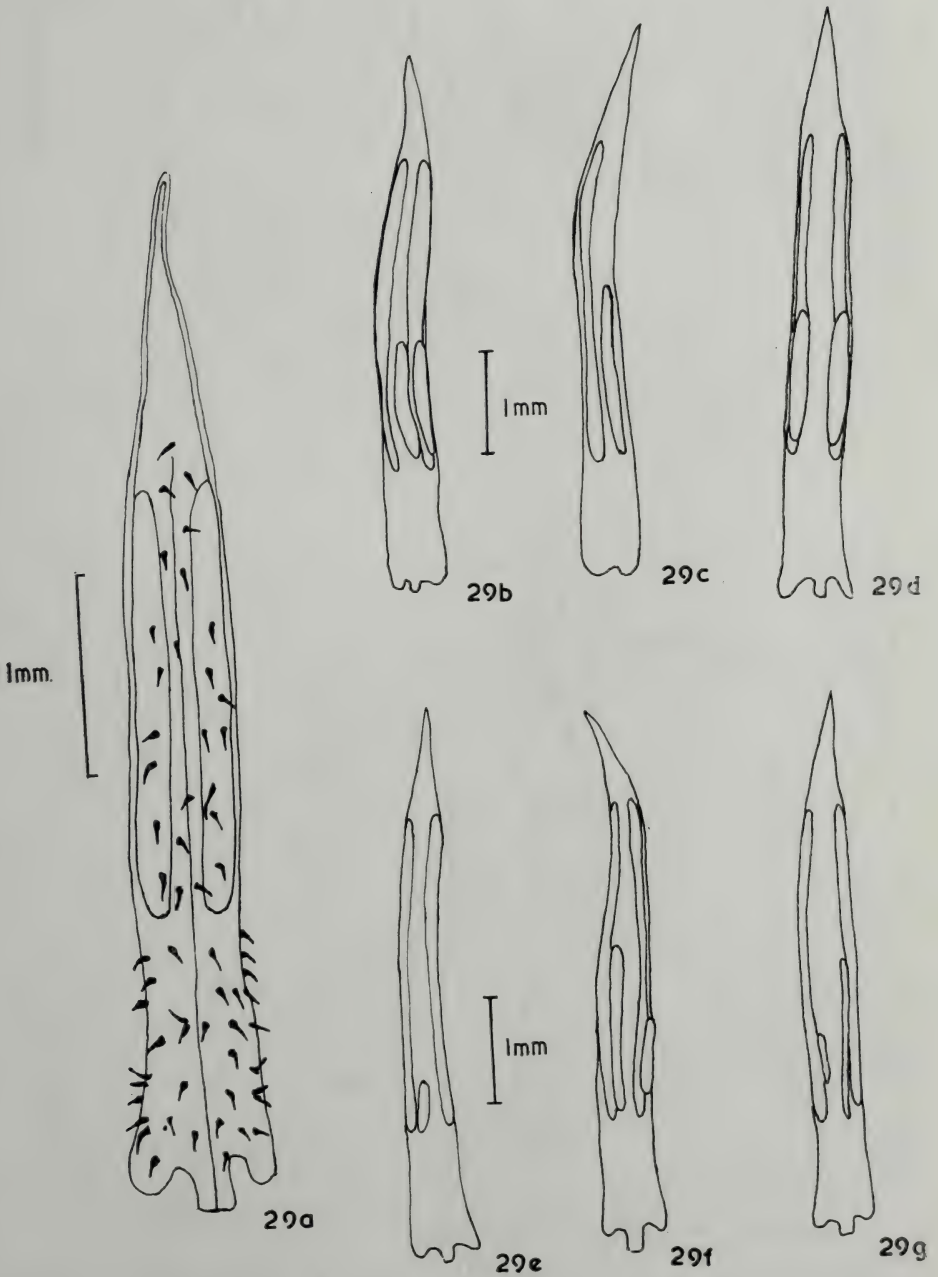

VATERIA

V. indica a. adaxial view of stamen with 2 locules. x 100. b. oblique lateral view of stamens with 4 locules. c. lateral view. d. adaxial view. e-g. stamens with adaxial locules of different sizes.

FIG 30

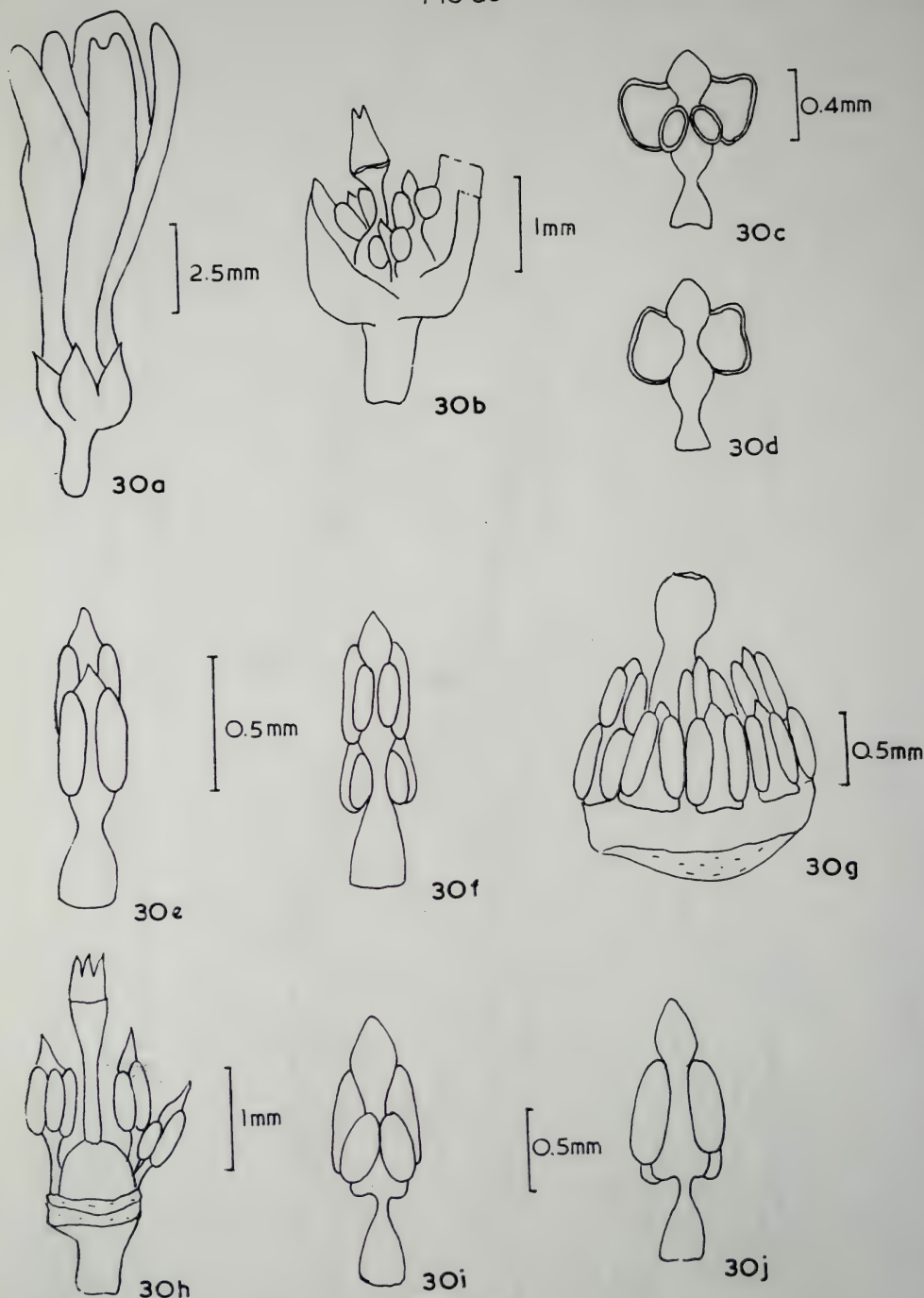

VATICA

- V. ridleyana* a. flower bud. b. flower with parts of perianth removed showing arrangement of stamens. c. adaxial view of stamen. d. abaxial view of stamen.
V. wallichii e. abaxial view of stamens. f. adaxial view of stamens. g. flower with perianth removed showing arrangement of stamens.
V. nitens h. flower with perianth removed showing arrangement of stamens. i. adaxial view of stamens. j. abaxial view of stamens.

FIG 31

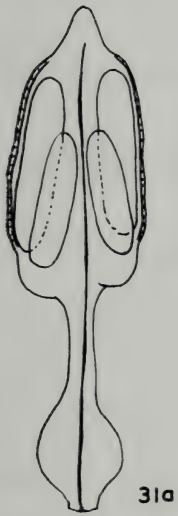

31a

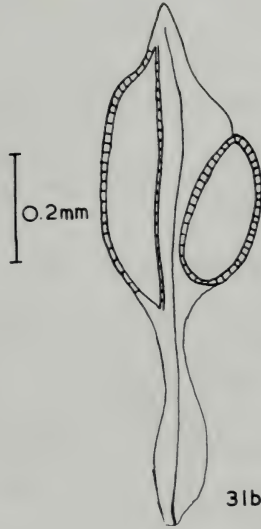

31b

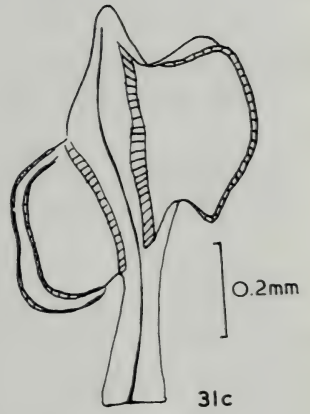

31c

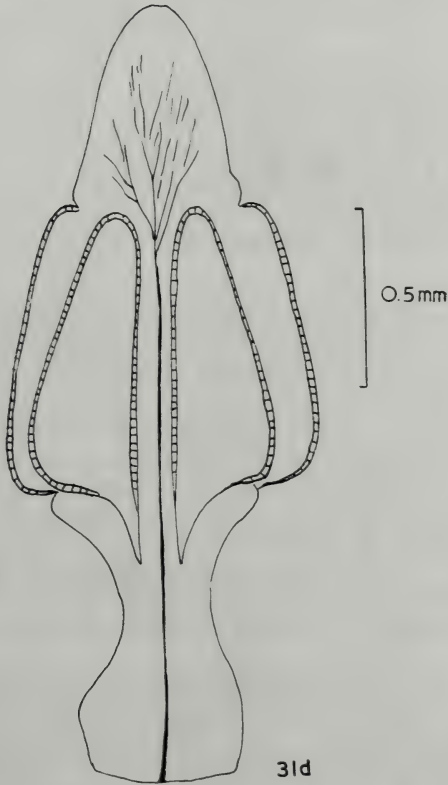

31d

VATICA

Stamens. x 100

a. & b. *V. wallichii* : adaxial and lateral view of stamen. c. *V. ridleyana* : lateral view. d. *V. nitens* : adaxial view.

Anthers: 4 loculed; the locules ovate-elliptic; short and broad, introrse; unequal, abaxial anther sacs larger than adaxial pair; anther sacs are separated along the whole length by fleshy connective; dehiscing longitudinally.

Appendages: connective produced into short, thick conical appendage, with an obtuse or pointed apex, much expanded in *V. nitens*.

Vasculature: single vascular trace seen between the anther sacs, ending near the appendage to connective but in *V. nitens* the vascular bundle branches out within the expanded appendage.

D. GENERALISATIONS AND DISCUSSION

The stamens of the Dipterocarpaceae are either numerous or reduced to a definite number. For instance, there are 40–50 stamens in *Vateria indica* and *Shorea sericea*, 30–40 in the Balau group of *Shorea*, 25–30 in *Upuna*, 20–25 in *Anisoptera*, 10 in *Hopea sangal* and *Shorea maxima*; and the rest of the species studied possess 15 stamens (Table 1). They are arranged in 1, 2 or more whorls. The commonest number of dipterocarp stamens is 15 and they are arranged in 2 whorls, namely 5 in the inner whorl and 10 in the outer whorl. The stamens in a flower may be uniform or dimorphic, in the latter case stamens of the outer whorl usually differ from those in the inner whorl in their external morphology and in their length (eg. the Red Meranti group of *Shorea*, Figs. 26 and 27).

The stamens are mostly hypogynous and often adnate to the base of the petals. In some cases they are perigynous (eg. *Dipterocarpus*, *Anisoptera*). The stamens are usually well differentiated into three parts: filament, connective and anthers. The stamens are mostly glabrous but they may be hispid, as in *Anisoptera laevis*, *Cotylelobium burckii* (Fig. 4e; Plate 1A), *Dipterocarpus kunstleri* (Fig. 5b), the Balau group of *Shorea* (Fig. 18; Plate 1E), *Vateria indica* (Fig. 29a; Plate 1G), *Parashorea malaanonan* (Fig. 14a) and others not studied here.

The anthers are usually 4-loculate, but often variable in shape. The abaxial pair of anther-locules are usually larger and projecting beyond the adaxial pair. Sometimes the adaxial pair becomes so obsolete that only 2 locules of the abaxial pair are present as in the Meranti Damar Hitam group of *Shorea* (Fig. 22; Plate 1D). The anther-sacs vary from elongate, linear-oblong to oval, elliptic, elliptic-oblong or ovate in shape. The elongate, linear-oblong types of anther-sacs are found in *Anisoptera*, *Cotylelobium*, *Dipterocarpus*, *Dryobalanops*, *Doona*, *Neobalanocarpus*, *Parashorea*, *Pentacme*, *Vateria*, *Vatica*. The oval, elliptic-oblong types can be seen in *Anisoptera curtisii*, *Upuna borneensis*, *Shorea*, *Hopea* and sometimes in the adaxial pair of anther-sacs of *Vatica ridleyana*. The anthers are often glabrous, or in some other genera and species they may be clothed with stiff hairs eg. *Anisoptera laevis*, *Cotylelobium burckii*, *Dipterocarpus kunstleri*, *Vateria indica*. The anthers are introrse or latrorse, dehiscing longitudinally.

The connectives of anthers are usually broadened in *Vatica* (Fig. 31; Plate 1H), *Vateria* (Fig. 29), *Dipterocarpus* (Fig. 5) and are narrowed or constricted especially in *Shorea*, *Hopea*, *Upuna*. The connectives are sometimes apically extended into a sterile appendage which is variable in shape and size. In many groups, the shape and size of the appendage are very characteristic and therefore of diagnostic value. In *Anisoptera laevis* (Fig. 2a), *Neobalanocarpus heimii* (Fig. 3d, e), *Dryobalanops* (Fig. 9a), *Cotylelobium* (Plate 1A), *Parashorea malaanonan* (Fig. 14a), the appendages are in the form of a short, erect, apiculate mucro. The length of appendages varies from 1/20 to 1/5 the length of the

TABLE 1

Genus	Species	Number of stamens
<i>Anisoptera</i>	<i>A. curtisii</i>	20 - 25
	<i>A. laevis</i>	15
<i>Cotylelobium</i>	<i>C. burckii</i>	15
	<i>C. malayanum</i>	15
<i>Dipterocarpus</i>	<i>D. gracilis</i>	30
	<i>D. oblongifolia</i>	15
	<i>D. kunstleri</i>	30
<i>Doona</i>	<i>D. gardneri</i>	15
	<i>D. macrophylla</i>	15
<i>Dryobalanops</i>	<i>D. aromatica</i>	30
	<i>D. oblongifolius</i>	30
<i>Hopea</i>	<i>H. apiculata</i>	15
	<i>H. beccariana</i>	15
	<i>H. minima</i>	15
	<i>H. nutans</i>	15
	<i>H. odorata</i>	15
	<i>H. sangal</i>	10
<i>Neobalanocarpus</i>	<i>N. heimii</i>	15
<i>Parashorea</i>	<i>P. malaanonan</i>	15
	<i>P. stellata</i>	15
<i>Pentacme</i>	<i>P. malayana</i>	15
<i>Shorea</i> Balau group	<i>S. exelliptica</i>	30 - 40
	<i>S. foxworthyi</i>	30 - 40
	<i>S. seminis</i>	30 - 40
Meranti Pa'ang group	<i>S. gratissima</i>	25
	<i>S. resinosa</i>	15
	<i>S. talura</i>	15
Meranti Damar Hitam group	<i>S. maxima</i>	10
	<i>S. resina-nigra</i>	15
Red Meranti group	<i>S. curtisii</i>	15
	<i>S. hemsleyana</i>	15
	<i>S. kunstleri</i>	15
	<i>S. lepidota</i>	15
	<i>S. leprosula</i>	15
	<i>S. parvifolia</i>	15
	<i>S. sericea</i>	40 - 50
	<i>S. borneensis</i>	25 - 30
<i>Upuna</i>	<i>U. indica</i>	40 - 50
<i>Vateria</i>	<i>V. nitens</i>	15
	<i>V. ridleyana</i>	15
	<i>V. wallichii</i>	15

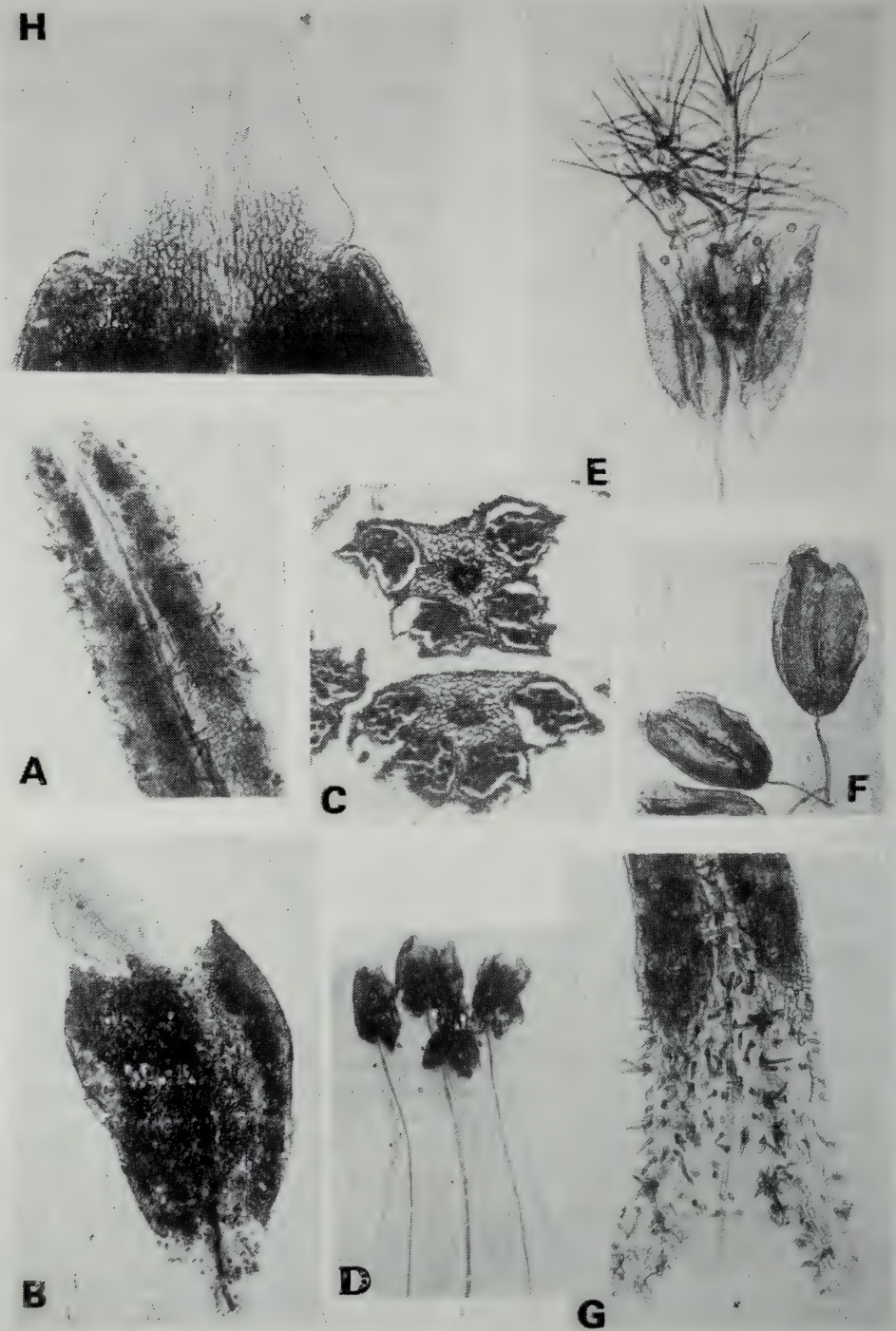

(Plate I) STAMENS OF THE DIPTEROCARPACEAE

A. *Cotylelobium burckii*, showing hispid anther (in part); B. *Doona gardneri*, showing a stamen with clavate appendage; C. *Neobalanocarpus heimii*, transverse section of flower bud showing anthers; D. *Shorea resina-nigra*, showing stamens with an inconspicuous, needle-like appendage; E. *Shorea siminis*, showing stamens with a densely barbate appendage; F. *Shorea talura*, showing stamens with a linear appendage; G. *Vateria indica*, showing part of hispid anther with auriculate base; H. *Vatica nitens*, showing tip of anther with stout, conical appendage.

stamens. Short, slender, subulate forms (length varying from 1/20 to 1/4 the length of the stamen) are seen in most *Shorea* except the Meranti Pa'ang group (Fig. 21; Plate 1F) in which the long appendages are filamentous, whip-like with a setaceous tip (length varies from 1/2 to 3/4 the length of the stamen). Long, filamentous, whip-like setose or glabrous appendages are found in *Hopea* (setose) (Fig. 12), *Anisoptera curtisii* (glabrous) (Fig. 2b, c), Meranti Pa'ang group of *Shorea* (setose) (Fig. 21; Plate 1F) and it is especially long in *Upuna* (glabrous) (Fig. 28) which may be as long as or even longer than the whole length of the stamen. Appendages of the Balau group of *Shorea* (Fig. 18; Plate 1E) are densely pubescent.

In *Dipterocarpus* (Fig. 5) and *Vateria indica* (Fig. 29), the sterile tissues of the anthers extends out apically as an erect, flattened, long and pointed appendage. The appendage is very long in *Dipterocarpus* (as long as the stamen) and shorter in *Vateria indica* (1/6 to 2/5 the length of the stamen). Clavate, fleshy appendages are found in *Doona* (Fig. 7; Plate 1B), *Parashorea* (Fig. 14a), *Pentacme* (Fig. 15) and *Vatica* (Fig. 31d; Plate 1H), they vary from 1/8 to 1/3 the length of the stamens. The clavate appendage with an obtuse or truncate apex is found in *Doona*, or with cuspidate apex as in *Parashorea malaanonan*. In *Pentacme malayana*, the appendage is falciform. The stamens of *Vatica* have a conical stout, tapering appendage, continuous with the sterile tissues of the anthers. The apical appendages are usually erect or sometimes bent abaxially egs. *Shorea exelliptica* (Fig. 18c), Meranti Pa'ang group of *Shorea* (Fig. 21; Plate 1F) and *Pentacme malayana* (Fig. 15); or it may be reflexed at anthesis eg. *Shorea hemsleyana* (Fig. 23.) Inappendiculate stamens are seen in *Shorea sericea* (Fig. 27g).

The filaments are mostly free or sometimes connate at the base eg. *Dryobalanops* (Fig. 8f, i). They are sometimes adnate to the petals eg. *Hopea* (Fig. 11q), Meranti Pa'ang group of *Shorea* (Fig. 19g, h) or united into bundles eg. *Shorea sericea*. The filaments in general are uniform in shape throughout the genera, compressed and applanate, narrowed at the top, and tapering gradually or abruptly towards the base. In *Shorea sericea* the filament is elongated, slender, twisted and thread-like.

Each stamen receives a single vascular bundle usually ending at the base of the appendage to the connective, sometimes extending into the appendages as in *Dipterocarpus* (Fig. 5), *Doona macrophylla* (Fig. 7d), *Parashorea malaanonan* (Fig. 14a), and branching out within the fleshy appendages of *Doona gardneri* (Fig. 7a, b, c) and *Vatica nitens* (Fig. 31d; Plate 1H). In *Hopea nutans* and *Hopea sangal*, the traces of epipetalous staminal bundles are fused with the vascular bundle in the corolla tube at the base. In the Red Meranti group of *Shorea*, egs. *S. hemsleyana* and *S. lepidota* the single vascular trace branches, thus there are 3 short traces in the connective. In the case of stamens whose filaments are fused at the base, a staminal bundle originates from the central stele of the flower, branching out to give rise to 2, 3 or more vascular strands, each strand entering a single stamen. Examples of the staminal bundle giving rise to 3 branches have been observed in *Dryobalanops oblongifolia*, in the Balau group of *Shorea* (Plate 1E) (egs. *S. exelliptica*, *S. foxworthyi*, and *S. seminis*) and in *Hopea nutans*. In *Shorea sericea*, the staminal bundle seems to branch out to 5 vascular traces, each supplying a single stamen.

Following the classical theory, the primitive stamen is a broad three-veined microsporophyll possessing two pairs of linear, non-marginal sporangia, deeply embedded in its surface (Canright 1952, Eames 1961). Such relatively unmodified stamens are found in the woody ranalean families, eg. Degeneriaceae, Himantandraceae (Bailey and Smith 1942; Bailey et al 1943), *Austrobaileya* and certain genera of the Magnoliaceae. The connective thus constitutes a major part of the anther in primitive families and the sporangia are relatively minor structures. In advanced families, the connective is a slender, median axis, sometimes hardly more than a thread or point of attachment for the anther lobes. The distal appendage of the connective, which is a typical feature of the anther in more or less primitive families like Magnoliaceae, Nymphaeaceae, is largely lost in advanced families, though it may persist there and even be elaborated for pollination, rather than the persistence of a primitive character. Filaments vary in shape from broad and dilated to terete and threadlike and from short to long. The shorter and broader types of filaments are in general more primitive. In vasculature, there is reduction in number of veins from three traces to one trace in the advanced stamens. The sporangium is primitively slender and elongate in less advanced families and in more advanced stamens, it has progressively shortened becoming more globose. The primitive stamen was laminar, with two pairs of sporangia borne on either the adaxial or abaxial surface. From this simple stamen, the slender stamen with marginal pairs of sporangia is developed. The dorsiventral form is lost and the specialised anther of the higher families is more or less four-angled and the filament terete. The number of sporangia in the anther is usually four, when there is less than four, this represents a reduction from the basic four. The two-sporangiate types are considered more advanced than the four-sporangiate types. (Eames, 1961).

The following discussion on the stamens of the Dipterocarpaceae is concentrated on the following points:

A. The protrusion of the connective; B. Vasculature and C. Suggested general evolutionary trends.

A. *The protrusion of the connective.*

The prominent connectives of the Dipterocarpaceae was mentioned by Parkin (1951). It was suggested that the continuation of the connective beyond the anther as a sterile tip in the Magnoliaceae may have ancestral significance. He further suggested a comparison of the vestige with the sterile, pointed extremity of the Bennettitean microsporophyll. Among the polypetalous families with produced connectives are the Magnoliaceae, Annonaceae, and Nymphaeaceae. However, according to Canright (1952), developmental studies of flowers in other families have shown that the anther normally develops very early in floral ontogeny, but that protrusion of the connective does not take place until just before anthesis. Thus it seems to suggest that extreme protrusion of the anther apex is a specialised rather than a primitive character.

Parkin also suggested that the prolongation of the connective may have biological value as it is quite possible that the protrusion, may have been extended and elaborated in one way or another to assist in pollination. Howard (1948) observed that in a subsection of the native West Indian species of *Magnolia* (*Magnoliaceae*), the connective is produced to a setaceous tip which is usually the length of the thecae. The setaceous tip plays a very important role in the distribution of pollen in this group of species. In the flower bud, the connective

tips are forced against the gynoecium and soon becomes firmly embedded in the fleshy gynoeical tissue. Hence, stamens are held by the connective in the reversed position, an advantageous position for pollen distribution. Parkin (1951) suggested that the dipterocarps should receive some attention in this respect.

Connective protrusions of various lengths were observed in all the species studied. Only in the Red Meranti group of *Shorea*, eg. *S. sericea*, inappendiculate stamens are present. The fleshy, clavate appendages seen in *Doona*, (Fig. 7; Plate 1B), *Parashorea malaanonan* (Fig. 14a), *Pentacme malayana* (Fig. 15), *Vatica nitens* (Fig. 31d; Plate 1H) seem to indicate that they are more primitive according to Hallier's (1903; cited in Parkin, 1951) definition of the primitive stamen. Extremely long, filiform, subulate appendages which may be setose or glabrous, are present in *Dipterocarpus* (Fig. 5), *Hopea* (Fig. 12), Meranti Pa'ang group of *Shorea* (Fig. 21; Plate 1F), *Upuna* (Fig. 28) and *Anisoptera curtisii* (Fig. 2b, c). It appears that they may have some bearings to the pollination mechanisms. It would seem, therefore, that the stamens of these genera represent the more advanced forms. The appendages usually have no vascular tissue.

B. Vasculature

Stamens of the dipterocarp species studied are supplied with a single vascular bundle which traverses the filament, enters the connective, terminating blindly near the apex. Sometimes it enters the distal appendage, eg. *Dipterocarpus* (Fig. 5), *Doona* (Fig. 7), *Parashorea malaanonan* (Fig. 14a), *Vatica* (Fig. 31d; Plate 1H). Branching within the connective is observed in the stamens of the Red Meranti group of *Shorea*. The common one trace condition was considered to have arisen by reduction in number of traces (Eames, 1961).

Stamen bundles are seen in the Balau group and the Red Meranti group of *Shorea*, *Hopea*, *Dryobalanops*. Usually the staminal bundle divides to give rise to three branches, each serving a stamen, eg. members of the Balau group of *Shorea* (Plate 1E) (e.g. *S. exelliptica*, *S. foxworthyi*, *S. seminis*); *Hopea nutans*, *Dryobalanops oblongifolia*, or the bundle divides into five vascular traces as in *S. sericea*.

C. Suggested general evolutionary trends

Species of the Dipterocarpaceae studied seem to show certain specialisations. The following evolutionary trends in stamens are suggested:

1. Elongation of appendage to connective and gradual shortening or loss of appendage.
2. Elongation and tapering of the upper part of the filament.
3. Development of hairs.
4. Development of anther sacs with apical and basal portions produced into appendages.
5. Reduction in number of sporangia.
6. Shortening of sporangia from linear oblong to ovate or subglobose.
7. Connective tissue becoming narrow and constricted; reduction in connective tissue in both apical and basal portions of anthers.

A diagram (Diagram 1) illustrating the probable course of evolution of the stamens in the Dipterocarpaceae have been drawn out, based on the morphology of the stamens studied and on the evolutionary trends listed above. Representative members of certain genera have been selected: *Cotylelobium burckii*, *Hopea nutans* (taken as representative of those with longer appendages in *Hopea*, *Shorea talura* of Meranti Pa'ang group of *Shorea*, *Shorea resina-nigra* of Meranti Damar Hitam group, *Shorea hemsleyana* of Red Meranti group (taken as representative of the group excluding *S. parvifolia*, *S. sericea* and *S. kunstleri*).

S. parvifolia (Fig. 27e) seems to be the basic form in the genus *Shorea* because of the short appendage, broad and short filament and elliptic oblong sporangia. From this basic form is the Balau group (Fig. 18; Plate 1E) with its longer filament and its appendage projects abaxially, leading on to the Meranti Pa'ang group (Fig. 21; Plate 1F) with long produced recurved appendage. The tendency is also towards the loss of appendage as in the Red Meranti group (Fig. 26, 27) eg. *S. sericea* or reduction to thin needle-like appendage as in *S. resina-nigra* (Fig. 22d) of the Meranti Damar Hitam group. Diagram 2 illustrates the probable course of evolution of stamens in the genus *Shorea*.

The stamens of *Hopea* are very alike certain members of *Shorea* except that they display an increased elongation of the appendage which are filamentous and setose. *Anisoptera curtisii* has stamens which are very similar to *Upuna* with reference to their long appendages. *Vatica wallichii* (Fig. 31a, b) seems to have stamens nearer to that of *Shorea*. *Vatica nitens* (Plate 1H) with its clavate appendage could be the primitive form.

The progressive elongation of stamen filaments is apparent in the *Hopea* and *Shorea* species, especially the Meranti Damar Hitam group eg. *S. resina-nigra* and *S. maxima*; also in the Red Meranti group, eg. *S. hemsleyana*, *S. leprosula*, *S. sericea*, *S. curtisii*, *S. lepidota*. The elongation of stamen filaments in more specialised flowers can have either one or two different functions (Stebbins, 1974). In wind-pollinated flowers, it places the dehiscing anthers well above the level of the perianth and so increases the efficiency of pollen dispersal. In flowers pollinated by nectar-seeking insects or other animal vectors, elongate filaments place the anthers in such a position that pollen is dusted onto particular parts of the animals' body during its visit. *Shorea sericea*, with its long and twisted filaments is very likely to be wind-pollinated. Adnation of stamen filaments to the corolla tube is a common specialisation as seen in *S. resinosa*, *S. gratissima*, *Hopea sangal*. The adaptive value of the epipetalous condition was probably the precise positioning of the anthers with respect to the stigma and the insect pollinators (Stebbins, 1974).

In *Dipterocarpus oblongifolius*, there is an outer ring of staminodes (Fig. 5c) The presence of staminodes that are homologous with stamens and apparently derived from them is characteristic of many flowers that are highly specialised for insect pollination (Stebbins, 1974). The long filiform appendages of *Anisoptera*, *Dipterocarpus*, *Hopea*, the Meranti Pa'ang group of *Shorea* and *Upuna* which may be setose or glabrous, as mentioned earlier, seems to be highly evolved structures for assisting in pollination. The stamens of these genera may be regarded as more advanced, in this respect. Moreover, the Balau group of *Shorea* (Plate 1E) have appendages which are barbate. These bristles may serve to brush off pollen from insect visitors. The long appendages of *Hopea* (Fig. 12) are usually minutely setose, eg. *H. nutans*, *H. beccarianna*, *H. apiculata*. Setaceous nature of the appendages may cause stamens to cling onto the insects' body and

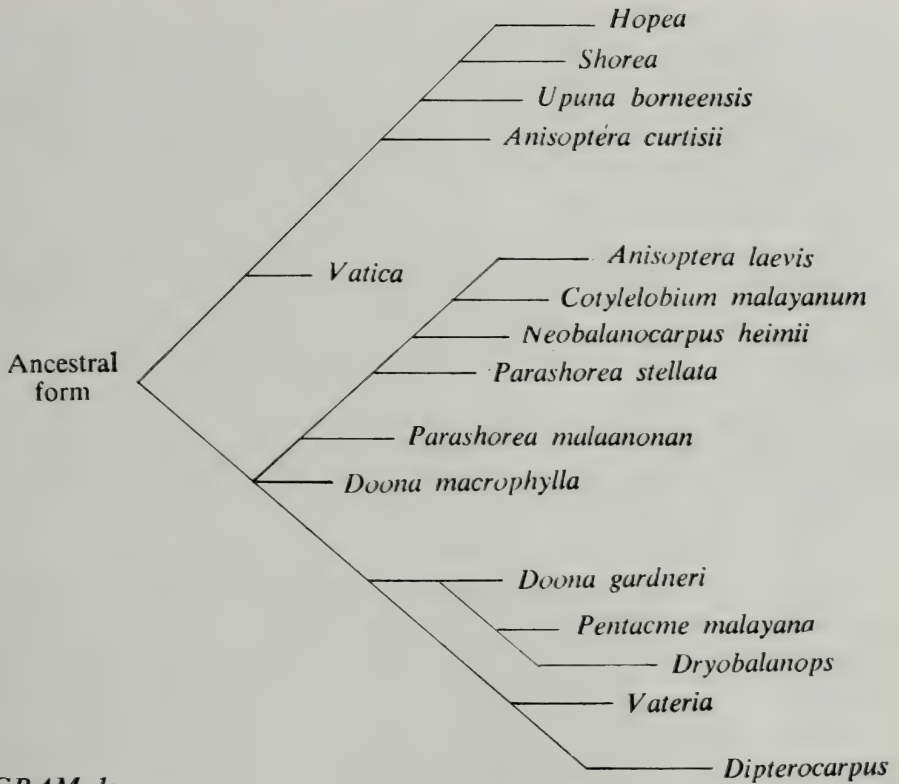

DIAGRAM 1:

Hypothetical evolutionary trends of stamens in the family of Dipterocarpaceae

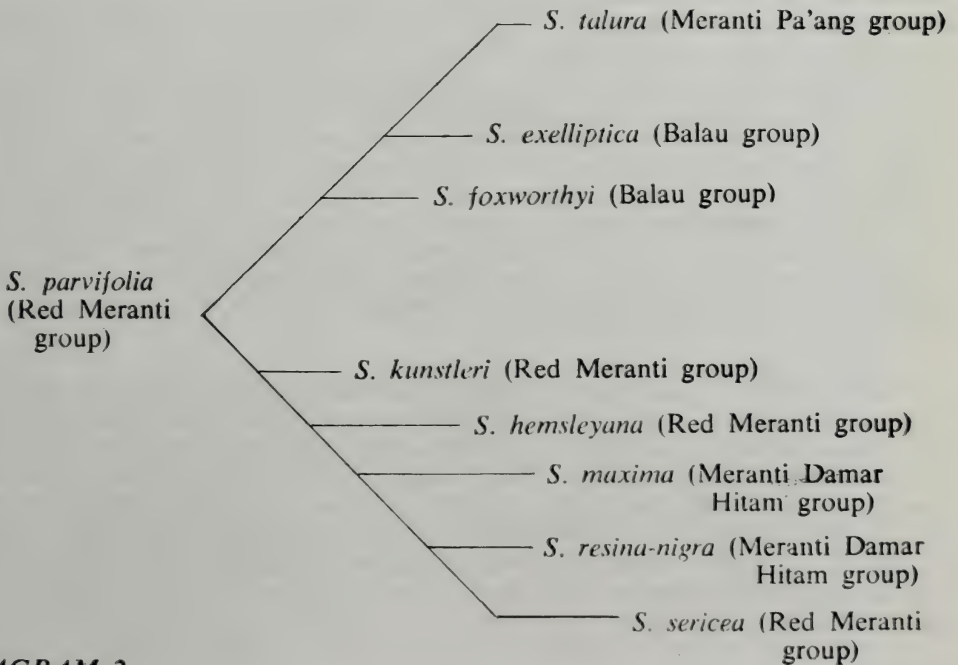

DIAGRAM 2:

Hypothetical evolutionary trends of stamens in the genus *Shorea*

be carried away to other flowers. The hispidous nature of a number of stamens of the Dipterocarpaceae is also prominent. Hairs are present in *Anisoptera laevis* (Fig. 2a), on the lateral edges of the anther sacs, all over the stamen of *Cotylelobium burckii* (Fig. 4e; Plate 1A), on the abaxial face of the stamen of *Dipterocarpus kunstleri* (Fig. 5b); on the connectival region of *Parashorea malaanonan* (Fig. 14a) and on the stamen of *Vateria indica* (Fig. 29a).

Another trend of evolution is observed in the stamens with elongate sporangia. *Doona macrophylla* (Fig. 7d) seems to be the basic form, with its long sporangia and clavate appendage. There is a tendency for the anthers to be pointed at the apices as seen in *Doona gardneri* (Fig. 7a, b, c; Plate 1B) and this is most pronounced in *Pentacme* (Fig. 15). The stamens of *Dryobalanops* (Fig. 9) also have apiculate anthers but it is not so pronounced. Two patterns can be seen: there is elongation of the appendage in *Vateria indica* (Fig. 29a) and very pronounced in *Dipterocarpus* (Fig. 5), or in the reduction of the appendage in *Parashorea stellata* (Fig. 14b), *Neobalanocarpus heimii* (Fig. 3d, e), *Anisoptera laevis* (Fig. 2a) and *Cotylelobium* (Fig. 4d, e).

The tendency is also towards reduction in sporangia from four to two in the Meranti Damar Hitam group of *Shorea* (Fig. 22) and *Vateria indica* (Fig. 29). Some stamens of *V. indica* have four sporangia, some two and some three. This probably represents the loss of sporangia. Eames (1961) described this condition in Proteaceae in which one anther may have four sporangia, two others have two each and the fourth sterile. The loss of sporangia according to Eames is often by abortion in early stages, and evidence of the loss may persist in the mature anther.

The family contains a number of members with flattened stamens eg. *Anisoptera laevis*, *Neobalanocarpus heimii*, *Cotylelobium*, *Dipterocarpus*, *Dryobalanops*, *Doona*, *Parashorea*, *Pentacme*, *Vateria*. Stebbins (1974) considered that flattened stamens occur only in families of angiosperms that are regarded as relatively primitive, and this is in accord with the much greater frequency of coleopteran pollination in these families which probably originated and developed before the more specialised Hymenoptera, Diptera and Lepidoptera had evolved. Diels has expressed the opinion that the earliest angiosperms were pollinated by beetles (Coleoptera). Recent observations showed that various primitive genera, such as *Calycanthus*, *Eupomatia*, *Magnolia* and the Annonaceae are pollinated by beetles; Leppik has made the interesting suggestion that beetles and other primitive insects first became pollen gatherers in association with the Jurassic Bennettitales and later transferred their adaptations to evolving angiosperms.

Stebbins (1974) stated that this kind of pollination, and the flattened stamens associated with it, have persisted chiefly in woody plants of tropical regions which can tolerate relatively inefficient pollination mechanisms because of the long life of the individual plant and the equable climate, permitting each flower to remain receptive to pollinators for a long period of time. Little is known about the pollination of dipterocarps. Meijer (1974) mentions the far greater frequency of occurrence of stingless bees belonging to the genus *Trigonia* often living at the base of dipterocarp trees in nests made of resin of the trees and it is unlikely that pollinators can be very specific.

LITERATURE CITED

- Airy-Shaw, H.K. 1973. A Dictionary of Flowering Plants and Ferns, by J.C., Willis (8th edit.). Cambridge: Cambridge Univ. Press.
- Ashton, P.S. 1978. Flora Malesiana Precursores: Dipterocarpaceae. Gard. Bull. Sing. 31: 5-48.
- Bailey, I.W. and A.C., Smith. 1942. Degeneriaceae, a new family of flowering plants from Fiji. Jour. Arnold Arb. 23: 356-365.
- Bailey, I.W. and C.F., Nast. 1943. The comparative morphology of the Winteraceae. I. Pollen and stamens. Jour. Arnold Arb. 24: 340-346.
- Canright, J.E. 1952. The comparative morphology and relationships of the Magnoliaceae. I. Trends of specialisation in the stamens. Amer. Jour. Bot. 39: 484-497.
- Croizat, L.C.M. 1952. Manual of Phytogeography. The Hague: W. Junk.
- Eames, A.J. 1961. Morphology of the Angiosperms. New York: McGraw Hill.
- Foster, A.S. 1949. Practical plant anatomy (2nd ed.). New York: Van Nostrand.
- Howard, R.A. 1948. The morphology and systematics of the West Indian Magnoliaceae. Bull. Torrey Bot. Club 75: 335-357.
- Johansen, D.A. 1940. Plant microtechnique. New York: McGraw Hill.
- Meijer, W. 1974. Plant geographic studies on Dipterocarpaceae in Malesia. Ann. Missouri Bot. Gard. 61: 806-818.
- Parkin, J. 1951. The protrusion of the connective beyond the anther and its bearing on the evolution of the stamen. Phytomorphology 1: 1-8.
- Stebbins, G.L. 1974. Flowering plants. Evolution above the species level. London: Edward Arnold.
- Symington, C.F. 1943. Forester's Manual of Dipterocarps. Malayan Forest Record no. 16. (Reprinted in 1974. Kuala Lumpur: Penerbit Universiti Malaya).

APPENDIX

LIST OF VOUCHER HERBARIUM SPECIMENS FOR STUDIES

1. *Anisoptera curtisii* Dyer.
Gunong Angsi, Negri Sembilan, Malaya: *F.S. Watson* (CF No. 742), April 1916.
Bt. Bank F.R. Trengganu, Malaya: *Y.C. Chan* (FRI 25067), 15 May 1976.
2. *Anisoptera laevis* Ridl.
Ulu Gombak FR, Selangor, Malaya: *C.F. Symington* (KEP 47004), 31 August 1938.
3. *Balanocarpus curtisii* King = *Hopea minima* Sym. Waterfall, Penang, Malaya: *C. Curtis* 1406, March 1901.
4. *Balanocarpus heimii* King = *Neobalanocarpus heimii* Ashton, Malaya: *F.C. Yong* (KEP 98875), 11 May 1963. FRI Kepong, Malaya: *Collector unknown* (KEP 98870).
5. *Cotylelobium burckii* (Heim) Heim.
Aup, Sibuluan, Sarawak: *J. Wight* (SAR A0416), 14 June 1938.
6. *Cotylelobium malayanum* V.S1.
Sungei Morai, Singapore: *J.S. Goodenough* 4630, 18 July 1890.
7. *Dipterocarpus gracilis* Bl.
Ulu Gombak F.R., Selangor, Malaya: *K.M. Kochummen s.n.*, 22 April 1965.
8. *Dipterocarpus kunstleri* King
Jerangau S.L. Dungun, Malaya: *K.M. Kochummen* (KEP 76663), 28 July 1955.
9. *Dipterocarpus oblongifolius* Bl.
Kechau River, Pahang, Malaya: *M. Hashim* (C.F. No. 695), 1 June 1916.
FRI Kepong, Malaya: *Z. Ramli* (KEP 99075), 29 April 1965.
Gunong Tahang, Pahang Malaya: *Md. Haniff & Md. Nor* 8032, 20 June 1922.
Kepong, Malaya, *K.M. Kochummen* 97742, 12 May 1961.
10. *Doona gardneri* Thw.
Ceylon: *Thwaitesii s.n.*, 1919.

11. *Doona macrophylla* Thw.
Ceylon: *Thwaitesii* 3713.
12. *Dryobalanops aromatica* Gaertn. f.
Kuching Reserve, Selangor, Malaya: *Ahmad* 5047, 20 Sept. 1920.
FRI Arboretum, Kepong, Malaya: *F.S.P. Ng* (FRI 6320), 28 March 1972.
13. *Dryobalanops oblongifolia* Dyer
Kuantan, Pahang, Malaya: *J.G. Watson* (CF Field No. 3250), 21 May 1919.
FRI Arboretum, Kepong, Malaya: *F.S.P. Ng s.n.*, 28 March 1972.
14. *Hopea apiculata* Sym.
Field 12A FRI, Kepong, Malaya: *Motan* (KEP 80225), 15 March 1955.
15. *Hopea beccariana* Burck
Govt. Hill, Penang, Malaya: *C. Curtis* 1398, July 1888.
16. *Hopea mengarawan* Miq.
Temerloh, Pahang, Malaya: *Hamid* (C.F. 4621), 10 Dec. 1919.
17. *Hopea nutans* Ridl.
FRI Arboretum, Kepong, Malaya: *S. Chelliah* (KEP 98355), 17 March 1972.
18. *Hopea odorata* Roxb.
FRI Arboretum, Kepong, Malaya: *F.S.P. Ng* (FRI 6325), 30 March 1972.
19. *Hopea sangal* Korth.
Batu Gantong, Penang, Malaya: *Md. Haniff* (C.F. No. 3715), 5 June 1918.
20. *Parashorea malaanonan* (Blanco) Merr.
FRI Arboretum, Kepong, Malaya: *F.C. Yong* (KEP 99624), 5 April 1962.
21. *Parashorea lucida* (Miq.) Kurz
Bt. Naga F.R. Malaya: *V.P. Borges* (KEP 5611), 4 Oct. 1921.
22. *Parashorea stellata* Kurz
Bt. Naga Reserve, Perak, Malaya: *V.P. Borges* 5611, 4 Oct. 1921.
23. *Pentacme malayana* King
Pulau Rabana, Perlis, Malaya: *M.R. Henderson* 23107, 25 Nov. 1929.
24. *Shorea acuminata* Dyer
FRI Arboretum, Kepong, Malaya: *Z. Ramli* (KEP 98352), 17 March 1965.

25. *Shorea curtisii* Dyer
Bt. Timah F.R. Singapore: *Ngadiman* (S.F. No. 34784), 5 Sept. 1938.
26. *Shorea exelliptica* Meijer
FRI Arboretum, Kepong, Malaya: *Y.C. Chan* (FRI 18197), 4 June 1976.
27. *Shorea foxworthyi* Sym.
FRI Arboretum, Kepong, Malaya: *F.S.P. Ng* (FRI 22180), 12 March 1976.
28. *Shorea gratissima* Dyer
Bot. Gardens, Singapore: *H. Keng & Jumali s.n.*, May 1977.
29. *Shorea hemsleyana* (King) King ex Foxw.
FRI Kepong Malaya: *Y.C. Chan* (KEP 115740), 22 Jan. 1972.
30. *Shorea kunstleri* King.
Parit Reserve, Kinta, Perak, Malaya: *M.L. Weber* 13714, 18 Nov. 1927.
31. *Shorea lepidota* (Korth.) Bl.
Pasoh F.R.N.S. Malaya: *Y.C. Chan* (FRI 23894), 7 April 1976.
32. *Shorea leprosula* Dyer
Bt. Timah Reserve, Singapore: *Ngadiman* (S.F. No. 37251, Tree No. 275), 16 Oct. 1939.
33. *Shorea maxima* (King) Sym.
FRI Arboretum, Kepong, Malaya: *F.S.P. Ng* (FRI 6326), 30 March 1972.
34. *Shorea ovalis* (Korth.) Bl. = *S. sericea* Dyer
FRI Arboretum, Kepong, Malaya: *F.C. Yong* (KEP 99988), 14 June 1963.
35. *Shorea parvifolia* Dyer
FRI Arboretum, Kepong, Malaya: *Ahmad* (KEP 99392), 6 April 1961.
36. *Shorea resinosa* Foxw.
FRI Kepong, Malaya: *Y.C. Chan* (FRI 18193), 24 Feb. 1976.
37. *Shorea resina-nigra* Foxw.
FRI Arboretum, Malaya: *K.M. Kochummen* (KEP 98876), 5 May 1963.
38. *Shorea seminis* (de Vriese) V. S1.
Sarawak: *Yakup* S79, 25 Sept. 1958;

J. Singh (SAN 60875), 10 May 1967; *Rehal* S9581, 26 August 1957.

Sandakan, Borneo: *A. Bakar* 36214, 8 May 1963.

39. *Shorea sericea* Dyer

Govt. Hill, Penang, Malaya: *Md. Haniff* 3760, 24 June 1918.
Temerloh, Pahang, Malaya: *Hamid* 5475, 11 Dec. 1920.

40. *Shorea talura* Roxb.

FRI, Kepong, Malaya: *Collector unknown s.n.*, 11 Feb. 1963.

41. *Upuna borneensis* Sym.

Sarawak: *Moksin* S1917, 13 August 1955.

42. *Vateria indica* Linn.

Yellapur, Bombay: *N.L. Bor.* 9671, 26 April 1939.

43. *Vatica nitens* King

Perak, Malaya: *F.S.P. Ng* (FRI 21000), 28 Jan. 1972.

44. *Vatica ridleyana* Brandis

Meranta Avenue, Bot. Gdns, Singapore: *M.R. Henderson* s.n., 13 March 1931.

45. *Vatica wallichii* Dyer

Lawn 2, Bot. Gdns., Singapore: *C.X. Furtado* (S.F. No. 37446), 27 Nov. 1941.

Singapore: *J. Sinclair* (S.F. No. 10696), 10 June 1962.

FRI Kepong Malaya: *Mat Asri* (FRI 21682), 27 August 1976.

CHECK LIST OF MOSSES OF SINGAPORE

by

Y. C. WEE

*Department of Botany,
University of Singapore*

SUMMARY

A total of 126 species of mosses from 51 genera and 21 families, recorded from Singapore, are contained in this check list.

Fleischer (1900–1922), in his four volumes on the moss flora of Bogor, Indonesia, listed a number of species collected from Singapore. Further records of local mosses are contained in Dixon's (1926) list of mosses from the Malay Peninsula, collected mainly by H. N. Ridley, I. H. Burkill, R. E. Holttum, and others from the Singapore Botanic Gardens. A list of the mosses collected from the Botanic Gardens itself was compiled by Holttum (1926). Further work was not seen until Johnson (1964) published her account of the Malaysian Leucobryaceae and much later, the Fissidentaceae (Johnson, 1973).

Dixon's (1926) list is by far the most comprehensive, but it is very much outdated. The present paper is an attempt at updating the list of mosses recorded from Singapore. Most of the species are from the above mentioned papers. Those marked with an asterisk (*) are from the records of the Bryophyte Herbarium maintained by the Department of Botany, University of Singapore, as well as from collections made by myself during the last two years. A total of 126 species from 51 genera and 21 families are included. The nomenclature and authorities cited are in accordance with Wijk *et al.* (1959–1969). The most appropriate name is given for each species, while any other name under which it has been reported is added in parenthesis.

FISSIDENTACEAE

Fissidens Hedw.

F. ceylonensis Doz. et Molk.

F. crassinervis Lac.

F. mittenii Par.

F. mittenii Par. var. *javensis* Fleisch.

F. sylvaticus Griff. (*F. zippelianus* Doz. et Molk.)

DITRICHACEAE

Garckea C. Muell.

G. comosa (Doz. et Molk.) Wijk et Marg. (*G. phascoides* C. Muell.)

DICRANACEAE

Campylopus Brid.

C. serratus Lac.

Dicranoloma (Ren.) Ren.

D. braunii (C. Muell.) Par.

Microdus Schimp.

M. miquelianus (Mont.) Besch.

LEUCOBRYACEAE

Arthrocormus Doz. et Molk.

**A. schimperi* (Doz. et Molk.) Doz. et Molk.

Exodietyon Card.

**E. blumii* (C. Muell.) Fleisch.

Leucobryum Hampe.

L. aduncum Doz. et Molk.

L. javense (Brid.) Mitt.

L. sanctum (Brid.) Hamp.

L. scalare C. Muell. ex Fleisch.

Leucophanes Besch.

L. albescens C. Muell.

L. candidum (Schwaegr.) Lindb. (*L. aciculare* C. Muell.)

L. candidum (Schwaegr.) Lindb. var. *densifolium* (Mitt.) Dix.
(*L. densifolium* Mitt.)

L. octoblepharioides Brid.

CALYMPERACEAE

Calymperes Sw.

C. bescherellei Fleisch.

C. delessertii Besch.

C. dozyanum Mitt.

C. hampei Doz. et Molk

C. longifolium Mitt.

C. nicobarense Hamp.

**C. nietneri* C. Muell.

C. porrectum Mitt. (*Calymperes salakense* Besch.)

C. punctulatum Hamp.

C. recurvifolium Besch.

C. serratum A. Braun ex C. Muell.

C. tahitense (Sull.) Mitt. (*Calymperes orientale* Mitt. ex Besch.)

C. tenerum C. Muell.

**C. thwaitesii* Besch. (*C. fordii* Besch.)

Calymperopsis (C. Muell.) Fleisch.

C. tjibodensis (Fleisch.) Fleisch. (*Syrrhopodon tjibodensis* Fleisch.)

Syrrhopodon Swaegr.

S. albo-vaginatus Swaegr.

S. ciliatus (Hook.) Swaegr.

S. confertus Lac.

S. croceus Mitt. (*Calymperidium croceum* (Mitt.) Fleisch.)

**S. gardneri* (Hook.) Swaegr.

S. griffithii Mitt.

S. horridulus Fleisch.

S. involutus Swaegr.

S. muelleri (Doz. et Molk.) Lac. (*Calymperidium muelleri* Doz. et Molk.)

S. revolutus Doz. et Molk.

S. ridleyi Broth. ex Dix.

S. rufescens Hook. et Grev.

S. spiculosus Hook. et Grev.

S. trachyphyllus Mont.

Thyridium Mitt.

T. fasciculatum (Hook. et Grev.) Mitt. (*Calymperes fasciculatum* (Hook. et Grev.) Mitt., *Syrrhopodon fasciculatus* Hook. et Grev.)

T. flavum (C. Muell.) Fleisch. (*Syrrhopodon flavus* C. Muell.)

T. manii Fleisch. (Syrhohodon *manii* C. Muell.)

T. repens (Harv.) Mitt. (Syrhohodon *repens* Harv.)

T. undulatulum (Broth. et Geh.) Fleisch. (Syrhohodon *undulatulus* Broth. et Geh.)

T. undulatum (Doz. et Molk.) Fleisch. (Syrhohodon *undulatus* (Doz. et Molk.) Lindb.)

T. wallisii (C. Muell.) Jaeg. (Syrhohodon *wallisii* C. Muell.)

POTTIACEAE

Hydrogonium (C. Muell.) Jaeg.

H. arcuatum (Griff.) Wijk et Marg. (*Barbula comosa* Doz. et Molk.)

H. consanguineum (Thwait. et Mitt.) Hilp. (*Barbula consanguinea* (Thwait. et Mitt.) Jaeg.)

Hymenostomum R. Brown

H. malayense Fleisch.

Hyophila Bridg.

H. involuta (Hook.) Jaeg. (*H. commutata* Broth., *H. dozy-molkenboeri* Fleisch., *H. micholitzii* Both.)

H. javanica (Nees et Blum.) Brid.

Semibarbula Herz. ex Hilp.

S. orientalis (Web.) Wijk. et Marg. (*Barbula indica* (Hook.) Spreng., *Trichostomum orientale* Web.)

SPLACHANCEAE

Gymnostomiella Fleisch.

G. vernicosa (Hook.) Fleisch.

Splachnobryum C. Muell.

S. oorschotii (Lac.) C. Muell.

BRYACEAE

Bryum Hedw.

B. coronatum Schwaegr.

**B. junghuhnianum* Hamp. ex Doz. et Molk.

MNIACEAE

Mnium Hedw.

**M. succulentum* Mitt.

RHIZOGONIACEAE

Rhizogonium Brid.

R. latifolium Bosch et Lac.

R. spiniforme (Hedw.) Bruch

HYPNODENDRACEAE

Hypnodendron (C. Muell.) Lindb.

H. arborescens (Mitt.) Lindb.

ORTHOTRICHACEAE

Desmotheca Lindb.

D. apiculata (Doz. et Molk.) Lindb.

Groutiella Steere

G. goniorrhyncha (Doz. et Molk.) Wijk et Marg. (*Macromitrium goniorrhynchum* (Doz. et Molk.) Mitt.)

Macromitrium Brid.

M. incurvifolium (Hook. et Grev.) Schwaegr.

MYURIACEAE

Myurium Schimp.

M. rufescens (Reinw. et Hornsch.) Fleisch.

Piloecium (C. Muell.) Broth.

P. pseudorufescens (Hamp.) C. Muell.

NECKERACEAE

Neckeropsis Reichdt.

N. gracilentata (Bosch et Lac.) Fleisch.

Pinnatella Fleisch.

P. kuehliana (Bosch et Lac.) Fleisch.

P. microptera Fleisch.

P. mucronata (Bosch et Lac.) Fleisch.

HOOKERIACEAE

Callicostella (C. Muell.) Mitt.

C. beccariana (Hamp.) Jaeg.

C. papillata (Mont.) Mitt.

C. prabaktiana (C. Muell.) Bosch et Lac.

HYPOPTERYGIACEAE

Cyathophorella (Broth.) Fleisch.

**C. tenera* (Bosch et Lac.) Fleisch.

Lopidium Hook. f. et Wils.

L. struthiopteris (Brid.) Fleisch. (*Hypopterygium javanicum* (Hamp.) Jaeg.)

THUIDIACEAE

Pelekium Mitt.

P. bifarium (Bosch. et Lac.) Fleisch. (*Thuidium bifarium* Bosch. et Lac.)

P. velatum Mitt.

PLAGIOTHECIACEAE

Plagiothecium B.S.G.

**P. neckeroideum* B.S.G.

SEMATOPHYLLACEAE

Acanthorrhynchium Fleisch.

A. papillatum (Harv.) Fleisch. (*Taxithelium papillatum* (Harv.) Broth.)

Acroporium Mitt.

A. asperifolium (Thwait. et Mitt.) Dix.

A. convolutum (Bosch. et Lac.) Fleisch.

**A. rufum* (Reinw. et Hornsch.) Fleisch. (*A. braunii* (C. Muell.) Fleisch.)

A. secundum (Reinw. et Hornsch.) Fleisch.

Glossadelphus Fleisch.

G. zollingeri (C. Muell.) Fleisch. (*Ectropothecium zollingeri* (C. Muell.) Jaeg.)

Meiothecium Mitt.*M. microcarpum* (Hook.) Mitt.*M. microcarpum* (Hook.) Mitt. var. *lineolatum* (Dub.) Fleisch.*M. jagorii* (C. Muell.) Broth.*Rhaphidostichum* Fleisch.*R. bruchii* (Doz. et Molk.) Fleisch.*R. leptocarpum* Fleisch.*R. luxurians* (Doz. et Molk.) Fleisch. (*Trichosteleum luxurians* (Doz. et Molk.) Broth.)*Sematophyllum* Mitt.*S. microcladiellum* Fleisch. (*Rhaphidostegium microcladum* (Doz. et Molk.) Broth.)*S. saproxylophilum* (C. Muell.) Fleisch. (*Rhaphidostegium saproxylophilum* (C. Muell.) Jaeg.)*Taxithelium* Spruc. ex Mitt.*T. capillipes* (Lac.) Broth.*T. instratum* (Brid.) Broth.*T. isocladum* (Bosch. et Lac.) Ren. et Card.*T. nepalense* (Schwaegr.) Broth.**T. vernieri* (Dub.) Bosch. (*T. lindbergii* (Jaeg.) Ren. et Card.)*Trichosteleum* Mitt.*T. boschii* (Doz. et Molk.) Jaeg. (*T. brachypelma* (C. Muell.) Par.)*T. monostictum* (Thwait. et Mitt.) Broth. var. *laevius* Dix.*T. singaporense* Fleisch.*Trismegistia* (C. Muell.) C. Muel.*T. lancifolia* (Harv.) Broth.*T. rigida* (Mitt.) Broth.*Warburgiella* C. Muell.*W. leptocarpa* (Schwaegr.) Fleisch. (*Trichosteleum leptocarpon* (Schwaegr.) Fleisch.)

HYPNACEAE

Ctenidiaedelpus Fleisch.

C. plumularia (C. Muell.) Fleisch. (*Taxithelium plumularia* (C. Muell.) Broth.)

Ectropothecium Mitt.

E. buitenzorgii (Bel.) Mitt.

E. incubans (Reinw. et Hornsch.) Jaeg.

**E. intorquatum* (Doz. et Molk.) Jaeg.

E. monumentorum (Dub.) Jaeg.

E. moritzii Jaeg.

E. singaporense Dix.

Isopterygium Mitt.

I. albescens (Hook.) Jaeg.

I. minutirameum (C. Muell.) Jaeg.

I. subalbescens Broth.

Taxiphyllum Fleisch.

**T. taxirameum* (Mitt.) Fleisch.

Vesicularia (C. Muell.) C. Muell.

V. dubyana (C. Muell.) Broth.

V. kurzii (Lac.) Broth.

V. miquelii (Lac.) Fleisch. (*Plagiothecium miquelii* (Lac.) Broth.)

V. montagnei (Bel.) Broth.

V. reticulata (Doz. et Molk.) Broth.

DIPHYSICIACEAE

Diphyscium Mohr

D. rupestre Doz. et Molk.

REFERENCES

- Dixon, H.N. 1926. A list of the mosses of the Malay Peninsula. *Gdns' Bull. Straits Settl.* 4, 1-46.
- Fleischer, M. 1900-1922. *Die musci der flora von Buitenzorg.* I-IV. Leiden.
- Holtum, R.E. 1926. A list of mosses collected in the Botanic Gardens, Singapore. *Gdns' Bull. Straits Settl.* 4, 88-91
- Johnson, A. 1964. An account of the Malaysian Leucobryaceae ('Lumut puteh'). *Gdns' Bul., Singapore*, 20, 315-360.
- Johnson, A. 1973. The Fissidentaceae (split-teeth mosses) of Singapore with notes on their Malaysian distribution. *Nanyang Univ. J.* 7, 64-77.
- Wijk, R. van der, Margadant, W.D. & Florschütz, P.A. 1959-1969. *Index Muscorum.* I-V. Utrecht.

THE LIMESTONE HILL FLORA OF MALAYA II*

by

S. C. CHIN

University of Malaya, Kuala Lumpur

Malaysia

CONTENTS

	<i>Pages</i>
Acanthaceae	69
Amaranthaceae	75
Anacardiaceae	76
Annonaceae	78
Apocynaceae	86
Aquifoliaceae	89
Araliaceae	89
Asclepiadaceae	91
Balanophoraceae	95
Balsaminaceae	95
Begoniaceae	97
Bignoniaceae	99
Bombacaceae	100
Boraginaceae	100
Burseraceae	101
Buxaceae	102
Capparidaceae	103
Caprifoliaceae	104
Cardiopteridaceae	104
Celastraceae	104

*Part I appeared in *Gardens' Bulletin*, XXX, 165-219, 1977.

	<i>Pages</i>
Chloranthaceae	106
Combretaceae	107
Compositae	108
Connaraceae	110
Convolvulaceae	111
Cucurbitaceae	112
Datisceae	113
Dilleniaceae	113
Dipterocarpaceae	113
Ebenaceae	116
Elaeocarpaceae	119
Ericaceae	119
Erythroxylaceae	120
Euphorbiaceae	120
Fagaceae	141
Flacourtiaceae	141
Gentianaceae	144
Gesneriaceae	145
Guttiferae	154
Hamamelidaceae	156
Hernandiacea	157
Hypericaceae	157
Icacinaceae	157
Labiatae	158
Lauraceae	162
Lecythidaceae	164
Leguminosae	165
Lentibulariaceae	171
Loganiaceae	171
Loranthaceae	173
Lythraceae	174

	<i>Pages</i>
Malvaceae	174
Melastomaceae	175
Meliaceae	178
Menispermaceae	179
Monimiaceae	180
Moraceae	180
Myristicaceae	186
Myrsinaceae	187
Myrtaceae	190
Nepenthaceae	192
Nyctaginaceae	192
Ochnaceae	193
Oleaceae	193
Onagraceae	196
Oxalidaceae	196
Passifloraceae	196
Piperaceae	196
Pittosporaceae	199
Polygalaceae	199
Polygonaceae	200
Primulaceae	201
Ranunculaceae	201
Rhamnaceae	201
Rhizophoraceae	203
Rosaceae	203

ACKNOWLEDGEMENTS

I am grateful to Wan Shahrizah for retyping this manuscript.

I am also grateful to Tem Smitinand (Deputy Director-General, Royal Forest Department, Thailand) for pointing out to me errors in the distributional data that appeared in the first part of this publication.

CORRECTIONS

The following species asterisked as being endemic to the **Malayan Peninsula** in Part I of this publication, are in fact not endemic to the **Malayan Peninsula**.

ANNONACEAE

Polyalthia lateritia Sinclair

APOCYNACEAE

Ervatamia peduncularis K. et G.

AQUIFOLIACEAE

Ilex maingayi Hk. f.

EUPHORBIACEAE

Cleidion javanicum Bl.

Cleistanthus macrophyllus Hk. f.

Mallotus griffithianus (M.A.) Hk. f.

GUTTIFERAE

Garcinia eugeniaefolia Wall. ex Anders.

LECYTHIDACEAE

Barringtonia fusiformis King

MELIACEAE

Aglaia argentea Bl.

MYRSINACEAE

Ardisia fulva K. et G.

A. solanacea Roxb.

RHAMNACEAE

Zizyphus pernettyoides Ridl.

CYPERACEAE

Fimbristylis trichophylla Ridl.

ORCHIDACEAE

Adenocos major Ridl.

Coelogyne pallens Ridl.

Corymborchis rhytidocarpa (Hk. f.) Holtt.

Dendrobium tetradon Rchb. f. ex Lindl.

Malaxis reniloba (Carr) Holtt.

Oberonia calcicola Holtt.

PALMAE

Arenga westerhoutii Griff.

ZINGIBERACEAE

Achasma macrocheilos Griff.

ANGIOSPERMS — DICOTYLEDONS

ACANTHACEAE

- | | | |
|--|---|----|
| 1. Stem twining | <i>Thunbergia fragrans</i> var. <i>javanica</i> | |
| Stem not twining | | 2 |
| 2. Fertile stamens 2. | | 3 |
| Fertile stamens 4. | | 19 |
| 3. Seeds 5 or more; leaf base decurrent | | 4 |
| Seeds 2-4; leaf base usually not decurrent | | 7 |
| 4. Herb 4-15 cm tall; seeds short hairy on the edge | | 5 |
| Herb 30-60 cm tall; seeds glabrous | <i>Andrographis tenuiflora</i> | |
| 5. Corolla 2.4 cm long | <i>Gymnostachyum diversifolium</i> | |
| Corolla much shorter | | 6 |
| 6. Corolla 1.5 cm long | <i>Gymnostachyum decurrens</i> | |
| Corolla 1.0 cm long. Known only from a single collection on limestone,
from Langkawi | <i>Gymnostachyum robinsonii</i> | |
| 7. Calyx lobes 4 | | 8 |
| Calyx lobes 5 | | 10 |
| 8. Plant erect, a sub-shrub 30-90 cm tall | | 9 |
| Plant decumbent, usually much smaller | <i>Rostellaria procumbens</i> | |
| 9. Plant spiny, flowers yellow | <i>Barleria prionitis</i> | |
| Plant not spiny, flowers blue | <i>Barleria siamensis</i> var. <i>glabrescens</i> | |
| 10. Anther-cells of a stamen inserted at equal level | | 11 |
| Anther-cells of a stamen inserted at a distinctly unequal level | | 12 |
| 11. Plant small, 15-45 cm tall; frequently unbranched | | |
| | <i>Pseuderanthemum crenulatum</i> | |
| Plant larger, 100-200 cm tall; branched | | |
| | <i>Pseuderanthemum graciliflorum</i> | |
| 12. One or both cells of a same anther with a basal spur | | 13 |
| None of the cells of a same anther with a basal spur | | 17 |
| 13. Capsules small, about 0.3 cm long. Bracts in pairs, bracteoles 2.
Plant small, about 20 cm tall. Very rare, known only from Langkawi
..... | <i>Rungia minutiflora</i> | |
| Capsules larger. Bracts usually single, bracteoles often absent. Plant
frequently larger | | 14 |

Aporuella sumatrensis Cl. var. **ridley** Cl., J. As. Soc. Beng. 74:628. 1907; Ridl., Fl. 2:564. 1923; Henders., J. Mal. Br. R. As. Soc. 17:62. 1939.

Herb, leaves at the base of plant, oblong-obovate, about 12 by 3–4 cm. Flowers white, spaced out on long-penduncled spikes.

This variety is endemic to Gua Batu in Selangor where it is not uncommon growing in small populations under shade. The species is known from Sumatra.

Barleria prionitis L., Sp. Pl. (1753) 636; Clarke, J. As. Soc. Beng. 74: 628. 1907; Ridl., Fl. 2:587. 1923; Henders., J. Mal. Br. R. As. Soc. 17:62. 1939.

Barleria siamensis Craib., Kew Bull. (1911) 437. var. *glabrescens* Ridl., Fl. 2:588. 1923; Henders., J. Mal. Br. R. As. Soc. 17:62. 1939.

Herb 30 cm tall. Leaves elliptic, 9 by 3–4 cm. Flowers few, terminal in a pair of large bracts, 2.4 by 1.5 cm.

This variety is endemic to the limestone at near sea level in Dayang Bunting, Langkawi. The species is known from Thailand at 700–1000 m altitude.

Dicliptera rosea Ridl., J. Str. Br. R. As. Soc. 59:154. 1911, Fl., 2:608. 1923; Henders., J. Mal. Br. R. As. Soc. 17:62. 1939.

Sub-shrub 30 cm tall. Stems angular. Leaves lanceolate or ovate, 3–8 by 2–4 cm. Spikes terminal.

Endemic to limestone in the North of Malaya, not common.

Gymnostachyum decurrens Stapf., Kew Bull. (1894) 357; Ridl., Fl. 2:579. 1923; Henders., J. Mal. Br. R. As. Soc. 17:62. 1939.

Endemic. Fairly common on limestone in shade.

Gymnostachyum diversifolium Clarke, J. As. Soc. Beng. 74:628. 1907; Ridl., Fl. 2:579. 1923; Henders., J. Mal. Br. R. As. Soc. 17:63. 1939.

Endemic. Uncommon, recorded from limestone in Lawgkawi.

Gymnostachyum robinsonii Ridl., J. Str. Br. As. Soc. 86:305. 1921, Fl. 2:579. 1923; Henders., J. Mal. Br. R. As. Soc. 17:63. 1939.

Stem short creeping, ascending to 8 cm. Leaves elliptic-ovate; base broad, abruptly decurrent, to 6 by 4 cm. Raceme to 7 cm. long.

Endemic and known only from the limestone at Dayang Bunting, Langkawi and apparently from only a single collection.

Three species of *Gymnostachyum*, *G. decurrens*, *G. diversifolium* and *G. robinsonii* are known from the limestone in Malaya. (out of a total of 13 species for the country, fide Ridley, l.c.). They are very similar and have been kept distinct chiefly on the size of flowers. On herbarium sheets I have not been able to spot any stable differences between *G. decurrens* and *G. diversifolium*, and although I have not seen the type material (and the only collection) of *G. robinsonii*, the type description could easily apply to either of the other two species. Ridley himself (Flora l.c.) on writing about *G. robinsonii* states that, 'this resembles *G. diversifolium*, but the flowers are only half as big.' Sic.

All three are from similar ecological habitats and collections are scarce; further collections, field observations and study are required to clarify the position of what now are three distinct species. I suspect that what we have here is a variable species or at the most variation at a sub-species level. Presently, I have arbitrarily separated the three on length of corolla tube.

Hemigraphis ridleyi Clarke, J. As. Soc. Beng., 74:652. 1907; Ridl., Fl. 2:259. 1923; Henders., J. Mal. Br. As. Soc. 17:63. 1939.

Hygrophila angustifolia R. Br., Prodr. (1810) 479; Clarke, J. As. Soc. Beng. 74:628. 1907; Ridl., Fl. 2:566. 1923.

Justicia

Twelve species of this genus have been recorded from limestone; of these 5 are rare endemics restricted to limestone, *J. hirticarpa*, *J. microcarpa*, *J. robinsonii*, *J. rupestris* and *J. subalterns*, and are known from only a single collection each. *J. valida* is known from only two collections, both from limestone, one from Kedah and the other from just across the border in Peninsular Thailand. Of the other six, only *J. uber* and *J. ptychostoma* are reasonably common plants. The rest, *J. henicophylla*, *J. pectinella*, *J. subcymosa* and *J. vasculosa* are by no means common.

The only accounts of this genus are in Ridley (Flora 2:593-602), and Clarke (J. As. Soc. Beng. 74:680-689) and I have retained their species; however I do not find it possible to construct a reasonable key to these 12 species based on the material available to me.

I have placed them in three artificial groups (ref. key.) for my present purpose and suggest that much more material are needed for study. Judging from the type descriptions of both Ridley and Clarke, especially of the species restricted to limestone, and of the very limited herbarium material available, a thorough study of these assorted species of the genus (and very probably also the other species) will likely lead to major changes in the taxonomy of the species as presently understood.

Justicia henicophylla Clarke, J. As. Soc. Beng. 74:685. 1907; Ridl., Fl. 2:601. 1923; Henders., J. Mal. Br. R. As. Soc. 17:63. 1939.

Shrub 40-130 cm. tall. Leaves 10-20 by 3-9 cm. elliptic. Flowers in axillary cymes.

Endemic to Malaya, found in Perak and Pahang, not a common plant, often on limestone.

Justicia microcrapa Ridl., J. Str. Br. R. As. Soc. 86:306. 1922, Fl. 2:599. 1923; Henders., J. Mal. Br. R. As. Soc. 17:63. 1939.

Slender herb, glabrous. Leaves lanceolate-ovate to 15 by 5 cm. Flowers in axillary and terminal racemes.

Endemic, collected only by Ridley (l.c.) from 'thickets at the base of limestone cliffs, Selangor, Batu Caves. (Gua Batu). Not seen again. I have not seen these collections.

Justicia pectinella Ridl., J. Str. Br. R. As. Soc. 61:34. 1912, Fl. 2:598. 1923; Henders., J. Mal. Br. R. As. Soc. 17:63. 1939.

Endemic Recorded several times from limestone.

Justicia ptychostoma Nees, in Wall., Pl. As. Rar. 3:108. 1832; Clarke, J. As. Soc. Beng. 74:682. 1907; Ridl., Fl. 2:594. 1923; Henders., J. Mal. Br. R. As. Soc. 17:63. 1939.

Endemic. Common in the north, sometimes on limestone.

Justicia robinsonii Ridl., J. Str. Br. R. As. Soc. 86:305. 1922, Fl. 2:597. 1923; Henders., J. Mal. Br. R. As. Soc. 17:63. 1939.

Shrubby. Leaves chartaceous, lanceolate-elliptic, 15–25 by 5–8 cm. Flowers in terminal racemes.

Endemic and known only from limestone at Dayang Bunting, Langkawi, Kedah.

Justicia rupestris Ridl., J. Str. Br. R. As. Soc. 59:153. 1911, Fl. 2:595. 1923; Henders., J. Mal. Br. R. As. Soc. 17:63. 1939.

Herb or sub-shrub, 30–50 cm. tall. Leaves lanceolate-elliptic, about 12 by 2–3 cm. Flowers in terminal spikes. Capsule 1 cm. long, pubescent.

Endemic and known from only a single number (Ridley 15051 from Bukit Lagi limestone, Perlis).

Justicia subalternans Clarke, J. As. Soc. Beng. 74:685. 1907; Ridl., Fl. 2:601. 1923; Henders., J. Mal. Br. R. As. Soc. 17:63. 1939.

Shrub 50–150 cm. tall. Leaves in pairs, one of a pair reduced or often wanting; larger one to 10 by 3 cm. Flowers in short axillary cymes.

A rare endemic known from only a single number (King's collector, 7061, Kinta, Perak, on limestone).

Justicia subcymosa Clarke, J. As. Soc. Beng. 74:683. 1907; Ridl., Fl. 2:596. 1923; Henders., J. Mal. Br. R. As. Soc. 17:63. 1939.

Endemic. Not common but with several limestone records.

Justicia uber Clarke, J. As. Soc. Beng. 74:688. 1907; Ridl., Fl. 2:599. 1923; Henders., J. Mal. Br. R. As. Soc. 17:63. 1939.

Shrub 100–150 cm. Leaves elliptic, 10–20 by 5–10 cm. Flowers in terminal or axillary spikes.

Endemic to Malaya, a common plant of lowland forest. Recorded a number of times from limestone.

Justicia valida Ridl., J. Str. Br. R. As. Soc. 59:152. 1911, Fl. 2:599. 1923; Henders., J. Mal. Br. R. As. Soc. 17:63. 1939.

Shrublet about 60 cm. tall. Leaves elliptic-lanceolate, to 18 by 8 cm. Flowers in whorls on an inflorescence 15–25 cm. long.

Very rare, restricted to limestone and known from only two records; one from Gunung Keriang, Kedah (Ridley 15049) and the other from just across the border in Thailand.

Justicia vasculosa Wall., Cat. (1830) 2469; Clarke, J. As. Soc. Beng. 74:687. 1907; Ridl., Fl. 2:598. 1923; Henders., J. Mal. Br. R. As. Soc. 17:63. 1939.

Polytrema cupreum Ridl., J.R. As. Soc. S. Br. 50:124. 1908, Fl. 2:607. 1923; Henders., J. Mal. Br. R. As. Soc. 17:63. 1939.

Small creeping plant. Leaves elliptic, rounded or ovate, about 1–2.5 cm. long and as wide. Flowers 3–4 on a short terminal cyme.

Endemic and most probably restricted to limestone. Known from only two collections from near Ipoh.

Polytrema vulgare Clarke, J. As. Soc. Beng. 74:628. 1907; Ridl., Fl. 2:606. 1923; Henders., J. Mal. Br. R. As. Soc. 17:63. 1939.

Pseuderanthemum crenulatum Radlk., Sitzb. Math-Phys. Akad. Wiss. Muench. 8:282; Ridl., Fl. 2:589. 1923; Henders., J. Mal. Br. R. As. Soc.

Eranthemum crenulatum Nees, in Wall., Pl. As. Rar. 3:107. 1832.

Pseuderanthemum graciliflorum (Nees in wall.) Ridl., Fl. 2:591. 1923; Henders., J. Mal. Br. R. As. Soc. 17:64. 1939.

E. malaccense Clarke, in Hk.f., F.B.I. 4:498. 1883.

Rostellaria procumbens Nees, in Wall., Pl. As. Rar. 3:101. 1832; Ridl., Fl. 2:602. 1923; Henders., J. Mal. Br. R. As. Soc. 17:64. 1939.

Justicia procumbens L., Sp. Pl. (1753) 15; Clarke, in Hk.f., F.B.I. 4:539. 1883.

Ruellia repens L., Mant. (1767) 89; Clarke in Hk.f., F.B.I. 4:412. 1883; Ridl., Fl. 2:564. 1923.

Rungia minutiflora Clarke, J. As. Soc. Beng. 74:698. 1907; Ridl., Fl. 2:602; 1923. Henders., J. Mal. Br. R. As. Soc. 17:64. 1939.

Small plant 15–25 cm. tall. Leaves ovate-lanceolate or ovate. Flowers in terminal spikes 2.5 cm. long.

Endemic to limestone in Malaya and known from only two collections made in Langkawi.

Stenothyrsus ridleyi Clarke, J. As. Soc. Beng. 74:651. 1907; Ridl., Fl. 2:568. 1923; Henders., J. Mal. Br. R. As. Soc. 17:64. 1939.

Herb, glabrous. Leaves to 10 by 4 cm, petioles about 2.5 cm. long. Flowers in a terminal spike to 15 cm. long; peduncle 15 cm. long.

Endemic to limestone and recorded several times from near Ipoh, Perak.

Strobilanthes leucopogon Ridl., J. Str. Br. R. As. Soc. 86:304. 1922; Fl. 2:575. 1923; Henders., J. Mal. Br. R. As. Soc. 17:64. 1939.

Endemic, only from Langkawi, rare.

Strobilanthes pachyphyllus Clarke, J. As. Soc. Beng. 74:658. 1907; Ridl., Fl. 2:575. 1923; Henders., J. Mal. Br. R. As. Soc. 17:64. 1939.

Shrub about 120 cm tall. Leaves elliptic to obovate, to 12 by 5 cm. Flowers in a terminal panicle, branches short, about 0.5 cm long.

Endemic and known only from Gunong Mesah, Kinta, Perak, from a collection by Kunstler. Not recorded again.

Thunbergia fragrans Rexb. var. **javanic** K. & G., in Ridl., Fl. 2:557. 1923; Back., Fl. Java 2:552. 1965.

Excluded species

Justicia hirticarpa J.B. Imlay, in Henders., J. Mal. Br. R. Soc. 17:63. 1939.

One sheet (Henderson 29176) in Singapore from Kisap, Langkawi, has been annotated by J.B. Imlay as "*Justicia hirticarpa* sp. nov." As far as I know this species has never been validly published and is only mentioned by Henderson, in l.c. Henderson also noted another specimen from Kuah, Langkawi which I have not seen, (Curtis 2117). These are the only two records of this species.

AMARANTHACEAE

1. Leaves opposite. Flowers in smaller clusters on short stalks, on the axis of racemes; stiff recurved spines present with the flowers *Cyathula prostrata*
Leaves alternate. Flowers singly, sessile, sub-sessile or pedicelled, on the axis of racemes; no spines 2
2. Flowers sessile or sub-sessile, spikes (racemes), 3-12 cm long, usually simple, rarely branched; ripe berry, white. Not uncommon, widely distributed *Deeringia polysperma*
Flowers on 0.6-2 mm long pedicels, racemes more than 15 cm long, those on the upper part of stem usually in a panicle; ripe berry, bright red. Rare, only recorded once from limestone; in Perak *Deeringia amaranthoides*

Cyathula prostrata (L.) Bl., Bijdr. :549. 1825; Hk. f., F.B.I. 4:723. 1885; Ridl., Fl. 3:7. 1924; Back., Fl. Mal. I, 4:82. 1949.

Deeringia polysperma (Roxb.) Moq., in DC. Prod. 13(2):236. 1849; Back., Fl. Mal. I, 4:47. 1949.

D. indica Zoll. ex Moq., in DC. Prod. 13(2):236. 1849; Ridl., Fl. 3:5. 1924.

Herb or sub-shrub 1–2 m tall, young parts finely pubescent. Leaves ovate or elliptic, 3–22 by 1.5–12 cm. Flowers in spikes which are usually unbranched, 3–12 cm long. Fruits ripen white, a berry with numerous seeds.

Distributed in Malesia, in Malaya not uncommon, usually on limestone, often at cliff bases; also recorded from granite rocks, and normally found in partially shaded situations.

Deeringia amaranthoides (Lamk.) Merr., Interpr. Herb. Amb. (1917) 211.

D. celosioides R. Br., Hk. f., F.B.I. 4:714. 1885; Ridl., Fl. 3:4 1924.

ANACARDIACEAE

1. A climber *Rhus perakensis*
Trees 2
2. Leaves simple 3
Leaves pinnate 6
3. Lower surface of leaves glabrous, sometimes puberulous on the midrib 4
Lower surface of leaves pubescent 5
4. Leaves with a pronounced tip; petioles very short or to 1 cm. long
..... *Buchanania sessilifolia*
Leaves with on pronounced tip, stiff coriaceous; petioles 1.3–9 cm
..... *Mangifera* sp.
5. Leaves obovate, rusty red pubescent below *Semecarpus glomerulata*
Leaves oblanceolate, yellowish pubescent below
..... *Semecarpus cochinchinensis*
6. Leaflets small, 2–4 by 0.8–1.7 cm; tip retuse, mucronulate
..... *Pistacia malayana*
Leaflets larger, 4–17 by 1.5–7 cm; tip obtuse, acute or acuminate 7
7. Fruits 4-winged *Parishia rosea*
Fruits not winged, a drupe 8
8. Leaves glabrescent beneath with tufts of hairs in the axils of nerves
..... *Pentaspedon curtisii*
Leaves glabrous beneath 9
9. Leaflets 2–8 pairs, entire; fruits 2.5–4.5 cm long; twigs and rachises rather tough *Spondias pinnata*
Leaflets 4–12 pairs, finely serrated; fruits 5–10 cm long; twigs and rachises succulent and brittle *Spondias dulcis*

Buchanania sessilifolia Bl., Mus. Bot. Lugd. Bat. 1:184. 1850; Ridl., Fl. 1:519. 1922; Koch. & Wyatt-Smith Mal. For. Rec. 17:213. 1964.

B. acuminata Turcz., Bull. Soc. Nat. Mosc. 1:472. 1858.

Mangifera sp.

What appears to be one species of this genus has been collected from several hills. It is not uncommon on Gua Batu, Selangor and Gunong Pondok, Perak, growing on the summit in pockets of soil to a fair size tree, 7–12 m tall and with a diameter of about 40 cm near the base. All specimens seen are however sterile. On Gunong Pondok, at least, this species is effectively regenerating itself as there are numerous saplings around the summit area where matured trees of this species are common.

Parishia rosea Ridl., J. Str. Br. R. As. Soc. 59:90. 1911, Fl. 1:536. 1922; Henders., J. Mal. Br. R. As. Soc. 17:42. 1939.

Tree to 20 m. Leaves 35 cm or more long; pinnate, leaflets thin coriaceous, ovate or oblong-ovate, base rounded, slightly cordate; usually about 10 by 6 cm. Panicles from the upper axils, about 45 cm long, flowers sessile, pink; sepals 4, enlarging and wing-like in fruit.

Distributed in Peninsular Thailand. In Malaya recorded only from Langkawi; apparently common and probably restricted to limestone.

Pentaspadon curtisii (King) Corner, Gard. Bull. S.S. 10:262. 1939; Henders., J. Mal. Br. R. As. Soc. 17:42. 1939.

Microstemon curtisii King, in Ridl., Fl. 1:537. 1922.

Tree, medium sized. Leaves 10–17 cm long, pinnate, rachis, puberulous. Leaflets membranous, oblong-lanceolate; base round, oblique; 4–7.5 by 1.7–2.3 cm. Panicles axillary on the upper leaves; flowers small, solitary or 2–4 together. Fruits unknown.

Distributed in Peninsular Thailand. In Malaya known only from one collection; Langkawi, on limestone.

Pistacia malayana Henders., Gard. Bull. S.S. 7:97. 1933, J. Mal. Br. R. As. Soc. 17:42. 1939.

Small tree 4–8 m. Leaves 7–12 cm long, pinnate, rachis narrowly winged. Leaflets oblong, oblong-elliptic or oblong-ovate, glabrous, 4–8 pairs, opposite, subopposite or alternate, sessile or subsessile, 2–4 by 0.8–1.7 cm; base narrowed, apex retuse, mucronulate. Inflorescence, a panicle 4–7 cm long; flowers unisexual; perianth in 2 whorls, 3 or 4 lobes in each whorl; male flowers with 5 stamens, style unequally 2–3 lobed at the tip; in the female the style is 3-partite almost to the base. Fruit ovoid globose about 0.4 cm across.

Endemic and restricted to limestone. Recorded from Perak, Pahang and Selangor; seen on Kelantan limestone. Very common on Bukit Takun, Selangor.

Rhus perakensis Scort., in King, J. As. Soc. Beng. 65:500. 1896; Ridl., Fl. 1:538. 1922.

Endemic, recorded in Perak and Langkawi. Uncommon.

Semecarpus glomerulata Ridl., J. Str. Br. R. As. Soc. 54:39. 1910, Fl. 1:542. 1922; Henders., J. Mal. Br. R. As. Soc. 17:42. 1939.

Medium-sized tree. Leaves simple, obovate, base narrowed, rusty pubescent below, 10–20 by 6–12 cm. Panicles 15–30 cm long, flowers in clusters. Fruit small, a drupe, 0.4 cm across.

Distributed in Peninsular Thailand. In Malaya recorded from Perlis and Kedah, rare, and according to Henderson in l.c. from limestone in Langkawi.

Spondias dulcis Forst. f., Prodr. (1786) 34; Craib, Fl. Siam 1:355. 1926. *S. cytherea* Sonn., in Corner, Way. Trees 1:115. 1952.

Spondias pinnata Kurz., in Pegu Rep. A. (1875) 44; Craib, Fl. Siam 1:356. 1926; Henders., J. Mal. Br. R. As. Soc. 17:43. 1939; Corner, Way. Trees 1:116. 1952.

Dubious record

Semecarpus cochinchinensis Engl., in DC., Mon. Phan. 4:489. 1883; Ridl., Fl. 1:542. 1922; Craib, Fl. Siam 1:353. 1926; Henders., J. Mal. Br. R. As. Soc. 17:43. 1939.

ANNONACEAE

1. Climbing or scrambling shrubs 2
Erect shrubs or trees 8
2. Plant with hooks from modified peduncles; leaves coriaceous, glabrous
..... *Artabotrys grandifolius*
Plant with no hooks 3
3. Young twigs and usually the undersurface of leaves with stellate tomentum (lens!) 4
Young twigs and leaves if pubescent, not with stellate tomentum 5
4. Pubescence woolly (floccose) and easily rubbed off; stamens 0.2 cm long. Fruits tomentose and tuberculate *Uvaria javana*
Pubescence not woolly; stamens about 0.7 cm long. Fruits glabrous and not tuberculate *Uvaria cordata*
5. Petals distinctly clawed equal or sub-equal. Lower surface of leaves usually slightly glaucous 6
Petals not clawed inner whorl much smaller. Lower surface of leaves not glaucous; usually with a golden shiny tint *Oxymitra bigandulosa*
6. Leaves densely pubescent, glaucous-purple beneath; flowers with 3–4 petals in one whorl *Desmos dasymachalus*
Leaves glabrous or only pubescent on the veins; flowers with 6 petals in 2 whorls 7

7. Veins of leaves very fine and faint on both surfaces *Desmos dunalii*
 Veins of leaves raised and prominent on the lower surface
 *Desmos cochinchinesis*
8. Sepals imbricate. Petals 2-seriate, one or both series imbricate in bud.
 Midrib impressed above 9
 Sepals and petals all valvate in bud. Midrib impressed or raised 12
9. Young twigs and often the midrib rusty pubescent 10
 Young twigs and leaves all glabrous 11
10. Leaves 15–22 by 4.5–8 cm. Flowers extra-axillary on leafy twigs
 *Trivalvaria macrophylla*
 Leaves 30–40 by 12–18 cm. Flowers on woody cymes from the lower part
 of trunk *Enicosanthum congregatum*
11. Midrib raised on the upper surface; leaves somewhat bullate. Flowers on
 trunk *Stelechocarpus cauliflorus*
 Midrib impressed on the upper surface; leaves not bullate, margin recurved.
 Flowers on twigs *Sagera elliptica*
12. Petals all equal or sub-equal 13
 Petals unequal, usually one whorl smaller 26
13. Flowers borne on the trunk and main branches; very rarely on leafless parts
 of twigs 14
 Flowers borne on the leafy parts of twigs 16
14. Leaves large 20–36 by 7.5–14 cm. Flowers on branches 30 cm – 2.5 m long,
 at the base of trunk *Polyalthia hypogaea*
 Leaves smaller 15
15. Leaves 4.5–7 cm wide, base oblique and slightly cordate; pedicels 0.6–0.7 cm
 *Polyalthia stenopetala*
 Leaves narrow 1–3.5 cm wide, base acute or slightly rounded; pedicels 2–4 cm
 long *Polyalthia cauliflora* var. *beccarii*
16. Undersurface of matured leaves pubescent; sometimes only on the midrib and
 nerves 17
 Undersurface of matured leaves glabrous 21
17. Flowers with very short pedicels 0.3–0.5 cm, or sessile 18
 Flowers with pedicels 2–10 cm long 20
18. Petals 1.5–2.5 cm long 19
 Petals 5–9.5 cm long; flowers 1–3 cm on short woody tubercles
 *Polyalthia cinnamomea*
19. Flowers axillary *Meiogyne virgata*
 Flowers extra axillary *Polyalthia motleyana* var. *glabrescens*
20. Petals 3–4, inner whorl absent. Ovary villous. Shrub
 *Desmos dasymachalus*
 Petals 6; Ovary glabrous. Tree (flowers very fragrant) *Cananga odorata*

21. Flowers extra-axillary or sometimes opposite leaves 22
 Flowers axillary 24
22. Pedicels 0.4–0.8 cm long, rarely to 1 cm long 23
 Pedicels more than 1 cm long. Petals 4 cm long. Veins on the lower surface of leaves scalariform *Desmos cochinchinensis*
23. Nerves 8–9 pairs. Leaf bases slightly asymmetrical
 Nerves 15–20 pairs. Leaf bases equal *Polyalthia brunneifolia*
 *Polyalthia motleyana*
24. Sepals about 0.4 cm long 25
 Sepals 0.6–1.5 cm long; ovules 1 in each ovary *Polyalthia rumphii*
25. Pedicels 0.3 cm long. Petals 1.5–2.2 cm long *Xylopia malayana*
 Pedicels 1 cm long. Petals 4–4.5 cm long *Polyalthia lateritia*
26. Inner petals smaller than the outer 27
 Inner petals larger than the outer 32
27. Flowers extra-axillary and opposite the leaves, 1–5 together 28
 Flowers axillary, usually solitary 29
28. Pedicels about 1 cm long, sepals 0.7 cm long. Stamens 0.4 cm long
 *Anaxagorea javanica*
 Pedicels 2 cm long, sepals 0.2–0.3 cm long. Stamens 0.1 cm long
 *Mitrephora maingayi*
29. Leaves 15 or more cm long, nerves usually 15 or more pairs 30
 Leaves 8–11 cm long, nerves 10–12 pairs *Goniothalmus subevenius*
30. Flowers from the axils of fallen leaves on older parts of twigs. Stamen connectives apiculate 31
 Flowers from axils of leaves on leafy parts of twigs. Stamen connectives convex *Goniothalmus fulvus*
31. Sepals 1.8–2.6 by 1.4–2.5 cm, foliaceous. Capsules with 1–2 ovules
 *Goniothalmus scortechinii*
 Sepals 1.2 by 0.7 cm. Carpels with 4–5 ovules *Goniothalmus uvarioides*
32. Base of leaf unequally bilobed *Milium amplexicaulis*
 Base of leaf different 33
33. Petioles short 0.4 cm or less 34
 Petioles 0.5–1 cm, swollen and tomentose *Pseudovaria macrophylla*
34. Under-surface of leaves glabrous 35
 Under-surface of leaves pubescent, sometimes only on the veins 38
35. Leaves large 12–23 cm long. Flowers pendulous on pedicels 2–4 cm long
 *Milium longipes*
 Leaves smaller, less than 12 cm long. Pedicels usually shorter 36
36. Inner petals with claws, usually distinctly vaulted over the reproductive parts 37
 Inner petals with no claws, not vaulted, ovate-oblong *Milium parviflora*

37. Pedicels about 0.3 cm long; outer petals 0.2–0.3 cm long.
 *Orophea polycarpa*
 Pedicels 1–3 cm long; outer petals 1–1.5 cm long. *Orophea enterocarpa*
38. Hairs pale brown, erect, 0.2–0.3 cm long. Flowers unisexual.
 *Pseudovaria setosa*
 Hairs shorter. Flowers bisexual 39
39. Flowers on peduncles 1–2 cm long, axillary or supra axillary 40
 Flowers in fascicles, opposite the leaves. *Popowia velutina*
40. Outer petals about 0.3 cm long; inner petals 0.7 cm long 41
 Outer petals about 1 cm long, inner petals 1.5–2.5 cm long
 *Orophea maculata*
41. Fruit globular, about 1 cm across; leaves 6–8 cm long *Orophea hirsuta*
 Fruit elongate, cylindrical, 3.5–5 by 0.7 cm; leaves 8–18 cm long
 *Orophea cuneiformis*

Anaxagorea javanica Bl., Fl. Jav. Anon. (1930) 66; Corner, Way. Trees 1:129.
 1952; Henderson, J. Mal. Br. R. As. Soc. 17:33. 1939; Sindair, Gard. Bull.
 S. 14:347. 1955; Koch, Tree Fl. Mal. 1:68. 1972.

A. scortechinii King, in Ridl., Fl. 1:62. 1922.

Artabotrys gradifolius King, Mats. 1:31. 1892; Ridl., Fl. 1:39. 1922; Henders.
 J. Mal. Br. R. As. Soc. 17:33. 1939; Sindair, Gard. Bull. S. 14:253. 1955.

Endemic, uncommon in lowland forest; recorded from limestone in Perak.

Cananga odorata (Lamk.) Hk. f. et Th., F.B.I. 1:56. 1872; Sinclair, Gard. Bull.
 S. 14:324. 1955; Koch., Tree Fl. Mal. 1:70. 1972.

Canangium odoratum King, Ridl. Fl. 1:43. 1922; Henders., J. Mal. Br. R.
 As. Soc. 17:33.

Desmos cochinchinensis Lour., Fl. Coch. 1:352. 1790; Ridl., Fl. 1:45. 1922;
 Henders., J. Mal. Br. As. Soc. 17:33. 1939; Sinclair Gard. Bull. S. 14:264.
 1955.

Desmos dasymaschalus (Bl.) Saff. var. *wallichii* (Hk.f. et Th.) Ridl., Fl. 1:47.
 1922; Sinclair, Gard. Bull. S. 14:370. 1955.

Desmos dunalii (Hk.f. et Th.) Saff., Bull. Tor. Bot. Club 39:506. 1912; Henders.,
 J. Mal. Br. R. As. Soc. 17:263. 1939; Sindair, Gard. Bull. S. 14:263. 1955.

Enicosanthum congregatum (King) Airy-Shaw, Kew. Bull. (1939) 277; Sinclair,
 Gard. Bull. S. 14:194. 1955.

Polyalthia congregata King., in Ridl., Fl. 1:60. 1922; Henders., J. Mal. Br.
 R. As. Soc. 17:34. 1939.

Endemic with limestone records from Gua Batu, Selangor.

Goniothalamus fulvus Hk. f. et Th., F.B.I. 1:75. 1872; Ridl., Fl. 1:68. 1922; Sinclair, Gard. Bull. S. 14:428. 1955.

— 15 —

Endemic, not common in lowland forest; recorded twice from limestone.

Goniothalamus scortechinii King, Mats. 1:77. 1892; Ridl., Fl. 1:67. 1922; Sinclair, Gard. Bull. S. 14:441. 1955.

Goniothalamus subevenius King, Mats. 1:71. 1892; Ridl., Fl. 1:64. 1922; Henders., J. Mal. Br. R. As. Soc. 17:33. 1939; Sinclair, Gard. Bull. S. 14:427. 1955.

Shrub or small tree. Leaves glabrous narrowly oblong, nerves 10–20 pairs, reticulations faint on both surfaces. Flowers solitary, axillary. Pedicels 1–1.3 cm long, sepals 0.5–0.7 cm long broadly ovate; petals, outer lanceolate, 1.8–2.3 cm long, the inner half as long.

Distributed in Thailand. In Malaya known only from Kuala Dipang and Gopeng, Perak, most probably only on limestone. Three times collected.

Goniothalamus unvarioides King, Mats. 1:78. 1892; Ridl., Fl. 1:68. 1922; Sinclair, Gard. Bull. S. 14:442. 1955.

Meiogyne virgata (Bl.) Miq., Ann. Mus. Bot. Lugd. Bat. 2:12. 1865; Sinclair, Gard. Bull. S. 14:277. 1955.

Cyathocalyx virgatus King, in Ridl., Fl. 1:36 1922; Henders., J. Mal. Br. R. As. Soc. 17:33. 1939.

Milium amplexicaulis Ridl., J. Str. Br. R. As. Soc. 54:13. 1910, Fl. 1:97 1922 (excluding *Polyalthia subcordata* Bl., Fl. Jav. Anon. (1830) 71); Sinclair, Gard. Bull. S. 14:380. 1955.

Small tree or shrub. Leaves with a 0.3 cm petiole, elliptic-ovate, base unequal cordate, glabrous above and glabrescent on the nerves below, 11–20 by 5–9 cm. Flowers axillary, usually solitary, sometimes 2–3. Sepals and outer petals similar, margin ciliate, 0.1–0.15 cm long; inner petals 0.3–0.5 cm long, ovate.

Endemic, confined to Kedah, Perak and Kelantan; uncommon, and frequently from limestone. Chin 900 which apparently is this species, has pedicels to 2.5 cm, instead of from 1–1.3 cm long.

Milium longipes King, Mats. 1:125. 1892; Ridl., Fl. 1:96. 1922; Henders., J. Mal. Br. R. As. Soc. 17:33. 1939; Sinclair, Gard. Bull. S. 14:379. 1955.

Milium parviflora Ridl. in Fl. 1:97. 1922; Henders., J. Mal. Br. R. As. Soc. 17:34. 1939; Sinclair, Gard. Bull. S. 14:380. 1955.

Small tree. Leaves elliptic-lanceolate, glabrous, 5–9 by 1.8–3.5 cm. Flowers axillary, solitary or in pairs. Sepals and outer petals similar, about 0.1 cm long. Inner petals 0.4–0.5 cm long. Ripe carpels 0.7–1.8 cm long, slightly apiculate.

Endemic and restricted to limestone; collected from Perlis and Kedah only.

Mitrephora maingayi Hk. f. et Th., F.B.I. 1:77. 1872; Ridl., Fl. 1:73. 1922; Henders., J. Mal. Br. R. As. Soc. 17:34. 1939; Sinclair, Gard. Bull. S. 14:464. 1955.

Endemic; a common species in lowland forest. Recorded from limestone once only.

Orophea cuneiformis King, Mats. 1:84. 1892; Ridl., Fl. 1:72. 1922; Henders., J. Mal. Br. R. As. Soc. 17:34. 1939; Sinclair, Gard. Bull. S. 14:394. 1955.

Shrub or tree 7–13 m tall. Leaves elliptic-oblongate, base slightly unequal sided, 8–18 by 4–5.5 cm. Peduncles 4–5 flowered, supra-axillary or axillary. Flower buds globose. Sepals ovate 0.2 cm long, outer petals 0.3 cm long, inner petals 0.7 cm long. Ripe carpels cylindrical, 3.5–5 by 0.7 cm.

Distributed in Peninsular Thailand. In Malaya only recorded from Perak. This species is apparently restricted to limestone.

Orophea enterocarpa Manigayi ex Hk.f. et Th., F.B.I. 1:92. 1872; Ridl., Fl. 1:70. 1922; Henders., J. Mal. Br. R. As. Soc. 17:34. 1939; Sinclair, Gard. Bull. S. 14:392. 1955.

Orophea hirsuta King, Mats. 1:81. 1892; Ridl., Fl. 1:70. 1922; Henders., J. Mal. Br. R. As. Soc. 17:34. 1939; Sinclair, Gard. Bull. S. 14:395. 1955.

Shrub, 3–4 m tall. Young twigs with erect rusty-brown 0.1 cm long hairs. Leaves elliptic, rusty-hirsute on the margins and on the lower surface 6–8 by 2.8–3.8 cm. Peduncles supra-axillary or axillary, 1–3 flowered, about 1 cm long. Pedicels 0.4–0.5 cm long, flowers with broadly ovate sepals, 0.1 cm long, outer petals 0.3 cm long, inner petals 0.7 cm long, thick. Matured carpels 4–5, about 1 cm across.

Endemic and restricted to limestone. Recorded from Kedah, Perlis, Perak and Kelantan, not common.

Orophea maculata King, Mats. 1:82. 1892; Ridl., Fl. 1:71. 1922; Henders., J. Mal. Br. R. As. Soc. 17:34. 1939; Sinclair, Gard. Bull. S. 14:393. 1955.

Shrub 3–7 m. Leaves elliptic-oblongate, base slightly unequal sided, 8–18 by 4–5.5 cm. Peduncles supra-axillary, sometimes axillary, 2–3 flowered, 1.5 cm long. Calyx and corolla segments all membranous and pubescent on both surfaces. Sepals linear 0.2–0.3 cm long; outer petals 1 cm long; inner petals 1.5–2.5 cm long. Carpels elongate-cylindrical, moniliform, 7–13 by 0.4 cm.

Endemic, recorded from Perak, Pahang and Selangor, usually but not exclusively from limestone.

Orophea polycarpa A. DC., Mem. Anon. (1832) 39; Sinclair, Gard. Bull. S. 14:395. 1955.

O. gracilis King, in Ridl., Fl. 1:71. 1922; Henders., J. Mal. Br. R. As. Soc. 17:34. 1939.

Slender tree 7–10 m tall. Leaves glabrous, lanceolate, 5–10 by 2–3.5 cm. Peduncles, supra-axillary or axillary, 2–6 cm long, with 1–2 flowers. Sepals broadly ovate 0.1 cm long, outer petals 0.2–0.3 cm long, inner petals 0.4–0.5 cm long, slightly vaulted. Ripe carpels globose, 1–1.3 cm across.

Distributed in Thailand, Burma and Indo-China. In Malaya and probably elsewhere too, restricted to limestone. Recorded from Perlis, Perak, Pahang and Kelantan.

Oxymitra biglandulosa (Bl.) Scheff., Nat. Tijdschr. Ned. Ind. 31:341. 1870; Ridl., Fl. 1:81. 1922; Henders., J. Mal. Br. R. As. Soc. 17:34. 1939; Sinclair, Gard. Bull. S. 14:459. 1955.

Polyalthia brunneifolia Sinclair, Gard. Bull. S. 14:301. 1955.

Endemic to Malaya, found in lowland forest; not uncommon on the limestone in Selangor, Kelantan and Pahang.

Polyalthia cauliflora Hk.f. et Th. var. *beccarii* (King) Sinclair, Gard. Bull. S. 14:294. 1955.

Polyalthia cinnamomea Hk.f. et Th., Fl. Ind. 1:138. 1855; Ridl., Fl. 1:51. 1922; Sinclair, Gard. Bull. 1:286. 1955; Koch., Tree Fl. 1:87. 1972.

Polyalthia hypogaea King, Mats. 1:62. 1892; Ridl., Fl. 1:61. 1922; Sinclair, Gard. Bull. S. 14:315. 1955; Koch., Tree Fl. Mal. 1:87. 1972.

Endemic, not very common, in the lowlands and hills. Once recorded from limestone. (Gunong Lanoh, Perak. Mills & Henderson 15075)

Polyalthia lateritia Sinclair, Gard. Bull. 14:290. 1955.

Also from Southern Thailand, seldom collected; recorded from limestone on Gunong Pondok, Perak.

Polyalthia motleyana (Hk.f.) Airy-Shaw in Kew. Bull. (1939) 280; Sinclair, Gard. Bull. S. 14:303. 1955.

var. *glabrescens* Airy-Shaw, Kew Bull. (1939) 282; Sinclair, Gard. Bull. S. 14:305. 1955.

P. oblonga King, in Ridl., Fl. 1:57. 1922; Henders., J. Mal. Br. R. As. Soc. 17:34. 1939.

Polyalthia rumphii (Bl.) Merr. Enum. Philip. Fl. Plants 2:162. 1923; Sinclair, Gard. Bull. S. 14:306. 1955.

P. scortechinii King, in Ridl., Fl. 1:56. 1955.

Polyalthia stenopetala (Hk.f. et Th.) Ridl., J. Str. Br. As. Soc. 75:6. 1917, Fl. 1:50. 1922 including *P. crinita* (Hk.f. et Th.) Ridl., l.c.; Sinclair, Gard. Bull. S. 14:285. 1955.

Popowia velutina King, Mats. 1:94. 1892; Ridl., Fl. 1:77. 1922; Henders., J. Mal. Br. R. As. Soc. 17:34. 1939; Sinclair, Gard. Bull. S. 14:472. 1955.

Shrub or tree 5–15 m tall. Leaves oval-oblong, base rounded, slightly unequal-sided, nerves 6–7 pairs; pubescent beneath, 7–9 by 3.5–5 cm. Flowers extra-axillary in fascicles. Sepals ovate, 0.2 cm long. Petals cream coloured, outer 0.2–0.3 cm, inner 0.3–0.4 cm long. Ripe carpels 1–4, globose-falcate, 1.5–2 cm long.

Endemic and known from two numbers only, both of which are from Gopeng, Perak.

Pseuduvaria macrophylla (Oliv.) Merr., Philip. J. Sc. Bot. 10:225. 1915; Sinclair, Gard. Bull. S. 14:408. 1955.

Mitrephora macrophylla Oliv, in Hk. Icon. (1887) 16; Ridl., Fl. 1:74. 1922, Henders., J. Mal. Br. R. As. Soc. 17:34. 1939.

Pseuduvaria setosa (King) Sinclair, Gard. Bull. S. 14:43, 405. 1955.

Orophea setosa King, in Ridl., Fl. 1:70. 1922; Henders., J. Mal. Br. R. As. Soc. 17:34. 1939.

Sageræa elliptica (A. DC.) Hk.f. et Th., Fl. Ind. 1:93. 1855; Ridl., Fl. 1:25. 1922; Sinclair, Gard. Bull. 14:181. 1955.

Stelechocarpus cauliflorus (Scheff.) R.E. Fr., Arkiv for Botanik, Band 3:42. 1953; Sinclair, Gard. Bull. S. 14:183. 1955.

S. nitidus King, in Ridl., Fl. 1:24. 1922; Henders., J. Mal. Br. R. As. Soc. 17:35. 1939.

Trivalvaria macrophylla (Bl.) Miq., Ann. Mus. Bot. Lugd. Bat. 2:19. 1865; Sinclair, Gard. Bull. S. 14:196. 1955.

Popowia nervifolia Main. ex Hk.f., in Ridl., Fl. 1:77. 1922; Henders., J. Mal. Br. R. As. Soc. 17:34. 1939.

Trivalvaria macrophylla (Bl.) Miq., Ann. Mus. Bot. Lugd. Bat. 2:19. 1865; Sinclair, Gard. Bull. S. 14:196. 1955.

Popowia nervifolia Main. ex Hk. f., in Ridl., Fl. 1:77. 1922; Henders., J. Mal. Br. R. As. Soc. 17:34. 1939.

Uvaria cordata (Dun.) Alston, Hand-Bk. Fl. Ceylon 6:4. 1931; Sinclair, Gard. Bull. S. 14:207. 1955.

U. macrophylla Roxb. in Ridl., Fl. 1:30. 1922; Henders., J. Mal. Br. R. As. Soc. 17:35. 1939.

Uvaria javana Dunal, Anon. (1817) 91; Sinclair, Gard. Bull. S. 14:216. 1955.

U. dulcis sensu Auctt. non Dunal, in Ridl., Fl. 1:30. 1922; Henders., J. Mal. Br. R. As. Soc. 17:35. 1939.

Xylopia malayana Hk.f. et Th., Fl. Ind. (1855) 125. Ridl., Fl. 1:91. 1922; Sinclair, Gard. Bull. Sing. 14:340. 1955.

X. dicarpa Hk.f. et Th. in Henders., J. Mal. Br. R. As. Soc. 17:35. 1939.

X. pustulata Hk.f. et Th. in Ridl., Fl. 1:91. 1922.

14. Corolla tube dilated near the top; lobes ovate *Kopsia pauciflora*
 Corolla tube dilated at the mid-portion; lobes obovate ... *Kopsia macrophylla*

Alstonia scholaris (L.) R. Br., Mem. Wern. Soc. 1:76. 1811; Ridl., Fl. 2:346. 1923; Whitmore, Tree Fl. Mal. 2:11. 1974.

ALYXIA Br.

The following key is adapted from Ridley, Fl. 2:332.1923. Material from limestone keys out to 3 different species. However *A. pumila* and *A. angustifolia* are not always distinct, though in the key they fall into one or the other species. The floral characters appear similar, and the leaf character, which in extreme forms are distinct, tend to overlap.

Key.

Leaves glabrous.

Leaves 0.8–1.9 cm wide *Alyxia pumila*

Leaves 0.6 cm wide *Alyxia angustifolia*

Leaves pubescent beneath *Alyxia selangorica*

Alyxia angustifolia Ridl., J. Fed. Mal. St. Mus. 6:161. 1915, Fl. 2:333. 1923.

Endemic, rare, found on rocky slopes from 1000–2000 m and on limestone on Bukit Takun, Selangor. The limestone specimens (Chin 385 & 571) which I tentatively place here have shorter but wider leaves, 1.7–3.2 by 0.3–0.8 cm; not unlike some *A. pumila* specimens.

Alyxia pumila Hk.f., F.B.I. 3:635. 1882; Ridl., Fl. 2:333. 1923.

Endemic, usually at 1000–1300 m. From limestone at low elevation in Kelantan and once (the identification of this specimen (Henderson 19466) is doubtful) from Pahang.

Alyxia selangorica K. & G., Mats. 19:422. 1907; Ridl., Fl. 2:334. 1923.

Very rare; distributed in Sumatra, and once from Malaya, Gua Batu, Selangor. (Ridley 8558).

Ervatamia peduncularis K. et G., Mats. 19:451. 1907; Ridl., Fl. 2:343. 1923; Henders., J. Mal. Br. R. As. Soc. 17:56. 1939.

Not uncommon in lowland forest. According to Henderson in l.c., recorded from limestone in Perlis and Pahang. I have not seen any of these specimens; but only one from the base of limestone. (Bukit Chintamani, Pahang, Stone 6574).

Holarrhena curtisii K. et G., J. As. Soc. Beng. 74.446. 1907; Craib, Fl. Siam. 2:450. 1939; Henders., J. Mal. Br. R. As. Soc. 17:56. 1939.

H. densiflora Ridl., Fl. 2:349. 1923.

H. pulcherrima Ridl., l.c. 349.

In Malaya, only from the extreme north. Sometimes on limestone.

Hunteria zeylanica (Retz.) Gard. ex Thw., Enum. (1860) 191; Craib, Fl. Siam 2:434. 1939; Henders., J. Mal. Br. R. As. Soc. 17:56. 1939.

H. corymbosa Roxb., Fl. Ind. 2:531. 1824; Ridl., Fl. 2:335. 1923.

Usually from the extreme north. Rarely on limestone.

Kopsia griffithii K. et G., Mats. 19:432. 1907.

var. **paucinervia** K. et G., l.c. 432; Ridl., F. 2:337. 1923; Henders., J. Mal. Br. R. As. Soc. 17:56. 1939.

Shrub 1–2 m tall. Leaves thinly coriaceous, ovate-elliptic, caudate, nerves 12–15 pairs, 8–12 by 3.5–5 cm. Cymes terminal, corymbose. Corolla 3 cm long, white dilated at the top.

The species is endemic and very rare; the variety is known from only one collection (King's collector 10707) from dense jungle on a limestone hill in Perak.

Kopsia macrophylla Hk.f. F.B.I. 3:639. 1882; Ridl., Fl. 2:2338. 1923; Henders., J. Mal. Br. R. As. Soc. 17:56. 1939.

K. ridleyana K. et G., Mats. 19:433. 1907; Ridl., Fl. 2:338. 1923.

Endemic, not common, in lowland forest. Once from limestone on Bukit Serdam, Pahang. (Henderson 25044).

Kopsia pauciflora Hk.f., F.B.I. 3:639. 1882; Ridl., Fl. 2:337. 1923.

K. alba Ridl., in Henders., Gard. Bull. S.S. 5:78. 1930; J. Mal. Br. R. As. Soc. 17:56. 1939.

Melodinus orientalis Bl., Bijl. (1826) 1026; Ridl., Fl. 2:330. 1923; Henders., J. Mal. Br. R. As. Soc. 17:56. 1939.

Melodinus perakensis K. et G., Mats. 19:414. 1907; Ridl., Fl. 2:331. 1923; Henders., J. Mal. Br. R. As. Soc. 17:56. 1939.

Climber. Leaves elliptic-oblong, 8–12 by 3–5 cm. Cymes axillary 2–2.5 cm long. Corolla tube dilated in the middle. Fruit woody, pear shaped to 5 cm long.

Endemic, known only from the limestone at Gopeng, Perak.

Parameria polyneura Hk.f., F.B.I. 3:660. 1882; Ridl., Fl. 2:359. 1923; Henders., J. Mal. Br. R. As. Soc. 17:57. 1939.

Rauvolfia perakensis K. et G., Mats. 19:424. 1907; Ridl., Fl. 2:335. 1923; Henders., J. Mal. Br. R. As. Soc. 17:57. 1939.

Rauvolfia reflexa Teys. et Binn., Nederl. Kruidk. Arch. 3:405. 1855; Whitmore, Tree Fl. Mal. 2:21. 1973.

R. sumatrana Jack., Mal. Misc. 2:22. 1820; Fl. 2:336. 1923; Henders., J. Mal. Br. R. As. Soc. 17:57. 1939.

- Wrightia dubia* (Sims) Spreng., in Ngan, Ann. Miss. Bot. Gdn. 52:172. 1965.
Strophanthus jackianus Wall. in Ridl., Fl. 2:355. 1923.
Wrightia laevis Hk.f. F.B.I. 3:654. 1882; Ridl., Fl. 2:353. 1923; Henders., J. Mal. Br. R. As. Soc. 17:57. 1939; Ngan, Ann. Miss. Bot. Gdn. 52:136. 1965.

AQUIFOLIACEAE

- Ilex maingayi* Hk.f., F.B.I. 1:605. 1875; Ridl., Fl. I:440 1922; Henders., J. Mal. Br. R. As. Soc. 17:40. 1939.

Not common but widely distributed in forest, with a single record for limestone. (King's coll. 8177, from Gopeng, Perak).

ARALIACEAE

- | | |
|--|--------------------------------|
| 1. Leaves simple, lobed | 2 |
| Leaves palmately compound | 3 |
| 2. Leaves pinnately lobed | <i>Aralidium pinnatifidum</i> |
| Leaves palmately lobed | <i>Brassaiopsis palmata</i> |
| 3. Leaves, once palmate | 4 |
| Leaves 2-3 (-4) times palmately divided | <i>Schefflers junghuhniana</i> |
| 4. Leaves glabrous, glabrescent or mealy pubescent, becoming glabrous when old | 5 |
| Leaves densely stellate pubescent | <i>Schefflera tomentosa</i> |
| 5. Leaflets 2-6, glabrous | 6 |
| Leaflets 8-10, mealy stellate tomentose when young, becoming glabrous with age | <i>Schefflera elegans</i> |
| 6. Auricle at the base of petiole, small. | |
| Auricle at the base of petiole about 2 cm long | <i>Schefflera musangensis</i> |
| 7. Petiole 4-8 cm long | <i>Schefflera subracemosa</i> |
| Petiole 8-15 cm long | 8 |
| 8. Inflorescence a terminal branched panicle; peduncle of umbels about 1.5 cm long | <i>Schefflera venulosa</i> |
| Inflorescence terminal with 1-5 racemose branches bearing umbels; peduncle of umbels about 0.4 cm long | <i>Schefflera subulata</i> |

Aralidium pinnatifidum Miq., Fl. Ind. Bat. 1:763. 1856; Hk. f., F.B.I. 2:725. 1879; Ridl., Fl. 1:895. 1922; Corner, Way Trees 1:154. 1952.

Brassaiopsis polycantha (Wall.) Ban., Ind. For. 93:341. 1967. *B. palmata* Kurz., As. Soc. Beng. 39:77. 1870; Ridl., Fl. 1:887. 1922; Henders., J. Mal. Br. R. As. Soc. 17:48. 1939.

Hedera polycantha Wall., Pl. As. Rar. 2:82. 1831.

Schefflera elegans (Ridl.) Ridl., Fl. 1:878. 1922.

Heptapleurum elegans (Ridl.) Ridl., Jour. F.M.S. Mus. 6:150. 1915.

Endemic and uncommon, on mountains at about 1500 m. Recorded once from low elevation on limestone. (Gua Serai, Kelantan, UNESCO 1962 432)

Schefflera junghuhniana (Miq.) Harms., Back. Fl. Java 2:164. 1965.

S. heterophylla Harms, Ridl., Fl. 1:881. 1922; Henders., J. Mal. Br. R. As. Soc. 17:48. 1939.

Schefflera musangensis Henders., Gard. Bull. S.S. 7:105. 1933, J. Mal. Br. R. As. Soc. 17:48. 1939.

Endemic, known as an epiphyte on *Dipterocarpus oblongifolius* Bl. near Gua Musang, Kelantan and on rocks on Bukit Takun, Selangor.

Schefflera subracemosa (King) Vig., Ann. Sc. Nat. Ser. IX. 9:353. 1909; Ridl., Fl. 1:878. 1922.

Heptapleurum subracemosum King, Mats. 10:49. 1898.

Shrub 0.5–1 m tall. Leaves digitate, leaflets 3–5, glabrous, coriaceous, elliptic-lanceolate; base narrow slightly caudate, apex acuminate; petiole 4–7 cm, petiolules about 1 cm long, that of the terminal leaflet 2–3.5 cm long; blade 5.5–10 by 2–3 cm. Panicles terminal, subracemosa 2 (? or more) branched, about 8 cm long; flowers on short umbels. Fruit oblong 0.4 cm long, with 5 blunt ridges.

Endemic. Known from a single collection from Perak limestone. (King's collector 8288) Recently a specimen (UNESCO 121) From Batu Pinta, Bertam, Kelantan was doubtfully identified as this species.

Schefflera subulata (Seem.) Vig., Ann. Sc. Nat. Ser. IX. 9:351. 1909; Ridl., Fl. 1:878. 1922; Henders., J. Mal. Br. R. As. Soc. 17:48. 1939.

Heptapleurum subulatum Seem., J. Bot. 3:78. 1865.

Schefflera tomentosa (Hassk.) Vig., Ann. Sc. Sc. Nat. Ser. IX. 9:331. 1909; Ridl., Fl. 1:877. 1922; Henders., J. Mal. Br. R. As. Soc. 17. 48. 1939.

Heptapleurum tomentosum Hasak., Cat. Hort. Bog. (1844) 165.

Schefflera venolosa (Seem.) Harms. ex Eng. & Prantl., Nat. Pflanzen. 8:39. 1894; Ridl., Fl. 1:880. 1922.

Heptapleurum venulosum Seem., J. Bot. 3:80. 1865.

Dubious record.

ARISTOLOCHIACEAE

Apama tomentosa Engl., in Engl. et Prantl., *Naturl. Pflanzenfam.* III. 1:272
1889; Ridl., *Fl.* 3:15. 1924; Bak., *Fl. Java* 1:162. 1963.

ASCLEPIADACEAE

1. Small shrubs with stout stems; leaves coriaceous. Only from Langkawi, not common *Gongylosperma lanuginosum*
Climbers 2
2. Flowers in clusters along a gradually lengthening axis which is sometimes branched. Leaves thin *Marsdenia tinctoria*
Flowers not so arranged 3
3. Twigs smooth, usually drying ashy-grey; leaves elliptic-oblong, petiole about 1.5 cm long. Flowers on a short (to 1.5 cm) usually paired raceme from an axillary peduncle, purple/red. Only from Langkawi
..... *Gymnanthera insularum*
Not the above combination of characters 4
4. Corolla lobes imbricate 5
Corolla lobes valvate 10
5. Flower buds narrow, conical; corolla lobes linear oblong, twisted 6
Flowers buds oblong, sub-globose or globose; corolla lobes broad, not twisted
..... 7
6. Leaves ovate-elliptic to elliptic, usually 3.5-7 by 2 cm
..... *Toxocarpus pauciflorus*
Leaves broadly elliptic-obovate to sub-orbicular, usually 4-5 by 3 cm
..... *Toxocarpus curtisii*
7. Leaf bases cuneate; inflorescence dichotomously branched
..... *Secamone micrantha*
Leaf bases rounded or cordate; inflorescence not so branched 8
8. Leaves cordate 9
Leaves not cordate; flowers small, purple *Tolyphora tenuis*
9. Flower buds oblong, truncate. Corolla lobes inflexed in bud and bent downwards *Tolyphora calcicola*
Flower buds different *Tolyphora perakensis*
10. Epiphytes, leaves thick and fleshy 11
Not epiphytes; leaves thin *Heterostemma piperifolium*
11. Corolla tubular or urceolate; leaves usually small, less than 5 cm long 12
Corolla circular and flat, rotate; leaves usually large, more than 5 cm long 16

12. Some leaves converted into hollow pitchers, 5–12 cm long *Dischidia rafflesiana*
 No leaves converted into pitchers 13
13. Stem long and bars; leaves very few and widely spaced *Dischidia benghalensis*
 Stem with numerous leaves 14
14. Leaves, sparsely tomentose, to 2 cm long 15
 Leaves, not tomentose, 4–6 cm long *Dischidia scortechinii*
15. Corolla 0.2–0.3 cm long, pink. Only from Perlis *Dischidia tomentella*
 Corolla about 0.7 cm long, red. Widely distributed *Dischidia hirsuta*
16. Leaves softly pubescent below *Hoya coronaria*
 Leaves glabrous 17
17. Leaves more than 12 cm long 18
 Leaves less than 12 cm long 19
18. Pedicels 0.6 cm long; flowers 1 cm across *Hoya latifolia*
 Pedicels 1.2–2.4 cm long; flowers 1.2–1.7 cm across *Hoya maingayi*
19. Leaves with 3 main nerves from the base *Hoya citrina*
 Leaves with pinnately arranged nerves, which are often obscured
 *Hoya occlusa*
 *Hoya parviflora*
 *Hoya revoluta*
 *Hoya ridleyi*

Dischidia benghalensis Colebr., Trans. Linn. Soc. 12:357. 1817; Ridl., Fl. 2:405. 1923; Henders., J. Mal. Br. R. As. Soc. 17:57. 1939; Mal. Wildfls. Dicots. (1959) 300.

Dischidia hirsuta Dcne., in DC., Prodr. 8:632. 1844; Ridl., Fl. 2:406. 1923; Henders., J. Mal. Br. R. As. Soc. 17:57. 1939; Mal. Wildfls. Dicots. (1959) 302.

Dischidia rafflesiana Wall., Pl. As. Rar. 2:35. 1831; Ridl., Fl. 2:405. 1923; Henders., Mal. Wildfls. Dicots. (1959) 300.

Dischidia scortechinii K. et G., J. As. Soc. Beng. 74:592. 1908; Ridl., 2:409. 1923.

Endemic and very rare. Known from Perak and once on limestone in Kelantan. (UNESCO 681).

Dischidia tomentella Ridl., Fl. 2:409. 1923; Henders., J. Mal. Br. R. As. Soc. 17:57. 1939.

Slender climber, softly tomentose. Leaves fleshy, lanceolate, 1.2 by 0.4 cm. Peduncles 0.6 cm long. Corolla short, pink.

Endemic and very rare, restricted to limestone; known only from Bukit Lagi in Perlis. I have seen only one specimen (Henderson 22802).

Gongylosperma lanuginosum Ridl., Fl. 2:372. 1923; Henders., J. Mal. Br. R. As. Soc. 17:57. 1939.

Short shrub, stout and woody. Leaves elliptic, pubescent, 12–25 by 4–8 cm. Cymes 5–8 cm long, flowers dull red. Fruit about 2.4 by 0.6 cm.

Endemic and restricted to limestone in Langkawi.

Gymnanthera insularum K. et G., J. As. Soc. Beng. 74:514. 1908; Ridl., Fl. 2:373. 1973; Henders., J. Mal. Br. R. As. Soc. 17:57. 1939.

Woody climber, stem smooth, old parts often pale grey. Leaves 4.5–9 by 1.6–3.6 cm. Flowers in short racemes, lengthening to 1.5 cm, purple.

Distributed in Peninsular Thailand. In Malaya only from Langkawi, probably restricted to limestone; not common.

Heterostemma piperifolium K. et G., J. As. Soc. Beng. 74:557. 1908; Ridl., Fl. 2:393. 1923; Henders., J. Mal. Br. R. As. Soc. 17:57. 1939, Mal. Wildfls. Dicots. (1959) 292.

Twiner, leaves thin, ovate-acuminate, the base cordate 5–9 by 2.5–6 cm, finely pubescent. Petioles 2–5 cm long. Peduncles 1–1.5 cm long, flowers yellow. Follicles slender, 10–12 cm long.

Endemic and found only in the northern half of Malaya; usually on limestone. Chin 28, 387 & 413 have much more pubescent leaves with very short (about 0.3 cm) petioles. Collected from limestone in Kedah, Perak, Pahang and Selangor.

Hoya citrina Ridl., in Fl., 2:397. 1923; Henders., J. Mal. Br. R. As. Soc. 17:57. 1939.

Stem long. Leaves thick, fleshy, ovate-acute, base rounded or cordate, 9–11 by 6–8 cm. Peduncles stout to 6 cm long, flowers pale yellow.

Endemic and rare, known only from Gua Batu, Selangor, Batu Kurau, Perak and from Ulu Bubong, Perak (not limestone).

Hoya coronaria Bl., Bijdr. (1827) 1063; Ridl., Fl., 2:400. 1923; Henders., J. Mal. Br. R. As. Soc. 17:57. 1939, Mal. Wildfls. (1959) 298.

Hoya latifolia Don., Gen. Syst. 4:127. 1837; Ridl., Fl. 2:395. 1923; Henders., Mal. Wildfls. (1959) 297.

Hoya maingayi Hk.f., F.B.J. 4:62. 1883; Ridl., Fl. 2:396. 1923; Henders., J. Mal. Br. R. As. Soc. 17:57. 1939.

Endemic, a rare and relatively unknown species. Recorded once from limestone. (UNESCO 125 from Bukit Pinta, Kelantan).

Hoya occlusa Ridl., J. Str. Br. As. Soc. 61:31. 1912, Fl. 2:398. 1923; Henders., J. Mal. Br. R. As. Soc. 17:57. 1939.

Stem angular. Leaves coriaceous, ovate-acute, about 10 by 5 cm, petioles 2.5 cm long. Inflorescence umbellate, flowers small.

Endemic, a very rare and hardly known species; recorded only by Ridley from Gua Batu, Selangor. (Ridley s.n. Dec. 1890).

Hoya parviflora Wight, Contrib. (1837) 37; Ridl., Fl. 2:401. 1923; Henders., J. Mal. Br. R. As. Soc. 17:57. 1939.

Hoya revoluta Wight ex Decne., in DC. Prodr. 8:636. 1844; Ridl., Fl. 2:401. 1923.

Endemic, not rare, in forests. Recorded only once from limestone. (Chin 95 from Gua Musang, Kelantan).

Hoya ridleyi K. et G., J. As. Soc. Beng. 74:592. 1908; Ridl., Fl. 2:401. 1923.

Marsdenia tinctoria Br., Mem. Wern. Soc. Edinb., 1:30. 1811; Ridl., Fl. 2:388. 1923; Henders., J. Mal. Br. R. As. Soc. 17:57. 1939, Mal. Wildfls. Discots. (1959) 291.

Distributed in India, China and all over Malesia. In Malaya found only in the northern half, often on or near limestone. This plant may be a remnant of cultivation and not native (at one time it was grown as a source of indigo).

Secamone micrantha Decne., in DC., Prodr. 8:501. 1844; Ridl., Fl. 2:375. 1923; Henders., J. Mal. Br. R. As. Soc. 17:57. 1939, Mal. Wildfls., Dicots. (1959) 294.

Toxocarpus curtisii K. et G., J. As. Soc. Beng. 74:521. 1902; Ridl., Fl. 2:376. 1923; J. Mal. Br. R. As. Soc. 17:58. 1939.

Endemic and not common, usually on the hills in dry spots, 700–1000 m. Recorded occasionally from limestone at low altitude.

Toxocarpus pauciflorus Henders., Gard. Bull. S.S. 7:110. 1933, J. Mal. Br. R. As. Soc. 17:58. 1939.

Climber. Young twigs rusty pubescent. Leaves ovate, elliptic or elliptic-lanceolate, 3.5–7 by 1.2–2(–3.5) cm. Inflorescence rusty pubescent, to 2 cm long. Flowers pale yellow, sweet scented; corolla lobes twisted. Fruit, a pair of follicles about 5 cm long, rusty pubescent (later becoming glabrous?)

Endemic and uncommon, restricted to limestone in Kelantan, Perak and Selangor.

Tylophora calcicola Henders., Gard. Bull. S.S. 7:111. 1933, J. Mal. Br. R. As. Soc. 17:58. 1939.

Slender twiner, young parts sparsely pubescent. Leaves 5–8 by 3–5 cm broadly ovate or oblong-ovate, base cordate. Cymes axillary to 3 cm long. Corolla lobes inflexed in bud. Ripe fruit unknown.

Endemic and known from only two limestone records. Henderson 19583 from Gua Ninek, Kelantan and Henderson 25204 from Bukit Cheras, Pahang.

Tylophora perakensis K. et G., J. As. Soc. Beng. 74:555. 1908; Ridl., Fl. 2:392. 1923; Henders., J. Mal. Br. R. As. Soc. 17:58. 1939.

Uncommon in Malaya, in forest. Recorded on limestone from Gunong Pondok, Perak (Ridley l.c.) and from Kedah.

Tylophora tenuis Bl., Bijdr. (1827) 1062. Ridl., Fl. 2:391. 1923; Henders., J. Mal. Br. R. As. Soc. 17:58. 1939, Mal. Wildfls. Dicots. (1950) 294.

BALANOPHORACEAE

Balanophora fungosa Forst., in Benth., Fl. Aust. 6:232. 1873; Merrill, Enum. Philip. Pl. 2:118. 1923.

BALSAMINACEAE

1. Plant to 2.5 m tall. Stem columnar, base swollen, leaves crowded at the end of stout branches, 1.5–3 cm in diameter; leaves 10–30 by 5–15 cm. Inflorescence to 30 cm long *Impatiens mirabilis*
Plant smaller, stem not as thick, base not swollen; leaves usually much smaller 2
2. Flowers in racemose inflorescences, branched or unbranched but with a distinct peduncle. A common species on the central Malayan limestone *Impatiens opinata*
Flowers not in racemes, usually axillary and solitary 3
3. Spur of the posterior sepal bilobed 4
Spur of the posterior sepal not bilobed 6
4. Spur of the posterior sepal recurved, about 0.5 cm long 5
Spur of the posterior sepal straight, about 1 cm long ... *Impatiens scortechinii*
5. Flowers with 3 sepals including the one with the spur, the 2 anterior sepals aborted, absent. Very rare, only from Tebing Tinggi in Perlis
..... *Impatiens vaughanii*
Flowers with 5 sepals including the one with the spur, the 2 anterior sepals reduced, linear, about 3 mm long. Rare, only from Perlis
..... *Impatiens macrosepala*
6. Flowers orange-yellow, the two anterior sepals about 4 mm long, rounded at the tip. Only from Gua Tipus in Pahang *Impatiens tipusensis*
Flowers predominantly white, the two anterior sepals 1–2 mm long 7
7. Leaves elliptic-lanceolate 3–6 by 1–1.25 cm. Endemic and only from limestone near Ipoh *Impatiens cryptoneura*
Leaves broadly elliptic to orbicular, apex acute, base cuneate. Common on Gua Batu, Selangor, also from Gunong Senyum, Pahang ... *Impatiens ridleyi*

Impatiens cryptoneura Hk.f. in Kew Bull. (1909) 9; Ridl., Fl. 1:339. 1922; Henders., J. Mal. Br. R. As. Soc. 17:38. 1939; Shimizu, S. East As. Studies 8:208. 1970.

Plant to 30 cm tall. Leaves ovate-lanceolate 3–6 by 1–2.5 cm, petioles 1–5 cm. Flowers small, sepals greenish, pedicels 2.5 cm.

Endemic and known only from a single collection (Curtis 3172) made on the limestone near Ipoh in 1895. Similar to *I. ridleyi*, except for the shape of the leaves which in this specimen are narrower than in *I. ridleyi*. More specimens are needed for closer examination.

Impatiens macrosepala Hk.f., Rec. Bot. Surv. Ind. 4:55. 1906; Ridl., Fl. 1:339. 1922; Craib, Fl. Siam. 1:211. 1926; Shimizu, S. East Asian Studies 8:205. 1970.

Plant 20–40 cm tall; leaves on the upper part of stem, ovate acuminate, 5–17 by 2–6 cm. Flowers solitary or in pairs, axillary, white; pedicels 1.5 cm.

Distributed in Peninsular Thailand; in Malaya only recorded from limestone in Perlis at Bukit Lagi and Tebing Tinggi.

Impatiens mirabilis Hk.f., Curtis, Bot. Mag. (1891) 117; Ridl., Fl. 1:337. 1922; Craib, Fl. Siam. 1:211. 1926; Henders., J. Mal. Br. R. As. Soc. 17:38. 1939; Shimizu, S. East Asian Studies 18:216. 1970.

Plant 1–2.5 m tall. Stem columnar, base swollen to more than 30 cm across, 2–3 times branched; ultimate branches stout. Leaves at the end of branches 10–30 by 5–15 cm, light green in colour. Inflorescences sub-terminal to 30 cm long.

Distributed in Peninsular Thailand; in Malaya from Perlis and Kedah, with a solitary record from Pahang. This spectacular plant is abundant and dominates the scenery on the rocky slope between Telok Dalam and the Lake on Pulau Langgun, (in the north-east of Pulau Langkawi proper). Restricted to limestone.

Impatiens opinata Craib, in Kew Bull. (1926) 163, Fl. Siam. 1:212. 1926; Shimizu, S. East Asian Studies 18:216. 1970.

I. foxworthyi Henders., Gard. Bull. S.S. 4:50. 1927, 5:94. 1930. J. Mal. Br. As. Soc. 17:38. 1939.

Plant 30–50 cm tall. Leaves ovate-elliptic 3–12 by 2–6.5 cm, on the upper part of stem; petioles 3–7 cm. Inflorescence terminal or sub-terminal, branched or unbranched. Flowers yellow.

Distributed in Peninsular Thailand (once collected); in Malaya common in Kelantan, also from Pahang; surprisingly not recorded from the northern Malayan limestone. Shade loving; usually from sheltered, moist situation. Restricted to limestone.

Impatiens ridleyi Hk.f., Rec. Bot. Surv. Ind. 4:55. 1906; Ridl., Fl. 1:339. 1922; Henders., J. Mal. Br. R. As. Soc. 17:38. 1939; Shimizu, S. East Asian Studies 18:207. 1970.

Plant 30–40 cm tall. Leaves broadly elliptic, orbicular-ovate, apex acute, base cuneate, biglandulose at the base. Flowers axillary, solitary white, the saccate part of the posterior sepal with reddish/purple reticulate markings on the inside. Seeds finely granulate, when freshly dehisced are sticky and effectively adheres on to any object on contact.

Endemic to limestone in Malaya; very common on Gua Batu, Selangor; only once from elsewhere, (Gunong Senyum, Pahang). This is the common balsam growing on rocks at the entrance to the Temple Cave in Gua Batu.

Impatiens scortechinii Hk. f., Rec. Bot. Surv. Ind. 4:55. 1906; Ridl., Fl. 1:339. 1922; Henders., J. Mal. Br. R. As. Soc. 17:38. 1939; Shimizu, S. East Asian Studies 8:206. 1970.

Plant 30–100 cm tall, stem 2–3.5 cm through at the base. Leaves at the end of stems, to 25 by 8 cm, usually less. Flowers white with some yellow-orange spots; in leaf axils, solitary or 2–3 fascicled, pedicels 2.5–4 cm long.

Distributed in North Borneo; in Malaya from Perak and Pahang. Restricted to limestone.

Impatiens tipusensis Henders., Gard. Bull. S.S. 5:72. 1930, J. Mal. Br. R. As. Soc. 17:38. 1939; Shimizu, S. East Asian Studies 8:208. 1970.

Plant creeping, scandent. Leaves up to 8 by 6 cm, triangular ovate. Flowers solitary, axillary, spur about 1 cm long, slender and upcurved.

Endemic and known only from a single collection (Henderson 19399) made from Gua Tipus in Pahang, where it was 'growing in great profusion on limestone rocks'.

Impatiens vaughanii Hk.f., Kew Bull. (1911) 250; Ridl., Fl. 1:338. 1922; Craib, Fl. Siam. 1:213. 1926; Henders., J. Mal. Br. R. As. Soc. 17:39. 1939. Shimizu, S. East Asian Studies 8:203. 1970.

Plant 40–60 cm tall, leaves only at the end of branches. Leaves ovate or elliptic, 8–10 by 4–6 cm, petioles 6–8 cm long. Flowers white or violet/purple. Spur incurved and bifid.

Distributed in lower Peninsular Thailand; in Malaya only from Perlis, restricted to limestone. A rare plant. The unspecified *Impatiens* mentioned by Henderson, l.c. pg. 39 (Ridley 15035) has been identified as this (Shimizu l.c. pg. 203).

BEGONIACEAE

- 1. Leaves peltate 2
 Leaves not peltate 3
- 2. Ovary 3-loculate; stem apex, young leaves and adult petioles, hairy. Only from Kota Glanggi, Pahang *Begonia ignorata*
 Ovary 2-loculate; plant glabrous. Not uncommon in Perak and Kelantan *Begonia kingiana*
- 3. Leaves orbicular, broader than long; margin ciliate with reddish brown hairs. Ovary 3-loculate 4
 Leaves longer than broad, margin usually glabrous. Ovary 2-loculate 5
- 4. Leaves 3–5 cm long by 4–6 cm wide or smaller, apices rounded. Male flower with 4 perianth lobes *Begonia nurii*
 Leaves 9–11 cm by 12–14 cm wide; apices abruptly acuminate or acute. Male flowers with 2 perianth lobes *Begonia foxworthyi*
- 5. Stem 5–20 cm long, erect, weakly or stiffly so 6
 Stem short creeping 7
- 6. Plant tuberous; flowers large, male about 2 cm across; outer perianth 0.7–1.1 cm long. Only from Langkawi, rare *Begonia curtisii*
 Plant not tuberous; flowers smaller, male about 0.7–0.9 cm across; outer perianth about 0.3–0.5 cm long. Recorded only from Gunong Pondok, Perak *Begonia dibilis*

7. Leaves pubescent on the undersurface, especially on the veins; the two outermost perianth lobes, white, 0.7–0.9 cm long, 0.5–0.8 cm wide. Only from Langkawi *Begonia guttata*
 Leaves glabrous; the two outermost perianth lobes white with reddish pink veins, 0.3–0.6 cm long and 0.4–0.5 cm wide. Common on Gua Batu. Selangor, very rare elsewhere *Begonia phoeniogramma*

Begonia curtisii Ridl., J. Str. Br. R. As. Soc. 59:106. 1911, Fl. 1:856. 1922; Irmsch., Mitt. Inst. Alg. Bot. Hamburg 8:149. 1929; Henders., J. Mal. Br. R. As. Soc. 17:47. 1939.

Plant slender, erect, tuberous, to 20 cm tall. Leaves 2–4, glabrous, ovate, base unequally cordate, to 15 cm long. Inflorescence terminal or sub-terminal, outer perianth of the male flower white with red veins. Fruit 3-winged, one longer than the other two.

Restricted to limestone and found only from the southern part of Peninsular Thailand and Langkawi.

Begonia debilis King, J. As. Soc. Bengal 71:60. 1902; Ridl., Fl. 1:858. 1922; Irmsch., Mitt. Inst. Alg. Bot. Hamburg 8:157. 1929; Henders., J. Mal. Br. R. As. Soc. 17:47. 1939.

Endemic to Malaya and only twice collected, once from Negri Sembilan on rocks in forest, not limestone; and the other from limestone on Gunong Pondok, Perak.

Begonia foxworthyi Burk. in Ridl., Fl. 5:311. 1925; Irmsch., Mitt. Inst. Alg. Bot. Hamburg 8:100. 1929; Henders., J. Mal. Br. R. As. Soc. 17:47. 1939.

Rhizome short and thick, creeping, 3–5 cm long and 0.5–0.7 cm across. Leaves 9–11 by 12–14 cm wide, hairy below especially on the veins. Inflorescence hairy, peduncle 7–20 cm long; male flowers with two perianth lobes.

Endemic to limestone and known only from Kelantan and Bukit Cheras in Pahang. Fairly widespread on the limestone in Kelantan, but not very common.

Begonia guttata Wall., Cat. (1831) 3671; Clarke in Hk.f., F.B.I. 2:684. 1879; Ridl., Fl. 1:858. 1922; Irmsch., Mitt. Inst. Alg. Bot. Hamburg 8:153. 1929; Henders., J. Mal. Br. R. As. Soc. 17:47. 1939.

A rare plant distributed in Peninsular Thailand and in Malaya, from Penang, Langkawi and according to Ridley, (l.c. 858) from Selangor. Recorded on limestone from Langkawi.

Begonia ignorata Irmsch., Inst. Alg. Bot. Hamburg 8:97. 1929; Henders., J. Mal. Br. R. As. Soc. 17:47. 1939.

B. hasskarli Zoll. et Mor. var. *hirsuta* Ridl., Fl. 1:860. 1922.

Plant small, with a creeping rhizome. Petiole 10–17 cm long, pubescent, lamina peltate, broad oval or sub-orbicular, 6–7 cm long. Inflorescence axillary, male flowers with 4 perianth part, outer two, 0.4–0.5 cm long.

Rare endemic to limestone, known only from a single collection, made at Kota Glanggi, Pahang.

Begonia kingiana Irmsch., Mitt. Inst. Alg. Bot. Hamburg, 8:106. 1929; Henders., J. Mal. Br. R. As. Soc. 17:47. 1939.

B. hasskarli King, in J. As. Soc. Bengal 71(2):62. 1902.

B. hasskarli Ridl., Fl. 1:860. 1922, non Zoll. et Mor.

Plant with creeping rhizome, about 6 cm long. Petiole (3-)6-12(-18) cm long, glabrous. Lamina peltate, 5-9 cm long, by and about as wide, apex abruptly acute. Inflorescence 10-40 cm long, male flowers glabrous, with 4 perianth, the outer 2, 4-6 cm long and as wide.

Endemic to limestone and known from Seelangor (fide Henderson, l.c.), Perak and Kelantan; not uncommon on the hills in Kelantan in shady places.

Begonia nurii Irmsch., Mit. Inst. Alg. Bot. Hamburg 8:95. 1929.

Plant with rhizome 3-4 cm long, 0.3-0.5 cm across. Petiole 4-9 cm long, blade orbicular-reniform, 3.5-5 cm long and 4-6 cm wide; all with reddish brown hairs, margin ciliate. Inflorescence slender, sub-terminal, flowers small, made with a 0.2-0.4 cm pedicel, tepals 4.

Endemic to limestone in Kelantan and Pahang.

Begonia phoeniogramma Ridl., J. R. As. Soc. St. Br. 75:35. 1917, Fl. 1:358. 1922. Irmsch., Mitt. Inst. Alg. Bot. Hamburg 8:155. 1929; Henders., J. Mal. Br. As. Soc. 17:47. 1939.

B. paupercula Ridl., J. R. As. Soc. S. Br. 54:42. 1909. non King.

Plant with a short inconspicuous stem, delicate. Petiole 1-7 cm long, lamina with unequal base, oblong to ovate, 4-8(-15) by 3-7 (-11) cm, green with pale spots. Inflorescence 4-5 cm long, much longer when in fruit. Male flowers with 4 sepals.

Endemic to limestone, from Langkawi (fide Ridley, l.c.), Kelantan (once collected) and Selangor where it is common on Gua Batu as small isolated populations in shade and usually from rock crevices.

BIGNONIACEAE

Radermachera lobbii (T. & B.) Miq., Ann. 3:250. 1867; van Steenis, Bull. Jard. Bot. Buit. 10:243. 1928; Stone, Mal. Nat. J. 24:94. 1971.

R. amoena Ridl., Fl. 2:551. 1923; Henders., Gard. Bull. S. S. 4:297. 1928.

Tree 7-25 m. Leaves bipinnate or sometimes simply pinnate. When bipinnate the lower pinnae with 3-5(-7) leaflets. Leaflets obovate-elliptic, 5-12 by 3-7 cm; apex blunt-acuminate or obtuse, rounded or emarginate; base cuneate, glandular with dark spots; glabrous. Inflorescence terminal or lateral, 10-25 cm long, peduncle 5-8 cm long. Flowers pinkish in bud, when opened with white corolla and some yellow in the throat. Calyx 1.2-1.5 cm, tubular-campanulate. Corolla 2.5-3 cm long. Capsule pendulous, cylindric 30-50 cm long, 0.7-0.8 cm broad.

Distributed in Sumatra and Borneo. In Malaya not uncommon in lowland forest. Only recently recorded for limestone, and the sole member of its family so recorded (Stone l.c.). It is fairly common occurring as scattered individuals on limestone in Kelantan. Collected from Gua Musang, Gua Panjang and Gua Serai, and observed from Batu Neng, Gua Batu Boh and Gua Tapah. The limestone specimens do not attain the size quoted above and were all only 2-7 m tall. They have always been observed on dry rocky summits with little soil accumulation; but not on the driest craggy parts. All the flowering specimens from the limestone I have seen differs from the typical form as described above by having larger flowers and smaller fruits. In fresh specimens the calyx is up to 2 cm long; petals protruding to 5 cm (including lobes) beyond the calyx cup. The dried fruits are 20-25 by 0.6-0.7 cm.

It is interesting to note that in August 1971 a couple of plants on Gua Musang, Kelantan have sent up vigorous shoots to 2 m tall (and already flowering) from the remaining basal parts of plants that have most of their aerial portions destroyed by the fire of early 1969. The other two species that with aerial parts surviving the fire are *Podocarpus polystachyus* R. Br. ex Mirb. and *Cratoxylon maingayi* Dryer.

BOMBACACEAE

Leaves simple *Neesia synandra*

Leaves palmately compound *Bombax anceps*

Bombax anceps Pierre, in Fl. For. Cochinch. (1888) 175; Koch., Tree Fl. Mal. 1:04. 1972.

B. insularis Ridl., Fl. 1:260. 1922.

Found in the north west in Malaya, usually near the sea. Sometimes on coastal limestone in Langkawi, Kedah.

Neesia synandra Masts., in Hk.f. F.B.I. 1:352. 1874; Ridl., Fl. 1:265. 1922; Koch., Tree Fl. Mal. 1:119. 1972.

BORAGINACEAE

1. Stigma 2-lobed. Shrubs or small trees *Ehretia timorensis*

Stigma 4-lobed. Small trees 2

2. Leaves ovate-lanceolate, acute or acuminate; base slightly cuneate

..... *Cordia griffithii*

Leaves ovate, sub-acute or bsunt; base round or sub-cordate ... *Cordia obliqua*

Cordia griffithii Clarke, in Hk.f., F.B.I. 4:139. 1885; Ridl., Fl. 2:439. 1923; Henders., J. Mal. Br. R. As. Soc. 17:59. 1939.

Distributed in Peninsular Thailand; in Malaya common in the north. Recorded from limestone in Langkawi only.

Cordia obliqua Willd., Sp. Pl. (1802) 1072; Ridl., Fl. 2:439. 1923; Back., Fl. Java 2:459. 1965.

Cordia sp., in Henders., J. Mal. Br. R. As. Soc. 17:59. 1939.

A fairly common tree in Malaya, often cultivated. Twice recorded from limestone; the specimen Kiah 35418 referred to by Henderson in l.c. has been named as this species, but according to the collector's label it is a climber.

Ehretia timorensis DC., Nouv. Ann. Mus. Hist. 3:395. 1834; Ridl., Fl. 2:442. 1923; Henders; J. Mal. B.R.A. Soc. 17:59. 1939.

E. laevis Roxb., in Back., Fl. Java 2:460. 1965.

Dacryodes kingii (Engl.) Kalkman ex Leenh., Fl. Mal. I. 5:224. 1956.

Santiria floribunda King, in Ridl., Fl. 1:376. 1922.

D. floribunda H. J. Lam, Ann. Jard. Bot. Btzig. 42:204. 1932; Henders., J. Mal. Br. R. As. Soc. 17:39. 1939.

Endemic to Malaya, not uncommon in lowland forest. Recorded once from limestone. (Henderson 23800 from Gunong Pondok, Perak).

Garuga floribunda Decne, Nouv. Ann. Mus. Hist. Nat. Paris 3:477. 1834; Leenh., Fl. Mal. I. 5:215. 1956; Koch., Tree Fl. Mal. 1:144. 1972.

Tree to 30 m. Branchlets finely tomentose, leaves crowded at the end of branchlets. Stipules at the base of petiole, caducous. Leaflets elliptic or oblong-lanceolate 5–15 by 2–5 cm. Inflorescence axillary, at the end of branchlets, appearing before leaves. Flowers bisexual, 5-merous.

Known in Malaya from a single collection. Whitmore F.R.I. 4247 from Gua Jenera, Kelantan.

BUXACEAE

1. Leaves 3–8 by 1–3 cm 2
Leaves larger, 10–17 by 3–7.5 cm. Known only from Kaki Bukit, Perlis ...
..... *Buxus holttumiana*
2. Leaves; upper surface shiny, when dry the midrib on the upper surface raised; styles on the fruit 0.4–0.5 cm long *Buxus malayana*
Leaves; upper surface dull, when dry the midrib on the upper surface impressed, styles on the fruit 0.1 cm long *Buxus rupicola*

Buxus holttumiana Hatusima, J. Dep. Agri. Kyu. Imp. Uni. 6:270. 1942; Henders., J. Mal. Br. R. As. Soc. 17:69. 1939.

Shrub. Leaves opposite, coriaceous, ovate-oblong, ovate-elliptic or broadly lanceolate, apex acuminate, glabrous, 10–17 by 3–7.5 cm. Racemes axillary, about 1 cm long. Flowers unisexual; male, pedicel 0.2 cm, sepals 4, stamens 4; female terminal, sepals 6, ovary 3-loculate. Capsule 1.3 cm long, style 3, persistent and recurved, 0.6 cm long.

Endemic and known only from limestone on Kaki Bukit, Perlis.

Buxus malayana Ridl., Kew Bull. (1926) 475; Henders., J. Mal. Br. R. As. Soc. 17:69. 1939; Hatusima, J. Dep. Agr. Kyu. Imp. Uni. 6:289. 1942.

Shrub or small tree 2–4 m tall. Leaves opposite, coriaceous, broadly elliptic, elliptic, elliptic-lanceolate or ovate-elliptic, apex blunt, acute or acuminate, margin narrowly recurved, glabrous, 3.5–6.5(–8) by 1–3 cm. Racemes axillary or sometimes terminal, short, 0.5–1 cm long. Flowers unisexual, male edicel 0.1 cm long, sepals and stamens 4; female terminal. Capsule ovoid, about 0.8 cm across, styles 3, persistent, the tip recurved, 0.5 cm long.

Endemic to limestone in Malaya. This species, *B. holttumiana* and *B. rupicola* which are all endemics to Malayan limestone, are the southernmost representatives of *Buxus* to be found in Asia. The latter two however are only found in the extreme Northwest and are very rare; *B. malayana* on the other hand is found in Kelantan, Pahang, Perak and Selangor and is not uncommon on many hills; being very common on Bukit Takun, Selangor where it forms the southernmost population of this genus.

Buxus rupicola Ridl., J. Str. Br. R. As. Soc. 59:166. 1911, Fl. 3:182. 1924; Henders., J. Mal. Br. R. As. Soc. 17:69. 1939; Hatusima, J. Dep. Agri. Kyu. imp. Uni. 6:282. 1942.

Shrub. Leaves opposite, thick coriaceous, ovate-oblong, oblong or oblong-lanceolate, apex obtuse or emarginate, margin narrowly revolute, glabrous, 3–6 by 1.2–2.5 cm. Racemes axillary, 0.6–0.8 cm long. Flowers unisexual; male pedicel 0.2 cm long, sepals and stamens 4; female terminal. Capsule ovoid 0.7 cm long, styles 3, persistent, 0.1 cm long.

Endemic and known only from a single collection made by Curtis in Sept. 1890. (Curtis 2662 from Dayang Bunting, Langkawi).

CAPPARIDACEAE

Thorns recurved; flowers in umbels *Capparis diffusa*
 Thorns straight or slightly curved upwards; flowers in short racemes
 *Capparis pubiflora*

Capparis diffusa Ridl., Fl. 1:22. 1922; Henders., J. Mal. Br. R. As. Soc. 17:35. 1939; Jacobs, Fl. Mal. I, 6:81. 1960.

Scandent shrub. Leaves elliptic, ovate to obovate, 5–8(–10) by 2.5–4 cm; midrib sunken about, raised below. Flowers in umbels, terminal. Pedicels filiform, 2–5 cm long. Sepals about 0.4 cm, petals white 0.4–0.5 cm long. Stamens 12–15, gynophore about 1.5 cm. Fruits unknown.

Distributed in N. Sumatra. In Malaya restricted to limestone and previously known from only two collections made in Perlis. Four recent numbers, Stone 6988 from Pulau Jerkokm Kechil, Langkawi, Chin 1069 and 1104 from Bukit Serdam, Raub and Chin 870 from Gunong Pondouk, Perak match this species. The flowers are however borne on short lateral shoots and the buds appear smaller than those of the type (I have not however seen opened flowers). This particular form is quite common on dry rocky slopes of hills.

Capparis pubiflora DC., Prodr. 1:246. 1824; Jacobs, Fl. Mal. I. 6:82. 1960.

C. perakensis (Scort. ex King) Ridl., Fl. 1:124. 1922.

Capparis sp., in Henders., J. Mal. Br. R. As. Soc. 17:35. 1939.

CAPRIFOLIACEAE

Viburnum sambucinum Bl., Bijdr. 13:656. 1826; Clarke in Hk.f., F.B.I. 3:5. 1880; Ridl., Fl. 2:1. 1923; Corner, Way. Trees 1:182. 1952; Kern & van Steenis, Fl. Mal. I. 4:186. 1951.

In Malaya common in hill and lower montane forest especially between 650–1300 m and occasionally in swampy places in the lowlands. Once collected from limestone. (UNESCO 117 from Batu Pinta, Kelantan).

CARDIOPTERIDACEAE

Cardiopteris javanica Bl., Rumphia 3:206. 1849; Back., Fl. Java 2:63. 1965. *C. lobata* Wall., in Ridl., Fl. 2:464. 1923; Henders., J. Mal. Br. R. As. Soc. 17:59. 1939.

Peripterygium quinquelobum Hassk., in Hutch., Fam. Fl. Pl. 1:315. 1964. (2nd. Ed.)

CELASTRACEAE

- | | |
|--|------------------------------------|
| 1. Leaves alternate or spirally arranged | 2 |
| Leaves opposite | 3 |
| 2. Flowers crowded at the apex of short shoots, 1–2 cm long and elongating as the fruit matures | <i>Maytenus curtisii</i> |
| Flowers on tubercles, sometimes ramiflorous | <i>Salacia grandiflora</i> |
| 3. Trees, to much more than 5 m tall | 4 |
| Shrubs 1–3(–5) m tall, or scandent | 5 |
| 4. Flowers in distinctly dichotomously lax-branched inflorescences; peduncle 1–8 cm long | <i>Euonymus cochinchinensis</i> |
| Flowers in almost sessile inflorescences; peduncle very rarely to 2 cm long | <i>Euonymus javanicus</i> |
| 5. Stipules small, lobed or laciniate | 6 |
| Stipules small, not lobed or laciniate | 7 |
| 6. Flowers in cymose inflorescence; peduncle 2–6 cm long, if very short, then fruit with 3 divergent follicle-like parts | <i>Reissantia indica</i> |
| Flowers in fascicles, on short tubercles, sometimes ramiflorous. Fruit subglobose, to about 5 cm across | <i>Salacia macrophylla</i> |
| 7. Branchlets sharply 4-angled, narrowly winged ... | <i>Glyptopetalum quadrangulare</i> |
| Branchlets not so, sometimes bluntly angled | 8 |

8. Fruits with 3-divergent, follicle-like parts; seed with a basal wing. Scandent
 *Loeseneriella pauciflora*
 Fruit otherwise; seed wingless 9
9. Fruit capsular, dehiscent, usually less than 2 cm across 10
 Fruit drupaceous, indehiscent, usually more than 2 cm across 12
10. Fruit dehiscent with the axis splitting completely leaving no columella. Seeds
 usually 2 in each locule 11
 Fruit dehiscent leaving a persistent columella. Seeds usually 1 in each
 locule. Only from Kota Glanggi, Pahang *Glyptopetalum zeylanicum*
 var. *brevipedicellatum*.
11. Flowers in distinctly dichotomously lax-branched, 1–8 cm long inflorescences
 *Euonymus cochinchinensis*
 Flowers in almost sessile, or very rarely to 2 cm long inflorescences
 *Euonymus javanicus*
12. Flowers in distinctly peduncled cymes; fruits 2–3 cm across
 *Salacia korthalsiana*
 Flowers in fascicles, or on very short tubercles, sometimes ramiflorous; fruits
 2–5 cm across *Salacia grandiflora*

Euonymus cochinchinensis Pierre, Fl. Flor. Coch. (1894) 4; D. Hou, Fl. Mal. I. 6:248. 1962; Whitmore, Tree Fl. 1:162. 1972.

Glyptopetalum scortechinii King, in Ridl., Fl. 1:447. 1922.

E. pahangensis Ridl., Fl. 5:299. 1925.

Euonymus javanicus Bl., Bijdr. (1827) 1146; Henders., J. Mal. Br. R. As. Soc. 17:40. 1939; D. Hou, Fl. Mal. I. 6:248. 1962; Whitmore, Tree Fl. 1:162. 1972.

E. coriaceus Ridl., Fl. 5:299. 1925.

E. micropetalus Ridl., l.c.

Glyptopetalum quadrangulare Prain ex King, J. As. Soc. Beng. 65:345. 1896; Ridl., Fl. 1:446. 1922; Henders., J. Mal. Br. R. As. Soc. 17:40. 1939; D. Hou, Fl. Mal. I. 6:257. 1962.

Glyptopetalum zeylanicum Thw. var. ***brevipedicellatum*** D. Hou, Fl. Mal. I. 6:257. 1962; Whitmore, Tree Fl. 1:162. 1972

Small tree. Leaves chartaceous, elliptic 7–10 by 3–5 cm. Margin slightly crenulate. Peduncle of cymes 4–5 cm long.

The species is recorded from Southern India and Ceylon; this variety is endemic to Malaya and collected only once here (D. Hou l.c.) at Kota Glanggi, Pahang (Ridley 2652).

Loeseneriella pauciflora (DC.) A.C. Smith, Am. J. Bot. 28:440. 1941.

Hippocratea nigricaulis Ridl., J. Str. Br. R. As. Soc. 75:20. 1917; Henders., J. Mal. Br. R. As. Soc. 17:40. 1939.

H. macrantha King., Ridl., Fl. 1:455. 1922.

Salacia perakensis King., Ridl., Fl. 1:457. 1922.

Maytenus curtisii (King) D. Hou, Fl. Mal. I. 6:240. 1962; Whitmore, Tree Fl. 1:170. 1972.

Gymnosporia curtisii King, in Ridl., Fl. 1:451. 1922; Henders., J. Mal. Br. R. As. Soc. 17:40. 1939.

Scandent shrub. Leaves subcoriaceous, elliptic, broadly elliptic to suborbicular, 7–16 y 4–9 cm, base cuneate. Cymes crowded towards the apex of short-shoots. Fruits obovate-depressed globose, 3-celled, each with 1–2 seeds.

Distributed in Peninsular Thailand and in Malaya where it has been recorded from Perlis, Kedah and Kelantan; apparently restricted to limestone in Malaya, but also from lowland forest in Thailand.

Reissantia indica (Willd.) Halle, Bull. Mus. Hist. Nat. Paris 30:466. 1958; D. Hou, Fl. Mal. I. 6:401. 1964.

Hippocratea indica Willd., in Henders., J. Mal. Br. R. As. Soc. 17:40. 1939.

Salacia grandiflora Kurz, J. As. Soc. Beng. 41:300. 1872; Ridl., Fl. 1:458. 1922; Henders. J. Mal. Br. R. As. Soc. 17:41. 1939.

S. scortechinii King, in Ridl., Fl. 1:457. 1922; Henders., J. Mal. Br. R. As. Soc. 17:41. 1939.

Salacia korthalsiana Miq. Ann. Mus. Bot. Lugd. Bat. 4:152. 1869; Ridl., 1:457. 1922; Henders., J. Mal. Br. R. As. Soc. 17:41. 1939.

Hippocratea obtusa Ridl., Fl. 5:299. 1925.

Salacia macrophylla Bl., Bijdr. (1825) 221; D. Hou, Fl. Mal. I. 6:412. 1964.

S. flavescens Kurz., incl. var. *dumosa* King; Ridl., Fl. 1:459. 1922; Henders., J. Mal. Br. R. As. Soc. 17:41. 1:39.

CHLORANTHACEAE

Chloranthus elatior R. Br. ex Link, Bot. Mag. t. 2190; Back., Fl. Java 1:175. 1963.

C. officinalis Bl., Enum. Pl. Jav. (1830) 79; Ridl., Fl. 3:52. 1924.

COMBRETACEAE

1. Climbers or scrambling shrubs 2
Trees 4
2. Inflorescence 2-4 cm long, spicate. Styles adnate to wall of receptacle. Petioles 0.4-0.6 cm. Langkawi *Quisqualis parvifolia*
Inflorescence 4-20 cm long, spicate or paniculate. Styles free from the receptacle. Petioles 0.5-3 cm. Perak 3
3. Leaves elliptic to narrowly elliptic. Calyx lobes deltoid, less than 0.1 cm long *Combretum porterianum*
Leaves broadly elliptic, ovate-elliptic or suborbicular. Calyx lobes narrowly triangular, 0.2-0.3 cm long *Combretum latifolium*
4. Leaves opposite or subopposite, on very slender twigs, elliptic, ovate-elliptic or sometimes obovate, 3-8 by 1.5-3.5 cm. Fruits (including wings) longer than broad. Small tree 3-10 m, often on dry craggy limestone
..... *Terminalia triptera*
Leaves spiral, crowded towards the ends of stout twigs, oblong or obovate, 9-20 by 3-9 cm. Fruits (including wings) broader than long. A larger tree *Terminalia calamansanai*

Combretum latifolium Bl., Bijdr. (1925) 641; Exell, Fl. Mal. I. 4:542. 1954.
C. extensum Roxb., in Ridl., Fl. 1:709. 1922.

Combretum porterianum (Cl.) Wall. ex Craib, Fl. Siam 1:618. 1931; Exell, Fl. Mal. I. 4:540. 1954.
C. chinense var *porterianum* Cl. in Ridl., Fl. I:709. 1922.

Quisqualis parvifolia (Ridl.) Exell, J. Bot. 69:123. 1931; Exell, Fl. Mal. I, 4:545. 1954.

Q. densiflora var *parvifolia* Ridl., Fl. I:711. 1922; Craib, Fl. Siam. 1:623. 1931; Henders., J. Mal. Br. R. As. Soc. 17:45. 1939.

Endemic in the north-west of Malaya, in rocky and open places, sometimes on limestone.

Terminalia calamansanai (Blanco) Rolfe, J. Linn. Soc. Bot. 21:310. 1884; Exell, Fl. Mal. I, 4:556. 1954; Koch., Tree Fl. Mal. I:175. 1972.

T. pyrifolia Kurz., in Corner, Way. Trees 1:194. 1952; Henders., J. Mal. Br. R. As. Soc. 17:45. 1939.

T. bialata King in Ridl., Fl. 1:705. 1922.

Terminalia triptera Stapf, Kew Bull. (1895) 103; Ridl., Fl. 1:706. 1922; Craib, Fl. Siam. I:608. 1931; Henders., J. Mal. Br. R. As. Soc. 17:45. 1939; Koch., Tree Fl. Mal. 1:178. 1972.

Small tree 3–10 m. Leaves chartaceous, obscurely pellucid-punctate, 3–8 by 1.5–3.5 cm. Flowers cream, in terminal and axillary panicles. Fruits 3-winged 1–2 by 0.6–1.2 cm.

Distributed in Thailand, Indo-China and in Malaya where it is restricted to the extreme north; often, but not exclusively on limestone, where it is often found on dry craggy parts.

COMPOSITAE

- | | |
|--|-----------------------------------|
| 1. Leaves opposite | 2 |
| Leaves alternate | 6 |
| 2. Twining and climbing. Leaves cordate | <i>Mikania cordata</i> |
| Not so, erect herbs or shrubs | 3 |
| 3. Shrubs, often sprawling | <i>Eupatorium odoratum</i> |
| Herbs | 4 |
| 4. Some leaves deeply lobed, more or less pinnate or with large irregular teeth, to one-third way to the midrib | 5 |
| All leaves with regular shallow teeth; upper leaves alternate | <i>Ageratum conyzoides</i> |
| 5. Some leaves pinnatifid or pinnate, flower heads in branched inflorescences | <i>Bidens pilosa</i> |
| All leaves simple, irregularly toothed. Flower heads usually solitary on a long 10–20 cm peduncle | <i>Tridax procumbens</i> |
| 6. Flower heads as wide or wider than long | 7 |
| Flower heads longer than wide | 8 |
| 7. Flower heads 0.4–0.6 by 0.4–0.6 cm. Leaves at the base of plant opposite; alternate above | <i>Ageratum conyzoides</i> |
| Flower heads 0.8–1 cm long by 1–1.2 cm wide. Leaves all opposite | <i>Vernonia curtisii</i> |
| 8. Flower heads with 1 series of lanceolate bracts almost as long as the flower and with small linear ones at the base | <i>Erechthites valerianifolia</i> |
| Flower heads with several series of bracts | 9 |
| 9. Heads numerous in a loose terminal corymbose inflorescence; 0.6–0.8 cm long. Ubiquitous herb | <i>Vernonia cinerea</i> |
| Heads 2–3 in axillary or terminal cymes; 1.2 cm long. Kedah | <i>Vernonia rupicola</i> |

Ageratum conyzoides L., Sp. Pl. (1753) 839; Koster., Blumea 1:484. 1935; Heenders., Mal. Wildfls. Dicot. (1959) 241.

A common weed; found on limestone in distributed localities.

Bidens pilosa L., Sp. Pl. (1753) 832; Ridl., Fl. 2:183. 1923; Henders., Mal. Wildfls. Dicots. (1959) 239.

A common weed; found on limestone in disturbed localities.

Erechtites valerianifolia (Wolf) DC., Prodr. 6:295. 1838; Ridl., Fl. 2:191. 1923; Henders., Mal. Wildfls. Dicots. (1959) 249; Back. Fl. Java 2:424. 1965.

A common weed. Once recorded from limestone from the disturbed, often frequented summit of Bukit Takun, Selangor.

Eupatorium odoratum L., Cyst. ed. 10, 1205. 1959; Steenis, Reinw. 1:478. 1952; Henders., Mal. Wildfls. Dicot. (1959) 234.

An aggressive sprawling shrub of disturbed areas. Common in such areas on limestone.

Mikania cordata (Burm.f.) B.L. Robinson, Contr. Gray Herb. 114:65. 1934; Koster., Blumea 1:504. 1935; Henders., J. Mal. Br. R. As. Soc. 17:52. 1939, Mal. Wildfls. Dicots. (1959) 233.

In Malaya, a very common climber, in forest margins, secondary growths, waysides, and all kinds of open ground. Sometimes at the base of limestone in disturbed areas.

Tridax procumbens L., Sp. Pl. (1753) 900; Hk.f., F.B.I. 3:311. 1881; Henders., Mal. Wildfls. Dicots. (1959) 238.

On disturbed limestone near Ipoh.

Vernonia cinerea (L.) Less., Linnaea 4:291. 1829; Hk.f., F.B.I. 3:233. 1881; Ridl., Fl. 2:188. 1923.

Recorded from limestone in disturbed places.

Vernonia curtisii Craib & Hutchinson, Kew Bull. (1910) 22; Ridl., Fl. 2:189. 1923; Henders., J. Mal. Br. R. As. Soc. 17:53. 1939.

Herb 30–100 cm. Leaves elliptic, base attenuate to the winged petiole, margin serrate. 3–8 by 0.7 to 2.5 cm. Flower heads 4–10 in a terminal inflorescence, each on a peduncle 3–10 cm long; 0.8–1 cm long by 1–2 cm wide. Achenes longitudinally ribbed.

Found only in Peninsular Thailand and Langkawi in Malaya; apparently restricted to limestone, not uncommon.

Vernonia rupicola Ridl., J. F.M.S. Mus. 10:144. 1920, Fl. 2:189. 1923; Hender., J. Mal. Br. R. As. Soc. 17:53. 1939.

Plant 30–100 cm tall, woody at the base. Leaves narrow elliptic to lanceolate, base narrowed to the winged petiole, 6–12 by 3–5 cm. Flower heads terminal or axillary, 2–3 together, on peduncles 3–5 cm long. Achenes narrow, ribbed hairy.

Endemic to the Langkawi group of island and most probably restricted to limestone, not common.

CONNARACEAE

1. Leaves trifoliolate. Fruits rough with 0.3–0.4 cm long papillae
 *Agelaea borneensis*
 Leaves pinnate. Fruits smooth 2
2. Fruits compressed, almost as broad as long *Connarus semidecandrus*
 Fruits convex, length almost twice the breadth *Connarus* sp.

Agelaea borneensis (Hk.f.) Merr., Philip. J. Sc. Bot. 4:127. 1909; Leenh., Fl. Fl. Mal. I. 5:504. 1958.

A. vestita Hk.f., in Ridl., Fl. 1:553. 1922.

Castanola villosa Schellenb., in Henders., J. Mal. Br. R. As. Soc. 17:43. 1939.

Connarus semidecandrus Jack, Mal. Misc. 2:39. 1822; Leenh., Fl. Mal. I, 5:534. 1958.

C. griffithii Hk.f., in Ridl., Fl. 1:546. 1922; Henders., J. Mal. Br. R. As. Soc. 17:43. 1939.

Connarus sp.

Woody climber. Leaves with 5–7 leaflets, of 1–2 sub-opposite pairs and a terminal leaflet. Petiole 25–30 cm long, petiolules 1–1.4 cm long. Leaflets elliptic-oblong, sub-coriaceous and glabrous (in the matured ones), 12–28 by 4.5–12 cm, base broadly cuneate, nerves 10–12 pairs. Infructescence (inflorescence not known) terminal, of 3–5 main branches about 10–28 cm long from the stem; each with 1–4 short lateral branches. Fruit about 4 by 2–3 cm, bright red; ellipsoid to oblong, base narrowed to a slender stipe about 0.3 cm long. The style remnant which is shifted to the dorsal side forms a beak near the apex. Inside of pericarp shortly and sparsely-densely pubescent; seed 1, about 3 cm long. In unripe fruit, testa yellow; the basal part below the hilum partly enveloped by a fleshy aril. In ripe fruit the seed is black and the aril yellow.

There are 3 numbers which are apparently the same, Chin 1424 and Whitmore FRI 4268 from the Gua Musang limestone at about 250 m altitude and Everett FRI 14391 from Taman Negara, Pahang, on a hillside below a narrow ridge over sandstone in primary forest at 330 m.

Chin 1424 was from a broad gully near the summit ridge of Gua Musang on rocky terrain with fair accumulation of soil and supporting a fairly dense vegetation 5–8 m tall.

CONVOLVULACEAE

1. Leaf base deeply cordate; entire or shallowly to deeply 3-5 lobed
..... *Lepistemon binectariferum*
Leaf bases cuneate, rounded, truncate or slightly cordate; entire or undulate,
never lobed 2
 2. Inflorescence 1-3(-5) flowered 3
Inflorescence many flowered 4
 3. Leaves elliptic to oblong, velvety pubescent with shiny pale golden hairs,
sparse on the upper surface *Argyreia mollis*
Leaves ovate to orbicular, lower surface glabrescent or pubescent, but not
velvety *Ipomoea illustris*
 4. Inflorescence with prominent persistent bracts; lanceolate and at least 1.2 cm
long. Corolla 4.5-6 cm long *Argyreia maingayi*
Inflorescence with much smaller bracts. Corolla 0.8-1 cm long
..... *Jacquemontia paniculata*
- Argyreia maingayi* (Cl.) Hoogl., Blumea 7:185. 1952; van Oost., Fl. Mal. I.
4:502. 1953.
- Lettsomia maingayi* Cl., in Hk.f. F.B.I. 4:195. 1883; Ridl., Fl. 2:450. 1923;
Henders., J. Mal. Br. R. As. Soc. 17:59. 1939.
- Endemic to Malaya, in forest, swamps, by rivers and on limestone in
Kelantan.
- Argyreia mollis* (Burm.f.) Choisy, Mem. Soc. Phys. Geneve 6:421. 1833; van
Oost., Fl. Mal. I. 4:496. 1953.
- Lettsomia argentea* Ridl., J.F.M.S. Mus. 7:47. 1916.
- A. obtusifolia* Lour. in Henders., J. Mal. Br. R. As. Soc. 17:59. 1939.
- Ipomoea illustris* (Cl.) Prain, Beng. Pl. 2:735. 1903; Ridl., Fl. 2:460. 1923;
Ridl., Fl. 2:460. 1923; Henders., J. Mal. Br. R. As. Soc. 17:59. 1939; van
Oost., Blumea 3:566. 1940, Fl. Mal. I. 4:485. 1953.
- In Malaya, rare, only in the north; recorded from the limestone (Henderson
l.c.) in Langkawi.
- Jacquemontia paniculata* (Burm.f.) Hall.f., Bot. Jahrb. 16:541. 1893; Ridl., Fl.
2:456. 1923; Henders., J. Mal. Br. R. As. Soc. 17:59. 1939; van Oost.,
Blumea 3:269. 1939, Fl. Mal. I. 4:432. 1953.
- Lepistemon binectariferum* (Wall.) O.K., Rev. Gen. (1891) 446; van Oost., Fl.
Mal. I. 4:489. 1953.
- L. flavescens* Bl., in Ridl., Fl. 2:462. 1923; Henders., J. Mal. Br. R. As.
Soc. 17:59. 1939.

CUCURBITACEAE

1. Fruit a capsule opening by a lid 2
Fruit a berry, not deshiscing 3
2. Calyx lobes 3, seeds winged all round *Zanonia clarkei*
Calyx lobes 5, seeds winged at one end only *Neoalsomitra pubigera*
3. Corolla lobes fimbriate *Trichosanthes tricuspidata*
Corolla lobes not fimbriate 4
4. Leaves scabrid, usually lobed; fruits not ribbed 5
Leaves not scabrid, entire with remote teeth *Momordica subangulata*
5. Fruits globose 1–1.2 cm across *Melothria affinis*
Fruits oblong-ovate, about 5 by 2 cm *Gymnopetalum cochinchinensis*

Gymnopetalum cochinchinense Kurz., J. As. Soc. Beng. 40:57. 1871; Ridl., Fl. 1:846. 1922; Henders., J. Mal. Br. R. As. Soc. 17:47. 1939.

Melothria affinis King, J. As. Soc. Beng. 67:38. 1898; Ridl., Fl. 1:849. 1922; Henders., Mal. Wildfls. Dicots. (1959) 157.

M. marginata Cogn., in DC., Mon. Phan. 3:593. 1881; Henders., J. Mal. Br. R. As. Soc. 17:47. 1939.

Momordica subangulata Bl., Bijdr. (1826) 928; Ridl., Fl. 1:848. 1922; Henders., J. Mal. Br. R. As. Soc. 17:47. 1939.

Not common in Malaya, recorded from limestone in Ipoh and from river banks in Kelantan.

Neoalsomitra pubigera (Prain) Hutch., Ann. Bot. N.S. 6:99. 1942.

Alsomitra pubigera Prain., in Craib, Fl. Siam 1:768. 1931; Henders., J. Mal. Br. R. As. Soc. 17:47. 1939.

A. clavigera Roem., in Ridl., Fl. 1:852. 1922.

Trichosanthes tricuspidata Lour., Fl. Cochinch. (1790) 529; Ridl., Fl. 1:844. 1922; Henders., J. Mal. Br. R. As. Soc. 17:47. 1939.

Zanonia clarkei King, J. As. Soc. Beng. 67:41. 1898; Ridl., Fl. 1:852. 1922; Henders., J. Mal. Br. R. As. Soc. 17:47. 1939.

Climber to 25 m long. Leaves coriaceous, ovate, base broad, nerves 5–7 from the base, blade 6–9 by 6–8 cm. Flowers unknown. Fruits ovoid, cylindrical 12–20 cm long.

Endemic, known only from two specimens collected from over limestone, one from Gua Batu, Selangor and the other from Kinta, Perak (Henderson l.c.).

DATISCACEAE

Tetrameles nudiflora R. Br., in Benn., Pl. Jav. Rar. (1838) 79; Ridl., Fl. 1:864. 1922; Henders., J. Mal. Br. R. As. Soc. 17:48. 1939; van Steenis, Fl. Mal. I. 4:385. 1953.

Large tree 25–45 m.

Distributed in Ceylon., Andamans and S.E. Asia. In Malaya recorded only from Gunong Keriang (a limestone hill) in Kedah, with nothing to show whether it was actually collected from the hill or not. It probably came from the base of the hill.

DILLENIAACEAE

Small perennial herbs. Leaves all radical or from a short stem *Acrotrema costatum*

Woody climber. Receptacle flat, anther-cells diverging towards the base *Tetracera scandens*

Tree. Receptacle between the carpels conical *Dillenia indica*

Acrotrema costatum Jack., Mal. Misc. I. 5:36. 1820; Ridl., Fl. 1:7. 1922; Henders., Mal. Wild. Fl. 1:20. 1949; Hoogl., Fl. Mal. I. 4:151. 1951.

Dillenia indica L., Sp. Pl. (1753) 535; Ridl., 1:10. 1922; Corner, Way. Trees 1:204. 1940; Hoogl., Fl. Mal. I, 4:171. 1951.

Tetracera scandens (L.) Merr., Int. Rumph. (1917) 365; Hoogl., Fl. Mal. I. 4:143. 1951.

T. hebecarpa Boerl. in Henders., J. Mal. Br. As. Soc. 17:33. 1939.

DIPTEROCARPACEAE

1. Lower surface of leaves glabrous 2
- Lower surface of leaves sparsely or densely tomentose, sometimes only on the veins 7
2. Veins very numerous, close together, slender and hardly raised 3
- Veins 6–16 pairs, usually prominently raised on the lower surface 4
3. Fruit with wings undeveloped *Dryobalanops oblongifolia*
- Fruit with 2 long wings *Hopea dryobalanoides*
- Fruit with 5 long wings *Dryobalanops aromatica*
4. Leaves about 15 cm long. Matured fruits with 3 or 5 enlarged wings 5
- Leaves, usually less than 10 cm long. Matured fruits with 2 enlarged wings 6

- 5. Leaf bases slightly cordate, broadly ovate-oblong, length less than twice the width. Ripe fruits with 3 wings larger than the other 2 ... *Pentacme siamensis*
 Leaf bases rounded, oblong-lanceolate, length more than twice the width.
 Ripe fruits with 5 enlarged wings *Parashorea lucida*
- 6. Leaves ovate-acuminate. Nut oblong *Hopea ferrea*
 Leaves elliptic-lanceolate. Nut globose *Vatica cinerea*
- 7. Leaves large, oblong-lanceolate, 15–24 by 6–10 cm
 *Dipterocarpus oblongifolius*
 Leaves smaller, less than 15 cm long, rarely 17 cm 8
- 8. Tertiary nerves reticulate 9
 Tertiary nerves more or less parallel and at right angles to the secondaries;
 scalariform 10
- 9. Undersurface of leaves with a close felt-like brown tomentum. Fruit with
 2 enlarged wings *Cotylelobium malayanum*
 Undersurface of leaves with very sparse pubescence. Fruit with 5 enlarged
 wings *Vatica cinerea*
- 10. Margin of leaves reflexed; leaf boat-shaped with the lower surface concave
 *Shorea ovalis*
 Leaves not as above 11
- 11. Leaves pubescent on the lower surface; elliptic *Shorea leprosula*
 Leaves pubescent only along the veins; oblong-lanceolate *Shorea guiso*

Cotylelobium malayanum V. Sl., Bull. Jard. Bot. Buitz. 3:12. 1932; Foxw., Malay. For. Rec. 10:247. 1932; Syming., Mal. For. Rec. 16:235. 1943.

In Malaya it is usually coastal and chiefly from the east coast. Once recorded from limestone; the tree was not seen but a leafy twig and a fruit were picked off the ground in an area completely encircled by vertical limestone cliffs (Gunong Rapat, Ipoh, Chin 774).

Dipterocarpus oblongifolium Bl., Mus. Bot. 2:36. 1852; Ridl., Fl. 1:216. 1922; Foxw., Mal. For. Rec. 10:86. 1932; Syming., Mal. For. Rec. 16:184. 1943.

Common in Malaya, usually along rocky streams. Once collected from limestone at Gua Serai, Kelantan; probably at the base (UNESCO 343).

Dryobalanops aromatica Gaertn. f., Fract. 3:49. 1805; Ridl., Fl. 1:210. 1922; Foxw., Mal. For. Rec. 10:105. 1932; Syming., Mal. For. Rec. 16:194. 1943.

Saplings have been seen on the small limestone outcrops in Johore; though the roots probably reach the sandstone-derived soil around the limestone.

Dryobalanops oblongifolia Dyer, Lond. J. Bot. 12:100. 1874; Foxw., Mal. For. Rec. 10:110. 1932; Syming., Mal. For. Rec. 16:196. 1943.

There are saplings of this plant growing on the small limestone outcrops in Johore; the roots probably reach the sandstone-derived soil around the limestone.

Hopea dryobalanoides Miq., Fl. Ind. Bot. Suppl. (1860) 492; Symington, Gard. Bull. S. 10:345. 1939, Mal.

For Rec. 16:123. 1941; Wycherley, M. N.J. 25:33. 1972.

According to Wycherley (l.c.) this species has been recorded from Batu Caves, "on deep soil over limestone in the high valley above the caves."

Hopea ferrea Llanessan, Pl. Utiles Col. Fr. (1886) 300; Foxw., Mal. For. Rec. 10:126. 1932; Henders., J. Mal. Br. R. As. Soc. 17:37. 1939; Syming., Mal. For. Rec. 16:124. 1943.

Balanocarpus anomalus King, in Ridl., Fl. 1:247. 1922.

Tree, frequently small and gnarled. Leaves coriaceous, ovate; acuminate; secondary veins 7–10 pairs. Fruit cylindrical, conical with 2 long wings 3–4 cm long and 3 short wings, 0.2–0.3 cm long, thick, curved, and bluntly pointed.

Distributed in Indo-China and Thailand. In Malaya it is restricted to the north west, and frequently as stunted, gnarled trees on the limestone, and other soil types. Very common on Langkawi islands; when in flower the light-coloured crowns are very conspicuous. Flower profusely in August 1972.

Parashorea lucida (Miq.) Kurz., J. As. Soc. Beng. 39:65. 1870; Syming., Mal. For. Rec. 16:102. 1943.

P. stellata Kurz., l.c. Ridl., Fl. 1:234. 1922; Foxw., Mal. For. Rec. 10:242. 1932.

Confined to the northern half in Malaya. Recorded from limestone once (UNESCO 377 from Batu Ner, Kelantan).

Pentacme siamensis (Miq.) Kurz., J. As. Soc. Beng 39:66. 1870; Foxw., Mal. For. Rec. 10:155. 1932; Syming., Mal. For. Rec. 16:105. 1943.

P. malayana King, in Ridl., Fl. 1:220. 1922.

Small tree, usually gnarled, deciduous, the flowers appearing with the new leaves. Leaves, 12–17 by 7–11 cm, glabrous. Fruit with 3 large wings to 8 cm long and 2 small to 4 cm long.

Distributed in Burma, Indo-China and Thailand. In Malaya it occurs only in the northwest, and is probably restricted to limestone, not uncommon, and often conspicuous on the Langkawi islands.

Shorea guiso (Blanco) Bl., Mus. Bot. Lugd. Bat. 2:34. 1852; Syming., Mal. For. Rec. 16:16. 1943.

S. longipetala Foxw., Mal. For. Rec. 10:174. 1932.

Once recorded from limestone on Gua Serai, Kelantan; not specified but probably from the base of hill (UNESCO 497).

Shorea leprosula Miq., Fl. Ind. Bot. Suppl. (1862) 487; Ridl., Fl. 1:222. 1922; Foxw., Mal. For. Rec. 10:220. 1932; Syming., Mal. For. Rec. 16:75. 1943.

Recorded once from limestone as a sapling; not specified but probably from the base of hill (UNESCO 498A from Gua Serai, Kelantan).

Shorea ovalis (Korth.) Bl., Mus. Bot. Lugd. Bat. 2:33. 1852; Syming., Mal. For. Rec. 16:80. 1943.

S. sericea Dyer., in Ridl., Fl. 1:224. 1922; Foxw., Mal. For. Rec. 10:229. 1932.

Recorded once from limestone, 'a small tree, sterile' (UNESCO 497 A from Gua Serai, Kelantan).

Vatica cinerea King, Materials (1893) 104; Foxw., Mal. For. Rec. 10:256. 1932; Henders., J. Mal. Br. R. As. Soc. 17:37. 1939; Syming, Mal. For. Rec. 16:105. 1943.

Synaptea cinerea (King) Ridl., Fl. 1:243. 1922.

Distributed in Burma and Thailand. In Malaya chiefly in the northwest and often in dry situations, not common on limestone, but recorded from Kelantan and Perlis.

EBENACEAE *

Seventeen species of *Diospyros* have been recorded from limestone; most of these are occasionals though a few are very rare and restricted to the limestone habitat.

I have only been able to collect or see only six species. Under the circumstances the treatment is largely dependent on Bakhizen (1933) who listed the Malayan Ebenaceae and described a large number of new species; and Bakhuzen (1936-41) which is a careful and detailed account of the Malesian Ebenaceae known then. Ridley's Flora and Corner (1952) * have also been consulted.

The key is only to the six species I have seen.

- | | |
|--|------------------------------|
| 1. Leaves, lower surface pubescent | 2 |
| Leaves, lower surface glabrous | 3 |
| 2. Leaves small, 2-4 (-8) by 0.8-2 (-3) cm; fruiting calyx 0.4-0.6 cm across. Recorded on limestone from Kelantan | <i>Diospyros buxifolia</i> |
| Leaves larger, 4.5-12 by 2.5-5.5 cm; fruiting calyx 2.5-3 cm across. Only from Langkawi | <i>Diospyros transitoria</i> |
| 3. Leaves more than 5 cm long, tip blunt-tapered, acute or acuminate | 4 |
| Leaves less than 5 cm long, tip emarginate, rounded or sub-acute. Common on limestone around Gua Musang, Kelantan | <i>Diospyros ferrea</i> |
| 4. Lateral veins prominent, 8-20 pairs, leaves membranous, chartaceous or sometimes subcoriaceous; base with no glands | 5 |
| Lateral veins obscure, numerous, anastomosing with tertiaries to form a network visible on the lower surface, coriaceous; base with a pair of glands | <i>Diospyros adenophora</i> |
| 5. Flowers on twigs; leaves and twigs drying a pale gray to black | <i>Diospyros frutescens</i> |
| Flowers on trunk, cauliflorous; leaves and twigs not drying grey or black | <i>Diospyros cauliflora</i> |

* See recent papers by F.S.P. Ng in, Malay. Forester 40:210-248. 1977 and Tree Fl. Mal. 3:56-94. 1978.

Diospyros adenophora Bakh., Gard. Bull. S.S. 7:164. 1933, Bull. Jard. Bot. Buitenz. III. 15:298. 1938; Henders. J. Henders. J. Mal. Br. R. As. Soc. 17:54. 1939.

Endemic, uncommon. On limestone from Raub and Kota Celanggi, Pahang. Otherwise from Kota Bahru, Kelantan, Termeloh, Pahang and Kuala Pilah, Negri Sembilan.

Diospyros buxifolia (Bl.) Hiern, Trans. Camb. Phil. Soc. 12:218. 1873; Bakh., Bull. Jard. Bot. Buitenz. III, 15:97. 1937.

D. microphylla Bedd., in Ridl. Fl. 2:293. 1923.

Diospyros cauliflora Bl., Bijdr. (1825–1826) 668; Bakh., Gard. Bull. S.S. 7:166. 1933, Bull. Jard. Bot. Buitenz. III. 15:134. 1937; Henders. J. Mal. Br. R. As. Soc. 17:54. 1939.

D. caliginosa Ridl., in Fl. 2:295. 1923.

Diospyros daemona Bakh., Gard. Bull. S.S. 7:169. 1933, Bull. Jard. Bot. Buitenz. III. 15:140. 1937; Henders., J. Mal. Br. R. As. Soc. 17:54. 1939.

Tree to 30 m. Leaves oblong or oblong-lanceolate, base round or slightly cordate, dense pubescent when young, later less so, 5–15 by 2–5 cm. Female flowers axillary, solitary and sessile. Fruits solitary, subglobose, 6–8 cm across.

Distributed in Sumatra, a very rare species known only from very few collections. Recorded from Malaya once, on Bukit Chintamani, Pahang. (Henderson 25030).

Diospyros ellipsoidea K. et G., J. As. Soc. Beng. 74:220. 1906; Ridl., Fl. 2:290. 1923; Bakh., Gard. Bull. S.S. 7:169. 1933, Bull. Jard. Bot. Buitenz. III, 15:122. 1937; Henders., J. Mal. Br. R. As. Soc. 17:55. 1939.

Endemic, uncommon in lowland forest, so far recorded only from Kelantan and Perak. According to Henderson, recorded from limestone in Perak.

Diospyros ferrea (Willd.) Bakh., Gard. Bull. S.S. 7:162. 1933, Bull. Jard. Bot. Buitenz. III, 15:50. 1937; Henders. J. Mal. Br. R. As. Soc. 17:55. 1939.

Maba buxifolia (Rottb.) A.L. Juss., in Ridl., Fl. 2:281. 1923

Common in Malaya, especially along rocky coasts; also on limestone, where it is fairly common on dry hill tops near Gua Musang.

Diospyros frutescens Bl., Bijdr. (1825–1826) 668. Bakh., Gard. Bull. 7:171. 1933, Bull. Jard. Bot. Buitenz. III, 15:192. 1938; Henders. J. Mal. Br. R. As. Soc. 17:55. 1939.

D. cymosa Ridl. Fl. 2:293. 1923.

D. Kunstleri K. et G., in Ridl. l.c. 293.

Diospyros hermaphroditica (Zoll.) Bakh., Gard. Bull. S.S. 7:162. 1933, Bull. Jard. Bot. Buitenz. III, 15:86. 1937; Henders, J. Mal. Br. R. As. Soc. 17:55. 1939.

D. clavigera (non Clarke) Ridl., Fl. 2:288. 1923.

Maba clarkeana K. et G., in Ridl. l.c. 280.

M. merguensis Hiern., in Ridl. l.c. 280.

M. olivacea K. et G., in Ridl. l.c. 279.

Not uncommon in Malaya, often coastal. Recorded from limestone in Perlis (Henderson l.c.) I have not seen any specimens of this species.

Diospyros holttumii Bakh., Gard. Bull. S.S. 7:162. 1933, Bull. Jard. Bot. Buitenz. III, 15:80. 1937; Henders, J. Mal. Br. R. As. Soc. 17:55. 1939.

Shrub. Leaves ovate-oblong to lanceolate, base cuneate or obtuse, margin reflex, glabrous, 7–15 by 3.5–5 cm. Male flowers not known; female flowers axillary, solitary. Fruit depressed globose, 1–2 cm across; calyx 3–4 lobed, 1.5–2 cm across.

Rare endemic, known from a single collection made over limestone; Holttum 15122 from Pulau Dayang Bunting, Langkawi, Kedah.

Diospyros malayana Bakh., Gard. Bull. S.S. 7:163. 1933, Bull. Jard. Bot. Buitenz. III, 15:75. 1937; Henders, J. Mal. Br. R. As. Soc. 17:55. 1939.

Maba racemosa Ridl., Fl. 5:320. 1925.

Diospyros pilosanthera Blanco, Fl. Filipin, 2:304. 1878; Bakh., Gard. Bull. S.S. 7:181. 1933, Bull. Jard. Bot. Buitenz. II, 15:243. 1938; Henders., J. Mal. Br. As. Soc. 17:55. 1939.

D. Helferi Cl., in Ridl., Fl. 2:292. 1923.

Diospyros retrofracta Bakh., Gard. Bull. S.S. 7:361. 1933, Bull. Jard. Bot. Buitenz. III, 15:361. 1938; Henders, J. Mal. Br. R. As. Soc. 17:55. 1939.

Small tree 3.5–10 m. Leaves oblong, margin reflexed, lower surface appress-pilose, 4–15 by 1.5 cm. Inflorescence axillary, cymose; flowers 4-merous; male unknown; female sessile, calyx 4-lobed, about 0.5 cm across. Fruit depressed globose; 2.5–3 cm across; calyx 1–2 cm across, lobed reflexed.

Distributed in Peninsular Thailand. Recorded from Perlis, Perak and Pahang in Malaya; restricted to limestone.

Diospyros rigida Hiern, Trans. Camb. Phil. Soc. 12:257. 1873; Ridl., Fl. 2:291. 1923; Bakh., Gard. Bull. S.S. 7:183. 1933, Bull. Jard. Bot. Buitenz. III, 15:367. 1938.

Rare in Malaya, recorded from Perak and recently from limestone in Kelantan; UNESCO 99, from Batu Hayan, Bertam.

Diospyros toposioides K. et G., J. As. Soc. Beng. 74:223. 1906; Ridl., Fl. 2:290. 1923; Bakh., Gard. Bull. S.S. 7:186. 1933, Bull. Jard. Bot. Buitenz. III, 15:301. 1938; Henders., J. Mal. Br. R. As. Soc., 17:55. 1939.

Diospyros transitoria Bakh., Gard. Bull. S.S. 7:186. 1933, Bull. Jard. Bot. Buitenz. III, 15:360. 1938.

Small tree to 10 m. Leaves ovate-elliptic, ovate-oblong to oblong-lanceolate, firm coriaceous; apex acute or gradually narrowed to acuminate, lower surface brown pubescent, 4.5–12 by (1.5–) 2.5–5.5 cm. Inflorescence axillary; male in short cymes about 1 cm long, flowers not known; female solitary, calyx 4–5 lobed, corolla tubular, 4–5 lobed. Fruit 2–3 cm across, densely pubescent; caly coriaceous, with 4 large lobes, each broadly ovate to 1.5 cm long.

Distributed in Peninsular Thailand. Recorded from Langkawi in Malaya, rarely collected and restricted to limestone.

Diospyros undulata Wall. ex G. Don., Cat. (1831) 4136; Bakh., Gard. Bull. S.S. 7:187. 1933, Bull. Jard. Bot. Buitenz. III, 15:279. 1938; Henders. J. Mal. Br. R. As. Soc. 17:55. 1939.

Diospyros wallichii K. et G. ex King., J. As. Soc. Beng. 74:220. 1906; Ridl., Fl. 2:291. 1923; Bakh., Gard. Bull. S.S. 7:263. 1933, Bull. Jard. Bot. Buitenz. III, 15:262. 1938; Henders. J. Mal. Br. R. As. Soc. 17:55. 1939.

ELAEOCARPACEAE

Elaeocarpus pedunculatus Wall., Cat. (1831) 2678; Hk.f., F.B.I. 1:408. 1875; Ridl. Fl., 1:316. 1922; Corner, Gard. Bull. S.S. 10:313. 1939.

Common on the lowlands and hills to 1100 m, especially on rocky cliffs near the sea. Recorded once on limestone from the summit of Gua Batu, Selangor. (Chin 1262).

ERICACEAE

Leaves opposite, often in 4–5-merous pseudowhorls; nerves 5–6 pairs, spaced out. Flowers in umbels *Rhododendron longiflorum*
Leaves spiral, not in pseudowhorls; nerves 3–5, basal or suprabaasal. Flowers in racemes *Vaccinium littoreum*

Rhododendron longiflorum Lindl., J. Hort. Soc. Lond. 3:88. 1846; Sleumer, Fl. Mal. I, 6:641. 1966; Stone, M.N.J. 24:93. 1971.

R. orion Ridl. var. *aurantiacum* Ridl., Fl. 2:217. 1923; Henders., Gard. Bull. S.S. 4:280. 1928.

It has been recorded once on limestone, 'in crevices', on the dome of Bukit Takun, Selangor (Stone 5887).

This is the only *Rhododendron* from limestone, but I have not been able to relocate this plant (originally collected on the 11th July 1965).

Vaccinium littoreum Miq., Fl. Ind. Bat. Suppl. 1:251, 587. 1860; Sleumer, Fl. Mal. I, 6:854. 1967.

V. hasseltii Miq., in Ridl., Fl. 2:209. 1923, incl. var. *sabuletorum* Ridl. l.c. 210; Henders., J. Mal. Br. R. As. Soc. 17:53. 1939.

Epiphytic or terrestrial, often near the coast. Also recorded from dry limestone cliffs on Bukit Takun, Selangor and Gua Panjang, Kelantan, and observed on Bukit Anak Takun, Selangor.

ERYTHROXYLACEAE

Erythroxylum cuneatum (Miq.) Kurz, J. As. Soc. Beng. 43:135. 1847; Ridl., Fl. 1:325. 1922; Payens, Fl. Mal. I, 5:548. 1958; Cockburn, Tree Fl. Mal. 1:194. 1972.

Common in lowland forest, often near beaches and rivers on sandy or rocky soils. Not uncommon on limestone in the central part of the country; usually a shrub to small tree, 2-7 m, on thin soil on slopes and summits of dry hills.

EUPHORBIACEAE — INTRODUCTORY KEY

The numbers on the right hand side refer to the numbers in the main key with which one should continue.

1. A cactus-like plant. *Euphorbia antiquorum*
- 1' Otherwise.
 2. Climbers or scramblers 3
Mallotus repandus,
Phyllanthus ridleyanus,
Bridelia stipularis,
Cnesmone spp.
 - 2' Herbs or subshrubs, less than 60 cm tall 9
Phyllanthus filicifolius,
P. pulcher, *Leptopus*
australis, *Euphorbia*
hirta, *Acalypha lanceolata*.
 - 2'' Shrubs or trees, more than 60 cm tall.
 3. Twigs and branches with coarsely fissured corky bark; very distinctive 13
Sauropus suberosus
 - 3' Otherwise.
 4. Leaves peltate 15
Endospermum diadenum
(sapling only)
Macaranga tanarius,
Mallotus peltatus.
 - 4' Leaves not peltate
 5. Leaves opposite 18
Blumeodendron kurzii,
Erismanthus obliquus,
Mallotus spp.,
Excoecaria oppositifolia
Trigonostemon aurantiacus
 - 5' Leaves alternate or spiral.
 6. Leaves distichously alternate, forming leafy twigs resembling pinnate leaves 29
Glochidion spp. *Phyllanthus*
spp., *Sauropus* spp. *Breynia*
vitis-idea.
 - 6' Otherwise.

- 7. Twigs and lower surface of leaves with stellate hairs, scales or glandular granules 41
 - Mallotus philippensis,*
Melanolepis glandulosa,
Endospermum diadenum,
Aleurites moluccana, Homonoia riparia, Croton spp.,
Cladogynos orientalis,
Koelodepas longifolium,
Sumbaviopsis albicans.

- 7' Twigs and lower surface of leaves not so covered.
 - 8. Leaf bases mostly asymmetrical 53
Drypetes spp.
 - 8' Leaf bases symmetrical.
 - 9. Flowers in axillary clusters.
 - 10. Calyx valvate.
 - 11. Ovary 2-loculate. Fruit drupaceous.
Bridelia spp.
 - 11' Ovary 3-loculate. Fruit capsular 59
Cleistanthus spp.
 - 10' Calyx imbricate 68
Microdesmis caseariifolia,
Trigonostemon aurantiacus,
Actephila spp.
 - 9' Flowers in expanded inflorescences.
 - 12. Male flower with petals 72
Agrostistachys gaudichaudii,
Trigonostemon spp.
 - 12' Male flowers without petals.
 - 13. Male calyx of 2 appressed sepals.
Leaves triangular to ovate 76
Homalanthus populneus
 - 13' Male calyx otherwise.
 - 14. Male calyx flattened from above downwards. Twigs and branches with coarsely fissured corky bark 77
Sauropus suberosus
 - 14' Male calyx otherwise.

15. Calyx lobes valvate 79
Cleidion javanicum, *Alchornea rugosa*, *Claoxylon longifolium*
Mallotus spp., *Sapium insigne*
- 15' Calyx lobes imbricate 83
Antidesma spp., *Aporusa stellifera*, *Baccaurea lanceolata*,
Richeriella malayana.

EUPHORBIACEAE — MAIN KEY

1. A cactus-like plant to 8 m. Branches 3–6 angled, succulent, thorny; Perlis and Langkawi *Euphorbia antiquorum*
 Plant otherwise 2
2. Climbers or scramblers 3
 Herbs, subshrubs, shrubs or trees; not climbing 8
3. Leaf base narrowed, cuneate or broadly cuneate 4
 Leaf base broad, rounded or cordate 5
4. Petioles 1–2 cm, leaves with a prominent pair of veins at the base of midrib, usually pubescent below, margin undulate-denticulate. Flowers in elongate inflorescences *Mallotus repandus*
 Petioles less than 0.5 cm, leaves with no prominent basal pair of veins, glabrous, margin entire. Flowers in axillary clusters ... *Phyllanthus ridleyanus*
5. Stout woody scrambler or small tree. Flowers usually on the leafless ends of twigs; in clusters *Bridelia stipularis* (sometimes)
 Slender twiggy climber. Flowers in slender racemes 6
6. Branches 0.4–0.5 cm in diameter. Leaves large 9–20 by 4.5–10 cm, base deeply cordate *Cnesmone javanica*
 Branches more slender. Leaves smaller, 3–7.5 by 3–5 cm, base slightly to distinctly cordate 7
7. Stipules persistent. Leaves slightly peltate or not. Male and female flowers on separate inflorescences. Gua Batu, Selangor and Gunong Pondok, Perak *Cnesmone subpeltata*
 Stipules deciduous. Leaves never peltate. Male and female flowers on the same inflorescence. Only Langkawi, Kedah *Cnesmone laevis*
8. Herbs or subshrubs, less than 60 cm tall 9
 Shrubs or trees, usually much more than 60 cm 13
9. Leaves alternate, in 2 ranks, forming sprays resembling pinnate leaves; glaucous on the underside 10
 Not so 11
10. Leaves obovate to orbicular. Sepals obovate, shallowly laciniate
 *Phyllanthus filicifolius*
 Leaves oblong. Sepals ovate, deeply laciniate *Phyllanthus pulcher*

11. Margin of leaves serrated or crenate. Capsules less than 0.3 cm across ... 12
 Margin of leaves entire. Capsules about 0.4 cm across ... *Leptopus australis*
12. Leaves opposite, plant with copious milky sap; inflorescence axillary. Weed *Euphorbia hirta*
 Leaves spiral, plant with no milky sap; inflorescence terminal *Acalypha lanceolata*
13. Twigs and branches with coarsely fissured corky bark, obvious about 5 leaves from the tip; very striking and distinctive in twigs more than 0.5 cm across *Sauropus suberosus* (sometimes)
 Not as above 14
14. Leaves at least 0.5 cm peltate 15
 Leaves not or only minutely peltate 17
15. Leaves stellate hairy below *Endospermum diadenum* (sapling only)
 Leaves not stellate hairy 16
16. Leaves broadly ovate to orbicular 8–25 cm across, about as long as broad. Fruits sticky glandular with soft spines about 1 cm long *Macaranga tanarius*
 Leaves ovate-oblong, 8–20 by 5–10 cm. Fruit sticky glandular spines short *Mallotus peltatus*
17. Leaves opposite, subopposite or predominantly opposite, sometimes one of a pair missing, aborted or undeveloped 18
 Leaves alternate or spiral 28
18. Leaves in whorl-like clusters; tertiary veins and reticulations forming a minute sunken pattern below *Blumeodendron kurzii*
 Not as above 19
19. Both leaves of a pair the same size 20
 One of each pair slightly, but distinctly or drastically reduced 25
20. Base of leaf strongly unequally heart-shaped *Erismanthus obliquus*
 Base of leaf different 21
21. Twigs, leaf stalks and the lower surface of leaves densely tomentose. Bases of leaves rounded or weakly cordate *Mallotus eriocarpus*
 Twigs, leaf stalks and the lower surface of leaves glabrous or glabrescent. Bases of leaves cuneate to rounded 22
22. Margin of leaves entire. Leaves ovate-elliptic, petioles slender, to 12 cm long *Mallotus wrayi*
 Margin of leaves subserrate to serrate or crenate 23
23. All leaves opposite, elliptic, margin subserrate. Stamens 30–40. Plant with no milky sap *Mallotus bracteatus*
 Leaves frequently subopposite or spiral. Stamens 3–5. Plant with or without milky sap 24

24. Plant with copious milky sap. Leaves ovate oblong, margin serrate. Flowers on axillary spikes. No petals *Excoecaria oppositifolia*
 No milky sap. Leaves ovate to elliptic. Female spikes to 20 cm. Male flowers in short stalked clusters. Petals present ... *Trigonostomon aurantiacus*
25. One of each pair of leaves drastically reduced; broadly ovate, 0.6–2 cm across, the other 8–20 cm long *Mallotus miquelianus*
 Not so drastically reduced 26
26. Pedicel very short, 0.2–0.3 cm. Leaves elliptic obovate, tapered to the base, slightly cordate *Mallotus brevipetiolatus*
 Pedicel 1–5 cm 27
27. Twigs, leaf stalks and the undersurface of leaves more or less densely pubescent. Twigs somewhat flattened. Stipules and bracts persistent *Mallotus dispar*
 Twigs, leaf stalks and the undersurface of leaves glabrous or glabrescent. Twigs rounded *Mallotus cuneatus*
28. Leaves distichously alternate, forming leafy twigs resembling pinnate leaves. (two *Sauropus* spp. in which this is not clear on herbarium sheets also come under lead 40) 29
 Leaves otherwise arranged 40
29. Leaf base very asymmetrical, leaves pubescent 30
 Leaf base symmetrical or sometimes slightly asymmetrical, leaves pubescent or not 31
30. Styles fused into a column, persistent on fruit *Glochidion obscurum*
 Styles free, spreading *Phyllanthus sikkimensis*
31. Leaves large, more than 5 cm long 32
 Leaves smaller, less than 5 cm long 34
32. Styles fused in a column, about 0.2 cm long, persistent on fruit. Base of leaf slightly unequal *Glochidion perakense*
 Styles free, not fused in a column 33
33. Twigs and branches with coarsely fissured corky bark; obvious in twigs, 0.3 cm across; very striking and distinctive in twigs more than 0.5 cm across. Leaves 12–25 cm long *Sauropus suberosus* (sometimes)
 Twigs and branches with thin bark, smooth. Leaves 7–15 cm long. Flowers in axillary clusters *Sauropus macranthus*
34. Twigs and sometimes leaves finely pubescent or glabrescent 35
 Twigs and leaves glabrous 37
35. Base of leaf slightly cordate twigs finely pubescent to glabrescent. Only from Gua Batu, Selangor *Glochidion rubrum*
 Base of leaf not cordate; twigs densely pubescent 36
36. Leafy twigs crowded in groups; rusty scurfy; leaves about 3 by 1.2 cm *Phyllanthus columnaris*
 Leafy twigs not crowded in groups, soft golden pubescent; leaves slightly larger *Sauropus villosus*

37. Leaves rotundus, about 2.5 by 2 cm., thin with prominent whitish close nerve network. Twigs blackish. Only G. Senyum, Pahang ... *Sauropus calcareus*
Leaves ovate or ovate-elliptic nerves different 38
38. Leaves drying blackish on the upper surface, lower surface glaucous grey *Breynia vitis-idea*
Leaves drying otherwise 39
39. Leaves with rounded apex *Sauropus brevipes*
Leaves with shortly drawn out pointed apex *Phyllanthus oxyphyllus*
40. Twigs and the undersurface of leaves covered with dense or sparse stellate hairs, scales or glandular granules (in *Croton laevifolius*, only on the younger parts) 41
Twigs and the undersurface of leaves glabrous or pubescent but not with stellate hairs, scales or glandular granules 52
41. Undersurface of leaves with glandular granules. Fruits covered with dense carmine scurf *Mallotus philippensis*
Not so covered 42
42. Leaves palmately veined 43
Leaves pinnately veined 45
43. Margin of leaves coarsely toothed *Melanolepis multiglandulosa*
Margin entire 44
44. Leaves usually cordate (leaves of saplings peltate). Petals absent. Fruit to 1.3 cm across *Endospermum diadenum*
Leaves not cordate (leaves of saplings 3-5 lobed, cordate). Petals present. Fruit to 6 cm across *Aleurites moluccana*
45. Lower surface of leaves densely covered by peltate scales, whitish, silvery or bronzed 46
Lower surface of leaves otherwise covered 48
46. Leaves narrow, oblong or lanceolate, about 8 by 1.5 cm ... *Homonoia riparia*
Leaves broader 47
47. Leaves silvery below with conspicuous brown dots, elliptic, 10-17 by 4-6.5 cm *Croton cascarilloides*
Leaves bronze below, not conspicuously dotted, ovate, 10-15 by 3.5-7.5 cm *Croton argyratus*
48. Male flowers in dense spherical stalked heads. Leaves coarsely toothed. Shrub *Cladogynos orientalis*
Male flowers different 49
49. Inflorescence lateral. Flowers without petals. Fruits about 1.3 cm across, orange *Koilodepas longifolium*
Inflorescence terminal. Flowers with or without petals 50

50. Leaves with 2 conspicuous glands at the base of blade 51
 Leaves with no glands *Sumbaviopsis albicans*
51. Lower surface of leaves glabrescent, with stellate hairs on the midrib and young leaves only *Croton laevifolius*
 Lower surface of leaves more or less densely dotted with stellate hairs
 *Croton erythrostachys*
52. Leaf bases mostly asymmetrical, leaves coriaceous, glabrous. Stigma expanded flat. Ovary and fruits fulvous tomentose 53
 Leaf bases symmetrical or nearly so; not with the above combination of characters 54
53. Leaves finely toothed with small spines. Fruits to 4.5 cm across
 *Drypetes oxyodonta*
 Leaves not toothed. Fruits small, about 1.2 cm across *Drypetes nervosa*
54. Flowers in axillary clusters; male flowers with petals (except *Sauropus* spp.) 55
 Flowers in expanded, spike-like or branched inflorescences (except *Cleidion javanicum* where the female flowers are solitary); male flowers without petals (except *Agrostistachys gaudichaudii* and *Trigonostemon* spp.) 71
55. Calyx lobes not overlapping in bud, i.e.: valvate; stamens fused in a column; female disc flask-shaped 56
 Calyx lobes overlapping in bud, i.e.: imbricate; stamens free or fused; disc various 68
 Calyx of male flowers horizontally flat, i.e.: from above downwards, disc-like, lobes sharply inflexed. Female calyx deeply divided
 *Sauropus macranthus* (sometimes)
56. Ovary 2-loculate. Fruit drupaceous 57
 Ovary 3-loculate. Fruit capsular 59
57. Leaves glabrous to glabrescent below, somewhat shiny, margin wavy
 *Bridelia ovata*
 Leaves scurfy to hairy below, dull 58
58. Leaves densely softly tomentose below. Flowers to 1 cm across, usually on leafless ends of twigs. Fruit to 0.6 cm across ... *Bridelia stipularis* (sometimes)
 Leaves weakly scurfy below. Flowers smaller. Fruits smaller
 *Bridelia tomentosa*
59. Leaves glabrous or glabrescent underneath, sometimes pubescent on the midrib 60
 Leaves pubescent underneath, hairs sometimes short and fine 66
60. Leaves distinctly glaucous below 61
 Leaves not glaucous below 62
61. Plant very twiggy, twigs very slender and flexible, completely glabrous. Flowers usually in axis of tiny bracts. Stipules not persistent
 *Cleistanthus gracilis* (sometimes)
 Plant different, tip of twigs pubescent. Flowers usually in the axils of reduced leaves. Stipules persistent *Cleistanthus glaucus*

62. Tertiary veins prominent on the lower surface. Flowers and fruits usually axillary 63
 Tertiary veins faint or not seen. Flowers and fruits often on leafless side shoots 65
63. Leaves 15–20 by 6–9 cm, ovate-elliptic. Fruits 1.5 cm across *Cleistanthus macrophyllus*
 Leaves smaller, elliptic. Fruits about 1 cm across 64
64. Leaf base cuneate, 5–19 by 2.5–8 cm. Fruits stalked *Cleistanthus decurrens*
65. Leaves 2–4 by 1.3–2 cm, elliptic to ovate, somewhat suddenly contracted to a 1–2 cm narrow drip tip *Cleistanthus gracilis* (usually)
 Leaves 4–9 by 1.5–3 cm, elliptic, oblong-ovate or oblong-obovate, tapering gradually to a pronounced tip *Cleistanthus parvifolius*
66. Leaf-base rounded, and usually minutely cordate, stipules persistent 67
 Leaf-base cuneate, stipules deciduous. Leaves ovate to ovate-elliptic, 10–17 by 5–8 cm *Cleistanthus kingii*
67. Secondary veins arising at about 60 degrees to the midrib, strongly curving upwards to margin. Leaves 2–6 by 1–2.5 cm *Cleistanthus polyphyllus*
 Secondary veins arising at about 45 degrees to the midrib, more or less direct to the margin. Leaves 7–10 by 3–4 cm *Cleistanthus hirsutululus* (sometimes)
68. Petals shorter than sepals; ovules 2 per locule. Monoecious 69
 Petals longer than sepals; ovules 1 per locule. Dioecious *Microdesmis caseariiifolia*
69. Flower clusters with both male and female flowers 70
 Flower clusters with only male flowers. Female flowers in spikes *Trigonostemon aurantiacus*
70. Sepals of female flowers large, ovate, 1.5 cm long *Actephila ovalis*
 Sepals of female flowers tiny *Actephila exelsa* var. *acuminata*
71. Male flowers with petals 72
 Male flowers without petals 76
72. Flowers subtended by a chaffy, straw coloured bract. Male flowers 3 to each bract; female, one to each bract. Base of spikes with 6–12 similar, overlapping bracts. Fruits blue-green. Leaves elliptic-lanceolate-obovate, 20–45 by 5–16 cm *Agrostistachys gaudichaudii*
 Flowers not subtended by such bracts. Not with the above combination of characters 73
73. Twigs and the lower surface of leaves dense hairy; rarely only so on midrib *Trigonostemon villosus*
 Twigs and the lower surface of leaves glabrous or glabrescent 74
74. Petiole 0.4–1 cm 75
 Petiole 1.5 cm. Flowers in spikes to 10 cm, with male flowers and a single terminal female *Trigonostemon verticillatus*
75. Inflorescence with male and female flowers, axis filiform, with branches to 5 cm. Female flowers borne terminally *Trigonostemon viridissimus*
 Inflorescence with either male or female flowers, axis stout, rigid. Female flowers on a spike to 23 cm. Male flowers in short clusters *Trigonostemon aurantiacus*

76. Male calyx of 2 sepals; erect and appressed; with 1–2 glands below each flower. Leaves broadly triangular to ovate. Bark with watery milky sap *Homalanthus populneus*
Calyx different. Not with the above combination of characters 77
77. Male calyx flattened from above downwards, dis-like; sepals sharply inflexed. Twigs and branches with coarsely fissured corkky bark; obvious in twig 0.3 cm across, very striking and distinctive in twigs more than 0.5 cm across. Inflorescence 10–30 cm long *Sauropus suberosus* (sometimes)
Calyx and twigs otherwise 78
78. Calyx lobes not overlapping in bud, i.e. valvate 79
Calyx lobes overlapping in bud, i.e. imbricate 83
79. Female flowers in inflorescences 80
Female flowers solitary. Fruit about 2 cm across obscurely or distinctly 2-lobed; styles long and persistent *Cleidion javanicum*
80. Stamens numerous 81
Stamens 8. Plant with no white latex *Alchornea rugosa*
Stamens 2–3. Plant with copious white latex *Sapium insigne*
81. Anther cells diverging from base upwards. Stamens with glands between their bases *Claoxylon longifolium*
Anther cells not diverging from each other 82
82. Petioles with swollen dark knees at both ends. Fruits with fine long bristles *Mallotus griffithianus*
Petioles without swollen knees. Fruits with short stiff spines *Mallotus oblongifolius*
83. Fruits with a single, hard, pitted stone with 1 seed. Stigmas persistent, often off-center 84
Fruits without a stone; wall of fruit may be hard 86
84. Young twigs and the lower surfaces of leaves pubescent; sometimes glabrescent, and pubescent only along the midrib. Fruits 1 by 0.6 cm *Antidesma tomentosum*
Young twigs and the lower surfaces of leaves glabrous or glabrescent 85
85. Inflorescence a simple spike. Leaves small, 4–9 by 1.5–3.5 cm *Antidesma japonicum*
Inflorescence a raceme or panicle. Leaves larger 10–18 by 4–7 cm *Antidesma montanum*
86. Inflorescence more than 3 cm long; often much more 87
Inflorescence a spike under 3 cm long. Fruits ovoid, 1.5 cm long, drying whitish *Aporusa stellifera*
87. Flowers in racemes borne on branches and trunk; disc obscured. Fruits ovoid, juicy, 2.5 cm long *Baccaurea lanceolata*
Flowers in slender axillary panicles, borne on twigs. Disc, of 5 glands alternating with sepals. Fruits a dry capsule about 0.5 cm long *Richeriella malayana*

Acalypha lanceolata Willd., Sp. Pl. 4:524. 1805; Whitmore, Tree Fl. Mal. 2:51. 1972.

A. fallax M.A., in Ridl., Fl. 3:274. 1924.

Actephila excelsa (Dalz.) M.A., Linnaea 32:78. 1863; Ridl., Fl. 3:196. 1924; Henders., J. Mal. Br. R. As. Soc. 17:68. 1939.

var. **acuminata** Airy Shaw, Kew Bull. 26:209. 1971.

Shrub 1–2 m tall. Leaves elliptic-lanceolate, long acuminate, about 9–12 by 2.5–3.5, dull chartaceous, glabrous. Flowers axillary, solitary or several clustered together. Capsule subglobose, 2–3.5 cm across.

Distributed in Peninsular Thailand and Indo-China. In Malaya, uncommon, restricted to limestone and known from near Ipoh, Perak; Gua Batu, Selangor; Gua Jaya and Gua Panjang, Kelantan.

Actephila ovalis (Ridl.) Gage, Rec. Bot. Surv. Ind. Ind. 9:219. 1922; Ridl., Fl. 3:196. 1924; Henders., J. Mal. Br. R. As. Soc. 17:68. 1939; Airy Shaw, Kew Bull. 26:210. 1971.

Agrostistachys gaudichaudii M.A., Linnaea 34:144. 1865; Ridl., Fl. 3:268. 1924; Airy Shaw, Kew Bull. 26:210. 1971; Whitmore, Tree Fl. Mal. 2:52. 1973.

Alchornea rugosa (Lour.) M.A., Linnaea 34:170. 1865; Airy Shaw, Kew Bull. 26:211. 1971; Whitmore, Tree Fl. Mal. 2:53. 1973.

A. javensis (Endl. ex Hassk.) M.A., in Ridl., Fl. 3:278. 1924.

Aleurites moluccana (L.) Willd., Sp. Pl. 4:590. 1805; Ridl., Fl. 3:253. 1924; Henders., J. Mal. Br. R. As. Soc. 17:68. 1939; Corner, Way. Trees 1:231. 1952; Airy Shaw, Kew Bull. 26:231. 1971.

A coastal tree, widely cultivated in Malaya. Once from limestone (Chin 560) on Bukit Chintamani, Pahang, collected as a sapling and probably an escape from cultivation; also from Gunong Pondok, Perak (fide Henderson).

Antidesma japonicum Sieb. et Zucc., Abh. Bayr. Akad. Munchen 4:212. 1846; Airy Shaw, Kew Bull. 26:354. 1971; Whitmore, Tree Fl. Mal. 2:59. 1973.

A. gracillium Gage, Rec. Bot. Surv. Ind. 9:227; 1922; Ridl., Fl. 3:227. 1924.

Antidesma montanum Bl., Bijdr. (1825) 1124; Ridl., Fl. 3:231. 1924; Henders. J. Mal. Br. R. As. Soc. 17:69. 1939; Airy Shaw, Kew Bull. 26:358. 1971; Whitmore, Tree Fl. Mal. 2:58. 1973. Including *A. phanerophlebium* Merr., sensu Ridl., in l.c. 230.

Antidesma tomentosum Bl., Bijdr. (1825) 1126; Ridl., Fl. 3:226. 1924; Henders. J. Mal. Br. R. As. Soc. 17:69. 1939; Whitmore, Tree Fl. Mal. 2:55. 1973.

A. longipes Hk.f., in Ridl., l.c. 229.

A. perakense Pax. et Hocm., in Ridl. l.c. 233.

A. persimile Kurz., in Ridl., l.c. 229.

Aporosa stellifera Hk.f., F.B.I. 5:352. 1885; Ridl., Fl. 3:239. 1924; Henders., J. Mal. Br. R. As. Soc. 17:69. 1939.

Endemic, common in lowland and hill forest. Recorded only once from limestone. (Gopeng, limestone rcks, King's collector 7102).

Baccaurea lanceolata (Miq.) M.A., in DC., Prodr. 15:457. 1866; Ridl., Fl. 3:248. 1924; Henders., J. Mal. Br. R. As. Soc. 17:69. 1939; Airy Shaw, Kew Bull. 26:220. 1971; Whitmore, Tree Fl. Mal. 2:65. 1973.

Blumeodendron kurzii, (Hk.f.) J. J. Sm., Meded. Dept. Landbouw 10:463. 1910; Ridl., Fl. 3:281. 1924; Henders., J. Mal. Br. R. As. Soc. 17:69. 1939; Airy Shaw, Kew Bull. 26:224. 1971; Whitmore, Tree Fl. Mal. 2:70. 1973.

Breynia vitis-idaea (Burm. f.) Fisher, Kew Bull. (1932) 65; Airy Shaw, Kew Bull. 26:227. 1971; Whitmore, Tree Fl. Mal. 2:73. 1973.

B. keithii Ridl., in Fl. 3:219. 1924.

B. rhamnoides (Willd.) M.A., in Ridl., Fl. 3:218. 1924.

Bridelia ovata Decne, Nouv. Ann. Mus. Paris 3:484. 1835; Ridl., Fl. 3:184. 1924; Henders., J. Mal. Br. R. As. Soc. 17:69. 1939; Airy Shaw, Kew Bull. 26:229. 1971; Whitmore, Tree Fl. Mal. 2:74. 1973.

Bridelia stipularis (L.) Bl., Bijdr. (1825) 597; Ridl., Fl. 3:183. 1924; Airy Shaw, Kew Bull. 26:230. 1971; Whitmore, Tree Fl. Mal. 2:74. 1973.

Bridelia tomentosa Bl., Bijdr. (1825) 597; Ridl., Fl. 3:184. 1924; Henders., J. Mal. Br. R. As. Soc., 17:69. 1939; Airy Shaw 26:231. 1971; Whitmore, Tree Fl. Mal. 2:74. 1973.

Cladognos orientalis Zipp. ex Span., Linnaea 15:249. 1841; Ridl., Fl. 3:276. 1924; Henders., J. Mal. Br. R. As. Soc. 17:69. 1939; Airy Shaw, Kew Bull. 26:232. 1971; Whitmore, Tree Fl. Mal. 2:78. 1973.

Shrub to 3 m tall. Leaves alternate, ovate-elliptic, coarsely toothed, upper surface glabrous, lower surface densely white or off white stellate pubescent, 8–25 by 4–9 cm. Male flowers in small dense, stalked axillary heads; female solitary; no petals. Capsule 0.5–0.7 cm long, subglobose, splitting, leaving a central column.

Distributed in S. China, Indo-China, Philippines, Java and Lesser Sunda Islands. In Malaya, uncommon, near or on limestone only in Kedah, Kelantan, Pahang and Perak.

Claoxylon longifolium (Bl.) End. ex Hassk., Cat. Pl. Hort. Bogor. Cult. Alter (1844) 235; Ridl. Fl. 3:272. 1924; Henders., J. Mal. Br. R. As. Soc. 17:69. 1939; Airy Shaw, Kew Bull. 26:234. 1971; Whitmore, Tree Fl. Mal. 2:79. 1973, including *C. longifolium* var. *brachystachys* Hk.f., F.B.I. 5:411. 1887.

Cleidion javanicum Bl., Bijdr. (1825) 613; Ridl., Fl. 3:296. 1924.

Cleidion spiciflorum sec. Merr., Interpr. Rumph. Herb. Amboin. (1917) 322; Whitmore, Tree Fl. Mal. 2:79. 1973.

Rare. In lowland forest; often on lower parts of limestone hills in Kelantan and Selangor.

Cleistanthus decurrens Hk.f., F.B.I. 5:278. 1887. Ridl., Fl. 3:191. 1924; Henders., J. Mal. Br. R. As. Soc. 17:69. 1939; Airy Shaw, Kew Bull. 26:236. 1971.

Cleistanthus glaucus Jabl., Pflanz. 4:25. 1915; Ridl., Fl. 3:188. 1924; Henders., J. Mal. Br. R. As. Soc. 17:69. 1939; Whitmore, Tree Fl. Mal. 2:80. 1973.

Endemic and rare. Known from limestone in Gopeng, Perak and once from Lumut (not limestone).

Cleistanthus gracilis Hk.f., F.B.I. 5:277. 1887; Ridl., Fl. 3:190. 1924, including var. *parvifolia* Ridl., Henders., J. Mal. Br. R. As. Soc. 17:70. 1939; Airy Shaw, Kew Bull. 26:236. 1971.

Cleistanthus hirsutululus Hk.f., F.B.I. 5:278; Ridl., Fl. 3:192. 1924; Henders., J. Mal. Br. R. As. Soc. 17:70. 1939; Airy Shaw, Kew Bull. 26:237. 1971; Whitmore, Tree Fl. Mal. 2:81. 1973.

Cleistanthus kingii Jabl., Pflanz. 4:40. 1915; Ridl., Fl. 3:193. 1924; Henders., J. Mal. Br. R. As. Soc. 17:70. 1939; Whitmore, Tree Fl. Mal. 2:83. 1973.

Shrub or tree to 20 m, branchlets twiggy. Leaves subcoriaceous, ovate-elliptic, pubescent below, 8–15 by 4–7 cm. Flowers in small axillary clusters. Capsule glabrous, about 0.8 cm across.

Rare endemic. Recorded from limestone in Perak and from seasonal swamp forest in Johore.

Cleistanthus macrophyllus Hk.f., F.B.I. 5:278. 1885; Ridl., Fl. 3:192. 1924; Whitmore, Tree Fl. Mal. 2:81. 1973.

Uncommon, in lowland forest. Rare on limestone.

Cleistanthus parvifolius Hk.f., F.B.I. 5:281. 1885; Ridl., Fl. 3:191. 1924; Henders., J. Mal. Br. R. As. Soc. 17:70. 1939; Whitmore, Tree Fl. Mal. 2:82. 1973.

Tree to 10 m. Leaves thin coriaceous, elliptic-oblong, oblong-ovate or oblong-ovate, glabrous, 4–9 by 1.5–3 cm. Male flowers not known, female flowers apparently solitary. Capsule subglobose, 3-lobed, 0.6–0.8 cm across.

Endemic, known from a single collection from limestone at Gopeng (Perak; King's collector 4540).

Cleistanthus polyphyllus Will., Bull. Herb. Boiss. 5:31. 1905; Ridl., Fl. 3:193. 1924; Whitmore, Tree Fl. Mal. 2:82. 1973.

Cnesmone javanica Bl., Bijdr. (1825) 630. Ridl., Fl. 3:306. 1924; Airy Shaw, Kew Bull. 26:240. 1971; Whitmore, Tree Fl. Mal. 2:83. 1973.

Cnesmone laevis (Rid.) Airy Shaw, Kew Bull. 23:118. 1969; Whitmore, Tree Fl. Mal. 2:83. 1973.

Tragia laevis Ridl., Fl. 3:307. 1924; Henders. J. Mal. Br. R. As. Soc. 17:72. 1939.

Slender twiner, with stinging hairs. Leaves small, triangular-ovate, base truncate or slightly cordate, shallowly serrate, pubescent or glabrescent, 3–7.5 by 3–5 cm. Racemes axillary, male flowers terminal, female at the base. Capsule small, strongly 3-lobed.

Distributed in Peninsular Thailand, restricted to limestone. In Malaya, known only from the Langkawi limestone.

Cnesmone subpeltata Ridl., Kew Bull. (1923) 368; Fl. 3:307. 1924; Henders., J. Mal. Br. R. As. Soc. 17:70. 1939; Whitmore, Tree Fl. Mal. 2:83. 1973.

Slender climber, softly pubescent all over. Leaves ovate-oblong or oblong, base truncate or slightly cordate; some, slightly peltate, membranous, margin shallowly sinuate-dentate, 3–7.5 by 3–5 cm. Stipules persistent, reflexed, triangular. Male racemes slender, axillary, 5–7 cm long. Female flowers separate, on a short peduncle 1.5–2 cm, long axis of which is abortive, after producing one flower. Sepals 3, large, ovate, 0.7–1.1 cm long, persistent. Styles 3, spreading out horizontal, each 0.3–0.4 cm long, bearing numerous papillae about 0.1 cm long. Capsule softly pubescent, yellow when matured; about 0.8 cm across.

Endemic, recorded only from Gunong Pondok, Perak and Gua Batu, Selangor. Not uncommon on the North East summit of Gua Batu, on the dry rocky slope.

Croton argyratus Bl. (sensu lato), Bijdr. (1825) 602; Ridl., Fl. 3:243. 1924; Henders., J. Mal. Br. R. As. Soc., 17:70. 1939; Airy Shaw, Kew Bull. 26:243. 1971; Whitmore, Tree Fl. Mal. 2:85. 1973.

Croton cascarilloides Raeusch., Nomencl. 3:280. 1797; Airy Shaw, Kew Bull. 16:344. 1963, *ibid.*, 26:244. 1971; Whitmore, Tree Fl. Mal. 2:85. 1973.

C. cumingii M.A., Ridl., Fl. 3:261. 1924; Henders., J. Mal. Br. R. As. Soc. 17:70. 1939.

Croton erythrostachys Hk.f., F.B.I. 5:391. 1885; Ridl., Fl. 3:260. 1924; Whitmore, Tree Fl. Mal. 2:85. 1973.

C. calcicola Ridl., Kew. Bull. (1923) 360; Henders., J. Mal. Br. R. As. Soc. 17:70. 1939.

Croton laevifolius Bl., Bijdr. (1825) 343; Corner, Gard. Bull. S. S. 10:294. 1939; Whitmore, Tree Fl. Mal. 2:85. 1973.

C. confusus Gage, in Ridl., Fl. 3:261. 1924.

C. griffithii Hk.f., F.B.I. 5:392. 1885; Ridl., Fl. 3:261. 1924.

Drypetes nervosa (Hk.f.) P. et H., Pflanz. 4:244. 1922; Ridl., Fl. 3:222. 1924; Whitmore, Tree Fl. Mal. 2:88. 1973.

Tree 10–12 m. Leaves elliptic to elliptic-oblong, glabrous except the midrib below, base unequal, to 15 by 5 cm. Flowers in axillary clusters. Ovary fulvous tomentose. Fruits olong, about 1.2 cm across.

Endemic, known only from one collection (undated and unnumbered) made in Gopeng, Perak, by Scortechini according to Ridley this was from limestone, although this is not stated on the label of this sheet at Singapore.

Drypetes oxyodonta Airy Shaw, Kew Bull. 23:57. 1969; Whitmore, Tree Fl. Mal. 2:87. 1973.

Tree to 10 m. Twigs dull yellow. Leaves elliptic, elliptic-oblong or ovate-lanceolate, 8–18 by 4–7 cm, coriaceous, glabrous; base rounded or truncate cuneate, equal to unequal sided. Margin shortly reflexed, finely toothed with short spines; midrib prominent on the lower surface, dull yellow; petiole 0.3–1 cm. Male sub-sessile, sepals 5, stamens numerous, probably 25–35. Female flowers in axillary clusters, 2–6. Young fruits with stalks 0.5–1 cm long, dense velvety. Fruits subglobose to 4.5 cm across.

Endemic, previously known from two numbers collected at Tembeling, Pahang. Recently collected from limestone in Pahang and Kelantan, it is quite common on the summit of Batu Boh, Kelantan. It is usually found in pockets of soil on slopes of hill with fairly deep soil; the trunk is slender and straight, often only pole size; the wood is hard.

Endospermum diadenum (Miq.) Airy Shaw, Kew Bull. 14:395. 1960; *ibid.* 26:258. 1971.

E. malaccense Benth. ex Muell. Arg., in Ridl., Fl. 3:305. 1924.

E. sp. in Henders., J. Mal. Br. R. As. Soc. 17:70. 1939.

Erismanthus obliquus Wall. ex M.A., in DC., Prodr. 15:1138. 1866; Ridl., Fl. 3:271. 1924; Airy Shaw, Kew Bull. 26:260. 1971; Whitmore, Tree Fl. Mal. 2:95. 1973.

Euphorbia antiquorum L., Sp. Pl. (1753) 450; Ridl., Fl. 3:180. 1924; Henders., J. Mal. Br. R. As. Soc. 17:70. 1939; Airy Shaw, Kew Bull. 26:262. 1971.

Spiny succulent shrub or small tree to 7 m. Branches 3–6 angled, with pairs of brown spines along the angles. Leaves few and small, obovate-oblong, deciduous. Flowers in dense cymes about 1 cm across above the pair of spines.

Distributed in S. India, Ceylon, Burma, Thailand and Indochina. Wild on the limestone of Perlis and Langkawi, occasionally cultivated throughout the country. Fairly common on the limestone islands of Langkawi.

Euphorbia hirta L., Sp. Pl. (1753) 454; Ridl., Fl. 3:181. 1924; Henders., J. Mal. Br. R. As. Soc. 17:70. 1939; Airy Shaw, Kew Bull. 26:264. 1971.

Excoecaria oppositifolia Griff., Cal. J. Nat. Hist. 4:386. 1844; Henders., J. Mal. Br. P. As. Soc. 17:70. 1939; Airy Shaw, Kew Bull. 26:270. 1971; Whitmore, Tree Fl. Mal. 2:96. 1973.

Shrub or tree to 10 m, with white latex. Leaves spiral or opposite oblong-elliptic or oblong-ovate, sharply to obscurely serrulate, laxly and strongly nerved, 15–23 by 5–10 cm. Flowers on short axillary spikes, petals none. Fruit a small 3-lobed capsule.

Distributed in Indochina, Burma and Thailand. Restricted to limestone in Malaya, not common; recorded from Langkawi, Gunong Pondok, Perak and Gua Teja, Kelantan.

Glochidion obscurum (Roxb. ex Willd.) Bl., Bijdr. (1825) 585; Ridl., Fl. 3:208. 1924; Henders., J. Mal. Br. R. As. Soc. 17:70. 1939; Airy Shaw, Kew Bull. 26:279. 1971; Whitmore, Tree Fl. Mal. 2:99. 1973.

Glochidion perakense Hk.f., F.B.I. 5:317. 1885; Ridl., Fl. 3:213. 1924. Airy Shaw, Kew Bull. 26:279. 1971; Whitmore, Tree Fl. Mal. 2:101. 1973.

G. glaberrimum Ridl., Fl. 3:208. 1924.

Glochidion rubrum Bl., Bijdr. (1825) 586; Airy Shaw, Kew Bull. 26:279. 1971; Whitmore, Tree Fl. Mal. 2:101. 1973.

G. leiostylum Kurz., Ridl., Fl. 3:212. 1924.

G. laevigatum var. *cuspidatum* Ridl., l.c. 215.

G. sp. in Henders., J. Mal. Br. R. As. Soc. 17:71. 1939.

Shrub or small tree to 6 m. Leaves ovate-elliptic or oblong-lanceolate, base round or shortly acute, 4–6.3 by 1.2–2.4 cm. glabrous. Twigs pubescent. Flowers in axillary clusters, males with pedicels about 0.5 cm long; females sessile. Capsule 0.5–0.7 cm across, seeds red.

Distributed in Burma, Indochina, throughout W. Malesia to Moluccas and Lesser Sunda Islands. A common and variable plant in Malaya, often on low lying ground in forest fringes. What appears to be an extreme form of this species has been recorded from the Selangor limestone; it is fairly common on Bukit Takun and Gua Batu. The twigs vary from pubescent to glabrescent or glabrous; the leaves are generally smaller, usually 2–3.5 by 1.1–1.5 cm, base very often cordate and slightly asymmetrical. I have so far only seen it as a shrub 1–2 m tall.

Homalanthus populneus (Geisel.) Pax, in Engl. et Prantl., Nat. Pflanzenfam. 5:96. 1890; Airy Shaw, Kew Bull. 21:409. 1968, *ibid.* 26:281. 1971; Whitmore, Tree Fl. Mal. 2:102. 1973.

Not uncommon in Malaya, mainly in the mountains but also around limestone in the lowlands.

Homonoia riparia Lour., Fl. Cochinch. (1790) 637; Ridl., Fl. 3:309. 1924; Corner, Way. Trees, 1:282. 1952; Airy Shaw, Kew Bull. 26:282. 1971; Whitmore, Tree Fl. Mal. 2:103. 1973.

A plant of rocky and gravelly stream beds, common from Kuala Lipis northwards. Recorded once from limestone, but not known whether it was from a streamside locale.

Koilodepas longifolium Hk.f., F.B.I. 5:420. 1887; Ridl., Fl. 3:275. 1924, (as *Coelodepas*); Airy Shaw, Kew Bull. 26:284. 1971; Whitmore, Tree Fl. Mal. 2:104. 1973.

Coelodepas glanduligerum Pax & Hoffm., in Ridl. l.c. 275.

Leptopus australis (Zoll. et Mor.) Pojarkova, Not. Syst. Herb. Inst. Bot. Acad. Sc. USSR 20:270. 1960; Airy Shaw, Kew Bull. 26:285. 1971; Whitmore, Tree Fl. Mal. 2:105. 1973.

Andrachne australis Zoll. et Mor., Nat. Gen. Arch. Neerl. Ind. 2:17. 1845; Ridl., Fl. 3:197. 1924; Henders., J. Mal. Br. R. As. Soc. 17:68. 1939.

Sub-shrub, 15–50 cm. Leaves membranous, ovate to elliptic, 4.5–7 by 2–4 cm, sparsely and finely pubescent, on the lower surface. Flowers axillary, male clustered; female solitary, sepals 5–6, petals 5–6 or 0, stamens 5–6. Sepals large in the female flower, enlarging in fruit, to 0.5 cm long.

Distributed in Indochina, Thailand, Java and Philippines. Restricted to limestone in Malaya, widely distributed but not very common.

Macaranga tanarius (L.) M.A., in DC., Prodr. 15:997. 1866; Ridl., Fl. 3:302. 1924; Henders., J. Mal. Br. R. As. Soc. 17:71. 1939; Corner, Way. Trees, 1:268. 1952; Whitmore, M.N.J. 20:94, 99. 1967, Tree Fl. Mal. 2:111. 1973; Airy Shaw, Kew Bull, 26:291. 1971.

Common in open country in Malaya; often as a pioneer species in waste ground. Collected from limestone only on disturbed areas; a secondary element.

Mallotus bracteatus Hk.f., F.B.I. 5:436. 1885; Ridl., Fl. 3:286. 1924; Whitmore, Tree Fl. Mal. 2:115. 1973.

Shrub or small tree to 5 m. Leaves elliptic, weakly toothed, underside glabrescent, 15–17 by 7 cm. Male racemes slender 5–7.5 cm, female flowers apparently unknown.

Endemic and very rare. According to Ridley, l.c. known only from Scortechini's collection made in Perak. Whitmore, l.c. mentioned this species as from limestone and recorded from Perlis and Perak, and very rare. Ridley l.c. wrote, "I have only seen a very poor specimen, but in its nearly glabrous habit, shape of leaves, and stamens number and form, it seems quite distinct from *M. leucocalyx* M.A., to which Pax refers it". (sic.)

M. leucocalyx M.A. is now *M. dispar* (Bl.) M.A. According to Ridley *M. bracteatus* Hk.f. has 30–40 stamens, the anther-cells are globose and separated by a broad connective. Accepting Ridley's description, which is the same as Hooker's, l.c. *M. bracteatus* Hk.f. is distinct from *M. dispar* (Bl.) M.A. Although I have not seen the type, or any other specimen labelled as *M. bracteatus* Hk.f., I have seen and examined a large number of specimens of *M. dispar* (Bl.) M.A. This has 30–50 stamens; the anthers and connective are as described for *M. bracteatus* Hk.f. The leaves vary from elliptic, ovate-elliptic, to obovate-elliptic and thus cover the leaf shape of *M. bracteatus* Hk.f. which has been described as elliptic or elliptic-oblong. Perhaps then the only outstanding character exclusive to *M. bracteatus* Hk.f. is its glabrescent habit. This does not seem to be a strong character, and I am inclined to agree with Pax & Hoffmann (in Engl., Pflanz. 7:150. 1914) in referring it to *M. leucocalyx* M.A., i.e. = *M. dispar* (Bl.) M.A.

Mallotus brevipetiolatus Gage, Rec. Bot. Surv. Ind. 9:242. 1922; Ridl., Fl. 3:287. 1924; Airy Shaw, Kew Bull. 21:393. 1968, *ibid.*, 26:293. 1971; Whitmore, Tree Fl. Mal. 2:114. 1973.

Small tree to 8 m. Leaves opposite, slightly unequal, glabrous, elliptic or oblanceolate, base cuneately narrowed, sometimes slightly cordate, margin distantly notched, 7–18 by 3–6 (–8.5) cm. Dioecious. Male, in spike like racemes 7–10 cm long, flowers in clusters. Female in similar racemes, not clustered. Fruit, depressed, 3-lobed, about 1.5 cm across, with sparse short spines.

Distributed in Peninsular Thailand. In Malaysia from Perak, Pahang and Kedah; always from limestone; common on the Perak hills.

Mallotus cuneatus Ridl., J. Str. Br. R. As. Soc. 59:181. 1911, Fl. 3:288. 1924; Henders., J. Mal. Br. R. As. Soc. 17:71. 1939; Airy Shaw, Kew Bull. 21:389. 1968; *ibid.* 26:294. 1971; Whitmore, Tree Fl. Mal. 2:115. 1973.

Shrub to 3 m. Leaves opposite, unequal, obovate, coarsely toothed, 10–17 by 5–10 cm, base trinerved. Dioecious. Male racemes about 12 cm long, female shorter. Capsules 3-lobed, about 0.6 cm across, pubescent.

Distributed in Indochina and Thailand. In Malaya, only from Perlis and restricted to limestone.

Mallotus dispar (Bl.) M.A., in DC., Prodr. 15:971. 1866; Ridl., Fl. 3:286. 1924; Henders., J. Mal. Br. R. As. Soc. 17:30, 70. 1939; Airy Shaw, Kew Bull. 21:380. 1968; *ibid.* 26:303. 1971; Whitmore, Tree Fl. Mal. 2:115. 1973.

M. leucocalyx M.A., in DC., Prodr., 15:970. 1886; Pax et Hoffm., in Engl., Pflanz. 7:150. 1914; Ridl., l.c. 286. Henders., l.c. 71.

Shrub or small tree to 5 m. Stems, petioles, the undersurface of leaves and inflorescences densely fulvous-tomentose. Leaves opposite in unequal pairs, elliptic, ovate-elliptic or obovate elliptic. Dioecious. Male racemes 6–13 cm long. Female racemes 4–7 cm long. Capsules, softly spiny, 3-lobed, about 0.8 cm across.

Distributed in Indochina and throughout W. Malesia. In Malaya, only from north of Kuala Lumpur, usually but not exclusively from limestone; widely scattered and found on many hills, usually near the bases and on slopes.

Mallotus eriocarpus (Thw.) M.A., Linnaea 34:194. 1865; Whitmore, Tree Fl. Mal. 2:115. 1973.

Coelodiscus montanus M.A., in Ridl., Fl. 3:280. 1924.

Mallotus griffithianus, (M.A.) Hk.f., F.B.I. 5:433. 1886; Ridl., Fl. 3:291. 1924; Henders., J. Mal. Br. R. As. Soc. 17:71. 1939; Whitmore, Tree Fl. Mal. 2:116. 1973.

Common throughout Malaya in lowland forest. Recorded for limestone only from Gopeng. (King's collector 4602).

Mallotus miquelianus (Scheff.) Boerl., Handl. Fl. Ned. Ind. 3:290. 1900; Airy Shaw, Kew Bull. 26:295. 1971; Whitmore, Tree Fl. Mal. 2:114. 1973.

M. anisophyllus Hk.f., in Ridl., Fl. 3:293. 1924.

Shrub or small tree to 4.5 m. Leaves in pairs, 1 of each pair reduced, suborbicular to 2 cm across, cordate, the other 12–30 cm long, elliptic-oblong or elliptic-obovate, margin coarsely toothed. Male racemes 1–2.5 cm long. Female flowers few on very short racemes. Capsules small, 3-lobed, with short dark tubercles.

Distributed in West Malesia, uncommon in Malaya in lowland forest. Recorded from limestone in Kelatan, it is fairly common though never abundant or conspicuous on limestone around Gua Musang.

Mallotus oblongifolius (Miq.) M.A., *Linnaea* 34:192. 1865; Ridl., *Fl.* 3:293. 1924; Airy Shaw, *Kew Bull.* 26:306. 1971; Whitmore, *Tree Fl. Mal.* 2:116. 1973.

M. porterianus M.A. in Ridl., l.c. 292; Corner, *Way Trees* 1:273. 1952.

M. puberulus Hk.f. in Ridl. l.c. 290.

Mallotus peltatus (Geisel.) M.A., *Linnaea* 34:187. 1865; Corner, *Way Trees* 1:272. 1952; Airy Shaw, *Kew Bull.* 26:307. 1971; Whitmore, *Tree Fl. Mal.* 2:113. 1973.

Mallotus acuminatus (Bl.) M.A. in Ridl., *Fl.* 3:290. 1924.

Mallotus philippensis (Lam.) M.A. (corr. Merr.), *Linnaea* 34:196. 1865; Ridl., *Fl.* 3:291. 1924; Henders., *J. Mal. Br. R. As. Soc.* 17:71. 1939; Corner, *Way Trees* 1:272; 1952; Airy Shaw, *Kew Bull.* 21:392. 1968, *ibid.* 26:300. 1971; Whitmore, *Tree Fl. Mal.* 2:115. 1973.

Mallotus repandus (Willd.) M.A., *Linnaea* 34:197. 1865; Ridl., *Fl.* 3:292; 1924; Airy Shaw, *Kew Bull.* 26:301. 1971; Whitmore, *Tree Fl. Mal.* 2:114. 1973.

Mallotus wrayi King ex Hk.f., in *F.B.I.* 5:433. 1885; Ridl., *Fl.* 3:287. 1924; Henders., *J. Mal. Br. R. As. Soc.* 17:71. 1939; Whitmore, *Tree Fl. Mal.* 2:115. 1973.

M. lancifolius Hk.f., l.c. 434, Ridl., l.c. 287.

Kunstlerodendron cuspidatum Ridl., *Fl.* 3:283. 1924.

Melanolepis multi glandulosa (Reinw. ex Bl.) Reichb. f. et. Zoll., *Verhand. Nat. Ver. Ned. Ind.* 1:22. 1856; Ridl., *Fl.* 3:284. 1924; Airy Shaw, *Kew Bull.* 26:309. 1971; Whitmore, *Tree Fl. Mal.* 2:118. 1973.

Microdesmis casearifolia Planch., in Hk., l.c. *Pl.* (1844) 8. t. 758; Ridl., *Fl.* 3:258. 1924; Henders., *J. Mal. Br. R. As. Soc.* 17:71. 1939; Airy Shaw *Kew Bull.* 26:362. 1971; Whitmore, *Tree Fl. Mal.* 2:119. 1973.

Phyllanthus columnaris M.A., *Linnaea* 32:15. 1863; Hk.f., *F.B.I.*, 5:291. 1885; Henders., *J. Mal. Br. R. As. Soc.* 17:71. 1939; Airy Shaw, *Kew Bull.* 26:318. 1971; Whitmore, *Tree Fl. Mal.* 2:123. 1973.

Small tree to 7 m. Leafy twigs resemble pinnate leaves, rusty scurfy to 23 cm. Leaves 2.5–4.5 by 0.7–1.7, finely scurfy below. Flowers in dense clusters in leaf axils. Fruits 3-lobed, 0.6 cm across.

Distributed in Burmat and Thailand. In Malaya, only from Perlis and Langkawi and probably restricted to limestone.

Phyllanthus filicifolius Gage, *Kew Bull.* (1914) 241; Ridl., *Fl.* 3:201. 1924; Henders., *J. Mal. Br. R. As. Soc.* 17:71. 1939; Whitmore, *Tree. Fl. Mal.* 2:121. 1973.

Shrub. Leaves obliquely obovate to almost round, glabrous, glaucous below 0.4–1 by 0.6 cm. Flowers solitary, axillary, male with 4 sepals, female with 5–7 sepals. Capsule small 0.2–0.3 cm across.

Endemic and known only from Langkawi, usually, but not always from limestone.

Phyllanthus oxyphyllus Miq., Fl. Ind. Bat. Suppl. (1860) 179. 148; Airy Shaw, Kew Bull. 23:29. 1969, *ibid.*, 26:321. 1971; Whitmore, Tree Fl. Mal. 2:123. 1973.

Phyllanthus pulcher Wall. ex M.A., Linnaea 32:49. 1863; Ridl., Fl. 3:210. 1924; Henders., J. Mal. Br. R. As. Soc. 17:71. 1939; Airy Shaw, Kew Bull. 26:322. 1971, Whitmore, Tree Fl. Mal. 2:121. 1973.

Phyllanthus ridleyanus Airy Shaw, Kew Bull. 26:323. 1971; Whitmore, Tree Fl. Mal. 2:123. 1973.

Phyllanthodendron coriaceum Gage, in Ridl., Fl. 3:325. 1924; Henders. J. Mal. Br. R. As. Soc. 17:71. 1939.

Scandent shrub. Leaves elliptic, elliptic-ovate to elliptic-oblong, coriaceous, glabrous, 6–15 by 2.5–7 cm, margin cartilaginous, reflexed; base slightly asymmetric; petioles thick, 0.2–0.3 cm long. Flowers in axillary clusters; sepals with a filiform tip to 0.5 cm long.

Distributed in Peninsular Thailand on limestone. In Malaya, also confined to limestone. Thought to be rare but recent collections show that this is a common species on limestone in Perak, and on Gua Musang, in Kelantan. It is often found growing in rather exposed places, scrambling over rocks and bushes. Easily distinguished by its coriaceous leaves with reflexed cartilaginous margin, the finely longitudinally striate stem which often dries black and the axillary clusters of flowers with filiform sepals to 0.5 cm long. I have not seen any fruits of this species.

Phyllanthus sikkimensis M.A., Linnaea 32:48. 1863; Airy Shaw, Kew Bull. 23:35. 1969, *ibid.*, 26:324. 1971; Whitmore, Tree Fl. Mal. 2:122. 1973.

P. hamiltonianus M.A., in Henders., J. Mal. Br. R. As. Soc. 17:71. 1939.

Richeriella malayana Hend., in Gard. Bull. S. S. 7:122. 1933; J. Mal. Br. R. As. Soc. 17:71. 1939; Whitmore, Tree Fl. Mal. 2:128. 1973.

Endemic and not common. Known from Gunong Pondok and Tambun limestone in Perak; also from non limestone fields in Penang, Trengganu, Malacca and Pulau Tioman.

Sapium insigne (Royle) Benth., Gen. Pl. 3:335. 1880; Whitmore, Tree Fl. Mal. 2:129. 1973.

A small tree with abundant latex. Leaves clustered at the end of twigs, 6–30 cm long, ovate; margin shallowly wavy-toothed. Flowers in spikes. Fruits ovoid, 0.5 cm across.

Distributed from the Himalayas to Burma and South to Malaya.

A very rare plant recently collected from Gua Batu, Selangor (Ng FRI 1626).

Sauropus brevipes M.A., Linnaea 32:73. 1863; Hk.f., F.B.I. 5:335. 1885; Airy Shaw, Kew Bull. 26:334. 1971; Whitmore, Tree Fl. Mal. 2:130. 1973.

S. parvifolius Ridl., Fl. 3:221. 1924; Henders., J. Mal. Br. R. As. Soc. 17:72. 1939.

Sauropus calcareus Henders., Gard. Bull. S. S. 7:121. 1933, J. Mal. Br. R. As. Soc. 17:72. 1939; Whitmore, Tree Fl. Mal. 2:180. 1973.

Small shrub. Leaves thin, broadly oblong ovate, ovate or orbicular, base round or slightly cordate, up to 3 by 2.5 cm. Flowers on short axillary tubercles, sepals 6, petals none. Capsule depressed globose, 0.4–0.5 cm across.

Endemic and known only from a single collection (Gunong Senyum, Pahang, Henderson 22316).

Sauropus macranthus Hassk., Retzia 1:166. 1855; Bak., Fl. Java 1:471. 1963; Airy Shaw, Kew Bull. 26:336. 1971; Whitmore, Tree Fl. Mal. 2:131. 1973.

S. spectabilis Miq., in Ridl., Fl. 3:220. 1924; Henders., J. Mal. Br. R. As. Soc. 17:72. 1939; and probably *S. forcipatus* Hk.f., in Ridl., Fl. 3:220. 1924.

Shrub to 4 m. Leaves ovate-oblong to elliptic-oblong, 7.5–15 by 5–7.5 cm, chartaceous, glabrous. Flowers in axillary clusters. Capsule large, 3-lobed, depressed globose, 2 cm across.

Distributed in N.E. India, S. China, S.E. Asia and throughout Malesia to N. Australia. Known in Malaya from a single specimen from the base of Gua Batu Selangor.

Sauropus suberosus Airy Shaw, Kew Bull. 23:42. 1969, *ibid.*, 26:338. 1971; Whitmore, Tree Fl. Mal. 2:130. 1973.

Shrub 2–3 m, usually slender, erect and sparingly branched. Stem with thick, longitudinally fissured corky bark. Leaves elliptic, elliptic-obovate or obovate-lanceolate, glabrous, thin, 10–25 by 3.5–7.5 cm. Stipules deltoid, 0.2–0.5 cm long. Inflorescence borne on the stem, flagelliform, 10–40 cm long. Male flowers to 0.2 cm across, lobes 6. Female flowers on a pedicel 0.3–0.5 cm long, ovary subglobose, glabrous, 0.15 cm across. Capsule not known.

Distributed in Peninsular Thailand (? limestone). In Malaya, restricted to limestone, so far recorded from Pahang and Perak. Common on Gunong Runto, Lenggong, Perak and on Gua Layang, Pahang. Usually in sheltered localities with fair accumulation of soil.

Sauropus villosus (Blanco) Merr., Contr. Arn. Arb. 8:86. 1934; Airy Shaw, Kew Bull. 23:49. 1969, *ibid.*, 26:339. 1971; Whitmore, Tree Fl. Mal. 2:130. 1973.

S. llanosii (M.A.) Gage, in Ridl., Fl. 3:221. 1924; Henders., J. Mal. Br. As. Soc. 17:30, 72. 1939.

Shrub to 1 m. Leaves with golden pubescence, oblong, 2.5–4.5 by 0.5–2 cm. Stipules setaceous. Flowers axillary, clustered. Capsules depressed-globose, yellow-orange, glabrous, 0.6 cm across.

Distributed in Indochina, Philippines and Sumatra. In Malaya, restricted to Kedah, Perlis, Kelantan and Pahang; usually on limestone.

Sumbaviopsis albicans (Bl.) J.J. Sm., Meded. Dep. Landb. 10:357. 1910; Henders., Gard. Bull. S.S. 7:125. 1933; Airy Shaw, Kew Bull. 14:357. 1960, *ibid.*, 26: 341. 1971; Whitmore, Tree Fl. Mal. 2:132. 1973.

Tree to 10 m. Leaves ovate, 15–27 by 7–15 cm, margin coarsely distantly toothed, lower surface densely stellate pubescent. Inflorescence terminal, densely stellate pubescent, to 30 cm long; female flowers in the lower half, males above. Calyx with 5 lobes. Male flowers with 5 petals, female none. Fruit depressed globose, 3-lobed, densely covered with mealy stellate hairs, about 2.5 cm across.

Distributed in Assam, Burma, Indochina, Thailand and W. Malesia. Restricted to limestone in Malaya and very rare; recorded once from Tembeling, Pahang, in lowland forest to the west of railway station on calcareous soil, (Henderson 24526) in fruit, May. Recently collected (Chin 1088) from Bukit Serdam, Pahang; in fruit, June. The male flowers of the Bukit Serdam specimens that I examined do not possess petals, even in bud.

Trigonostemon aurantiacus (Kurz ex Teijsm. et Binnend.) Boerl. Handl. Fl. Ned. Ind. 3:232. 1900; Airy Shaw, Kew Bull. 23:126. 1969; *ibid.* 26:345. 1971; Whitmore, Tree Fl. Mal. 2:136. 1973.

Actephila aurantiaca Ridl., Fl. 3:197. 1924.

Actephilopsis malayana Ridl., l.c. 252; Henders., J. Mal. Br. R. As. Soc. 17:68. 1939.

Trigonostemon verticillatus (Jack) Pax ex Pax et Hoffm., in Engl., Pflanz. 3:87. 1910; Airy Shaw, Kew Bull. 26:349. 1971; Whitmore, Tree Fl. Mal. 2:136. 1973.

Shrub to 1m. Leave coriaceous oblong or lanceolate, glabrous, 12–17 by 1–2 cm. Racemes axillary to 10 cm. Sepals with ciliated margin. Ovary pubescent 3-lobed. Capsule 0.6 cm across.

Distributed in Peninsular Thailand and Sumatra. According to Ridley l.c. this has been recorded on limestone from Kanching, Selangor.

Trigonostemon villosus Hk.f., F.B.I. 5:397. 1885; Ridl., Fl. 3:265. 1924; Whitmore, Tree Fl. Mal. 2:135. 1973.

Endemic and uncommon, in lowland forest. Once collected from limestone. (Gua Batu, Selangor, Whitmore FRI 752)

Trigonostemon viridissimus (Kurz) Airy Shaw, Kew Bull. 25:545. 1971; Whitmore, Tree Fl. Mal. 2:135. 1973.

Sabia viridissima Kurz, in Hk.f., F.B.I. 2:3. 1879.

T. ovatifolius J.J. Sm., in Bak., Fl. Jav. 1:495. 1963.

Sub-shrub, 0.5–1 m, woody. Leaves elliptic-lanceolate or elliptic-oblong, thinly coriaceous, 8–15(–23) by 2.5–5(–) cm., sparsely pubescent on the veins below. Inflorescence axillary, 7–15 cm long; branches usually, terminating in

a female flower. Sepals 5, about 0.1–0.2 cm long, with short, stiff pale hollow hairs; petals 5, yellow, 0.4 cm long, very early deciduous in the female flowers. Stamens 5, fused and borne on an androphore about 0.1 cm long; disc present, fleshy. Fruits 3-lobed, green, glabrous, about 1.1 cm across.

Distributed in Burma, Andamans, W. Malesia and Indonchina. Rare in Malaya, previously known from a single collection (Strugnell KEP 20275) from W. Pahang, near Raub at Ulu Gali, around hill (probably not limestone). Recently collected from near Raub, on limestone. It is not uncommon on Bukit Serdam, usually in partially exposed localities.

FAGACEAE

- Cupule 1.5 cm across, margin not reflexed *Lithocarpus elegans*
- Cupule large 4.3–5.5 cm across, margin prominently reflexed
- *Lithocarpus urceolaris*

Lithocarpus elegans (Bl.) Hatus. ex Soepadmo, Reinw. 8:236. 1970; Fl. Mal. I, 7:366. 1972.

Pasania spicata Oerst., incl. var. *gracilipes* DC. and var. *microcalyx* (Korth.) Gable, in Ridl., Fl. 3:376. 1924; var. *gracilipes* DC., in Henders., J. Mal. Br. R. As. Soc. 17:74. 1939.

Lithocarpus urceolaris (Jack) Merr., J. Arn. Arb. 33:241. 1952; Soepadmo, Reinw. 8:285. 1970; Fl. Mal. I. 7:344. 1972.

FLACOURTIACEAE

- 1. Flowers in racemes 2
- Flowers in few-many flowered axillary fascicles; sometimes solitary 9
- 2. Racemes less than 6 cm long. Plants often spiny 3
- Racemes more than 6 cm long, sometimes branched. Plants usually not spiny 5
- 3. Flowers bisexual. Stigma single. entire or slightly 2-lobed. Fruit a leathery berry 4
- Flowers unisexual. Stigma 4–6, each 2-lobed. Fruit pulpy. Cultivated, sometimes an escape *Flacourtia jangomas*
- 4. Racemes all simple. Leaves elliptic to elliptic-lanceolate, base broadly cuneate. Not uncommon in the lowlands, sometimes on limestone *Scolopia spinosa*
- Terminal racemes branched. Leaves ovate to ovate-oblong, base broadly rounded. *Scolopia steenisiana* (sometimes)
- 5. Inflorescence a panicle of several-many spicate racemes, or only the terminal raceme branched 6
- Inflorescence a solitary spicate raceme 8
- 6. Fruit large, to 2 cm across, style persistent. Flowers solitary on the axis. Leaves ovate to ovate-oblong *Scolopia steenisiana* (sometimes)
- Fruit small. Flowers in fascicles or solitary. Leaves oblong or ovate-oblong, to elliptic 7

7. Flowers in whorled fascicles; with repulsive odour. Stamens 2 at the base of each petal. Leaves oblong or ovate-oblong, rarely elliptic *Homalium foetidum*
 Flowers laxly arranged. Stamens 4-5 at the base of each petal. Leaves elliptic to oblong-elliptic *Homalium undulatum*
8. Leaves pubescent on the lower surface, or at least on the veins. Leaves thinly chartaceous. From Perak and Langkawi *Homalium dasyanthum*
 Leaves glabrous or nearly so, thickly coriaceous. Only from Kinta, Perak *Homalium kunstleri*
9. Flowers bisexual. Fruits ellipsoid, ribbed when dried, ultimately splitting; seeds with orange-red aril 10
 Flowers unisexual. Fruits usually globose, not splitting; seeds embedded in pulp 11
10. Leaves distinctly prominently-reticulate on both surface. Fruits 1.5-2 by 1 cm *Casearia capitellata*
 Leaves not or obscurely reticulated above, prominent on the lower surface. Fruits (2.5-) 3-4 by 1.7-1.8 cm *Casearia grewiaefolia*
11. Leaves with midrib on the upper surface flat or slightly impressed or sometimes slightly raised 12
 Leaves with midrib on the upper surface prominently raised 13
12. Leaves sub-coriaceous, tertiary nerves fine. Petals 5-7; fruit wall gritty *Hydnocarpus woodii*
 Leaves thickly coriaceous, tertiary nerves thick and prominent. Petals 8; fruit wall fibrous *Hydnocarpus wrayi* (sometimes)
13. Leaf stalk 0.5-1.5 cm, not or obscurely kned at the top only. Leaves slightly serrate *Hydnocarpus ilicifolia*
 Leaf stalk 1.5 cm or more long, kned at both ends 14
14. Leaves distinctly prominently-reticulate on both surfaces; midrib and nerves pubescent beneath. Fruit wall fibrous. Petals 8. *Hydnocarpus wrayi* (sometimes)
 Leaves with faint reticulations on the upper surface; glabrous. Fruit wall with gritty. Petals 5 *Hydnocarpus castanea*

Casearia capitellata Bl., Mus. Bot. 1:254. 1850; Sleumer, Fl. Mal. I, 5:102. 1954; Whitmore, Tree Fl. Mal. 2:141. 1931. *C. latifolia* Ridl., Fl. 1:831. 1922.

Casearia grewiaefolia Vent. Choix (1803) 48; Ridl., Fl. 1:830. 1922; Sleumer, Fl. Mal. I, 5:93. 1954; Whitmore, Tree Fl. Mal. 2:140. 1973.

var. *deglabrata* Koord. & Val., Bijdr. Booms. Java 1:174. 1894; Sleumer, l.c. 95.

C. leucolepis Turcz., in Ridl., Fl. 1:831. -1922.

Flacourtia jangomas (Lour.) Raeusch., Nomencl. Bot. ed. 3:290. 1797; Ridl., Fl. 1:158. 1922; Henders., J. Mal. Br. R. As. Soc. 17:36. 1939; Sleumer, Fl. Mal. I, 5:72. 1954.

Distributed throughout the tropics, as a cultivated plant, not known in the wild state, but possibly originated in India (Sleumer l.c.). Once recorded from limestone in Malaya, most probably as an escape from cultivation.

Homalium dasyanthum (Turcz.) Warb., in Engl. et Prantl., Pfl. Fam. 3:36. 1893; Henders., J. Mal. Br. R. As. Soc. 17:46. 1939; Sleumer, Fl. Mal. I. 5:1954; Whitmore, Tree Fl. Mal. 2:145. 1973.

H. griffithianum Kurz. incl. var. *glabrum* Gagnep.

&var. *cambodianum* Gagnep. in Ridl., Fl. 1:835. 1922.

Homalium kunstleri King, J. As. Soc. Beng. 67:20. 1898; Ridl., Fl. 1:835. 1922; Henders., J. Mal. Br. R. As. Soc. 17:46. 1939; Whitmore, Tree Fl. Mal. 2:145. 1973.

Tree 6–14 m. Leaves subovate to elliptic-oblong, shortly obtusely acuminate, narrowed or mostly rounded at the base; stiffly coriaceous, 11–18 by 6–8 cm. Racemes solitary spicate, 10–15 cm long, flowers in 3–4 flowered fascicles. Sepals and petals about 0.2 cm long. Ovary tomentose, styles 5.

Very rare endemic on limestone, known only from one or two numbers by King's collector from Larut, Perak.

Homalium undulatum King, J. As. Soc. Beng. 67:23. 1898; Ridl., Fl. 837. 1922; Henders., J. Mal. Br. R. As. Soc. 17:46. 1939; Sleumer, Fl. Mal. I. 5:61. 1954; Whitmore, Tree Fl. Mal. 2:145. 1973.

H. verruculosum Craib., Fl. Siam. En. 1:742. 1931.

Tree 10–20 m. Leaves elliptic to elliptic-oblong, subcoriaceous, shallowly crenate, 7–10 by 3–5 cm. Panicle 7–10 cm long, of several racemes. Flowers laxly arranged along the rachis. Ovary tomentose; styles 3.

Distributed in Peninsular Thailand and Malaya, most probably restricted to limestone. In Malaya, collected from Perak and Langkawi only.

Hydnocarpus castanea Hk.f. & Th., F.B.I. 1:197. 1872; Ridl., Fl. 1:159. 1922; Henders., J. Mal. Br. R. As. Soc. 17:36. 1939; Sleumer, Fl. Mal. I. 5:26. 1954; Whitmore, Tree Fl. Mal. 2:149. 1973.

Hydnocarpus ilicifolia King, Ann. R. Bot. Gard. Calc. 5:130. 1896; Ridl., Fl. 1:161. 1922; Henders., J. Mal. Br. R. As. Soc. 17:36. 1939; Sleumer, Fl. Mal. I. 5:19. 1954; Whitmore, Tree Fl. Mal. 2:149. 1973.

Tree 10–30 m., sometimes smaller and bushy. Leaves lanceolate-oblong or oblong; variable in shape, margin entire, dentate or thorny-serrate; 7–15 by 3–5 cm. Cymes corymbose, peduncle about 1.5 cm long, branched once. Flowers unisexual. Fruit globose, rusty to blackish-brown velvety, 4–5(–8) cm diameter.

Distributed in Indochina, Thailand, Sumatra and in Malaya, where it is locally common, and apparently restricted to limestone.

Hydnocarpus woodii Merr., Pl. Elm. Born. (1929) 208; Sleumer, Fl. Mal. I. 5:28. 1954; Whitmore, Tree Fl. Mal. 2:152. 1973.

Hydnocarpus wrayi King., J. As. Soc. Beng. 59:121. 1890; Ridl., Fl. 1:161. 1922; Sleumer, Fl. Mal. I. 5:22. 1954; Whitmore, Tree Fl. Mal. 2:149. 1973.

Scolopia spinosa (Roxb.) Warb., in Engl. et Prantl., Pflanz. Fam. 3:29. 1893; Sleumer, Fl. Mal. I. 5:10. 1954; Whitmore, Tree Fl. Mal. 2:160. 1973.

S. roxburghii Clos. incl. var. *ovata* and var. *lamponga* Boerl. in Ridl., Fl. 1:156. 1922.

Scolopia steenisiana Sleum., *Blumea* 20:34. 1972; Whitmore, *Tree Fl. Mal.* 2:161. 1973. *S. kermodei* auct., non C.E.C. Fisher, in Steen., *Blumea* 17:270. 1969.

Tree 10–15 m tall. Leaves elliptic-ovate, apex abruptly acuminate, base obtuse or rounded, glabrous, 6–10 by 3–5 cm; petiole 0.7–0.9 cm long. Inflorescence 4–6 cm long. Flowers ovate-oblong, about 0.4 cm long, petals similar. Fruits subglobose, when submature about 1.5 cm across.

Endemic and known only from limestone in Kelantan and Bukit Takun in Selangor.

Dubious record

Homalium foetidum (Roxb.) Benth. *J. Linn. Soc. Bot.* 4:37. 1860; Sleumer, *Fl. Mal. I.* 5:57. 1954; Whitmore, *Tree Fl. Mal.* 2:146. 1973.

H. propinquum Cl., in Ridl., *Fl.* 1:835. 1922.

GENTIANACEAE

1. Glabrous herb, leaves opposite; calyx more or less winged 2
 Pubescent herb, leaves mostly alternate; calyx not winged.
 *Microrhaphium pubescens*
2. Leaves with a single midrib; calyx tube about 0.8 cm long.
 *Canscora pentanthera*
 Leaves with 3–5 veins from the base, calyx tube very short or absent
 *Exacum tetragonum*

Canscora pentanthera Clarke., *J. As. Soc. Beng.* 74:86. 1908; Ridl., *Fl.* 2:433. 1923; Henders., *J. Mal. Br. R. As. Soc.* 17:58. 1939; *Mal. Wildfls. Dicots.* (1959) 306.

Herb 30–50 cm tall. Leaves ovate-lanceolate, apex and base narrowed, 3–6 by 2–3 cm, usually with one prominent pair of basal vein. Flowers in small inflorescence with up to 10 flowers, corolla white, calyx papery. Fruit an ellipsoid capsule.

Distributed in Peninsular Thailand. In Malaya collected from most of the limestone hills visited, commonest on dry hills; rarely found away from limestone (recorded from Kedah Peak).

Exacum tetragonum Roxb., *Fl. Ind.* 1:398. 1820; Ridl., *Fl.* 2:432. 1923; Henders., *Mal. Wildfls. Dicots.* (1959) 305.

Microrhaphium pubescens Clarke, *J. As. Soc. Beng.* 74:88. 1908; Ridl., *Fl.* 2:434. 1923; Henders., *J. Mal. Br. R. As. Soc.* 17:58. 1939; *Mal. Wildfls. Dicots.* (1959) 307.

Pubescent herb, 50–90 cm. Leaves broadly elliptic, base tapered, 6–9 by 3–4.5 cm, petioles to 5 cm. Flowers numerous in branched inflorescence to 7 cm. Corolla white. Capsule oval 0.2–0.3 cm long.

Distributed in Peninsular Thailand; in Malaya, restricted to limestone on Langkawi; with one collection (Nur. 25158) from Bukit Sagu in Pahang which is probably a glabrous variety of this.

GESNERIACEAE*

1. Stem slender, sprawling or climbing; often epiphytic. Corolla red or green. Capsules slender 10–30 cm long. Seeds plumed with one or more hairs ... 2
Not a climber; not epiphytic 4
2. Leaves with subsistent pubescence, fleshy, 1.5–3 cm long. Flowers 1–2, usually axillary, red *Aeschynanthus radicans*
Leaves glabrous, coriaceous, 2–5 cm or longer 3
3. Leaves 5–9 cm long, marbled. Calyx-lobes free almost to the base
..... *Aeschynanthus longicaulis*
Leaves about 2.5 cm long, not marbled. Calyx tubular
..... *Aeschynanthus parvifolia*
4. Succulent herb with one large leaf, ovate-cordate; stem unbranched 5
Herbs or subshrubs with several or more leaves 7
5. Leaves glabrous, sepals not spreading in fruit 6
Leaves strigose hairy, sepals spreading in fruit *Monophyllaea hirticalyx*
6. Sepals ovate-obtuse. Common in Perak, Kelantan, Selangor and Pahang. Not recorded from Langkawi *Monophyllaea horsfieldii*
Sepals lanceolate-acute. Recorded only from Langkawi; rare
..... *Monophyllaea glabra*
7. Leaves drastically unequal at the base; alternate or one of a pair suppressed 8
Leaves equal or rarely, asymmetric at the base; in which case in pairs ... 10
8. Leaves crenate or crenulate, stamens 4 9
Leaves entire or wavy, stamens 2. *Rhynchoglossum obliquum*
9. Flowers about 1.2 cm across; corolla not spurred, white with a blue spot in the throat *Stauranthera umbrosa*
Flowers about 3 cm across; corolla spurred, blue with a yellow spot in the throat *Stauranthera grandiflora*
10. Fruit, a fleshy berry, not dehiscent 11
Fruit, a capsule, eventually dehiscent 12
11. Bracts connate into a large cup, enclosing the flowers ... *Cyrtandra cupulata*
Bracts not connate, small lanceolate *Cyrtandra lanceolata*
12. Leaves, the upper surface distinctly different from the lower, usually dark green, glabrous, glabrescent or pubescent; the lower from pale-cinnamon, pale-brown, to white; velvety or dense woolly-pubescent; sometimes in a rosette or culustered, opposite or whorled 13
Leaves, both surface not distinctly different; opposite or alternate, more or less equally spaced 32

* The generous help of B.L. Burtt, Royal Botanic Gardens, Edinburgh, with this family is most gratefully acknowledged.

13. Capsules twisted, very rarely evident only at dehiscence 14
 Capsules not twisted 25
14. Calyx 5-lobed 15
 Calyx 3-lobed. Capsules lanceolate, thick, 2.5–4 by 0.3–0.5 cm. Only from Langkawi *Dichiloboea speciosa*
15. Upper surface of leaves glabrous or glabrescent 16
 Upper surface of leaves pubescent, usually less dense than the lower 21
16. Capsules about 0.6 cm long 17
 Capsules 2–2.5 cm or longer 19
17. Inflorescence 10 cm or more long 18
 Inflorescence short, 1–4 cm long, axillary. Known only from Perak
 *Boea suffruticosa*
18. Inflorescence umbellately branched. Known only from Perak
 *Boea parviflora*
 Inflorescence paniculate. Known only from Kelantan *Boea brachycarpa*
19. Inflorescence terminal, more than 30 cm long 20
 Inflorescence axillary, 10–20 cm long *Boea acutifolia*
20. Corolla small, less than 1 cm across. Leaves crowded, rosette-like
 *Boea divaricata*
 Corolla larger, 2–2.5 cm across. Leaves not arranged rosette-like
 *Boea treubii*
21. Capsule 1 cm or more long 22
 Capsule 0.4 cm long. Leaves sparsely long-pubescent. Panicles lax, spreading. Known only from Pahang *Boea minutiflora*
22. Inflorescence terminal 23
 Inflorescence axillary. Leaves in a rosette, lower surface woolly-pubescent. Only from Langkawi *Boea lanata*
23. Leaves more or less evenly spaced. Panicles with the same colour tomentum as the leaves 24
 Leaves in dense clusters at the top of woody portions of stems; above these clusters, stems with spaced leaves terminate in inflorescences. Panicles with brown tomentum, leaves with white or off-white tomentum
 *Boea paniculata*
24. Tomentum white or off-white. Panicle-branches 2.5–7 cm long. Capsules slender, 1–1.3 cm long *Boea verticillata*
 Tomentum cinnamon-coloured. Panicle-branches 10–15 cm or more long. Capsules 2–3 cm long *Boea caerulescens*
25. Stem 30–45 cm long 26
 Stem very short, leaves crowded 27
26. Inflorescence dichotomously branched. Capsule 1 cm long, protruding beyond the 0.2 cm long calyx. Only from Pahang *Paraboea bettiana*
 Inflorescence not so branched. Capsule 0.6 cm long, more or less enclosed by the calyx. Recorded from Kedah mainland *Ornithoboea flexuosa*

27. Leaves petiolate; petiole 2–15 cm 28
 Leaves sessile with dense, pale brown, silky-pubescence. Peduncles slender, glabrous, to 15 cm long *Paraboea laxa*
28. Leaves blunt-elliptic 29
 Leaves broadly ovate to ovate-orbicular 30
29. Leaves, lower surface with branched reddish-brown hairs. Only from Perak *Paraboea vulpina*
 Leaves, lower surface with straw-coloured hairs. Only from Perlis
 *Paraboea bintangensis*
30. Peduncles with pale brown or cinnamon-coloured hairs 31
 Peduncles with ferruginous hairs; cymes compact scorpiod. Only from Langkawi *Paraboea ferruginea*
31. Petioles to 4.5 cm long. Inflorescence sub-umbellate, flowers few
 *Paraboea bakeri*
 Petioles 5–12 cm long. Inflorescence umbellate and subtended by two broad, 0.6 cm long bracts, flowers numerous *Paraboea capitata*
32. Bracts fused, cup-like 33
 Bracts different 34
33. Capsule small, globose, enclosed within the bracts. Plant viscid pubescent. Common *Epithema saxatile*
 Capsule elongate, to 8 cm; protruding from the bracts. Only from Langkawi
 *Chirita rupestris*
34. Calyx tubular *Chirita lacunosa*
 Calyx divided to the base 35
35. Fringe of clavate hairs in the corolla tube above the position of the anthers present 36
 Fringe of clavate hairs in the corolla tube not present 38
36. Corolla 3–4 cm long 37
 Corolla less than 2 cm long. Anthers with dark spots *Chirita viola*
37. Petiole with glandular hairs; stem glabrescent *Chirita caliginosa*
 Petiole eglandular; stem densely hairy *Chirita sericea*
38. Corolla lobes cream; fruits 1–4 cm long *Chirita hamosa*
 Corolla lobes purple-blue; fruits 5–7 cm long *Chirita involucrata*

Aeschynanthus longicaulis (Wall. Cat. no. 888 (1929) nomen); R. Br. in Benn., Pl. Jav. Rar. (1840) 116; Burt & Woods, Notes R.B.G. Edin. 33:471. 1975.

An epiphytic or rock plant with slender trailing stems.

Distributed in Burma, Vietnam and Thailand. In Malaya recorded only from the limestone on Kaki Bukit and Bukit Bintang., Perlis.

Aeschynanthus parvifolia R. Br. in Benn., Pl. Jav. Rar. (1840) 115; Ridl., 2:500. 1923.

Common in lowland forest. Recorded from limestone in Kelantan and Selangor.

Aeschynanthus radicans Jack., Trans. Linn. Soc. 14:43. 1823; Ridl., Fl. 2:500. 1923.

Common in the lowlands. Recorded from the limestone on Gua Serai, Kelantan and Bukit Takun, Selangor.

Boea acutifolia Ridl., J. Linn. Soc. 32:519. 1895, J. Str. Br. R. As. Soc. 43:75. 1905, Fl. 2:536. 1923; Henders., J. Mal. Br. R. As. Soc. 17:60. 1939.

Stem to 30 cm, woody. Leaves crowded at the top of stem, oblanceolate, 10–15 by 3–4 cm.

Distributed in Thailand and restricted to limestone. In Malaya only from Langkawi and Perlis.

Boea brachycarpa Ridl., Kew Bull. (1929) 259; Henders., J. Mal. Br. R. As. Soc. 17:60. 1939.

Stem woody, about 20 cm. Capsules 0.6 cm long with only one twist in dehiscence. Style persistent.

Endemic and known from limestone in Kelantan. Until the 1962 UNESCO limestone expedition only one specimen (Henderson 19668, from Gua Ninek, Kelantan) was known to science.

Boea caerulescens Ridl., J. Str. Br. R. As. Soc. 43:73. 1905, Fl. 2:535. 1923; Henders., J. Mal. Br. R. As. Soc. 17:60. 1939.

Plant to 80 cm tall, stem woody. Leaves oblanceolate, 12–20 by 3–5 cm. Capsule glabrous, slender, 2–3 cm long.

Endemic and probably restricted to limestone. Fairly common on the Perak and Kelantan hills, also from Pahang.

Boea divaricata Ridl., J. Str. Br. As. Soc. 43:75. 1905, Fl. 2:535. 1923; Henders., J. Mal. Br. R. As. Soc. 17:60. 1939; Burt, Notes R.B.G. Edinb. 31:35. 1971.

Stem stout and woody. Leaves crowded, about 12–17 by 4–6 cm.

Endemic and restricted to limestone. Known from only three collections from Langkawi.

Boea lanata Ridl., J. Linn. Soc. 32:520. 1895, J. Str. Br. R. As. Soc. 43:74. 1905, Fl. 2:535. 1923; Henders., J. Mal. Br. R. As. Soc. 17:60. 1939.

Stem stout and woody, about 5–8 cm long. Leaves densely crowded, upper surface arachnoid, lower densely woolly, white, 7–15 by 2–3 cm. Capsule about 1.5 cm long, style persistent.

Endemic and restricted to limestone in the south-eastern corner of Langkawi, not uncommon. The densely pubescent leaves are very distinctive.

Boea minutiflora Ridl., Fl. 2:537. 1923; Hendera., J. Mal. Br. R. As. Soc. 17:60. 1939.

Stem to about 10 cm. Leaves thin, ovate or ovate-lanceolate. Capsule ovoid, 0.4 cm long.

Boea paniculata Ridl. J. Linn. Soc. 32:519. 1895, J. Str. Br. R. As. Soc. 43:72. 1905, Fl. 2:534. 1923; Henders., J. Mal. Br. R. As. Soc. 17:60. 1939.

Stem woody, about 10–16 cm long. Leaves lanceolate. Flowers about 4 cm across. Capsules about 2 cm long.

Endemic, common on limestone and restricted to it, with no records however from the eastern half of the peninsula.

Boea parviflora Ridl., J. Str. Br. As. Soc. 43:76. 1905, Fl. 2:536. 1923; Henders., J. Mal. Br. R. As. Soc. 17:60. 1939.

Stem slender, 12–15 cm long. Leaves paired, about 10 by 2.5–3 cm. Panicle umbellate.

Endemic, restricted to limestone in Perak.

Boea suffruticosa Ridl., J. Linn. Soc. 32:518. 1895, J. Str. B. R. As. Soc. 43:75. 1905, Fl. 2:536. 1923; Henders., J. Mal. Br. R. As. Soc. 17:60. 1939.

Branching sub-shrub, 30–60 cm tall. Stems slender, spreading.

Endemic and restricted to limestone in Langkawi. Rare.

Boea treubii Forbes, in J. Linn. Soc. Bot. 19:297. 1882; Burt, Notes R.B.G. Edinb. 31:37. 1971.

Sub-shrub. Leaves opposite, elongate-lanceolate, upper surface glabrous.

Distributed in Sumatra and Sarawak. Known in Malaya from a single specimen (Henderson 19459) from Gua Tipus, Pahang.

Boea verticillata Ridl., J. Linn. Soc. 32:519. 1895, J. Str. Br. R. As. Soc. 43:73. 1905, Fl. 2:535. 1923; Henders., J. Mal. Br. R. As. Soc. 17:60. 1939.

Lower part of stem woody; leaves whorled.

Endemic and restricted to limestone, common on the Selangor limestone; not known in Kelantan.

Chirita caliginosa Clarke, in DC., Mon. Phan. 5:122. 1883; Ridl., J. Str. Br. R. As. Soc. 43:58. 1905, Fl. 2:524. 1923; Henders., J. Mal. Br. R. As. Soc. 17:60. 1939, Mal. Wildfls. Dicots. (1959) 350; Wood, Notes R.B.G. Edinb. 33:186. 1974.

C. parvula Ridl., Fl. 2:524. 1923; Henders., J. Mal. Br. R. As. Soc. 17:60. 1939.

Herb to 50 cm., stems succulent.

Distributed in Sumatra and Sarawak, restricted to limestone, common.

Chirita hamosa R. Br., in Ben. & Br., Pl. Jav. Rar. (1840) 117; Cl., in Hk. f., Fl. Br. Ind. 4:360. 1884; Wood, Notes R.B.G. Edinb. 33:191. 1974.

Herbaceous, to 30 cm tall. Leaves solitary or paired.

Distributed in the north, from India and Burma to China, on limestone. Recorded only once from Malaya (Henderson 29185) from the Langkawi limestone.

Chirita involucrata Craib, in Gard. Chron. Ser. 3, 83:140. 1928; Wood, Notes R.B.G. Edinb. 33:199. 1974.

Plant herbaceous, to 45 cm tall.

Apparently restricted to limestone, distributed in Thailand and Cambodia. Recorded in Malaya from Kedah and Kelantan.

Chirita lacunosa (Hk.f.) Burt, Notes R.B.G. Edinb. 26:267. 1965; Wood, *ibid.* 33:151. 1974.

Didymocarpus lacunosus Hk. f., in Ridl., Fl. 2:510. 1923.

Acaulescent herbaceous herb. Inflorescence scapiform.

Restricted to limestone, distributed in Thailand and recorded from Gua Badak, Perak and Langkawi.

Chirita rupestris Ridl., J. Str. Br. As. Soc. 43:59. 1905, Fl. 2:525. 1923; Henders., Mal. Wildfls. Dicots. (1959) 349; Wood, Notes R.B.G. Edin. 33:201. 1974.

Herb, 10–30 cm tall.

Distributed in Thailand and Malaya, restricted to limestone. Recorded from Langkawi and Perlis in Malaya (one specimen from Bukit Penarak, Langkawi is probably not from limestone).

Chirita sericea Ridl., J. Str. Br. R. As. Soc. 43:59. 1905, Fl. 2:525. 1923; Henders., J. Mal. Br. R. As. Soc. 17:61. 1939; Wood, Notes R.B.G. Edinb. 33:187. 1974.

Herb. to 25 cm tall, silky pubescent.

Endemic and very probably restricted to limestone, recorded from Perak and once from Kedah.

Chirita viola Ridl., J. Linn. Soc. 32:516. 1895, J. Str. Br. R. As. Soc. 43:58. 1905, Fl. 2:525. 1923; Henders., J. Mal. Br. R. As. Soc. 17:61. 1939, Mal. Wildfls. Dicots. (1959) 350; Wood, Notes R.B.G. Edinb. 33:190. 1974.

Herb, 12–45 cm tall.

Distributed in Peninsular Thailand. Recorded from Malaya in Pahang, Kelantan and Kedah, including Langkawi; frequently but not always on limestone. Common on the coastal limestone of Langkawi.

Cyrtandra cupulata Ridl., J. Linn. Soc. 32:527. 1895, J. Str. Br. R. As. Soc. 43:92. 1905; Henders., Mal. Wildfls. Dicots. (1959) 362.

Endemic and common in lowland forest. Recorded once from limestone (Loh FRI 17261, from Gua Peningat, Pahang).

Cyrtandra lanceolata Ridl., J. Linn. Soc. 32:527. 1895, J. Str. Br. R. As. Soc. 43:91. 1905, Fl. 2:546. 1923.

A rare plant, recorded once from limestone (UNESCO 547, from Gua Panjang, Kelantan).

Dichiloboea speciosa (Ridl.) Stapf., Kew Bull. (1913) 356; Ridl., Fl. 2:537. 1923; Henders., J. Mal. Br. R. As. Soc. 17:61. 1939. Burt, Notes R.B.G. Edinb. 31:39. 1971.

Phylloboea speciosa Ridl., J. Linn. Soc. Bot. 32:522. 1895.

Sub-shrub. Stems, lower surface of leaves and fruits white arachnoid.

Distributed in South Thailand and restricted to limestone. Recorded in Malaya only from Kedah and Perlis.

Epithema saxatile Bl., Bijdr. (1826) 738; Ridl., J. Str. Br. R. As. Soc. 43:80. 1905, Fl. 2:539. 1923; Henders., J. Mal. Br. R. As. Soc. 17:61. 1939, Mal. Wildfls. Dicots. (1959) 360.

Slender herb, 7–30 cm tall. Peduncle 3–15 cm long. Capsule globose, dehiscent by a lid.

Common in Malaya, usually on limestone, but also on other rocks. Recorded only once from Kelantan though.

Monophyllaea glabra Ridl., J. Str. Br. R. As. Soc. 43:82. 1905; Henders., J. Mal. Br. R. As. Soc. 17:61. 1939.

Herb; stem succulent, 15–30 cm tall with a single ovate-cordate leaf.

Distributed in Peninsular Thailand. Recorded for Malaya from Langkawi; only from limestone.

Monophyllaea horsfieldii R. Br., in Benn., Pl. Jav. Rar. (1840) 121; Ridl., J. Str. Br. R. As. Soc. 43:81. 1905, Fl. 2:540. 1923; Henders., J. Mal. Br. R. As. Soc. 17:61. 1939; Mal. Wildfls. Dicots. (1959) 356.

Succulent herb.

In Malaya, common on limestone in Perak, Kelantan and Selangor; also known from Perlis. Not always from limestone. The distal $\frac{1}{4}$ – $\frac{1}{2}$ of the leaf is nearly always tattered and torn though it does not appear to be the result of predation.

Monophyllaea hirticalyx Franch., in Bull. Soc. Linn. Paris, n.s. 1:125. 1899; Burt, Notes R.B.G. Edinb. 31:50. 1971.

M. patens Ridl., J. Str. Br. R. As. Soc. 43:82. 1905, Fl. 2:540. 1923; Henders., J. Mal. Br. R. As. Soc. 17:61. 1939.

Succulent herb, stem 5–15 cm.

Endemic and restricted to limestone, recorded from Perak, Pahang, Kelantan and Selangor. This species also nearly always have the distal half of the leaf torn.

Ornithoboea flexuosa (Ridl.) Burt, Notes R.B.G. Edinb. 22:297. 1958.

Lepidanthus flexuosa Ridl., Fl. 2:538. 1923; Henders., J. Mal. Br. R. As. Soc. 17:61. 1939.

Herb to 45 cm tall. Leaves opposite, ovate, toothed, pubescent.

Distributed in Peninsular Thailand. In Malaya, recorded from only Kedah mainland; restricted to limestone.

Paraboea bakeri Henders., Gard. Bull. S.S. 7:115. 1933, J. Mal. Br. R. As. Soc. 17:61. 1939.

Acaulescent herb. Leaves broad ovate to orbicular.

Endemic and known from a single collection (Henderson 25094) from Bukit Sagu, 18 miles N.W. of Kuantan, at about 300 m on bare dry limestone.

Paraboea bettiana Henders., Gard. Bull. S.S. 7:116. 1933, J. Mal. Br. R. As. Soc. 17:61. 1939.

Stem woody to 45 cm tall. Leaves crowded.

Endemic and known from a single locality at Bukit Cheras, about 15 miles W.N.W. from Kuantan at about 160 m.

Paraboea bintangensis Burtt, Notes R.B.G. Edinb. 31:51. 1971.

Acaulescent herb. Leaves broadly elliptic, about 9 by 4.5 cm.

Endemic, known only from the limestone of Bukit Bintang, Perlis.

Paraboea capitata Ridl., J. Str. Br. R. As. Soc. 43:67. 1905, Fl. 2:531. 1923; Henders., J. Mal. Br. R. As. Soc. 17:61. 1939.

Acaulescent with a stout rootstock. Leaves broadly ovate to orbicular, 6–15 by 5–12 cm.

Endemic, usually on limestone. Recorded from limestone in Perak, Pahang and Kelantan.

Paraboea ferruginea Ridl., J. Str. Br. R. As. Soc. 43:68. 1905, Fl. 2:531. 1923.

Stem very short, leaves in a rosette.

In Malaya, restricted to limestone on Langkawi, rare; probably distributed in Peninsular Thailand as well.

Paraboea laxa Ridl., J. Str. Br. R. As. Soc. 43:70. 1905, Fl. 2:532. 1923; Henders., J. Mal. Br. R. As. Soc. 17:61. 1939.

Stem woody, very short. Leaves obovate, decurrent, 6–15 by 3–7 cm, densely pale brown tomentose especially on the lower surface. Inflorescence umbellate, peduncle slender 10–15 cm long. Pedicels slender, 0.3 cm long. Corolla 0.6 cm across, white, pink or (?) yellow. Capsule, 1.2 cm long.

Endemic and restricted to limestone on Langkawi. Chin 1731 and 1785 have pedicels 1.2–2 cm long and capsules to 2 cm long.

Paraboea vulpina Ridl., J. Str. Br. R. As. Soc. 43:69. 1905, Fl. 2:532. 1923; Henders., J. Mal. Br. R. As. Soc. 17:61. 1939.

Endemic and restricted to limestone in Perak, very rare.

Rhynchoglossum obliquum Bl., Bijdr. (1826) 741; Ridl., J. R. As. Soc. 43:79. 1905, Fl. 2:539. 1943; Henders., J. Mal. Br. R. As. Soc. 17:61 1939.

Found in hill forests in Malaya, not common, only once from limestone (Henderson 19402 from Gua Tipus, Pahang).

Stauranthera grandifolia Benth., Scroph. Ind. (1835) 57; Ridl., J. Str. Br. R. As. Soc. 43:83. 1905, Fl. 2:541. 1923; Henders., J. Mal. Br. R. As. Soc. 17:61. 1939, Mal. Wildfls. Dicots. (1959) 357.

On rocks, usually in damp places, mainly in the north. Sometimes on limestone.

Stauranthera umbrosa Cl., Comm. et Cyrt. Beng. (1874) 89; Ridl., J. Str. Br. R. As. Soc. 43:83. 1905, Fl. 2:541. 1923; Henders., J. Mal. Br. R. As. Soc. 17:62. 1939.

On rocks in damp places. Recorded once from limestone (King's coll. 7144 from 'limestone hill', Perak).

Note

Didymocarpus calcareus Ridl., Kew Bull. (1929) 258.

Apparently the only locality from which this species has been collected is Gunung Stong in Kelantan. The type specimen (Mohamed Nur & Foxworthy 12192) is from '1500 ft altitude, on limestone'. Henderson (1939:15) commenting on G. Stong wrote, 'The summit of Gunung Stong, c. 5000 ft. was reported to be capped with limestone, but Symington and Willbourn report that there are only a few boulders or limestone, of no significance from a botanical point of view'.

The plant was recollected on G. Stong by Symington in 1934 (Symington 37724). His field notes say 'damp quartzite rocks, 3500-4000 ft'.

No other *Didymocarpus* has been reported from limestone. It is very likely that Mohamed Nur & Foxworthy and Ridley all made a mistake about the rock type from which their specimen was collected. The specific epithet is therefore an unfortunate misnomer.

GUTTIFERAE

1. Leaves with numerous straight and parallel secondary veins
..... *Calophyllum curtisii*
Leaves different 2
2. Leaf stalk bases clasping stem, apical pair concealing the apical bud. Flowers
yellow, pink or red 3
Leaf stalk bases not clasping stem, apical pair not concealing bud. Flowers
white 11
3. Leaves with a pair of small ovate stipules. Common in Perlis, Kedah and
around Gua Musang in Kelantan. *Garcinia minutiflora*
Leaves with no stipules 4
4. Leaves mostly 10–20 cm long 5
Leaves mostly smaller 6
5. Leaves with conspicuous black dots and dashes. Fruits globose, umbonate,
2.5–4.5 cm across *Garcinia nigrolineata*
Leaves sometimes only with fine black longitudinal lines. Fruits pear shaped,
about 6 by 3.5 cm *Garcinia opaca*
6. Lower surfaces of leaves with a fine pattern of finger-print like markings,
veins obscure 7
Lower surface of leaves not so 9
7. Leaves narrow, small, 3–6 by 1–1.8 cm. Fruits flask shaped
..... *Garcinia montana*
Leaves wider, bigger, 4–10 by 2–5 cm. Fruits globose or sub-globose ... 8
8. Leaves with a pronounced drip tip. Flowers in axillary racemes to 2.5 cm
long. Fruits 1 cm across, stigma to 0.3 cm across *Garcinia eugeniaefolia*
(sometimes)
Leaves not so. Flowers axillary, solitary. Fruits to 2 cm across, stigma to
0.5 cm across *Garcinia murdochii*
9. Flowers solitary or in clusters. Fruit wall succulent, collapsing on drying
..... *Garcinia cowa*
Flowers in axillary racemes, short or to 2.5 cm long. Fruit wall more or
less woody, not or scarcely collapsing on drying 10
10. Leaves with a pronounced drip tip. Racemes about 2 cm long. Stigmas
flat or convex *Garcinia eugeniaefolia* (sometimes)
Leaves rarely with a pronounced drip tip. Racemes very short. Stigmas
slightly concave *Garcinia merguensis*
11. Leaves with fine but conspicuous reticulations; lower surface glaucous. Sepals
fused in bud, later splitting into 2. Flowers small, 1–1.5 cm across
..... *Mammea brevipes*
Leaves not reticulate or with very faint reticulations; lower surface not
glaucous. Sepals free, 4. Flowers larger, 7–10 cm across *Mesua ferrea*

Calophyllum curtisii King, J. As. Soc. Beng. 59:176. 1890; Ridl., Fl. 1:185. 1922; Whitmore, Tree Fl. Mal. 2:177. 1973.

Garcinia cowa Roxb., Hort. Beng. (1814) 42; Hk.f., F.B.I. 1:262. 1875; Corner Way Trees (2nd ed.) 1:315. 1952; Whitmore, Tree Fl. Mal. 2:208. 1973.

Recorded from limestone on Gunong Gajah, Kampar, Perak (Whitmore l.c.). Samsuri 551 and Chin 768 from Gunong Rapat, Perak have been assigned to this species with some doubts. The fruits are larger, to 5 cm across (instead of about 3 cm) and the rind succulent and very brittle.

Garcinia eugeniaefolia Wall. ex Anders., in Hk.f., F.B.I. 1:268. 1874; Ridl., Fl. 1:169. 1922; Henders., J. Mal. Br. R. As. Soc. 17:36. 1939; Whitmore, Tree Fl. Mal. 2:210. 1973.

Usually in lower montane forest, very rare in the lowlands. Common in the north, also from Thailand. Recorded once from limestone in Kedah (Kiah 35368) and once from Kelantan (UNESCO 354) the identity of the UNESCO specimen is however doubtful.

Garcinia merguensis Wight., Illus. Ind. Bot. (1831) 122; Ridl., Fl. 1:169. 1922; Whitmore, Tree Fl. Mal. 2:215. 1973.

G. lanceolata Ridl., l.c. 170.

Garcinia minutiflora Ridl., J. Str. Br. R. As. Soc. 82:169. 1920 Fl. 1:176. 1922; Henders., J. Mal. Br. R. As. Soc. 17:36. 1939; Whitmore, Tree Fl. Mal. 2:216. 1973.

Tree to 8 m tall. Leaves usually crowded towards twig ends, with a pair of small stipules, ovate, ovate-elliptic to obovate, 4.5–8 by 2.5–4.5 cm, coriaceous, margin recurved, lower surface with fine black dots; secondary nerves fine, looping and joining near the margin. Male flowers crowded on racemes to 1 cm long. Female flowers solitary or paired, axillary on stalks 1 cm long. Fruit ellipsoid, 1.2–2.3 cm long, one seeded.

Probably found in Peninsular Thailand: in Malaya, nearly always on limestone, common in Perlis, Langkawi and around Gua Musang in Kelantan; often as gnarled trees on craggy limestone.

Garcinia montana Ridl., Fl. 1:175. 1922; Whitmore, Tree Fl. Mal. 2:216. 1973.

Endemic, known from a single collection from Mount Ophir in Johore. A recent collection from limestone near Ipoh, Ng FRI 1600 is tentatively placed here (Whitmore l.c.).

Garcinia murdochii Ridl., J. Str. Br. R. As. Soc. 82:169. 1920, Fl. 1:175. 1922; Whitmore, Tree Fl. Mal. 2:217. 1973.

Distributed in Sarawak. Rare in Malaya, with several limestone records from Selangor and Pahang Loh FRI 17175 from Gua Peningat is probably this species. Chin 1147 from Raub and 1253 from Gua Batu match this species, except that the fruits are somewhat obliquely beaked.

Garcinia nigrolineata Planch. ex T. Anders., in Hk.f., F.B.I. 1:263. 1875; Ridl., Fl. 1:176. 1922; Corner, Way. Trees (2nd ed.) 1:319. 1952; Whitmore, Tree Fl. Mal. 2:218. 1973.

G. kunstleri King, in Ridl., Fl. 1:177. 1922; Henders., J. Mal. Br. R. As. Soc. 17:36. 1939.

Garcinia opaca King, J. As. Soc. Beng. 50:160. 1890; Ridl., Fl. 1:178. 1922; Whitmore, Tree Fl. Mal. 2:218. 1973.

Endemic, found in Perak, Selangor and S.E. Johore. Recorded from limestone in Kelantan, Trengganu and Johore (on the small outcrops on the slopes of Gunong Sumalayang).

Mammea brevipes (Craib) Kosterm., Commun. For. Res. Inst. Bogor 72:13. 1961; Whitmore, Tree Fl. Mal. 2:226. 1973.

Ochrocarpus siamensis (Miq.) Anders., Ridl., Fl. 1:180. 1922.

Distributed in Thailand. In Malaya, only from Langkawi, sometimes on limestone.

Mesua ferrea L., Sp. Pl. (1753) 515; Ridl., Fl. 1:192. 1922; Henders., J. Mal. Br. R. As. Soc. 17:36. 1939; Foxw., Mal. For. Rec. 3:135-7. 1927; Corner, Way. Trees (2nd ed.) 1:320. 1952; Whitmore, Tree Fl. Mal. 2:232. 1973.

HAMAMELIDACEAE

Basal third of fruit enveloped by a persistent receptacle. *Distyliopsis dunnii*
No such persistent receptacle. *Distylium stellare*

Distyliopsis dunnii (Hemsley) Endress, Blumea 19:105. 1971.

Sycopsis dunnii Hemsley, Ic. Pl. (1907) 29, Vink, Fl. Mal. I, 5:371. 1957; Whitmore, Tree Fl. Mal. 2:241. 1973.

Uncommon, and often local, on montane forest from 1200-1500 m. Recorded on limestone from Gua Musang, Kelantan and Bukit Serdam, Pahang both at less than 400 m altitude. It is abundant on the dry scrubby summit of Bukit Serdam.

Distylium stellare O. Kuntze, Rev. Gen. Pl. 1:233. Vink, Fl. Mal. I, 5:369. 1957; Back., Fl. Java 1:654. 1963; Whitmore, in Tree Fl. Mal. 2:239. 1973.

Uncommon in Malaya, at 1000-2000 m. Recorded for limestone from Gunong Pondok at an elevation of less than 400 m.

HERNANDIACEAE

Illigera pulchra Bl., Bijdr. (1826) 1154; Back. Fl. Java 1:136. 1963; Kubitzki, Bot. Jb. 89:174. 1969.

I. lucida Teysm., Binn. in Ridl., Fl. 3:140. 1924.

A slender climber. Leaves 3-foliolate. Leaflets lanceolate or lanceolate-elliptic, base round, sometimes slightly cordate, 5–15 by 2–15 cm. Inflorescence terminal and axillary, flowers 5-merous. Fruit 4 winged, about 2.5 cm long and 6–7 cm wide; wings, 3 long, 1 short.

Distributed in Sumatra, Malaya, Java and Celebes. Uncommon to rare in Malaya, known from only five records, three are from limestone, the other two also likely from limestone.

HYPERICACEAE

Cratoxylum maingayi Dyer, in Hk. f. F.B.I. 1:258. 1975; Ridl., Fl. 1:154. 1922; Gogelein, Blumea 15:470. 1967.

Collected a number of times from Ulu Kelantan limestone where it appears not to be uncommon though never abundant. The plants are usually spindly shrubs 2–4 m tall on dry craggy summits with a little soil accumulation. There is a tree about 6–8 m tall on the summit of Gua Musang near the picnic ground, overlooking the railway and the town. This tree withstood the fire of early 1969 that destroyed almost all the vegetation on this part of the hill. See under *Radermachera lobbii* (T. et B.) Miq. (Bignoniaceae).

ICACINACEAE

1. Climber with tendrils, pubescent 2
Erect shrubs, glabrous or glabrescent *Gomphandra quadrifida*
 2. Pubescence on the lower surface of leaves, consisting of soft, erect, or somewhat oblique hairs. Inflorescence to about 30 cm long in the male
..... *Iodes cirrhosa*
Pubescence on the lower surface of leaves, consisting of appressed stiff hairs.
Inflorescence small, 2–3 cm long *Iodes ovalis*
- Gomphandra quadrifida* (Bl.) Sleum., Notizbl. Berl.-Dahl. 15:238. 1940, Blumea 17:200. 1969.
- G. penangiana* Wall. ex Mast., in Ridl., Fl. 1:427. 1922.
- G. affinis* Mast. sensu Ridl., including var *floribunda* Ridl., Fl. 1:427. 1922; as *G. sp.* in Henders., J. Mal. Br. R. As. Soc. 17:40. 1939.
- var. *quadrifida*, in Sleum., Blumea l.c. 201.
- Iodes cirrhosa* Turcz., Bull. Soc. Nat. Moscou 27:261. 1854; Sleum., Blumea 17:221. 1969.
- Iodes ovalis* Bl., Bijdr. (1925) 30; Henders., J. Mal. Br. R. As. Soc. 17:40. 1939; Sleum., Blumea 17:220. 1969.
- I. oblonga* Planch., in Mast., in Hk.f., F.B.I. 1:597. 1857; Ridl., Fl. 1:435. 1922.

LABIATAE

1. Inflorescence terminal or sub-terminal, sometimes also with smaller axillary ones, but always towards the distal end of the stem 2
 Inflorescence axillary, often forming false-whorls made up by the pairs of opposed cymes 8
2. Inflorescence a terminal or sub-terminal false-whorl forming a globular head 1.5–2.0 cm across; sometimes axillary false-whorls occur below *Leucas zeylanica*
 Inflorescence not a globular head 3
3. Main branches of the inflorescence dichotomously branched, usually rather compact 4
 Main branches of the inflorescence (if branched), not dichotomously, usually raceme like and lax 5
4. Stem to over 100 cm tall; leaves 5–11 by 3.5–6 cm, glabrous above, pubescent below *Cymaria dichotoma*
 Stem very short 5–10 cm long, woody; leaves 15–20 by 10–12 cm, hirsute on both sides *Acrymia ajugiflora*
5. Flowers borne singly on the axis. Very rare endemic on limestone
 *Plectranthus kunstleri*
 Flowers borne in false whorls of 3-many; sometimes only 2 and opposite ... 6
6. Inflorescence unbranched, raceme-like. Flowers 2–3 in a false whorl; if 2, opposite *Scutellaria discolor*
 Inflorescence usually branched, if unbranched flowers usually more than 4 in a false whorl 7
7. Filaments prominent, projecting about 2 cm beyond mouth of corolla. Leaves 3–9 by 2–4.5 cm, base cuneate *Orthosiphon aristatus*
 Filaments not projecting beyond mouth of corolla. Leaves usually broadly ovate, 4–7 by 3–5 cm, base rounded *Coleus scutellarioides*
8. Flowers in globose or sub-globose heads; old flower heads withering black and persistent, peduncles 3–5 cm long *Hyptis rhomboides*
 Flowers not so borne 9
9. Leaves less than 5 cm long and (1–) 2–4 cm wide 10
 Leaves more than 8 cm long, often much more and (3–) 7–15 cm wide ... 11
10. Flowers 2–5 in cymes with a peduncle 0.5–1 cm long; calyx campanulate, when old 0.8–1.0 cm long, strongly ribbed, drying brown ... *Hyptis suaveolens*
 Flowers 3–10 in axillary false whorls, petioles 0.1–0.2 (–0.5) cm, calyx cylindrical 0.5–0.7 (–0.8) cm, drying pale green or straw coloured
 *Leucas mollissima*
11. Flowers in lax, axillary pedunculate and often branched cymes 12
 Flowers in dense axillary false whorls 13

12. Corolla tube almost straight, throat narrow; nutlets 1-2
 *Gomphostemma crinitum*
 Corolla tube curved, throat inflated; nutlets 1-4 *Gomphostemma curtisii*
13. Calyx tube in flowers, 0.5-7 cm long; corolla 2.5-3.5 cm long, straight
 *Gomphostemma microcalyx*
 Calyx tube in flowers, 1.0-1.5 (-2.0) cm long; corolla 4.0-4.5 (-5.0) cm long,
 distinctly curved *Gomphostemma javanicum*

Coleus scutellarioides (L.) Benth., in Wall., Pl. As. Rar. 2:16. 1830; Back., Fl. Java 2:637. 1965; Keng, Gard. Bull. S. 24:51. 1969.

C. atropurpureus Benth. in Wall., Pl. As. Rar. 2:16. 1830; Ridl., Fl. 2:646. 1923; Henders., J. Mal. Br. R. As. Soc. 17:65. 1969.

Cymaria dichotoma Benth., in Wall., Cat. (1828) 2080; Hk.f., F.B.I. 4:705. 1885
 Ridl., Fl. 2:654. 1923; Henders., J. Mal. Br. R. As. Soc. 17:66. 1939;
 Keng, Gard. Bull. S. 24:65. 1969.

Subshrub about 1 m tall. Stem faintly 4-angled, finely pubescent. Leaves 5-11 by 3.5-6 cm. Flowers 6-15, on the branches of cyme.

Distributed in S. China, Burma, Thailand and Malesia; in Malaya frequently but not always collected from limestone at low altitudes.

Gomphostemma crinitum Wall., Cat. (1828) Hk.f., F.B.I. 4:695. 1885; Ridl., Fl. 2:652. 1923. 1923; Henders., J. Mal. Br. R. As. Soc. 17:66. 1939; Keng, Gard. Bull. S. 24:84. 1969.

Plant 50-150 cm tall, stems stout erect. Leaves herbaceous 25-30 by 8-15 cm, pubescent. Flowers in axillary branched cymes.

Distributed in Burma, Indochina and Malesia; in Malaya collections are often though not always from limestone; usually from the bases of limestone hills in shade on soil rich in accumulated rock and plant debris.

Gomphostemma curtisii Prain, in J. As. Soc. Beng. 59:315. 1890; Ridl., Fl. 2:654. 1923; Keng, Gard. Bull. S. 24:85. 1969.

Cyrtandromoea repens Ridl., Fl. 2:543. 1923.

Gomphostemma javanicum (Bl.) Benth., Lab. Gen. & Sp. (1835) 650; Back., Fl. Java 2:618. 1965; Keng, Gard. Bull. S. 24:86. 1969.

G. oblongum Wall. ex Benth., in Wall., Pl. As. Rar. 2:12. 1930; Ridl., Fl. 2:653. 1923 (including var. *setosa* Ridl.); Henders., J. Mal. Br. R. As. Soc. 17:66. 1939.

Gomphostemma microcalyx Prain, in J. As. Soc. Beng. 59:316. 1890; Ridl., Fl. 2:652. 1923; Keng, Gard. Bull. S. 24:82. 1969.

Hyptis rhomboidea Mart. & Gal., Bull. Acad. Bru. 11:188. 1844; Keng, Gard. Bull. S. 24:92. 1969.

H. capitata (non Jack.) Miq. Fl. Ind. Bat. 2:958. 1858; Back., Fl. Java 2:634. 1965.

Hyptis suaveolens (L.) Poit., Ann. Mus. Paris 7:472. 1806; Ridl., Fl. 2:645. 1923; Back., Fl. Java 2:634. 1965; Keng, Gard. Bull. S. 24:96. 1969.

A weed of open places, not common.

Leucas mollissima Wall. ex Benth., in Wall. Pl. As. Rar. 1:62. 1830; Hk.f., F.B.I. 4:682. 1885; Henders., J. Mal. Br. R. As. Soc. 17:66. 1939; Keng, Gard. Bull. S. 24:106. 1969.

Plant 40–60 cm tall, much branched. Leaves thin ovate to elliptic 1.5–3 by 1–1.5 cm, the base rounded, tomentose on both sides. Flowers (3–) 6–10 in axillary false whorls. Calyx cylindrical, corolla white, upper lip densely hairy.

Distributed in India to S. China and Malesia; in Malaya restricted to limestone and only Kedah, in open places on rocky ground.

Leucas zeylanica R. Br. in W.T. Aiton, Hort. Kew. ed. 2, 3:409. 1811; Hk.f., F.B.I. 4:689. 1885; Ridl., Fl. 2:650. 1923; Back., Fl. Java 2:623. 1965; Keng, Gard. Bull. S. 24:101. 1969.

Orthosiphon aristatus (Bl.) Miq., Fl. Ind. Bat. 2:943. 1858; Back., Fl. Java 2:640. 1965; Keng, Gard. Bull. S. 24:132. 1969.

O. stamineus Benth., in Wall. Pl. As. Rar. 2:15. 1931; Hk.f., F.B.I. 4:615. 1835; Ridl., Fl. 2:645. 1923.

Plectranthus kunstleri Prain, in J. As. Soc. Beng. 66:521:1897, 74:916. 1907; Ridl., Fl. 2:646. 1923; Keng, Gard. Bull. S. 24:151. 1969.

Plant 80–120 (–150) cm tall, stems angular. Leaves membranous, broad ovate, 7–10 (–12) by 4–6 cm, base broad and abruptly short cuneate. Flowers in panicles 10–14 cm long, borne singly. Calyx, 1–1.5 mm long in flower (in fruit 5–6 mm).

Rare; endemic to the limestone of Malaya, previously known only from a single collection from the limestone in Perak. (King's collector 8240, Sept. 1885). This species was not recorded again for almost 90 years after the initial collection, until recently when it was found on Pulau Langgun (Chin 1760), the largest island to the Northeast of Pulau Langkawi proper. Though Langkawi has always been a popular spot for collectors, Pulau Laggun is one of the few islands, I believe, that has not been botanised on; and it was on the north-eastern part of the island, about half way between the shore and the lake that this plant was found again. It was growing on very rocky ground, consisting of hugeoulders suggesting that a huge cave-in could have occurred in the not too distant past. The plants were well spaced, scattered over a considerable area, rooting in rock crevices and on humus accumulated on the boulders, under the shade of scattered trees. Ground vegetation was fairly sparse, consisting mainly of climbing aroids, *Impatiens mirabilis* Hk.f. and ferns.

The inflorescence appears to elongate gradually producing 1–2 flowers at a time, and on most inflorescences still producing flowers, buds as well as the remnants of dried calyx are found together. The flowers are a purplish pink colour.

Scutellaria discolor Wall. ex Benth., in Wall., Pl. As. Rar. 1:66. 1830; Ridl., Fl. 2:649. 1923; Back., Fl. Java 2:620. 1965; Keng, Gard. Bull. S. 24:165. 1969.

NOTE

Acrymia ajugiflora Prain, Kew Bull. (1908) 114; Ridl., Fl. 2:654. 1923; Henders., J. Mal. Br. R. As. Soc. 17:65. 1939; Keng, Gard. Bull. S. 24:29. 1969.

Stem woody, prostrate and short, leafy only at the upper half. Leaves elliptic, 15–20 by 10–12 cm, margin irregularly serrate, petioles 3–4 cm long. Flowers in dichotomously branched compound cymes; corolla 0.6–0.7 cm long, upper lip 2-lobed, lower lip 3-lobed, the midlobe large and obovate.

Monotypic and endemic to Malaya. The type specimen collected by Kunstler is labelled 'Perak, N.K.L.' Prain, Ridley and Keng quoted this specimen as from Perak; Henderson however thinks that Kunstler often did not delete the word 'Perak' from his printed labels even though the plant was not collected from Perak; and is of the opinion that 'N.K.L.' probably means 'Near Kuala Lumpur'. However they are all of the opinion that it (Kunstler, King's collector, 10709) is from limestone. All other collections seen are from two localities; one from Rawang (Melville 4747), where there is no limestone outcrop of botanical interest; and the others from Kanching Forest Reserve, (Steenis 18509, Nur 34334, Reid s.n. June 1953 and Ridley s.n. Dec. 1920). Reid's specimen is specifically labelled as from the base of a quartz cliff, in an area a few hundred yards square.

The Kanching specimens (Reid's excepted) have been assumed by previous authors (Henderson included) to be from limestone. However I have not found this species on the limestone in Kanching (Bukit Anak Takun and Bukit Takun) where I have collected intensively, but have collected it (Chin 1825) from the base and lower slopes of the quartz ridge (also in Kanching and about two miles from the limestone outcrops). A label on which the locality is stated as 'a cliff' or 'base of cliff', the type of which is unspecified can easily prompt workers to interpret the cliffs as being limestone as the limestone cliffs are the popularly known cliffs in Kanching. I am therefore of the opinion that none of the Kanching specimens are from limestone but instead are all from the same locality at the base and slopes of the small quartz ridge (rising to 593 ft. as Bukit Perangin) which is chiefly under *Dryobalanops aromatica* Gaertn. f., and which forms part of the Kanching Forest Reserve. The Rawang specimen collected by Melville could very well be from the same locality, since Rawang is the closest town to the Kanching Forest Reserve and is less than three miles from the quartz ridge. Under the circumstances Melville could easily have (and rightly) recorded his collection as from Rawang.

Therefore after rejecting the idea that Kunstler's specimen could have been collected from Perak, I conclude that the species is restricted to Selangor only, and I am of the opinion that no collections yet made are from limestone. All are very likely are from the same locality at the base and lower slopes of the quartz ridge at Kanching Forest Reserve, where there is still a healthy and thriving population.

LAURACEAE

1. Undersurfaces of matured leaves pubescent; sometimes along the veins only 2
Undersurfaces of matured leaves glabrous and usually glaucous 4
2. Leaves cuspidate with a tip 2-3 cm long; lower surface densely pubescent, velvety; especially so along the veins *Cryptocarya griffithiana*
Leaves not with a tip 2-3 cm long; pubescence not dense 3
3. Inflorescence lax, peduncle 5-7 cm long; leaves shortly caudate
..... *Dehaasia longipedicellata*
Inflorescence dense and short; leaves with a rounded or acute apex
..... *Litsea polyantha*
4. Leaves 3-5 veined from the base or the lowest pair of veins prominent, reaching half the length of leaves 5
Leaves with veins not as above 7
5. Flowers in small axillary clusters. Young leaves more or less pubescent ... 6
.....
Flowers in axillary or terminal panicles, 5-15 cm long. Young leaves not pubescent *Cinnamomum iners*
6. Anthers 4-celled; stamens 6. Petioles about 1.2 cm long
..... *Neolitsea zeylanica*
Anthers 2-celled; stamens 9. Petioles usually to 0.4 cm long
..... *Lindera concinna*
7. Flowers in pseudo-umbels surrounded by large persistent bracts forming an involucre (the whole resembling a flower) 8
Flowers not surrounded by a persistent involucre 9
8. Leaves mostly less than 8 cm wide, apex acute. Flowers with 0-3 perianth lobes *Litsea glutinosa*
Leaves usually more than 8 cm wide, apex rounded or obtuse. Flowers with 4 perianth lobes *Litsea noronhae*
9. Leaves long acuminate. Anthers 4-loculate *Phobe lanceolata*
Leaves not so. Anthers 2-loculate 10
10. Leaves large, more than 20 cm long *Dahaasia microcarpa*
Leaves smaller 11
11. Fruiting pedicels enlarged. Perianth lobes unequal in 2 whorls. Common on limestone *Dehaasia curtisii*
Fruiting pedicels not enlarged. Perianth lobes equal 12
12. Leaves 2-2.5 cm wide; base long attenuate *Beilschmiedia pahangensis*
Leaves 3.5-6 cm wide; base narrowed *Beilschmiedia lumutensis*

Beilschmiedia lumutensis Gamble, Kew Bull. (1910) 148; Ridl., Fl. 3:84. 1924.

Endemic and rare. Known only from a collection made in the Dindings, Lumut, and recently, one from limestone in Kelantan. (Gua Seria, UNESCO 504).

Beilschmiedia pahangensis Gamble, Kew Bull. (1910) 150; Ridl., Fl. 3:86. 1923.

Endemic, often by rivers. Once from limestone on Gunong Tempurong, Perak. (Ng FRI 5856).

Cinnamomum iners Reinw. ex Bl., Bijdr. (1826) 570; Corner, Way. Trees 1:340. 1952.

Cryptocarya griffithiana Wight, Icon. Pl. (1852) t. 1830; Corner, Way. Trees 1:342. 1952.

Dehaasia curtisii Gamble, Kew Bull. (1910) 151; Ridl., Fl. 3:88. 1924; Henders., J. Mal. Br. R. As. Soc. 17:67. 1939.

Tree 3–8 m. Twigs pale colour. Leaves coriaceous, obovate to obovate-elliptic, glaucous beneath 4–7 (–12) by 2–3 (–5) cm. Flowers small, in inflorescences to 2 cm long. Fruit ellipsoid 1.2–1.5 cm long, ripening black.

Endemic, common on the limestone but not restricted to it. Plants growing in very exposed, dry, rocky summits tend to have smaller leaves in prominent fascicles at twig ends than plants growing in sheltered localities with some accumulation of soil.

Dehaasia longipedicellata (Ridl.) Kosterm., in Reinw. 6:284. 1962.

Beilschmiedia longipedicellata Ridl., Kew Bull. (1926) 475.

Endemic to Malaya and rare, once from limestone (Batu Bayan, Bertam, Kelantan, UNESCO 80).

Dehaasia microcarpa Bl., Rumphia (1837) 162; Ridl., Fl. 3:87. 1924; Henders., J. Mal. Br. R. As. Soc. 17:67. 1939.

Lindera concinna Ridl., J. Str. Br. R. As. Soc. 82:192. 1920, Fl. 3:137. 1924.

Endemic, usually found above 1,500 m. Once from limestone at about 300 m, on Gua Musang, Kelantan. (Ng, FRI 5564).

Litsea glutinose (Lour.) C.B. Rob., Philip. J. Sc. 6:321. 1911; Bak., Fl. Java 1:125. 1963.

L. chinensis Lam., Encyc. 3:574. 1791-1792; Henders., J. Mal. Br. R. As. Soc. 17:68. 1939.

L. sebifera Bl., Bijdr. (1826) 560; Ridl., Fl. 3:128. 1924.

Tree 5–15 m tall. Leaves elliptic oblong, glabrous 9–15 (–30) by 2–4 (–13). Buds softly pubescent. Flowers in short inflorescences along twigs. Fruits green, ripening black.

Distributed from India to Indochina, Java and Borneo. Occasionally cultivated. In Malaya recorded in limestone from Bukit Anak Takun and Bukit

Takun in Selangor and from Gunong Baling in Kedah; otherwise an uncommon plant. Ridley l.c. doubts whether it is native to Malaya; however I feel that the Selangor specimens are wild.

Litsea noronhae Bl., Bijdr. (1826) 561; Ridl., Fl. 3:128. 1924; Henders., J. Mal. Br. R. As. Soc. 17:68. 1939; Bak., Fl. Java 1:127. 1963.

Litsea polyantha Juss., Ann. Mus. Par. 6:211. 1805; Ridl., Fl. 3:118. 1924; Henders., J. Mal. Br. R. As. Soc. 17:68. 1939.

Neolitsea zeylanica Merr., Philip. J. Sc. I. Suppl. 57. 1906; Ridl., Fl. 3:132. 1924; Corner, Way. Trees 1:349. 1952.

Phoeba lanceolata (Wall. ex Nees) Nees, Syst. Laur. (1836) 109; Ridl., Fl. 3:104. 1924. Kosterm., Reinw 8:124. 1970.

LECYTHIDACEAE

1. Coastal tree. Leaves broad, 20–40 by 10–18 cm. *Barringtonia asiatica*
Not coastal. Leaves narrower 10–35 by 3–8 cm 2

2. Leaves pubescent beneath, the base emarginate or cuneate
..... *Barringtonia fusiformis*
Leaves glabrous beneath, the base cuneate *Barringtonia macrostachya*

Barringtonia asiatica (L.) Kurz, Rep. Pegu (1875) App. A. 55; Henders., J. Mal. Br. R. As. Soc. 17:45. 1939; Payens, Blumea 15:184. 1967.

B. speciosa J. R. et G. Forster, Char. Gen. (1776) 76; Ridl., Fl. 1:756. 1922.

Widely distributed along tropical shores from the Indian Ocean to the Western Pacific Ocean; common in Malaya. Recorded from limestone in Langkawi only as a littoral plant.

Barringtonia fusiformis King, J. As. Soc. Beng. 70:140. 1901; Ridl., Fl. 1:759. 1922; Henders., J. Mal. Br. R. As. Soc. 17:45. 1939; Payena, Blumea 15:240. 1967.

In Malaya, fairly common on riverbanks and in dense bamboo-forest in the lowlands. Recorded from limestone on Gunong Pondok, Perak, (Henderson 23796) growing on rocky soil covered slopes and doubtfully once on limestone from Gua Batu, Selangor (Ridley 8284).

Barringtonia macrostachya (Jack) Kurtz, Rep. Pegu (1975) App. A. 66; Ridl., Fl. 1:758. 1922; Payens, Blumea 15:244. 1967.

LEGUMINOSAE

1. Trees or shrubs 2
 Climbers 16
 Prostrate herbs, prickly *Mimosa pudica*
2. Leaves simple 3
 Leaves compound 4
3. Leaves, tip bifid *Bauhinia acuminata*
 Leaves, tip not bifid *Moghania strobilifera*
4. Leaves trifoliolate. Coastal 5
 Leaves pinnate, leaflets more than 3; sometimes 3. Usually not coastal ... 7
 Leaves bipinnate 15
5. Trees, prickly *Erythrina indica*
 Shrubs, not prickly 6
6. Leaves rugose; pods strigose *Desmodium rugosum*
 Leaves and pods not so *Desmodium umbellatum*
7. Leaves even-pinnate, with no terminal leaflet 8
 Leaves odd-pinnate, with a terminal leaflet 13
8. Leaflets 10–20 (–24) pairs 9
 Leaflets 1–5 (–8) pairs 10
9. Leaves 8–15 cm long; flowers in racemes 5–10 cm long
 *Tamarindus indicus*
 Leaves 25–45 cm long; flowers in terminal panicles 30–40 cm long
 *Cassia timoriensis*
10. Leaflets very asymmetric; 1–3 pairs *Cynometra malaccensis*
 Leaflets more or less symmetrical; 1–8 pairs 11
11. Leaves big, 22–90 cm long; leaflets with distinct stalks about 1 cm long;
 basal leaflets not close to twig *Saraca thaipingensis*
 Leaves smaller; leaflets subsessile; the basal pair often clasping the twig ...
 12
12. Stamens 3–5, usually 4; calyx tube 0.5–3 cm long *Saraca declinata*
 Stamens 5–10, usually 6–8; calyx tube 0.5–1.2 cm long *Saraca indica*
13. Sarmentose shrub, rarely climbing; panicles large 20–60 cm long
 *Derris thyrsoiflora*
 Trees; racemes small 5–10 cm long 14
14. Leaflets glabrous; pods thickly woody; narrowly 0.2 cm winged. Only from
 Ipoh *Millettia pterocarpa*
 Leaflets hairy along the midrib below; pods thinly woody; not winged.
 Kelantan *Millettia hemsleyana*

15. Flowers in dense glbose heads; shrubs; in disturbed areas only *Leucaena glauca*
 Flowers in panicles; trees; coastal *Peltophorum pterocarpum*
16. Thorny 17
 Not thorny 18
17. Leaflets 0.8–1.2 cm long *Pterolobium densiflorum*
 Leaflets 2–4 cm long *Caesalpinia crista*
18. Leaves simple 19
 Leaves trifoliolate 25
 Leaves with more than 3 leaflets; pinnate; rarely some leaves with only
 3 leaflets 26
19. Buds spindle-shaped to oblong-ellipsoid, winged or prominently ribbed at the
 apex, rarely rounded. Tendrils absent *Bauhinia pottsii*
 Buds globular to oblong-ellipsoid, never winged at the apex. Tendrils
 present 20
20. Flowers in corymbose, dense short racemes 21
 Flowers in slender-stemmed, narrow racemes, never corymbose 23
21. Anthers opening by a large pore. Only from Gunong Senyum, Pahang ...
 *Phanera decumbens*
 Anthers opening by a slit 22
22. Receptacle tubular, 0.7–1.1 cm long *Phanera glauca*
 Receptacle slender, 0.4 cm long *Phanera integrifolia* subsp. *integrifolia*
23. Discs swollen. Ovary glabrous 24
 Disc not swollen. Ovary densely tomentose *Lasiobema strychnoideum*
24. Pedicels to 2 cm long. Stamens about 0.5 cm long. Staminodes 5–6. Leaves
 shallowly bifid *Lasiobema curtisii*
 Pedicels about 0.5 cm long. Stamens about 1 cm long. Staminodes 2.
 Leaves one third to half bifid *Lasiobema flavum*
25. Herbaceous climber, pubescent; flowers yellow *Phaseolus mungo*
 Woody climber, glabrous; flowers bluish-purple *Mucuna biplicata*
26. Leaflets alternate 27
 Leaflets opposite 28
27. Leaflets 0.6–1 by 0.5–0.8 cm; branchlets pubescent
 *Dalbergia phyllanthoides*
 Leaflets 1.7–3.5 by 0.8–2 cm; branchlets glabrous *Dalbergia scortechinii*
 Leaflets 10–15 by 4–6 cm; branchlets pubescent *Dalbergia kunstleri*
28. Sarmentose shrub; rarely climbing; inflorescence large 20–60 cm long
 *Derris thyrsofolia*
 Always a climber; inflorescence smaller, 7–30 cm long 29

29. Pods thick, woody, lower surface of leaflets scaly and finely hairy
 *Millettia sericea*
 Pods thin, winged along one or both sutures 20
30. Standard petal 1.5–2.5 cm long, with basal tubercles; densely pubescent on
 the outside *Derris elliptica*
 Standard petal 0.5–1 cm long, without basal tubercles; not densely pubescent
 *Derris heterophylla*

Bauhinia acuminata L., Sp. Pl. (1753) 375; Ridl., Fl. 1:625. 1922; Henders.,
 J. Mal. Br. R. As. Soc. 17:43. 1939; De Wit, Reinw. 3:393. 1956.

Caesalpinia crista L., Sp. Pl. (1753) 380; Back., Fl. Java 1:545. 1963.

C. nuga Ait, Hort. Kew 3:32. 1811; Ridl., Fl. 1:650. 1922.

Cassia timoriensis DC., Prodr. 2:499. 1825; Ridl., Fl. 1:617. 1922; Whitmore,
 Tree Fl. Mal. 1:248. 1972.

Cynometra malaccensis Meeuwen, Blumea 18:18. 1970; Whitmore, Tree Fl. Mal.
 1:254. 1972.

C. inaequifolia Gray, in Bak., in Hk.f., F.B.I. 2:267. 1878; as 'inaequalifolia'
 in Ridl., Fl. 1:635. 1922.

Dalbergia kunstleri Prain ex King, J. As. Soc. Beng. 66:121. 1897; Ridl., Fl.
 1:592. 1922; Henders., J. Mal. Br. R. As. Soc. 17:43. 1939.

Endemic and known only from 2 localities; one on limestone from Gopeng
 and the other from the banks of the Kinta river, both in Perak.

Dalbergia phyllanthoides Bl., in Miq. Fl. Ind. Bat. 1:134. 1855; Henders., J.
 Mal. Br. R. As. Soc. 17:43. 1939.

Dalbergia scortechinii Prain., J. As. Soc. Beng. 70:444. 1901; Ridl., Fl. 1:589.
 1922.

Derris elliptica Benth., J. Linn. Soc. 4:111. 1860; Ridl., Fl. 1:597. 1922;
 Henders., J. Mal. Br. R. As. Soc. 17:43. 1939; Back., Fl. Java. 1:617. 1963.

Derris thyrsoiflora Benth., J. Linn. Soc. 4:114. 1860; Ridl., Fl. 1:594. 1922.

Desmodium rugosum Prain., J. As. Soc. Beng. 66:137. 1897; Ridl., Fl. 1:607.
 1922; Henders., J. Mal. Br. R. As. Soc. 17:44. 1939.

Shrub, puberulous. Leaflets coriaceous, rugose, terminal one about 10 by
 6 cm. Inflorescence axillary, corymbs 3–6 flowered. Pods 4 cm long, 4-jointed.

Distributed in Burma and Thailand; in Malaya known only from Langkawi,
 Kedah; chiefly but not exclusively on limestone.

Desmodium umbellatum DC., Prodr. 2:235. 1825; Ridl., Fl. 1:607. 1922;
 Henders., J. Mal. Br. R. As. Soc. 17:44. 1939; Back., Fl. Java 1:603. 1963.

Erythrina variegata L., Herb. Amboin. (1754) 10; Krukoff, J. Arn. Arb. 53:132.
 1972.

E. indica Lam., Encyc. 2:291. 1786; Ridl., Fl. 1:578. 1922; Henders., J. Mal. Br. R. As. Soc. 17:44. 1939.

E. orientalis (L.) Murr., Comm. Gotting. 8:35. 1787; Whitmore, Tree Fl. Mal. 1:292. 1972.

Lasiobema curtisii (Prain) De Wit, Reinw. 3:424. 1956.

Bauhinia curtisii Prain, in Ridl., Fl. 1:633. 1922; Henders., J. Mal. Br. R. As. Soc. 17:43. 1939.

B. calcicola Craib, Kew. Bull. 1927:387.

Woody climber with short, circinate tendrils. Leaves ovate, bifid at the tip, 5–10 by 2.5–6 cm. Slightly pubescent on the nerves. Flowers in terminal or lateral, lax racemes about 10 cm long. Pods flat, elliptic or strap-shaped.

Distributed in Peninsular Thailand and northern Malaya, common on, but not restricted to limestone.

Lasiobema flavum De Wit, Reinw. 3:425. 1956.

Climber, tendrils glabrescent. Leaves ovate to orbiculate, one-third to half bifid, 6–8 by 7–11 cm. Flowers in slender-stemmed, pubescent racemes, 12–18 cm long. Flowers small, about 1.5 cm across.

Endemic to limestone on Pulau Dayang Bunting and known from only a single collection (Henderson 29146).

Lasiobema strychnoideum (Prain) De Wit., Reinw. 3:429. 1956.

Bauhinia strychnoidea Brain ex King, in J. As. Soc. Beng. 66:195. 1897; Ridl., Fl. 1:633. 1922; Henders., J. Mal. Br. R. As. Soc. 17:43. 1939.

Climber. Leaves ovate-elliptic to nearly lanceolate, sub-coriaceous, 5 nerved, the outer pair very slender. Flowers in dense, many-flowered, puberulous racemes, 20–30 cm long. Pods flat, densely woolly tomentose when young, 11 cm long, 3–6 cm wide.

Endemic to Malaya, uncommon; often collected from limestone hills, but not exclusively so. Recorded from Perak, Kelantan and Gunong Senyum in Pahang.

Leucaena leucocephala (Lam.) De Wit, Taxon 10:54. 1961; Back., Fl. Java 1:560. 1963.

L. glauca Bth., in Ridl., Fl. 1:655. 1922.

Millettia hemsleyana Prain, J. As. Soc. Beng. 66:90. 1897; Ridl., Fl. 1:585. 1922; Whitmore, Tree Fl. Mal. 1:297. 1972.

Millettia nterocarpa Dunn., J. Linn. Soc. 41:175. 1912; Henders., J. Mal. Br. R. As. Soc. 17:44. 1939; Whitmore, Tree Fl. Mal. 1:298. 1972.

M. glaucescens Kurz, in Prain, J. As. Soc. Beng. 66:89. 1897.

Like *M. hemsleyana* except that the leaflets are glabrous below and the pods are thickly woody, and narrowly, about 0.2 cm, winged.

Endemic and only collected three times; twice from limestone in Ipoh, Perak and once from Kapayang, Kinta, Perak, not known if from limestone.

Milletia sericea (Vent.) W. et A. ex Hassk., Prodr. (1834) 263; Ridl., Fl. Java 1:596. 1963.

Mimosa pudica L., Sp. Pl. (1753) 518; Ridl., Fl. 1:656. 1922; Back., Fl. Java 1:561. 1963.

Moghania strobilifera (L.) St. Hill. ex Jacks., Ind. Kew 2:252. 1894; Norte., Reinw., 5:433. 1961.

Flemingia strobilifera (L.) R. Br., in Ait., Hort. Kew 4:350. 1812; Ridl., Fl. 1:565. 1922.

Mucuna biplicata Teysm. et Binn., Cat. Hort. Bogor. (1866) 261; Ridl., Fl. 1:576. 1922.

M. atropurpurea Bak., in Hk.f. F.B.I. 2:186. 1879.

Peltophorum pterocarpum (DC.) Back. ex Heyne, in Nutt, Pl. Ned. Ind. ed. 2. 2:755. 1927; Whitmore, Tree Fl. Mal. 1:268. 1972.

P. inerme (Roxb.) Llanos., in Back. Fl. Java 1:547. 1963; Henders., J. Mal. Br. R. As. Soc. 17:44. 1939.

P. ferrugineum (Decne) Bth., in Ridl., Fl. 1:646. 1922.

Plant of rocky and sandy coast, frequently and widely cultivated. Recorded from limestone in Langkawi as a coastal plant.

Phanera decumbens (Hend.) De Wit, Reinw. 3:503. 1956.

Bauhinia decumbens Henders., Gard. Bull S. S. 7:99. 1933; J. Mal. Br. R. As. Soc. 17:43. 1939.

Scandent shrub with tendrils, branchlets pubescent. Leave broadly ovate or orbicular, bifid to about one-third, 4–7 cm across. Flowers in dense corymbs, yellow to red, petals rounded to broadly ovate, slightly over 1 cm long.

Endemic to limestone and known only from a single collection; Pahang, Gunong Senyum (Henderson 22268) “on open top of limestone hill, scrambling over rocks”.

Phanera glauca Wall. ex Benth., in Pl. Jungh. (1852) 265; De Wit, Reinw. 3:348. 1956.

Bauhinia glauca (Benth.) Benth., Fl. Hongk. (18661) 99.

B. micrantha Ridl., J. Str. Br. R. As. Soc. 59:98. 1911, Fl. 1:633. 1922; Henders., J. Mal. Br. R. As. Soc. 17:43. 1939.

Phanera integrifolia (Roxb.) Benth., in Pl. Jungh. (1852) 263; De Wit, Reinw. 3:478. 1956.

B. flammifera Ridl., Fl. 1:631. 1922.

Subsp. *integrifolia*

Pterolobium densiflorum Prain, J. As. Soc. Beng. 66:236. 1897; Ridl., Fl. 1:648. 1922.

Saraca delinata (Jack) Miq. Fl. Ind. Bat. 1:84. 1855; Zuijder, Blumea 15:419. 1967; Whitmore, Tree Fl. Mal. 1:269. 1972.

S. cauliflora Bak., in Ridl., Fl. 1:641. 1922.

S. macroptera Miq., in Ridl., l.c. 642.

S. palembanica (Miq.) Bak., in Ridl., l.c. 642.

S. triandra (Roxb.) Bak., sensu Ridl., in l.c. 642.

A common forest tree, especially along rocky stream banks. Recorded several times from limestone on earth covered slopes, never on craggy summits; all from Perak.

Saraca indica L., Mant. Pl. 1:98. 1767; Zuijder, Blumea 15:423. 1967; Whitmore, Tree Fl. Mal. 1:269. 1972.

S. bijuga Prain, in Ridl., Fl. 1:641. 1922; and probably *S. kunstleri* Prain, in Ridl., l.c. 641.

Recorded once from limestone at the base of a cliff.
(Gua Panjang, Kelantan, Henderson 19562).

Saraca thaipingensis Cantley ex Prain, J. As. Soc. Beng. 66:211. 1897; Zuijder, Blumea 15:416. 1967; Whitmore, Tree Fl. Mal. 1:270. 1972.

S. declinata (Jack) Miq., sensu Ridley in Fl. 1:641. 1922.

Recorded several times from limestone, on hill slopes with fairly deep soil; never on dry craggy summits. All from central Malaya east of the Main Range.

Tamarindus indica L., Sp. Pl. (1753) 34; Ridl., Fl. 1:636. 1922; Corner, Way-Trees. 1:404. 1952.

In Malaya, widely cultivated in villages and occurring as an escape in waste-ground especially in the north. Recorded once from limestone; presumably an escape.

Dubious records.

Bauhinia pottsii G. Don., Gen. Syst. (1832) 462; De Wit., Reinw. 3:402. 1956.
B. mollissima Wall., in Ridl., Fl. 1:626. 1922.

Two specimens (UNESCO 139 and 653) from Kelantan are doubtfully this species.

Derris uliginosa (Roxb.) Benth., Pl. Jungh. (1852) 252; Ridl., Fl. 1:595. 1922.

Two specimens (Chin 609 from Gunung Sumalayang and Stone & Wycholey 8980 from Gua Batu) are doubtfully this species.

Phaseolus mungo Linn., Mantissa (1767) 101; Ridl., Fl. 1:567: 1922.

The identification of a limestone record. Chin 483 from Langkawi is doubtful.

LENTIBULARIACEAE

Ultricularia minutissima Vahl, Enum. Pl. 1:205. 1805; Henders., J. Mal. Br. R. As. Soc. 17:60. 1939.

An uncommon herb in wet places. Recorded once from limestone in Langkawi (Holttum 17427).

LOGANIACEAE

1. Herbs, only from Kedah *Cynoctonum mitreola*
Woody plants 2
2. Leaves 3–5-nerved from the base. Tendrils or axillary spines often present. A liana, sometimes a shrub 3
Leaves pinnately nerved. No tendrils or axillary spines. Trees, shrubs or short climbers 4
3. Twigs and leaves pubescent, rarely glabrescent-glabrous. Corolla 3–5 mm long. Fruit small, about 1 cm across *Strychnos axillaris*
Twigs and leaves glabrous. Corolla 0.7–1.7 cm long. Fruit 4–12 cm across *Strychnos ignatii*
4. Leaves with prominently reflexed auricles. Only from Bukit Takun, Selangor *Fagraea auriculata*
Leaves with no prominently reflexed auricles 5
5. Calyx partly enveloped by 1 or 2 pairs of large bracteoles. Only from Bukit Chintamani, Pahang *Fagraea calcarea*
Not as above 6
6. Corolla tube 6–14 cm long, nearly cylindrical 7
Corolla tube less than 6 cm long, funnel shaped. Flowers 1–4 or many together 8
7. Flowers solitary, or sometimes in two's, bracteoles just below or adpressed to the calyx tube *Fagraea carnosia*
Flowers in 5-flowered cymes, bracteoles attached to about the middle of the pedicel *Fagraea ceilanica*
8. Inflorescences warty-lenticellate, flowers usually more than 7 in a branched inflorescence *Fagraea blumei*
Inflorescences not warty-lenticellate, flowers (1–) 2–4 in an unbranched cyme *Fagraea curtisii*

Cynoctonum mitreola (L.) Britt., Mem. Torr. Bot. Cl. 5:258. 1894; Leenhouts, Fl. Mal. I. 6:375. 1962.

Mitreola oldenlandioides Wall., in Ridl., Fl. 2:413. 1923; Henders., J. Mal. Br. R. As. Soc. 17:58. 1939.

Erect herb 5–50 cm tall. Stems angular, leaves ovate with interpetiolar stipules. Inflorescences terminal or sub-terminal. Flowers small, corolla 1–2 mm. Capsules 2-horned.

Widely distributed, found in S.E. United States, South America, in S.E. Asia from Bombay to Tonkin, Malesia, Philippines, New Guinea and N. Australia. In Malaya probably restricted to limestone and found only in Langkawi, Kedah.

Fagraea auriculata Jack., Mal. Misc. 2, n7:82. 1822; Ridl., Fl. 2:416. 1923. Leenhouts, Fl. Mal. I. 6:326. 1962.

Fagraea blumei G. Don, Gard. Dict. 4:69. 1837; Leenhouts, Fl. Mal. I. 6:320. 1962.

F. obovata Wall., in Henders., J. Mal. Br. R. As. Soc. 17:58. 1939.

F. vaginata K & G., in Ridl., Fl. 2:418. 1923.

Fagraea calcarea Henders., Gard. Bull. S.S. 7:113. J. Mal. Br. R. As. Soc. 17:58. 1939; Leenh., Fl. Mal. I. 6:332. 1962.

Climbing shrub. Leaves elliptic, ovate or obovate, 12–17 by 6–9 cm, thinly coriaceous, exauriculate. Flowers 1 (–3); bracteoles 2 pairs, the outer ovate, to 3 cm long, the inner to 2 cm long, all covering the base of the calyx. Corolla tube about 5 cm long.

Endemic and known only from a single collection. (Henderson 25036, from Bukit Chintamani, Pahang) climbing on a limestone rock face. Close to *F. curtisii* K & G. but differing in the larger bracteoles and thinner, wider and more rounded leaves.

Fagraea carnososa Jack, Mal. Misc. 2, n. 7:81. 1922; Ridl., Fl. 2:416. 1923; Henders., J. Mal. Br. R. As. Soc. 17:58. 1939; Leenhouts. Fl. Mal. I. 6:331.

F. rotundifolia Ridl., Fl. 2:416. 1923.

F. flavidula Ridl., Fl. 5:322. 1925.

F. lanceolata (non Bl.) Henders., Gard. Bull. S. S. 4:99. 1927.

Epiphytic shrub, often scandent; rarely terrestrial. Leaves elliptic, lanceolate or obovate, 7–16 by 4–8 cm; thickly coriaceous. Flowers 1(–2), corolla tube 7–14 cm long. Fruits ellipsoid 4–7 cm long.

Distributed in Lower Burma, Sumatra and Borneo; usually on limestone but also coastal on non-limestone rocks. The specimens that I have collected were both more or less terrestrial, growing on accumulated humus and amongst roots and rocks, in exposed, dry situations.

Fagraea ceilanica Thunb., Vet. Acad. Handl. Stockh. 3:132. 1782; Leenhouts, Fl. Mal. I. 6:315. 1962.

F. lanceolata Bl., Bijdr. (1826) 1021; Ridl., Fl. 2:420. 1923.

Fagraea curtisii K. et G., J. As. Soc. Beng. 74:605. 1908; Ridl., Fl. 2:417. 1923; Henders., J. Mal. Br. R. As. Soc. 17:58. 1939; Leenhouts. Fl. Mal. I. 6:332. 1962.

Spreading tree, 5–10 m, sometimes an epiphytic shrub. Leaves elliptic, ovate-elliptic to oblong-obovate, 10–20 by 5–8 cm. Flowers, 1(–2–4) together. Corolla tube about 4.5 cm long. Fruit roadly obovoid.

Distributed in Burma, Peninsular Thailand and Malaya. Frequently on limestone but not exclusively so. Not common in Malaya, recorded from Kedah, Kelantan and only recently from Pahang and Perak; probably more common on the limestone than previously thought.

Strychnos axillaris Colebr., Trans. Linn. Soc. 12:356. 1819; Leenhouts, Fl. Mal. I. 6:358. 1962.

S. pubescens Cl. inc. var. *scortechinii* K & G., in Ridl., Fl. 2:242. 1923.

S. chloropetala Hill., in Henders., J. Mal. Br. R. As. Soc. 17:58. 1939.

Dubious record

Strychnos ignatii Beng., Mat. Med. 1:146. 1778; Leenhouts, Fl. Mal. I, 6:347. 1962;

S. ovalifolia Wall., in Ridl., Fl. 2:425. 1923.

A limestone record from Gua Musang (UNESCO 311) is doubtfully this species.

LORANTHACEAE

1. Leaves 3–5-veined from the base, obovate to elliptic *Viscum orientale*
Leaves pinnately veined, secondary veins often obscure 2
2. Young twigs and undersurface of leaves pubescent, sometimes the undersurface of leaves becomes glabrous with age 3
Twigs and leaves glabrous 4
3. Petiole 1–2 cm long; undersurface of leaves becoming glabrous with age. Flowers in racemes 1.5–7 cm long *Helixanthera coccinea*
Petiole 0.2–0.6 cm long; undersurface of leaves pubescent. Flower in clusters *Scurrula ferruginea*
4. Petiole 0.3–0.8 cm long. Flowers in short racemes 0.2–2 cm long
..... *Macrosolen cochinchinensis*
Petiole 1–2.5 cm long. Flowers in racemes to 15 cm long.
..... *Helixanthera pulchra*

Helixanthera coccinea (Jack) Dans., in Bull. Jard. Bot. Buit. Ser. III, 11:374. 1931.

Loranthus coccineus Jack, Mal. Misc. 1:8. 1820; Ridl., Fl. 2:152. 1924.

Helixanthera pulchra (DC.) Dans., in Bull. Jard. Bot. Buit. Ser. III, 11:384. 1931.

Loranthus pulcher DC., in Ridl., Fl. 3:151. 1924 excl. var. *sessiliflora* Ridl.

Macrosolen cochinchinensis van Tiegh., in Dans., Bull. Jard. Bot. Buit. Ser. III, 11:279. 1931.

Loranthus cochinchinensis Lour., Fl. Coch. 1:195. 1970.

Elytranthe globosa G. Don, in Ridl., Fl. 3:161. 1924.

E. barnesii Gamble, in Ridl., l.c. 161.

Scurrula ferruginea., Bull. Jard. Bot. Buit. Ser. III, 11:432. 1931.

Loranthus ferrugineus Jack., in Ridl., Fl. 3:153. 1924.

Viscum orientale Willd., Sp. Pl. 4:737. 1805; Ridl., Fl. 3:164. 1924; Dans., Bull. Jard. Bot. Buit. Ser. III, 11:466. 1931.

LYTHRACEAE

Lagerstroemia langkawiensis Furt. et Mont., Gard. Bull. S. 24:327. 1969.

A small tree, 4–6 m tall. Leaves lanceolate, oblong or elliptic, 6–18 by 2.5–6 cm, glabrous, subcoriaceous. Panicle terminal. Flowers unknown. Fruiting calyx ferruginous stellate tomentose, campanulate 1.0–1.5 cm long including a 0.4–0.5 cm pedicelliform base. Capsule glabrescent, elliptic-oblong, 1.5–2.2 cm long, usually brown stellate at the apex.

Endemic and restricted to limestone on Langkawi; close to *L. siamica* Gagnep. which is found in Burma, Thailand and North Malaya; their ranges overlap and some herbarium material appear rather similar, *L. langkawiensis* is rarely collected and more material and study are required. Chin 486 has been tentatively determined as this species; it has somewhat smaller fruits and leaves.

MALVACEAE

1. Tree, coastal, calyx truncated, almost entire with no lobes *Thespesia populnea*
Herbs, subshrubs or shrubs, usually ubiquitous; calyx lobed 2
2. Flowers with an epi-calyx below the calyx; styles twice as many as carpels; flowers pink *Urena lobata*
Flowers with no epi-calyx; styles as many as carpels; flowers yellow 3
3. Carpels 5, ovules and seeds 1 to each carpel. Only from the north *Sida javensis*
Carpels 15–20, ovules and seeds 2-many in each carpel. Widespread weed; recorded from limestone only from the north *Abutilon indicum*

Abutilon indicum (L.) Sweet, Hort. Brit. (1826) 54; Ridl., Fl. 1:256. 1922; Henders., J. Mal. Br. R. As. Soc. 17:37; Borss., Blumea 14:171. 1966.

ssp. *indicum*

A common weed of waste ground.

Sida javensis Cav., Diss. 1:10. 1785; Henders. J. Mal. Br. R. As. Soc. 17:37. 1939; Borss., Blumea 14:184. 1966.

S. veronicifolia Lam. in Ridl., Fl. 1:254. 1922.

S. humilis Cav., in Back., Fl. Java 1:427. 1963.

Thespesia populnea (L.) Sol. ex Corr., Ann. Mus. Herb. Paris 9:290. 1807; Ridl., Fl. 1:260. 1922; Corner, Way. Trees. 1:444. 1940; Borss., Blumea 14:106. 1966.

Recorded from coastal limestone in Langkawi, growing at waters edge.

Urena lobata Linn., Sp. Pl. (1753) 692; Ridl., Fl. 1:256. 1922; Borss., Blumea 14:138. 1966.

A common weed, recorded from disturbed limestone localities.

MELASTOMACEAE

- | | |
|--|----------------------------------|
| 1. Herbs | 2 |
| Shrubs or trees | 4 |
| 2. Leaves less than 6 cm long, base narrowed or rounded, 5-nerved from the base. Petals 3, stamens 3 | 3 |
| Leaves more than 10 cm long, base cordate, 7-9-nerved from the base. Petals 4, stamens 8 | <i>Phyllagathis hispida</i> |
| 3. Leaves ovate-acute, base narrowed, cymes with 5-6 flowers | |
| | <i>Sonerila epilobioides</i> |
| Leaves elliptic to sub-orbicular, base and tip rounded, cymes with numerous flowers | <i>Sonerila elliptica</i> |
| 4. Leaves and twigs pubescent, or only twigs and nerves on the under-surface of leaves pubescent | 5 |
| Leaves and twigs both glabrous | 7 |
| 5. Lower surface of leaves with scales and hairs, twigs with scales | |
| | <i>Melastoma polyanthum</i> |
| Lower surface of leaves and twigs with no scales | 6 |
| 6. Leaves somewhat bullate, cross venules prominent, scalariform. Inflorescence 1.5 cm long, flowers, 5-merous | <i>Clidemia hirta</i> |
| Leaves not bullate, cross venules on the undersurface obscure. Inflorescence 2.5-5 cm long, flowers 4-merous | <i>Pachycentria constricta</i> |
| 7. Base of leaves with 2 auricles; base of anthers with a tuft of hairs | |
| | <i>Pogonanthera pulverulenta</i> |
| Base of leaves with no auricles | 8 |
| 8. Leaves sessile, base rounded or usually cordate; twigs more than 0.2 cm thick | 9 |
| Leaves stalked, stalks usually short; twigs sometimes to less than 0.1 cm thick | 10 |

9. Stems warty, leaves 10–17 (20) cm long. Flowers in cymose inflorescences, each with 8 stamens *Medinilla scortechinii*
 Stems not warty, leaves 6–10 cm long. Flowers 1–2(–3), axillary, each with 24–36 stamens *Plethiandra sessiliflora*
10. Leaves with a pair of very prominent veins from the base. Ovary 4–6 loculate *Medinilla crassifolia* var. *hasseltii*
 Leaves pinately nerved, sometimes nerves obscure. Ovary 1-loculate 11
11. Leaves less than 5 cm long, very rarely to 6 cm long 12
 Leaves more than 5 cm long 13
12. Leaves; tip rounded to acute, sometimes notched; broadly elliptic, elliptic-ovate to sub-orbicular *Memecylon laevigatum*
 Leaves, tip obtusely acuminate; ovate-elliptic *Memecylon pauciflorum*
13. Twigs angled 14
 Twigs terete or semi-terete, not angle 15
14. Leaves 6–10 by 2.5–5 cm, nerves 6–8 pairs *Memecylon dichotomum*
 Leaves 12–20 by 6–7.5 cm, nerves 14–15 pairs, prominent
 *Memecylon wallichii*
15. Secondary nerves prominent *Memecylon kunstleri*
 Secondary nerves faint or obscure 16
16. Inflorescence umbellate. Pedicels with 2 bracteoles
 *Memecylon floribundum*
 Inflorescence cymose or paniculate, often very short 17
17. Petiole 1–1.2 cm long. Inflorescence 2–2.5 cm long ... *Memecylon oleaefolium*
 Petiole 0.3–0.7 cm long. Inflorescence usually shorter 18
18. Leaves acute or short acuminate *Memecylon edule*
 Leaves prominently acuminate *Memecylon acuminatum*

Clidemia hirta (L.) Don., Mem. Wern. Soc. 4:309. 1823; Ridl., Fl. 1:807. 1922; Bakh., Rec. Trav. Bot. Neerl. 40:113. 1946; Henders., Mal. Wildils. (1959) 128.

Medinilla crassifolia (Reinw. ex Bl.) Bl., Fl. 14:511. 1831; Bakh., Rec. Trav. Bot. Neerl. 40:188. 1946.

var. *hasseltii* (Bl.) Bakh., in l.c. 189.

M. hasseltii Bl., in l.c. 513.

Medinilla scortechinii King, J. As. Soc. Beng. 69:62. 1900; Ridl., Fl. 1:803; 1922; Henders., Mal. Wildfls. Dicots. (1959) 136.

Endemic, common on the hills at 900–1500 m, occasionally on the lowlands. Recorded from limestone at low altitude in Kelantan.

Melastoma polyanthum Bl., Fl. 14:481. 1831; Ridl., Fl. 1:765. 1922; Bakh., Rev. Trav. Bot. Neerl. 40:64. 1946.

Memecylon acuminatum Sm., in Rees, Cycl. 23. n.4. 1812; Ridl., Fl. 1:817. 1922; Henders., J. Mal. Br. R. As. Soc. 17:45. 1939.

Endemic, common in lowland forest. Recorded from limestone in Langkawi.

Memecylon dichotomum Cl. ex King, J. As. Soc. Beng. 69:75. 1900; Ridl., Fl. 1:812. 1922; Henders., J. Mal. Br. R. As. Soc. 17:46. 1939.

Endemic, common in lowland forest. Recorded positively from limestone once (Henderson 25064) from Pahang. Two records from the Langkawi limestone are doubtfully this species (Corner s.n. 17:11.41, Henderson s.n. 22.11.34).

Memecylon edule Roxb., Cor. Pl. 1:59. 1798; Hk.f., F.B.I. 2:563. 1897; Ridl., Fl. 1:819. 1922.

M. ovatum Sm. ex Kurz, in Henders., J. Mal. Br. R. As. Soc. 17:46. 1939.

Fairly common in Malaya in coastal areas. Recorded for limestone from Perlis, Kedah and Selangor.

Memecylon kunstleri King, J. As. Soc. Beng. 69:76. 1900; Ridl., Fl. 1:814. 1922; Henders., J. Mal. Br. R. As. Soc. 17:46. 1939.

Endemic, not common in lowland forest. Collected from limestone on Gunong Dipang, Perak by Kunstler (Ridley l.c.). I have not seen this specimen.

Memecylon laevigatum Bl., Mus. Bot. Lugd. Bat. 1:358. 1851; Ridl., Fl. 1:817. 1922; Henders., J. Mal. Br. R. As. Soc. 17:46. 1939; Bakh., Rec. Trav. Bot. Neerl. 40:343. 1946.

M. myrsinoides Bl., in Bak.f., J. Bot. 62:42. 1924; Ridl., Fl. 1:817. 1922; Henders., J. Mal. Br. R. As. Soc. 17:46. 1939.

Not common in the lowlands, often coastal. A small-leaved form of this species is fairly common on dry craggy summits of limestone hills. The leaves are obovate, broadly-elliptic to sub-orbicular, 2-4 by 1-2.5 cm. Very common on Bukit Takun, Selangor.

Memecylon oleaefolium Bl., Mus. Bot. Lugd. Bat. 1:359. 1851; Ridl., Fl. 1:814. 1922; Bakh., Rec. Trav. Bot. Neerl. 40:356. 1946.

Memecylon pauciflorum Bl., Mus. Bot. Lugd. Bat. 1:356. 1851; Ridl., Fl. 1:816. 1922; Bakh., Rec. Trav. Bot. Neerl. 40:360. 1946.

This is usually a coastal plant in Penang and Kedah. It has however been collected from inland limestone in Perak and Selangor.

Memecylon wallichii Ridl., J. Str. Br. R. As. Soc. 79:74. 1918, Fl. 1:813. 1922.

Endemic, not common, in the northern half of Malaya. Recorded from limestone in Kelantan.

Pachycentria constricta (Bl.) Bl., Fl. 14:519. 1931; Bakh., Rec. Trav. Bot. Neerl. 40:124. 1946.

P. tuberculata Korth., in Ridl., Fl. 1:805. 1922.

Plethiandra sessiliflora Ridl., Fl. 1:806. 1922.

Endemic, recorded from Singapore and Johore as epiphytes on mangrove, and recently from Bukit Takun in Selangor, growing on humus covered rocks, mixed with *Nephrolepis dicksoniodes* Chr.

Pogonanthera pulverulenta (Jack.) Bl., Fl. 14:521. 1831; Ridl., Fl. 1:805. 1922; Bakh., Rec. Trav. Bot. Neerl. 40:128. 1946.

This is usually an epiphyte and sometimes a rock plant; frequently coastal. Recorded once from limestone near the summit of Bukit Anak Takun, Selangor. (Chin 30).

Sonerila elliptica Stapf., J. As. Soc. Beng. 69:30. 1900; Ridl., Fl. 1:784. 1922; Henders., J. Mal. Br. R. As. Soc. 17:46. 1939.

Endemic and restricted to the Kinta district and Sungei Siput in Perak; probably restricted to limestone. I have not seen any specimens of this species.

Sonerila tenera Royle, Illustr. Bot. Himal. (1835) 215; Ridl., Fl. 1:781. 1922.

S. elilobioides Stapf., J. As. Soc. Beng. 69:22. 1900; Henders., J. Mal. Br. R. As. Soc. 17:46. 1939.

Dubious record.

Phyllagathis hispida King, J. As. Soc. Beng. 69:46. 1900; Ridl., Fl. 1:794. 1922; Henders., I. Mal. Br. R. R. As. Soc. 17:46. 1939.

Endemic, found on the hills and mountains at 700–2000 m. Reported by Henderson in l.c. as recorded by Ridley from Kanching limestone (Selangor). This is not mentioned by Ridley in his Flora, and I have not seen any material from the limestone at Kanching. Further I have not seen this plant on the limestone there (which is not extensive). I feel that Henderson must have made a mistake.

MELIACEAE

- | | |
|---|------------------------------|
| 1. Leaves simple, alternate; membranous and glabrous | <i>Turraea braviflora</i> |
| Leaves pinnate compound | 2 |
| 2. Leaves glabrous | 3 |
| Leaves pubescent on the undersurface | 5 |
| 3. Leaflets 1–3 pairs. Fruits large, globose, 12–18 cm across | <i>Xylocarpus granatum</i> |
| Leaflets 5–11 pairs | 4 |
| 4. Leaves imparipinnate | 5 |
| Leaves paripinnate | <i>Chukrassia tabularis</i> |
| 5. Leaf rachis 20–60 cm long; petiolules 0.2 cm long. Fruits ellipsoid, about 1.5 cm across | <i>Azadirachta excelsa</i> |
| Leaf rachis 15–25 cm long; petiolules 0.7–1.2 cm. Fruits ovoid, 3 cm across | <i>Dysoxylum arborescens</i> |
| 6. Leaflets with 12–24 pairs of veins. Leaves about 30 cm or more | 7 |
| Leaflets with 6–9 pairs of veins. Leaves usually smaller, 15–23 cm long | <i>Aglaia odoratissima</i> |

7. Leaflets large, 12–22 by 5–112 cm *Aglaiia argentea*
 Leaflets smaller and narrower, about 15 by 4 cm *Aglaiia splendens*

Aglaiia argentea Bl., Bijdr. (1825) 170; Ridl., Fl. 1:405. 1922; Henders., J. Mal. Br. R. As. Soc. 17:40. 1939.

Not common in lowland forest. Rare on limestone.

Aglaiia odoratissima Bl., Bijdr. (1825) 171; Ridl., Fl. 1:404. 1922; Henders., J. Mal. Br. R. As. Soc. 17:40. 1939.

A. roxburghiana Miq., in Hk.f., F.B.I. 1:555. 1875.

Aglaiia splendens Koord. et Valet., Ic. Bogor. 1. t. 14. 1897–1901; Ridl., Fl. 1:405. 1922; Henders., J. Mal. Br. R. As. Soc. 17:40. 1939.

Azadirachta excelsa (Jack) Jacobs, Gard. Bull. S. 1875. 1961.

Melia excelsa Jack, Mal. Misc. 1:12. 1820; Corner, Gard. Bull. S. S. 10:263. 1939; Henders., J. Mal. Br. R. As. Soc. 17:40. 1939.

Chukrassia tabularis Juss., Mem. Mus. Par. 16:251. 1830; Ridl., Fl. 1:415. 1922; Craib, Fl. Siam Enum 1:266. 1926.

Dysoxylum arborescens Miq., Ann. Mus. Bot. Lugd. Bat. 4:24. 1868; Ridl., Fl. 1:391. 1922; Henders., J. Mal. Br. R. As. Soc. 17:40. 1939.

Turraea breviflora Ridl., Fl. 1:383. 1922; Henders., J. Mal. Br. R. As. Soc. 17:40. 1939.

Endemic, not common in Malaya, in lowland forest. Recorded once from limestone, from Bukit Takun in Selangor (fide Ridley). I have not seen this specimen.

Xylocarpus granatum Koenig, Naturf. 20:2. 1784; Back., Fl. Java 2:118. 1965.

Carapa granatum Alston, in Burkill, Dic. Econ. Prod. Mal. 1:457. 1935.

C. obovata Bl., in Foxw., Mal. For. Rec. 6:124. 1928; Ridl., Fl. 1:414. 1922.

C. moluccensis of many authors; non Lamark.

In Malaya, common by tidal rivers. Recorded from coastal limestone in Malaya.

MENISPERMACEAE

1. Leaves peltate 2
 Leaves not peltate 4
2. Leaves, lower surface glabrous or glabrescent 3
 Leaves, lower surface densely pubescent; apex acuminate; inflorescence 10–50 cm long *Cyrtia laxiflora*
3. Inflorescence an umbellate cyme, on a 4–10 cm peduncle; borne on slender climbing stems *Stephania venosa*
 Inflorescence a raceme of cymes, 40–50; borne on woody main stems
 *Diplodisia glaucescens*

4. Base of leaf cuneate, sometimes rounded. Sepals 8–12 5
 Base of leaf codate. Sepals 6 *Tinospora crispa*
5. Leaves, 2–4 cm wide. Inflorescence short, to 1 cm long
 *Hypserpa cuspidata*
 Leaves broader, 5–8 cm wide. Inflorescence 10–20 cm long
 *Tinomiscium petiolare*
- Cyclea laxiflora* Miers, Contr. Bot. 3:241. 1864–71; Ridl., Fl. 1:114. 1922;
 Henders., M.N.J. 6:415. 1951; Forman, Kew Bull. 14:75. 1960.
- Diploclisia glaucescens* (Bl.) Diels, in Engl., Pflanz., Menisp. (1910) 225; Back.,
 Fl. Java 1:158. 1963; Forman, Kew Bull. 22:363. 1963.
- D. kunstleri* (King) Diels, in Ridl., Fl. 1:107. 1922.
- Hypserpa cuspidata* Miers, Ann. & Mag. Nat. Hist. Ser. II. 7:40. 1851; Ridl.,
 Fl. 1:111. 1922.
- Limacia cuspidata* Hk.f. et Thoms., Fl. Ind. (1855) 189, F.B.I. 1:100. 1875.
- Stephania venosa** (Bl.) Spreng., Syst. Veg. 4:316. 1827; Bak., Fl. Java 1:160.
 1963; Forman, Kew Bull. 11:58. 1956.
- S. rotunda* Lour., in Ridl., Fl. 1:113. 1922;
- S. sp.* in Henders., J. Mal. Br. R. As. Soc. 17:35. 1939.
- Slender climber to 20 m. Leaves peltate, broadly triangular-ovate, sometimes
 slightly lobed, lower surface minutely papillose, otherwise glabrous, 5–20 by
 5–20 cm; palmately 9–12-nerved. Male inflorescence an axillary, umbelliform
 cyme, peduncle 4–11 cm; female similar. Fruit red, obovate, 0.6–0.9 cm long.
- Distributed in Sumatra, Java, Borneo, Philippines and Celebes; on lowland
 and hills, to 1600 m. In Malaya previously only from Perlis and Langkawi;
 probably restricted to limestone. Recently recorded from Limestone in Perak.
- Tinomiscium petiolare* Miers ex Hk.f. et Thoms, in Hk.f. F.B.I. 1:97. 1875;
 Ridl., Fl. 1:105. 1922; Bakk., Fl. Java. 1:157. 1963.
- Tinospora crispa* (L.) Miers ex Hk.f. et Thoms., in Hk.f., F.B.I. 1:96. 1875;
 Ridl., Fl. 1:103. 1922; Bak., Fl. Java, 1:157. 1963.

MONIMIACEAE

- Kibara chartaceae* Bl., Mus. Bot. Lugd. Bat. 2:89. 1856; Ridl., Fl. 3:74. 1924;
 Henders., J. Mal. Br. R. As. Soc. 17:67. 1939.
- Once from limestone on Bukit Cheras, Pahang (Henderson 25070).

MORACEAE

1. Flowers inside urceolate receptacles; the figs 2
 Flowers not so enclosed 25
2. Root-climbers. Leaves distichous 3
 Shrubs or trees; rarely scandent. Leaves very rarely distichous 5

3. Leaves glabrous *Ficus sagittata*
 Leaves pubescent especially on the lower surface 4
4. Leaves 7–10 by 5–7.5 cm; figs in axillary pairs
 *Ficus trichocarpa* var *obtusata*
 Leaves 12–25 by 7–10 cm; figs in small clusters *Ficus villosa*
5. Strangling figs; trunks composed of interlacing and anastomosing roots usually
 ramifying over rock faces and into clefts 6
 Not strangling figs; trunks normal 15
6. Figs mostly on twigs and small branches behind the leaves 7
 Figs in leaf-axils, in pairs or solitary 8
7. Leaves ovate, elliptic-ovate or ovate-oblong, broadest towards the base; figs
 subsessile or with a peduncle to 1.5 cm long *Ficus superba* var *japonica*
 Leaves elliptic-obovate, broadest in the upper half, figs sessile
 *Ficus virens* var. *glabella*
8. Figs with a peduncle 0.2–2 cm long 9
 Figs sessile 10
9. Leaves large, 15–55 cm long; lateral veins 12–20 pairs *Ficus annulata*
 Leaves smaller, 4–13 cm long; lateral veins 3–9 pairs
 *Ficus tinctoria* subsp. *gibbosa*
10. Basal pair of veins slightly or distinctly elongate, to $\frac{1}{4}$ or $\frac{1}{2}$ the lamina, meeting
 the midrib at a smaller angle than the other veins 11
 Basal pair of veins not elongate 12
11. Basal bracts large, yellow, covering one-third of fig; fig 1.2–1.8 cm across;
 leaves elliptic-oblong to elliptic-obovate *Ficus sundaica*
 Basal bracts small; figs 0.4–1 cm across; leaves lanceolate-acuminate
 *Ficus binnendykii*
12. Stipules long 8–30 cm; basal bracts not permanent; sapling leaves to 30 by
 15 cm *Ficus elastica*
 Stipules shorter; basal bracts permanent; sapling leaves never as large ... 13
13. Basal bracts 0.3–1 cm long; figs 1.5–1.8 cm across *Ficus stricta*
 Basal bracts smaller, 0.1–0.5 cm long; figs smaller, 0.6–1.2 cm across 14
14. Leaves small, 3–7 (–10) by 1.8–3.5 (–5) cm; basal bracts 0.1–0.35 cm long
 *Ficus microcarpa*
 Leaves larger, 10–17 by 5–8 cm; basal bracts 0.3–0.5 cm long
 *Ficus curtipes*
15. Figs from trunk or main branches, on tubercles or woody, leaflets twigs ... 16
 Figs from leaf-axils or very rarely from twigs behind the leaves 21
16. Leaf-base more or less equal sided 17
 Leaf-base very asymmetrical; figs from long sprays or on runners near the
 base of tree *Ficus semicordata*

17. Leaves hispid-pubescent with stiff white hairs; figs from pendulous twigs to 1 m long *Ficus hispida*
 Not as above 18
18. Leaves coarsely toothed; figs large, 3.5–7 cm across *Ficus oligodon*
 Leaves not toothed 19
19. Leaves acuminate-cuspidate; shrubs or small trees; figs 1.5–3.5 cm across ... 20
 Leaves blunt; a tall tree, figs larger, 3–5 cm across *Ficus racemosa*
20. Figs 2.5–3.5 cm across, ripening russet-brown; in branched paniculate clusters 25–50 cm across *Ficus botryocarpa*
 Figs 1.5–2.5 cm across, with 5 ribs radiating from the base, ripening yellow-red; in compact clusters 5–10 cm across *Ficus scortechinii*
21. Leaves, lower surface rusty pubescent, 3-nerved from the base
 *Ficus parietalis*
 Leaves, lower surface not pubescent 22
22. Figs sessile; a tree, common on Bukit Takun, Selangor *Ficus calcicola*
 Figs stalked; shrubs, erect or scandent 23
23. Leaves coarsely serrate, scabrid all over *Ficus montana*
 Leaves not serrate, sometimes angular or lobed, not scabrid 24
24. Leaves 2–10 by 1–5 cm, elliptic, oblong or obovate, commonly angular, apex acute, blunt or emarginate, midrib sometimes forked *Ficus deltoidea*
 Leaves 10–26 by 3.5–12 cm, oblong or obovate, not angular, apex never emarginate, midrib never forked *Ficus subulata*
25. Erect; shrubs or small trees 26
 Scandent; woody climber *Malaisia scandens*
26. Male inflorescences in heads, female flowers solitary; leaf-margins not spiny-toothed 27
 Male inflorescences spicate or racemose, 1–5 cm long, female flowers solitary or 2–6 in an inflorescence; leaf-margins often spiny-toothed 28
27. Plant spiny; fruiting perianth much longer than the fruit, 1.5–3 cm long
 *Streblus taxoides*
 Plant not spiny; fruiting perianth shorter or as long as the fruit, 0.5–0.8 cm long *Streblus asper*
28. Male flowers sessile; male spikes with a sterile groove; female inflorescence 2–6 flowered; bracts reniform *Streblus ilicifolius*
 Male and female flowers pedicellate; male racemes without a sterile groove; female flowers solitary; bracts peltate *Streblus laxiflorus*

Ficus annulata Bl., Bijdr. (1825) 448; Ridl., Fl. 3:333. 1924; Henders., J. Mal. Br. R. As. Soc. 17:73. 1939; Corner, Gard. Bull. S. 21:12. 1965.

Ficus binnendykii Miq., Ann. Mus. Lugd. Bat. 3:288. 1867; Ridl., Fl. 3:336. 1924; Corner, Gard. Bull. S. 21:20. 1965.

Ficus botryocarpa Miq., Ann. Mus. Bot. Lugd. Bat. 3:233. 1867; Corner, Gard. Bull. S. 21:86. 1965.

F. miquelii King, in Hk.f., F.B.I. 5:524. 1888; Ridl., Fl. 3:341. 1924; Henders., J. Mal. Br. R. As. Soc. 17:73. 1939; Corner, Way. Trees 1:685. 1952.

Ficus calcicola Corner, Gard. Bull. S. 17:392. 1959, *ibid.* 21:19. 1965.

Small tree 3–5 m tall, on limestone rocks and also epiphytic. Branches and trunk pale. Leaves elliptic, elliptic-oblong or elliptic-ovate, coriaceous, 5–13 by 2.7–5.5 cm; lateral nerves 5–8 pairs, the basal pair to one-quarter or one-third length of lamina. Petiole and veins on the lower surface of young leaves brown pubescent, soon becoming glabrous. Figs axillary in pairs or single, sessile, subglobose or subpyriform, 0.7–1 cm across. Male, female and gall flowers in the same fig.

Distributed in Burma and Thailand; a species restricted to limestone and usually found on dry craggy summits of hills; common on Bukit Takun, Selangor.

Ficus curtipes Corner, Gard. Bull. S. 17:397. 1959, *ibid.* 21:22. 1965.

F. obtusifolia Roxb., Fl. Ind. 3:546. 1832; Ridl., Fl. 3:335. 1924; Henders., J. Mal. Br. R. As. Soc. 17:73. 1939.

Tree, epiphytic when young. Leaves thickly coriaceous, elliptic-oblong or obovate, apex rounded and blunt, base cuneate, glabrous 10–17 by 5–8 cm; secondary lateral veins almost as prominent as the primary laterals. Figs in axillary pairs sessile, globose, yellow or orange or pinkish, about 1–1.2 cm across; basal bracts 3, each 0.3–0.5 cm long.

Distributed in N.E. India, Burma, Indochina, Thailand and Sumatra. In Malaya, uncommon, only from Kedah and Perlis, usually on limestone.

Ficus deltoidea Jack, Mal. Misc. 2:71. 1822; Corner, Gard. Bull. S. 17:17:420. 1959, *ibid.* 21:37. 1965.

F. diversifolia Bl. in Ridl., Fl. 3:346. 1924; Henders., J. Mal. Br. R. As. Soc. 17:73. 1939; Corner Way. Trees 1:687. 1952.

Ficus elastica Roxb. ex Hornem, Hort. Beng. (1819) 65; Ridl., Fl. 3:334. 1924; Henders., J. Mal. Br. R. As. Soc. 17:73. 1939; Corner, Way. Trees 1:677. 1952; Gard. Bull. S. 21:24. 1965.

Distributed in India, Burma, Sumatra and Java, often cultivated. Wild in the north of Malaya. Also widely cultivated. Recorded from limestone at Baling and Ipoh; the Ipoh specimen (Curtis 3305) was collected in 1898 and thought by Curtis to be an undoubtedly wild tree. All other authors have however doubted his conclusion, probably, because this tree has been widely cultivated and easily escapes from cultivation and there has been no other authentic records of wild plants from Malaya (except in the extreme north). We will probably never know the truth about the origin of Curtis's tree, though I do not see why it could not have been wild. The limestone areas have often proved to be the southernmost refuge of many plants whose home has otherwise been further north.

- Ficus hispida* L.f., Supp. (1781) 442; Ridl., Fl. 3:342. 1924; Henders., J. Mal. Br. R. As. Soc. 17:73. 1939; Corner, Way Trees 1:685. 1952, Gard. Bull. S. 21:89. 1965.
- Ficus microcarpa* L.f., Spp. (1781) 442; Corner, Gard. Bull. S. 17:397. 1959. *ibid.* 21:22. 1965; Condit, *Ficus* (1969) 146.
- F. retusa* Linn. in Ridl., Fl. 3:335. 1924; Corner, Way Trees 1:679. 1952.
- Ficus montana* Burm. f., Fl. Ind. (1768) 226; Corner, Gard. Bull. S. 17:453. 1959, *ibid.* 21:64. 1965.
- F. quercifolia* Roxb., Fl. Ind. 3:534. 1832; Ridl., Fl. 3:339. 1924.
- Ficus oligodon* Miq., Ann. Mus. Bot. Lugd. Bat. 3:234. 1867; Corner, Gard. Bull. S. 21:82. 1965.
- F. pomifera* Wall. ex King, in Ridl., Fl. 3:350. 1924; Henders., J. Mal. Br. R. As. Soc. 17:73. 1939.
- Ficus parietalis* Bl., Bijdr. (1825) 462; Ridl., Fl. 3:330. 1924; Henders., J. Mal. Br. R. As. Soc. 17:73. 1939; Corner, Gard. Bull. S. 21:77. 1965.
- Ficus racemosa* L.f., Suppl. (1753) 442; Corner, Gard. Bull. S. 21:34. 1965.
- P. glomerata* Roxb., Pl. Corom. 2:13. 1798; Corner, Way Trees 1:684. 1952.
- Ficus sagittata* Vahl., En. 2:185. 1806; Corner, Gard. Bull. S. 18:11. 1960, *ibid.* 21:55. 1965.
- F. ramentacea* Roxb., Fl. Ind. 3:547. 1832; Ridl., Fl. 3:345. 1924.
- Ficus scortechinii* King, Ann. Bot. Gard. Calc. 1:112. 1888; Ridl., Fl. 3:343. 1924; Henders., J. Mal. Br. R. As. Soc. 17:73. 1939; Corner, Way Trees 1:686. 1952, Gard. Bull. S. 21:94. 1965.
- Ficus semicordata* B. Ham. ex J.E. Smith, Rees Cyclop. 14:71. 1810; Corner, Gard. Bull. S. 17:449. 1959.
- F. cunia* B. Ham. ex Roxb., Fl. Ind. 3:561. 1832; Ridl., Fl. 3:341. 1924.
- Ficus stricta* Miq., Ann. Mus. Bot. Lugd. Bat. 3:266. 1867; Back., Fl. Java. 2:24. 1965; Corner, Gard. Bull. S. 21:21. 1965.
- Ficus subulata* Bl., Bijdr. (1825) 461; Ridl., Fl. 3:329. 1924; Back., Fl. Java. 2:26. 1965; Corner, Gard. Bull. S. 21:76. 1965.
- Ficus sunndaica* Bl., Bijdr. (1825) 450; Corner, Gard. Bull. S. 17:389. 1959. *ibid.* 21:18. 1965.
- F. indica* sensu King (not of L.) in Hk.f., F.B.I. 5:506. 1885; Corner, Way Trees 1:678. 1952.
- Ficus superba* Miq., Ann. Mus. Bot. Lugd. Bat. 2:200. 1867; Corner, Way Trees 1:679. 1952.
- var. *japonica* Miq., in Corner, Gard. Bull. S. 21:7. 1965.

Ficus tinctoria Forst. f., Prodr. Fl. Aust. (1786) 76.

subsp. *gibbosa* (Bl.) Corner, Gard. Bull. S. 17:476. 1959, *ibid.* 21:74. 1965. *F. gibbosa* Bl., in Ridl., Fl. 3:329. 1924; Henders., J. Mal. Br. R. As. Soc. 17:73. 1939; Corner, Way. Trees 1:677. 1952.

Ficus trichocarpa Bl., Bijdr. (1825) 458.

var. *otusa* (Hassk.) Corner, Gard. Bull. S. 18:19. 1960, *ibid.* 21:59. 1965.

F. obtusa Hassk., Cat. Hort. Bogor. (1844) 75; Ridl., Fl. 3:344. 1924. Henders., J. Mal. Br. R. As. Soc. 17:73. 1939.

Ficus villosa Bl., Bijdr. (1823) 441; Ridl., Fl. 3:345. 1924; Henders., J. Mal. Br. R. As. Soc. 17:74. 1939; Corner, Gard. Bull. S. 21:56. 1965.

Ficus virens Ait., Hort. Kew 3:451. 1789.

var. *glabella* (Bl.) Corner, Gard. Bull. S. 17:377. 1959, *ibid.* 21:9. 1965.

F. glabella Bl., in Ridl., Fl. 3:336. 1924; Henders., J. Mal. Br. R. As. Soc. 17:73. 1939; Corner, Way. Trees 1:677. 1952.

Malaisia scandens (Lour.) Planch., in Merr., Fl. Manila (1912) 176; Corner, Gard. Bull. S. 19:240. 1962; Back., Fl. Java 2:15. 1965.

M. tortuosa Blanco, in Ridl., Fl. 3:325. 1924.

Streblus asper Lour., Fl. Cochinch. 2:615. 1790; Ridl., Fl. 3:323. 1924;

Henders., J. Mal. Br. R. As. Soc. 17:74. 1939; Corner, Way Trees 1:692. 1952. Gard. Bull. S. 19:228. 1962.

Streblus ilicifolius (Vidal) Corner, Gard. Bull. S. 19:227. 1962.

Taxotrophis ilicifolius Vidal, Rev. Pl. Vasc. Filip. (1886) 249; Ridl., Fl. 3:322. 1924; Corner, Way Trees 1:693. 1952.

The commonest species of *Streblus* on limestone. Often abundant on dry rocky slopes.

Streblus laxiflorus (Hutch.) Corner, Gard. Bull. S. 19:229. 1962.

Taxotrophis eberhardtii Gagn., Fl. Gen. Indochina 5:700. 1928.

T. laxiflora Hutch., Kew Bull. (1918) 151.

Streblus taxoides (Heyne) Kurz., For. Fl. Burma 2:465. 1877; Corner, Gard. Bull. S. 19:225. 1962.

Phyllochlamys spinosa (Roxb.) Bur., in DC., Prodr. 17:218. 1873; Ridl., Fl. 3:323. 1924.

P. wallichii King, in Hk.f., F.B.I. 5:489. 1888; Ridl., Fl. 3:322. 1924.

MYRISTICACEAE

1. Leaves glaucous or sub-glaucous beneath. Inflorescence a short woody axis or tubercle 2
 Leaves not glaucous. Inflorescence a branched panicle 5–10 cm long
 *Horsfieldia tomentosa*
2. Twigs and petioles when young densely woolly; hairs 0.2–0.5 cm long
 *Knema hookeriana*
 Twigs and petioles when young not densely woolly but tomentose, pubescent or glabrous, hairs less than 0.2 cm long 3
3. Matures leaves stellate-pubescent beneath. Anthers sessile
 *Knema laurina*
 Matured leaves glabrous beneath. Anthers sessile or stalked 4
4. Twigs pale strawcoloured. Fruits ellipsoid, 2.5–4.5 by 1–1.3 cm
 *Knema cinerea* var. *rubens*
 Twigs darker, brownish or black 5
5. Twigs smooth shining reddish-brown. Fruit ellipsoid, 3–4 by 1.8–2.2 cm
 *Knema intermedia*
 Twigs dull, rough or striate, dark brown or black 6
6. Coastal tree. Leaves 8–17 by 1.5–5 cm, thinly coriaceous. Fruit sub-globose, 1.5–2 by 1.3–1.5 cm *Knema globularia*
 Not coastal. Leaves 7–23 by 3–7.5 cm, coriaceous. Fruit ellipsoid, 1.3–1.5 by 1.0–1.3 cm *Knema cinerea* var. *patentinervia*

Horsfieldia tomentosa Warb., Monog. Myrist. (1897) 302; Ridl., Fl. 3:56. 1924.
 Sinclair, Gard. Bull. S. 16:403. 1958.

Knema cinerea (Poir.) Warb., Monog. Myrist. (1897) 611; Sinclair, Gard. Bull. S. 18:169. 1961.

var. *patentinervia* (Sinclair) Sinclair, Gard. Bull. S. 18:182. 1961.

Knema glaucescens Jack var. *patentinervia* Sinclair, Gard. Bull. S. 16:308. 1958.

Myristica glaucescens (Jack) Hk.f. et Th., F.B.I. 5:111. 1886.

var. *rubens* (Sinclair) Sinclair, Gard. Bull. S. 18:185. 1961.

Khema glaucescens Jack. f. *rubens* Sinclair, Gard. Bull. Sing. 16:307. 1958.

Knema globularia (Lamk.) Warb., Monog. Myrist. (1897) 601; Sinclair, Gard. Bull. S. 16:325. 1958, *ibid.* 18:214. 1961.

Myristica globularia Lamk., Mem. Ac. Paris (1788) 162.

K. missionis (King) Warb., in Ridley, Fl. 3:71. 1924; Henders., J. Mal. Br. R. As. Soc. 17:67. 1939.

Knema hookeriana (Hk.f. et Th.) Warb., Monog. Myrist. (1897) 551; Ridl., Fl. 3: 67. 1924; Sinclair, Gard. Bull. S. 16:272. 1958, *ibid.*, 18:226. 1961.

Myristica hookeriana Hk.f. et. Th., in F.B.I. 5:109. 1886.

Knema intermedia (Bl.) Warb., Monog. Myrist. (1897) 564 T. 25; Ridl., Fl. 3: 68. 1924; Sinclair, Gard. Bull. 16:315. 1958, *ibid.* 18:227. 1961.

Knema laurina (Bl.) Warb., Monog. Myrist. (1897) 606; Ridl., Fl. 3:72. 1924. Henders., J. Mal. Br. R. As. Soc. 17:67. 1939; Sinclair, Gard. Bull. S. 16:329. 1958, *ibid.* 18:248. 1961.

MYRSINACEAE

Seventeen species of *Ardisia* are recorded from limestone, of which thirteen are very rare or uncommon; *A. lankawiensis* and *A. meziana* are known only from a single collection each and the other eleven though known from more than a single collection each are poorly represented in the herbarium. Only *A. colorata*, *A. crenata*, *A. lanceolata* and *A. villosa* are fairly common, or common plants.

Much of the information used in the making of this key is extracted from King and Gamble's Materials, and Ridley's Flora. The latter also has a key to the Malayan species; this key however has poor leads which do not sufficiently distinguish the various species. Another reason, perhaps, is that some of the species should not be kept distinct.

This key therefore goes only as far as material will allow and is incomplete; more field work and research are required; *A. kunstleri*, *A. solanacea* and *A. oxyphylla* especially are rather similar in many respects.

1. Scandent shrubs 2
Erect subshrubs, shrubs or trees 3
2. Leaves obovate; flowers 4-merous, ovary superior; fruit 1-seeded. Very rare. Only from Langkawi *Embelia calcarea*
Leaves elliptic or elliptic-oblong; flowers 5-merous, ovary inferior; fruit many seeded. Not recorded from Langkawi *Maesa striata*
3. Apex of leaves gradually tapered or shortly acute or acuminate. Flowers at the end of a 2 cm or more, peduncle; rarely shorter; not as below 4
Apex of leaves rounded, bluntly acute to slightly emarginate. Flowers on axillary cone-like bracteate branches, 0.3-0.6 cm long *Myrsine porteriana*
4. Ovary superior; fruit with a single seed 5
Ovary inferior; fruit with many seeds *Maesa pahangiana*
5. Inflorescence sessile or with a very short peduncle 6
Inflorescence with a peduncle 1 cm or more long 7
6. Herbaceous subshrubs, 30-60 cm tall. Leaves elliptic-obovate, apex abruptly acuminate. Inflorescence axillary, long most of the stem ... *Ardisia meziana*
Shrub or small tree, to 5 m. Leaves oblong-lanceolate, apex long acuminate. Inflorescence axillary, in the axils of the uppermost leaves ... *Ardisia ridleyi*

Ardisia lanceolata Roxb., Hort. Beng. (1814) 85; K. & G., Mats. 17:134. 1905; Ridl., Fl. 2:249. 1923; Henders., J. Mal. Br. R. As. Soc. 17:53. 1939; Corner, Way Trees 1:481. 1952.

Ardisia lankawiensis K. et G., Mats. 17:125. 1905; Ridl., Fl. 2:251. 1923; Henders., J. Mal. Br. R. As. Soc. 17:53. 1939.

A tree. Leaves coriaceous, elliptic or elliptic-lanceolate, glabrous, entire, 8–12 by 3–4 cm. Inflorescence with a 7–9 cm long, flattened peduncle; flowers in dense racemes, corolla-lobes ovate-acuminate, 0.7 cm long. Drupe depressed globose, 0.5 cm across.

Endemic and known from a single specimen Ridley & Curtis 9313, 'in woods, opposite Kuah'. The part of Pulau Dayang Bunting facing Kuah is chiefly limestone cliffs with short stretches of sandy beach and some mangrove at Telok Penaga. It is therefore likely that this specimen was from limestone; Henderson l.c., also thinks so.

Ardisia meziana K. et G., Mats. 17:147. 1905; Ridl., Fl. 2:253. 1923; Henders., J. Mal. Br. R. As. Soc. 17:53. 1939.

Sub-shrub, 30–60 cm. Leaves chartaceous, elliptic-obovate, glabrous above, sparsely pubescent below, margin crenate-dentate, 8–14 by 3–5 cm. Inflorescence axillary, of racemes 0.2–0.4 cm long about 6-flowered; flowers waxy-white. Corolla-lobes about 0.2 cm long. Drupe unknown.

Endemic and known from a single specimen (King's collector, 5839); from Perak on limestone rocks in open jungle at 150–250 m. I have not seen this specimen.

Ardisia oxyphylla Wall, Cat. (1830) 2291; K. & G., Mats. 17:139. 1905; Ridl., Fl. 2:242. 1923; Henders., J. Mal. Br. R. As. Soc. 17:53. 1939.

Ardisia pendula Mez., Monog. Myrs. (1901) 125; K. & G., Mats., 17:140. 1905; Ridl., Fl. 2:244. 1923; Henders., J. Mal. Br. R. As. Soc. 17:53. 1939; Bak., Fl. Jav. 2:200. 1965.

Ardisia platyclada K. et G., Mats. 17:132. 1905; Ridl., Fl. 2:247. 1923; Henders., J. Mal. Br. R. As. Soc. 17:53. 1939.

Endemic and rare, in forest. Once from limestone.

Ardisia ridleyi K. et G., Mats. 17:148. 1905; Ridl., Fl. 2:253. 1923; Henders., J. Mal. Br. R. As. Soc. 17:53. 1939.

Ardisia solanacea Roxb., Hort. Beng. (1814) 16; K. & G., Mats. 17:137. 1905; Ridl., Fl. 2:242. 1923; Henders., J. Mal. Br. R. As. Soc. 17:53. 1939.

var. *elata* K. & G., l.c. 138.; Ridl., l.c.

Rare; the species is distributed in India and Burma. Recorded from limestone in Perak and Langkawi.

Ardisia tahanica K. et G., Mats. 17:143. 1905; Ridl., Fl. 2:242. 1923.

Endemic and uncommon, in lowland and hill forest. Once from limestone.

Ardisia vaughani Ridl., Fl. 2:248. 1923; Henders., J. Mal. Br. R. As. Soc. 17:54. 1939; Furt., Gard. Bull. S. 17:302. 1958.

Endemic, not common, in lowland forest. From limestone only on Gunong Baling, Kedah.

Ardisia villosa Roxb., Hort. Beng. (1814) 85; Ridl., Fl. 2:251. 1923; Sinclair, Gard. Bull. 15:29. 1956.

Embelia calcarea Fletcher, Kew Bull. (1936) 44; Henders., J. Mal. Br. R. As. Soc. 17:54. 1939.

Scrambling shrub. Leaves obovate, apex obtuse, base long acuminate, subcoriaceous, glabrous on both sides, 9–18 by 5–7 cm. Petiole 1.5–2 cm. Inflorescence lateral, spike-like. Flowers 4-merous; calyx-lobes ovate-obtuse, 0.2 by 0.15 cm. Fruit globose, about 1.2 cm across.

Endemic and known from a single record from Langkawi. I have not seen this specimen.

Maesa pahangiana K. et G., Mats. 17:98. 1905; Ridl., Fl. 2:229. 1923; Henders., J. Mal. Br. R. As. Soc. 17:54. 1939.

Endemic, uncommon, usually along stream banks. Recorded from limestone in Kelantan and Perak.

Maesa striata Mez., Monog. Myrs. (1901) 42; K. & G., Mats. 17:98. 1905; Ridl., Fl. 2:228. 1923.

Myrsine porteriana Wall., Cat. (1832) 6525; K. & G., Mats. 17:101. 1905; Ridl., Fl. 2:230. 1923; Henders., J. Mal. Br. R. As. Soc. 17:54. 1939; Corner, Way Trees 1:482. 1952.

A plant of rocky and sandy coastal areas, also on mountain tops to 1700 m. Common on the Bukit Takun and Anak Takun limestone, Selangor; also on limestone in Kedah and Kelantan.

MYRTACEAE

- | | |
|---|--------------------------------|
| 1. Leaves spirally arranged, fruit a capsule | 2 |
| Leaves opposite, fruit a drupe or berry | 4 |
| 2. Leaves with a single midrib; flowers in axillary cymes or panicles | 3 |
| Leaves with 5–7 prominent longitudinal veins; flowers in spikes | |
| | <i>Melaleuca cajuputi</i> |
| 3. Base of leaf auricled; inflorescence 1.2–2 cm long | |
| | <i>Tristania subauriculata</i> |
| Base of leaf not auricled; inflorescence 3.5–5 cm long | |
| | <i>Tristania merguensis</i> |
| 4. Twigs and young leaves pubescent; young leaves often silvery white | |
| | <i>Decaspermum fruticosum</i> |
| Twigs and leaves glabrous | 5 |

5. Base of leaf rounded and slightly cordate. Inflorescence 1-2 (-3?) flowered *Eugenia porphyranthera*
 Base of leaf cuneate, rarely rounded, never cordate 6
6. Primary nerves numerous, 15-30 pairs 7
 Primary nerves fewer, 10-15 pairs 8
7. Flowers in short condensed corymbs, 2.5-5 cm across, calyx tube funnel shaped *Eugenia claviflora*
 Flowers in expanded panicles to 8 cm long; calyx tube not or only slightly tapered *Eugenia chlorantha*
8. Leaves small, 4-9 by 1.5-4 cm, base broadly cuneate or rounded
 *Eugenia spicata*
 Leaves large, 10-20 by 4-8 cm, base cuneate *Eugenia pendens*

Decaspermum fruticosum J.R. et G. Forster, Char. Gen. Pl. (1776) 74, t 37; Back., Fl. Java 1:335. 1963.

D. paniculatum (Lindl.) Kurz., J. As. Soc. Beng. 46:61. 1877; Ridl., Fl. 1:717. 1922.

Eugenia chlorantha Duthie, in Hk. f., F.B.I. 2:478. excl. syn.; Ridl., Fl. 1:734. 1922; Henders., Gard. Bull. S. 12:107. 1949.

Eugenia claviflora Roxb., Fl. Ind., 2:488. 1832; Hk.f., F.B.I. 2:484. 1879; Ridl., Fl. 1:742. 1922; Henders., Gard. Bull. S. 12:252. 1949.

Eugenia pendens Duthie, in Hk.f., F.B.I. 2:475. 1878; Ridl., Fl. 1:726. 1922; Henders., Gard. Bull. S. 12:71. 1949.

Eugenia porphyranthera Ridl., J.R. As. Soc. Str. Br. 61:8. 1912; Fl. 1:727. 1922; Henders., Gard. Bull. S. 12:59. 1949.

Endemic and uncommon, found only in Selangor and Pahang. Recorded once from limestone (Chin 1031 from Bukit Serdam, Pahang).

Eugenia spicata Lamk., Encycl. Bot. 3:201. 1789; Henders., J. Mal. Br. R. As. Soc. 17:45. 1939; Gard. Bull. S. 12:231. 1949.

E. zeylanica Wight., Ridl., Fl. 1:738. 1922.

Melaleuca cajuputi Powell, Pharm. Lond. Transl. (1809) 22; Ridl., Fl. 1:713. 1922; Corner, Ways Trees 1:506. 1952; Blake, Contr. Qd. Herb 1:22. 1968.

Tristania merguensis Griff., J. As. Soc. Beng. (1854) 637; Ridl., Fl. 1:715. 1922; Henders., J. Mal. Bl. As. Soc. 17:45. 1939.

Tristania subauriculata King., J. As. Soc. Beng. 70:66; Ridl., Fl. 1:714. 1922; Henders., J. Mal. Br. R. As. Soc. 17:45. 1939.

Endemic and known from two records only, one is from limestone (King's coll. 8253 from Kuala Dipang, Perak).

NEPENTHACEAE

Nepenthes sp.

A species of *Nepenthes* was observed on Gunong Tempurong, Perak on a recent trip. The plant was climbing on low vegetation and probably rooted in the fairly thick peaty layer which had accumulated over the limestone. This is the only record of *Nepenthes* from limestone hills in Malaya. Unfortunately no material was collected.

Anderson (1965) writing on limestone habitat in Sarawak noted that a shallow acidic 'mor' layer is often found on the summits of limestone hills, where the vegetation is undisturbed. He further noted that the vegetation is more calcifugal than calciphylous in character and in floristic composition has affinities to the low altitude heath forests of Borneo. The species found on low altitude hills include *Casuarina sumatrana*, *Nepenthes albomarginata*, *Pandanus* spp., *Rhododendron brookeanum*, *Vaccinium borneense* and *Vaccinium lobbii*. I have however not noticed any similar accumulation of such 'calcifugal' species on any of the Malayan limestone hills though no doubt such acidic 'mor' layer exist in localised spots on many hills. It is also possible that some of the larger and as yet unexplored hills may support such a 'calcifugal' vegetation.

NYCTAGINACEAE

1. Plant with recurved axillary thorns; climber. Fruit (anthocarp) with 5 biserial rows of soft viscid prickles *Pisonia aculeata*
Plant not thorny 2
2. Herbs or subshrub, scandent. Leaves opposite, one of each pair reduced. Fruit (anthocarp) glandular but not viscid *Boerhavia chinensis*
Tree. Leaves opposite often in pseudowhorls. Fruit (anthocarp) with 4-5 viscid ribs *Pisonia umbellifera*

Boerhavia chinensis (L.) Aschers. & Schweinf., Beitr. Fl. Aeth. 1:167. 1867; Stemmerik, Fl. Mal. I, 6:455. 1964.

B. repanda Willd., Sp. Pl. I, 1:22. 1797; Ridl., Fl. 3:2. 1924; Henders., J. Mal. Br. R. As. Soc. 17:66. 1939.

Herb or subshrub, erect or scandent. Leaves 2.5-4.5 by 1.5-4 cm, base broad to cordate. Flowers in umbels. Perianth 1-1.2 cm long. Anthocarp elongate, 0.7-0.8 cm, 10-ribbed, with conspicuous glands.

Distributed in India to Burma and southwards to Java, Lesser Sunda Islands and Moluccas. In Malaya, this species is only known from two collections (Henderson 23115 and Ridley 15153) recorded from Bukit Chupeng cave mouth, Perlis in 1929. It has not been found again.

Pisonia aculeata L. Sp. Pl. (1753) 1026; Ridl., Fl. 3:3. 1924; Henders., J. Mal. Br. R. As. Soc. 17:66. 1939; Stemmerik, Fl. Mal. I, 6:467. 1964.

Woody climber, thorny. Leaves subopposite, elliptic 4–10 by 1–5 cm. Flowers unisexual in dense, cymose, axillary inflorescences; campanulate, urceolate 0.2 by 0.1 cm. Anthocarp club-shaped, 1.5 by 0.2 cm, with 5 ribs, each bearing a biserial row of glandular appendages, later viscid.

Distributed throughout most of the tropics. Generally coastal in rocky places and along forest fringes in dry places. In Malaya, recorded only from limestone in Perlis and Langkawi.

Pisonia umbellifera (Forst.) Seem., Bonplandia 10:154. 1862; Stemmerik, Fl. Mal. I, 6:460. 1964.

P. excelsa Bl., in Ridl., Fl. 3:3. 1924; Henders., J. Mal. Br. R. As. Soc. 17:66. 1939.

Tree, to 28 m tall. Leaves opposite, sometimes in pseudowhorls towards the ends of twigs, 9–23 by 4–11 cm. Inflorescences terminal in umbels. Flowers bisexual or unisexual, perianth 0.3–0.7 cm. Anthocarp 2–4 by 0.3 cm, with 5 viscid ribs.

Distributed from Madagascar, Mauritius, Andaman Islands, to Formosa and throughout Malesia and into Polynesia. Often in coastal areas. In Malaya, it is restricted to limestone, usually at the bases of hills where there is fairly deep soil and in gullies on hill slopes. Only from Perak and Pahang.

OCHNACEAE

Gomphia serrata (Gaertn.) Kanis, Taxon 16:422. 1967, Blumea 16:53. 1968.

G. microphylla Ridl., Fl. 1:365. 1922; Henders., J. Mal. Br. R. As. Soc. 17:39. 1939.

G. sumatrana Jack, in Ridl., Fl. 1:365. 1922.

OLEACEAE

- | | |
|---|---------------------------|
| 1. Climbers or sprawling shrubs | 2 |
| Erect shrubs or trees | 9 |
| 2. Leaves 3-veined from the base, the two lateral veins slender and sometimes faint | 3 |
| Leaves pinnately veined | 5 |
| 3. Leaves coriaceous, margin revolute | <i>Jasminum insularum</i> |
| Leaves thinly coriaceous, margin not revolute | 4 |

4. Leaves tapered to a very blunt-rounded tip *Jasminum* sp. A.
 Leaves acute, if blunt, not distinctly tapered *Jasminum* sp. B.
5. Calyx lobes 0.3–0.6 cm long 6
 Calyx lobes 1–1.2 cm long 8
6. Leaves small 3–8 cm long; flowers solitary or in small clusters to 12 together 7
 Leaves large 7–17 cm long; flowers 15–20 together *Jasminum wrayi*
7. Leaves; veins obscure, blade firm, drying smooth and even; flowers 1–3 together *Jasminum cordatum*
 Leaves; veins distinct, blade thin, drying undulate and uneven; flowers 4–12 together *Jasminum bifarium*
8. Flowers 1–2(–3) together *Jasminum adenophyllum*
 Flowers 15–20 together *Jasminum curtisii*
9. Inflorescence 2.5–12 cm long; corolla lobes valvate *Ligustrum confusum*
 Inflorescence 1.2 cm long; corolla lobes imbricate *Osmanthus scortechinii*

Jasminum adenophyllum Wall., Cat. (1831) 2876; K. & G., Mats. 17:261. 1905; Ridl., Fl. 2:314. 1923; Henders., J. Mal. Br. R. As. Soc. 17:55. 1939.

Jasminum bifarium Wall., Cat. (1831) 2866; K. & G., Mats. 17:260. 1905; Ridl., Fl. 2:313. 1923; Henders., Mal. Wildfls. Dicots. (1959) 276.

Jasminum cordatum Ridl., Kew Bull. (1926) 473; Henders., J. Mal. Br. R. As. Soc. 17:55. 1939.

Shrubby climber; leaves opposite, coriaceous, ovate to ovate-lanceolate; base cordate, 3–7 by 1.8–3 cm. Flowers in the axils of terminal pairs of leaves, 1–3(–4) together; corolla tube to 2.5 cm long; cylindrical; lobe 7, oblong-acute. Drupe oblong.

Endemic and restricted to limestone. Only from Perak and Selangor; rare.

Jasminum curtisii K. & G., Mats., 17:259. 1905; Ridl., Fl. 2:312. 1923; Henders., J. Mal. Br. R. As. Soc. 17:55. 1939.

Climbing shrub (?). Leaves membranous ovate or ovate-oblong, glabrous except on the veins above and axils of the main nerves beneath, 7–12 by 2.5–5 cm. Flowers in a terminal cyme supported by leafy bracts 2.5–3 cm long; flowers in each cyme 15–20. Calyx-lobes 6, linear-subulate, 1.2 cm long. Corolla-tube 2.4 cm long, lobes 8–9; 1.2 cm long. Fruit unknown.

Endemic, known only from two collections, one from limestone in Perlis (Henderson 23010) and the other without data from near Ipoh, Perak.

Jasminum insularum Kerr., Kew Bull. (1938) 128; Craib, Fl. Siam 2:401. 1939.

Jasminum wrayi K. & G., Mats. 17:258. 1905; Ridl., Fl. 2:312. 1923; Henders., J. Mal. Br. R. As. Soc. 17:56. 1939.

Slender climbing shrub. Leaves membranous oblong or obovate-oblong, base rounded or cordate, glabrous except in the axils of the main nerves beneath, 7–17 by 3.5–6.5 cm. Flowers in terminal, 15–20 flowered cymes, bracts lanceolate-acuminate, 1.2 cm long. Calyx-lobes 0.6 cm long, corolla-tube about 2 cm long, lobes 8–9. Fruit ovoid-globose.

Endemic, recorded from limestone from Perak and Kelantan, also from non-limestone fields. Uncommon.

Jasminum sp. A. aff. *J. trinerve* Vahl.

This is represented by a sterile collection from Pulau Dayang Bunting limestone, Langkawi, Kedah (Stone 9144). The plant is a slender climber. Stem and leaves glabrous. Leaves ovate, base rounded to cordate; apex, very blunt but with a mucronate tip, 1.5–3.8 by 0.7–1.7 cm. The identification has been provided by P.S. Green of Kew. *J. trinerve* which it resembles is described from Java.

Jasminum sp. B

Scandent shrub. Young twigs finely pubescent. Leaves opposite, thinly coriaceous, 3-veined from the base, ovate to ovate-lanceolate, glabrous; base rounded or cordate, apex acute or blunt, mucronulate, 2–5 by 1–2.4 cm. Petioles finely pubescent. Flowers axillary or terminal 1–3 together, lobes 6–10 oblong-acute or ovate-lanceolate, 1.5–2 cm long.

Known from three specimens, (Stone 6920, 6927 & 6986), all from the Langkawi limestone. It does not match any of the Malayan material, but should be compared with Thai material.

Ligustrum confusum Dcne., Nouv. Arch. Mus. Hist. Paris II, 2:24. 1879; Hk.f., F.B.I. 3:616. 1882; Craib, Fl. Siam 2:419. 1939; Henders., J. Ma. Br. As. Soc. 17:56. 1939; Kiew, Blumea 24:144. 1978.

Olea puberula Ridl., in Fl. 2:318. 1923.

L. robustum auct. non (Roxb.) Bl., in Merr., J. Arn. Arb. 35:150. 1954.

Straggling shrub to small tree, to 6 m. Leaves subcoriaceous, elliptic-lanceolate, about 8 by 2 cm. Panicles terminal 2.4–12 cm long, pubescent, bractless; flowers clustered, subsessile, corolla tube as long or slightly longer than calyx tube. Fruit olive-shaped, about 5 mm across.

Distributed in S. India, Indochina, Yunnan, Thailand. Uncommon, often on limestone. Common on Bukit Takun, Selangor.

Osmanthus scortechinii K. & G., Mats. 17:265. 1905; Ridl., Fl. 2:315. 1923.

Tree to 45 m. Leaves coriaceous, lanceolate, glabrous, margin recurved, 5–10 by 2–3.2 cm. Flowers in very short axillary racemes, to 1.2 cm long in fruit, 4-merous, calyx 0.1 cm long, corolla-tube 0.1 cm long, lobes 0.25 cm long, oblong; stamens 4. Drupe globose about 0.5 cm long.

Endemic and rare. Once from limestone. (Batu Neng, Kelantan, UNESCO 346).

ONAGRACEAE

Ludwigia hyssopifolia (G. Don) Exell., in Raven, Reinw. 6:385. 1963.

Jussiaea linifolia Vahl., Henders., Mal. Wildfls. Dicots. (1959) 148.

J. suffruticosa sensu Ridl., J. Bot. Lond. 59:257. 1921, non Linn. 1753, Fl. 1:827. 1922.

In wet places in the lowlands. Recorded from limestone by the edge of a stream at Tambun, Perak.

OXALIDACEAE

Biophytum adiantoides Wight ex Edgew. et Hk.f., F.B.I. 1:437. 1875; Ridl., Fl. 1:331. 1922; Henders., J. Mal. Br. R. As. Soc. 17:38. 1939.

Only from the north; usually on rocky streambanks in forest. Recorded once from limestone in Perlis ((Kiah 35246).

PASSIFLORACEAE

Pubescent. Leaves 3-lobed; flowers bisexual *Passiflora foetida* var. *hispida*

Glabrous. Leaves entire; flowers unisexual *Adenia nicobarica*

Adenia nicobarica (Kurz.) King, Mats. 13:52. 1902; Ridl., Fl. 1:840. 1922; Henders., J. Mal. Br. R. As. Soc. 17:49. 1939.

Modecca nicobarica Kurz., in Hk.f., F.B.I. 2:603. 1879.

Passiflora foetida L., Sp. Pl. (1753) 959; Ridl., Fl. 1:839. 1922; Henders., Mal. Wildfls. Dicots. (1959) 151.

var. *hispida* (DC.) Killip., Merr. & Perry, J. Arn, Arb. 27:325. 1946.

Common all over in waste ground. Recorded from disturbed areas on limestone.

PIPERACEAE

- | | |
|--|---|
| 1. Erect herbs | 2 |
| Climbers or shrubs | 6 |
| 2. Flowers sessile, fruits smooth; plants not rhizomatous | 3 |
| Flowers pedicelled, fruits with bristles; plants rhizomatous | |
| <i>Zippelia begoniaefolia</i> | |
| 3. Leaves alternate | 4 |
| Leaves opposite or in whorls | 5 |

4. Stem and leaves pubescent *Peperomia kotana*
 Stem and leaves glabrous *Peperomia* sp. A
5. Stem and leaves pubescent. Scattered on Pahang limestone, not common ...
 *Peperomia dindigulensis*
 Stem and leaves glabrous. Very rare, known only from one collection; Gua
 Batu, Selangor *Peperomia portulacoides*
6. Leaves 5–17 cm long; longer than broad, rarely as broad as long. Spikes
 solitary 7
 Leaves 15–30 cm long; as broad as long. Spikes fascicled
 *Piper umbellatum*
7. Climber 8
 Erect shrub *Piper boehmeriaefolia*
8. Leaves pubescent below, sometimes on the nerves only 9
 Leaves glabrous 10
9. Leaves broadly ovate to suborbicular *Piper porphyrophyllum*
 Leaves ovate or ovate-lanceolate *Piper caninum*
10. Leaves pinnately nerved 11
 Leaves palmately nerved, or 3-nerved from the base with the basal pair of
 nerves to half the length of leaves 13
11. Midrib with 3–5 pairs of nerves 12
 Midrib with 3 nerves on one side and 4 on the other. Very rare
 *Piper scortechinii*
12. Leaves; bases equal sided. Extremely rare *Piper collinum*
 Leaves; bases unequal sided *Piper retrofractum*
13. Leaves 5–9 nerved from the base *Piper nigrum*
 Leaves 3-nerved from the base, with one other pair higher up
 *Piper mucronatum*

Peperomia dindigulensis Miq., Syst. Pip. 1:122. 1843; Ridl., Fl. 3:26. 1924;
 Henders., J. Mal. Br. R. As. Soc. 17:66. 1939. Mal. Wildfls. Dicots (1959)
 435.

Herb 10–30 cm tall. Leaves opposite or in whorls of 3–4 pubescent, broadly
 elliptic, obovate suborbicular, 1.2–3.7 by 0.6–2.3 cm. Spikes 3–7 (–10) cm long,
 bisexual. Flowers unisexual. Stamens 2, from behind a scale like bract. Drupe
 very small, to 0.1 cm long.

Distributed in southern India. Restricted to limestone in Malaya, from
 Pahang and according to Ridley, from Gua Batu, Selangor. Found in shade on
 mossy rocks or in small pockets of soil.

Peperomia kotana C. DC., Rec. Bot. Surv. Ind. 6:2. 1912; Ridl., Fl. 3:27. 1924; Henders., J. Mal. Br. R. As. Soc. 17:66. 1939.

Peperomia sp. in Henders., J. Mal. Br. R. As. Soc. 17:66. 1939

Herb 10–20 cm tall, pubescent all over. Leaves alternate, petioles 0.4–0.7 cm long, blade obovate or suborbicular, 1.2–2.4 by 0.8–1.4 cm. Spike terminal 3–5 cm long. Flowers unisexual; male with 2 stamens. Drupe very small.

Endemic. Recorded from limestone in Kedah, Kelantan and Pahang and (not from limestone) in Pulau Tioman, Johore. Rare.

Peperomia portulacoides Dietr., in Sp. Pl. (1753) 172; Hk. f., F.B.I. 5:98. 1885; Ridl., Fl. 3:26. 1924; Henders., J. Mal. Br. R. As. Soc. 17:66. 1939.

Succulent glabrous herb. Leaves opposite or in whorls of 3–4, obovate or subrhomboid, 2.5–5 by 1.8–3 cm. Spikes 1–2 together, axillary or terminal, 3–6 cm long. Flowers unisexual. Male with 2 stamens.

Distributed in Southern India, Madagascar, Seychelles and Mauritius. Very rare in Malaya, according to Ridley, recorded from Gua Batu, Selangor. I have not seen the specimen.

Peperomia sp. A

A fleshy herb 15–30 cm tall, glabrous. Leaves alternate, ovate, broadly elliptic or suborbicular, thick fleshy, lower surface pale; margin when dried often undulate, 1.2–3 cm; veins 3–5 from the base, obscure, barely visible in dried or fresh material. Spikes terminal, solitary, slender, 4–10 cm long, peduncle 1–1.5 cm long. Flowers unisexual, subtended by an orbicular, peltate bract; male with 2 stamens. Fruit slightly less than 0.1 cm long, ovoid, ripening, dark green with a tinge of orange; when dried the surface is pimply.

Recorded from the west-slope, Bukit Anak Takun, growing from mossy rock crevices in shade. Thriving in several scattered patches in a narrow strip about 20 m long (Chin 539, Chin & Badaruddin 1695, Stone 14086).

This species seems to match a specimen in Singapore collected by L. Wray (709) from Maxwell's hill, Perak, prior to 1909 and which is unnamed.

Piper boehmeriaefolium Wall., Cat. (1832) 6654: Hk.f., F.B.I. 5:85. 1885; Ridl., Fl. 3:41. 1924; Henders., J. Mal. Br. R. As. Soc. 17:67. 1939.

Piper caninum Bl., Verh. Bat. Gen. 11:214. 1826; Hk.f., F.B.I. 5:82. 1885; Ridl., Fl. 3:38. 1924; Henders., J. Mal. Br. R. As. Soc. 17:67. 1939.

Piper collinum C.DC., Rec. Bot. Surv. Ind. 6:17. 1912; Ridl., Fl. 3:36. 1924; Henders., J. Mal. Br. R. As. Soc. 17:67. 1939.

Slender, glabrous climber to 4 m. Leaves membranous, elliptic-lanceolate, base equal, acute, pinnately nerved, 12–15 by 4.2–7 cm. Male spikes unknown; female spikes to 7 cm long. Drupe ovate, to 0.5 cm long.

Endemic. Known from a single record collected by Kunstler from limestone at Gopeng, Perak. I have not seen this specimen.

Piper mucronatum C. DC., Rec., Bot. Surv. Ind. 6:15. 1912; Ridl., Fl. 3:36. 1924.

Endemic, uncommon in lowland forest. Once from limestone, Gua Batu (Poore 801).

Piper nigrum L., Sp. Pl. (1753) 28; Hk.f., F.B.I. 5:90. 1885; Henders., J. Mal. Br. R. As. Soc. 17:67. 1939; Burkill, Dict. Econ. Prod. Mal. (2nd ed.) 2:1776. 1966.

Recorded from Gua Batu, Selangor (Ridley 8180) and Tambun, Perak (Burkill, 6305). These are probably escapes from cultivation.

Piper porphyrophyllum N.E. Br., Gard. Chron. 2:438. 1884; Ridl., Fl. 3:45. 1924.

Endemic and common in lowland forest. Recorded once (Chin 611) climbing over limestone rock in deep shade on the small isolated outcrops in Johore.

Piper retrofractum Vahl, Enum. Pl. 1:314. 1805; Merr., Fl. Manila (1912) 170; Henders., J. Mal. Br. R. As. Soc. 17:67. 1939.

Piper scortechinii C. DC., Rec. Bot. Surv. Ind. 6:8. 1912; Ridl., Fl. 3:50. 1924; Henders., J. Mal. Br. R. As. Soc. 17:67. 1939.

Endemic; recorded from Taiping hills (not limestone) and Gopeng limestone (fide De Candolle). I have not seen any specimens of this rare plant.

Piper umbellatum L., Sp. Pl. (1753) 30; Ridl., Fl. 3:51. 1924; Henders., J. Mal. Br. R. As. Soc. 17:67. 1939.

Zippelia begoniaefolia Bl., in Schult. f., Syst. Veg. 7:1651. 1830; Back., Fl. Java 1:168. 1963.

Z. lappacea Bl., in Ridl., Fl. 3:25. 1924; Henders., J. Mal. Br. R. As. Soc. 17:67. 1939.

PITTOSPORACEAE

Pittosporum ferrugineum Ait., Hort. Kew ed. 2, 2, 2:27. 1811; Ridl., Fl. 1:136. 1922. Bak. & Steenis, Fl. Mal. I. 5:355. 1957. Whitmore, Tree Fl. Mal. 2:310. 1973.

Common in coastal areas, rare inland. Recorded once from limestone (Gunong Tempurong, Perak, Ng FRI 5572).

POLYGALACEAE

1. Herbs; leaves not glaucous; fruit a small capsule 2
Tree; leaves slightly glaucous beneath; fruit a drupe, globose, 2-3.5 across
..... *Xanthophyllum glaucum*
2. Margin of leaves ciliated; stamens 4-5 *Salomonina ciliata*
Margin of leaves not ciliated; stamens 8 3
3. Capsule obcordate; wings broad. Leaves ovate-elliptic, 0.6-5.5 by 0.4-3 cm
..... *Polygala cardiocarpa*
Capsule elliptic, oblong-obovate, orbicular or sub-orbicular; wings narrow
..... 4

4. Leaves mostly in pseudowhorls of 3, elliptic to ovate, 1–5.5 by 0.9–2.5 cm. Seeds with a large black appendage at the chalazal end *Polygala malesiana*
 Leaves alternate, spatulate or orbicular, 0.5–3 cm long. Seeds with a small appendage *Polygala triphylla*

Polygala cardiocarpa Kurz., J. As. Soc. Beng. 41:293. 1872; Ridl., Fl. 1:1939. 1922, in part, the specimens from Langkawi; Henders., J. Mal. Br. R. As. Soc. 17:35. 1939. Adema, Blumea, 14:260. 1966.

Erect herb 5–25 cm. Leaves ovate-elliptic, 0.6–5.5 by 0.4–3 cm. Flowers in terminal racemes, yellow or orang-yellow. Sepals 5, unequal, petals 3, the lower one keel-shaped.

Distributed in Burma and Peninsular Thailand. In Malaya found only from Langkawi. This species is apparently restricted to limestone in all its range.

Polygala malesiana Adema, Blumea 14:259. 1966.

P. cardiocarpa (non Kurz) Ridl., Fl. 1:139. 1922; in part.

P. triphylla Ham. ex Don var. *glaucescens* Wall. in Hk. F.B.I. 1:201. 1875.

Erect herb, 6–20 cm tall. Leaves mostly in pseudowhorls of 3, broad-elliptic to ovate, 1–5.5 by 0.9–2.5 cm. Racemes terminal, sometimes branched. Sepals 5, unequal; petals 3, the lower one keeled. Ovary obcordate.

Distributed all over Malesia. In Malaya, restricted to limestone, recorded from Perak, Pahang and Selangor, rare.

Polygala triphylla Buch. et Ham. ex Don, Prodr. Fl. Nep. (1825) 200; Hk.f. F.B.I. 1:201. 1875.

P. hyalina Wall., in Henders., J. Mal. Br. R. As. Soc. 17:36. 1939.

Herb, 5–25 cm tall. Leaves 0.5–3 cm long, spatulate or orbicular. Flowers in racemes 3–5 cm long. Sepals 5, unequal, petals 3, the lower one keeled. Capsules orbicular, narrowly winged.

Distributed in N.W. and Central India, Burma, Thailand and in Malaya from Gopeng, Perak; Gunong Senyum, Pahang; and Selangor. Confined to limestone in Malaya.

Salominia ciliata DC., Prodr. 1:334. 1824; Ridl., Fl. 1:140. 1922; Henders., J. Mal. Br. R. As. Soc. 17:36. 1939.

Xanthophyllum glaucum Wall. ex Hassk., Cat. (1831) 4199; Ridl., Fl. 1:147. 1922. Henders., J. Mal. Br. R. As. Soc. 17:36. 1939.

POLYGONACEAE

Polygonum chinense L., Sp. Pl. (1753) 363; Ridl., Fl. 3:12. 1924; Bak. Fl. Java 1:223. 1963.

Mainly in the highlands at 1000–1300 m. Recorded once from limestone at Gunong Rapat, Perak (Ng FRI 1918) at about 100 m. This species is occasionally cultivated by the Chinese as a medicinal plant and therefore found in the lowlands. It is not known whether the limestone specimen is an escape from cultivation.

PRIMULACEAE

Lysimachia peduncularis Wall. ex Kurz. Cat. (1829) 1489. J. As. Soc. Beng. 46:219. 1877; Henders., J. Mal. Br. R. As. Soc. 17:53. 1939; Bentvelzen, Fl. Mal. I. 6:182. 1962; Keng & Avadhani, M.N.J. 22:86. 1969.

Decumbent herb, to 30 cm tall. Leaves spiral, lanceolate 1.5–5 by 0.5–1.5 cm, somewhat strigose; petiole 0.5–1 cm. Flowers yellow, axillary, solitary with a 2–5 cm pedicel. Capsule shorter than the calyx, 5 valved.

Distributed in India, S. Burma, Thailand, Indochina and Malaya. This is a plant of coastal limestone; in Burma to 420 m in bamboo forest. In Malaya, it is known from only two collections; one by Henderson on the 21st. Nov. 1934 and the other by Keng *et al* on the 7th Nov. 1969; both were from Batu Ayam, Selat Panchor, Langkawi. Keng 6211 was growing on a small patch of fine sand enclosed in a basin-like limestone rock, 3 or 4 yards away from the high water mark, and Henderson 21371 was 'on limestone'. This species is the *only record of Primulaceae from Malaya.*

RANUNCULACEAE

Flowers solitary or in threes, axillary *Naravelia dasyoneura*
Flowers in panicles, numerous, axillary and terminal *Naravelia laurifolia*

Naravelia dasyoneura Korth., Ned. Kruidk. Arch. 1:208. 1847; Eichler Bibliotheca botanica 124:54. 1958.

N. axillaris Ridl., Fl. 1:2. 1922.

Recorded for Malaya twice; once by Ridley in the early part of this century from a hedge by rice-fields in Perlis and the other in 1962 from Gua Batu Boh limestone, near Gua Musang in Kelantan (UNESCO 219).

Naravelia laurifolia Wall., Cat. (1831) 4685; Hk.f., F.B.I. 1:7. 1875; Ridl., Fl. 1:2. 1922; Eichler, Bibliotheca botanica 124:54. 1958.

Recorded from limestone on Gua Musang, Kelantan (Chin 128).

RHAMNACEAE

- | | |
|---|-------------------------------|
| 1. Spiny shrubs | 2 |
| Not spiny, shrubs or small trees | 3 |
| 2. Leaves, lower surface usually densely rusty-red pubescent; spines stout, strongly recurved | <i>Zizyphus oenoplia</i> |
| Leaves, lower surface pubescent on the veins only; spines slender, more or less straight and directed upwards | <i>Zizyphus pernettyoides</i> |
| 3. Veins 3 pairs; fruit a capsule | <i>Colubrina asiatica</i> |
| Veins 6–9 pairs; fruit a winged samaroid or drupaceous | 4 |

4. Fruit fleshy, drupaceous *Sageretia thea*
 Fruit dry, a winged samaroid 5
5. Leaves 2.5–7 by 1.5–2.4 cm; calyx tube enclosing more than half the nut ...
 *Ventilago gladiata*
 Leaves 6–11.5 by 3–4.2 cm; calyx tube not enclosing nut
 *Ventilago oblongifolia*

Colubrina asiatica (L.) Brongn., Ann. Sc. Nat. 10:369. 1827; Ridl., Fl. 1:465. 1922; Henders., J. Mal. Br. R. As. Soc. 17:41. 1939; Stone, Micronesica 6:399. 1970.

Distributed throughout south-eastern Asia and into the Pacific; a plant of coastal areas. It is very interesting to note that there is a collection (UNESCO 570) of this plant (apparently wild) from Gua Panjang, Kelantan, a locality almost 100 miles from the nearest coast.

Sageretia thea (Osbeck) Johnst., J. Arn. Arb. 49:378. 1968.

Rhamnus thea Osbeck., Dagb. ofwer Ostind. Resa. (1757) 232.

S. theezans (L.) Brongn., in Li, Woody Fl. Taiwan (1963) 516.

Scrambling shrub. Leave ovate or elliptic, glabrous or scruffy pubescent especially when young, 1–3 by 0.6–1.5 cm; margin serrulate. Inflorescence a paniculate spike. Fruit drupaceous.

India. China and the Philippines. Recorded in Malaya only from limestone on Gua Batu; in partially exposed rocky patches on the summit.

Ventilago gladiata Pierre, Fl. For. Cochinch. Fasc. 20. t 314c. 1894; Ridl., J. Str. Br. R. As. Soc. 75:23. 1917, Fl. 1:467. 1922.

Ventilago oblongifolia Bl., Bijdr. (1827) 1144; Ridl., J. Str. Br. R. As. Soc. 75:23. 1917; Fl. 1:467. 1922; Back., Fl. Java 2:81. 1965.

Zizyphus oenoplia Mill., Gard. Dict. No. 3; Hk.f., F.B.I. 1:634. 1875; Ridl., Fl. 1:462. 1922; Back., Fl. Java 2:82. 1965.

Thorny rambling bush, twigs densely rusty-red pubescent. Leaves with a pair of spinous stipules; one straight and directed upwards, deciduous, the other recurved, stout and persistent; blade ovate-lanceolate, glabrous above except on the nerves and densely rust-red pubescent below; nerves 3, from the base of leaf; 2–5 by 1–2.5 cm. Flowers in axillary clusters to 15 together. Drupe globular, 0.5 cm across.

Distributed all over tropical Asia to Australia. The pubescence varies from very dense to sparse, in which case, it is densest on the veins. Common on dry limestone hills, often forming dense thickets very uncomfortable to penetrate.

Zizyphus pernettyoides Ridl., Fl. 1:463. 1922; Probably the *Zizyphus* sp. in Henders., J. Mal. Br. R. As. Soc. 17:41. 1939.

Scrambling shrub, thorny. Leaves with a pair of spinous stipules, both rather straight and directed upwards; blade ovate to ovate-lanceolate, glabrous in matured leaves; pubescent on the veins only; young twigs and leaves pubescent; 1.2 by 0.6 cm. Flowers in axillary groups, 5-merous.

Endemic; known previously only from Robinson's collection made on Langkawi limestone which I have not seen. However, what appears to be this species has been seen on limestone in Selangor, Kelantan and Perak. Chin 343 (from Gua Batu) matches Ridley's type description; the leaves, however, are larger, 1.5-3 by 1-1.5 cm, and the flowers are in groups of 2-5 instead of only 3.

RHIZOPHORACEAE

Carallia brachiata (Lour.) Merr., Philip. J. Sc. 15:249. 1919; D. Hou, Fl. Mal. I, 5:485. 1958.

C. scortechinii King, J. As. Soc. Beng. 66:319. 1897; Ridl., Fl. 1:697. 1922; Henders., J. Mal. Br. R. As. Soc. 17:44. 1939.

C. spinulosa Ridl., in Fl. 1:698. 1922.

ROSACEAE

Tree *Eriobotrya bengalensis*
Shrub, sarmentose, prickly *Rubus angulosus*

Eriobotrya bengalensis Hk.f., F.B.I. 2:371. 1878; Ridl., Fl. 1:680. 1922; Henders., J. Mal. Br. R. As. Soc. 17:44. 1939; Prance in Whitmore, Tree Fl. Mal. 2:326. 1973.

Recorded from limestone in Kelantan, Selangor and Pahang, not uncommon on the craggy summits of dry hills with shallow soil. The collection from Raub (Chin 1152) has foliaceous stipules, to 0.6 by 0.4 cm, but is otherwise a good match.

Rubus angulosus Focke, Bibl. Bot. 72:90. 1909; Ridl., Fl. 1:678. 1922; Henders., J. Mal. Br. R. As. Soc. 17:44. 1939.

KOH KENG HOE ORCHID NURSERY

NO. 8, ADAM ROAD,

SINGAPORE 1128.

TEL: 663739

For Orchid Hybrids — DENDROBIUM is our speciality.

Our latest green hybrids are very outstanding.

Come and see for yourself at our nursery.

We produce Dendrobium Ng Eng Chow green
Dendrobium AMRO green
Dendrobium AMRO green red lip
Dendrobium AMRO green green lip

We export our plants all over the world by air cargo

Satisfaction guaranteed

We also have other General Orchid Hybrids.

Visits to our nursery are welcomed.

劉炳江建築工程

LAU PENG KANG

409, 4TH FLOOR, KATONG SHOPPING CENTRE,
MOUNTBATTEN ROAD, SINGAPORE 1543.

TEL: 408934 & 405045

WE SPECIALISE IN:

- a) Landscaping of gardens
- b) Planting and transplanting of trees and shrubs
- c) Turfing (various varieties)
- d) Cutting and pruning of trees
- e) Grass cutting and general maintenance
- f) Construction of footpath (colour or without colour) of all designs
- g) Construction of football fields, basketball courts, etc.
- h) Fencing
- i) Construction of carparks, road drains, etc.

WE ALSO SUPPLY:

- j) Topsoil, fertilizer, plants, etc.

DBS Building Branch:
1001, Tower Lift Lobby,
DBS Bldg., Shenton Way,
Singapore 0106.
TEL: 2214086, 2203468,
2219850

World Trade Centre Branch:
G59, World Trade Centre,
1, Maritime Square,
Singapore 0106.
Tel: 2751202, 2730620

Thomson Plaza Branch:
G43, Thomson Plaza,
301, Upper Thomson Road,
Singapore 2057.
Tel: 4543694, 4543695

Nursery
201-C, Stephen Lee Road,
(Mandai Tekong)
Tel: 2695507

for flowers, plants or seeds let us supply your needs.

LANDSCAPE DESIGNERS & CONTRACTORS

Interior Plantscaping

Specialises in Indoor Plant display for
RESIDENTIAL, COMMERCIAL &
INDUSTRIAL

Plants

Hardy indoor foliage plants for
SALE & RENTAL

Horti-Mart

From seeds to fertilisers from
insecticides to fungicides, garden
tools to decorative pots, containers
and vases, plus mini-potted plants
available at all branches.

F — flowers, plants or seeds
L — let us supply your needs,
O — ours are without limitation,
R — ring us whatever the occasion,
A — anytime, any place & any day,
L — leave an address & we'll be on our way,

D — delay not,
E — early action saves a lot,
W — when you call



floral dew



SAM HENG
BUILDING CONSTRUCTION CO.

90-B, JALAN WOODBRIDGE,

SINGAPORE 2879.

TELEPHONE: 4812073

WE SPECIALISE IN:—

■ TREE CUTTING

■ PLANTING

■ TURFING

■ LANDSCAPING, ETC.

INSTRUCTIONS TO AUTHORS

Manuscripts: The Editorial Board of the Gardens' Bulletin will be glad to receive and consider for publications original research findings and reviews of progress in the fields of Botany and Horticulture and allied subjects. Contributions must be original and the material must not have been submitted or, if accepted, be submitted for publication elsewhere.

Two copies of the manuscript should be submitted, typed on one side only with double-line spacings and a margin of at least 4 cm. Authors should see the lay-out of other papers published in this journal to ensure that papers submitted conform as closely as possible to the accepted pattern. Numerical data should only be included if its essential to the argument and this can be presented either in the form of tables or diagrams.

Title and authors: The title should give a concise description of the contents of the paper. The name(s) of author(s) and address(es) must be given below the title. Lengthy papers and those of a taxonomic nature must have the contents listed at the beginning of the paper.

Scientific names: The complete scientific name — genus, species and authority, and cultivar where appropriate — must be cited for every organism at time of first mention. The generic name may be abbreviated to the initial thereafter except where intervening references to other genera with the same initial could cause confusion.

Tables: Should be numbered and carry headings describing their content. These should be comprehensive without reference to the text.

Abbreviations: Standard chemical symbols may be used in the text (e.g. IAA, IBA, ATP), but the full term should be given on the first mention. Dates should be cited thus — 3 May 1976. Units of measurement should be spelled out except when preceded by a numeral, when they should be abbreviated in standard form: g, mg, ml, etc. and not followed by stops.

Literature citation: Citations in the text should take the form: King and Chan (1964). If several papers by the same author in the same year are cited, they should be lettered in sequence (1964a), (1964b), etc. When papers are by more than two authors, but not more than four, all the names should be recorded on first mention, e.g. Ang, Yong, and Singh (1966); otherwise the reference should be to Ang et al. (1966). Citations listed under the heading LITERATURE CITED must be available in libraries and references must be placed in alphabetical order without serial numbering. The following standard form of citation should be used:

Lawson, R. H. (1970). Flower necrosis in *Cattleya* orchids. *Amer. Orchid Soc. Bull.* 39: 306–312.

Singh, H. (1967). Sclereids in *Fagraea*. *Gard. Bull. Sing.* 22(2): 193–212.

Abbreviations of titles of journals should be those of the World List of Scientific Periodicals (4th Edition) or the Selected Abbreviated Titles of Biological Journals (London: Institute of Biology).

Reference to books and monographs should include authors' and/or editors' names, full title, number of pages, edition (unless there is only one), the publisher's name and place of publication, e.g.

Eames, A. J., (1961). *Morphology of the Angiosperms*, 518 pp. McGraw-Hill Book Company Inc., New York, Toronto and London.

Reprints: Authors will be given 25 reprints free of charge. Additional reprints will be charged at cost.

Editor's Address: Manuscripts are to be submitted to:

The Editor,
Gardens' Bulletin,
Botanic Gardens,
Cluny Road,
Singapore 1025.

PUBLICATIONS OF THE BOTANIC GARDENS
SINGAPORE

1. **The Agricultural Bulletin of the Malay Peninsula (Series I).**
Only Nos. 3, 5, 7, 8 and 9 available, at 20 cents each.
2. **The Agricultural Bulletin of the Straits and F.M.S. (Series II).**
Vols. 1-10, 1901-1911, monthly issues.
Many parts available.
Price: \$5 per volume, 50 cents per part.
3. **The Gardens' Bulletin, Straits Settlements (Series III).**
Vols. 1-11, 1912-1947.
Vol. 1 (1-5) January-May 1912 issued under title of **Agricultural Bulletin of the Straits & F.M.S.**

Prices on application.
4. **The Gardens' Bulletin, Singapore (Series IV).**
Vols. 12-27, 1949-1971. Vol. 28 Pt. I in print.
Price: Vol. 13 Pt. I (New impression) \$12 per copy, \$20 per vol.
Vols. 12 & 14 \$13 per vol. Vol. 15 \$20 per vol. Vols. 16-25 \$25 per vol. Individual parts vary in price.
Vol. 26 (Pt. I \$18; Pt. II \$18); 27 (Pt. I 18; Pt. II \$18.50); 28 (Pt. I \$18; Pt. II \$15); 29 (\$30); 30 (\$48); The Freshwater Swamp-forest of S. Johore and Singapore by E. J. H. Corner (Gdns' Bull. Suppl. 1) — \$35.
5. **Materials for a Flora of the Malay Peninsula, Monocotyledons.**
Parts 1, 2 and 3 remain available.
Price: \$10 per set, \$5 per part.
6. **Annual Reports.**
1909-1972.
7. (a) **Malayan Orchid Hybrids** by M. R. Henderson and G. H. Addison. \$15.
(b) **Malayan Orchid Hybrids, Supplement I** by G. H. Addison. \$21.
8. **A Revised Flora of Malaya.**
(a) Vol. 1, Orchids, by R. E. Holttum. \$50 (3rd ed. 1972 Impr.).
(b) Vol. 2, Ferns, by R. E. Holttum. \$20 (2nd ed. 1968).
(c) Vol. 3, Grasses, by †H. B. Gilliland. \$30 (1971).
9. **Boletus in Malaysia** by E. J. H. Corner. \$50 (1972).

Items 1-6 obtainable from the Commissioner, Parks & Recreation Department, Botanic Gardens, Cluny Road, Singapore 1025.

Items 7-9 obtainable from Singapore National Printers (Pte) Ltd, Upper Serangoon Road, Singapore 1334.

Prices quoted are in Singapore Dollars
Overseas postage is extra

