

Gj-G

WHITNEY LIBRARY,  
HARVARD UNIVERSITY.



THE GIFT OF  
J. D. WHITNEY,  
*Sturgis Hooper Professor*  
IN THE  
MUSEUM OF COMPARATIVE ZOOLOGY

14,592

June 19, 1903.

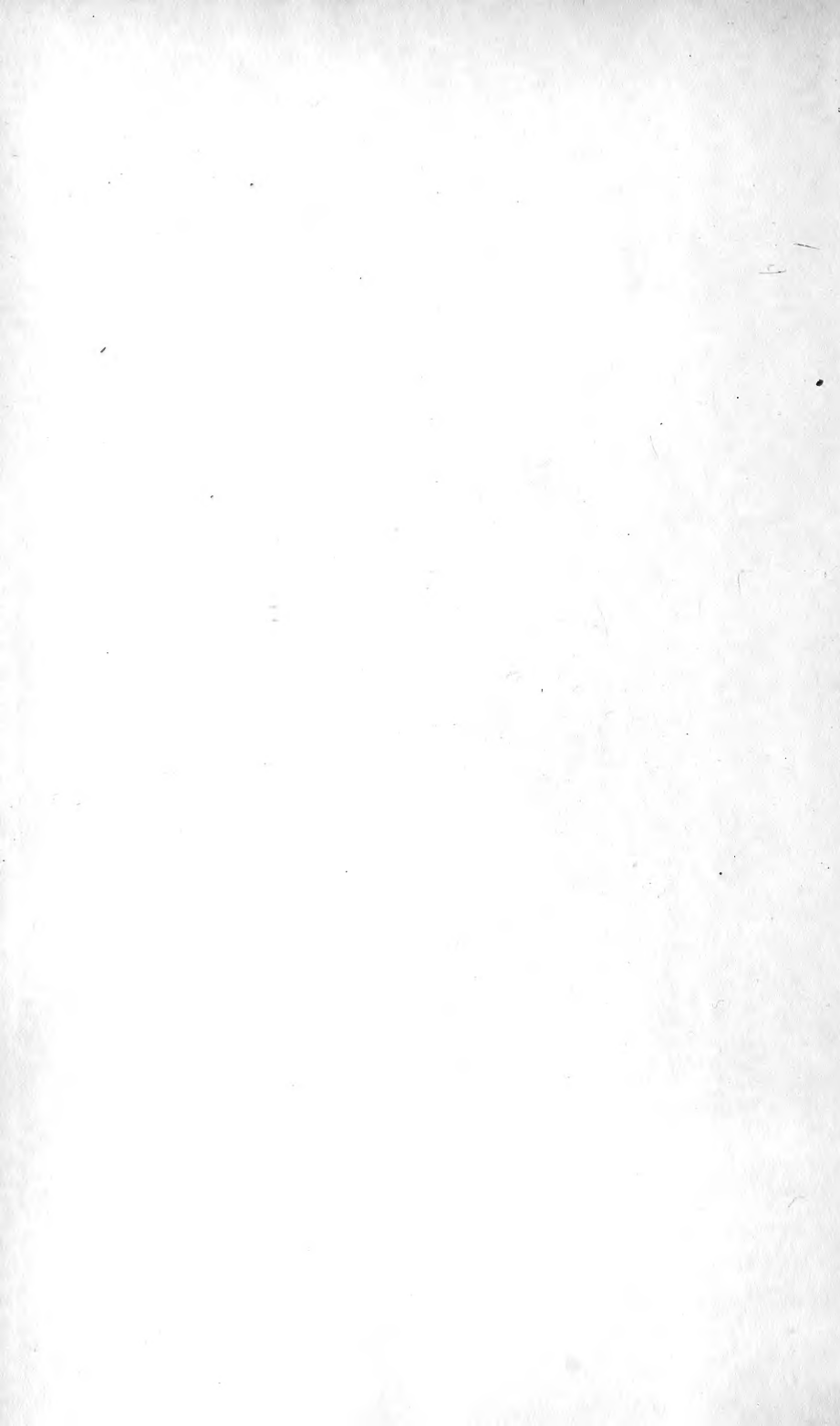


**HARVARD UNIVERSITY**

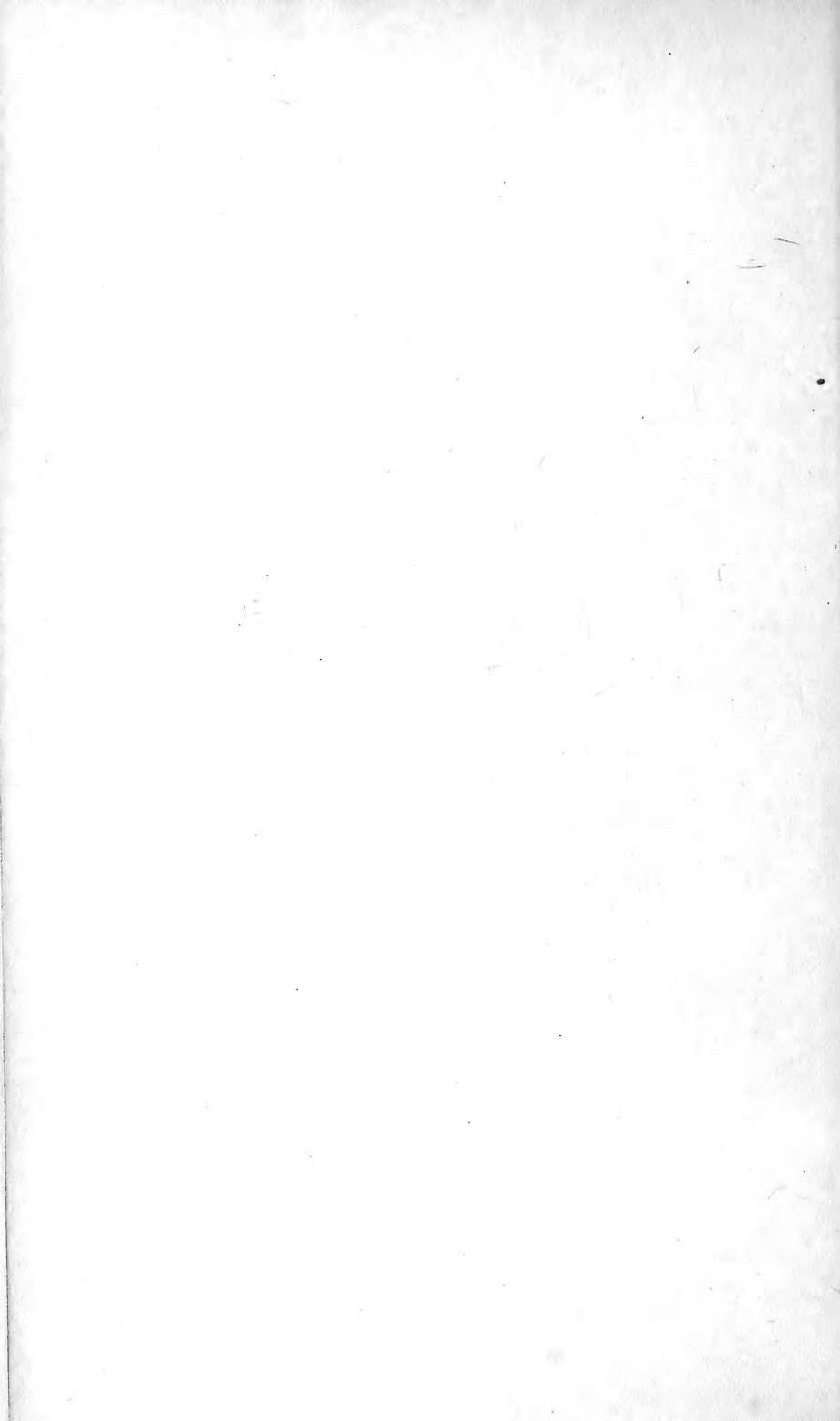


**GEOLOGICAL SCIENCES  
LIBRARY**

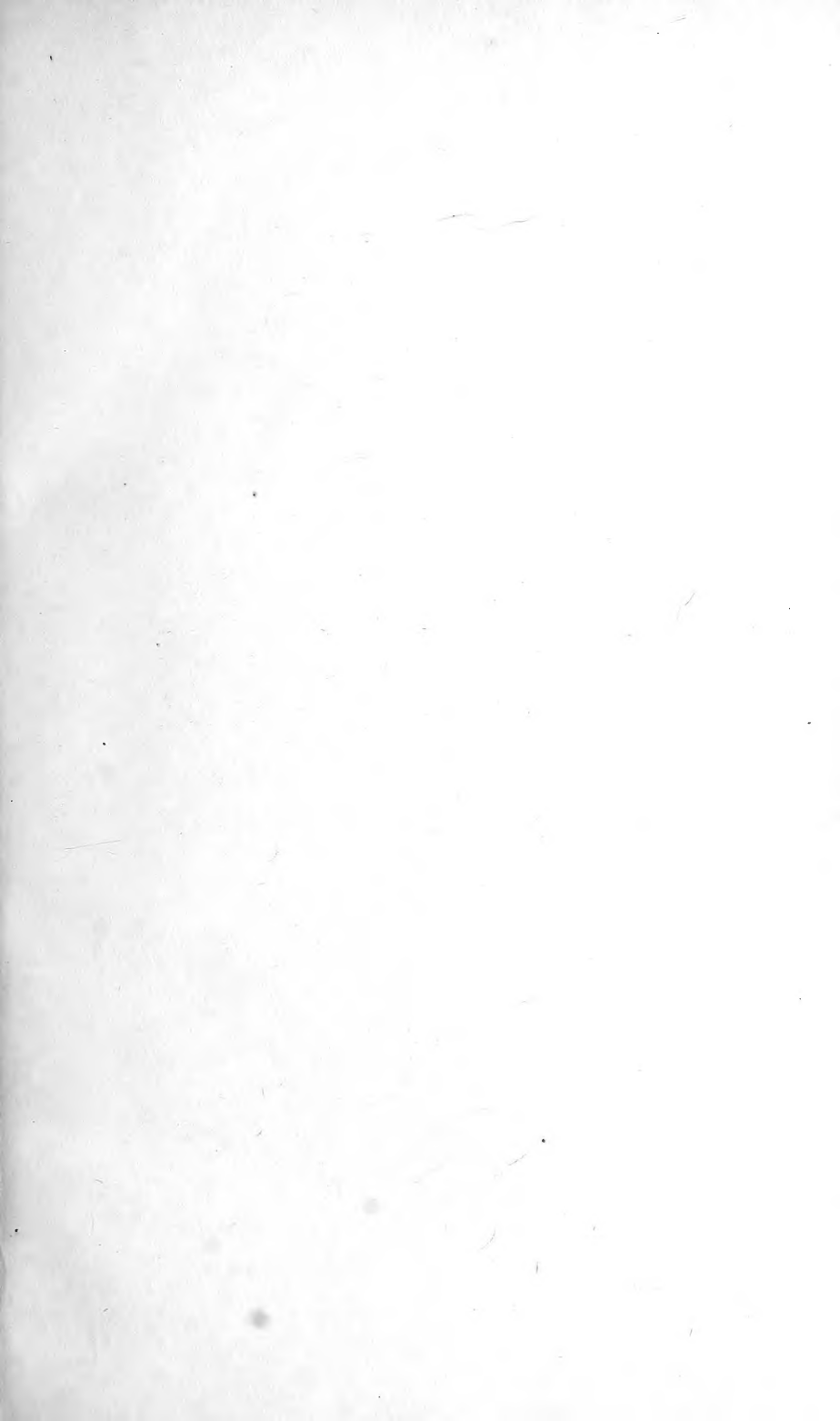
TRANSFERRED TO GEOLOGICAL SCIENCES LIBRARY













THE  
GEOLOGICAL MAGAZINE

NEW SERIES.

DECADE III. VOL. I.

JANUARY — DECEMBER. 1884.





THE  
GEOLOGICAL MAGAZINE:

OR,

Monthly Journal of Geology:

WITH WHICH IS INCORPORATED

“THE GEOLOGIST.”

NOS. CCXXXV. TO CCXLVI.

EDITED BY

HENRY WOODWARD, LL.D., F.R.S., F.G.S., F.Z.S., F.R.M.S.,

OF THE BRITISH MUSEUM OF NATURAL HISTORY;

VICE-PRESIDENT OF THE PALEONTOGRAPHICAL SOCIETY,

MEMBER OF THE LYCEUM OF NATURAL HISTORY, NEW YORK; AND OF THE AMERICAN PHILOSOPHICAL SOCIETY, PHILADELPHIA; HONORARY MEMBER OF THE YORKSHIRE PHILOSOPHICAL SOCIETY; OF THE GEOLOGISTS' ASSOCIATION, LONDON: OF THE GEOLOGICAL SOCIETIES OF EDINBURGH, GLASGOW, AND NORWICH; CORRESPONDING MEMBER OF THE GEOLOGICAL SOCIETY OF BELGIUM; OF THE IMPERIAL SOCIETY OF NATURAL HISTORY OF MOSCOW; OF THE NATURAL HISTORY SOCIETY OF MONTREAL; AND OF THE MALACOLOGICAL SOCIETY OF BELGIUM.

ASSISTED BY

PROFESSOR JOHN MORRIS, M.A., F.G.S., &c., &c.,

AND

ROBERT ETHERIDGE, F.R.S. L. & E., V.P.G.S., &c.

OF THE BRITISH MUSEUM OF NATURAL HISTORY.

NEW SERIES. DECADE III. VOL. I.

JANUARY—DECEMBER, 1884.

LONDON:

TRÜBNER & Co., 57 AND 59, LUDGATE HILL.

F. SAVY, 77, BOULEVART ST.-GERMAIN, PARIS.

c 1884.

HERTFORD:

PRINTED BY STEPHEN AUSTIN AND SONS.

## LIST OF PLATES.

PLATE	PAGE
✓ I. A Faulted Slate . . . . .	1
✓ II. <i>Ctenacanthus costellatus</i> , Traquair, Carboniferous, Eskdale. . . . .	8
✓ III. Oxfordian and Lower Oolite Gasteropoda (Yorkshire) . . . . .	49
✓ IV.        "                  "                  "                  " . . . . .	107
✓ V. <i>Megalichthys laticeps</i> , Traquair, Carboniferous . . . . .	121
✓ VI. Oxfordian and Lower Oolite Gasteropoda (Yorkshire) . . . . .	146
✓ VII.       "                  "                  "                  " . . . . .	193
✓ VIII.       "                  "                  "                  " . . . . .	241
✓ IX.        "                  "                  "                  " . . . . .	296
✓ X. <i>Archæastacus (Eryon) Willemœsii</i> , Spence Bate, Lias . . . . .	307
✓ XI. Australian Fossils . . . . .	337
✓ XII. Carboniferous Entomostraca, Nova Scotia . . . . .	357
✓ XIII. Caudal Segments and Valves of <i>Echinocaris</i> . . . . .	393
✓ XIV. Head of the Berlin <i>Archæopteryx</i> . . . . .	419
✓ XV. <i>Viverra Hastingsiæ</i> , Davies, Eocene, Hampshire . . . . .	433
✓ XVI. Carboniferous Trilobites . . . . .	485
✓ XVII. British Eocene <i>Aporrhaidæ</i> . . . . .	529













FAULTED SLATE.



THE  
GEOLOGICAL MAGAZINE.

NEW SERIES. DECADE III. VOL. I.

No. I.—JANUARY, 1884.

ORIGINAL ARTICLES.

I.—A FAULTED SLATE.

By J. J. HARRIS TEALL, M.A., F.G.S.

(PLATE I.)

IT is well known that the slates of the Borrowdale series in the Lake District furnish beautiful illustrations of faulting on a small scale; but so far as I am aware, no description of them, from this point of view, has as yet appeared. The accompanying Plate has been produced in Autotype from one of these slates, the surface of which was first most carefully smoothed and afterwards varnished. Every detail of the faulting is shown in the most perfect manner, and the general tint of the slate is also reproduced. The specimen was purchased at the village of Rosthwaite in Borrowdale; but I was not able to learn the exact locality from which it was obtained. I have little doubt, however, that it came from the Honister quarries. Mr. De Rance tells me that similar slates occur at Tilberthwaite, near Coniston. The plate is of the natural size. The face represented is a cleavage plane, and neither the bedding nor the fault planes are at right angles to this face. The bedding planes make with it an angle of about  $40^{\circ}$ .

Looking at the plate, the first point that strikes one is the conspicuous fault which slopes downwards from right to left. This will be referred to as the main fault. It produces a displacement of  $3\frac{1}{2}$  inches measured along the line of fault as this is shown on the plate. Running parallel with this main fault are several smaller ones, the most conspicuous of which occur in the bottom right-hand corner of the plate. All these form one series which will be described as the *B* series. Crossing this series at an angle of  $35^{\circ}$ , as measured in the plane of the face, is another series which will be referred to as the *A* series. Owing to the intersection of the two series, a number of typical trough faults are produced, and it will therefore be interesting to examine the different modes of explanation that have been proposed to account for such faults.

According to Prof. Jukes (Manual of Geology, p. 215), trough faults are produced during the bulging upwards of a mass of strata by the action of an upheaving force. Tension must arise in such a bending mass and intersecting cracks may be produced. As the elevation proceeds, the wedge-shape masses may slip down into the opening cracks, and a series of trough faults may arise. When the force of elevation has expended itself, a settling down of the mass

will be likely to ensue, great lateral pressure might thus be produced, and any open cracks would become filled up. Such in brief is the theory which Prof. Jukes applies to the trough faults of the South Staffordshire Coal-field, and which Prof. Phillips had previously applied to the Malvern area.

In his work on the Geology of the Weald, Mr. Topley refers to the above theory, and at the same time points out a different mode of explanation, which is unquestionably true for certain faults to which he especially directs attention. He shows that if a district be faulted at two distinct periods, by faults which have the same general strike, but which are inclined to each other, then troughing must necessarily arise. This mode of explanation has one great advantage over that adopted by Professors Phillips and Jukes. It easily explains those cases in which the faults are clean cut; that is, in which there is no considerable thickness of fault rock. If the faults producing the trough were simultaneous, then the angle of the wedge would not usually correspond with that of the space into which the wedge is supposed to slip, and clean cut faults would be the exception instead of the rule. Of course the real test of the accuracy of Mr. Topley's mode of explanation is to examine the point of intersection of the two faults, and trace the earlier fault on the opposite side of the later one. This obviously is only possible when the faults are small.

Such being the two modes of explanation, it is interesting to examine the slate in order to see what light it throws on the question. A momentary glance is sufficient to show that Mr. Topley's mode of explanation gives a perfect account of the appearances there seen. Trace the faults of the *A* series in the top left-hand half of the plate. They terminate abruptly at the line of the main fault. Other and parallel faults occur on the opposite side, but they are not continuous across the slate; the smaller faults of the *B* series shift them again and again. The faults of the *B* series are therefore later than those of the *A* series, and the troughing is the result of the intersection of the two series. It is not necessary to suppose that any long interval of time elapsed between the formation of the two series. Indeed, I suspect that they are both connected with one and the same set of earth-movements, though I do not understand how it is that they are produced successively and not simultaneously.

It will be observed that the faults of this slate appear to be of the ordinary and not of the reversed type. It must be remembered, however, that we are ignorant of the position of the slate in relation to the horizon. If the bedding were horizontal at the time of the faulting, then the effect of the faulting would be to extend the mass in a horizontal direction; but if, on the other hand, the bedding were vertical, then the effect would be exactly the opposite. Whether this particular mass of rock was subjected to horizontal extension or to horizontal compression, or to some other kind of deformation, cannot now be determined. It is interesting to note that instances of what may be called reversed faults are common in these slates. They are described by Mr. E. J. Hebert in the *GEOL.*

MAGAZINE for 1877, p. 441, as being more numerous than those of the ordinary type. A little consideration will show that the two types of faulting might be produced in one and the same bed. Suppose a given stratum of some thickness to be bent into a curve. A state of tension will arise on the outside, and one of compression on the inside. The two spaces in which these opposite conditions exist will be separated by a neutral plane.<sup>1</sup> If the strains be relieved in both cases by faulting—they may of course be relieved in other ways—then ordinary faults will be produced on the outside and reversed faults on the inside.

It would be extremely interesting to study these faulted masses in the field, and to trace the connection between the deformations which they have suffered and the more powerful earth-movements that have affected the rocks. Until this has been done, there are many points that must of necessity remain more or less obscure.

Of course the importance which the reader will attach to the present instance will depend on the view he holds as to the extent to which the general principles of rock deformation are illustrated by minute examples. For my own part, I must confess to a growing conviction that the essential points of both mountain- and low-land stratigraphy, to borrow expressions used by Prof. Lapworth, may be frequently studied in hand specimens.

## II.—DESCRIPTION OF A FOSSIL SHARK (*CTENACANTHUS COSTELLATUS*) FROM THE LOWER CARBONIFEROUS ROCKS OF ESKDALE, DUMFRIESHIRE.

By R. H. TRAQUAIR, M.D., F.R.S.

(PLATE II.)

THE deficiency of our knowledge of the organization and configuration of the Palæozoic Selachii is an unfortunate fact too well known to biologists to render it necessary for me to dilate upon here. Immense numbers of genera and species have been founded upon detached teeth and spines; but as yet very few specimens have occurred, which threw any light upon the general organization and configuration of the ancient possessors of these now scattered relics.

Among the many new and remarkable fossil fishes, which the Lower Carboniferous beds of Eskdale, Dumfriesshire, have recently yielded to the investigations of the officers of the Geological Survey of Scotland, as well as of other collectors, none are more interesting than an entire specimen of a fossil shark, acquired a short time ago by the British Museum. It was found at Glencartholm by Mr. Jex, collector to Mr. Damon, of Weymouth, and for the privilege of describing and figuring it, I am indebted to my friend Dr. Woodward, F.R.S., Keeper of the Geological Department.

The specimen is represented in Pl. II. Fig. 1 (reduced three-fourths), and presents us with a somewhat gracefully shaped fish, laterally compressed, with two dorsal spines, and a heterocercal tail.

<sup>1</sup> See A. Heim, Mechanismus der Gebirgsbildung, Band II. s. 17.



series of oblique neural spines. They are rather obscure, yet they may be seen to be elongated, and slightly constricted in the middle, and consisting of granular calcified cartilage. There is no appearance of vertebral centra, or of ribs.

*Fins.*—Behind the head are two obliquely placed cartilages, which are evidently the right and left elements of the shoulder-girdle, and below and behind these on the vertical margin are some remains of a pectoral member, consisting of some rod-shaped cartilages, evidently radials, beyond which are some obscure indications of the shagreen-covered expanse of the fin.

Again, on the ventral margin opposite the insertion of the second dorsal spine, is a moderately-sized fin, whose internal structure shows pointed radial cartilages, and whose surface is covered with minute ridged and pectinated shagreen granules. This I interpret as *ventral*.

The *first dorsal spine* (Fig. 2), deeply and obliquely implanted, measures  $4\frac{2}{3}$  inches in length, its greatest antero-posterior diameter, about  $1\frac{3}{4}$  inch from the root, being  $\frac{1}{2}$  inch. It has a blunt base, acute point, gently convex anterior margin, the posterior one, towards the extremity, being also slightly concave. The limits of the implanted and exposed portions are not exhibited, the exposed part is also slightly injured near the base, but by carefully clearing out the counterpart and taking an impression in wax, a pretty good view of the sculpture was got. The exposed portion of this, the left, side of the spine, somewhat convex proximally and flattened distally, shows eleven longitudinal ridges, diminishing by alternate suppression to three at the extremity. The distance between each pair of these ridges averages  $\frac{3}{4}$  inch. They enlarge at intervals into small nodular tubercles; those on the anterior ridges are closely placed, there being about eight to every  $\frac{1}{4}$  inch, while on the ridges further behind (Fig. 4) they become more distant, reduced to three or four in the same space, and towards the point dying away altogether. When these tubercles are perfect (Fig. 3), they are seen to be brilliantly enamelled and striated longitudinally by three or four sharp ridges and sulci. The posterior margin of the spine is evidently cut off flat, while a row of small recurved denticles, five to  $\frac{1}{4}$  inch, arms the line of junction of the posterior and lateral surfaces.

The *second dorsal spine*, four inches in length, has its surface more injured, and as the counterpart of this part of the specimen is gone, the plan of taking a wax impression to supplement our knowledge of the external sculpture, was not available. Nevertheless, so far as can be seen, the characters of this spine are quite the same as those of the first, though it is shorter and apparently a little straighter. Behind the spine is a mass of calcified cartilage, evidenced by the mosaic of minute calcareous pieces, which at first sight look something like flat polygonal shagreen granules; distally, however, this mass becomes differentiated into pointed rod-like bodies, of which six are visible, and which are clearly radial cartilages of the fin. Scattered about here are also undoubted shagreen bodies, showing the same ridged and pectinated character already described.

The *caudal fin* is very distinctly bifurcated and heterocercal, though

unfortunately the extremity of the upper lobe is cut off by the edge of the stone: a thin layer of matrix also adheres very obstinately in this part, and attempts which have been made to clear it off have not been very successful. Through this thin veil of matrix seven fin cartilages may be traced projecting in the direction of the lower lobe to a distance of  $3\frac{1}{4}$  inches.

Immediately in front of the lower lobe of the caudal, there projects a film or mass of minute shagreen granules, which may either be the remains of an anal fin, or simply a mass of those appendages displaced from the adjacent part of the body. But as no radial cartilages can be detected in connection with it, I am rather disposed to accept the latter alternative.

*Remarks.*—The general form of the spines, showing a comparatively short implanted portion, obliquely marked off from the sculptured exposed surface; the nature of that sculpture, consisting of longitudinal ridges ornamented with tubercles; the evident presence of a posterior area with recurved denticles along the margins between it and each lateral surface—form an assemblage of characters affording, I think, ample justification for the reference of this remarkable fossil shark to the genus *Ctenacanthus* of Agassiz. As regards the species, there can be no doubt that it is new, as the system of tuberculation of the ridges differs sufficiently from that in any hitherto described species. In general aspect the spine perhaps approaches most nearly the *Sphenacanthus serrulatus* of Agassiz than any other; but in the latter the tubercles of the ridges are much more distant and less prominent, being in fact only observable on the ridges towards the posterior margin and lower part of the side; whereas, in the Eskdale shark they are most prominent and closely set on the ridges in front. Here also I may state, that taking the genus *Ctenacanthus* as it at present stands, including as it does such species as *Ct. hybodoïdes* and *nodosus* of Egerton, *Ct. laevis* of Davis, etc., I cannot see any ground for the retention of *Sphenacanthus* as a separate genus. In describing it Prof. Agassiz seems to have been especially struck by its resemblance to the spine of *Hybodus*, but as a characteristic difference he remarks that “au lieu de grosses dents à ses bords postérieurs, on n’y remarque qu’une fine crenélure.”<sup>1</sup> But the type specimen of *Sph. serrulatus*, now in the Edinburgh Museum of Science and Art, to which it was presented by the Royal Society of that city, displays, on the only portion of one of the postero-lateral margins which has been preserved, teeth as prominent as in most species of *Ctenacanthus*, and which must therefore have escaped the attention of the great palæichthyologist. For this new species I accordingly propose the name of *Ctenacanthus costellatus*.

The next important question is that regarding the dentition of *Ctenacanthus*. Except in a few instances, such as *Pleuracanthus*, *Pleuroodus*, *Tristychius*,<sup>2</sup> the correlation of the teeth and spines of Palæozoic *Selachii* has hitherto been a very hopeless subject; how-

<sup>1</sup> Poissons Fossiles, vol. iii. p. 23.

<sup>2</sup> In connexion with the dentition of *Tristychius*, see a paper by Mr. T. Stock in Ann. and Mag. Nat. Hist. Sept. 1883.

ever, as regards *Ctenacanthus*, there has been a good deal of speculation. Agassiz was inclined to refer *Psammodus* to *Ctenacanthus*;<sup>1</sup> but as Sir Philip Egerton rightly remarked, "The occurrence, however, of the latter genus of *Ichthyodorulites* in the Coal-measures unassociated with teeth of the genus *Psammodus* would militate against this suggestion."<sup>2</sup> Founding upon the occurrence together of spines of *Ctenacanthus* (*Ct. furcicarinatus*, N.) with a species of *Orodus* (*O. variabilis*, N.) in the Waverley shale at Vanceburg, Kentucky, Prof. Newberry has put forward the view that *Orodus* formed the dentition of the fishes bearing the genus of spines with which we are concerned.<sup>3</sup> But the view which has found most favour is that which has been advocated by the late Messrs. Hancock and Atthey of Newcastle,<sup>4</sup> and by Mr. James Thomson of Glasgow,<sup>5</sup> namely, that the dentition of *Ctenacanthus* is to be sought in the teeth so well known as *Cladodus*. Certainly, even without evidence of association, the identity of these genera is indeed suggested by the obvious general resemblance which the *Ctenacanthus* spine and the *Cladodus* tooth bear to the certainly correlated spines and teeth of the Mesozoic *Hybodus*. Romanowski has indeed described a very hybodont-looking spine as *Cladodus tenuistriatus*, from its association with teeth referable to that genus,<sup>6</sup> and Mr. J. W. Barkas has gone even so far as to propose the abolition of the terms *Cladodus* and *Ctenacanthus* altogether, and to merge their species in the one genus *Hybodus*.<sup>7</sup> It is at all events satisfactory to find that the dentition of the present species was Cladodont in character, and that we have in this a corroboration of the wide-spread idea that the characteristic teeth and spines of the Carboniferous era, known respectively as *Cladodus* and *Ctenacanthus*, and represented by so many species, were borne by the same genus of fishes.

Founded also upon analogy with the extinct *Hybodus* and the recent *Cestracion* and *Acanthias*, a very general opinion has been entertained that *Ctenacanthus* must, like those genera, have possessed two dorsal fins with a spine in front of each. This question is settled by the present specimen, which shows the two dorsal spines *in situ*, the spines closely resembling each other, though the anterior one is slightly the longer, and the posterior somewhat more straight in contour.

Although at least one genus of Palæozoic sharks, *Gyracanthus*, must have been provided with pectoral, or in any case paired, spines, the paired fins are, in this case, clearly destitute of any such appendages. And no *Ctenacanthoid* or *Hybodontoid* spine has ever been shown to possess that peculiar want of bilateral symmetry which points out those of *Gyracanthus* as non-median.

Prof. Hasse has indicated his belief that, in the Palæozoic *Selachii*,

<sup>1</sup> Poissons Fossiles, vol. iii. p. 171.

<sup>2</sup> Quart. Journ. Geol. Soc. 1853, p. 232.

<sup>3</sup> Pal. Ohio, vol. ii. p. 54.

<sup>4</sup> Ann. and Mag. Nat. Hist. (4) ix., 1872, p. 260.

<sup>5</sup> Trans. Geol. Soc. Glasgow, vol. iv. (1861), p. 59-62.

<sup>6</sup> Bull. Soc. Nat. Moscow, vol. xxxvii. (1864), pp. 157-170.

<sup>7</sup> Proc. Roy. Soc. New South Wales, 3 Oct. 1881.

the notochord was persistent, and the vertebral sheath ("Wirbelkörperanlage") unsegmented, or at most provided with weak ring-shaped calcifications.<sup>1</sup>

This conclusion as to the condition of the vertebral axis is indeed amply corroborated by the present specimen, as well as justified by the general absence from the older rocks of anything like calcified shark vertebræ. But in maintaining further that in the majority of *Elasmobranchii* before the Trias, the skeleton was entirely soft, and the skin destitute of placoid scales, he has, I fear, been rather hasty. The present specimen shows the presence of extensive calcification in all the parts of the skeleton save the vertebral axis, and the skin was also provided with a well-developed coat of shagreen. There is also no doubt that skeletal calcifications, and also shagreen bodies, are not of such rare occurrence in Palæozoic rocks as Prof. Hasse seems to imagine. Why they do not oftener occur as conspicuous fossils is also very readily comprehensible, though it is also probable enough that the remote ancestors of the *Selachii*, at some period of the earth's history, were naked-skinned, as well as with soft skeletons.

*Conclusion.*—Accepting the fish just described as a new species of *Ctenacanthus*, it yields us the following important facts regarding the genus:—

1. The shape of the animal was moderately elongated, with blunt snout and heterocercal tail.
2. The skin was covered with shagreen granules, mostly of an ornate, ridged-pectinate character.
3. There were two dorsal fins, each with a spine; that of the first being the longer. There were no paired spines, and the ventral fin was opposite the second dorsal. The presence of an anal fin is doubtful.
4. The dentition was Cladodont.
5. The vertebral axis was unsegmented; but there were extensive calcifications in connexion with other parts of the skeleton.

#### DESCRIPTION OF PLATE II.

FIG. 1. *Ctenacanthus costellatus*, Traq., one fourth natural size.

- „ 2. Anterior dorsal spine, natural size.
- „ 3. Ornamentation of one of the anterior ridges on the same spine,  $\times 8$  diameters.
- „ 4. Detail of ridges more posteriorly situated,  $\times 6$  diameters.
- „ 5. Ridges still further behind and towards the point,  $\times 6$  diameters.
- „ 6. Tooth,  $\times 4$  diameters.
- „ 7. Portion of skin, with shagreen bodies,  $\times 4$  diameters.

#### III.—DESCRIPTION OF A NEW SPECIES OF *ELONICHTHYS* FROM THE LOWER CARBONIFEROUS ROCKS OF ESKDALE, DUMFRIESSHIRE.

By R. H. TRAQUAIR, M.D., F.R.S.

**T**HE labours of Mr. Jex in the Eskdale fish-beds have brought to light another beautiful new fish, now in the British Museum. This is a Ganoid of the genus *Elonichthys*, and though represented as yet only by a single specimen, this is fortunately a very perfect one.

The length of the specimen is exactly 12 inches, but the tip of the

<sup>1</sup> Das natürliche System der Elasmobranchier, pt. i. p. 58.



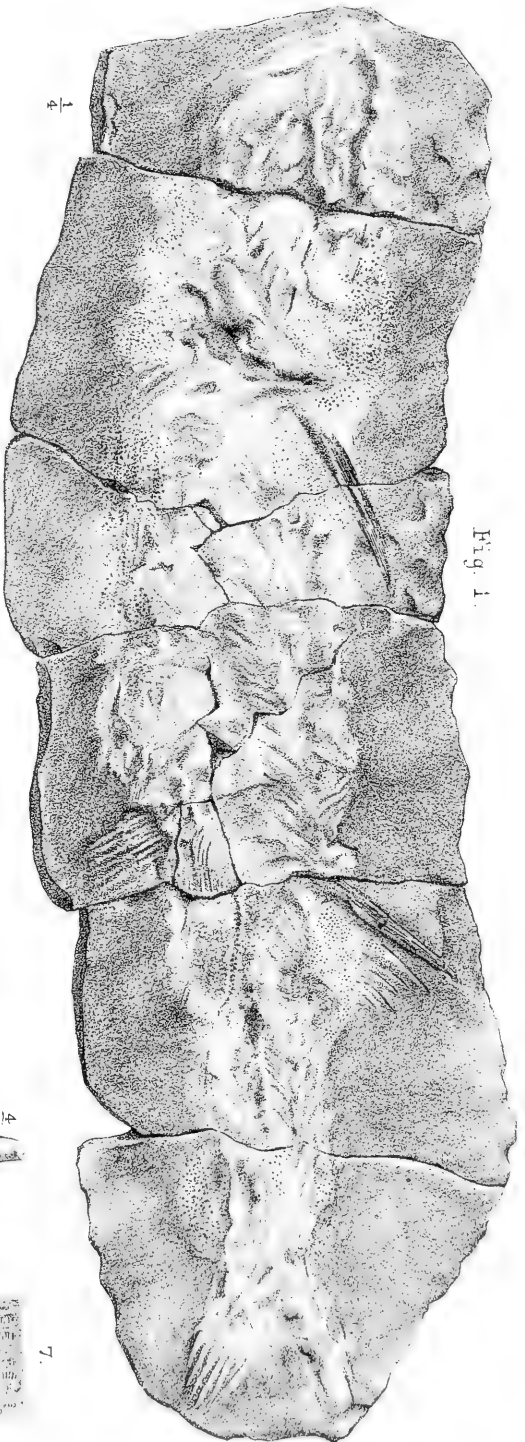
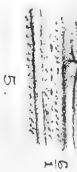
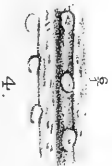


Fig. 1.

$\frac{1}{4}$

2.





snout is not present. It is also slightly contorted or bent, so that the back is more convex or gibbous than would otherwise be the case, while the ventral margin assumes a concave contour. Compression has also taken place in a somewhat oblique direction, so that, the fish lying on its right side, the origin of the dorsal fin is slightly concealed by the scales of the left.

The general contour of the fish is deeply fusiform, with a pretty large head and powerful heterocercal tail. If we allow  $\frac{1}{2}$  inch for the missing part of the snout, the length of the head would be contained  $4\frac{1}{2}$  times in the total.

The *head* has the usual palæoniscid structure, but is so crushed and otherwise badly preserved that little more can be said of it. Traces of fine striæ are seen on the maxilla as well as on the mandible opercular bones. The supra-clavicular element of the shoulder girdle shows the same kind of ridged sculpture so general in species of this genus.

The *scales* are of moderate size, and are *not serrated on their posterior margins*. Those of the flank are higher than broad: *tolerably coarse ridges and furrows run parallel with the superior, posterior, and inferior margins, and meet at acute angles on a strong diagonal ridge which runs downwards and backwards over the scale to the postero-inferior angle*. Posteriorly this diagonal ridge becomes less marked and finally disappears, and towards the tail pedicle the sculpture becomes reduced to interrupted furrows and punctures arranged diagonally in the middle of the scale, but at the periphery tending to be parallel to the superior, posterior, and inferior margins. On the small narrow scales of the caudal body-prolongation, these markings appear mostly as simple diagonal furrows.

One of the *pectoral* fins is seen, and attains a length of  $1\frac{3}{4}$  inch, but it is not in a good state of preservation, its rays being rather broken up terminally and post-axially. I should say that the principal rays must have been unarticulated for some part of their length.

The *ventral* is similarly badly preserved; as the specimen lies, it seems nearer the anal than the pectoral. It appears small, but the broken-up condition of its rays indicates that its size and form are not accurately preserved.

The *dorsal* commences slightly in front of a point midway between the posterior border of the gill cover and the commencement of the caudal fin. Its shape is triangular-acuminate, its height in front  $1\frac{1}{2}$  inch, though it must have been higher, as its base is partly concealed by the oblique compression of the specimen. Its rays are rather distantly articulated, and each joint is ornamented on its exposed part by one prominent smooth ridge, or longitudinal elevation. Traces of very oblique slender fulcra are seen along the anterior margin.

The *anal* agrees closely with the dorsal in configuration and structure; the length of its longest rays is  $1\frac{3}{4}$  inch.

The caudal fin is large, inequilateral, and deeply bifurcate; the length of the upper lobe, measured from a point in the middle of the tail pedicle opposite the commencement of the lower one, being

$3\frac{3}{4}$  inches. The longest rays of the lower lobe attain a length of  $2\frac{2}{3}$  inches as preserved, but as the point of this part of the fin is broken off, their original length may be estimated at  $2\frac{3}{4}$  inches. These rays of the lower lobe are more closely articulated than those of the other median fins, yet though the joints become shorter towards the extremities, they never are so short as to be square. The joints also show occasional longitudinal furrows on their ganoid surfaces, and the anterior margin of the fin is bordered by minute and very oblique slender fulcra. The upper lobe possesses a very strong body-prolongation: its fringing rays are fine, and begin to dichotomise about the middle of their length; the joints are rather longer than broad and apparently smooth externally.

The peculiar sculpture of the scales, together with the non-denticulated character of their hind margins, separate this species from all others with which I am acquainted. I propose therefore to designate it as *Echinichthys ortholepis*.

---

IV. — ON *GALERITES ALBOGALERUS*, LAMARCK, SYN. *ECHINOCONUS CONICUS*, BREYNIUS.

By Prof. P. MARTIN DUNCAN, F.R.S., etc.

NEXT to *Ananchytes ovata*, there is probably no fossil Echinoid which is so well known to geologists and so common in collections as *Galerites albogalerus*, Lam. Described by Lamarck, studied by Forbes, and puzzled over by almost every naturalist who has classified the Echinoidea, this common yet most variable form has received a number of synonyms, and has been made to belong to four genera besides that in which it now rests.

It has been figured over and over again, and its teeth have been illustrated by Stokes and Forbes. It gives the name to the family of the Galeridæ of Albin Gray and Desor.<sup>1</sup> Eminently Cretaceous in its age, the genus has not yet been found in the Tertiaries; but in these days of deep-sea exploration and affinity-seeking, the well-known form could hardly be without a recent alliance. Thus, in the magnificent Report on the "Challenger" *Echini*, by Alex. Agassiz, *Cystechinus*, A. Agassiz, a genus the species of which dwell in from 1050 to 2225 fathoms, is said to have "the facies of *Ananchytes* and is closely allied to *Galerites*" (Report, p. 148).

This statement regarding two very different forms naturally attracted my attention, and from what I believed I knew about *Galerites albogalerus*, it did not commend itself to my belief. But when I began to study the well-known genus of the Chalk, I found that nearly every palæontologist who had described the form had not been sufficiently exact, and some had fallen into considerable error. In fact, almost every author fails in the truthful description of the nature of the base of the test of the typical species, of the apical system, of the ambulacra, the position of the periproct (anus),

<sup>1</sup> Character:—Test circular or pentagonal, peristome central decagonular pentagonal, periproct independent of the genital apparatus either superior or inferior. Pores simple; divided into 1, *Galerites* proper with teeth, and 2, *Echinonina*, without teeth.

and all regard the form as a toothed Echinoid, which it certainly is not. Desor, Forbes, Cotteau and Triger, and Dr. T. Wright, F.R.S., have written on this species, and I cannot agree with their statements; but Lovén as usual is a master in exactitude, and there is only one point of difference between us, and it is one which he rather avoids.

Desor, in his "Synopsis des Echinides fossiles," gives the following generic determination:—*Galerites*, Lamarck, 1801. Swollen urchins, often conical, sometimes turrated, narrowed posteriorly. The inferior surface flat. The peristome central elongated, but nevertheless decagonal. The periproct infra-marginal. Tubercles small, slightly close, indistinctly in series. Four genital pores. The odd posterior plate (the 5th) is imperforate and sensibly smaller than the other plates. The masticating apparatus is composed of vertical jaws. The spines are in the shape of little smooth filaments and are striated longitudinally.

*Galerites albogalerus*, Lam. "Forme normale." A conical urchin as high as it is long, slightly narrowed behind, with a level base. Periproct infra-marginal. "Forme obtuse." A less elevated variety. "Forme haute et comprimée." "Forme pyramidale." "Forme anguleuse;" and "Forme mixte." These varieties speak for themselves.

Desor's figures, *op. cit.* tab. xxv. fig. 5–10, show the different shapes of the four varieties, indicate that the base on which the test stands is perfectly flat, that the 5th or posterior generative plate (No. 5) has a posterior angle which separates the postero-lateral ocular plates, and that the pairs of pores of the ambulacra are oblique and in equal-sized low plates. He shows the long narrow teeth (after Forbes), and indicates that the actinal pairs of pores are in quite straight series, the peristomial (mouth edge) end of ambulacra being rather broad.

Forbes described *Galerites albogalerus*, and attributed the species to Klein in "Memoirs of the Geol. Survey of the United Kingdom," decade iii. plate viii. 1850. He did great service by grouping the varieties of the species and by describing and illustrating a type. It is not necessary to quote Forbes's description at length, but only to refer to important parts of it. "The ambulacrals are minute, and often cuneiform, and are separated from each other not infrequently by small accessory plates." "The base is flat. Its ambulacral and interambulacral areas are studded with numerous spiniferous tubercles, larger than those of the dorsal surface. In the former they form oblique rows of four, or at most five, across the whole of each ambulacral space near the margin, and diminishing in number towards the mouth; in the latter they are thickly crowded towards the margin, and ranged towards the mouth in oblong transverse groups, interrupted by raised granulated wavy spaces which mark the lines of junction of the plates, and forming an arachnoid arrangement of irregular rings on the base, of which the mouth is the centre." "The base is elongated, posteaally thickened, and subrostrated for the anus, which is large and broadly elliptical in a longitudinal direction; its margins are raised and

thick." "The anus is inferior and sub-marginal." "The mouth appears round, but is obscurely decagonal, being gently notched at its margins opposite the avenues of pores. It is inflexed opposite each area, the inflexions opposite the interambulacral areas being deeper and semicircular. The pairs of pores are small, ranged in single file down the dorsal surface, falling into series of three pairs on the base soon after passing the margin. The series become more and more oblique until, at a tenth or eleventh from the base, they are directly under each other, and consequently give considerable breadth to the avenues. Three lines drawn up each avenue in the inner half of its basal course will intersect one of the pairs of pores of each series."

"The apex of the body is the highest point of the back. The apical disk is formed of five genital and five ocular plates. Four of the former are perforated, for the oviducts, in their lower halves; one of the perforated plates is greatly enlarged above, to form the centre of the disk, where it is wrinkled and punctured, constituting the madreporiform plate. The fifth posterior odd genital plate is very small, triangular, and imperforate."

"The existence of a dental system in *Galerites* was made known by Mr. Charles Stokes." "A second specimen with teeth adorns the collection of Mr. Bowerbank, and in it the dental lantern is sufficiently protected to enable us to determine the form and structure of its principal elements. The teeth are smooth, white, lanceolate, triangular, each consisting of a concave lamina, terminating below in the dental point, and straightened on its back by a prominent rounded ridge." In the plate drawn by Bone after Forbes, the whole of the type, seen from the side, clearly indicates that the base is not flat (Fig. 1): the anus is distinctly inferior and submarginal (in Fig. 2): the ambulacral plates are rectangular and equal, the pores are oblique (Fig. 5): the triplets are well shown (on Fig. 6). The teeth are shown, three placed side by side and quite close!!! (Fig. 10, and magnified in Fig. 10a). A single tooth magnified is shown at *b*. Figure 12 shows the posterior ocular plates widely separated by the fifth genital plate, and the anterior edge of the left posterior ocular is in contact with the madreporic plate.

Cotteau et Triger in their *Échinides du Departement de la Sarthe*, 1859, classify the species now under consideration with the genus *Echinoconus* of Breynius, 1732, and give a long list of synonyms.

Omitting all considerations regarding the generic title, these authors may be said to have given much more correct morphology than their predecessors.

Their *Echinoconus conicus* = *Galerites albogalerus*, var. *pyramidalis*, var. *angulosa*. They state that the base is perfectly flat, the interambulacra furnished with little tubercles crenulated and perforated without serial order, distant abactinally, closer, larger, and more scrobiculate at the ambulus and actinally. Intermediate granules abundant, unequal, and sometimes irregular. Ambulacra narrow, provided with tubercles similar to those in the interradia; however,

they appear to be closer, especially above (abactinally), and they form a distinct row close to the edge of the poriferous zones. The ambulacral plates are irregular and very unequal, and many of them do not reach the centre of the ambulacrum; but each has a pair of pores which are simple and directly superposed on the upper surface (abactinal), and being grouped in triplets lodged in oblique furrows on the actinal surface. The apical system is compact, almost square and granular. It is composed of four genital plates and a small imperforate supplementary plate, and of five ocular plates all perforated. The small posterior genital plate does not separate the posterior ocular plates, which are very unequal in size and differ in shape, the right posterior being in the median line. The anus (periproct) is large, elliptical, infra-marginal, slightly pointed at its upper end and with a long triangular area between it and the mouth. Peristome central, rounded decagonal. The figures given on plate 47 of Cotteau and Triger's work noticed above are faulty as regards the apical system.

Lovén employs the synonym *Echinoconus conicus*, Breynius, for *Galerites albogalerus*, places the form amongst the toothed Echinoidea,<sup>1</sup> and explains that there is no fifth generative plate. In his plate xv. fig. 134, he indicates the large madreporic right anterior genital plate stretching over the median line and uniting with the much smaller left anterior and left posterior generative plates. He shows that the right posterior ocular plate comes into the median line, and has its anterior edge in contact with the madreporic plate, and that the postero-lateral generative plates are separated by this ocular plate alone. So that the posterior part of the madreporic plate is in contact with the postero-lateral generative plate and the right posterior ocular plate.

The distance between the postero-lateral generative plates is not great, and the edge of the ocular plate which is jammed in between them is narrow from side to side. The madreporic does not pass backwards beyond the postero-lateral generative plates.

The position of the posterior ocular plates is remarkable; the right one being more anterior than the left, which is pushed behind and to the left, and does not come in contact with the madreporic plate.

This able observer notices the deficiency of knowledge regarding the interradial areas of the Echinoconidæ, but notices the disposition of the ambulacral pores near the peristome in triplets and gives an admirable illustration of them in another species (*op. cit.* plate xiv. fig. 129, page 20).

"The Revision of the *Echini*," by A. Agassiz dates 1872—1874. It does not describe the genus *Galerites*, but he states (p. 337) that he would limit the *Galerites* to the group provided with teeth. "I am aware that the great development of *Galerites* in former geological periods, and the relation of the anus and test (? mouth) may on further acquaintance with living representatives entitle them to rank

<sup>1</sup> Lovén, *Etudes sur les Echinoidées*, Stockholm, 1872.

as a sub-order intermediate between the *Echini* proper and the *Clypeastroids*." That is, between the groups with teeth. A. Agassiz has not otherwise remarked upon the genus.

In 1874 the Palæontographical Society<sup>1</sup> published a Monograph on the British Fossil Echinodermata from the Cretaceous Formations, by Dr. T. Wright, F.R.S., etc.<sup>2</sup> It dealt with the genus *Echinoconus*, Breynius, and described *Galerites albogalerus* under the name of *Echinoconus conicus*.<sup>3</sup> In the generic diagnosis<sup>4</sup> Dr. Wright states that the peristome is "notched" with internal auricles supporting a pentagonal masticating apparatus. He observes also that the pores are unigeminal except near the peristome where they are trigeminal, moreover that there are miliary granules either microscopic and homogeneous filling up all the intermediate spaces between the perforate and crenulate large tubercles, or larger and more developed and disposed in regular circles around the primary tubercles. He states that there are five ovarial (genital) plates, one being imperforate, and "the right antero-lateral is much the largest and is prolonged posteriorly with a portion of the madreporiform body into the centre of the disk; the three other plates are much smaller and terminate externally in prominent angles in which the genital aperture is pierced. The five ocular plates are very small and interposed between the angles of the ovarials." Dr. Wright describes the form now under consideration as the most typical of the genus. The diagnosis is as follows: "Test much elevated, conoidal, larger anteriorly than posteriorly; slightly angular and rounded at the border; base flat; single inter-ambulacrum tumid and recurved; vent large, oval, infra-marginal; mouth opening central, peristome decagonal, armed with five pairs of dentigerous jaws; ambulacra straight, narrow, doubly lanceolate; pores small, unigeminal in oblique pairs, which become trigeminal near the peristome; inter-ambulacra wide, angular; tubercles on both areas, small, homogeneous; granules abundant, unequal, sometimes elongated and prominent; apical disk small, quadrangular, very solid. Height,  $1\frac{5}{10}$  inch; altitude,  $1\frac{4}{10}$  inch.

The species is illustrated on plate 1 of the Monograph on the British Fossil Echinodermata from the Cretaceous Formations, vol. i. part 6, Pal. Soc. Lond., 1874. The apical disk shows the fifth genital plate and the very wide apart posterior ocular plates (fig. 1c). The ambulacrum drawn shows rectangular equal plates and slightly oblique pores. The figure 8 is said to exhibit the jaws and teeth *in situ*, and figure 6, a copy from Forbes, shows the teeth magnified.

The species is very common, and yet the majority of specimens do not show structure well, but the British Museum contains many which are beautifully preserved, and amongst them the celebrated Bowerbank type. I have a few perfect specimens, which were collected by my son, S. V. Duncan, who has assisted me in this research, and one has the so-called teeth and jaws. There is a most instructive series of casts in flint of the species in the British Museum. Altogether I have examined about one hundred fairly

<sup>1</sup> Vol. xxvii.

<sup>2</sup> Vol. i. part 6, on the *Echinoconidæ*.

<sup>3</sup> p. 221 et seq. plates xlix. figs. 2, 3, 4. Plate 1. fig. 1-6.

<sup>4</sup> p. 213 et seq.



good forms, and the result has been that I differ very considerably with all previous writers except Lovén, and with him upon one main point. In fact, until I had completed my examination, I had perfectly orthodox and at the same time highly erroneous views regarding this common type.

Admitting the variability of the species in its relative height, I find that in well-preserved specimens the actinal surface or base is not flat. The test rests on a downward projection anterior to the peristome (mouth) and on a rounded surface between this and the anus. The result is that the peristome (in the natural position of the test) is higher than the points on which the base rests. The fossil is unsteady.

The statement that there are "internal auricles supporting a pentagonal masticating apparatus," made by Dr. Wright, is one of the most extraordinary fictions ever imagined. I find that there are *no teeth at all, no masticating apparatus, and no internal auricles*. There are *ten buccal plates*, two to each ambulacrum, placed close to the edge of the peristome side by side, and forming a nearly perfect circle. These are to be seen in several specimens at the British Museum and in Bowerbank's specimen. These plates are figured by Dr. Wright (*op. cit.* pl. I. fig. 5) as jaws and teeth *in situ*.

Their inner margins are sharpened by him more than they really are. I find on the free surface of these plates an ornamentation of a few miliary tubercles and the plates are blunt there and slightly concave. By scraping away the chalk above them that is within the peristome, it can be shown that the buccal plates are rather thick as well as broad. The things called teeth by Forbes, and copied by Dr. Wright, are buccal plates with portions of chalk attached to them cut into the elongate and sharp condition with the clearing out knife. The points looked upwards into the cavity of the test and had they been those of teeth, the animal would have masticated its own internal tissues. An Echinoid with ten teeth pointing inwards would be a phenomenon.

When the buccal plates are in position, the peristomial opening is small, and it is evident that there would not be room for any jaws to come down it and act efficiently.

What Mr. Stokes saw, and described in the Transactions of the Geological Society, were buccal plates and not teeth, and all the figures of teeth by Forbes are inventions.

There are no auricles to be seen in any specimen I have examined, and a beautiful section of a perfect test, made at my solicitation by Dr. Woodward, and which is in the British Museum, proves that nothing like auricles ever existed. I have carefully washed away the chalk from the neighbourhood of the peristomial plates, and within the test of other specimens, and have not found anything of "the nature of internal auricles supporting a pentagonal masticating apparatus." Figures of the auricles have been drawn, and from casts in flint. There are pyriform projections in the position of auricles. Now in a cast a projection is a depression in the original, and an impression of the cast proves the auricular idea to be as

fallacious as that regarding the teeth. On cleaning out a good specimen which was filled with chalk no trace of auricles could be found, and the so-called "casts" are extremely rudimentary. The interambulacra thicken close to the peristome, and between the rounded thickening and the edge of the peristome is a depression, and it is this which, in the state of cast, simulates the auricular base. But it is really not in the position of such a base.

*Galerites albogalerus* is then edentulous, and has no auricles. The position of the periproct (anus) is not altogether infra-marginal in perfect specimens. Its upper part can be seen on the margin when the test is looked at from behind on a level with the eye.

The apical system most certainly does not show a fifth genital plate. About 40 of the specimens examined by me show the apical details very well. There is some variability of the arrangement of the postero-lateral genital plates, and the posterior oculars, but I have never seen the madreporic body which, as usual, occupies an enlarged right anterior genital plate pass backwards and separate the posterior oculars. The disk is very compact, and the following are the variations in the relations of the plates.

1. The madreporic plate reaches over the median line, is in contact anteriorly with the much smaller left anterior genital plate, and with the odd anterior ocular. The madreporic is in contact posteriorly with the postero-lateral genital plates and the right posterior ocular plate. The right antero-lateral ocular plate touches the madreporic, and the left antero-lateral ocular is occluded by the junction of the left lateral genital plates. The left posterior ocular plate is not in contact with the madreporic.

2. The same—but the left antero-lateral ocular plate separates the left lateral genital plates, and comes in contact with the madreporic plate.

3. The same—but both posterior ocular plates, which are small, are in contact with the madreporic (Brit. Mus. 38,723, and 38,731).

4. The postero-lateral generative plates unite along the median line and separate the madreporic from the posterior oculars (Brit. Mus. 38,731, middle specimen on the tablet).

5. The postero-lateral generative plates unite to the left of the median line.

The occasional entry of the right posterior ocular plate into the ring is accompanied by its increase in size, and by the pushing backwards and to the left of the left ocular plate. Lovén's (plate xv. fig. 134, *Etudes*) delineation represents one of the commonest of the above variations. The drawing of the apical disk by Desor, Forbes, and Wright is absolutely wrong. Cotteau and Triger show a rare variation, but I have never seen the small genital plate they represent.

The ambulacra, above the margin of the test, are not equal and rectangular as drawn by Forbes and Wright. At a short distance from the ocular plate, and where the breadth of the ambulacra corresponds with that of the drawings of the above-mentioned authors, the plates in succession are unequal, and one does not reach the

median line of the ambulacrum. These plates are in sets of three: the upper one is low and long and rectangular; the next is triangular with a curved outer edge close to the pores, and the third is irregular in shape, being taller at the median line and of the same height as the other two at the poriferous side. The pairs of pores are not near the sutures of the ambulacral plates; and above the margin of the test the direction of the two pores is oblique: one pore being above the other and towards the inter-ambulacrum. But below the margin the upper pore gets first directly above the other, and then obliquely, being above and towards the median line of the ambulacrum. This obliquity is increased where the triplets occur.

Each triplet comprises a set of three ambulacral plates as described above. The pair of pores (of the triplet) nearest the ambulacral median line is on the upper rectangular plate; the next pair a little further out towards the interambulacral edge of the ambulacral plate is on the triangular plate, and the third pair further out still, is on the lowest and largest plate and close to its interambulacral edge. The two ambulacral plates closest to the peristome have according to the ambulacrum one pair on one side of the median line and two on the other side. The arrangement of the triplet is unlike that of any other genus.

There is a point of considerable importance about the peristome, its edge is carried upwards very slightly in the interambulacral part so as to produce the rudiments of a tube, which is very evident in such genera as *Amblypygus* for instance.

The position of *Galerites albogalerus* = *Echinoconus conicus* as a toothed form can no longer be maintained. It has a singularly concentrated apical system and but four genital plates. The ambulacra reaching from the ocular plates to the peristome and widening out at the margin of the test have intercalated small triangular plates, and the direction of the pores of the pairs alters. The triplet arrangement has nothing to do with extra plates, and is produced by the position of the penetration of the successive plates by the tentacles. Five pair of buccal plates exist in well-preserved specimens.

With regard to the construction of the base of the test, it may be observed that there are 6 plates between the peristome and the periproct, and that the 7th from the mouth enters into the composition of the periproct, as also do the 8th, 9th, and 10th.

On the whole, the test is thin, and there is a specimen in the British Museum which shows that an inward bulge was produced during life.

The genus *Galerites*, and possibly some others which have hitherto been associated together in the family Galeridæ, must join some atelostomatous group. Lately Mr. Percy Sladen and myself<sup>1</sup> have shown the affinities of the genus *Amblypygus* and *Echinoneus*, and it is evident that only the oblique mouth and certain peristomial plates separate these genera from *Galerites*. It should stand amongst the Echinonidæ, a sub-family of the Cassidulidæ, of the sub-order Atelo-

<sup>1</sup> Fossil Echinoidea of Kachh and Kattywar, Pal. Indica, ser. xiv. vol. i. part 4, 1883.

stomata. This position is diametrically opposed to the dictum of A. Agassiz, that the Galeritidæ have no affinity with *Echinoneus* ("Revision," p. 332); but it assists him in his comparisons of *Cystechinus* with ancient forms. Lovén, whilst tacitly acknowledging the old notions about *Galerites*, showed there are affinities between the Echinoconidæ and Echinonidæ.

V.—ON THE DENTICULATED STRUCTURE OF THE HINGE-LINE OF  
*SPIRIFERA TRIGONALIS*, MARTIN.

By JOHN YOUNG, F.G.S.,  
of the Hunterian Museum in the University of Glasgow.

RECENTLY, when examining some weathered fossiliferous limestone shale from the Lower Carboniferous strata of East Kilbride, Lanarkshire, my attention was attracted to some fragments of the valves of *Spirifera trigonalis*, Martin, in which I noticed, on the hinge-line of the dorsal valve, a row of small, round, hollow pits, and on the hinge-line of the ventral valve, a corresponding row of small, projecting, rounded denticles. These characters I had not noticed before, and on searching further, I found other fragments of the valves showing the same thing. This led to an examination of more perfect specimens of this *Spirifera*, contained in my own collection, and that of Dr. J. R. S. Hunter, of Braidwood, Carluke, and in one example, where the valves had slightly opened through pressure, on clearing away the shale, I found, on the outer edge of the ventral valve, a distinct row of small projecting denticles, that had evidently fitted into hollow pits or sockets in the dorsal valve, but from the way the valves had shifted in this specimen these were not seen. These denticles, when looked at externally, are nearly as numerous, and much of the same size, as those seen in many of the hinge-lines of shells of the genus *Arca*, only in this genus the teeth are the same in each valve, and lock into each other.

*Spirifera trigonalis*, Martin.

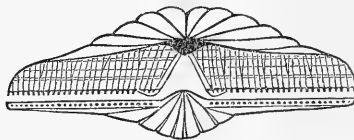


Diagram sketch, nat. size, valves slightly open to show  
the denticulated hinge-line and pits.

The denticles, as already stated, project from the outer edge of the hinge-line of the ventral valve, which is seen to be bevelled from within outwards so as to present a moderately sharp edge, and on this edge the denticles are situated. On a specimen, measuring one inch and three-quarters in length along the hinge-area, thirty-five of these small denticles may be counted on either side of the central triangular fissure. Sometimes there are more or less, their numbers generally corresponding in most specimens with the extent of the hinge-area.

It had long been noticed that in the shell structure of the external surface of the hinge-line area in the ventral valve of many of the species of *Spirifera*, as well as in others of the straight-hinged Brachiopods, there exist a series of vertical lines or tubes, slightly inclined and waved in some specimens, but more often straight in others. These lines are well illustrated in the figures of many of the *Spirifera* in the plates of Dr. Davidson's Monograph of the Carboniferous Brachiopoda, and in the *Spirifera* figured on plate ix. of Prof. King's Permian Monograph, but so far as I am aware, no one has noticed or described these lines or tubes as forming and corresponding with a row of denticles along the edge of the valve in the specimens on which they are found. I have, however, obtained clear evidence in the specimens that I have examined that such is the case, as shown in the diagram-sketch of the hinge-area. Some of the lines bifurcate in their upper extremity, but the greater majority are single, and they slightly increase in thickness as they approach the edge of the hinge, in which they are seen to be continuous with the denticles.

At first, I thought that these lines leading to the denticles might have originally been hollow tubes, but I have failed in finding any of them filled with clay, pyrites, or other mineral matter, which is common in the tubes and perforations of other shells from the same beds. Such being the case, I am now inclined to regard them as having been originally composed of vertical lines of aragonite in the shell structure, which, being harder than the ordinary calcite of the shell, went to the formation of the row of denticles. These lines are now seen to be composed of a coarser and more structureless kind of calcite, than that forming the hinge-area of the shell, and it often weathers out into hollow grooves upon the external surface, or when the lines have been etched with acid.

It is now well known that both calcite and aragonite enter into the composition of the shells of many of the Mollusca, and it has been further shown, by Dr. Sorby and others, that while the aragonite was originally the hardest of the two varieties of lime present, yet, during fossilization, it was the first to change or go to decay, its place being often taken by calcite that had infiltrated into the shell, and when this is the case, it is found that the calcite replacing the aragonite is of a more crystalline and coarse structure than that now entering into the composition of other parts of the shell. If I am therefore right in my conjecture as to the denticles and lines of coarser structure seen on the hinge-area of the ventral valve of the *Spirifera* under notice having been aragonite, its present condition can be explained by the changes that have taken place during fossilization, and of its former use in the structure of the shell, while the animal was in life, in the formation of its hard row of small denticles.

After a careful examination of the hinge-area of the dorsal valve in this species of *Spirifera*, I am inclined to think that the row of pits or sockets seen along its area have been worn out solely by the friction of the harder projecting points of aragonite in the

hinge of the ventral valve that formed the denticles. These working mechanically in the softer calcite of the dorsal valve, through the continuous opening and shutting of the valves, would naturally wear out a row of pits corresponding with the number of denticles.

The object which these denticles and their sockets had to serve in the economy of this organism was probably that which Dr. Davidson has suggested to me by letter, viz. "to steady the valves, especially when the hinge-line was long and the teeth not very large." I have also to note that in several specimens that I have examined there is clear evidence of successive layers of shell-growth along the area of the hinge-line of the ventral valve. These stages show in the rounded appearance of the calcite layers around the denticles that there had been in the growth of the hinge-area periods in which for a time it had remained stationary, and it has also occurred to me that the bifurcation seen in some of the lines that went to form the denticles may be satisfactorily explained on the supposition that there had been at these points of the hinge-area originally two lines of aragonite, forming two separate denticles, which from some cause afterwards converged so as to form only one denticle.

The Scottish specimens of Carboniferous *Spirifera* in which I have found the clearest evidence of the denticulated hinge-line are those obtained from shales in which the shells and other organisms have not been much mineralized. Those from the harder limestones, although showing in many specimens the vertical lines on the hinge-area distinctly, yet their valves are so firmly locked together that evidence of the denticles can only be obtained by carefully scraping the edge of the hinge-line with a knife, and etching the area with acid.

The species upon which I have worked is *S. trigonalis*, Martin, and its variety *S. bisulcata*, Phillips, which is similarly denticulated. On the thin-shelled and short-hinged species, such as *S. glabra*, Mart., and *S. lineata*, Mart., denticles seem to be absent, or, if present, are only very feebly developed. An examination of other straight-hinged genera of Brachiopods, such as *Streptorhynchus* and *Strophomena*, from our Scottish Carboniferous strata, show only in some instances traces of vertical lines on the hinge-area and very feeble indications of denticles, but this may be due to the less perfect preservation in the beds where they have been found; for in the *Strophodonta* from the Silurian strata of America the denticulated hinge-line is often beautifully preserved.

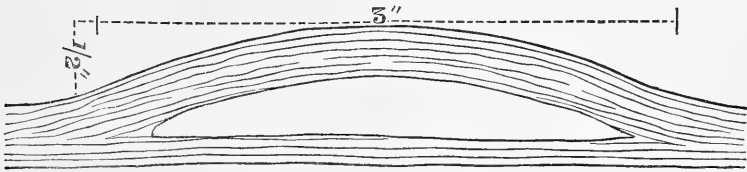
---

## VI.—MINIATURE DOMES IN SAND.

By T. MELLARD READE, F.G.S.

IN walking along a stretch of very fine smooth sandy shore at Blundellsands, I was very much struck at finding a portion of it studded over with numerous bosses of sand from  $\frac{1}{2}$  in. to 3 inches in diameter. Wondering what could be the cause of this singular phenomenon, I dissected some of them with my knife, and found in all cases a cavity below corresponding in extent and height to the

external form of the boss or tumescence. The perfect regularity and smoothness of these protuberances was very remarkable; they appeared to be in all cases segments of spheres connected with the plane of the shore by reflex spherical curves. The largest I dissected measured 3 inches in diameter rising half an inch. The thickness of the dome was  $\frac{1}{3}$  an inch and the cavity below was 3 inch diameter also. The following is a section—



Clean, fine, siliceous sand seems *a priori* a very unlikely material for blisters to arise in, yet there they were. Occasionally the crown of the dome had little cracks across it as if broken in the extension or swelling up of the dome of sand.

Further examination showed that the sand in question lay at the foot of a little line of cliff eroded in the Peat and Forest Bed. It rested upon a bed of blue clay, usually bare, and is about a foot thick. The bosses were found along a zone of the sand running parallel to the peat cliff and from 6 to 10 feet from it. I came to the conclusion that these little domes were lifted by air imprisoned between the clay and the moist surface of the sand, the water collecting on the surface of the peat percolating from the line of cliff along the clay, and forcing the interstitial air upwards. The cohesion of the moist surface layer of sand being sufficient to prevent its escape at once upwards, it has forced itself along a line of laminae laterally, and so assumed the form of a flat bubble. The grains of sand form the *voussoirs* of the dome and the water the cementing material. Once formed, they will stand without the imprisoned air so long as the sand is moist. I have often observed blow-holes in the shore sand and air issuing with a hissing noise, and I have also seen minute bubbles in the shore formed by a film of sand cemented by water, but never anything like what I now describe.

Probably very few people know how much interstitial air space there is between grains of sand. I have just made an experiment to ascertain it. I filled a bottle with 7 oz. of perfectly dry sand shaking it well together. I then immersed it in a vessel of water with the orifice below the surface. Bubble after bubble arose until the point of saturation was reached, but the bulk of the sand remained constant, neither increasing nor diminishing. On weighing it, I found it held 2 oz. of water. Taking the specific gravity of the quartz grains at 2.6, the relative *bulks* were: sand 7, water 5. That is, out of 12 cubic feet of sand and water at the point of saturation of the sand, 7 would be quartz and 5 water. Thus in saturating 12 feet of absolutely dry sand (which I need hardly say is never met with in

nature) 5 cubic feet of air would be displaced. The grains of sand are very rounded. The proportion of a sphere to its circumscribing cube is  $\cdot 5236$ , so the interstitial space is rather less in this sand than it would be with an equal mass of small shot of uniform size. The cementing power of moisture in sand is very remarkable, for moist sand will stand nearly vertical for a considerable height, the same material when dry flowing like water. The sand dunes when moist being denuded into cliffs by the sea, but not at other times, show this.<sup>1</sup>

Probably I may be asked what is the geological application of the foregoing. Well, I did not write with any special application in view—but simply to record a curious fact. If, however, we substitute beds of rock on a large scale for the sandy laminae, and molten rock injected from below, for the air, we shall have a pretty good model of the *modus operandi* of the formation of the laccolites or stone cisterns so well expounded by Mr. Gilbert in his *Geology of the Henry Mountains*.

---

VII.—NOTE ON THE SYNONYMY OF *PHILLIPSIA GEMMULIFERA*, Phillips sp. 1836, A CARBONIFEROUS TRILOBITE.

By HENRY WOODWARD, LL.D., F.R.S.

**A**LTHOUGH the Carboniferous Trilobites are but few in number, and are all included in four genera, they have not escaped the usual trouble arising from incorrect determinations.

One of these occurred in reference to *Phillipsia gemmulifera*, Phillips, sp., better known by the name of "*Phillipsia pustulata*," Schlotheim species, a name first applied to this form by Professor de Koninck in 1842-44 (see *Descr. Anim. Foss. Terr. Carbonif. de Belgique*, p. 603, tab. liii. fig. 5).

This Trilobite, first known by a pygidium only, was very carefully figured in "Brongniart's and Desmarest's *Histoire Naturelle des Crust. Foss.* 1823, p. 145, pl. iv. fig. 12, 1822," where it is called "*Asaphus*" from the black limestone in the environs of Dublin.

It was next figured by Phillips in his *Geology of Yorkshire*, 1836, vol. ii. pl. xxii. fig. 11, p. 240, who named it *Asaphus gemmuliferus*.

Buckland again repeats the figure later in the same year, and follows Phillips's name of *A. gemmuliferus*.

Prof. de Koninck, in 1842-44, changed the name to *Phillipsia pustulata*, quoting Schlotheim's "Nachtrage zur Petrefactenkunde" (ii. Abth. pp. 42-3, Gotha, 1823, and Atlas, p. 22, and plate xxii. fig. 6) as his authority. Now as Schlotheim's Trilobite differs very greatly from Phillips's figure, and also from those given by Brongniart, and by Buckland, and as moreover Schlotheim's specimen was said to have been derived from the youngest Upper Transitional Limestone (Devonian) of the Eifel, I felt great doubt in accepting Prof. de Koninck's correlation of *Phillipsia gemmulifera* with the *Trilobites pustulatus* of Schlotheim.

<sup>1</sup> See *Æolian Sandstone*, *GEOL. MAG.* 1881, p. 197.



These doubts I expressed in my Monograph,<sup>1</sup> and acting on the evidence of the age (Devonian), and the published figure of Schlotheim's specimen, I restored Phillips' specific name of *gemmaefera* for this Carboniferous Limestone form, and discarded that of Schlotheim (*T. pustulatus*) as untenable. Having lately seen and consulted my friend Prof. Dr. Ferdinand Roemer, of the Mineralogisches Museum, Breslau, our highest authority on the fossils of the Eifel, he very kindly promised me, on his return journey, in passing through Berlin to Breslau, to compare my figures of *Phillipsia gemmaefera* with Schlotheim's specimen of *Trilob. pustulatus* in the Berlin Museum. I now have the pleasure to append his letter, which entirely sets the matter at rest.

“Mineralogical Museum of the Royal University of Breslau. Dear Dr. Woodward,—Schlotheim's *Trilobites pustulatus* is nothing else than a pygidium of *Phacops latifrons* from the Eifel. This is proved beyond any doubt by Schlotheim's original specimen in the Berlin Museum.—Yours very truly,

“(17th October, 1883.)

FERD. ROEMER.”

## NOTICES OF MEMOIRS.

### SOME GEOLOGICAL CONDITIONS AFFECTING THE QUESTION OF WATER SUPPLY FROM THE CHALK.

[Part of the Presidential Address to the Norwich Geological Society, 6 Nov. 1883.]

By W. WHITAKER, B.A., F.G.S., of the Geological Survey.

IT has occurred to me that I might profitably take as the chief subject of my address one of practical importance, and one showing that the detailed mapping of our county by the Geological Survey, which is now all but finished, is not a matter of mere theoretical interest.

As our Survey will be finished this year, except for some questions of revision in the western part of the county, and as some time next year the officers of that Survey will be denuded from Norfolk, the present seems a fit time for bringing forward such a subject. Were the question put off for the publication of the whole of the Survey Maps, it would be at least two years before it could be brought before you, and though I suffer therefore from the want of great part of the material needful for a full consideration of the question as regards Norfolk, yet I think that we have enough to warrant its discussion, especially as it can be illustrated by reference to other districts of a like character. Indeed the amount of material in my hands is so large that I have been unable to work it all up in time, and therefore have had to neglect some parts of the bordering counties of Cambridge and Suffolk which I had hoped to have illustrated amongst the maps before you.

During the course of my work on the Geological Survey I have paid some attention to the question of water-supply, and a few years ago I had to make a set of maps for the purpose of showing the

<sup>1</sup> See Mon. Carb. Limestone Trilobites, 1883, part i. pp. 17-19, plate iii. figs. 1-8. See also GEOL. MAG. 1883, Decade II, Vol. X. Fig. 3, p. 450.

areas of Chalk, in part of the London Basin, that were open to receive and absorb water. It was only those parts over which the Geological Survey had mapped the various subdivisions of the Drift that were available for this purpose, for fairly clear reasons, which will be referred to at some length further on; where the Drift has not been mapped, the Survey Maps are comparatively useless.

It is to the particular subject of this set of maps, namely, the accessibility of the chalk to surface-water, that I wish to draw your attention, illustrating it by copies of some of the original maps, by what I may call an improved or second edition of some of them, and by an extension of the work into Norfolk and Suffolk.

Before doing this, however, it may be well to allude to the present state of Chalk water-supply in the county, as far as my knowledge goes. There are three ways of getting public supplies of water from the Chalk, and it is to public supplies only that I shall refer:—namely, the underground way, by wells and borings; the guarded surface way, by closed pipes from a spring-head; and the over-ground way, by an open channel, natural or artificial.

I believe that Cromer, Dereham, Swaffham and Thetford are the only Norfolk towns that get their supply by the first way. I know of no Norfolk town that gets water from the Chalk by the second way, though the seaside resort of Hunstanton is thus supplied; but the Cambridgeshire town of Wisbech does so, leading the water from the springs near the base of our Norfolk Chalk at Marham through some sixteen miles of pipes, and thus giving the great boon of good water to a district in which none occurs. The enterprise of Wisbech is thus in strong contrast to the apathy, and one may say the stupidity, of the larger town in which I have the misfortune to live, its Norfolk rival, Lynn, the corporation of which treat the inhabitants to one of the worst supplies that I know of. These guardians of the public health allow a set of Chalk springs, some pure, but others contaminated, to mix together and to flow along an open channel of six miles or so, as the crow flies, receiving on the way the drainage of a fair tract of country, and, at the last, close by the borough-boundary, some part of the sewage of the village of Gaywood. Notwithstanding that the evil of this course has been pointed out for years, and constant complaints occur, yet our town-councillors, in the multitude of whom there is not wisdom, have not yet made up their minds to any decided action, and a question that really admits of no debate is the subject of apparently endless discussion: "Words not deeds" should be the town-motto, at least as far as regards water-supply.

Since the above paragraph was written, the Town Council of Lynn adopted a scheme for the supply of good water; but I fear in a half-hearted way: at all events their scheme has been rejected at a meeting of the ratepayers, and I am therefore compelled to transfer the charges above made from the members of the council to the body of the townsmen, who seem not to be educated up to pure water pitch! When they have had a serious epidemic, perhaps they may acquire more sensible views on this matter.

The supply of Norwich, taken from the Wensum, is I believe free from serious contamination.

In the western part of Norfolk there are large quantities of chalk-water, which may be said to run to waste, and the abstraction of which it seems to me would result in the improvement of certain tracts that are now water-logged. This water flows into streams that are really little else than drains, and not always sufficient ones, for large tracts of lowland, which tracts would also be improved by being rid of some of the water. The parts where the springs rise are often of a peculiar nature, the dissolving away of the chalk having caused the formation of a great number of small hollows, more or less round in shape, from the sinking in of that rock and overlying sand and gravel. The bottoms of these hollows are filled with water, probably because they reach the saturation-level of the Chalk, the same cause that gives us the much larger sheets of water in the District of the Meres at a higher geological level in the Chalk, the tracts now alluded to being near the base of the formation.

At our last Yearly Meeting I remarked that the completion of the Geological Survey of a district did not result in the exhaustion of that district, as regards geological investigation, but rather that our work aided future workers. The set of maps to which I have now to call your attention is an illustration of this; for, whilst they can only be made after a detailed survey, yet they need for their construction something more than is shown on any Geological Survey Map, or that can be easily worked out from a Memoir. They need a consideration of various local circumstances, which it is open to any careful geological observer to make: there is indeed only one thing in which they absolutely follow the geological maps, that is, as regards the area of bare Chalk.

I would remark at once that these maps are not geological maps, and it is important that you should remember this, or you will misunderstand them, though they are founded on geological maps: their object is to show what comes between the Chalk and the rain.

For this purpose it was found that all our geological divisions, from the Chalk upwards, could be grouped under 4 heads, as follows:—

1. Areas where the Chalk is bare (except of course for soil), and in which therefore water has free access to it.

2. Areas where the Chalk is covered by permeable beds only, or by beds almost wholly permeable, and in which therefore water has nearly free access to it.

3. Areas where the Chalk is covered by beds of varying character or mixed structure, partly permeable, partly impermeable, and in which therefore water has but a limited power of access to it.

4. Areas where the Chalk is protected by impermeable beds, and in which therefore water does not sink into it.

Now, in colouring these maps in accordance with the above scheme, and in thinking over the colouring of others not yet to hand,

I have found only two certainties, that is, only two colours on our Geological Survey Maps that could at once be followed. These two are the outcrops of the bare Chalk (No. 1) and the areas of the London Clay, which latter of course range themselves under No. 4. Moreover, it is not only where London Clay is shown as occurring at the surface that this holds; but also over the tracts where it occurs beneath other beds, so that, for our purpose, the whole of the Bagshot Sands (mostly permeable though they be) are coloured with impermeable areas as regards the Chalk, and so also will be great part of the Suffolk Crag tract, although that Crag is highly permeable.

As far as I have yet carried the work, one other colour on the Survey Maps can also be followed, for the Boulder Clay can be included with impermeable beds. However, in some parts in which this work is not yet done, it is possible that there may be some tracts coloured as Boulder Clay over which that bed has been altered, by surface actions, so that some of the clayey matter has been lost and the Chalk dissolved away, the remainder forming a stony loam that is not quite impermeable. Indeed, the fact of such alteration occurring at all, produced as it is mainly by the infiltration of water, is in itself a proof that the Boulder Clay is to some extent permeable, and therefore where thin it may let some amount of water through to more permeable beds underneath. Moreover, on some of the higher ground of West Norfolk, it is not easy to distinguish a thin capping of Boulder Clay from the weathered surface of the Chalk itself, for the Boulder Clay in those parts consists sometimes of little else than Chalk, being mainly a mass of chalk pebbles in a chalky matrix, with a little admixture of sand, but with little clay. It follows therefore that some Boulder Clay cannot fairly be coloured as impermeable; but must be classed with the mixed beds (No. 3).

Of course with this Clay, as with the London Clay, it is not only where it crops out, but also wherever it underlies other beds, which may be highly permeable, that we have to take it into account; this however, is one of the things that is sometimes not shown on the Survey Map; but which must be shown from knowledge of the ground, or by inference, from the lie of the beds.

Having drawn your attention to the more certain parts of the work, it may be well to treat of the various beds in stratigraphical order, premising that in all cases (unless otherwise mentioned) only their area of outcrop is referred to, and not parts where they are covered by Drift, of whatsoever character; and I will begin at the bottom.

*Thanet Beds.* — This comparatively local base of the Tertiary Series is almost wholly a fine sand in Surrey and West Kent, and may then be fairly treated as on the whole permeable. When, however, the map of East Kent is taken in hand, a different condition will have to be dealt with, for then we find a mass of clayey beds in the sands, which may cause the greater part to be impermeable, or at all events not higher in the scale than the mixed beds (No. 3). In Suffolk the outcrop of this division is too narrow to be shown

separately, and it has been included with that of the overlying division. In Norfolk neither of these come to the surface.

The *Woolwich and Reading Beds* are very irregular and varying in their composition, sometimes all clay, sometimes all sand, sometimes alternations of clayey and sandy beds. As it would be almost impossible to pick out the permeable and impermeable parts, the whole has been classed as mixed. In Norfolk and in the neighbouring part of Suffolk, where these beds are everywhere thickly covered with Drift, I have extended the colour of the impermeable beds up to their presumed boundary, as a matter of safety.

The *Oldhaven and Blackheath Beds*, though of a highly permeable character, are nearly everywhere underlain by the last division, and therefore their permeability is of no effect, as regards the Chalk, so that they have to go with the last, except in the very small areas where they cut through to the Thanet Sand, and in the outliers that rest direct on the Chalk.

The *London Clay* has already been noticed; but it should be remarked that its basal beds are often rather sandy, and let some water through. The outcrop of these beds however is so small that it may be disregarded. All the beds overlying this thick and widespread mass of clay are put out of court, as I have already said, being cut off from the Chalk by it, and thus the Bagshot Beds and the Coral-line Crag are wholly disposed of.

The *Red Crag* of Suffolk, however, in part rests on the Chalk, and must then take its proper place among the permeable beds, though most of it is taken out from the fact of overlying the London Clay. With its representative in our county, the *Norwich Crag*, the case is somewhat different, as it rests to a much greater extent on the Chalk. As however, in the Geological Survey maps, some upper beds are coloured with this series that have not always been classed with it, we must take into consideration the occurrence of those clayey patches, generally thought to represent the more continuous *Chillesford Clay* of Suffolk, which locally cut off the gravel and sand above from the Chalk, as far as infiltration is concerned, and as some of these patches are too small to be shown on the map, though they may have much effect underground, this is a case where local knowledge comes in, and I have to thank Mr. H. B. Woodward for giving me the advantage of his knowledge in this matter. As a general rule the *Norwich Crag*, has been classed as permeable, even where the lower part is not seen, and where, though small lenticular masses of clay or loam may occur, these would have little effect, merely throwing off the water locally.

The *Drift*, as you must expect, has a very varying effect, from its varying character. The *Boulder Clay* has already been noticed, and there is no need to recur to it; but the gravels and sands that often underlie it, though in themselves permeable, are sometimes cut off from the Chalk by clayey beds, whether thin local layers of *Boulder Clay* or masses of brick-earth. With regard to this *Glacial brick-earth* too there is much variation, for whilst most of the small isolated masses in the south are practically impermeable, when we get to the

northern part of our county some parts of the large sheet of brick-earth are sandy, and therefore fall into the Mixed division. Here, again, I have drawn on Mr. Woodward's knowledge; but nevertheless I can only look on part of the Norwich map as an approximation or a compromise.

When we come to the later, or Post-Glacial Drifts, as before, the gravels and sands range themselves in the permeable beds (of course I mean only when not underlain by impermeable or mixed beds); but the brick-earth is rarely impermeable, being generally of a sandy nature, and therefore classed as Mixed.

On the broad Chalk tracts of some of our more southern counties that rock is to a large extent hidden, over the higher grounds, by a very irregular mass of brick-earth, usually with a more clayey layer, known as the "clay-with-flints," at the base. Now this brick-earth is also sandy, and though the underlying clay would seem at first sight to be fairly waterproof, yet the fact that it has been formed simply by the gradual dissolving away of the Chalk, by the infiltration of carbonated water, is enough to show that water has sunk through to the Chalk in large quantity—the clayey matter being indeed simply a filtrate, the solid residue left after very long continued action. I have therefore classed these loamy and clayey tracts as Mixed; but they need not trouble us here, as they do not occur in Norfolk.

*Alluvium.*—It might be expected that the deposits of our marshes and river-flats would be impermeable, from their generally clayey nature; but I have thought it advisable as a rule to class them in the Mixed group. The reasons for this are that some alluvium is of a sandy nature, that some is very thin, and that the water-courses in many places cut through the alluvium to the gravel and chalk beneath; so that on the whole it is best to class it amongst the doubtful beds.

With regard to the four divisions adopted in these maps the first two, Bare Chalk and Chalk covered by permeable beds, naturally group themselves together, as also do the latter two, the areas taken up by mixed beds and by impermeable beds. It should be noted, however, that there are large tracts of the last division in which the natural drainage is outward, towards the chalk, in consequence of which much of the rain falling on such tracts of impermeable beds flows across them to the Chalk, or to permeable beds over the Chalk, and then in many parts wholly sinks into the ground, and in others partially sinks; so that these areas contribute to the supply of water in the Chalk. In some of the newer maps exhibited I have divided the area of the impermeable beds into two, distinguishing the part that drains away from the Chalk from that where the drainage flows to the Chalk.

Of course to make use of these maps it is needful to measure the various areas, and a very hasty look at the maps will show you that this will be a very troublesome task. It has been done however on the older maps exhibited, by engineers with the proper appliances for such work; but I have not ventured to attempt such measurements on the new maps.

The general result of the maps is to show that over large areas, coloured on ordinary geological maps as Chalk, that rock is covered by beds impermeable to water, the drainage of great part of which moreover flows away from the Chalk, and therefore cannot in any way contribute to the water therein.

I may here allude to the enormous error in all but the latest maps, in colouring the whole of East Norfolk and the northern part of East Suffolk as Chalk (except for Crag), whereas we know, from well-sections, that there is a mass of the older Tertiary beds (London Clay and Reading Beds) between the Drift or Crag and the Chalk along the whole of the Suffolk coast and the eastern coast of our county.

---

## REVIEWS.

---

I.—GEOLOGICAL SURVEY OF SOUTH AUSTRALIA. Report of the Government Geologist, HENRY Y. LYELL BROWN, F.G.S., Adelaide, South Australia, August 1st, 1883; with four chromolithographic plans. (Adelaide, Government Printing Office.)

THE Government of South Australia is to be congratulated on its wise decision to establish a Geological Survey of its Territories, the investigation of which has been hitherto left wholly to the energy of private individuals. First settled by a company, in 1834, it was not formed into a regular colony until 1841, and received the right of self-government in 1856. Its original area was about 300,000 square miles, but in 1861 its western limit was extended to 129° E.; and in 1863, the Northern Territory, reaching to the sea between 129° East and 138° East, was added, by which the area of the Colony was trebled. Hitherto South Australia has been chiefly distinguished for its valuable mines of copper, but its staple industry is wheat-growing, in which it is pre-eminent over its neighbours. It also has extensive sheep-runs, and since 1874 the number of sheep has never been less than 6,000,000.

Of course the great desire of every new country is to discover coal, and for the interior districts, water is indispensable to enable the large areas, seemingly well adapted for pasturage, to be occupied as runs.

The exploration which forms the subject of the present report was directed to the area comprised between 26° and 32° S. Lat. and 138½° and 141½° E. Long. The chief objects of this journey were to ascertain the extension from New South Wales into South Australia of the gold-bearing rocks of Mount Brown, and the Cretaceous formation in which artesian and other water has been found. The gold-bearing rocks were not found to extend across the border into South Australia, as far as could be ascertained. The Flinders range is the nearest point in this colony where rocks likely to prove auriferous outcrop, the intervening country being covered over with Cretaceous and Tertiary formations. There may, however, be some low outcrops occurring amongst the sand hills, but this is not very likely, and they cannot exist in any great extent. The extension of the Cretaceous

and Tertiary area into this colony from New South Wales and Queensland was proved along a distance of 225 miles of boundary of the former, and 300 miles of that of the latter colony.

The sketch map and sections accompanying the report are intended to show approximately the boundaries, thickness, and stratigraphical positions of the older mineral-bearing and the Secondary and Tertiary rocks. The latter are provisionally classed as of Cretaceous age, pending the obtaining of further information from fossils and the discovery of older underlying beds over any portions of the area. The ages assigned to the older rocks are in accordance with their similarity in composition and position to certain rocks in New South Wales.

“The following is a general list of the rocks referred to in this report, in descending order, with their ages provisionally :—

1. TERTIARY.—Sand, clay, gravel, and conglomerate ; gypsum and rock salt.
2. CRETACEOUS.—Table-land formation, sandstones, kaolin, grit, and conglomerate ; clay and sandy beds with gypsum, ironstones, sandstones, limestones, and calcareous clays in horizontal beds.
3. DEVONIAN (?).—Clay-stones, and conglomerates skirting the Flinders Range and elsewhere.
4. SILURIAN (?).—Limestones, clay-slates and shales, quartzites, calcareous slates, sandstones, siliceous and conglomeratic limestones.
5. METAMORPHIC.—Clay-slates, mica-slate, and schists with granite dykes.
6. Granite and greenstone.”

Fossils do not appear to have been commonly met with. But at St. Mary's Pool, in the bed of the MacDonnell Creek, “On some of the hard blocks of quartzite and quartzose sandstone near this place, there are marks somewhat resembling the impressions of the feet of human beings, kangaroo, birds, etc., which are considered to be fossil tracks. On examination they appear to be merely rough imitations of such, the smooth surface of the rocks having been removed by some hard instrument to a slight depth, the pitted marks of such action being plainly visible. Besides this, in one case, the plane of the supposed impression is at an angle with the planes of bedding of the rock.”

“The general direction of strike of the main line of quartz reefs at Waukaringa is about E.N.E., and the dip southerly, at an angle of from 25 to 35°. The thickness of these reefs varies from a few inches to about 20 feet ; the quartz is as a rule of a highly ferruginous character, and associated with iron ore and a ferruginous gossany formation. The veins occur in and between bands of quartzose sandstone, quartzite, sandstone, clay and calcareous slates, which form synclinal and anticlinal curves and undulations, and are highly jointed and cleaved.

“Richman's line lies further south, and strikes N. 53° E., with a north-westerly dip of from 35 to 55°. The character of the quartz and the bed rock are similar to the main line of reef.

“Blackfellow's reef to the north-west of the above line is said to have yielded the coarsest gold yet found in this locality. The vein, which is very thin, consists of quartz with carbonate of iron, iron pyrites and oxide of iron in greenish clay, slate, and argillaceous sandstone. These lines of reef outcrop towards the summit of low



ranges; others traverse the valleys between. The proportion of gossany quartz and iron ore found in them is considerable; the gold is found in both in a very finely-divided state. The lodes are strong and extend for long distances, and will doubtless be found to continue to considerable depths when followed. Very little work, however, has been done to the greater number of the claims, which have probably been taken up for speculative purposes. A few miles westward galena containing on assay 12 ozs. 14 dwt. 19 grs. of silver per ton has been found in an excavation a few feet deep on a ferruginous quartz lode. Of four assays of gossany quartz from the main line of reef, three contained only traces of gold, while the fourth yielded at the rate of 2 ozs. 12 dwts. 6 grs. to the ton.

“The country near Nellingho, Koonamore, and Waukaringa is all likely country for alluvial gold, which, however, does not appear to have been looked for to any extent, the absence of water preventing prospecting operations. From the general character of this country it is not likely that boring for artesian water will prove successful, for reasons set forth in report by Mr. Brown of April 9th, 1883.

“North-eastward from Waukaringa the rocks are a continuation of the same formation; calcareous varieties are, however, more frequently met with; they are capped in places by quartz gravel, similar to the Pliocene gravel of other gold-fields.

“About twenty-two miles from Waukaringa granite country begins, and continues eastward to Mingary Creek, alternating with areas of metamorphic and other slaty rocks. In the granite of the Ethiendua Hills, veins of quartz, hematite, and slate occur. Two miles S.E. of Mount Victoria, a copper lode has been found, and is being prospected and ore raised from a shallow depth; specimens of gold are found in the ore and quartz from the mine; the lode lies parallel to a dyke of soft bluish granite and decomposed serpentinous clay traversing hard granite of the ordinary kind. These soft granitic dykes in granite are not uncommon here, and are indicated on the surface by smooth road-like spaces between rough boulders of granite. Mica schist bands also occur in the granite and occasional veins of quartz. The alluvium is charged with magnetic iron sand. From Mount Victoria to within sixteen miles of the province boundary the country is granitic and metamorphic, the granite being in masses over a large area and in dykes traversing mica slate and clay slate. Near Boolcoomatta there are hornblendic and micaceous gneissic rocks, with coarse granite dykes and greenstone. A quartzose sandstone and felspathic rock has been excavated here and crushed for gold; it is stained with green and blue carbonate of copper. Eastward of this place vertical cleaved clay and mica slates strike N.E., associated with quartz and iron ore lodes, greenstone, and granitic dykes. Afterwards granite again appears and dips under extensive plains near Mingary Creek, which continue thence to the boundary of the province. Water has been found by sinking in all the formations met with on this route at comparatively shallow depths, from the sandstone and purple shale formation down to the granite and metamorphic rocks.

“A considerable portion of the country, as shown by sections Nos. 1 and 2, is underlaid by a limestone formation, which is always found to be favourable to the natural storage of water underground. A list of 17 stations is given with the principal wells met with on the route, and the formation in which each occur.”

It appears from Mr. Lyell Brown's report that “water is rather plentiful in the older rock formations, although it cannot be determined before sinking whether it will be brackish or fresh. The numerous beds of limestone which are interstratified with the other rocks are, as mentioned above, favourable to the storage of water in caves and hollows and underground streams. The occurrence of calcareous conglomerate and tufa on the surface of the older rocks, and in gullies and creeks traversing them, points to the eruption of water charged with lime at some not very remote period. The Flinders and other ranges lying to the south of the plain and sand-hill country act as a dam to prevent the subterranean water from reaching the sea; this gives rise to the natural artesian springs, such as Mulligan, Blanchwater, etc., etc. This area is coloured green on the map. The natural artesian wells show that in those localities water will rise to the surface when the water-bearing strata have been pierced. Whether it will do so all over the area above mentioned depends on the level of the land, the depth of the formation, the undulations of the bed rock, etc. It is, however, certain enough that water will be found in sufficient quantities by sinking to a moderate depth.”

#### EVOLUTION OF LIFE IN PALÆOZOIC TIMES.

##### II.—THE CONNECTION OF THE ANIMAL WORLD IN GEOLOGICAL TIMES.

By Prof. A. GAUDRY, Memb. Inst.

Les Enchainements du Monde Animal dans les Temps Géologiques Fossiles Primaires. Par Albert Gaudry, Memb. Inst., Professeur de Paléontologie au Muséum d'Histoire Naturelle. Royal 8vo. pp. 320, avec 285 gravures dans le texte. (Paris, F. Savy, 1883.)

WE have again to express our thanks to Professor Gaudry for another valuable text-book of Palæontology added to our Library. His former volume<sup>1</sup> dealt with the Evolution of the Tertiary Mammalia—in which branch of study he is the master *par excellence*. The present work deals with the fossils of the Primary Rocks, Chapter I. being devoted to a sketch of the progress of Palæontology, “in which,” says Prof. Gaudry, “we can distinguish two phases: first, one in which Naturalists recognize that there has been, before the coming of man on the earth, an immense lapse of time, during which many of the now existing forms of animals were already living; and a second, or that which has established chronological geology, that is to say, which has shown that the past ages were divided into a number of epochs characterized by special

<sup>1</sup> Les Enchainements du Monde Animal dans les Temps Géologiques. Mammifères Tertiaires. Par Prof. A. Gaudry. Royal 8vo. pp 296, avec 312 gravures dans le texte. (Paris, F. Savy, 1878). See GEOL. MAG. 1878, Dec. II. Vol. V. pp. 221-7.

species." He points out the various lines of ideas which prevailed amongst the earlier writers down to the period of Cuvier and D'Orbigny, when a series of stratified deposits had been recognized, but each with its fauna and flora was believed to be *quite distinct* and separate from the one before, or the one which followed after.

In Chapter II. he shows that the idea of their relationship to each other is quite compatible with the teachings of Geology; that the system of appearances and universal destructions, although not deficient in grandeur, has given place to more philosophical views; and that we are now aware that the hard lines of separation between the geological formations were only local phenomena; and that if life was interrupted at one point, it was continued at another.

The ten chapters which follow give us an account of the Primary formations and their fossils. Then the *Cœlenterata*, the *Echinodermata*, the *Brachiopoda*, the *Gasteropoda* and *Conchifera*, the *Cephalopoda*, the *Arthropoda*, the first Fishes and the first Reptiles, have each a chapter devoted to them, accompanied by numerous and excellent figures.

"There cannot," writes Prof. Gaudry, "be a doubt as to the former connexion between the life-forms of the Cambrian and Silurian, and between these and the Devonian and Carboniferous; and these and the Permian, and again between the Permian and those we call Secondary."

M. Briart has observed, "All the epochs are connected one with another, not by beings preserved in an exceptional manner, but by entire faunas, and floras." "The primary *Foraminifera* were singularly like the present ones; several of the genera have continued from Carboniferous times to the present day. Not only do they graduate from one into another, but we have difficulty in establishing lines of demarcation between the families, whether we take their texture or their mode of grouping as the basis of classification.

"The same thing occurs with the *Cœlenterata* as with the *Foraminifera*. Formerly they were arranged according to their mode of grouping, but it was soon apparent that this mode offered but poorly-marked distinctions.

"At the present day we class their families according to their intimate structure, and yet we see transitions between them. Still we find passages between the *Tubulata*, the *Tabulata* and the *Rugosa*, and to the well-septated *Madreporaria*. Nor is it easy to establish a marked separation between the ancient and recent *Hydrozoa*.

"Notwithstanding their apparent diversity, the greater part of the *Crinoidea* can be referred to one common type. The study of the Sea Urchins has not yet established any transition between the *Palæoechinidæ* and the *Neoechinidæ*; nevertheless it is possible to conceive that by the union and atrophy of one portion of their test, the transition may have been effected.

"The researches of Mr. Thos. Davidson, F.R.S., have shown us that the *Brachiopoda* pass from one species to another. It is not always easy to establish barriers between the genera of different families. The *Lingulæ*, *Crania*, *Discinæ*, *Terebratulæ*, and *Rhynchonellæ*.

*chonellæ* prove that Nature in those ancient days presented certain phases of resemblance with those of to-day.

The Mollusca of primary periods have also many types which unite them to our day.

The multitude of variations which M. Barrande has shown in the Cephalopoda, especially in *Orthoceras* and *Cyrtoceras*, proves, that the specific form is a somewhat indefinite, transient, and ephemeral character.

It may seem difficult to conceive how Cephalopods with a *calotte* (hood), said to be initial, have become Cephalopods with a spherical nucleus, or how they can have passed from one to the other. We must confess their transition has not yet been observed. But the characters of the siphon, of the septa, and of the curvature, and the aperture of their shells have shown transitions.

“As in the Mollusca, so the Trilobites have given a striking proof of the simplicity of the means by which nature produces the most diverse appearances. The differences arising from individual metamorphosis are actually greater than are their specific differences.

“However strange and remarkable may be the ancient *Merostomata*, the genera *Bellinurus* and *Prestwichia* have connected them with the *Limuli* of the present day.

“The *Ostracoda* and the *Insecta* of ancient days were, we may conclude, like those of the present epoch.

“Many fishes have afforded us characters which induce us to consider these fossil forms as the younger state of the class *Pisces*.

“Some of the ancient Reptiles, which had incompletely-ossified vertebræ and cartilaginous extremities to their limb-bones, are equally difficult to understand, except as representing the young state of the reptilian class.

“Thus the patient study of facts reveals connexions between the beings of past ages.”

“I have difficulty in believing,” wrote D’Omalius de’Halloy, at the end of his life, “that the Almighty Being, whom I consider the Author of Nature, should have at different epochs destroyed all living beings in order to enjoy the pleasure of re-creating new ones, which, on the same general plans, presented successive differences tending to culminate in the present living forms.” “This language seems to me to be that of common sense.”

“The examination of the primary fossils leads us to accept the conclusion that there exists a passage from species to species and from genus to genus, and from family to family” (and one might add, in all probability, from Class to Class!—EDIT.).

“But to keep within the exact truth, we must add that the present state of science scarcely allows us to go beyond this. It does not allow us to pierce the mystery of the primitive development of the great classes of the animal kingdom.”

“No man knows how the first individuals of the Foraminifera, of the Coelenterata, the Starfish, the Crinoids, the Echini, and the various other classes were formed which appear in the Primary rocks. In the Lower Cambrian of St. Davids we already see

Cœlenterata, Echinodermata, Mollusca, and Crustacea. In the Silurian there are Echini, Crinoids, Starfish, which appear to be as distinct from each other as these groups are at the present day.”

“I confess,” says Prof. Gaudry, “when I began to study the Reptiles of the Permian, which in certain respects present characters of inferiority, I expected to find relations between them and the fishes; but I found, on the contrary, that these early reptilia, by the full development of their fore and hind limbs, as well as by their thoracic and pelvic girdles, were as different as possible from the class of Fishes. These facts, which set forth clearly the separation of the principal classes of the animal world in very remote times, need not, I think, astonish zoologists. The more accomplished observers refuse to admit a single linear series, commencing at the Monad and continuing step by step, through the Polype, the Echinoderm, the Mollusc, the Worm, the Articulata, the Fish, the Reptile, the Bird, the Mammal, and ending at Man.

“Although the Mammalia are the most perfect of the Vertebrata, the study of their embryological development does not show that they have passed through the fish and the bird-stage. Palæontologists are in accord with embryologists, when they see that in geological times there has not been one single line of connexion, but many lines of relationships, the development of which has been pursued independently.

“In whatever manner we may suppose that evolution was produced, it seems most probable that it was marked by successive progress in the course of geological epochs. We are ignorant as to what occurred before the Cambrian epoch; but since then the history of living beings has been marked by progress. In Silurian times the animals have become more numerous and more varied than in the Cambrian epoch. The Cœlenterata, the Echinodermata and the Cephalopoda, here take an extension previously unknown. Beside the Trilobites are seen the Merostomata, and the end of the Silurian epoch even witnesses some fishes. But in all the earlier half of this immense epoch we have neither fishes nor Merostomata. The sovereigns of ocean were no other than the Trilobites and the Cephalopods.

“The animals met with in the primary formations are for the most part, and notably in the Silurian, seen to have been better organized for defence than for attack, as though in the earlier days of the globe, the animals being fewer, the means of preservation was more necessary.

“Thus certain Rugosa had opercula, the Cystideans were enclosed in calcareous tests, and even the greater part of the Crinoids, properly so-called, instead of having their viscera unprotected, like the Secondary forms, had them enclosed in a case which recalls the arrangement in the Cystidea: Brachiopoda could only slightly open their valves: *Maclurea* and several Pteropods had opercula.

“Amongst the Cephalopoda the aperture was often contracted.<sup>1</sup> I

<sup>1</sup> Many of the Ammonites were furnished with a shelly operculum (= *Aptychus*, *Trigonelites*, etc., homologous with the dorsal hood of *Nautilus*) closing the aperture of their body-chamber.—Édit. GEOL. MAG.

have already remarked that to judge from the analogy of existing forms the ancient Prosobranchiate Mollusca were not carnivorous. If, instead of being weakly, protected by a shell, or a carapace, hiding under sediments, there were in the beginning forms of life more powerful for attack than for defence, perhaps life would not have been developed on our planet, and there would have been a void, where life is now both abundant and varied.

“Silurian forms must have composed a silent world. No doubt they were not without beauty. I can quite believe (says Professor Gaudry) that Verneuil, Salter, Barrande, Hall, whose lives have been devoted to their study, must have greatly admired these ancient forms. Nevertheless, there is a great distance between the calm existence of the Silurian days and that more animated life which we contemplate in the more recent periods.

“The Devonian strata show a great progress in the organic world—since they correspond with the development of the Vertebrata. These vertebrates it is true are only fishes, and moreover many of these are strangely formed and very different from those of to-day.

“Carboniferous and Permian times have witnessed fresh progress. Together with the Trilobites and the Merostomata which have decreased, the higher Crustacea, such as Decapods, begin to appear. Insecta, Myriapoda, and Arachnida become numerous. Vertebrata are no longer only represented by Fishes. As in France, so in Germany, Russia, England, and America, Reptiles began to multiply. But with the exception of certain genera, towards the end of the Primary period they have neither the diversity nor development which we shall see in the Secondary period.

The remains of Birds and Mammals have not been found in Primary formations. The warm-blooded vertebrates are absent, or at least they must have been very rare. This shows great inferiority; for these warm-blooded animals were those whose functions are the most active: and activity is just the measure of the power of the animal.

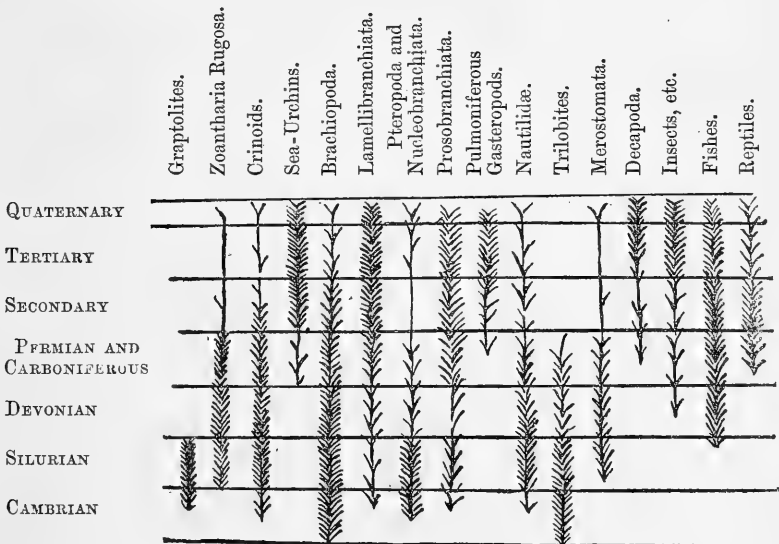
“Besides, from an æsthetic point of view, the Mammalia with their varied forms and the Birds with the riches of their plumage play the first role in Nature. Imagine our country without the song of birds or the cry of the Mammalia, we should find it very dull. The forests of primæval days could not compare with the shrubberies of the present time where birds give such lovely concerts. And then again, without wishing to assert under what form the intelligence of animals was first awakened, we may be permitted to suppose it was by means of the senses. For in man himself philosophers admit that sensation is the primordial faculty: it precedes reasoning. But sensation in the primary creatures must have been less developed than that of beings of later epochs. Those birds which hatch, and those mammalia which suckle, their young seem to love them more than do the other animals. In the times in which these did not exist, the strongest of all the affections, maternal love, must have been but little manifested.

“As we descend the course of geological life we shall notice

other progresses: we shall see in the Secondary epoch the reign of reptiles; in the Tertiary epoch the reign of birds and mammals; in the Quaternary epoch the reign of man. Thus taken in its entirety the history of the world shows progressive development. The evolutions proper to the Primary periods whilst admitting that, taken as a whole, the history of the world has presented the spectacle of progress, we must bear in mind that all classes have not developed in a continuous manner during geological times.

“We have seen that the Pteropoda, Cephalopoda, Ostracoda, Brachiopoda, Merostomata, and Insects, have attained in the Primary epoch a high degree of perfection, and a greater size than at the present period.

“One of the most curious results of palæontological study has been to show that each one of the epochs of the world has had its own special development. There have been forms which have been specially designed for it; with it has begun their reign, with it their reign came to an end. This will be seen on glancing at the subjoined table, wherein I have indicated the path which the development of one part of the primary animals has followed. I have represented each group by a branch which I have drawn more or less thickly clothed with leaves according as the development has been greater or less.



“We see in this table how ephemeral have been the Graptolites. I have already noticed that these forms, born in the Cambrian, do not extend beyond the Silurian rocks.

“Some of the Hydroid Cœlenterates of more recent epochs may have arisen from them, but then they have ceased to be Graptolites;

so that we must say that this form was confined to these older formations. The Rugosa have had their extension in Primary times. It is very likely that many roots have been the parent-stock of the Corals of the Secondary period; since they pass insensibly into these; but without doubt all of them have not been their ancestors. Some among the *Tabulata* of ancient formations such as *Heliolites* seem to have been the ancestors of the recent Alcyonarians: on the other hand, *Michelinia*, *Halysites*, and many others have been entirely confined to the Primary formations. Angelin's work on the Crinoids admirably shows the diversity of these animals in the Silurian epoch; surely such an abundance and variety of forms was not necessary for culminating in the present species whose existence the latest dredgings have revealed. The same must be said of the Primary Brachiopoda; certain of these have been continued changed or unchanged to our own times, but the immense majority of the genera of *Orthises*, *Producti*, and *Spirifers* has had no influence on the Brachiopoda of our seas. The Primary Pteropods and Nucleobranchiata may have been the ancestors of those which followed them; nevertheless they have been so changed, that there is no risk of confounding the ancient genera with the newer. With the exception of *Nautilus*, no form of the family *Nautilidæ*, which in former times had such extreme fecundity, is represented in our day. The Trilobites, the variations of which have shown such an astonishing plasticity in Cambrian and Silurian times, diminished during the Carboniferous period, and their last species has been found in the Permian.<sup>1</sup>

"The Merostomata are at the present day only represented by the genus *Limulus*. It is not for producing this isolated survivor of so many singular creatures that the groups Xyphosuridæ and Eurypteridæ were developed so largely in Palæozoic times.

"I believe that many of the ancient Fishes have been the prototypes of the present ones; but some amongst them, such as *Pterichthys*, *Cephalaspis*, *Coccosteus*, constitute a strange population confined to primary times; and Labyrinthodont reptiles characterized the end of the Primary and the beginning of the Secondary period. Those fossils which have been specially characteristic of certain periods in the history of our earth, render invaluable assistance to the geologist in the determination of the strata; they well deserve the name of "Medals of Creation" which Mantell gave them, for they indicate exactly geological epochs.

"*Inequality in Evolution*.—It arises from what has just been said that there have been great inequalities in the development of beings in ancient times. These inequalities do not confirm the idea of a struggle for life in which victory would be to the most highly gifted. Palæontology shows us that the contrary may have been the case.

"Many organisms may have been like transitory dynasties, they have become salient individualities, which have given to their epoch a marked physiognomy; even as we speak of the age of Charle-

<sup>1</sup> This supposed Permian Trilobite is erroneous. No Trilobite occurs higher in the series than the Carboniferous formation.—Edit. GEOL. MAG.



magne and the age of Louis Quatorze, so may we speak of the age of *Paradoxides*, the age of *Slimonia*, the age of *Pterichthys*, the age of *Coccosteus*, of *Megalichthys*, of *Euchirosaurus*.

“Frequently, those organisms which have been the most specialized and most perfect of their genus have the soonest died out. *Paradoxides*, *Slimonia*, *Pterichthys*, have marked the culminating point of divergence which their type was to attain. They could therefore no longer produce new forms; and as the normal characteristic of creatures is either to change or die,—they died. Alongside these transition forms, offering these eccentric variations, there have been others, whose individuality has been less pronounced, being of intermediate position, representing in the animal kingdom the *juste milieu*. Amongst these we find the types which have been more persistent, just as in our day we find cosmopolitan forms, which are found in all parts of the world, so there have been forms which one might call *panchronic*, for they have been of all epochs.

“They have constituted a sort of permanent reservoir from which have arisen at every moment in geological time beings destined to take a more or less high position.

“It might perhaps be possible that the shorter lives of those genera, which in their own classes show the highest perfection, may have sometimes had its cause in this same perfection. The greater the complexity of an organism, the less chance is there of the modification of one of its parts; consequently, it must suffer more from changes in its surrounding circumstances, and must make a more delicate subdivision in the changes which mark geological time. The power of longevity resides partly in their plasticity; they recall the fable of the oak and the reed. Like the reed, these weakly creatures have bowed before the storms of time, and have thus been preserved, whilst the giants of the organic world fell. We must, moreover, confess that we can but very imperfectly explain this inequality of the evolution of animals; for we see in one and the same class, and at the same epoch, beings which are at different stages of development; for example, I have already mentioned that in the Permian formation of Igornay we find together *Actinodon*, of which the vertebræ still retain their centra unossified (notochordal), and *Stereorachis*, in which the centra are fully ossified.

“Brachiopoda offer us singular inequalities in the persistence of genera. The *Lingulæ*, the *Cranidæ*, and the *Rhynchonellæ* have continued throughout all subsequent geological times without any notable change; whilst *Pentamerus*, and *Producta*, and many other genera have not survived the Primary epoch.

“We find together with types absolutely special to Primary times, types closely related to our *Nautili* and *Limuli* which have had the singular destiny of being spectators of all the changes of the organic world from the days of the Trilobites to our own times.

“The difficulty which we find in understanding the causes of the evolution of ancient organisms is no reason for denying this evolution; for the embryogenical metamorphisms which we witness every day are in no wise less unequal than the palæontological ones.

*Coleoptera* change but little, but the *Lepidoptera* pass through great metamorphoses. Frogs and Toads commence life as tadpoles; whereas Salamanders differ but little at birth from their parents. Many marine Gasteropoda (Prosobranchiata) undergo considerable modifications, whereas young snails are snails from their first appearance. If all the creatures had changed equally quickly in geological time, those which have been transmitted through all the past ages would all have been elevated beings at the present day. There would thus have been more of the higher than of the inferior animals; more of the eaters than of the animals to be eaten. The harmony of the organic world would long ago have been broken. Moreover, the inequality in evolution is one of the causes of the variety of aspects presented in the history of the world.

“At all epochs, except no doubt just at the beginning, there have been organisms in the first stages of their evolution, others in the second, others in a third, and others in more elevated stages. It is in part from these inequalities that the marvellous beauty of nature in all geological periods has arisen.”

We have given this very full *résumé* of Prof. Gaudry's views in order to show that even amongst the strongest adherents of special creation the doctrine of Evolution has made its way, and for the obvious reason, that unlike the doctrines of Lamarck, which appealed to the imagination, the Darwinian theory appeals to one's personal observations, and every naturalist may test it and apply it to his own special research. Not that the doctrine of Evolution is perfect and complete—no one knew better than Darwin himself how many tough problems remained still awaiting solution; but it is because it helps us to understand and to piece together a larger proportion of the puzzle of Life on the Earth than any other theory yet propounded, that geologists and naturalists of all shades of thought have adopted it, some at once—like Sir Charles Lyell—others, like Prof. Gaudry, more slowly, but none the less surely, because they have carefully tested it by actual application to their own researches.

PROF. HÉBERT'S INTRODUCTION TO GEOLOGY.

III.—PROF. E. HÉBERT'S "NOTIONS GÉNÉRALES DE GÉOLOGIE." 18mo. pp. 114, and 54 Woodcuts. [Paris: G. Masson, 1884 (really Nov. 1883).]

THIS little book is a remarkable one in many respects. It has the appearance of a primer; yet it is not a primer in any sense of the word. It is to a certain extent an introduction to the Science of Geology, and yet it assumes in its readers a respectable amount of preliminary knowledge. Again, though confessedly an introduction, the work is complete in itself. Perhaps the following extracts from the author's preface will best explain his object:—

“This small methodic treatise can thus serve as an introduction to thorough and detailed studies, or it may supply sufficient instruction to those who, otherwise employed, are yet curious to be initiated into this branch of human knowledge.” . . . “It is principally to pupils in rhetoric and philosophy [*i.e.* the highest forms of the

French *Lycées*] that it is addressed; for elementary though these “*Notions générales*” be, a trained judgment is yet required in order to understand them properly. The practical acquaintance with the nature of rocks, with the natural phenomena of the present day, etc., acquired by these young men in the lower forms, would thus in the higher classes receive a complement of the highest interest, and such as to awaken in these young intellects wide horizons of thought.”

The book, in fact, is a brief and clear exposition of the great truths of geology, in which all details are omitted except such as have been with great judgment selected to illustrate each step of the well-reasoned whole. These illustrations are naturally taken, when possible, from French geology; but with some slight alterations, in this particular only, the work might with advantage be translated into English. There are in this country many well-educated persons who are above the standard of our many primers, who do not care to wade through the dreary technicalities of the larger text-books, and to whom the style of so-called “popular” books is anything but attractive. Many readers of this class would welcome a short account of the aims and methods of modern geology, of its proved facts and probabilities, written by the hand of a master. Professor Hébert’s scholarly and most readable essay would, in our opinion, exactly meet this case.

G. A. L.

---

## REPORTS AND PROCEEDINGS.

---

### GEOLOGICAL SOCIETY OF LONDON.

I.—November 21, 1883.—J. W. Hulke, Esq., F.R.S., President, in the Chair.—The following communications were read:—

1. “On the Skull and Dentition of a Triassic Mammal (*Tritylodon longævus*, Ow.) from South Africa.” By Prof. Owen, C.B., F.R.S.

The specimen described in this paper formed part of a collection containing remains of some of the known South-African Triassic Reptilian genera, and agreed with them in its mode of fossilization. It was submitted to the author by Dr. Exton, of Bloemfontein. The specimen is a nearly entire skull, wanting only the hinder part, and it measures about  $3\frac{3}{4}$  inches in length, from the broken end of the parietal crest to the point of the united premaxillaries. The upper surface shows the anchylosed calvarial portions of the parietals, and the frontal bones divided by a suture; the contiguous angles of these four bones are cut off, so as to leave an aperture, occupied by matrix, which may be a fontanelle, or a pineal or parietal foramen. The frontals form the upper borders of the orbits, which are bounded in front by the lacrymal and malar bones, and were not completed behind by bone. Each frontal is narrowed to a point at the suture between the nasal and maxillary. The nasals are narrow, but widen in front to form the upper border of the exterior nostril, which is terminal, and is completed by the premaxillaries. The maxillaries are widened posteriorly, then constricted, and again widened before their junction with the intermaxillaries.

The teeth include a pair of large round incisors, broken off close to the sockets, and showing a large pulp-cavity, surrounded by a complete ring of dentine, which is covered by a thin coat of enamel on the front and sides. At 2 millim. behind each of these teeth is the socket of a smaller premaxillary tooth; this tooth apparently had a thin wall and a pulp-cavity relatively larger than in the anterior tooth. It is separated by a ridged diastema from the series of six molar teeth on each side, the first of which has a sub-triangular crown with the base applied to the second tooth. The latter and four following teeth are nearly similar, subquadrate in form, with the crowns "impressed by a pair of antero-posterior grooves, dividing the grinding-surface into three similarly disposed ridges, and each ridge is subdivided by cross notches into tubercles. Of these there are, in the second to the fourth molar inclusive, four tubercles on the mid ridge, three on the inner ridge, and two on the outer ridge."

The author discussed the relations of this new form of mammal, especially as indicated by the structure of the teeth, which he showed to resemble those of *Microlestes*, from the Keuper of Würtemberg and the Rhætic of Somersetshire, and those of the Oolitic genus *Stereognathus*, the former having on each tooth two multituberculate ridges, and the latter three ridges, but with only two tubercles on each. The fossil presents no characters to show definitely whether the animal it represents was a placental or non-placental mammal.

2. "Cranial and Vertebral Characters of the Crocodilian Genus *Plesiosuchus*, Owen." By Prof. R. Owen, C.B., F.R.S., F.G.S.

In this paper the author, with the view of showing that the Kimmeridgian *Steneosaurus Manselii*, Hulke, really forms the type of a distinct genus, discussed the characters by which Cuvier divided the fossils referred by him to the Crocodiles into three principal groups, to which Geoffroy St.-Hilaire gave generic names, and those by which the latter author afterwards distinguished his genus *Steneosaurus*, including Oolitic forms, from the Liassic genus *Teleosaurus*. From his exposition of these characters the author concluded that the above-named species does not belong to *Steneosaurus*, Geoff., and he proposed to make it the type of a new genus, *Plesiosuchus*, characterized by the convergence of the frontal bones to a point nearer the apex of the skull than in *Steneosaurus*, by the extension of the gradually attenuated nasal bones into a point penetrating the hind border of the nostril, and by other peculiarities of the skull, teeth, and vertebræ. The author pointed out that this form, like *Steneosaurus*, helped to bridge over the space between the Liassic Teleosaurs and the Tertiary and recent Crocodiles, even approaching nearer to the latter than the older Oolitic type.

3. "On some Tracks of Terrestrial and Freshwater Animals." By Prof. T. McKenny Hughes, M.A., F.R.S.

The author's observations have been made on certain pits in the district about Cambridge which are filled with the fine mud produced in washing out the phosphatic nodules from the "Cambridge Greensand"—a seam at the base of the Chalk Marl. As the water

gradually dries up, a surface of extremely fine calcareous mud is exposed. This deposit is often very finely laminated, and occasionally among the laminæ old surfaces can be discovered, which, after having been exposed for some time to the air, had been covered up by a fresh inflow of watery mud into the pit. The author described the character of the cracks made in the process of drying, and the results produced when these were filled up. He also described the tracks made by various insects, indicating how these were modified by the degrees of softness of the mud, and pointed out the differences in the tracks produced by insects with legs and elytra, and by Annelids, such as earthworms. The marks made by various worms and larvæ which burrow in the mud were also described. Marks resembling those called *Nereites* and *Myrianites* are produced by a variety of animals. The groups of ice-spicules which are formed during a frosty night also leave their impress on the mud. The author concluded by expressing the opinion that *Cruziana*, *Nereites*, *Crossopodia*, and *Palæochorda* were mere tracks, not marine vegetation, as has been suggested in the case of the first, or, in the second, the impression of the actual body of ciliated worms.

II.—December 5, 1883.—J. W. Hulke, Esq., F.R.S., President, in the Chair.—The following communications were read:—

1. "On the Cambrian Conglomerates resting upon and in the vicinity of some Pre-Cambrian Rocks (the so-called intrusive masses) in Anglesey and Caernarvonshire." By Henry Hicks, M.D., F.G.S.

The author stated that as he and others who had asserted that some of the great rock-masses marked as "intrusive" on the maps of the Geological Survey in Anglesey and Caernarvonshire were really of Pre-Cambrian age, had been charged in the last edition of the Geological Survey Memoir on North Wales with having done so on purely theoretical grounds, he had found it necessary to obtain the additional evidence which he now brought before the Society. He felt this to be the more incumbent upon him as the present Director-General had recently stated that his predecessor would not admit the existence of any Pre-Cambrian rocks in the Principality, and had further asserted that the author, "with the most complete disregard of the evidence by which the officers of the Survey were led to regard certain rocks as intrusive" in Cambrian and Silurian strata, had simply made these rocks into metamorphic and volcanic Pre-Cambrian masses, without giving any detailed statement of the evidence in support of so great a change. The author said that he was prepared to bring forward conclusive evidence of the correctness of his views from all the areas referred to, and he offered the present paper as a first instalment of the detailed criticism demanded by the Director-General.

In a former paper he had maintained that there was no evidence to show that the so-called intrusive granite in Anglesey had altered the Cambrian and Silurian rocks in its immediate vicinity, or that they had been entangled in it as described, but that it seemed to be a rock of metamorphic origin, varying much in its general appearance

at different points. He contended that, instead of being an intrusive granite, as supposed by the officers of the Survey, it was in all probability the oldest rock in Anglesey. The basal Cambrian conglomerate in contact with it is in an unaltered condition, and at Llanfaelog contains an extraordinary proportion of well-rolled pebbles, identical in mineral composition with the so-called granite immediately below. Fragments of all the varieties of rock found in the granitoid axis are recognizable in the conglomerate, and in precisely the same condition as in the parent rock. Fragments of the various schists of the area were also present; so that he thought there cannot be the shadow of a doubt that the so-called granite and the metamorphic schists are older than the conglomerate, and therefore Pre-Cambrian. The view maintained by the Survey that the schists are altered Cambrian and Silurian strata, and the granitoid rock an intrusive granite of Lower Silurian age, is consequently quite untenable.

In Caernarvonshire equally conclusive evidence was obtained from many areas. Fragments of the Dimetian (Twt-Hill type) occurred abundantly in the basal Cambrian Conglomerates at Dinas Dinorwig, Pont Rothei, Moel Tryfaen, and Glyn Lifon. Quartz-felsite pebbles in every respect identical with the varieties found in the so-called intrusive ridges between Bangor and Caernarvon, and to the north and south of Llyn Padarn, were found on the shores of the Menai Straits, in the railway-cutting at Bangor, at Llandeiniolen, Dinas Dinorwig, Llyn Padarn, and elsewhere. This evidence, supplementary to that previously furnished by Prof. Hughes, Prof. Bonney, and the author, is conclusive as to these areas, since the basal Cambrian conglomerates, which are in contact with these supposed intrusive masses, are composed almost entirely of rocks identical with the latter; and this could not possibly be the case if the granitoid masses had been intruded among the conglomerates after their deposition.

2. "On some Rock-specimens collected by Dr. Hicks in Anglesey and N.W. Caernarvonshire." By Prof. T. G. Bonney, D.Sc., F.R.S.

The author stated that pebbles in the blocks of conglomerate collected by Dr. Hicks to the north of Llanfaelog were practically undistinguishable macroscopically and microscopically from the granitoid and gneissic rocks which occur *in situ* between that place and Ty Croes, and that the matrix contained smaller fragments, probably from the same rock, with schist bearing a general resemblance to members of the group of schists so largely developed in Anglesey, and with grits, argillites, etc. Pebbles of granitoid aspect in the Cambrian conglomerate near Dinas Dinorwig, etc., bear a very close resemblance to the Twt-Hill rock, and are associated with abundant rolled fragments of rhyolite resembling those already described from the Cambrian conglomerate and the underlying conglomeratic beds and rhyolites. Two pebbles of rather granitoid aspect in the Cambrian conglomerate by the shore of the Menai Straits, near Garth, prove to be spherulitic felsite, somewhat resembling that already described by the author from Tan-y-maes. He pointed out that the evidence of these specimens collected by

Dr. Hicks, added to that already obtained, led irresistibly to one of two conclusions;—either that, when the Cambrian was formed, an area of very ancient metamorphic rock was exposed near Ty Croes and in the Caernarvonshire district, or that the rhyolitic volcanoes were so much older than the Cambrian time that their granitic cores were already laid bare by denudation. Hence, in either case, the existence of Archæan rock in North Wales was proved. To one or other of these conclusions he could see no possible alternative, and he considered the former to be (even if some of the granitoid rock were granite) far the most probable.

3. “On some Post-glacial Ravines in the Chalk-Wolds of Lincolnshire.” By A. J. Jukes-Browne, Esq., F.G.S.

In a former paper the author stated that of the valleys intersecting the Chalk Wolds some were older and some were newer than the formation of the Boulder-clays (Hessle and Purple Clays). He now described some cases where the modern watercourse, after flowing for some distance along the line of an ancient (pre-Boulder-clay) valley, suddenly deserts that valley and passes through a ravine excavated entirely out of the Chalk.

These ravines are very different from the other parts of the valley traversed by the same stream, being deep and narrow cuts or trenches with steep wooded sides, and exhibiting more the scenery of Derbyshire vales than of ordinary Chalk valleys.

In accounting for the origin of these ravines, the author pointed out that the whole district in which they occur must once have been completely covered by the Boulder-clays; and he supposes that at certain points where the ancient valleys were blocked with high mounds of Drift, the streams found it easier to cut new channels through the flanking ridge of Chalk than through the obstacles in front of them.

---

## CORRESPONDENCE.

---

### THE PERMIAN-TRIAS QUESTION.

SIR,—As the Permian-Trias question was brought forward rather prominently (thanks to your courtesy) in the pages of this Journal during last year, perhaps you will further allow me to make a remark or two with reference to the paper bearing upon the subject which I had the honour of reading this year before Section C. of the British Association. The evidence which I was able to bring forward (from recent work in Germany) as to the existence of local discordance and unconformity on a large scale between the Dyas and Trias was admitted even by Prof. Hull to have fully established that position. This, however, which was the main point, was not noticed in any report of the discussion which I have seen in the newspapers. It follows of course that wherever in my papers of last year (following Murchison) I have spoken of a conformable sequence between the Dyas and Trias of Central Europe, all that must be considered now as unsaid.

The retention of the name “Permian” after it has admittedly

ceased to connote what the author of the term intended by it, is quite a minor question; and I was so completely satisfied with Professor Hull's surrender of the *argumentum ad rem* that I did not care to lay myself open to the charge of prolonging the discussion upon a collateral issue. In appealing to the English sentiment of an audience composed mostly of people who could scarcely be expected to be familiar with the question in all its ramifications, it was of course not difficult to obtain an expression of opinion in favour of the retention of the name Permian on that ground. But when we come to consider the rival claims of *connotative* and *geographical* names of groups of strata, a question of principle, rather than one of opinion, is raised. For individual *formations* (*pace* the International Commission) geographical terms are probably upon the whole preferable, except in certain cases (*e.g.* 'Bunter,' 'Keuper'), in which the general uniformity of character of a formation over a very large area renders the difficulty of naming it from any locality very great. In the main, however, the instincts of English geologists, which have led them to give geographical names for the most part to single formations, have led them at the same time to show a preference for connotative names for the larger groups of strata. Thus, taking any authoritative table of the British series, such as that in the excellent Geological Chart of Prof. Morris, the preponderance is nearly three to one in favour of connotative names for the more comprehensive groups, as the following lists show:—

<i>Connotative Names.</i>	<i>Geographical Names.</i>
Recent.	_____
Pleistocene: Quaternary.	_____
Pliocene.	_____
Miocene.	_____
Eocene: Oligocene.	_____
Cretaceous.	_____
Oolitic.	Jurassic.
Lias.	_____
Trias: New Red Sandstone.	_____
Dyas: Magnesian Limestone.	Permian.
Carboniferous.	Devonian.
	Silurian.
Old Red Sandstone.	Cambrian.
Archæan.	Laurentian.

The argument then in favour of the retention of the name 'Permian' (as against, *e.g.* that of 'Dyas') is based on no logical consistency with established geological nomenclature. It is an excellent local name for the Russian series, but as a general term for the European series it is highly misleading. A. IRVING.

WELLINGTON COLLEGE.

#### ORIGIN OF CONTINENTS.

SIR,—My article under the above title, in the June Number of the GEOLOGICAL MAGAZINE, is criticized by Prof. Le Conte, in the November Number, in a way that implies some misconception of my position. My arguments were directed chiefly against Prof. Dana's theory, and only incidentally against that held by Prof. Le Conte,



only, as I expressly stated, in so far as it coincides with Prof. Dana's theory. Granting the probable validity of Prof. Le Conte's first objection, that the coefficient of contraction is probably not the same in parts of the earth differing in composition, it simply shows that his theory is not so different from Prof. Dana's as I had supposed; although he still locates the Continents where Prof. Dana locates the ocean-floors, and demands a globe continuously rigid from centre to circumference, which Professor Dana does not.

Prof. Le Conte says that, unless we assume that the earth is preternaturally homogeneous, the very slight deformation exhibited by its surface would result from cooling. This appears to be a sufficient answer to my argument, so far as it applies to Prof. Le Conte's own theory, since he says the inequalities of the surface are due to unequal contraction of the radii through their entire length. But Prof. Le Conte's criticism does not meet my argument in its application to Prof. Dana's theory; for Prof. Dana says the oceanic hollows are due to the unequal contraction, not of 4000 miles of earth-matter, but of only about forty miles. His theory supposes that the earth has a thin solid crust, separated by a mobile layer from an immense solid nucleus, and that the inequalities of the surface are due to unequal contraction of this thin external crust alone. Hence Prof. Le Conte's illustration should be modified. Instead of taking a ball of molten iron or rock as a model of the whole earth, suppose a layer of molten iron or rock to represent the earth's crust. Let this layer be forty inches thick; then Prof. Dana says that when the whole is solid the layer will be three inches thicker in some parts than in others, in consequence of unequal contraction. Now I claim that this unequal conductivity and contraction, amounting to about eight per cent., requires, in the case of the earth, an unproved and improbable difference in composition.

If Prof. Le Conte will consult the last published expression of Prof. Dana's views (*Amer. Journ. of Science*, 3, vi. p. 168), he will find that Prof. Dana does hold that the steep slopes of the oceanic depressions are due to the supposed original difference in composition and conductivity of the continental and oceanic areas. I have not ascribed this view to Prof. Le Conte, but he seems to have both misread and misquoted me here.

Finally, although I have taken account only of the contraction due to solidification, yet I think this is fair, because I have made the extremely favourable supposition for Prof. Dana's theory that the oceanic areas remained liquid until the continents became entirely solid.

BOSTON SOCIETY OF NATURAL HISTORY,  
BOSTON, U.S.A.

W. O. CROSBY.

---

#### THE MAMMOTH IN THE FOREST-BED.

SIR,—By a singular coincidence, the day after I received a copy of my paper on the occurrence of the Mammoth in the Forest-bed, a heavy storm laid bare that bed at Overstrand and Sidstrand. I took the first opportunity to go to Cromer, and Mr. Alfred Savin

placed in my hands an upper tooth, which I unquestionably pronounced to bear a stronger resemblance to the *E. primigenius*, than any I had before met with, and I went with him to the spot whence the person, who sold it to Mr. Savin, took it. It was the upper part of the Forest-bed series, and the matrix upon the tooth corresponded with it.

It was a fine specimen with about 18 plates; although it was undoubtedly of *E. primigenius* form, still the width of the plates reminded me of the pre-existent Leptodon type from which it appears to be derived.

Yesterday Mr. Savin favoured me with several photos of the small teeth; some of which are from the same parts of the Forest-bed, others from a lower part. All these Mr. Savin had been advised to label *E. primigenius*. They are remarkably crimped. Mr. Fitch has kindly given me an opportunity to compare them with some specimens in his splendid collection obtained from the railway cutting at Ipswich. These are also milk teeth, but no less remarkable for the entire absence of crimping.

Surely these, although labelled and considered to be teeth of the Mammoth, must be of a remote and intermediate type. What I contend for is the existence of such intermediate links between the forms recognized by Dr. Falconer as decided species.

I am not surprised to find them pass from one into the other, as exemplified by the recent discovery of this fine molar, which I take the first occasion to announce through your valuable Journal.

JOHN GUNN.

---

#### THE PIKRITE BOULDERS IN ANGLESEA.

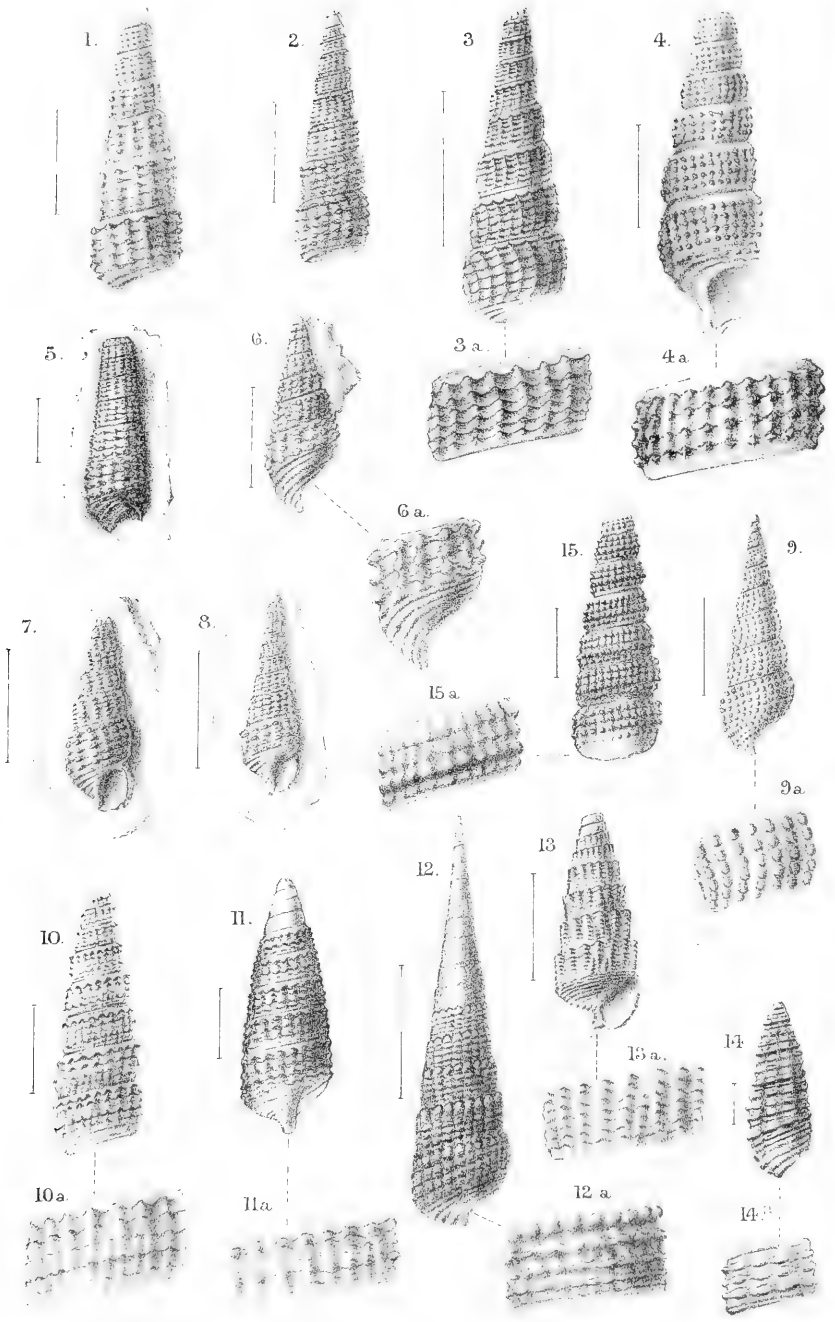
SIR,—I am sorry the famous boulder of this mineral has recently disappeared from its place at Pen-y-carnisiog in Anglesea. The natives tell me it has all gone to London. I have known this fine sparkling boulder for several years, and never passed the spot without bounding over the wall to give it a friendly tap with my hammer, or have a smoke leaning against its polished sides; but my knowledge never got further than to call it a strong hornblendic “tumbler,” *i.e.* Cymraeg for an “erratic”—of which there are other examples yet unremoved.

For the last ten years my holidays have been spent at a small place on the S.W. coast of Anglesea. The time has been pleasantly utilized with the aid of my wife in exploring and dredging for molluscs (of which we have over 200 good species), and in mapping down the geology of a broken coast, of which I have nearly measured every yard of 12 miles of the rocks. The complete section and map is full of details, an explanation of which is almost completed; but the point which will have most interest to some will lie in the fact that the Map will show more than one locality where the mineral Pikrite is bedded *in situ*.

ROYAL MUSEUM, PEEL PARK,  
MANCHESTER.

CAPT. JOHN PLANT, F.G.S.





A. S. Foord, del.

Mitern Bros. imp.

Oxfordian & Lower Oolite Gasteropoda (Yorkshire.)

THE  
GEOLOGICAL MAGAZINE.

NEW SERIES. DECADE III. VOL. I.

No. II.—FEBRUARY, 1884.

ORIGINAL ARTICLES.

I.—CONTRIBUTIONS TO THE PALÆONTOLOGY OF THE YORKSHIRE  
OOLITES.

By WILFRID H. HUDLESTON, M.A., F.G.S.

(Continued from Dec. II. Vol. IX. p. 251.)

(PLATE III.)

No. 2. *Gasteropoda of the Oxfordian and Lower Oolites.*

21.—“PHASIANELLA” STRIATA, Sowerby, 1814.

1814. *Melania striata*, Sowerby, Min. Conch. p. 101, pl. 47.

1850. *Phasianella striata*, Sowerby, Morr. and Lyc. Gt. Ool. Moll. p. 118, pl. xv.  
fig. 19.

? 1858. *Phasianella Sæmanni*, Opper, Juraformation, pp. 387.

1869. *Bourquetia striata*, Sowerby, Terq. and Jourdy, Bath. Mos. p. 51, pl. ii.  
figs. 21, 22, 23.

THE subject of the identity of the great shell (or rather cast), which occurs in the Scarborough Limestone, with the Corallian *P. striata*, was partly discussed in the “Corallian Gasteropoda.”<sup>1</sup> The considerable abundance of this form on certain horizons in the Oolites, both of the north and south of England, and its complete absence from other horizons, has attracted considerable attention. Thus it appears alike in the *Humphresianus*-zone of Scarborough and of Cheltenham, but not, as far as I know, in lower beds. The Yorkshire specimens are not good enough to warrant any conclusions as to the specific difference between this and the Corallian forms; therefore it seems safer to follow the authors of the Great Oolite Mollusca in referring the White Nab fossils to Sowerby’s species. Moreover, I have less doubt as to the propriety of this course after reading the very interesting remarks of MM. Terquem and Jourdy with reference to *Bourquetia striata*.

These authors, perceiving, like M. Deshayes, the objections to placing Sowerby’s species under any of the numerous genera to which it has been referred, adopted Deshayes’ MS. name, and give their reasons in the work above quoted for making a separate genus. On the whole, they were disposed to regard the new genus as being more nearly allied to *Natica* than to *Melania*, or *Chemnitzia*. They make no mention of Opper as having distinguished the Corallian from the Inferior Oolite form, but observe that *M. striata*, which is

<sup>1</sup> p. 23 of separate memoir.

found with identical *external* characters on many horizons from the Bajocian to the Corallian, might well belong to different genera according to the horizon which contains it, if the *internal* characters could be known. In default of such evidence, they appear disinclined to make even a specific distinction. The form is stated to be abundant in the "calcaire à polyypiers" of the Moselle (Upper Bajocian), but rare in the Lower Bathonian of that district.

<sup>1</sup> PHASIANELLA LATIUSCULA, Morris and Lycett, 1850.

#### GENUS CERITHIUM.

The species referred to *Cerithium* will be many, or few, according to the view taken as to the arrangement and classification of a group of shells, which are fairly abundant in the Dogger Sands and extend somewhat sparingly, and with considerable modification, throughout most of the succeeding fossiliferous horizons, to re-appear in great abundance in the Coralline Oolite. The representative form of the group is *C. muricatum*, Sowerby, which, like all "species" with an extended range in time and space—in fact, like all common species—has had numerous offshoots diverging from the main line, in which more or less difference of ornament may be noted.

The second group comprises a smaller and more finely ornamented set of shells, where the sculpture is pretty regular, but where the proportions of the spire vary materially. *Cerithium Beanii*, Morris and Lycett, will cover most of these forms, which in Yorkshire are confined to the Dogger and Sands, as far as I know.

Besides these two groups are a few rare forms of extremely dissimilar character which must find at least a temporary resting-place under *Cerithium*; though the companionship of such shells as *C. Comptonense*, which most probably should be classed under Lycett's subgenus *Kilvertia*, with such a shell as *C. caninum*, seems strange indeed.

<sup>1</sup> 1850. *Phasianella latiuscula*, Morr. and Lyc. Gt. Ool. Moll. p. 117, pl. xv. fig. 16.

These authors describe and figure a fossil cast, stated to occur "near Scarborough," under the above designation. Their figure is very familiar to Jurassic palæontologists, and has a certain resemblance to the *soi-disant Phasianellas*, of which several species occur in the Bathonian Beds of the West Midland district. In the Leckenby Collection there are no specimens which could fairly be referred to Morris and Lycett's species, except such as have a strong resemblance to *Natica Bajocensis* (*N. punctura*, Bean, Inf. Oolite variety). The specimen in the York Museum referred to, "*P. latiuscula*" is exactly like Morris and Lycett's figure; being a very perfect internal cast of a Naticoid shell in the grey matrix of the Scarborough Limestone, and having considerable resemblance to the shell of *P. elegans*, a species of the Great Oolite of the West Midlands. But it is certainly misleading to institute a comparison between the external form of one shell and the internal mould of another, even in the case of unornamented species.

The ratio between the body-whorl and the whole spire in the cast known as "*P. latiuscula*," is as 50 : 100; in average forms of the shell of *Natica Bajocensis* this ratio may be taken as 60 : 100. Making due allowance for the difference which is certain to exist between the external proportions of a shell and those of its internal moulds, it is by no means impossible that "*P. latiuscula*" represents the cast of *Natica Bajocensis*.

As it may be necessary to publish a supplemental plate at the end of this Memoir, I shall be very glad if any proof can be adduced in the mean time of the occurrence of such a species as "*P. latiuscula*," as a distinct shell.

The Dogger Sands and the Dogger are the most prolific in forms, and also in individual specimens, the *muricatum*-group, as we shall see, being fairly well represented and of considerable variety, more especially in the Dogger Sands,<sup>1</sup> where, if we may judge from numerous specimens in the Leckenby Collection, there has been considerable tendency to change.

22 and 23.—*CERITHIUM MURICATUM* group, Sowerby, 1825. Pl. III. Figs. 1—8.

1825. *Turritella muricata*, Sow., Min. Conch., vol. v. p. 159, pl. 499, figs. 1 and 2.

1829. " " " " Phillips, G. Y. 1st edition, p. 164.

1831. *Cerithium echinatum*, Von Buch, Jura in Deutschland, p. 56.

1836. *Cerithium quadrilineatum*, Röm. (pars), Ool. Geb. p. 154, pl. 11, fig. 14.

1844. *Cerithium granulato-costatum* and *muricato-costatum*, Münst. (pars), Goldf. pl. 173, figs. 10 and 12.

1875. *Cerithium muricatum*, Sow.; Phillips, G. Y. 3rd edition, p. 258.

*Bibliography, etc.*—As previously intimated, *C. muricatum*, Sow., is to be regarded as a group, rather than as a species in an ordinary sense—a group in fact out of which perhaps more than half the species of *Cerithia* that figure in the lists from the Lower and part of the Middle Oolites has been carved. In dealing with the shells which are classed under this heading the palæontologist's dilemma presents itself with unusual force. Are all the forms which exhibit some slight divergence of ornament or proportions to enjoy full specific distinction? This primary difficulty is further complicated by others, of which the difference in appearance, due to diversity of mineralization throughout the seven zones, is very grievous, and one that especially affects all highly sculptured forms.

In this case, however, there is a further and special difficulty—no less, in fact, than the crucial question, what is the type? Sowerby appears to have had no doubt that the Steeple Ashton fossil was identical with that from the Dogger of the Peak (Blue Wyke), and Phillips, in the earlier editions of the Geology of the Yorkshire Coast, evidently took the same view, since he quotes *Turritella muricata* as occurring in the Coralline Oolite, Lower Calcareous Grit, Kelloway Rock, and Dogger. In the last edition (1875) Phillips quotes *Cerithium muricatum* from the Coralline Oolite, Lower Calcareous Grit, and Cornbrash only. Its occurrence in the Dogger is not alluded to in any way, nor is there any alternative name given

<sup>1</sup> It should be borne in mind that the *Dogger Sands* are classed as part of the Upper Lias by some authorities, though not by Tate and Blake, who enumerate eight species of *Cerithium* from the entire formation, not including these Sands. Again, the division between the Dogger and the Dogger Sands at Blue Wyke may be drawn somewhat differently. This subject has been discussed by me at some length in the first part of the "Yorkshire Oolites" (Proc. Geol. Assoc. vol. iii.), where it was pointed out that, besides the *Nerinaea*-bed which yields the bulk of the specimens classed as "from the Dogger," there are three fossiliferous beds below this which form a part of the Dogger proper. The irony condition of the *Nerinaea*-bed and its shells is generally a pretty safe test as to a specimen coming from the Dogger, but this is not in all cases to be relied upon as regards the lower fossiliferous zones, which yet form part of the Dogger and not of the Dogger Sands. Hence there is a possibility in some cases that fossils believed, on account of their matrix and mineral condition, to have come from the Sands, may in reality have been obtained from the lower fossiliferous beds of the Dogger proper.

with which a group of shells not altogether uncommon in the Dogger and the Dogger Sands could in any way be identified. The third edition ignores the existence of this group in the Dogger entirely, and the question as to how far the common *Cerithium* of the Coralline Oolite is identical with certain forms in the Dogger is thus quietly shelved.

No one doubts the practical identity of the Steeple Ashton fossil with the ordinary forms of *C. muricatum*, so abundant in the Coralline Oolite at Pickering: yet it is not easy to indicate how these differ from the Dogger types; even the varieties being pretty much the same. The Coralline Oolite specimens from Pickering have rather a wider spiral angle. It is true that in the Dogger Sands are forms presenting considerable differences, and it may be a legitimate question whether all of these should be included here, but there can be no doubt, with the specimens before us, that the difficulty as to the Dogger types disappears, and that, whatever stratigraphical palæontologists may say to the contrary, Sowerby was justified in placing the shells from the Peak and from Steeple Ashton under the same specific designation.

*General Description.*—Since modifications of the ornaments take place from absorption, from deposition of foreign matter, or from other causes due to differences of conservation and of the physical character of the matrix, it is important to seize upon such points as are least liable to be modified by mineralization. The following may be accepted as the general diagnosis of the *Cerithium muricatum* group in well-developed specimens.

Shell turritid: length, usually 18—25 mm.; spiral angle 16°—22°; whorls moderately tumid, flat in the middle, constricted towards the base, and subangular in general outline, 12—14 in number, width of whorl to height as 5 : 3·5. Suture well marked: ornaments conspicuous, consisting of spiral bands varying from 3 to 6 in number, which decussate with more or less numerous longitudinal ribs: the latter are frequently arcuate and have a slight inclination from left to right.<sup>1</sup> Nodes or spinous granulations occur at the points of intersection of the bands and ribs, and these nodes are drawn out spirally, in some cases more than others, but always spirally. The upper spiral band on each whorl is the most salient, producing the muricated character of the spire, though this feature is by no means confined to the group under consideration: the other spiral bands are equal or nearly so. The spiral belts in the base are strongly marked but plain.

Some of the varieties occurring in the Lower Oolites are partly represented by *C. granulato* and *C. muricato-costatum*, Münst. (Goldf., 1844, pl. 173, figs. 10 and 12), whilst Römer's *Turritella quadrilinea* (Ool. Geb. p. 154, pl. 11, fig. 14), which is quoted by that author from the Posidonienschiefer of Hildesheim, is without doubt

<sup>1</sup> N.B.—It may be worth remarking that in the *Chemnitzia vetusta* group the longitudinal ornaments are more conspicuous than the spiral ones: in the *Cerithium muricatum* group the two systems of ornament are about equally strong, whilst in the *Turritella* of the Dogger the ornamentation is altogether arranged spirally.



the representative of a section of the group. This form is recognized by Tate and Blake (Yorkshire Lias, p. 351) as occurring both in the highest beds of Alum Shale (Upper Lias), and also in the Blue Wyke Beds (*i.e.* the Dogger Sands).

It may be conceded to palæontologists who are fond of "making species" that fairly well marked natural form-groups existed in times past as they do now; but a "species" as it existed in Nature is probably in many cases a very different thing from a "species" created by an author, who only obtains a glimpse of the facts. Hence I am bound to confess my belief that very many "species" must be regarded as more or less provisional arrangements which an extended knowledge of the facts will tend greatly to modify. In the case of the fossils now more especially under consideration we may seek to find names for them in the various foreign books, straining a point here and there to make things fit, and when this resource fails us, we may confess defeat by making a new species. Where the differences are considerable and not bridged over by intermediate forms, this is perfectly legitimate. In dealing with the selected specimens of what I have called the *muricatum*-group, it seems the best plan to regard them as tending to arrange themselves in two sections, more especially as no great regularity of difference, no system as it were, seems traceable.

*Description, etc., of selected specimens* (Fig. 1).—Specimen from the Dogger (zone 1), Peak (Blue Wyke). Collection of Sowerby's types, British Museum. Marked "R. H. Bay."

Length (restored).....	20 millimètres.
Width .....	6
Height of whorl to width <sup>1</sup> .....	3·5 : 5.
Spiral angle .....	16°.

Spirals 4, except in the last two whorls, where a fifth spiral is partially developed; longitudinals straight, with very slight inclination, and rather wide apart.

Fig. 2.—Specimen from the Dogger (zone 1), Peak (Blue Wyke). Leckenby Collection.

Length (restored).....	18 millimètres.
Width .....	6
Height of whorl to width .....	3 : 4·5
Spiral angle .....	17°.

About an average width: spirals 5 on all the whorls as far as can be counted: longitudinals curved, with slight inclination, and rather close together.

Figures 1 and 2 may be regarded as more or less typical of the two commonest varieties of *C. muricatum*, and very nearly the same two varieties may be noted in the Coralline Oolite of Pickering. In the "Corallian Gasteropoda" (GÉOL. MAG. 1880, p. 402) these two varieties were described as *C. muricatum*, Sow., and *C. Russiense*, D'Orb., the latter being the form with 4 spirals. In the Dogger Sands specimens with 5 spirals and curved costæ are tolerably numerous, and except that they mostly run rather larger, many must

<sup>1</sup> In this measurement the penultimate is selected.

be regarded as identical in form and ornaments with Fig. 2, due allowance being made for difference of matrix.

Fig. 3.—*C. muricatum*, var. *sexlineatum*. Specimen from the Dogger Sands (lower part of zone 1), Blue Wyke. Leckenby Collection.

Length (restored) .....	22 millimètres.
Width .....	6½ ”
Height of whorl to width .....	3.5 : 5.
Spiral angle .....	18°.

Spirals 6 in number; the nodes at the intersections are much drawn out spirally, so as to produce a slightly different pattern, which is somewhat exaggerated in the figure. Longitudinals considerably curved; nodes fine and sharp, as though originally rather more spinous.

Whilst Figs. 1 and 2 represent comparatively common forms, Fig. 3 represents the only specimen I have seen. Such a specimen, if regarded simply by itself, might well be deemed to belong to a distinct species.

Fig. 4.—Specimen from the Cornbrash (zone 4), Scarborough. Leckenby Collection.

Length (restored) .....	23 millimètres.
Width .....	6½ ”
Spiral angle .....	16°.

Spirals 4 in number, nodes but little drawn out spirally, and not in the least echinate; longitudinals moderately curved—more so than is shown in the figure. Suture wide, upper spiral band of each whorl but little prominent. In this specimen the aperture is well preserved; its subquadrate character and anterior canal being well seen. A small oyster causes a thickening on the end of the canal.

The striking peculiarities of Figure 4 are perhaps as much due to *status* as to any other cause; the ornaments appear to have been rounded by a sort of polishing action, which may be partly chemical, partly mechanical. The older authors in making species do not seem to have had any regard to the external changes thus produced by fossilization. What we are certain of in this case is that the shell was spirally quadrilineate with curved longitudinals. It may be near to a *Cerithium*, stated by Morris and Lycett (Great Ool. Moll. p. 29) to be the most common of the genus in the Great Oolite of the Cotteswolds, and which they refer to *C. quadricinctum*, Müntst.;<sup>1</sup> but, after all, this is no more than a conjecture as regards the Scarborough fossil. On the other hand, some might prefer to compare it with *C. granulato-costatum*, Müntst., only it happens to have 4 spirals instead of 5, and is hardly at all turritid.

Fig. 5.—*Cerithium Culleni*, Leck.<sup>2</sup> TYPE REFIGURED. Specimen from the Kelloway Rock (zone 5), Scarborough. Leckenby Coll.

Length (restored) .....	13 millimètres.
Width .....	3½ ”
Spiral angle .....	?13°.

<sup>1</sup> Goldf. Gast. p. 30, pl. 173, fig. 11.

<sup>2</sup> Q. J. G. S., vol. for 1859, p. 13, pl. 3, fig. 13.

The spirals are 4, the nodes much extended spirally, and somewhat spiny (rather more so than shown in the figure), so as to give the specimen an echinate aspect: longitudinals very straight and well-marked.

One of the conditions relied upon by Mr. Leckenby in distinguishing this form was its less rapid volitional increase (*i.e.* smaller spiral angle), as compared with the more typical forms of *C. muricatum*. This appearance is doubtless increased owing to the fact that one side of the type specimen is not quite clear of matrix. As Mr. Leckenby's species were founded for the most part on specimens in a poor state of preservation, and of very infrequent occurrence, it becomes a matter of interest to ascertain how far the peculiarities attaching to this fossil are representative of forms on that horizon, and how far they are adventitious. Unfortunately, I have never seen any specimen of the *muricatum*-group from the Kelloway Rock of Yorkshire other than this one. *C. echinatum*, von Buch, quoted by Quenstedt from the Brauner Jura<sup>1</sup> *delta*, may be taken as the type of this group, and the differences between it and the shells from the *Parkinsoni*-Oolite of Aalen referred by the same authority to "*Turritella*" *muricata*, Sow., were long ago pointed out by von Buch.

Fig. 6.—*C. muricatum*, var. *trilineatum*. Specimen from the Scarborough Limestone (zone 3), York Museum.

Length .....	10 millimètres.
Width .....	5     "
Spiral angle .....	25°.

Spirals 3 in number; nodes large and roundish; longitudinals prominent, and slightly arcuate, or more strictly speaking irregular; whorls full, but flattened towards the middle, suture well marked.

This is a unique specimen, and represents the opposite extreme to such a form as Fig. 3, so far as the number of spirals is concerned. Its wide angle and other peculiarities might almost entitle it to specific distinction.

Fig. 7.—Specimen from the Dogger Sands (lower part of zone 1), Blue Wyke. Leckenby Collection.

Length (restored) .....	12 millimètres.
Width .....	4     "
Spiral angle .....	22°.

Whorls tumid, and without flattening in the centre; muricated character not prominent. Spirals 5; longitudinals well developed and arcuate.

In the tumid rather than subangular character of the whorls, in the very slight prominence of the upper spiral band, the shortness of the spire, and the slightly larger spiral angle, there is considerable divergence from the more typical forms of *C. muricatum*, of which Fig. 2 may be regarded as a good representative. Taken by itself alone, this specimen might almost be raised into a species, as one would not hesitate to do, if any considerable number were found.

<sup>1</sup> Quenstedt, *Der Jura*, p. 417, pl. 57, figs. 15 and 16.

Fig. 8.—Same horizon and collection as the above.

Length (restored).....	11 millimètres.
Width .....	$3\frac{3}{4}$ ”
Spiral angle about .....	$22^{\circ}$ .

Whorls nearly flat; spirals 4, with but slight prominence of the upper row, longitudinals straight.

As this specimen happens to have no more than 4 spirals, it would do for *C. quadrilineatum*, Röm., but for the fact that the longitudinal costulæ in Römer's species are described as being subarcuate, whilst these are certainly very straight. Brauns (Mittl. Jura, p. 171) includes specimens with 5 spirals under this heading, and, if a little more latitude be given, *C. quadrilineatum* might be made to cover most varieties of the *muricatum*-group from this low horizon.

*Relations and Distribution of the C. muricatum*-group.—Unless we are prepared to make a distinct species out of every variety of this most abundant and widely-spread group of fossil shells, the only alternative method of dealing with the subject at all practicable is to regard the numerous modifications as representing varieties within certain limits, such as those laid down in the general diagnosis.

In the Leckeny Collection may be seen a number of these forms from the Dogger Sands, nearly every one of which shows some difference. Specimens with 4 (Fig. 8), 5 (Fig. 7), 6 (Fig. 3), spirals occur; likewise specimens with arcuate longitudinals (Figs. 3 and 7) and straight longitudinals (Fig. 8), though the former are decidedly the most numerous. On the whole, specimens from the Sands run rather larger than do those from the Dogger, the varieties Figs. 7 and 8 having been selected simply to illustrate extremes. The most common form in the Sands is exemplified by Fig. 2, though that happens to represent a Dogger specimen. I regard this as the standard or typical form (not necessarily the type) of the group, it having the most resemblance to the well-known Steeple Ashton fossils. All the forms that do not come up to this standard might be regarded by thorough species-makers as distinct. When we ascend into the Dogger itself, the group is less numerous, and the varieties apparently more restricted; but we find the straight-ribbed, flat-whorled sort (Fig. 1) with 4 spirals, in addition to the form (Fig. 2) which I have described as most typical. In the succeeding zones the group is very rare, and is represented by such divergent forms as Figs. 4, 5, and 6 from the Cornbrash, Kelloway Rock and Scarborough Limestone respectively—divergent after making all due allowance for difference of fossilization under different physical conditions. I am not aware of any specimens having been found in the Oxford Clay of Yorkshire, but the form with 4 spirals (identified with *C. Russiense*, D'Orb., see “Corallian Gasteropoda”) is not very uncommon in the Lower Calcareous Grit; whilst in the Coralline Oolite, especially at Pickering, both forms which occur in the Dogger are again seen, but far more abundantly, especially the 5-spiral form, with curved longitudinals.

There does not appear to be any great regularity or plan in these varieties of ornament, so that a trinomial system of nomenclature

would scarcely help us out of our difficulty here. We might agree to call all specimens with straight longitudinals and a flat whorl *C. Culleni*; and those with curved longitudinals and more tumid whorl *C. muricatum*, without reference to the number of spirals. Or, if we try another method, we might call the specimens with rounded nodes *C. granulato-costatum*, and those specimens with spinous nodes *C. muricato-costatum*. Thirdly, if we adopted the number of spirals as our test, we should have *C. sexlineatum* (Fig. 3), *C. quinquelineatum* (Fig. 2), *C. quadrilineatum* (Figs. 1 and 5), *C. trilineatum* (Fig. 6). Roughly speaking, two sections of the group seem to declare themselves, and under these most of the forms might be arranged, though such an arrangement would only be of an incomplete and partial character. The first section would be arranged under *C. muricatum*, Sow., with its curved longitudinals, and its whorls somewhat tumid though flattened in the centre and rather constricted towards the base, it has usually 5 spirals. Very fine specimens of this type occur in the Dogger Sands, more rarely in the Dogger, and the very same form, even to the most minute details, is an abundant and characteristic fossil of the Coralline Oolite of Pickering.<sup>1</sup> Of the second section with straight longitudinals and a flat whorl, *C. echinatum*,<sup>2</sup> von Buch, might be selected as the nominal representative. *C. Culleni*, Leck., would fall in here and likewise the variety in the Coralline Oolite identified with *C. Russiense*, D'Orb. This section usually has four spirals. It is hardly necessary to say much more with regard to such divergent forms as are depicted in Figs. 3, 6, and 7, beyond the fact that they are very rare. The variety Fig. 3 occurs where the group is rather numerous and given to sporting; whilst the variety Fig. 6 occurs where the group is extremely rare, and where possibly the forms were pauperized. The form Fig. 7 might be entitled to more distinct recognition.

As regards distribution in the Inferior Oolite of other districts in England, we seem to have but little evidence of the occurrence of this group. No specimens answering to any of the varieties have been seen by me from Bradford Abbas, etc., nor does Mr. Tawney notice any species of *Cerithium* amongst the Dundry Gasteropoda. Neither has it been detected by Mr. Walford in the Inferior Oolite of North Oxfordshire. The species in the Great Oolite referred by Morris and Lycett to *C. quadricinctum* may belong here. On the Continent we may always suspect its presence when we see such names as *C. quadrilineatum*, *granulato-costatum*, *muricato-costatum*, *echinatum*, etc., in lists of fossils. Coming to the higher horizons, in Hébert and Deslongchamps' work on the Callovian of Montreuil Bellay, we recognize in *C. Lorieri*, H. and D.,<sup>3</sup> the average form with 5 spirals and arcuate longitudinals, and in their "*C. granulato-costatum*, Quenst,"<sup>4</sup> we see the section to which *C. Culleni* belongs, and for which *C. echinatum* is perhaps the most appropriate name.

<sup>1</sup> Specimens from this horizon near Weymouth have the longitudinals more closely set, and the whorls are without the constriction towards the base.

<sup>2</sup> Quenst. Der. Jura, p. 417.

<sup>3</sup> Bull. Soc. Linn. Norm. vol. v. p. 41 (sep. mem.), pl. vi. fig. 2.

<sup>4</sup> *Vol. cit.* p. 38, pl. vii. fig. 1.

Thus it is evident that, on many horizons, and in countries far distant, these two sections seem to have been ranged side by side wherever the group was at all numerous, and although this fact may be lost sight of in a fog of synonyms, and of specific names created for small differences, it will be surely recognized by those who regard the whole system of species-making as one that requires modification, if we are to arrive at a correct understanding of the life history of the past.

24.—*CERITHIUM GEMMATUM*, Morris and Lycett, 1850. Plate III. Fig. 9.

1850. *Cerithium gemmatum*, Morris and Lycett, Great Ool. Moll. p. 115, pl. xv. fig. 6.

1875. *Ibid.* *Ibid.* Phillips's G. Y. 3rd ed. p. 258.

*Bibliography, etc.*—The authors describe their specimen as from the "Great Oolite near Scarborough." I have not traced the type, but the specimen now figured resembles it very fairly. The following is the original description. "Shell small, turritid; volutions rather convex, encircled with 5 rows of nodules; nodules ovate, about 24 in a volution; the rows of nodules are slightly curved, and the last volution has from 7 to 9 rows.

The little nodules are regular, oval, their longer diameter being in the axis of the shell, and they are distant from each other about their own diameter; the number of volutions are but few, apparently not more than 7. Length 7 lines, transverse diameter 2 lines."

*Description.*—Specimen from the Scarborough Limestone (zone 3). Bean Collection, British Museum.

Length .....	15 millimètres.
Width .....	4 $\frac{3}{4}$ "
Spiral angle .....	20°.

Except as regards the number of whorls, the original description, quoted above, would do very fairly. In this one 8 whorls can be counted, and at least 3 more must have existed on the spire, making 11 in all. The little oval granules of the upper spiral in each whorl are somewhat stouter than the rest: the whorls are very regularly convex, and the body-whorl is decidedly full: the base is ornamented with spiral bands, of which the two uppermost are granulated, the granules being drawn out spirally, and less deeply cut out than those of the spire. The body-whorl shows 6 spirals on the flank (Fig. 9a).

*Relations and Distribution.*—This very elegant little *Cerithium* is probably remotely connected with the *muricatum*-group, from which it is separated by the more convex character of the whorl, by the excessive closeness of the longitudinals, and by the fact of the nodes or granules being drawn out axially (longitudinally) and not spirally; which latter seems an important difference, since in all the varieties referred to the *muricatum*-group, which are figured in the accompanying Plate, the nodes or granules are drawn out spirally. The beaded character of the granulations is partly due, I suspect, to the effect of the marly matrix, and hence this point of difference need not be insisted on too strongly.

Confined in Yorkshire, as far as I know, to the more marly beds of the Scarborough Limestone, *C. gemmatum* is moderately plentiful in the grey marly Oolite of White Nab, whence Mr. Herries obtained specimens lately. Under what synonym it lurks in other localities, or on other horizons, I have not yet discovered, supposing it to be anything more than a local form.<sup>1</sup> It would be almost too hazardous to suggest that *C. granulato-costatum* partly represents it.

25.—*CERITHIUM BEANII*, Morris and Lycett, 1850. Plate III.  
Figs. 10 and 11.

1850. *Cerithium Beanii*, Morris and Lycett, Great Ool. Moll. p. 112, pl. xv. fig. 5.  
1875. *Ibid.* *Ibid.*, Phillips, 3rd edition, p. 257.

*Bibliography, etc.*—This species was originally described by the authors of the Great Oolite Mollusca as occurring “near Scarborough,” and therefore presumably either in the Millepore Rock (zone 2), or in the Scarborough Limestone (zone 3)—at that time supposed to represent the Great Oolite. I have not succeeded in identifying the type specimen (which is but poorly figured) in any of the collections, nor have I seen any specimens in the matrix of the Scarborough Limestone anywhere. For this reason I am forced to the conclusion that Phillips in his third edition has made a mistake (p. 257) in confining this species to his “Grey Oolite,” *i.e.*, to the Scarborough Limestone. All specimens seen by me, no matter in what collection, are unmistakably from the Dogger, though there are dwarfed forms in the Millepore Rock which might represent it. In the Scarborough Limestone even these do not occur, if I may judge by the collections or by my own experience. Notwithstanding the prevalent impression to the contrary, *C. Beanii*, in all its varieties, is essentially a shell of the Dogger.

The following is the original diagnosis. “Shell small, turritid: apex obtuse, volutions numerous, narrow, rather flattened, encircled with five rows of costæ: costæ tuberculated, the costæ being about 16 in a volution: ribs unequal, sutures of the whorls deeply depressed; third and fifth row of costæ less prominent.”

*Description.*—Specimen from the Dogger (zone 1), Peak (Blue Wyke). York Museum (Fig. 10).

Length from base to apex about .....	12 millimètres.
Width .....	3 $\frac{3}{4}$ ”
Height of whorl to width .....	2 : 3 $\frac{3}{4}$ ”
Spiral angle of apex probably about .....	25°.
Ditto of anterior portion of spire .....	15°.

This specimen corresponds so well to the above diagnosis of the species that there is very little to add. The upper row of spirals is strongly tuberculated, and so contributes to the turritid character of the shell. There is no proper system of longitudinals, but an irregular development in the upper part of each whorl, where the nodes or granulations have a tendency to become confluent in an axial direction. The apex, in this specimen, is broken off, but it seems clear that the opening of the spiral angle was considerably

<sup>1</sup> Quoted as common in the Lincolnshire Limestone, App. to Judd’s Geol. of Rutland, p. 281.

larger than the angle of the anterior portion of the spire. This coincides with the "apex obtuse" of Morris and Lycett; hence the shell is somewhat pupoid.

*Description of a Variety.*—Specimen from the same horizon, locality, and collection (Fig. 11).

Length.....	9 millimètres.
Width.....	3·5 „
Angle of anterior portion of spire .....	20°.

A shorter and thicker variety, not less pupoid perhaps than Fig. 10, which is the most frequent form. There is also a considerable difference in the ornaments. In this one the two uppermost spirals are almost fused into one belt, which is thus strongly bi-tuberculate, and gives a turritid aspect to the whorls in spite of the pupoid outline of the spire. The third and fifth spirals are faint as in the typical forms: there is no defined system of longitudinals.

*Relations and Distribution.*—*Cerithium Beanii* is clearly a well-marked species, the most prevalent form being that indicated in Fig. 10. The five richly cut spirals, the less prominence of the third and fifth rows, the strong tuberculation of the first and second rows, giving rise to irregular longitudinals sometimes continued to the base of the whorl, are unmistakable characteristics of ornamentation. A specimen in the Leckenby Collection, said to come from the Dogger Sands, represents a short and extremely pupoid variety, where the longitudinals are very thick in the upper part of the whorls. In the specimen thus alluded to the longitudinal almost overpowers the spiral system of ornament—an effect partly produced perhaps by the conditions of mineralization.

As regards distribution in Yorkshire, *C. Beanii*, including the two forms, Figs. 10 and 11, is very rare in the Dogger Sands, but rather abundant in the Dogger, especially in the *Nerinea*-bed at Blue Wyke, whence both Mr. Herries and Mr. Walford have obtained several characteristic specimens lately. In nearly all cases the apex seems to be missing, nor have I seen any specimen showing a well-preserved aperture, though, as *Cerithium turris* (Fig. 13) is a near relative, the aperture in *C. Beanii* would probably be not very dissimilar to this one. The presence of *C. Beanii* on the Millepore horizon, either on the coast or in the Castle Howard district, is not so certain. I rather think that I remember having seen something like it, but do not feel sure. Although I have searched all the collections accessible, there seems to be no trace of it in the Scarborough Limestone. Hence *C. Beanii* in Yorkshire is characteristic of a very low position in the Inferior Oolite.

Turning to the Midland district, we observe in the Jermyn Street Museum specimens, said to come from the Inferior Oolite of Compton, which have been referred to *C. Beanii*, and it is quoted in lists of fossils in Judd's Geology of Rutland as occurring in the Lincolnshire Limestone, but not in the Northampton Sand, where we should rather expect to find it.<sup>1</sup> No mention is made of this species in Mr. Tawney's list of Dundry fossils, and, as far as I know, it is equally absent from the Bradford Abbas district.

<sup>1</sup> *Op. cit.* App. p. 281.



It is almost dangerous to suggest what may be the representative or nearest relative of *C. Beanii*, on the Continent. *C. pupæforme*, Koch and Dunker (Beitr. p. 33, pl. 2, fig. 10), has some resemblance to the more pupoid forms of *C. Beanii*, but in general appearance rather than in details. Koch and Dunker's species is stated by Brauns (Mittl. Jura, p. 176) to occur in the middle division of the *Parkinsoni*-zone of North-west Germany.

26.—*CERITHIUM LECKENBYI*, sp.n. Plate III. Fig. 12.

*Description*.—Specimen from the Dogger (zone 1), Peak (Blue Wyke). Leckenby Collection.

Length (restored).....	?17 millimètres.
Width .....	4    "
Height of whorl to width .....	2: 3 $\frac{3}{4}$ .
Spiral angle .....	14°.

Spire elongate, conical, sub-turrited. There are indications of about 13 whorls, which, as far as can be judged from the somewhat imperfect condition of the apical portion of the spire, increase under a perfectly regular angle: they are flat, short in comparison with their width, and follow close on the suture, which is consequently rather narrow. The ornaments consist of 5 finely granulated or tuberculated spirals, of which the first is the strongest, and the fifth the faintest. The longitudinals are irregular, as in *C. Beanii*, frequently not reaching to the anterior portion of the whorl. Spirals in the base of the body-whorl scarcely granulated. Aperture in matrix.

*Relations and Distribution*.—Closely related as regards ornament to *C. Beanii*, though not showing the extreme faintness of the third and fifth spirals. The spire is less turrited, more elongate, and, as far as one can judge, not in the least pupoid. Hence, in spite of its being an unique specimen, I have felt constrained to recognize this form as a "species," though it might be called *C. Beanii*, var. *elongatum*. Mr. Leckenby himself seems to have taken this view.

27.—*CERITHIUM TURRIS*, sp.n. Plate III. Fig. 13.

*Description*.—Specimen most probably from one of the nodule beds of the Dogger. Jermyn Street Museum.

Length (restored).....	13 millimètres.
Width .....	4 $\frac{3}{4}$ "
Height of whorl to width .....	2: 4 $\frac{1}{4}$ .
Spiral angle .....	20°.

Spire short, strongly turrited, with probably a blunt apex. Whorls about 12 or 13 in number, flat, and short, suture close. The ornaments are very conspicuous for so small a shell. Seven spirals are counted on the penultimate, consisting of wavy lines with granulations, drawn out spirally, at considerable intervals, producing a sort of basket-like pattern. The longitudinals are very strong, and close together, especially in the upper part of each whorl, but are on the whole irregular. Aperture sub-quadrate to oval, with a well-developed anterior canal.

*Relations and Distribution*.—Obviously related to *C. Beanii*, this is

a more widely angled and less pupoid shell, possessed of a more complex system of ornamentation, and much more strongly turritid. The specimen is unique, as far as I know.

28.—*CERITHIUM* (*KILVERTIA*) *COMPTONSENSE*, sp.n. Plate III.

Fig. 14.

*Description*.—Specimen from the Millepore Rock of the coast (zone 2). Leckenby Collection.

Length of the entire shell .....	6 millimètres.
Width .....	1 $\frac{3}{4}$ „
Ratio of body-whorl to entire shell, nearly as....	1 : 2.

Shell extremely small and short, with an obtuse apex; whorls 6 in number, the body-whorl being relatively large; sutures close and the sutural inclination slight. Spirals 4 in number, judging from the penultimate, where alone the ornaments can be determined with accuracy: three of these are distinguished by large oval granulations, extended spirally, but arranged to form the thick tuberculated costæ so characteristic of the spire. The spirals in the base of the body-whorl are strongly marked, but not tuberculated. Aperture involved.

*Relations and Distribution*.—This curious little shell is so situated in the matrix that it has not been possible to ascertain for certain whether it possesses the thickened orbicular aperture said to be one of the characteristics of *Kilvertia* (Lycett, Suppl. to Grt. Ool. Moll. pp. 8 and 15), a subgenus instituted to receive a number of pygmy forms chiefly known in this country from Bathonian beds.

As regards Yorkshire the specimen is unique, but there exists in the Jermyan Street Museum a solitary specimen, clearly belonging to this species, said to come from the Inferior Oolite of Compton;<sup>1</sup> hence the name selected.

29.—*CERITHIUM*, or *TURRITELLA*, sp. Pl. III. Fig. 15.

*Description*.—Specimen from the Dogger Sands (lower part of zone 1), Blue Wyke. Leckenby Collection.

This specimen is too imperfect for accurate measurements, but the fragment indicates a turritid univalve with a spiral angle of 15°, and very wide suture. As there is no trace of aperture, it is difficult to say whether this form should be classed under *Cerithium* or *Turritella*. Judging from analogy with other shells about this horizon, the openness of the suture is rather in favour of regarding it as a *Turritella*. The number of the spirals (4), and the prominence of the third one, would seem rather to connect it with *Turritella quadrivittata*, presently to be described. Yet there is a somewhat spiny character about the nodes, and certain traces of longitudinal ornament, which altogether fails in the *Turritellæ* of the Dogger, where the ornamentation partakes more of the nature of spiral belts.

In the enlargement of this ill-preserved specimen too much prominence has perhaps been given to the third spiral. There is no other specimen exactly like it in the Leckenby Collection; but there is a small *Cerithium*, also from the Dogger Sands, which may belong to

<sup>1</sup> No one seems to know exactly where this place is situated.

the same species. This latter is not unlike the figure and description of *C. quadriseriatum*, Desl. (Mem. Soc. Linn. Norm. vol. vii. p. 205, pl. xi. figs. 29 and 30).

CERITHIUM ABBREVIATUM, Leckenby, 1859.

1859. *Cerithium abbreviatum*, Leckenby, Q. J. G. S. vol. for 1859, p. 13, pl. iii. fig. 12.

The type specimen, now in the Woodwardian Museum, is so extremely imperfect that one would hesitate what to say about this species. The length of the fragment is 10 mm., representing most of the apical whorls of a shell whose original length may have been greater. Although very much larger, the ornaments somewhat connect it with *C. Comptonense*. Mr. Leckenby says that one-fourth of the length is occupied by the aperture: I can discover no aperture either in the specimen or in the figure, which is clearly that of a shell with the aperture broken off.

Unique specimen in the Leckenby Collection. Kelloway Rock, Scarborough.

EXPLANATION OF PLATE III.

- FIG. 1. *Cerithium muricatum*, Sow. Dogger, Blue Wyke. Collection of Sowerby's types, British Museum. Enlarged twice.
- „ 2. *Cerithium muricatum*, Sow., form with 5 spirals, and arcuate longitudinalinals. Dogger, Blue Wyke. Leckenby Collection. Enlarged twice.
- „ 3. *Cerithium muricatum*, Sow., var. *sexlineatum*. Dogger Sands, Blue Wyke. Leckenby Collection. Enlarged twice.
- „ 3a. Whorl further magnified.
- „ 4. *Cerithium muricatum*, Sow., var. near to *C. quadricectum*, Münt. Cornbrash, Scarborough. Leckenby Collection. Enlarged three times.
- „ 4a. Whorl further magnified.
- „ 5. *Cerithium muricatum*, Sow., var. *Culleni*, Leck. TYPE RE-FIGURED. Kelloway Rock, Scarborough. Leckenby Collection. Enlarged three times.
- „ 6. *Cerithium muricatum*, Sow., var. *trilineatum*. Scarborough Limestone, York Museum. Enlarged twice.
- „ 6a. Body-whorl further magnified.
- „ 7 and 8. Extreme varieties of the *C. muricatum* group. Dogger Sands, Blue Wyke. Leckenby Collection. Enlarged twice.
- „ 9. *Cerithium gemmatum*, Morr. and Lyc. THE TYPE SPECIMEN? Scarborough Limestone. Bean Collection, British Museum. Enlarged twice.
- „ 9a. Whorl further magnified.
- „ 10. *Cerithium Beanii*, Morr. and Lyc., typical form. Dogger, Blue Wyke. York Museum. Enlarged two and a half times.
- „ 10a. Whorl further magnified.
- „ 11. *Cerithium Beanii*, Morr. and Lyc., variety. Dogger, Blue Wyke. York Museum. Enlarged three times.
- „ 11a. Whorl further magnified.
- „ 12. *Cerithium Leckenbyi*, sp.n. Dogger, Blue Wyke. Leckenby Collection. Enlarged two and a half times.
- „ 12a. Whorl further magnified.
- „ 13. *Cerithium turris*, sp.n. Dogger, Blue Wyke. Jermyn Street Collection. Enlarged twice.
- „ 13a. Whorl further magnified.
- „ 14. *Cerithium (Kilvertia) Comptonense*, sp.n. Scarborough Limestone. Leckenby Collection. Enlarged four times.
- „ 14a. Whorl further magnified.
- „ 15. *Cerithium* or *Turritella*, fragment from the Dogger Sands. Leckenby Collection. Enlarged two and a half times.
- „ 15a. Whorl further magnified.

## II.—NOTICE OF NEW FISH REMAINS FROM THE BLACKBAND IRONSTONE OF BOROUGH LEE, NEAR EDINBURGH. No. V.

By Dr. R. H. TRAQUAIR, F.R.S.

*Aganacanthus striatulus*, n. gen. et sp.

I HAVE recently obtained from the Borough Lee Ironstone several specimens of a Selachian spine, apparently new, and showing several features of a very interesting character.

The most perfect of these specimens measures  $5\frac{1}{2}$  inches in length; but as the apex is broken off, its original length was probably six inches. In general form it is stout and rapidly tapering; its circumference at the thickest part, two inches from the proximal extremity, being  $3\frac{1}{2}$  inches, and only  $\frac{7}{10}$  inch where it is broken off distally. The spine shows, moreover, a pretty strong antero-posterior curvature, besides which, it is also slightly bent laterally, there being no indication that this lateral curvature is in any way the result of distortion by pressure. The base is occupied by an extensive cavity, which extends along the back of the spine as a deep open hollow or sulcus, which closes externally at a distance of  $3\frac{7}{10}$  inches from the proximal extremity. Transverse sections show that this cavity, after its external closure on the posterior aspect of the spine, becomes internally very soon obliterated.

The anterior margin is rounded, and from it two sides diverge backwards, each of which, in the proximal part of the spine, becomes rounded off posteriorly into the corresponding lip of the posterior hollow or sulcus. But one of these sides, that on the concave aspect of the spine, is *narrower than the other*, so that the opening of the aforesaid hollow does not look right backwards; accordingly this hollow is visible when the spine is looked at from one side, invisible when viewed from the other. After the closure of the sulcus the transverse section assumes a trigonal aspect, with rounded angles, but the two sides, corresponding to the lateral aspects of the spine, remain as before unsymmetrical, one being (in section) longer than the other. Where the point is broken off, the posterior side, which at first was flattened, has now become slightly convex; but the angles between it and the two unsymmetrical lateral surfaces are still evident.

The external surface shows no trace of enamel, nor any sort of sculpture save a close and delicate longitudinal striation, which gives it that so-called "fibrous" appearance characteristic of the implanted portions of other fossil shark-spines.

Another specimen measures  $5\frac{4}{5}$  inches in length, and displays the same essential characters as the preceding, save that it presents no lateral curvature, and that its point, which has certainly not been lost by breakage, in getting it out of the stone, seems obliquely sliced, or worn, off posteriorly. But another interesting point is that this specimen is asymmetrical in precisely the opposite direction to the preceding. Place the two spines together on a table with their backs facing each other, and the posterior hollows of both are visible; reverse them, so that the anterior margins are opposite, and in both cases the posterior hollows are invisible. It is therefore

plain that these two spines, though not belonging to the same fish, form in other respects a *pair*, right and left.

A third specimen represents the distal portion of a spine broken off after the closure of the sulcus, but fortunately with the point entire. It is  $2\frac{2}{3}$  inches in length, and  $1\frac{2}{3}$  inch in circumference proximally, whence it tapers to a pretty sharp point. The unsymmetrically trigonal form of the transverse section, the nature of the striation of the surface, and the appearance, internally, of the tissue of which it is composed, show clearly that this fragment is the terminal portion of a spine of the same species as the two already noticed, and it may also be observed that, as regards the direction in which it is unsymmetrical, it belongs to the same category as No. 2. But the point of special importance in this specimen is that, extending from the apex for a distance of  $\frac{9}{10}$  inch along the posterior aspect, are two rows of small recurved denticles, each row being placed slightly within the rounded margin separating the posterior from the corresponding lateral surface. The denticles on the broader side of the spine are nearly all perfect, and are nine in number, those on the narrow side are only eight, and are mostly broken off, though still indicated by the fractured bases,—I may add that they were perfect before the specimen was removed from its matrix. The distance between the denticles in each row increases from about  $\frac{1}{2}$  inch at the apex to  $\frac{1}{3}$  between the last two, but the increase is not regular, so that the denticles of the two series are not always opposite. The surface of the denticles is smooth, nevertheless there is no appearance of a covering of enamel.

This new spine is of great interest from the analogies with *Gyracanthus* which it presents in many important points of its configuration. As in *Gyracanthus*, we have here a spine which is not bilaterally symmetrical, the posterior area being turned awry, which occurs in pairs, and which accordingly may safely be looked upon as a lateral appendage. One of the specimens presents appearances at the apex which I am inclined to interpret as “wearing,” though, if so, the wearing is on the posterior aspect. But though the wearing in *Gyracanthus* spines is usually anterior, I have certainly seen it also on the posterior aspect in specimens from Borough Lee. Here, however, the resemblances cease, as the present spine is proportionally short and stout, is devoid of distinctive sculpture, and its mode of denticulation is very different.

From the want of shining enamel or ganoine on the surface, which want is certainly not due to abrasion or erosion in any specimen I have seen, I propose to call the present new genus and species of Selachian spine *Aganacanthus striatulus*.

### III.—THE LONG MEAD-END BED. FURTHER REMARKS.

By S. V. WOOD, F.G.S.

BY the kindness of Dr. Henry Woodward, Keeper of the Geological Department of the British Museum, I have been furnished with a list of shells which have the locality “Mead End” attached to them in the Edwards Collection in that Museum.

To these I have been able to add from other sources<sup>1</sup> some others which are given in italics in the subjoined list, those in the Edwards collection appearing in Roman letters; and together they represent the whole molluscan fauna which up to this time has, so far as I can ascertain, been obtained from this bed.

It is not unlikely that collectors from the Hampshire beds may be able to add to the list, and if so I should feel obliged to them if they would favour me with particulars of such. The columns to show the presence of the shells in the Upper Eocene of Belgium are based on the Bruxellian and Laekian lists of Nyst, in Prof. Dewalque's "Prodrome d'une description géologique de Belgique," pp. 401 to 407, and those showing this in the Upper Eocene of France are based on Deshayes' "Animaux sans vertèbres dans le bassin de Paris, 1866." The negative occurrence of them in the column for the Lower Tongrian is based on the lists of Bosquet in the same "Prodrome," pp. 410 to 416.

Names of Species. (Those marked + are, though given in Messrs. Keeping and Tawney's list of Middle Headon Shells in Q.J.G.S., vol. xxxvii. p. 113, omitted from the "Meadend" column of that list.)	Upper Eocene, France.		Upper Eocene, Belgium.		Lower Oligocene, Belgium
	Calcaire Grossier.	Sables Moyens.	Bruxellian	Laekian	Lower Tongrian.
<i>Marginella simplex</i> , Edw., Eo. Moll .....	...	...	...	...	...
<i>Pisania</i> ( <i>Buccinum</i> ) <i>lavata</i> , Sow. ....	...	..	...	...	...
<i>Oliva Branderi</i> , Sow. ....	...	*	...	...	...
† <i>Ancillaria buccinoides</i> , Lam. ....	*	*	*	*	...
<i>Natica Studeri</i> , Bron. ( <i>depressa</i> of Sow., but Deshayes doubts its identity with either <i>intermedia</i> , Desh., or <i>depressa</i> , Desh.) .....	?	...	...	...	...
„ <i>grossiuscula</i> , Edw. MS. (a var. of <i>Studeri</i> according to Keeping & T.)	?	...	...	...	...
<i>Planorbis hemistoma</i> , Sow. (a Lower Eocene species). ....	...	...	...	...	...
„ <i>biangulatus</i> , Edw. Eo. Moll. ....	...	...	...	...	...
† <i>Odostomia hordeola</i> , Lam. ....	*	*	...	...	...
<i>Cerithium</i> ( <i>Potamides</i> ) <i>pyrgotum</i> , Edw. MS.	...	...	...	...	...
„ „ <i>speculatum</i> , Edw. MS.	...	...	...	...	...
„ „ <i>pleurotomoides</i> , Edw. MS. ? (authority of K. & T.)	...	...	...	...	...
„ „ <i>variabile</i> , Desh. ( <i>funatum</i> of Mantell sec Desh., a Lower Eocene species.).....	...	...	...	...	...
„ „ <i>submarginatum</i> , D'Orb.	...	*	...	...	...
„ ( <i>Pirena</i> ) <i>concavum</i> , Sow. ....	*	*	...	...	...
„ „ <i>cavatum</i> , Edw. MS. (a var. of <i>concavum</i> according to K. & T.)	?	?	...	...	...
<i>Melania fasciata</i> , Sow. (M. Nysti, Duch.)...	...	...	...	...	...

<sup>1</sup> These sources are, as to *Lucina concava*, a note in my father's handwriting, and as to *Melanopsis sodalis*, *Cardita oblonga*, *Lucina divaricata*, *Psammobia appendiculata*, *Maetra depressa*, and *Corbula oblonga*, similar notes, and also specimens in my possession with their names and localities affixed to them in my father's handwriting. The authority for the introduction of the rest in italics is mentioned in the list.

Names of Species (continued).	Upper Eocene, France.		Upper Eocene, Belgium.		Lower Oligo- cene, Belgium
	Calcaire Grossier.	Sables Moyens.	Bruxellian.	Laekonian.	Lower Tongrian.
† <i>Melania muricata</i> (Sow. ? given in K. & T.'s sect. Q.J.G.S., vol. xxxix. p. 574).	...	...	...	...	...
<i>Melanopsis fusiformis</i> , Sow. ( <i>M. buccinoides</i> , Fer. ? and thought by Desh. to be only derivative in the Sab. Moyens).	...	*	...	...	...
„ <i>subfusiformis</i> , Morris.....	..	..	..	..	..
„ <i>brevis</i> , Sow. ....	..	..	..	..	..
„ <i>sodalis</i> , Desh. (a Low. Eocene, sp.)	..	..	..	..	..
<i>Rissoa carinata</i> , Edw. MS. ....	..	..	..	..	..
<i>Hydrobia subangulata</i> , Edw. MS. ....	..	..	..	..	..
„ <i>anceps</i> , (? author) .....	..	..	..	..	..
<i>Nematura (Valvata) parvula</i> , Desh. ....	..	..	..	..	..
<i>Neritina concava</i> , Sow.....	..	..	..	..	..
<i>Ringicula ringens</i> , Lam. ....	*	*	..	..	..
<i>Bulla Lamarckii</i> , Desh. ....	*	*	..	..	..
<i>Dreissena Brardii</i> , Fauj. ....	..	..	..	..	..
<i>Mytilus affinis</i> , Sow. ....	..	..	..	..	..
<i>Modiola elegans</i> , Sow. ....	..	..	..	..	..
„ var. <i>elegantior</i> , S. Wood..	..	..	..	..	..
<i>Trigonocœlia (Leda and Nucula) deltoidea</i> , Lam. ....	*	..	..	..	..
<i>Nucula tumescens</i> , Edw. (S. Wood) .....	..	..	..	..	..
„ <i>ampla</i> , Edw. (S. Wood) .....	..	..	..	..	..
<i>Cardita (Venericardia) oblonga</i> , Sow. ....	..	..	..	..	..
<i>Lucina inflata</i> , Edw. MS. ....	..	..	..	..	..
„ <i>pratensis</i> , Edw. MS. ....	..	..	..	..	..
† „ <i>concava</i> , De Fr.....	..	..	..	..	..
„ <i>gibbosula</i> , Lam. ....	*	*	*	..	..
„ <i>divaricata</i> , Lam. ( <i>L. pulchella</i> , Ag.)	*	..	*	*	..
„ ( <i>Strigilla</i> ) <i>colvellensis</i> , Edw. MS.	..	..	..	..	..
<i>Cyrena cycladiformis</i> , Desh. ....	*	..	..	..	..
„ <i>pisum</i> , Desh. ....	*	..	..	..	..
„ <i>gibbosula</i> , Morris .....	..	..	..	..	..
„ <i>arenarea</i> , Forbes .....	..	..	..	..	..
„ <i>altirupestris</i> , Edw. MS. ....	..	..	..	..	..
<i>Psammobia rudis</i> , Lam. ( <i>solida</i> , of Sow.) ...	*	*	..	*	..
„ ( <i>Solen</i> ) <i>appendiculata</i> , Desh. (upper Calc. Gros. only) .....	*	..	..	*	..
<i>Tellina reflexa</i> , Edw. in Lon. Geol. Journ...	..	..	..	..	..
„ <i>elongata</i> , Edw. MS. ....	..	..	..	..	..
<i>Mactra fastigiata</i> , Edw. MS. ....	..	..	..	..	..
„ <i>filosa</i> , Edw. MS. (a var. of <i>fastigi-</i> <i>ata</i> , according to Keeping and T.)	..	..	..	..	..
„ <i>depressa</i> , Desh ( <i>compressa</i> also of Desh.) .....	..	*	*	..	..
<i>Mya angustata</i> , Sow. ....	..	..	..	..	..
<i>Potamomya plana</i> , Sow. ....	..	..	..	..	..
<i>Corbula nitida</i> , Sow. (non Bron. non D'Orb. non <i>Sphenia nitida</i> , Desh.) ...	..	..	..	..	..
„ <i>cuspidata</i> , Sow. ....	..	..	..	..	..
„ <i>fortisulcata</i> , Edw. MS. (a var. of <i>pisum</i> , according to Keeping & T.)	..	?	..	?	..
„ <i>oblonga</i> , Desh. (upper Calc. Gros. only) .....	*	..	..	..	..

To what extent the species marked "Edwards MS." may be represented in French or Belgian beds I am unable to say; but taking the published species as the basis of remark, the statement I made in the December Number of the *GEOL. MAG.*, that not many of the Meadend species occurred in the Laekenian, but more in the Sables Moyens, is borne out. All the Upper Eocene of England, however, so far as the molluscan remains in it afford an indication, appears to have a greater connection with the beds regarded as the Upper Eocene of France, than with those similarly regarded of Belgium; a fact for which no sufficient explanation has yet been suggested.

Four of the published species, viz. *Marginella simplex*, *Psammobia rudis*, *Corbula nitida*, and *Mya angustata* (all Middle Headon shells), do not seem to have occurred lower in the Tertiary series of England than this bed, though *Psammobia rudis* occurs as low as the *Calcaire grossier* in France. Whether any of the species marked "Edw. MS." appear at a lower horizon than this bed I am unable to say.

When (in the December Number) I spoke of this bed showing the transition from the Upper Eocene to the Lower Oligocene, it was on the assumption that Prof. Judd's suggested correlation (p. 167 of vol. xxxvi. of the *Quart. Journ. Geol. Soc.*) was, so far as regarded the parallelism of the Lower Headon with the Lower Oligocene,<sup>1</sup> sufficiently founded, whatever questions existed as to other points of contention; but as not one of the Meadend species seems to have occurred in the Lower Oligocene of Belgium, and the Meadend bed is but the fluvio-marine base of the Lower Headon, the correspondence of any part of the Lower Headon to the Lower Oligocene appears questionable.<sup>2</sup>

As the paper of my father, in which the Meadend bed was first made known, appeared in a periodical which stopped 37 years ago, after only the first few numbers of it had been published (so that his paper was not even concluded), and may be unknown to many younger geologists, I here reproduce so much of it as specially relates to the marine beds of Hordwell Cliff, viz. the Meadend bed and the Middle Headon, and the positions they respectively occupy in relation to the freshwater beds with which they are associated.

"On the Discovery of an Alligator and of several new Mammalia in the Hordwell Cliff; with Observations upon the Geological Phenomena of that Locality. By Searles Wood, F.G.S. (page 3 of the *London Geological Journal* for September, 1846).

"So far back as 1822, Mr. Webster visited this coast for the purpose of tracing the connexion between the cliff at Hordwell and that on the opposite side of the

<sup>1</sup> As Prof. Judd in his vertical "New Forest" section, (*loc. cit.* p. 170) places the "Sands" (numbered 1 in the section of Hordwell Cliff accompanying this paper) which intervene between the base of the Lower Freshwater and the Barton Clay, in his "Headon Group," and places all this group on the horizon of the Lower Oligocene, it follows that this horizon begins in his view even some way below the Meadend bed, although he does not show this bed in his section.

<sup>2</sup> One of the shells, *Neritina concava*, is given from the Klein Spawen bed; but as my father (see *Eo. Moll.* p. 346) found it at Muddiford, which is far below the Meadend horizon, this would be no exception to the remark in the text. Bosquet, however, regards the Belgian shell as different from Sowerby's *concava*.



Solent. He discovered on that occasion the existence of this freshwater deposit [that of Hordwell Cliff], and its geological identity with that portion of Headon Hill, in the Isle of Wight, which is in juxtaposition with the London Clay,<sup>1</sup> and known as the Lower Freshwater formation. But he was unable to find anything at all analogous to the so-called Upper Marine, that estuary deposit immediately resting on the Lower Freshwater at Headon Hill, though he suggested that it very probably might exist in some portion of the cliff then inaccessible to his examination. Mr. Lyell subsequently explored this part of the coast, and the account which he has given in the Geological Transactions for 1827 is the latest memoir that I know of in which any information respecting the Hordwell Cliff is to be found. Mr. Lyell's investigation led him to the four following conclusions:—

“First. ‘That no portion of the Upper Marine formation exists anywhere in this part of the Hampshire coast: the uppermost beds in the series at Hordwell Cliff, so far from indicating a passage into the Upper Marine, contain organic remains, both animal and vegetable, exclusively belonging to freshwater genera. The shells referred to by Mr. Webster as *Cerithia*, occurring in fallen blocks along the shore, belong to the genus *Potamides*, and the stratum in which they abound occupies a middle place in the series. *Cerithium* is a marine genus, but the *Potamides*, of which some species still exist in a recent state, inhabits rivers, or at least the mouths of rivers.’—*Geol. Trans. New Series, vol. 2.*”

“As Mr. Lyell's visit was probably a short one, I am not surprised at his not having observed any portion of the Upper Marine formation in Hordwell Cliff, but the existence of that deposit may be seen at a spot one mile to the east of Beacon-Bunny, and a few paces westward of a ravine that is situated half a mile from the village of Milford.<sup>2</sup> The bed occurs at an elevation of ten or twelve feet above high-water mark, but with a thickness of only nine or ten inches, and only traceable for about forty yards. Mr. Frederic Edwards, of Hampstead, so well known for his unrivalled cabinet of Hampshire fossils, was the first to notice this deposit, three years previous to my visit. At that time, he informs me, the bed could be followed for three hundred yards, but owing to the debris which has since fallen from the upper portion of the cliff, I could not trace it for a third of this distance.

The following list of Testacea from this stratum of the Upper Marine formation at Hordwell, is the joint result of Mr. Edwards' researches and my own.

*Acteon.**Ancillaria subulata* [*buccinoides*], Lam.*Arca elegans.**Balanus unguiformis.**Bulla* (two species).*Cæcum.**Cancellaria muricata.*,, *elongata.**Cerithium cinctum*, Sow.,, *margaritaceum*, Sow.,, *terebrale.*,, *ventricosum*, Sow.*Chenmitzia* [*Turbonilla*], two species.*Corbula cuspidata*, Sow.*Cyrena cycladiformis*, Desh.,, *obovata*, Sow.,, *pulchra*, Sow.*Cytherea incrassata*, Desh.,, *obliqua*, Desh.*Fusus labiatus*, Sow.*Hydrobius.**Kellia* [*Scintilla* and *Lepton*], two species.*Limnæus.**Lucina divaricata*, Lam.,, *pulvinata.**Melania angulata.*,, *fasciata*, Sow.*Melania muricata.**Melanopsis ancillaroides*, Desh.,, *carinata*, Sow.,, *fusiformis*, Sow.,, *minuta.**Murex sexdentatus*, Sow.*Mya angustata*, Sow.*Mytilus ? affinis*, Sow.*Natica depressa*, Sow.,, *epiglottina*, Lam.,, *labellata*, Lam.*Nematura.**Nerita aperta*, Sow.

<sup>1</sup> At this time, and until after the first part of this paper had been published, the Barton Clay was regarded by geologists as the same formation as the London Clay.

<sup>2</sup> In the Ordnance one inch to the mile map this ravine is called Paddy's Gap, but in the six inch to the mile map no name is given to it. Its distance from Milford is given correctly in my father's paper, but its distance from Beacon-Bunny is according to the six inch map upwards of a mile and a half.

*Neritina concava*, Sow.  
*Nucula* [*Trigonocelia*] *deltoides*, Lam.  
 „ new species.  
*Ostostomia subulata*.  
*Ostrea*.  
*Planorbis* (two species).  
*Pleurotoma* (two species).

*Psammobia compressa*, Sow.  
*Scalvria*.  
*Serpula corrugata*, Sow.  
 „ *tenuis*, Sow.  
 „ new species.  
*Turbo*?  
*Voluta spinosa*? Lam.

“ In addition to these are also found a species of *Cytherina*, and one of *Cristellaria*.

“ Many of the above species must have inhabited the sea, or at least that estuary portion of a river to which salt water must have had access, and these are not met with in that more purely *freshwater stratum* both above and beneath the *marine stratum* I have described. They are identical also with those *Testacea* which have been collected and regarded as marine from the so-called ‘Upper Marine’ in Headon Hill. The remaining portion of the cliff to the eastward, I consider more from position than its organic contents as the Upper Freshwater. Indeed, I am not acquainted with any species peculiar to this stratum; for I have found all hitherto published as such, in the *Lower Freshwater at Hordwell*.

“ Secondly, Mr. Lyell says, ‘The extent of the Freshwater formation is somewhat greater than had been supposed, as it is continued in Barton Cliff to nearly opposite the village of Barton, the lower beds of the series there exposed contain in parts *Gyrogonites* and freshwater shells.’

“ I am not disposed to admit the extent of this freshwater deposit to be so great as is here represented, but would limit its western extremity to that gorge or ravine known by the name of ‘Beacon-Bunny,’ the upper portion of which [gorge] is a bed of lignite beneath the gravel, and overlying a bed of greyish-white or light-coloured sand, containing the following molluscous genera, some species being extremely abundant: *Oliva*, *Potamides*, *Ancilla* [*Ancillaria*], *Natica*, *Melania*, *Melanopsis*, *Pleurotoma*, *Bulla*, *Mactra*, *Cyrena*, *Corbula*, *Sanguinolaria*, *Venericardia* [*Cardita*], *Cytherea*, *Lucina*, and *Potamomya*.<sup>1</sup>

“ This bed appears to be intermediate between the London Clay<sup>2</sup> and the Lower Freshwater, and must be referred to an estuary formation, for the largest portion of its *Testacea* are referable to marine genera; and for the sake of distinction it might be convenient to designate this estuary deposit by the term ‘Lower Marine.’ It may be traced to the eastward beneath the *freshwater marls* to about 300 yards from Mead-end, where it is lost beneath the shingle of the beach. It cannot be considered as a true freshwater deposit, having from its organic contents as much claim to be regarded of marine origin as the so-called ‘Upper Marine’ of the Isle of Wight.”

In the remaining portion of this paper, my father proceeded to combat Sir Charles Lyell’s third conclusion, that the white sand of Beacon and Barton Cliffs must be referred to the Freshwater formation; and also his fourth conclusion, that although the shells of Hordwell Cliff belonged exclusively to the Lower Freshwater formation, yet it might be a question whether the organic remains were not of a mixed nature—conclusions not entertained now by geologists;—and to describe the vertebrate and molluscan remains collected by him from the Lower Freshwater of Hordwell Cliff.

I now subjoin so much of the letter of Mr. Keeping to this MAGAZINE, of September last, as impugns my father’s description; having placed in italics the statements in that letter, and those in my father’s paper, that conflict. The statements in Mr. Keeping’s letter (no locality being named) could be reconciled with my father’s statements in no other way than by supposing Mr. Keeping to refer to the Mead-end bed.

<sup>1</sup> I have not been able to find *Pleurotoma*, *Sanguinolaria*, or *Cytherea* among the shells of this (Mead-end) bed.—S.V.W.

<sup>2</sup> By this is meant the Barton Clay, as explained in note *ante*.—S.V.W.

“In the discussion upon the paper ‘On the Section at Hordwell Cliff from the top of the Lower Headon to the base of the Upper Bagshot Sands,’ by the late Mr. E. B. Tawney and myself, which was read before the Geological Society, June 28, 1883, Prof. Judd is reported to have said: That the paper seemed to be a critical one, and the criticism was rather of the nature of a statement that the authors had not seen what several distinguished observers such as Mr. F. E. Edwards, Mr. Searles Wood, Dr. Wright, and others, stated they had distinctly seen. . . . Now I wish to assure Prof. Judd that my memory does not fail me, and that I have seen the fossiliferous patch of stuff in question many hundreds of times *just in the same position as Mr. S. Wood*, Mr. Edwards, Dr. Wright, and the Marchioness of Hastings had seen it, and I always believed it to be *nothing more than a slipped mass*, which I subsequently obtained complete proof that it was.

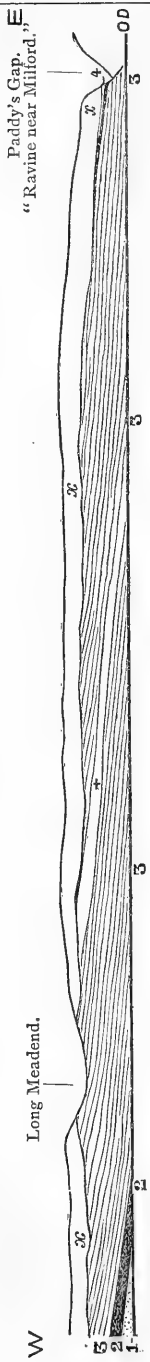
“The patch in question when described by Mr. S. Wood was only to be found *close to the beach just above high-water mark, and only extending some 20 yards in length, and 9 inches in thickness*. . . . I succeeded in finding the bed from which the fossils had come, *in situ*, just in the sequence as I had always expected to find it, namely, close under the gravel with all the Lower Headon Freshwater beds below it, showing clearly that *all* the previous authors were wrong in putting *these* freshwater beds above it. . . . The bed in dispute I wish to be distinctly understood to maintain is the Marine Middle Headon of the Geological Survey, and equivalent to the *Middle Headon* of Colwell Bay, *Headon Hill*, Whitecliff Bay, and Brockenhurst in the New Forest.”

Mr. Elwes writes in the November Number of this MAGAZINE by the request of Mr. Keeping to say, that he and a party under Mr. Keeping’s direction, had opened the bed on the west side of Paddy’s Gap (the ravine near Milford referred to by my father), and found it *in situ* 13 feet above the shore, consisting of from 1 foot to 1½ of sand and comminuted shells, estuarine and marine, immediately overlain by whitish sand of similar thickness, beneath 26½ feet of gravel and soil, and resting on light green clayey sand in which specimens of *Paludina* and *Unio* were found; adding that about a third of a mile to the east, near Westover Lane-end, there is a slight upthrow showing the *Unio* bed, and about 10 feet of the underlying green clays; and that it was under this that the previous writers had placed the Middle Headon marine bed, instead of above it.

Mr. Elwes was good enough to send me the rough section which is given *in fac simile* in cut No. 2, in explanation of this; and I have added cut No. 1 to show the section of the entire cliff, from this point westwards to beyond Meadend, prepared from sections made by myself nearly 40 years ago, and connected by description with the vertical section given by Messrs. Keeping and Tawney in their paper giving rise to the discussion<sup>1</sup> (but which was not published till after both my article in the November, and letter in the December Number, of this MAGAZINE were in print); and I think that I need not add anything to the above to make the whole case intelligible, and show how utterly my father’s statements have been misrepresented, and how the excavation made has confirmed his description in every particular, but carried the subject no further. The party have found the marine bed overlying the Lower Freshwater, *as he did, in situ* (and not as a *slipped mass close to the beach*, as Mr. Keeping made out), and at a height above the shore, which they estimate at 13 feet, instead of the 10 to 12 at which he estimated it; but as regards the Freshwater beds to the east of it, which

<sup>1</sup> Quart. Journ. Geol. Soc. vol. xxxix. p. 574.

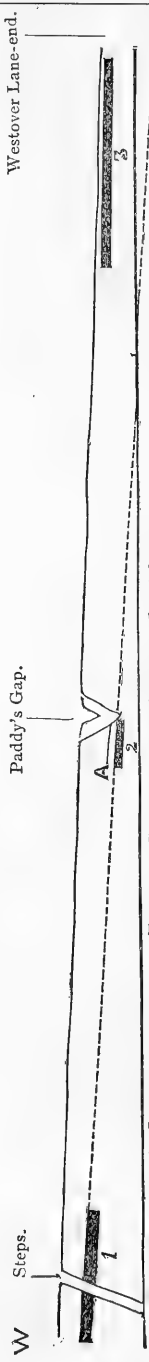
FIG. 1.—HORDWELL CLIFF.  
LENGTH OF SECTION, 12 FURLONGS, VERTICAL SCALE 8 TIMES THE HORIZONTAL.



1. White unfossiliferous sand intervening between the Barton Clay and bed No. 2 (This is *g* of Messrs. Keeping and Tavney's vertical section in O. J. G. S., vol. 39, p. 575, and "Sands" of Prof. Judd's vertical "New Forest" Sect. in vol. 36, p. 170).  
 2. The Long Meadend bed (This is *a, b, c, d, e & f* of K. and T.'s section, but not shown in Prof. Judd's) "Lower Marine" of my father—fluvio-marine.  
 3. The Lower Headon (1 to 33 of K. and T.'s section and "Lower Freshwater" of my father)—Freshwater.

4. The "Upper Marine" of my ather; "Middle Headon" of Mr. Keeping "Marine band" of Prof. Judd—Marine with some freshwater shells.  
*x* Newer Pliocene gravel. The Cross denotes the place and position from which were obtained the Mammalian, Avian, Reptilian, and Fish remains referred to in my footnote at p. 496 of Vol. X. of this MAGAZINE, the bed yielding them being No. 15 of K. and T.'s section.  
 o. d. Ordnance datum line.

FIG. 2.—SECTION FURNISHED BY MR. J. W. ELWES.



*Unio bed* ———— Its position according to the dip

1. Same as seen by the steps. 2, as in our pit. 3, opposite Westover.

my father considered might be Upper Freshwater only from their eastward position (pointing out that the shells in them were the same as in those beneath the marine bed), they have shown nothing beyond, or contrary to, what he stated; and it is obvious that it will require further excavations between the two points to determine whether the Freshwater beds a third of a mile to the east are, or are not, beneath the marine bed which this party opened. If such be done, and Mr. Keeping's view that they are beneath it is confirmed, this, so far from showing my father to have been wrong, will show him to have been right in so cautiously guarding himself against any more positive assertion as to the geological position of these freshwater beds to the east of the ravine, than appears from the extracts which I have given from his paper.

---

IV.—ON THE CAUSES OF CHANGE OF CLIMATE, FROM WARM TO COLD, AND COLD TO WARM, DURING LONG PERIODS, AND ALSO OF COINCIDENT CHANGES OF THE FAUNA AND FLORA.<sup>1</sup>

By JOHN GUNN, M.A., F.G.S.

**I**T is a trite observation that truths which lie at our feet may be overlooked by the wise, and discovered by mere accident, or the chance step of some casual passer-by.

This appears to be the case with the phenomena of the so-called Glacial epoch, and the causes of the change of temperature on the earth's surface. The depth and the height of science have been searched through heaven and earth, while the grand and simple agency of nature, which has been operating alike through all time, may have been overlooked, or not duly consulted.

To enter upon the subject at once: it may be asked, if the elevation of mountain ranges be productive of cold, why may not the converse be true, and the wearing down and levelling of those heights be the cause of a warm temperature?

This is not a matter of conjecture, but from its very nature it ought to be a subject of observation, and to admit of actual verification.

In pursuing this inquiry, it is not necessary to enter into the question, how the inequalities of the earth's surface may have originated, nor to refer to astronomical agencies, such as the Precession of the Equinoxes, which are perpetually and uniformly at work alike under all conditions of elevation or depression; but I will claim in support of my proposition, the effect produced by the alterations of the course of the Gulf Stream, through changes in the level of the land, and also by the transport and melting of icebergs and glaciers.

With these provisos, I will commence my observations with the Carboniferous epoch. There is evidence of a quiescent state during which coal was deposited. Not a single instance, that I am aware, can be adduced of the occurrence of bouldered rocks, certainly not of

<sup>1</sup> A Paper read before the Geological Section of the Meeting of the British Association at Southport, 1883.

ice-scratched boulders, in the Coal-measures; but a mild and sub-tropical climate seems to have prevailed.

If we pass on to the Permian, the change both of Fauna and Flora appears to be coincident with that of the level of the land. A great and general disturbance took place, and glaciated and striated rocks prove the reality of a Glacial period. This was first observed and announced by Professor Ramsay. It was exposed in many places to such an extent as to excite surprise that it had not been noticed before.

From that epoch, to and throughout the Oolitic, a gradual and general levelling took place, and no striated boulders nor any indication of ice-action have been discovered.

If in the Chalk, as pointed out by Mr. Godwin-Austen in his elaborate treatise<sup>1</sup> a mass of granitic rock has been found at Croydon imbedded, it exhibits no more than the wasting of the land by floods, or inroads of the sea, or it may have been carried, as he suggests, by sea-coast ice from Polar regions, but such masses are rounded and afford no proof of local glaciation.

In no parts of this country, we might say of Europe, are there equal facilities offered for observation, as in the eastern counties of England, and this arises from the continuous and unbroken succession of the strata: consequently the relations of cause and effect are very minutely and extensively disclosed, and we cannot fail to see how changes of climate and of the Fauna and Flora follow step by step on the elevation or depression of the land.

It can be demonstrated that throughout the Norwich Crag series, and the Stony-bed, which dates from the surface of the Chalk, to the present day, and through the Forest-bed series, the Laminated series, which includes the Chillesford clays and sands, and through the Westleton beds, and the entire Quaternary formations commencing with the lower Boulder-clay, and ending with the Post-Glacial deposits, all the changes of climate and of fauna and flora have gone *pari passu* with the changes of the level of the land.

Thus the *Mastodon arvernensis*, whose remains are found in the Bone-bed in Suffolk beneath the Red Crag, and in the Stony-bed beneath the Norwich Crag, occurs in certain Antwerp-beds at a lower level than that in which the remains of *Elephas meridionalis* are found.

That Elephant succeeded the *Mastodon arvernensis*, and appears in the Estuarine-bed of the Anglo-Belgian basin without the Mastodon, which had ceased to exist in that district at least.

A change of level then took place; the Forest began to grow upon *terra firma*, and there was a concurrent change in animal life; the *Elephas meridionalis* either disappeared altogether, or else the rugosity of the enamel-plates was so modified, and the number increased, as to be scarcely recognizable.

Another and distinct species, or rather form of Elephant appeared. This was named by Dr. Falconer *E. (Euelephas) antiquus*, and it is supposed to have undergone many variations with respect to the

<sup>1</sup> Quart. Journ. Geol. Soc. vol. xiv. p. 252.

width of the teeth, as observed by the late Professor Leith Adams, (Palæont. Monograph, *E. antiquus*, p. 31) during the Forest-bed series.

The effect produced by the continued upraising of the bed of the Estuary is very remarkable. As its result, we have on one side the remains of an Estuary without a river, and on the other side the remnant of the magnificent Rhine without its Estuary.

The extent to which this severance of the estuary from the river has been carried through the elevation of the land is truly marvellous. This is shown by the dispersion of Elephants and other animals on either side.

Prof. Goldfuss, of Bonn, has noticed several teeth derived from a diluvial deposit on the banks of the river Ruhr in Westphalia, with well-marked rhombs, similar to those of the existing African elephant,<sup>1</sup> and he inferred thence that the valley of the Rhine was formerly inhabited by a species of Elephant, which more nearly resembled the existing African species than the *E. primigenius* does the existing Indian.

A tooth of the *Elephas (Loxodon) priscus* is also mentioned by Dr. Falconer, *loc. cit.* p. 96, to have been derived from Gray's Thurrock, in the valley of the Thames, differing slightly from the *E. Africanus*, and another found on the beach at Palling on the Norfolk coast, described by him, *loc. cit.* pp. 98 and 99; a third from the Stony-bed at Horstead, now in the Norwich Museum, and also a well-pronounced specimen in Mr. Savin's Collection; these all prove the same or a very similar species of Elephant to have existed on either side of the valley of the Rhine.

We may go far beyond these limits, and observe that these fossil remains are found not only on both sides of the Rhine-valley, but also beyond the Alpine mountain ranges intervening.

There is an unquestionable correspondence, I might say identity, between the fossil remains on the west and on the east side of the Alps and Sub-Apennines. At the Museum of Florence there are magnificent specimens of the *E. meridionalis* rivalling those of our Forest-bed, associated with the *E. antiquus*, so that I could not but feel quite at home there, and that I was treading on like ground to that of my native country. This coincidence is not confined to one single district beyond the Alpine regions; when at Rome, Mr. Ponzi showed me, among other teeth, one which resembled those of the intermediate *Elephas giganteus*, found at Mundesley, in Norfolk. At Monte Mario, near Rome, I obtained a specimen of the *E. meridionalis*, which I placed in the Norwich Museum. Thus these denizens of the Forest-bed, with which we are so familiar, are found on the other side of the Alpine ranges in like abundance, and of the same colossal stature.

A question arises, how could they have crossed those mountains supposing they were raised to their present height? Judging from accounts given of their powers of locomotion in India, there can be little doubt that the height alone would have offered no obstacle, but

<sup>1</sup> Fauna Antiqua Sivalensis, vol. ii. p. 64.

the increasing cold, arising from the elevation of the land, would not only have prevented their passage over, but have caused the extermination of all the Elephants, except indeed the *E. antiquus* and *E. primigenius*.

With respect to the Molluscs, the same story is told by them. Sir C. Lyell<sup>1</sup> has identified specimens from the Red Crag at Walton-on-the-Naze, in Essex, with some now living in the Mediterranean, and the *Cyrena* or *Corbicula fluminalis*, once common in the Norfolk Crag-beds, is now not to be found nearer than in the warm waters of the Nile.

It thus appears that both Mammals and Molluscs have had an extensive range before the mountain heights were upheaved, and intercommunication cut off. It may seem startling to affirm that the Alps have been interposed at so late a geological period. We are accustomed to regard them as monuments of the highest geological antiquity, on account of their sub-strata of Primary rocks; but nevertheless, as Sir Roderick Murchison has shown<sup>2</sup> in his able paper on the "Structure of the Alps," they have been comparatively recently elevated, so that not only Miocene, but Pliocene formations rest upon their present summits; and probably still more recent deposits have been laid upon them, and have been worn down by the process of glaciation.

The effects produced by the elevation of the Alpine ranges is obvious. The extreme cold induced culminated in the almost entire change of the fauna. The *Elephas primigenius* and the *Rhinoceros tichorhinus* survived and superseded the other and more southern types; the *Cervus elephas*, *C. tarandus* and the *C. capreolus* survived the profusion of Deer whose remains are yielded by the Forest-bed, and also a host of other Mammals, which succumbed to the cold.

The Glacial epoch, so called, was thus introduced, and the mountain heights, when they attained their highest point of elevation, spread their refrigerating influence far and wide by an ice-sheet, or glaciers, descending into the plains. This was necessarily limited by, and proportioned to the degree of latitude, while near to the Pole, the ice would be continuous, and icebergs, carried down into the sea, would extend the cold into otherwise warmer regions.

The reality of this cause of cold is best shown by the effect produced by the opposite system of depression and the gradual diminution of the regions of perpetual ice and snow.

Every traveller in Switzerland, Savoy, Italy and Greece remarks the traces of former glaciation and of retreating glaciers. In France the return to a genial climate is evident, as in Dordogne, where the Reindeer and the *Elephas primigenius* once lived, and have left their relics, and their unmistakable portraits, or figures carved by the hands of former natives.

Such are some of the indications of the change of climate from cold to warmth due to the gradually diminishing height of mountain

<sup>1</sup> Elements of Geology, p. 207, 6th edition.

<sup>2</sup> Quart. Journ. Geol. Soc., vol. v. p. 244.



ranges; and there is no reason to doubt but that, if the depression continued in a sufficient degree, there would be a return to the temperature of more genial periods, to the Purbeck or the Oolite; or on the contrary, if the engine may be said to be sufficiently reversed, there would be a return to the Glacial epoch.

The most remarkable evidence to this effect may be adduced from the variations of the course of the Gulf Stream.

Mr. William Hopkins shows<sup>1</sup> that the present Gulf Stream flowing through the Straits of Bahama, and thence in its north-eastern direction towards the North Sea and the coasts of Europe, is a current reflected from the shores of the Gulf of Mexico, in consequence of the impossibility of its continuing the north-western course by which it reaches the Gulf. In his masterly paper he proves that its course has not always been, as at present, through the Straits of Bahama, and that it would not continue to be so, if a depression of the North American Continent to the amount of 2000 feet were to take place; that such a depression would convert the valley of the Mississippi into a great arm of the sea, of which the present Gulf of Mexico would form the southern extremity; and which would communicate at its northern extremity with the waters occupying the submerged district, which he described as the great valley now occupied by the chain of lakes. A direct communication would be thus produced between the Gulf of Mexico and the Arctic Sea along the eastern base of the Rocky Mountains.

Such would be the necessary consequence of this submergence, and further Mr. Hopkins affords a very strong proof that such a course of the Gulf Stream has actually existed between the Gulf of Mexico and the regions of North America by the discovery made by Professor E. Forbes of plants which belong to the Pleistocene period along the flanks of the Rocky Mountains, and between them and Hudson's Bay, being the very region in which the temperature would be expected to be affected by the warm current from the Gulf of Mexico.

Such, no doubt, has been the effect produced by the change of level of the North American Continent, and it is a striking fact that this altered current of the Gulf Stream would have flowed in the direction of Melville Island, the Miocene coal-bearing country in the Arctic regions.

I do not mean to affirm that this extraordinary phenomenon would be thus satisfactorily accounted for, but the conjoint actions of depression of the land and influx of the Gulf Stream appear to offer an explanation of this most extraordinary phenomenon of the existence of a Miocene flora in so northerly a latitude. Without this joint agency, we may affirm that no change in the configuration of land and water, so ably advocated by Sir C. Lyell, could have produced that effect.

In addressing the Members of the British Association, I have not thought it necessary to enter more fully into the particulars of the changes of level and climate during the several periods mentioned.

<sup>1</sup> Quart. Journ. Geol. Soc., vol. viii. p. 89.

I hope I have pointed out sufficient to prove that the relation between cause and effect is borne out, as I proposed to show, and that the levelling of mountain ranges may on good grounds be considered to be the cause of warmth of climate, just as their elevation is productive of cold.

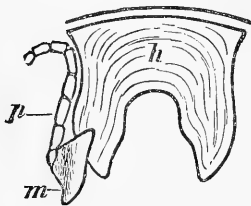
## V.—ON THE STRUCTURE OF TRILOBITES.

By HENRY WOODWARD, LL.D., F.R.S.

IN the GEOLOGICAL MAGAZINE for July, 1871, Plate VIII. pp. 289–294, I published an article on the above subject, giving my views of the appendages of Trilobites, and reproducing the figure of *Asaphus platycephalus*, Stokes, showing traces of eight pairs of locomotory appendages, discovered by Mr. Billings in the Trenton Limestone, city of Ottawa, and described and figured by him (in Quart. Journ. Geol. Soc. 1870, pp. 479–486, and plates xxxi. and xxxii.). I also appended a note to Mr. Billings's paper (*op. cit.* 1870, pp. 486–488) on a palpus of *Asaphus* from the same locality, which is as follows:—"Having been requested by Sir William Logan to examine the Trilobite sent over by Mr. Billings from Montreal, I was led to compare it with certain specimens in the British Museum collection, presented by Dr. J. J. Bigsby, F.R.S., some years since.

I was at once attracted by a specimen of *Asaphus*, from the Black Trenton Limestone (Lower Silurian), which has been much eroded on its upper surface, having the hypostoma, and what appear to be the appendages belonging to the first, second, and third somites, exposed to view, united along the median line by a longitudinal ridge.

Buccal organs of *Asaphus platycephalus*, Stokes.



*h.* hypostome ; *p.* palpus ;  
*m.* maxilla.

The pseudo-appendages, however, have no evidence of any articulations. But what seems to me to be of the highest importance, as a piece of additional information afforded by the Museum specimen, is the discovery of what I believe to be the *jointed palpus* of one of the maxillæ (Fig. 1), which has

left an impression upon the side of the hypostoma—just, in fact, in that position which it must have occupied in life, judging by other Crustaceans which are furnished with an hypostoma, as *Apus*, *Serolis*, etc.

The palpus is 9 lines in length ; the basal joint measures 3 lines, and is 2 lines broad, and somewhat triangular in form.

There appear to be about seven articulations in the palpus itself, above the basal joint, marked by swellings upon its tubular stem which, is one line in diameter.

There can be no reason to doubt that the Trilobita possessed antennules, antennæ, mandibles, maxillæ, and maxillipeds, as we find

the same organs preserved in Crustacea of equal antiquity (e.g. *Slimonia acuminata* and *Eurypterus remipes*, both Upper Silurian forms).

We know of no Crustacean having *two pairs* of appendages to each segment; but it is characteristic of Crustacea to have their appendages *bifid*, giving rise to an *endopodite* and an *exopodite*, but these are always given off from a common base (*basipodite*).

Having regard to the characters presented by the Trilobita as a group, we should be inclined to place them *near to* (if not actually in) the Isopoda-Normalia. In all this group, the branchiæ are abdominal, being placed under the broad and well-developed pygidium, which is not equivalent to the telson of the higher Crustacea, but is composed of several segments soldered together, in fact, representing the true abdomen. It is here, then, we should expect to find the branchiæ in the Trilobites placed, and not upon the epimera of the body-segments.

If any objection should be urged against the organs observed in the specimen in the British Museum being really legs, I would suggest that they may be considered good evidence of the presence of these organs, and that they probably represent the apodemata, or infoldings, of the hard external crust to which those organs, or the muscles by which they are moved, were attached.

The prominence of the hypostome in the Trilobita reminds one even more strongly of the genus *Apus* than of the *Isopods*; and it is quite reasonable to expect, in the Trilobita, a more generalized type of structure than that which marks the modern (and more specialized) representatives of the class.

The question will naturally be asked why so many specimens of Trilobites should be found, yet no trace of limbs. It seems reasonable to infer that a large number of these fossil remains are only *exuvia*, the Crustacea frequently casting their shells. The detachment of the limbs is also a common occurrence in all the fossil Articulata, especially, where, as in the Crustacea, the proximal joint is extremely constricted, and, in consequence, easily disarticulated.

Nor need we assume that all the genera of this very extensive family had horny chitinous limbs, seeing that in the modern Isopoda a great diversity exists in these organs.

The publication of Mr. Billings's discovery appears to me to be of the highest importance to palæontologists; and he is entitled to our best thanks; for his observations are sure to excite further researches upon the Trilobita, and thus will be the means of greatly increasing our knowledge of this interesting group."

It is not a little singular that the writer of the subjoined article should have met with a specimen of *Asaphus* broken open and displaying the same characters, but, if possible, more clearly than in Mr. Billings's specimen already noticed. We give the paper as it stands.

---

VI.—LOCOMOTORY APPENDAGES OF TRILOBITES.<sup>1</sup>

By JOHN MICKLEBOROUGH, Ph.D.

Principal, Normal School, Cincinnati, Ohio, U.S.A.

THE discoveries and investigations of palæontologists touching the question of ambulatory and branchigerous appendages of the Trilobites have been entirely ignored by many of the ablest workers in the science. The important evidence which Mr. Billings produced was unsatisfactory to both Dana and Verrill. In 1881, after many years of untiring labour, Mr. C. D. Walcott (in the "Bulletin of the Museum of Comparative Zoology at Cambridge College") furnished most conclusive proof of the existence of *appendages* to the *cephalic*, *thoracic*, and *abdominal* divisions of *Calymene*, *Ceraurus*, and *Acidaspis*. He says: "the discoveries have been received in about the same manner" as those of Billings and others—with incredulity, and as "having little value."

To confirm the conclusions of these naturalists, who have affirmed the existence of Trilobite legs, and possibly shed some light on the character of the ventral surface of these crustaceans, and thereby aid in the determination of ichnological specimens, is the object of the writer. The conclusions here reached are based upon the work of predecessors, and the specimens of *Asaphus megistos*, which were found by Mr. James Pugh (they now belong to Mr. David McCord), two miles north of Oxford, Ohio, in the upper portion of the Hudson River Group.

Although Ch. Mortimer, as early as 1750, and Linnæus, in 1753, had determined the crustacean character of the Trilobites, at least, in zoological affinities, they were placed with *Limulus*, yet more than a century elapsed before any discovery of feet or antennæ was made. In 1864, Mr. Billings discovered the presence of legs in a specimen of *Asaphus platycephalus*, from the Trenton Limestone of Canada.

To show the distrust in the minds of naturalists, we quote from the pamphlet of Mr. C. D. Walcott, page 196: "The instances of the discovery of the animal other than the dorsal shell and hypostoma are rare. M. Barrande, in reviewing the reported discoveries made of the appendages of the Trilobites to the date of the publication of his volume i. 1852, says: 'Unhappily, all the researches have resulted in nothing more than the discovery of the pieces of the mouth named hypostoma and epistoma, and the intestinal canal.' Again, in his supplement to volume i., 1872, he says: 'The few scattered observations of parts found which might belong to the Trilobites have little value, and were accepted as such by naturalists.'"

In 1872, Dr. A. S. Packard, in his work on the Development of *Limulus polyphemus*, page 185, says: "Though disposed to regard the processes figured by Mr. Billings as feet, still the proof is unsatisfactory. The Trilobites probably had habits similar to those of

<sup>1</sup> From the Journal of the Cincinnati Society of Natural History, vol. vi. 1883.

Since printing this Dr. Mickleborough has most obligingly announced that he has despatched clichés of his illustrations, which we hope to give in our next Number.—  
EDIT. GEOL. MAG.

*Limulus*, and consequently they must have had ambulatory feet, rather than phyllopodal feet, attached to the middle segments of the body. In view of the conflict of opinions as to the nature of the limbs of the Trilobites, it is to be hoped that the matter will not be suffered to rest here by palæontologists, even if the most unique and valuable specimens have to be sacrificed in making the requisite observations."

In 1874 Mr. S. A. Miller figured and described, in the Quarterly Journal of Science, an ichnolite which he regarded as the track of *Asaphus*. In 1880, he reviewed the work of 1874, and figured and described another slab, the markings of which he regarded as made by an animal generically related to the former.

In 1875, Prof. Dana, in his Manual of Geology, page 123, says: "No remains of legs are found with any Trilobites."

In 1876, Dr. Nicholson, in his Manual of Zoology, page 219, says: "No traces of ambulatory or natatory limbs, of branchiæ or of antennæ, have ever been discovered. On the under surface of the body nothing has hitherto been discovered except the hypostoma or labrum. It has generally been supposed that the axial lobes protected a series of delicate respiratory feet; but this view is doubted by many authorities, and the question is one which we have at present no means of deciding."

In 1878, Prof. Huxley, in his Anatomy of Invertebrate Animals, page 220 (Am. Ed.), says: "Limbs or appendages capable of effecting locomotion are always attached either to the head or to the thorax—the extinct Trilobites possibly form an exception to this rule." Again, page 224: "Now, among the water-breathing Arthropoda no trace of limbs has yet been certainly discovered among the Trilobites."

In the Encyclopædia Britannica, ninth edition (*vide* Crustacea), Dr. Henry Woodward, F.R.S., says: "At present more evidence is needed as to the nature of the locomotory appendages of this extinct group—Trilobita."

In a letter from Mr. C. D. Walcott, dated June, 1883, he states that all his recent sections "simply corroborate the views given in his pamphlet of 1881."

These numerous references and quotations are given to show the distrust and uncertainty in the minds of prominent naturalists as to the limbs of the Trilobites.

In the autumn of 1882 a specimen of the Trilobite, *Asaphus megistos*, was sent me for examination. In the delay of correspondence with palæontologists, fortunately, no report was made, for in the spring of 1883, twelve months after finding the first specimen, the same party found the second, which proved to be the matrix of the ventral surface of the first specimen. It was found about one hundred mètres from the point where the first was obtained.

About two-thirds of the cephalic shield is broken off. That part of the head anterior to a line drawn obliquely through the left eye to the middle of the pleura of the second thoracic somite on the right is entirely wanting. With the head restored, the specimen would be

about 18·5 centimeters ( $7\frac{3}{8}$  inches) long; in width 11·5 centimeters (about  $4\frac{1}{2}$  inches). On the ventral surface a broad median *groove* extends along the concavity of the thorax and abdomen. It begins at a point beneath the articulation of the head with the thorax, or in the posterior part of the area between the lobes of the hypostoma. Its length is 10·5 centimeters ( $4\frac{1}{8}$  inch)—6·5 centimeters being the length of the thoracic, and four centimeters that of the abdominal portion of the groove. This specimen clearly demonstrates the *concavity* of the three principal divisions of the *Asaphus*, a fact which Mr. Billings pointed out in 1864. The vertical distance from the dorsal surface of the head to a line in the plane of the external margins of the pleuræ is 2·5 centimeters (about one inch).

Directly beneath the eight somites of the thorax, *ten* pairs of jointed limbs are distinctly seen; the two anterior pairs of appendages are situated directly under the first two thoracic segments; but from the character of these appendages, as well as the relation of parts, these, while having the general appearance of organs of locomotion, yet were, no doubt, maxillipedes with the basal joints articulated to the body of the animal, near the point where the oral aperture certainly existed, and presumably they were differentiated to perform the function of mouth organs, and consequently should be considered as belonging to the cephalic division. The remaining eight pairs of legs are then directly referable to the eight thoracic somites. The number of joints in a limb cannot be definitely given from a study of these specimens; the basal joints are not preserved at the median groove.

Following the terminology of Milne-Edwards for the several parts of the limb of a crustacean, the prominently-marked portion of these ambulatory limbs is undoubtedly the meropodite, which was in some cases two centimeters in length and quite large, with the merocarpopodite articulation well pronounced, so as to leave a distinct, pit-like depression in the matrix. The several joints externally to that which is considered the meropodite can be distinguished by careful study of the several legs and the grooves and foveæ of the matrix. The carpopodite was about the length of the meropodite, but decidedly slender as compared with the latter. If there was any positive evidence to show that these were broad, lamellar appendages, adapted to swimming, then the slender joints external to the meropodite might be accounted for by supposing the edges were the portions visible. The propodite was about two-thirds the length of the carpopodite, and also appears to have been slender and slightly curved backward; the dactylopodites are not well preserved, yet sufficiently so to permit the conclusion that they were not chelate. The posterior pair of these thoracic appendages is directly beneath the posterior somite of the thorax. The meropodites of the two anterior pairs of appendages resemble the same joints in the thoracic limbs.

In examining the matrix, where the left limb of the anterior pair is well preserved, it is seen to curve around the outer margin of the left lobe of the hypostoma, and from the evidence which the surface

presented when first examined, I am of the opinion that this limb was chelate. In removing the limestone so as to expose the left lobe of the hypostoma, and also establish the articulation of the claws, an accidental stroke destroyed the evidence of this direct connection, yet at the fracture the ends of two broken claws can yet be seen. At first I was disinclined to regard the distal extremity of this pair as chelate. Before attempting to remove the limestone, the surface clearly showed a conjunction of these parts. This condition could have been accounted for by supposing one limb to have been thrown over another. It was to clear up this point that the removal of the adhering material was made. If chelate, the claws were slender and of about equal size as in *Limulus*. As the hypostoma is frequently found in this limestone formation, it is to be hoped that these limbs will also be found, so as to definitely settle this point. On fitting the two specimens together, the ends of these supposed claws are seen at the fracture directly beneath the left eye. These specimens demonstrate that the thoracic appendages were well developed walking legs, extending nearly to the outer margins of the carapace. The exoskeleton of the limbs seems to have been somewhat different in character from the calcareous exoskeleton of the dorsal surface of the animal. At least, it was of such a character as not to preserve well the integrity of the parts in the process of fossilization. They could not have been soft and yielding, judging from the symmetry of the matrices of the meropodites, as well as from the general cylindrical character of limbs themselves.

On the ventral surface of the pygidium there are at least twelve (pairs of) appendages; posteriorly, an exact enumeration is impossible. The term *pairs* is used on account of the median groove, showing in the structures a bilobed character. This groove is continuous with the thoracic groove, and is somewhat narrower and more shallow than the latter. From an examination of the two specimens, these twelve or more appendages appear to be leaf-like, or foliaceous, and on each side of the median groove the direction was outward and somewhat forward. No doubt these appendages were branchial in function, and also adapted to swimming.

These specimens will prove of interest to zoologists, especially from a taxonomic point of view. Spence Bate and Henry Woodward, of England, and Prof. Dana, of this country, regard the *Trilobites* as closely related to *Isopoda*. Woodward homologizes thus:

TRILOBITA (fossil or extinct).	ISOPODA (fossil and living).
1. Eyes sessile, compound.	1. Eyes sessile, compound.
2. No ocelli visible.	2. No ocelli visible.
3. Appendages partly oral, partly ambulatory, arranged in pairs.	3. Appendages partly oral, partly ambulatory, arranged in pairs.
* 4. Thoracic segments variable in number, from six to twenty-six, free and movable; animal sometimes rolling in a ball.	* 4. Thoracic segments usually seven, free and movable; animal sometimes rolling in a ball.
5. Abdominal somites coalesced, forming a broad caudal shield (bearing the branchiæ beneath?)	5. Abdominal somites coalesced, forming a broad caudal shield, bearing the branchiæ beneath.
6. Lip-plate well developed.	6. Lip-plate small.

\* Incorrectly printed in Dr. Mickleborough's pamphlet, corrected from original Article (*Crustacea*) in *Encyclopædia Britannica* (9th Edition, p. 660, Vol. VI.).—H.W.

If the conclusions herein expressed in the interpretation of the abdominal appendages of *Asaphus megistos* are correct, then the mark of doubt in No. 5 of Woodward's homological table may be removed.

Prof. E. Van Beneden, of Belgium, believes the *Limuli* are not Crustaceans, and, from a study of their embryology, concludes that they cannot be separated from scorpions and other arachnida. This view, in which he is not alone, if correct, would carry the Trilobites out of the class of Crustacea.

Dr. Packard, in his excellent work on the "Development of *Limulus polyphemus*," places the Xiphosura and Eurypterida as suborders under the order Merostomata, which is followed by Trilobita as a separate order. This view is accepted by Dr. Lockwood and Mr. C. D. Walcott. It remains for zoologists to place whatever value may attach to the fact of the appendages of Trilobites subserving the purposes of *branchial* organs, of *manducation*, and of *locomotion*, either ambulatory or natatory.

---

## NOTICES OF MEMOIRS.

---

### THE GEOLOGICAL COMMITTEE OF RUSSIA.

THE recent arrival in this country of the first Reports of the Geological Committee of Russia furnishes some information regarding that body. It was instituted in 1882 by order of H.I.M. the Czar, under the Ministry of the Domains of the Empire, their centre being the Institute of Mines, St. Petersburg. The Committee has been formed for the purpose of studying systematically the geological constitution of Russia and for the construction of a detailed geological map of the Empire.

Besides the 8vo., Reports referred to, Memoirs will be published in 4to. illustrated by plates and maps, the first volume of which is now in the press. The Committee are desirous of exchanging these with the geological publications of other countries.

The staff consisted when established of a Director, three Senior Geologists, three Junior Geologists, and a Curator.

The first volume of Nos. 1—6 of volume 2 of the Reports are unfortunately for many English Geologists printed in the Russian language, but the Committee propose to give a *précis* in French or German of their Memoirs as published. Besides the proceedings of the committee meetings, the Reports contain papers, mostly of a preliminary character, on work done in the field in 1882. They are as follows:—

In vol. 1, A. Karpensky, On the Origin of the Iron Ore of the Donetz Basin. In vol. 2, Nos. 1—6, P. Kroloff, Preliminary Account of Geological Investigations made in the Government of Perm; Th. Chernesheff, Account of Investigations on the Western Slope of the Urals; A. Shtookenberg, On Geological Investigations made in the Government of Perm; S. Neketen, On the Palæozoic Geology of Sheet 58 of the General Geological Map of European Russia (scale 10 miles = 1 English inch), containing Yaroslave, Rostof, Koliazin,



Vesegonsk and Poshekon; S. Neketen, Observations on the Use of the terms diluvium, alluvium and eluvium; V. Domger, Geological Investigations made in the Ekaterenoslav Government, etc.; E. Shmalgaozen, Observations on *Araucarites rhodeanus*, Goepf.; A. Krasnopol'sky, On Geological Investigations on the Western Slope of the Urals; F. Schmidt, Preliminary Account of Investigations on the Baltic Iron-ore Deposits; A. Michalsky, On Geological Observations made in the Kyleletz Government; and P. Armashesky, Account of Investigations made in the Poltava Government.

W. R. J.

---

R E V I E W S.

---

DR. REUSCH'S DISCOVERY OF SILURIAN FOSSILS IN THE HIGHLY ALTERED ROCKS OF BERGEN PENINSULA IN NORWAY.

DIE FOSSILIEN FÜHRENDE KRYSTALLINISCHE SCHIEFER VON BERGEN IN NORWEGEN VON DR. HANS H. REUSCH. AUTORISIRTE DEUTSCHE AUSGABE VON R. BALDAUF. (Leipzig, 1883.)

THE announcement of the discovery by Dr. Reusch of Silurian fossils in highly altered rocks has excited so much interest that a German edition of the work in which the details of the discovery are recorded will be heartily welcomed. The work in question consists of 134 octavo pages. It is illustrated by a coloured geological map and section, and by 92 excellent woodcuts. Whatever opinion the reader may form as to the correctness of some of the author's conclusions, he will readily admit that the work is a most valuable contribution to the literature of a branch of geological science which is at present very little understood.

After some general remarks on the geology of Norway, and on the difficulties which the field geologist has to contend with in consequence of the climate of the country and the sparseness of its population, the author proceeds to describe in greater detail the geological structure of the Bergen peninsula. The highest part of the peninsula lies to the east and attains in the Gulfjeld an elevation of 986 metres. It is composed of saussurite-gabbro and greenstone(?) and forms a zone of country which extends in the northern part in a north and south, and in the southern part in a north-east and south-east direction. To the south and east of this zone occur the crystalline schists which, in the neighbourhood of Osören, a town on the south coast of the Bergen peninsula, contain Silurian fossils. They comprise conglomerate, sandstone, micaceous clay-slate (Thonglimmerschiefer), with crystalline limestone, talc-mica-schist, hornblende-schist, gneiss, etc. Rocks of the same series occur at Trengereid in the north-eastern part of the peninsula, and probably also at Bergen, but the author has not discovered fossils in the latter locality. That part of the peninsula which lies between the area occupied by the Bergen schists and the zone of saussurite-gabbro is denominated by the author the Ulriken gneiss district. The dominant rock is gneiss in many varieties; sometimes fine-grained

and thinly-bedded, and at other times very massive with foliation, but no trace of bedding. The latter variety is denominated gneiss granite. Subordinate to the gneiss appear mica-schist, hornblende-schist, together with small masses of gabbro and diorite. In this district also occurs a remarkable labrador-rock. The prevailing strike in the peninsula is N.E. and S.W.; the most important exception to this rule being in the immediate neighbourhood of Bergen, where the strike curves round so as to form a semicircle. The dip varies in different localities. In the neighbourhood of Bergen the beds lie at low angles, but over the larger portion of the peninsula they are either vertical or highly inclined to the N.W. or S.E.

The neighbourhood of Osören is then referred to in great detail. For purposes of description the district is divided into five zones which succeed each other from S.E. to N.W. in the following order:—

(1) The low plateau which lies between the elevated country, composed mainly of saussurite-gabbro, and the shore of the Fusefjord.

(2) The zone of saussurite-gabbro.

(3) The quartzite-conglomerate zone consisting of quartzite-conglomerate, sandstone, micaceous clay-slate, with fossils, etc. The depression of the Tyssedal marks this zone to the N.E. of Ulven.

(4) A broad zone of elevated country composed of diorite and hornblende-schist with granite-gneiss. The rocks of the first three zones and those of the southern half of this zone dip at high angles towards the N.W.; those of the northern half of this zone dip in the opposite direction.

(5) The zone of the Lysekloster schists.

The rocks of these five zones constitute according to the author a continuous series. They are, if this view be correct, of Silurian age; at any rate, the clastic rocks and the contemporaneous volcanic products must be of this age. As the point is one of so much interest, it will be well to quote at some length from the descriptions of the principal varieties of rock. The materials of which the first zone referred to above is composed are very variable. On the S.E., that is on the shores of the Fusefjord, there is generally seen a quartz-bearing talc-mica-schist. The three constituents of this rock vary very much in relative abundance; sometimes the rock is a quartz-schist, at other times a true mica-schist. Bands of gneiss occur here and there. The quartz lamellæ are sometimes so small that they can scarcely be recognized; at other times they swell out into large lenticular bodies a metre in length.

Immediately over the talc-mica-schists occur a series of greenish rocks, in which hornblende plays the dominant, and felspar a secondary part. The names diorite, diorite-schist, hornblende-schist, and green-schist have been applied to varieties of these rocks.

Different members of this series vary very much in the extent to which foliation has been developed; some of the rocks having a massive habit. The rocks especially rich in hornblende frequently contain numerous layers of a fine-grained gneiss, poor in mica, which, as a rule, does not show foliation. The author is in doubt as to whether this is not an eruptive rock.

The rocks just described are succeeded by a very remarkable conglomerate, which deserves most attentive consideration. It contains pebbles of hornblende-bearing rocks, such as diorite and hornblende-schist, gneiss, granite poor in mica, an epidote-bearing rock and sometimes pebbles of quartzite and limestone. The rock has been subjected to great pressure, which has flattened the pebbles. Secondary minerals, principally mica and chlorite, have been developed. Sometimes the pressure has been so great as to roll out the pebbles into flat discs and thin lamellæ, and in these cases, if mica has been richly developed, the rock resembles a mica-schist. Its true nature, however, may be easily discovered by tracing it along the strike, when it will be seen to pass into an unmistakable conglomerate. In the neighbourhood of Mobergvold the junction of the conglomerate with the overlying rock, a quartz-augen-gneiss, is very sharp, and fragments of the latter rock occur in it. The lower part of the conglomerate has been here so metamorphosed by pressure, and by the development of secondary minerals, that at first sight one is disposed to regard it as a hornblende-schist. Even in true hornblende-schists, at least in rocks which the author under other circumstances would have no hesitation in classing under this head, there occur lamellæ which may be regarded as rolled-out pebbles. The quartz-augen-gneiss which succeeds the conglomerate is a very well characterized rock. The "eyes" consist of white granular quartz. The matrix is essentially composed of a clear greenish-yellow fine-grained or compact felspar. Large individuals with cleavage planes and twin striation may occasionally be recognized. The felspar contains chlorite scales, and sometimes plates of black and white mica. The chlorite and mica-scales bend round the "eyes" of quartz. The rock as a whole shows parallel structure, but not bedding.

The quartz-augen-gneiss is succeeded by another band of conglomerate, and over this second bed of conglomerate is the first zone of micaceous clay-slate with fossils. The last-mentioned rock is sometimes a dull slate (*Schiefer*), at others a black or grey glistening slate. The glistening varieties become more and more micaceous, and pass into a perfect muscovite-schist. The author has not definitely determined the species of mica; had he done so, he would probably have found it hydrous and of the nature of sericite. This slate (? schist) is always finely plicated and wrinkled, and sometimes several systems of folds may be seen crossing each other. Near *Indre Moberg* there occurs in this series a grey glistening schist which effervesces with acid. Macroscopically this rock is a micaceous clay-slate (*Thonglimmerschiefer*). Microscopically it is a fine-grained calcite-bearing gneiss. Layers of crystalline limestone occur associated with the micaceous clay-slate and in these cup corals, chain corals, and other traces of organisms have been found.

The fossiliferous beds are succeeded by chloritic sparagmit.<sup>1</sup> This consists of fragments of fine-grained greenish rocks, which are diffi-

<sup>1</sup> The term Sparagmit appears to be applied by Scandinavian geologists also to a quartz-felspar grit. Such a rock for instance as our *Torridon* sandstone.

cult to determine. It is full of chlorite, accompanied by some dark scaly mica. These minerals occur in the fragments as well as in the ground-mass. The chloritic sparagmit is followed by a narrow band of calcite-bearing gneiss, and then we come to the important zone mainly composed of saussurite-gabbro and amphibolite-schist.

(2) Zone of Saussurite-gabbro.

The predominant rock of this zone is especially characterized by the structure known in Germany as the *Riesen-flaser-struktur*. This structure is thus described by Credner: "An plumpe Linsen von körnigem, massigem bis flaserigem Gabbro und flaserigem Amphibolit schmiegen sich langgestreckt linsenförmige Schmitzen und Lagen von dünnschieferigem und langflaserigem Amphibol-schiefer an und erzeugen so die *Riesen-flaser-struktur*." Credner regards the Flaser-gabbro of Saxony as sedimentary and as a division of his granulite formation, which he also considers sedimentary. Naumann on the other hand regards both as eruptive. The author is not satisfied with either of these explanations. He uses the term gabbro to include true gabbro and coarsely foliated amphibolite schist, because these two rocks stand in such an intimate relation to each other in the Bergen peninsula and also in Saxony, that the separation of one from the other is only of interest from a petrographical point of view.

He then describes and figures several occurrences in Saxony which illustrate the intimate relations in question, and concludes that in order to account for them it is necessary to suppose that the rocks became plastic, not necessarily by heat, after the felspar and hornblende had been formed. He does not agree with Credner that the structures in question indicate a sedimentary origin, and states that similar structures may be observed in the undoubtedly eruptive post-Silurian syenite of Langesundsfjord.<sup>1</sup> The constituents of the saussurite-gabbro are next described.

The saussurite is a whitish finely crystalline or compact substance formed of epidote, zoisite, and here and there triclinic felspar. The second constituent is in many cases hornblende. Typical diallage and intermediate forms between diallage and hornblende also occur.

When considered in the light of Dr. Lehmann's more recent researches, it appears probable that the hornblende is almost, if not entirely, a secondary product. Evenly bedded rocks appear from the author's description to be exceptional in this zone: nevertheless they have been observed especially in the south-western area. The bedded structure is due to variation in the size of the individual con-

<sup>1</sup> The development of foliation, and other structures which especially characterize some of the crystalline schists in igneous rocks by combined chemical and mechanical agencies is a subject of great importance. It will be discussed by Dr. Lehmann in a work about to be published, entitled "Die Entstehung der atkrystallinischen schiefer-gesteine," of which a short notice has already appeared in the "Annales de la Société géologique du Nord, 1883," by M. Barrois. Dr. Lehmann treats especially of the Granulit formation of Saxony. He brings forward a large number of facts to show that the amphibolite schists above referred to are developed from the gabbro, an eruptive rock, by combined chemical and mechanical agencies, the amphibole being of course the metamorphosed representative of the diallage.

stituents, and also to variation in their relative proportions. One of the most beautifully bedded rocks described and figured by the author occurs near Skeie. The rock is a true olivine gabbro, and the bedding is due to the repetition of layers alternately rich and poor in olivine.

(3) Zone of quartzitic sandstone and quartzite-conglomerate with micaceous clay-slate.

The micaceous clay-slate is similar to that already described. The sandstone shows no special fragmental structure. It is often schistose, and then mica occurs on the divisional planes. This series is covered at Hagerik by hornblende rocks and granulit. At the junction there occurs a remarkable conglomerate 1 metre thick. The matrix is a greenish scaly chlorite, in which flattened pebbles of a compact rock with splintery fracture and a dirty yellowish-brown fine-grained rock—an epidote-diorite—occur. Greenish-black needles of hornblende, grains of magnetite and sometimes garnets occur in the matrix, and also in the pebbles. Hornblende crystals may frequently be seen lying partly in the matrix and partly in the pebbles.

(4) Zone of diorite and hornblende-schists with granulit and granite-gneiss. These rocks rest upon those of the last zone. They are similar in character to the diorite and hornblende-schists which occur in zone (1).

(5) The zone of the Lysekloster schists. These are more or less allied to those of zone (4). They are distinguished as a whole by beds of gneiss with white mica.

The author next proceeds to describe the mode of occurrence of the fossils and the character of the rock in which they are imbedded. Fossils have been found at two horizons. At the southern horizon near Kuren, cup corals, *Halysites*, and *Syringophyllum* are found in beds and lenticular patches of a greyish-blue crystalline limestone which occurs in a dark shining micaceous clay-slate.

At the northern horizon a much richer fauna has been found. The best localities are situated near the road leading from Ulven to the north-east, the richest fossil source being near the Vagtdal farmhouse. The rock is a light-grey glistening schist (? slate), which, to the unaided eye, is seen to consist largely of small scales of muscovite (?). Porphyritic roundish plates of a brown mica, whose cleavage planes are independent of the schistosity, also occur. Under the microscope quartz showing aggregate polarization, and not having a fragmental aspect, is seen to form an essential constituent of the rock. Brownish rutile, often in twins and beautifully crystallized tourmalines, may also be detected. There occur, moreover, dark flecks and spots of doubtful character. The rock is easily broken between the fingers. The following is a bulk analysis by Professor Kjerulf.

SiO <sub>2</sub> ... ..	54.05	CaO ... ..	1.69	Na <sub>2</sub> O ... ..	2.94
Al <sub>2</sub> O <sub>3</sub> ... ..	21.24	MgO ... ..	4.49	TiO <sub>2</sub> ... ..	.89
FeO ... ..	7.70	K <sub>2</sub> O ... ..	5.26	H <sub>2</sub> O ... ..	1.74

In a special analysis 1.45 per cent. of TiO<sub>2</sub> was found.

The shells of the fossils have disappeared, and only a reddish-coloured earth remains. The fossils which have been recognized comprise: Trilobites of the genera *Phacops* and *Calymene*; Gastropoda, and Brachiopoda not determinable; Corals, including *Cyathophyllum*, *Halysites catenularis*, *Favosites*, etc.; and Graptolites of the genera *Rastrites* and *Monograptus*.

The author next describes the rocks of Trengereid which occur to the north-east, and on the same line of strike as those of Osören. They do not show the same succession, but are, on the whole, similar in petrological characters. Fossils have been found in the limestones, and therefore the author refers them without hesitation to the Silurian period.

The schists in the immediate neighbourhood of Bergen, which occur in the N.W. of the peninsula, are of more doubtful character. They contain limestones and conglomerates, and were thought by the author, at first, to belong to the same series as those of Osören. Fossils, however, have not been found in them, and there are one or two important petrological differences. Thus the quartz-augen-gneiss, so characteristic of the district of Osören, is absent in the neighbourhood of Bergen; whereas a normal augen-gneiss with "eyes" of reddish felspar is common in the latter locality.

Between the Bergen schists and those of Lysekloster there intervenes an extensive tract of country denominated by the author the Ulriken's gneiss district. This district was examined hastily for the purpose of determining if possible the relation between the rocks of which it is composed and the fossiliferous schists of Osören. No very important results were obtained as far as the succession is concerned, although many extremely valuable facts of local interest are recorded.

The rocks, which show on the whole bedding and foliation, and which strike, roughly speaking, N.E. and S.W., comprise reddish gneiss with beds of hornblende-schist, foliated labrador-rock, hornblende-granite or gneiss, gneiss-granite, quartzite and mica-schist. Irregular patches of granite and pegmatite and masses of diorite also occur.

The author next proceeds to summarize his work. He considers that the facts recorded in the paper, as far as they bear on the structure of the Bergen peninsula, may be interpreted on the assumption that the rocks between Osören and Bergen form one series in unbroken succession. The entire thickness, according to this view, would be at present about 20,000 metres, and it must, as the author remarks, have been originally much greater, for enormous compression has clearly taken place.

Another and totally different view is however possible. The Ulriken's gneiss district may behave as the central-massif of the Alps. This would make the fossiliferous beds younger than the more massive gneisses.

The author evidently inclines to the former view. At any rate he considers that the schists of Osören form a single series of rocks of Silurian age, having a total thickness, not due in any way to repetition by folding, of about 5,000 metres.

The phenomena of metamorphism are then discussed; but no additional facts of any great importance are brought to light. The author expresses the opinion that the various gneisses of the district in question were originally clastic rocks, somewhat perhaps of the nature of a quartz-felspar grit; and that the saussurite-gabbro, diorite, diorite-schists, hornblende-schists, and related rocks were on the other hand originally eruptive rocks or their tuffs.

Some interesting facts with regard to gneiss and gneiss-granite are then referred to, and the author concludes by expressing the opinion that certain granitic areas may be regarded as portions of the fundamental series which have been pushed through later rocks by the enormous earth pressure whilst in a plastic condition.

---

## REPORTS AND PROCEEDINGS.

---

### GEOLOGICAL SOCIETY OF LONDON.

I.—December 19, 1883.—J. W. Hulke, Esq., F.R.S., President, in the Chair.—The following communications were read:—

1. "On some Remains of Fossil Fishes from the Yoredale Series at Leyburn in Wensleydale." By James W. Davis, Esq., F.G.S.

After describing the nature and succession of beds among the rocks which yielded the fossils under consideration, the author discussed the conditions under which they were deposited. He pointed out that the Fish-fauna of the Yoredale series was distinguished by some important peculiarities from that of the Mountain Limestone below, as also from that of the Coal-measures. Some of the Carboniferous-Limestone types are represented only by very small specimens in the Yoredale series; certain Coal-measure fish make their first appearance in these Yoredale beds; but a large proportion of the species in the latter are peculiar to the formation.

Of the thirty-four species cited twenty are identified with known Carboniferous-Limestone forms, namely:—*Cladacanthus paradoxus*, Ag.; *Physonemus hamatus*, Ag.; *Cladodus mucronatus* and *Hornei*, Davis, and *C. striatus*, Ag.; *Pristicladodus dentatus*, McC., and *concinus*, Davis; *Glyphanodus tenuis*, Davis; *Petalodopsis tripartitus*, Davis; *Polyrhizodus Colei*, Davis; *Diclitodus scitulus*, Davis; *Petalodus acuminatus*, Ag.; *Pleuroodus Woodi*, Davis; *Pæcilodus corrugatus*, Davis; *Lophodus reticulatus*, *serratus*, and *bifurcatus*, Davis; *Psammodus rugosus*, Ag.; *Copodus corvutus*, Ag.; and *Ctenopetalus crenatus*, Davis. The Coal-measure species, *Megalichthys Hibberti*, is also cited. The remaining thirteen species are described as new; they are:—*Chomatodus lamelliformis*, *Sandalodus minor*, *Lophodus conicus* and *angularis*, *Deltptychius plicatus*, and the following, which are regarded as the types of new genera; *Gomphacanthus acutus*, *Hemichladodus unicuspidatus*, *Astrabodus expansus*, *Cyrtocodus gibbus*, *Echinodus paradoxus*, *Diplacodus bulboides*, *Mycetodus verrucosus*, and *Cercidognathus canaliculatus*.

In conclusion, the author noticed the occurrence, associated with

the above, of some very fragmentary remains, apparently belonging to a Labyrinthodont, a portion of which have already been described by Prof. Miall in the 'Quarterly Journal' (vol. xxx. p. 775). These remains consist of parts of the head and of one hind limb.

2. "Petrological Notes on some North-of-England Dykes." By J. J. H. Teall, Esq., M.A., F.G.S.

The author described the stratigraphical relations and the structure, macroscopic and microscopic, of a number of dykes which occur in the north-east of England, giving analyses. He pointed out that they fell into four more or less distinct groups:—

- (1) The Cleveland dyke and that of Acklington.
- (2) The Heth and its related dykes.
- (3) The dykes of Hebburn, of Tynemouth, of Brunton, of Hartley, and of Morpeth.
- (4) The High Green dykes.

Groups (1) and (3) resembled one another in specific gravity and chemical composition, as did (2) and (4), the percentage of silica in the first two (except in the Morpeth dyke) varying from 57 to 59, and the specific gravity being about 2·7 or 2·8, while the others had a silica percentage of from 51 to 53 and a rather higher specific gravity. The former present some microscopic differences, the latter are very closely related. The Cleveland, Acklington, and Heth dykes have been examined at intervals far apart, and exhibit no variation or relation to the surrounding rocks; so that evidently they have not taken up any appreciable portion of the material through which they have broken. The dykes of Group (3) being probably Pre-tertiary (the author does not himself find it possible to distinguish igneous rocks by their geologic age) would be termed melaphyres on the continent; but those of (2) and (4) are nearer to the group of diabases. The Cleveland dyke (Group 1) is almost certainly of Tertiary age, and its structure and composition entitle it to the name of an augite-andesite.

3. "The Droitwich Brine Springs and Saliferous Marls." By C. Parkinson, Esq., F.G.S.

The author referred to the effects of the pumping of brine from beneath Droitwich in producing insecurity in the buildings, and proceeded to discuss the possible source of the brine-water system. He referred to the probable existence of extensive beds of rock-salt, lower than the present brine-cavities, towards the north-east of Droitwich—a conclusion which receives support from the deeper borings carried on at the Stoke works. Full details of these and other recent borings were given by the author.

---

II.—January 9, 1884.—J. W. Hulke, Esq., F.R.S., President, in the Chair.—The following communications were read:—

7. "On the Volcanic Group of St. David's." By the Rev. Prof. J. F. Blake, M.A., F.G.S.

The result of the author's examination of the rocks in the district of St. David's which have been designated *Dimetian*, *Arvonian*, and



*Pebidian*, is that they belong to one volcanic series, whose members are those usually recognized in eruptive areas, and whose age is anterior to, and independent of the true Cambrian epoch.

The independence of this series and the Cambrian is shown by the nature of the junction at all points of the circuit that have been seen. In a bay west of Nun's Chapel the junction on the beach is actually a faulted one, the conglomerate being cut out, and the amount of ashy rock seen comparatively small. To the west of this all ashes have been cut out, granite and slate being in contact to the east: at Caerbwdy there is a quarter of a mile across the ashes. This shows discordance. In the Solva valley the beds beneath the conglomerate are again different, and up the higher reach the series on the north and south side are quite distinct, showing a fault. At Trehenliw the conglomerate is absent, at Ogof Goldfa there is a forked fault. South of Castell the conglomerates and slates strike directly at the consolidated ashes, and at Carn-ar-wig the conglomerate is actually seen overlying unconformably green ashes and agglomerates, silky schists being in the neighbourhood, but nowhere near the visible junction. At Ogof Llesugn the appearances are due to the intrusion along a fault of a diabase dyke which has caught up large fragments of granite, felsite, and conglomerate, and cemented them in its substance; but the granite scarcely anywhere comes in contact with the conglomerate, and is nowhere intrusive. The junctions in the Allan valley are all faulted with forked faults, some reversed, others normal, the intervening mass often decaying.

The supposed isocline west of the granitic mass cannot be verified on an examination of the coast-section, there being great irregularity and gentle synclinals not far from where the apex of the isocline should be.

With regard to the nature of the rocks which thus antedate the Cambrian, the author was unable to recognize any true alternations in the materials of the granitic axis, though the rock is a peculiar one in the arrangement of its constituents. The felsitic rocks are not independent of the granite, as they surround it on all sides, the line along the north and south being specially traced. They are also often intrusive into the ashes, and hence can have no definite strike. The general features of these rocks are therefore most easily to be matched in such volcanic districts as that of Mull.

These results are confirmed by the structure of two outlying masses, one at Ramsey Island, the other south of Points Castle. In the former, at Porth Hayog, quartz-porphyry is succeeded by a band of rhyolite showing flow-structure, and this by ashes and agglomerates. On the South Carn is a mass showing perlitic structure and contorted lines of flow, and on the north, at Pwll Heudre, large masses of banded spherulite of somewhat doubtful character, and an apparent strike of E. and W. The conglomerate in this area has many pebbles of the associated rocks. In the latter area we have a similar series separated by a fault from the Cambrian rocks, and consisting of banded felsites, weathering into apparent beds of very irregular lie, and followed by an ashy series.

The mass which lies to the east and terminates at Roche Castle does not present sufficient similarity to these to be included in the same description. The Roche-Castle rock, however, instead of being bedded, was originally andesitic or trachytic, the felspar crystals having been replaced by pseudomorphous quartz.

Attention was drawn to the highly acid character of the whole series, and the small size of the centres of eruption, and it was suggested that such centres have continually decreased in number and increased in magnitude during geological time.

2. "On further Discoveries of Vertebrate Remains in the Triassic Strata of the South Coast of Devonshire, between Budleigh Salterton and Sidmouth." By A. T. Metcalf, Esq., F.G.S.

The author gave a brief stratigraphical account of the Triassic rocks of the coast. He then described some vertebrate remains, consisting chiefly of portions of jaw-bones with teeth in line, probably of Labyrinthodonts, found in the Upper Sandstones (Ussher's classification) at High Peake Hill, near Sidmouth, by H. J. Carter, Esq., F.R.S. At numerous places between Budleigh Salterton and Sidmouth Mr. Carter and the author had found a large number of isolated bone fragments. Such fragments had been submitted to a microscopical examination by Mr. Carter. In some specimens the bone structure was visible throughout; in some the bony portion had been partially removed and replaced by an infiltration of mineral matter; in others the removal of the bony portion was complete. From these facts the author drew the conclusion that a comparative abundance of vertebrate life was maintained during the Triassic period; and that the rareness of Triassic fossils was due not so much to the paucity of animal life during that period as to the fact that Triassic strata afforded no suitable conditions for the *preservation* of organic remains.

---

## CORRESPONDENCE.

---

### THE MIDDLE HEADON MARINE BED.

SIR,—I do not know why Mr. S. V. Wood should think it strange that I have repeated Mr. Keeping's statement, as to the Middle Headon bed at Hordle, described in former years, not having been *in situ*.

Mr. Searles Wood, senior, described the bed he saw, and then left the locality. Mr. Keeping resided at Milford for many years within a mile of the spot, and he relates that he saw this portion of the bed worked out. Had the seam been continuous, and not a detached mass, why should he have been unable to follow it horizontally into the cliff? Instead of doing this, Mr. Keeping states that he went to a higher level, and dug down on to the bed through the gravel talus. This operation he has repeated this autumn, and the readiness and accuracy with which he selected the spot for the digging, sinking a pit directly down on what appeared to be the edge of the bed formerly exposed by him, convinced me of the truth of his views.

That the statement "10 or 12 feet above high-water mark" is strictly corroborated by our estimate of "13 feet above the beach" is, I think, rather doubtful, as high-water mark is, excepting at high spring tides, a few feet below the top of the beach.

On page 3 of Mr. Wood's paper, he speaks of "that more purely freshwater formation both *above* and beneath the marine stratum," and he leaves the question of the beds exposed to the eastwards being Upper or Lower Headon an open one. Now we have shown clearly that there are no beds between the marine stratum and the gravel at Paddy's Gap, except one foot and a half of unfossiliferous white sand, which can hardly be referred to the freshwater Upper Headon series; and further that the *Unio* beds distinctly underlie the Middle Headon. Unless the supposed Upper Headon beds were portions of the *Unio* beds, what were they?

Is it not better to settle a discussion of this nature on the spot by an examination, and excavation where necessary made at the present day, than to have an argument on observations made many years ago.

All geologists recognize the great value of the work done here, as elsewhere, by the late Mr. Searles Wood; but surely his son writes somewhat unadvisedly in demanding apologies from Mr. Keeping.

OTTERBOURNE, near WINCHESTER,  
Dec. 21st, 1883.

JOHN W. ELWES.

#### THE MIDDLE HEADON MARINE BED.

SIR,—What could have induced Mr. Searles Wood to write a long article on the Long Mead End Upper Bagshot Sands (*GEOL. MAG.* Nov. 1883) I cannot conceive, seeing that the discussion was strictly on the position of the Middle Headon Marine bed. Was it that he was desirous of informing us that his father had discovered the Upper Bagshot Sands in July, 1843? Mr. Searles Wood seems, however, to have overlooked the fact that it had been mentioned by several previous writers—by Webster in 1824, Lyell in 1829, and D'Archiac in 1838.

I do not for a moment blame Mr. Searles Wood in looking after his father's interests; but this, it seems to me, is the reverse of what he is doing, for he implicates his father in several mistakes which he has himself made. Thus he states distinctly (*GEOL. MAG.* Nov. 1883, p. 496) that the Upper Headon does occur at Hordwell; the late Mr. Searles Wood was much more cautious, for he admits that he regarded it as Upper Freshwater "more from position than from its organic contents," thus leaving it an open question.

Our object has been to show that there is *no* Upper Headon at Hordwell, and this I believe we have succeeded in doing. I have myself worked at these cliffs more or less every year for the last 42 years, and we merely wished to add a few facts to what was already known.

Mr. J. W. Elwes having so well described (*GEOL. MAG.* Nov. 1883) the position of the beds in a pit we sank last September, I need hardly say more on this point, excepting that it is not likely that this Middle Headon Marine bed would ever have been found

had it not been for a small slip. I well remember the slipped mass sinking lower and lower until it reached the beach.

Prof. Judd says that the importance of the marine bed has been much overrated, as it is not a distinct formation, but only one of numerous local intercalations of brackish-water bands among the Oligocene strata.

To this I reply that although I have so constantly worked this area, I have never once met with any but this one zone, and have never until now heard of such.

I could say much more, but it really seems a waste of time, and of your valuable space, since one of my critics admits that he has not visited the neighbourhood since 1845, and the other writes as though he had never seen the place at all.

H. KEEPING.

WOODWARDIAN MUSEUM, CAMBRIDGE.

---

PIKRITE.

SIR,—I am glad to learn that Capt. John Plant has discovered the rock Pikrite (it is not a mineral, as twice stated in his letter) *in situ* in Anglesey. As I have specially studied the rock, and am aware of more than one variety of it which occurs in Anglesey, I shall be greatly indebted to him if, before he publishes his "map and explanation," he will permit me to examine his specimens.

T. G. BONNEY.

---

MISCELLANEOUS.

---

PROFESSOR SIR RICHARD OWEN, K.C.B., M.D., D.C.L., LL.D., F.R.S., F.G.S., etc., etc., etc.—Professor Owen, who was appointed to the post of first Superintendent of the Natural History Departments in the British Museum in May, 1856, an office specially created for him, retired from official connection with the National Museum on the 31st December last, after 28 years' service. He had previously filled the office of Conservator of the Museum and Hunterian Professor at the Royal College of Surgeons, Lincoln's Inn Fields, for about 25 years. Although Professor Owen's labours as a Zoologist and Comparative Anatomist and Physiologist are so important and extensive, yet he will be more especially remembered for his great and original researches into the extinct forms of life which peopled our earth in the old times, and his British Fossil Mammalia, Fossil Reptilia, his Extinct Gigantic Edentata of South America, his Fossil Reptilia of South Africa, his Fossil Marsupialia of Australia, and his Fossil Wingless Birds of New Zealand, alone form a stupendous monument of patient and masterly labour. His Memoirs on the Pearly Nautilus, on *Spirula*, on *Limulus*, on Camerated Shells, etc., betray the same extensive powers of observation. His memoirs upon the fossil long-tailed bird, *Archæopteryx*, and those on the great horned lizard, *Megalania prisca*, from Australia, specially deserve to be mentioned. The title of K.C.B. conferred upon him by his Sovereign is a fitting recognition of his life-long scientific labours. Sir Richard Owen will complete his 80th year on the 20th July next.<sup>1</sup>

<sup>1</sup> We hope to give a full account of Professor Owen's life and work in a later Number, with a portrait of this distinguished Palæontologist.—EDIT. GEOL. MAG.

THE  
GEOLOGICAL MAGAZINE.

NEW SERIES. DECADE III. VOL. I.

No. III.—MARCH, 1884.

ORIGINAL ARTICLES.

I.—ON THE PERMIAN-TRIAS QUESTION.

By JULES MARCOU, For. Memb. Geol. Soc. Lond.

THE Rev. A. Irving, in the January Number of the GEOLOGICAL MAGAZINE, p. 46, writes: "The argument then in favour of the retention of the name 'Permian' (as against *e.g.* that of 'Dyas') is based on no logical consistency with established geological nomenclature. It is an excellent local name for the Russian series, but as a general term for the European series it is highly misleading."

A few quotations from memoirs and geological maps on Russia will show that the term 'Permian' is even more objectionable and misleading for the Russian series than for any other parts of Europe.

Murchison defined his proposed system, and affirmed the non-existence of the Triassic series, in his great work *Russia and the Ural Mountains*, vol. i. 1845, in the following manner:—"Our Permian System embraces everything which was deposited between the conclusion of the Carboniferous epoch and the commencement of the Triassic series," pp. 140, 141, excluding "the Rothe-todte-liegende of Germany from our Russian natural group." Farther at p. 182, we read: "We have not indeed any sort of evidence to prove that the masses we are describing constitute a portion of the Trias of Europe . . . . simply considering it a great and copious cover of the Permian system." . . . . "On the whole, however, we confess we are disposed to view these variegated sands and marls like those of Orenburg as a part of the Permian system." Finally, p. 193; "Mount Bogdo.—Having already stated that we have no proof of the existence of rocks of the age of the Trias in the central region of Russia . . . ."

As Murchison placed then the Rothe-todte-liegende in the Carboniferous, and did not recognize the Trias (except at Mount Bogdo), or the Lias, or the Lower Oolite in Russia, his 'Permian System,' as defined by him, comprehended in one lump all the Russian rocks existing between the Rothe-todte-liegende and the Oxfordian or Middle Oolite rocks, which, according to Murchison, "occupy a region more than twice the size of the whole Kingdom of France" (*Russia*, p. 137).

If we look at Murchison's *Geological Map of Russia*, we see the 'Permian' marked No. 4 occupying almost half of the Russian Empire in Europe. The Trias marked No. 5 is reduced to a small

spot, of the size of a pea, north-east of Astrakan at the Grand Bogdo Mountain.

On his *Geological Map of Europe*, in collaboration with James Nicoll, 1856, in four sheets, Murchison colours and marks with the letter *e* as 'Permian' all the rocks in Russia between the Carboniferous and the Jurassic, excluding even the Trias of Mount Bogdo, with the remark however, inscribed under the word Grand Bogdo: "Limestone with Trias fossils on Saliferous Sandstone."

The two general Geological Maps of Russia published at St. Petersburg by Colonel Ozerski in 1849, and by General Helmersen in 1863, reproduce the geographical distribution of the 'Permian' as it was delineated by Murchison, with a few alterations near the foot of the north-eastern part of the Ural Mountains.

The first general Geological Map of Russia, after Helmersen's of 1863, is Valérien de Moeller's *Carte des gites miniers de la Russie d'Europe*, 1878. Here we have a map differing entirely, as to the distribution of the Trias and 'Permian,' from those previously quoted. Instead of the single small spot of Trias of Mount Bogdo, we have an immense surface, twice as large as England and Scotland together, coloured as Trias, while the 'Permian' is so much diminished in size, as to occupy only a very modest place, along the western foot of the Ural Mountains and at a few spots along the Volga river, also east and north of Moscow, and near Mittau in Courland. In fact, the 'Permian System' in the map of Moeller, 1878, plays a very secondary part in the geology of Russia.

In a special Geological Map of the Ural Mountains, entitled *Carte géologique du versant occidental de l'Oural*, published in 1869, M. Valérien de Moeller gave already an entirely different view of the geographical distribution and stratigraphical section of the so-called 'Permian Series.' For not only M. de Moeller admits fully the existence of the Trias, over immense surfaces precedently coloured as 'Permian,' but he divides the rocks placed between the Trias and the Carboniferous into two great groups, one formed of Limestone with marls, slates, gypsum and salt, and the other of Sandstone, conglomerate, copper grits and coal; in fact, M. de Moeller's 'Permian' is a regular Dyas, somewhat similar to the Dyas of Central Germany.

How such a great change came about requires a few words of explanation; for it seemed according to Murchison that we have in Russia a type of a formation badly defined in Germany and in England, and that for the first time himself and his associates De Verneuil and von Keyserling had found in the great Russian Empire, and more especially in the Government of Perm, proof of the existence of a great series of rocks, which he offered to geologists as a typical formation, under the title of the 'Permian System.'

The publication of my memoir, entitled *Dyas et Trias*, at Geneva, in 1859, first attracted attention to the difficulties and even impossibilities of accepting such a type, so far from Central Germany and the classical ground of Thuringia in Saxony; and with such an unsatisfactory description as the one contained in *Russia and the Ural Mountains*.

Shortly after Rudolph Ludwig made a journey to the Ural Mountains, and explored especially the series of rocks considered by Murchison as his typical formation of the 'Permian' in the Government of Perm. He soon recognized the errors of superpositions, classifications and determinations of ages committed by his predecessors, and having convinced himself there on the field that Murchison by mistake has placed in his 'Permian System' the whole of the Trias, he published successively his *Geogenische und geognostische Studien auf einer Reise durch Russland und den Ural*, with a Geological Map of a part of the Government of Perm;<sup>1</sup> and his Geological Map, *Die Dyas in Russland*, in the beautiful and excellent monograph of the *Dyas*, by H. B. Geinitz, 1861 and 1862.

Other discoveries followed; and now even in Russia the word 'Dyas' is used, as more appropriate than any other offered until now, to designate a series of rocks, so well known and distinguished in Germany under the double appellation of *Rothe-todte-liegende* or *Rothliegende* and *Zechstein*.

The celebrated Russian geologist, the late Edouard d'Eichwald, has signalized and pointed out the Government of Orenburg as better fitted to give a fine series of the Dyassic rocks than the Government of Perm, long before Mr. W. H. Twelvetrees; for we read in his introduction to vol. i. part 2, of his *Lethea Rossica*, p. 17, 18, Stuttgart, 1860: "The Permian System is the same as the Pénéen, which is better worth preserving as a geological name, than Permian, especially as the animals and plants characteristic of the Pénéen System are not found in the Government of Perm, but in that of Orenburg." "In the *Lethea*, I have sometimes called these strata Cupriferous sandstones, sometimes Magnesian or Zechstein, limestone which is interpolated between the beds of Cupriferous sandstone: thus well deserving the name of 'Dyas' suggested by M. J. Marcou."

Finally, Prof. C. Greveingk uses the word *Dyas* in his description and on his large *Geognostische Karte der Ostseeprovince Liv.-Est.-und Kurland*, Dorpat, 1879.

CAMBRIDGE, MASSACHUSETTS, U.S.A.

## II.—ON THE DIPLODOCIDÆ, A NEW FAMILY OF THE SAUROPODA; AN ORDER OF AMERICAN JURASSIC DINOSAURS.<sup>2</sup>

By Professor O. C. MARSH, M.A., F.G.S.

THE *Sauropoda* are now generally recognized by anatomists as a well-marked order of the Sub-class *Dinosauria*. In the previous articles of this series, the main characters of the two families of this order (*Atlantosauridæ* and *Morosauridæ*) already named by the writer have been given.<sup>3</sup> A third family is represented by the genus

<sup>1</sup> The city of Perm, which has given its name to the Government of Perm and to the 'Permian System,' is not built on the so-called 'Permian,' but on the Trias.

<sup>2</sup> From the American Journal of Science, vol. xxvii. February, 1884, pp. 161-168.

<sup>3</sup> See Silliman's American Journal of Science, vol. xvi. p. 411, Nov., 1878; vol. xvii. p. 86, Jan., 1879; vol. xxi. p. 417, May, 1881; vol. xxiii. p. 81, Jan., 1882; and vol. xxvi. p. 81, Aug., 1883.

*Diplodocus*, a study of which, more especially of the skull, throws light on the whole group of Dinosaurian reptiles.

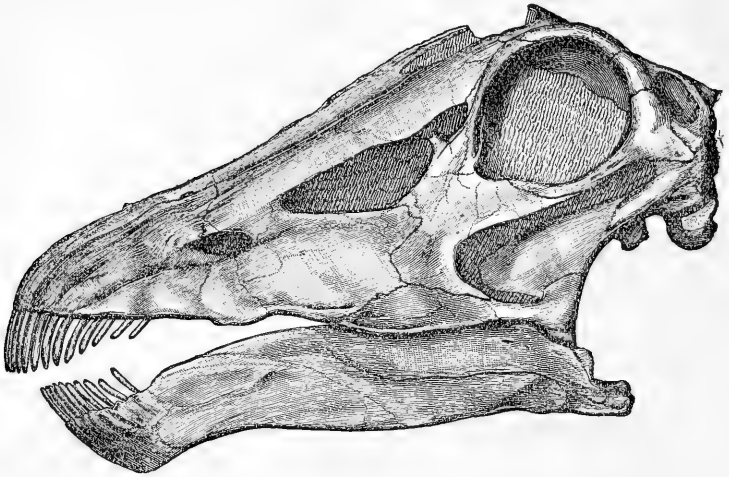


Fig. 1.—Skull of *Diplodocus longus*, Marsh (one-sixth nat. size. Side view).

*The Skull.*—The skull of *Diplodocus* is of moderate size. The posterior region is elevated, and narrow. The facial portion is elongate, and the anterior part expanded transversely. The nasal opening is at the apex of the cranium, which from this point slopes backward to the occiput. In front of this aperture, the elongated face slopes gradually downward to the end of muzzle, as represented in Figure 1.

Seen from the side, the skull of *Diplodocus* shows five openings: a small oval aperture in front (*a*), a large antorbital vacuity (*b*), the

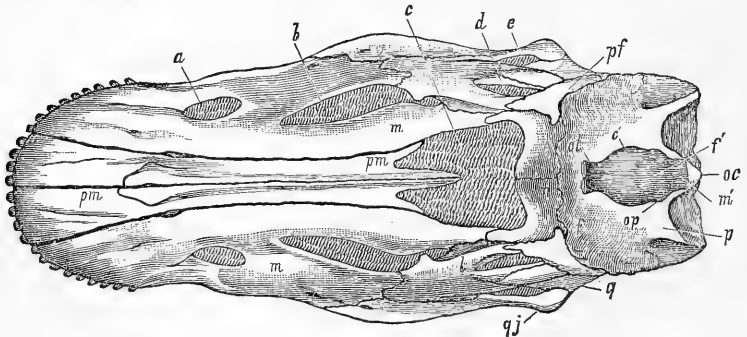


Fig. 2.—Diagram of the skull and brain-cast of *D. longus*; seen from above, one-sixth natural size; *a*, aperture in maxillary; *b*, antorbital opening; *c*, nasal opening; *c'*, cerebral hemisphere; *d*, orbit; *e*, lower temporal fossa; *f*, frontal bone; *f'*, fontanelle; *m*, maxillary bone; *m'*, medulla; *n*, nasal bone; *oc*, occipital condyle; *ol*, olfactory lobes; *op*, optic lobe; *p*, parietal bone; *pf*, pre-frontal bone; *pm*, pre-maxillary bone; *q*, quadrate bone; *qj*, quadrato-jugal bone; *lj*, lachrymal bone.



nasal aperture (*c*), the orbit (*d*), and the lower temporal opening (*e*) (Figure 2). The first of these has not been seen in any other Dinosaur; the large antorbital vacuity is characteristic of the *Sauropoda*; and the other three openings are present in all the known *Dinosauria*.

On the median line, directly over the cerebral cavity of the brain, the type specimen of *Diplodocus* has also a fontanelle in the parietals. This, however, may be merely an individual peculiarity.

The plane of the occiput is of moderate size, and forms an obtuse angle with the fronto-parietal surface.

The occipital condyle is hemispherical in form, and seen from behind is slightly sub-trilobate in outline. It is placed nearly at right angles with the long axis of the skull. It is formed almost wholly of the basi-occipital, the exoccipitals entering but slightly or not at all into its composition. The basi-occipital processes are large and rugose. The paroccipital processes are stout, and somewhat expanded at their extremities, for union with the quadrates.

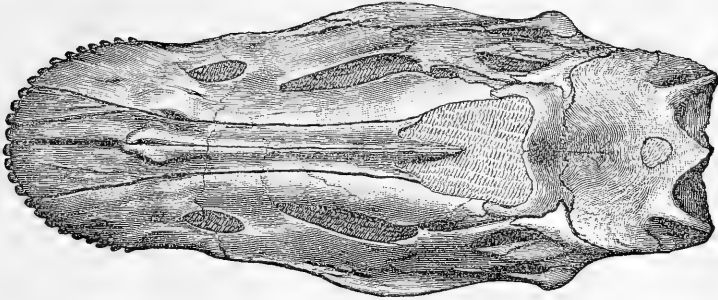


Fig. 3.—View of the skull of *D. longus*, as seen from above (one-sixth nat. size).

The parietal bones are small, and mainly composed of the arched processes which join the squamosals. There is no true parietal foramen, but in the skull here figured 3 there is the small unossified tract mentioned above. In one specimen of *Morosaurus*, a similar opening has been observed, but in other *Sauropoda*, the parietal bones, even if thin, are complete. The suture between the parietals and frontal bones is obliterated in the present skull, and the union is firm in all the specimens observed.

The frontal bones in *Diplodocus* are more expanded transversely than in the other *Sauropoda*. They are thin along the median portion, but quite thick over the orbits.

The nasal bones are short and wide, and the suture between them and the frontals is distinct. They form the posterior boundary of the large nasal opening, and also send forward a process to meet the ascending branch of the maxillary, thus forming in part the lateral border of the same aperture.

The nasal opening is very large, subcordate in outline, and is partially divided in front by slender posterior processes of the pre-maxillaries. It is situated at the apex of the skull, between the orbits, and very near the cavity for the olfactory lobes of the brain.

The premaxillaries (Fig. 4) are narrow below, and with the ascending processes very slender and elongate. Along the median line these processes form an obtuse ridge, and above they project into the nasal opening. Each premaxillary contains four functional teeth.

The maxillaries are very largely developed, more so than in most other known reptiles. The dentigerous portion is very high, and slopes inward. The ascending process is very long, thin and flattened, inclosing near its base an oval foramen, and leaving a large unossified space posteriorly. Above, it meets the nasal and prefrontal bones. Along its inner border for nearly its whole length, it unites with the ascending process of the premaxillary. Each maxillary contains nine teeth, all situated in the anterior part of the bone (Fig. 1).

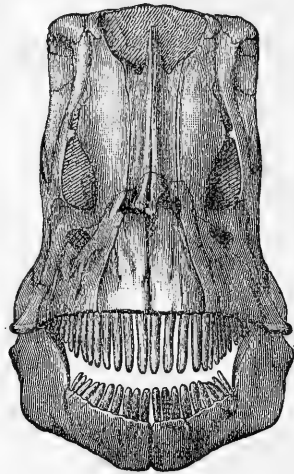


Fig. 4.—Front view of the skull of *D. longus* (one-sixth nat. size).

Along their upper margin, on the inner surface, the maxillaries send off a thickened ridge or process, which meets its fellow, thus excluding the premaxillaries from the palate. Above this, for a large part of their length, the ascending processes of the maxillaries underlap the ascending processes of the premaxillaries, and join each other on the median line.

The orbits are situated posteriorly in the skull (Fig. 1), being nearly over the articulation of the lower jaw. They are of medium size, nearly circular in outline, their plane looking outward and slightly backward. No indications of sclerotic plates have been found either in *Diplodocus* or the other genera of *Sauropoda*.

The supra-temporal fossa is small, oval in outline, and directed upwards and outwards. The lateral temporal fossa is elongated, and oblique in position, bounded, both above and below, by rather slender temporal bars.

The pre-frontal and lachrymal bones are both small, the suture connecting them, and also that uniting the latter with the jugal, cannot be determined with certainty.

The post-frontals are tri-radiate bones. The longest and most slender branch is that descending downward and forward for connection with the jugal; the shortest is the triangular projection directed backward, and fitting into a groove of the squamosal; the anterior branch, which is thickened and rugose, forms part of the orbital border above.

The squamosal lies upon the upper border of the par-occipital process. The lower portion is thin, and closely fitted over the head of the quadrate.

The quadrate is elongated, slender, with its lower end projecting very remarkably forward. In front, it has a thin place extending inward, and overlapping the posterior end of the pterygoid.

The quadrato-jugal is an elongate bone, firmly attached posteriorly to the quadrate by its expanded portion. In front of the quadrate, it forms for a short distance a slender bar, which is the lower temporal arcade.

The palate is very high and roof-like, and composed chiefly of the pterygoids. The basi-pterygoid processes are elongate, much more so than in the other genera of *Sauropoda*.

The pterygoids have a shallow cavity for the reception of these processes, but no distinct impression for a columella. Immediately in front of this cavity, the pterygoids begin to expand, and soon form a broad, flat plate, which stands nearly vertical. Its upper border is thin, nearly straight, and extends far forward. The anterior end is acute, and unites along its inferior border with the vomer. A little in front of the middle, a process extends downward and outward for union with the transverse bone. In front of this process, uniting with it and with the transverse bone, is the palatine.

The palatine is a small semi-oval bone fitting into the concave anterior border of the pterygoid, and sending forward a slender process for union with the small palatine process of the maxillary.

The vomer is a slender, triangular bone, united in front by its base to a stout process of the maxillary, which underlaps the ascending process of the premaxillary. Along its upper and inner border, it unites with the pterygoid, except at the end, where for a short distance it joins a slender process from the palatine. Its lower border is wholly free.

*The Brain.*—The brain of *Diplodocus* was very small, as in all Dinosaurs from the Jurassic. It differed from the brain of the other members of the *Sauropoda*, and in fact from all other known reptiles, in its position, which was not parallel with the longer axis of the skull, as is usually the case, but inclined to it, the front being much elevated, as in the Ruminant mammals. Another peculiar feature of the brain of *Diplodocus* was its very large pituitary body, enclosed in a capacious fossa below the main brain case. This character separates *Diplodocus* at once from the *Atlantosauridæ*, which have a wide pituitary canal connecting the brain cavity with the throat. In the *Morosauridæ*, the pituitary fossa is quite small.

The posterior portion of the brain of *Diplodocus* was diminutive. The hemispheres were short and wide (Figure 2), and more elevated than the optic region. The olfactory lobes were well developed, and separated in front by a vertical osseous septum. The very close proximity of the external nasal opening is a new feature in Dinosaurs, and appears to be peculiar to the *Sauropoda*.

*The Lower Jaws.*—The lower jaws of *Diplodocus* are more slender than in any of the other *Sauropoda*. The dentary especially lacks the massive character seen in *Morosaurus*, and is much less robust than the corresponding bone in *Brontosaurus*. The short dentigerous portion in front is decurved (Figure 1), and its greatest depth is at

the symphysis. The articular, angular, and subangular bones are well developed, but the coronary and splenial appear to be small.

*The Teeth.*—The dentition of *Diplodocus* is the weakest seen in any of the known *Dinosauria*, and strongly suggests the probability that some of the more specialized members of this great group were edentulous. The teeth are entirely confined to the front of the jaws (Figures 1 and 2), and those in use were inserted in such shallow sockets that they were readily detached. Specimens in the Yale Museum show that entire series of upper or lower teeth could be separated from the bones supporting them without losing their relative position. Figure 5 shows a number of detached teeth. The series of teeth was found with the remains of *Stegosaurus*, and hence was at first referred to that genus, as was also the specimen represented in figure 3 of the same plate.<sup>1</sup> The teeth of *Stegosaurus* are now known to be of a different type, somewhat resembling those of *Scelidosaurus*.

Fig. 5.

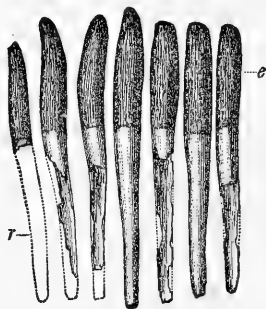


Fig. 5.—Maxillary teeth of *D. longus*, side view, one-half natural size; *e*, enamel; *r*, root.

Fig. 6.

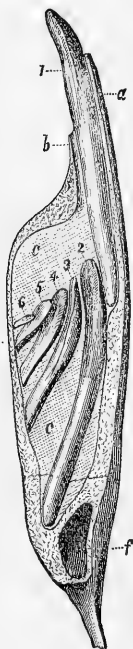


Fig. 6.—Section of maxillary of *D. longus*, one-half natural size, showing functional tooth (fourth) in position, and five successional teeth and dental cavity; *a*, outer wall; *b*, inner wall; *c*, cavity; *f*, foramen.

The teeth of *Diplodocus* are cylindrical in form, and quite slender. The crowns are more or less compressed transversely, and are covered with thin enamel, irregularly striated. The fangs are long and slender, and the pulp cavity is continued nearly or quite to the crown. In the type specimen of *Diplodocus*, there are four teeth in each premaxillary, the largest of the series; nine in each maxillary; and ten in each dentary of the lower jaws. There are no palatine teeth.

<sup>1</sup> See Silliman's American Journal of Science, vol. xix. p. 255, March, 1880.

The jaws contain a single row only of teeth in actual use. These are rapidly replaced, as they wear out or are lost, by a series of successional teeth, more numerous than is usual in these reptiles. Figure 6 represents a transverse section through the maxillary, just behind the fourth tooth. The latter is shown in place (1), and below it is a series of five immature teeth (2 to 6), in various stages of development, preparing to take its place. These successional teeth are lodged in a large cavity (*c*), which extends through the whole dental portion of the maxillary. The succession is also similar in the premaxillary teeth, and in those of the lower jaws.

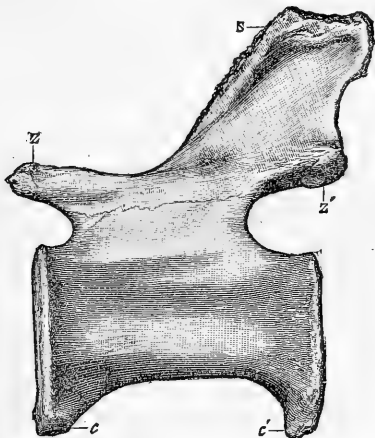


Fig. 7.—Twelfth caudal vertebra of *Diplodocus longus*, Marsh; side view, one-sixth natural size, *c*, anterior face for chevron; *c'*, posterior face for chevron; *s*, neural spine; *z*, pre-zygapophysis; *z'*, post-zygapophysis.

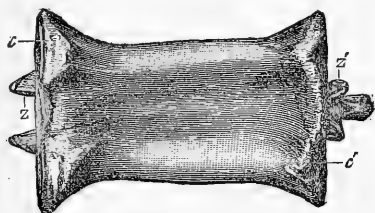


Fig. 8.—The same vertebra; view of the underside, size and letters as Fig. 7.

*The Vertebrae.*—The vertebral column of *Diplodocus*, so far as at present known, may be readily distinguished from that of the other *Sauropoda* by both the centra and chevrons of the caudals. The former are elongated, and deeply excavated below, as shown in Figures 7 and 8. The chevrons are especially characteristic, and to their peculiar form the generic name *Diplodocus* refers. They are double, having both anterior and posterior branches, and the typical forms are represented in Figures 9 and 10, p. 106.

*The Pelvic Girdle.*—The most characteristic bone of the two families of *Sauropoda* previously described is the ischium. In the *Atlanto-*

*sauridæ*, the ischia are massive, and directed downward, with their expanded extremities meeting on the median line. In the *Morosauridæ*, the ischia are slender, with the shaft twisted about  $90^\circ$ , directed backward, and the sides meeting on the median line, thus approaching this part in the more specialized Dinosaurs. The ischia referred to the genus *Diplodocus*, representing the new family here established, are intermediate in form and position between those above mentioned. The shaft is not expanded distally, nor twisted, and was directed downward and backward, with the ends meeting on the median line.

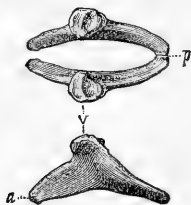


Fig. 9.—Chevron found attached to tenth and eleventh vertebræ of *D. longus*, top and side views, one-tenth natural size; *a*, anterior end; *p*, posterior end; *v*, faces for articulation with vertebræ.

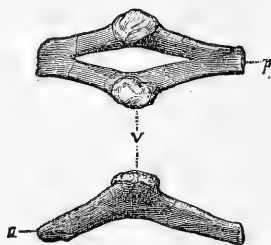


Fig. 10.—Chevron of another individual: top and side views; size and letters as in Fig. 9.

*Size and Habits.*—The type specimen of *Diplodocus*, to which the skull here figured apparently belongs, indicates an animal intermediate in size between *Atlantosaurus* and *Morosaurus*, probably 40 or 50 feet in length, when alive. The teeth show that it was herbivorous, and the food was probably succulent vegetation. The position of the external nares indicates an aquatic life.

The remains of the above specimen were found by Messrs. S. W. Williston and M. P. Felch in the Upper Jurassic beds, near Cañon City, Colorado. A second and smaller species is represented by remains found by Mr. Arthur Lakes near Morrison, Colorado. This species, which may be called *Diplodocus lacustris*, has much more slender jaws than the one above described. A maxillary bone contains eight teeth, and at the premaxillary suture measures  $26^{\text{mm}}$  in thickness. The series of teeth occupy a space of  $70^{\text{mm}}$ . A second specimen of apparently the same species has since been found in Wyoming.

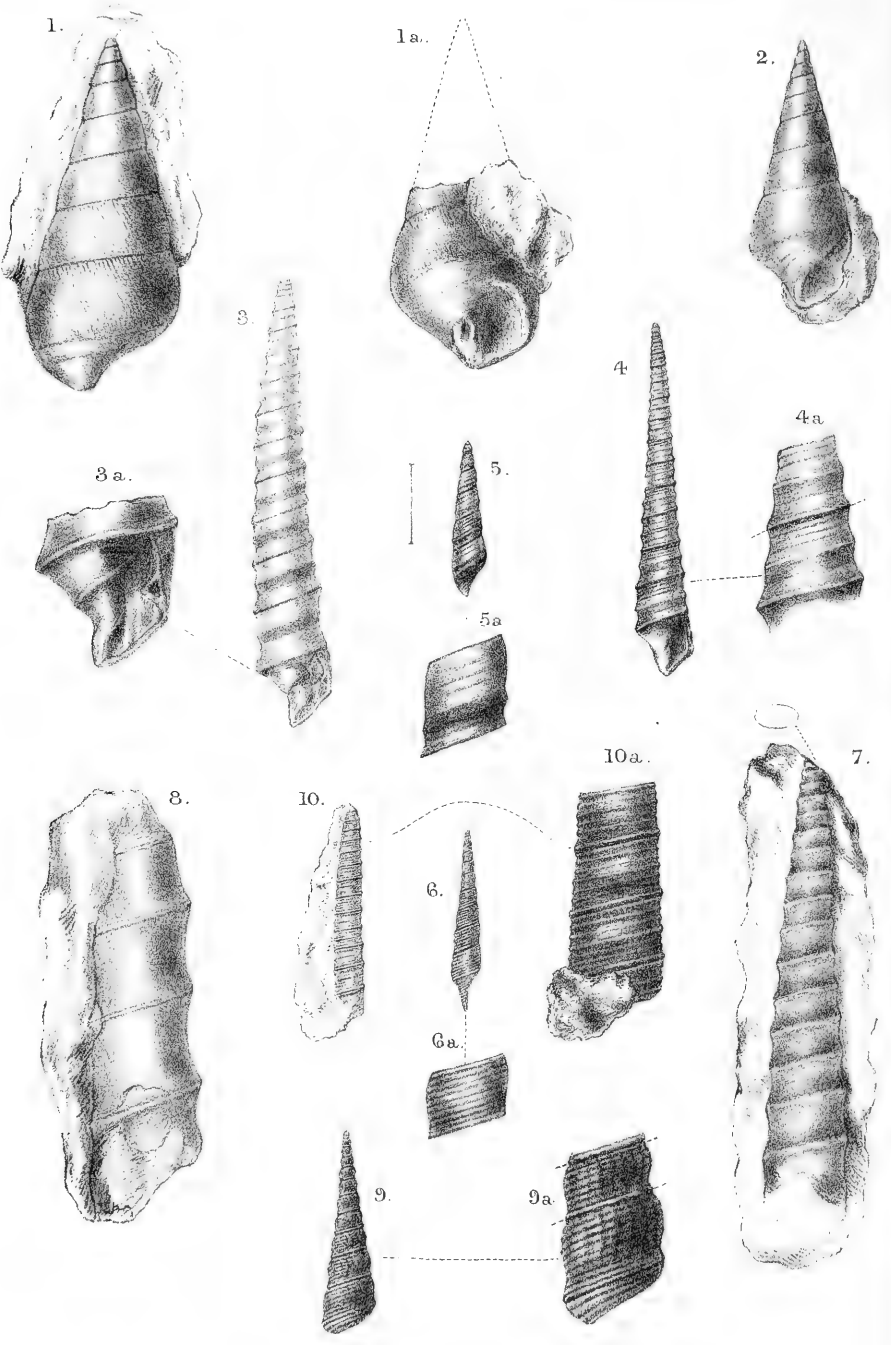
The geological horizon of all the *Sauropoda* from the Rocky Mountain region is in the *Atlantosaurus* beds of the Upper Jurassic. No Cretaceous forms of this group are known.

#### CLASSIFICATION.

The main characters of the order *Sauropoda*, and of the three families now known to belong to it, are as follows:

Order *Sauropoda*.—Premaxillary bones with teeth. Large antorbital opening. Anterior nares at apex of skull. Post-occipital bones. Anterior vertebræ opisthocælian; pre-sacral vertebræ hollow; each sacral vertebra supports its own transverse process. Fore and hind limbs nearly equal; limb bones solid. Feet plantigrade, ungulate; five





A.S. Foord del.

Mintern Bros. imp.

Oxfordian & Lower Oolite Gasteropoda.  
(Yorkshire).



digits in manus and pes; second row of carpal and tarsal bones unossified. Sternal bones parial.<sup>1</sup> Pubes projecting in front, and united distally by cartilage; no post-pubis.

- (1.) Family *Atlantosauridæ*. A pituitary canal. Ischia directed downward, with expanded extremities meeting on median line. Sacrum hollow. Anterior caudals with lateral cavities.
- (2.) Family *Diplodocidæ*. Dentition weak. Brain inclined backward. Large pituitary fossa. Two antorbital openings. Ischia with straight shaft, not expanded distally, directed downward and backward, with ends meeting on median line. Caudals deeply excavated below. Chevrons with both anterior and posterior branches.
- (3.) Family *Morosauridæ*. Small pituitary fossa. Ischia slender, with twisted shaft, directed backward, and sides meeting on median line. Anterior caudals solid.

The *Sauropoda* are the order of Dinosaurs having the nearest affinities with the *Crocodylia*, especially through some of the extinct forms. *Diplodocus*, for example, resembles *Belodon* of the Triassic, particularly in the large antorbital vacuities of the skull, the posterior position of the external nasal aperture, as well as in other features. The genus *Aetosaurus*, from the same formation, is an intermediate form, and represents a distinct order, which may be called *Aetosawria*. The nearer relations of these groups will be discussed by the writer elsewhere.

YALE COLLEGE, NEW HAVEN, Jan. 21, 1884.

### III.—CONTRIBUTIONS TO THE PALÆONTOLOGY OF THE YORKSHIRE OOLITES.

By WILFRID H. HUDLESTON, M.A., F.G.S.

(Continued from Dec. III. Vol. I. p. 63.)

(PLATE IV.)

#### 30.—*CERITHIUM* (?) *CANINUM*, sp. n. Pl. IV. Figs. 1, 1a, 2.

*Description*.—Specimen from the Dogger (zone 1), Peak (Blue Wyke). Bean Collection, British Museum. Figs. 1 and 1a.

Length (restored).....	51 millimètres.
Width .....	21
Ratio of body-whorl to entire shell .....	37 : 100.
Spiral angle.....	32°.

Shell conical, moderately long, with perhaps a rudimentary umbilicus. The complete spire would consist of about 10 whorls, which increase under a regular angle. The surface of the apical whorls in this specimen is not well preserved, but the five anterior whorls are in good condition; they are smooth, somewhat tumid towards the centre, and separated by a suture of moderate depth. Wavy longitudinal lines, apparently lines of growth, are observed, but there is no trace of any other ornament. Base of body-whorl

<sup>1</sup> *Ceteosaurus* has been figured with a single sternal bone by Phillips and other authorities. The writer recently examined the original specimen at Oxford, and found portions of two of these bones, which strongly resemble the sternal plates of American *Sauropoda*.

smooth and almost polished, except where there has been a decortication of the outer layer of shell. This decortication, besides affecting a considerable area near the outer lip, has formed a belt in the posterior region of the base, thus producing a sort of false carination. In this way we learn that both inner and outer layers of shell were of considerable thickness. (N.B.—The shell is now mainly in the condition of spathic iron, coated and coloured with brown oxide).

The columella and anterior extremity of the aperture have, in like manner, suffered some injury, producing an exaggerated appearance of an umbilicus. As far as one can judge from present condition the aperture is almost quadrate.

*Description of another specimen.*—Same horizon and locality. Leckenby Collection (Fig. 2).

Length (restored) .....	38 millimètres.
Width .....	13            "            "
Ratio of body-whorl to entire shell .....	37 : 100.
Spiral angle.....	29°.

There are 8 whorls, with fairly-preserved outline, but these have all suffered from attrition, or some other cause, so that we do not see the outer shell layer as completely as in the specimen from the Bean Collection. In consequence, the convexity of the whorls is slightly less marked, the sutures are shallower, and the proportion of width to height is less: the traces of the wavy longitudinal lines are very slight. On the other hand, the aperture, though considerably involved in matrix, has an outline somewhat better preserved. Its resemblance to that of some *Nerinæas* is rather suggestive.

*Relations and Distribution.*—This form seems to be confined to the Dogger, where it is rare, no other specimens having come under my notice. Its affinities are difficult to trace, as it appears to have no near relations either in this or in higher horizons. Whether there are any forms in the Lias which could be regarded as related, I am unable to say; but certainly, as regards the Yorkshire Lias, Tate and Blake make no mention of any such shell. It would be hazardous to venture on any conjecture as to its relations in the foreign beds, inasmuch as we are not in a position to ascertain beyond a doubt the true character of the aperture. I would merely allude to the possibility of its connection with the genus *Fibula*, Piette (Bull. Soc. Géol. France, April 20, 1857), founded for the reception of certain peculiar *Cerithia* occurring in the Bathonian of the Aisne and the Ardennes. A rudimentary umbilical groove is one of the characteristics of Piette's genus, cf. *Fibula undulosa*, Piette, *op. cit.*

#### GENUS NERINÆA.

A peculiar interest attaches to the *Nerinæas* of the Inferior Oolite, since they are the earliest of their kind. The genus, we are told by Sharpe, usually occurs in calcareous strata associated with shallow-water shells. Thus we do not find *Nerinæas* in the Lias nor in the *Striatulus*-beds, nor even in the Dogger Sands. Indeed I am not aware that any remains of the genus have been detected in the lower portions of the Dogger itself, such as the nodule beds which

occur at intervals immediately above the *Cynocephala*-zone (Yellow Sands).<sup>1</sup> But when we come to what was once the more calcareous portion of the Dogger, the shell-bed towards the top is so full of them as to have received the name of *Nerinea*-bed. In this bed, only 18 inches thick, the first noteworthy accumulation of *Nerineas* occurs, nor are they ever plentiful again throughout the Yorkshire Oolites until we reach the Corallian Rocks.

How and whence did they come, these curious cylindrical shells with their internal folds? Such a question must occur as a matter of course to every one interested in Jurassic palæontology. The genus is so well marked and characteristic, and, on the whole, so different from anything else that a close attention to its genesis may ultimately lead to conclusions of importance in the biological history of the Mesozoic rocks. Does the evidence at present in our possession lead us to suppose that they appeared almost simultaneously along the whole line, or earlier in one place than in another? We may fairly believe that these shells originated in the calcareous shallows, which succeeded the more sandy deposits of the *Cynocephala*-zone towards the base of the Inferior Oolite. As far as our English beds are concerned, *Nerinea* first appeared on this horizon, which may be regarded as situate in the lower portion of the *Murchisonæ*-zone; we shall perceive this fact more clearly in studying the relations and distribution of *N. cingenda*, Phil., the oldest so far as we know of the race.

Most of the specimens found in the Dogger belong to that species. In the next, or Millepore zone, are a few specimens, some of which may belong to other species. The condition of these fossils is for the most part so indifferent, that they have usually been referred without question to *Nerinea cingenda*. The same may be said of specimens from the Scarborough Limestone of Cloughton (Hundale). Beyond the fact that they are cylindrical *Nerineas*, with prominent spiral belts at the base of each whorl, nothing more can be said about them. In the Cornbrash *Nerinea* is extremely rare individually, but contains two well-marked species, whilst the Kelloway Rock, Oxford Clay, and Lower Calcareous Grit are devoid of it. But as soon as the deposits become markedly calcareous, as in the Lower Coralline Oolite, then *Nerinea* once more puts in an appearance, and swarms in the true Coralline Oolite and Coral Rag.

Glancing at the history of the appearance of *Nerinea* in other areas, we find *Nerinea cingenda*, Phil. (*i.e.* Bronn), to be the only representative of the genus in the Northampton Sand, on the horizon of the Dogger, where it is stated to be rare; whilst both this and several other species are quoted from the Lincolnshire Limestone.<sup>2</sup> Again, in the Inferior Oolite of the Cotteswolds, *N. cingenda* is the only species quoted by Wright from the Pea Grit, etc., of Cheltenham,<sup>3</sup> whilst several species made their appearance in the overlying Oolite Marl.<sup>4</sup> Further south the evidence of the occurrence of *Nerinea* as

<sup>1</sup> See Yorkshire Oolites, pt. i. Proc. Geol. Assoc. vol. iii.

<sup>2</sup> Judd, Geology of Rutland, p. 282.

<sup>3</sup> Q. J. G. S. vol. xvi. pp. 11 and 13.

<sup>4</sup> First noticed and described by Lycett in 1857. See his "Cotteswold Hills."

low down as the Inferior Oolite becomes very feeble, and the instances quoted by Mr. Tawney are not altogether, as he tells us, free from doubt, whilst the specific identifications are very uncertain. I do not possess in my own collection a single specimen of *Nerinea* from the Inferior Oolite of the Sherborne-Yeovil district.

Continuing the circuit of the Anglo-Parisian basin, *Nerinea*, according to Deslongchamps,<sup>1</sup> is entirely absent from the Inferior Oolite of Normandy, including the Ferruginous Oolite, but first makes its appearance in the Great Oolite or "White Stone." Throughout the Inferior Oolite of the rest of France the indications of the genus are but slight, though *Nerinea Jurensis*, D'Orb. (T. J. vol. ii. p. 80, pl. 251, fig. 1) from the "Calcaire à polypiers" of Salins (Jura) is the representative of the genus on a somewhat high horizon of the Inferior Oolite. Not a single *Nerinea* is quoted by Brauns from any part of the Brown Jura in N.W. Germany, but Laube gives *N. bacillus*, D'Orb., as occurring very rarely in the Brown Jura of Balin, though in what part of the Brown Jura he gives no intimation.

From the above it may be gathered that the very considerable abundance, at the Peak, of a certain form of *Nerinea* on a low horizon in the Inferior Oolite is exceptional as regards N.W. Europe, and yields additional testimony to the remarkable character of our Yorkshire Dogger.

31.—*NERINEA CINGENDA*, Phillips (= *N. cingenda*, Bronn), 1829.  
Plate IV. Figs. 3, 3a, 4, 4a, 5, 5a.

1829 and 1835. *Turritella cingenda*, Sowerby. Phillips, G. Y. p. 164, pl. xi. figs. 28, 29.

1836. *Nerinea cingenda*, Phill. Bronn in Neues Jahrbuch for 1836, p. 558.

1849. *Nerinea cingenda*, Bronn., *Turritella cingenda*, Phil. D'Orb., Prod. i. p. 263.

1854. *Nerinea cingenda*, Bronn., Morr. Cat. p. 263.

1875. *Nerinea cingenda*, Phil. Phillips, G. Y. 3rd edit. p. 258, pl. xi. figs. 28, 29.

*Bibliography, etc.*—In his first edition Phillips referred specimens from the Coralline Oolite, "Impure Limestone" (*i.e.* Scarborough Limestone and Millepore Rock), and Dogger, all to *Turritella cingenda*, Sowerby (M. C. p. 499, fig. 3—1825), which he fancied to be identical with the fossil figured by him. The type should be at York, but without the aid of this Phillips's figure is sufficiently characteristic of the well-known *Nerinea* of the Dogger, which, as previously stated, is rather abundant. On the other hand, Sowerby's *Turritella cingenda*, as we shall see presently, is decidedly rare. Bronn showed that Phillips's figure was that of a *Nerinea* different from Sowerby's species, whilst both D'Orbigny and Morris endorsed this identification. Strictly speaking, therefore, we ought to follow the example of those writers and regard it as Bronn's species.

If any further proof were needed, I might add, from my own knowledge of the Dogger itself, and of all the more important collections therefrom, that the *Nerinea* figured by Phillips, plate xi. figs. 28, 29, is THE *Nerinea* of the Dogger. Yet in the 3rd edition of the Geology of Yorkshire, Phillips, as though determined to be

<sup>1</sup> *Op. et vol. cit.* p. 179.

wrong, describes the species which bears his name as occurring in the "G. O., Cloughton, Brandsby, C. B. Scarborough," and not in the Dogger at all.

*Descriptions.*—Specimen from the Dogger (zone 1), Peak (Blue Wyke). Leckenby Collection (Figs. 3, 3a).

Length.....	60 millimètres.
Width of body-whorl.....	8 $\frac{1}{2}$ "
Height of whorl to width .....	76 : 100.

This specimen is too much twisted to show the spiral angle correctly; it is considerably worn and the apical portion is wanting, yet it is far above an average of specimens in condition. The spire is subcylindrical, attenuated, turrated; height of the penultimate rather more than  $\frac{3}{4}$ ths of the width: each whorl rises anteriorly towards a strong spiral varix which contains the suture; the height of the last three whorls is nearly the same, the chief increase being in the direction of the width. A slight spiral belt may be noticed a little above the middle of each of the whorls, which are strongly constricted about  $\frac{2}{3}$ rds of the way down. These features are very characteristic.

Aperture oblong, with one wide fold on the outer lip, and two finer folds on the columella.

*Another specimen.*—Same horizon, locality and collection. Figs. 4, and 4a.

Length (apex restored) .....	53 millimètres.
Width of body-whorl.....	7 $\frac{3}{4}$ "
Height of whorl to width .....	75 : 100.
Spiral angle.....	7°.

As regards ornaments this specimen is in rather better condition than the other, and it suggests that there may be some difference in the style of the earlier and later whorls. The upper  $\frac{3}{4}$ ths of the lower whorls is seen to be nearly flush with the preceding varix, and to have very faint spiral lines: then comes the median varix (less prominent than the sutural varix), and then the smooth constricted area occupying the lower  $\frac{3}{4}$ ths.

These details seem to have been somewhat obliterated by usage in the larger specimen.

? *A young specimen.*—Same horizon and locality, York Museum. Figs. 5 and 5a.

Length .....	11 millimètres.
--------------	-----------------

The condition is scarcely favourable for obtaining accurate proportions. The general aspect (due allowance being made for the exaggerations of enlargement) is not unlike what we might expect of the apical conditions of *N. cingenda*.

*Specimen* from the same horizon and locality, Leckenby Collection. Figs. 6 and 6a. Placed under *N. cingenda* provisionally.

Length .....	27 millimètres.
Width .....	3 $\frac{3}{4}$ "
Height of whorl to width.....	90 : 100.
Spiral angle .....	? 7°.

Shell attenuated, subcylindrical: whorls but slightly wider than high, and increasing suddenly below the sutures, which are open.

The ornaments consist of numerous fine spiral bands, and are best defined in the upper  $\frac{2}{3}$  ths: anterior  $\frac{2}{3}$  ths very slightly constricted.

This is an unique specimen, and it may possibly represent nothing more than the apical conditions of *N. cingenda* in an unusually good state of preservation. Yet the spiral lines are finer and more numerous, the constriction in the lower part of the whorl is hardly marked, and no one of the spiral lines is sufficiently larger than the rest to constitute a median varix.

*Relations and Distribution.*—Unless specimens are well preserved, it would not be easy to distinguish between *Nerinæa cingenda*, Phil., *Nerinæa bacillus*, D'Orb. (T. J. pl. 252, figs. 3–6) and some other subcylindrical forms possessed of a marked sutural varix. All these serve to illustrate the primitive forms of the genus. Specimens in the Yorkshire beds are too badly preserved to entertain any very close comparisons as to affinities.

Abundant in the *Nerinæa*-bed of the Dogger at Peak (Blue Wyke), but not found, as far as my observations go, in any other part of the Dogger, either at this place, or elsewhere. Imperfect specimens of *Nerinæa*, some of considerable size, such as Fig. 8, occur in the Millepore Rock of Cloughton Wyke (Sycarham), and these are usually referred to *N. cingenda*, Phil. Casts of *Nerinæa* are also found in the Scarborough Limestone (zone 3) of Cloughton Wyke (Hundale), which might belong either to *N. cingenda* or to any other sub-cylindrical species. Some of these were lately collected by Mr. Herries.

### 32.—NERINÆA, sp. Plate IV. Fig. 7.

*Description.*—Specimen from the Millepore Oolite (zone 2), Whitwell. York Museum.

Length of portion preserved ..... 64 millimètres.

This fossil is flattened, as may be seen on examining the apical end; hence the entire figure is distorted—a circumstance which might easily escape observation, since the flanks of the spire are involved in matrix. No trace of ornaments can now be seen, but considering the condition of the fossil, this proves nothing. One peculiarity, which even distortion cannot hide, is the shortness of the whorls, especially towards the apex, and the prominence of the posterior border.

This peculiarity would seem to remove it from *N. cingenda*, Phil. If we make due allowance for the effects of flattening, this part of the fossil presents some resemblance to *N. Jonesii*, Lycett (“Cotteswold Hills,” p. 124, pl. 2, fig. 4), from the *Fimbria*-stage, Nailsworth Hill; which species has also been detected by Mr. Walford at Coombe Hill. The fossil now figured is the only specimen of *Nerinæa* which I ever saw from the Millepore Oolite.

### 33.—NERINÆA (?) CINGENDA, Sowerby, 1825. Pl. IV. Figs. 9 and 9a.

1825. *Turritella cingenda*, Sow., Min. Conch., vol. v. p. 160, t. 499, fig. 3.

1854.        ”        ”        ”        Morris, Cat. “Cor., Scarborough.”

1875. *Nerinæa*        ”        ”        non Phil.; Phillips, G. Y. 3rd edition, p. 258.

*Bibliography, etc.*—Sowerby says that his type was found in

“Shaley clay in Robin Hood’s Bay near Scarborough, by Mr. Bean.” This seems rather to point to the Lias. If the original is still preserved amongst Sowerby’s types, I have not seen it. Tate and Blake make no allusion to any such shell. Hence we may feel pretty sure that no such form occurs in the Lias. On what grounds Morris classed it as “Corallian, Scarborough,” I have no information. Since Sowerby’s figure is characteristic, and evidently depicts a shell similar to the one now under consideration, there can be very little doubt as to the correctness of the present identification. Our shell most certainly coming from the Dogger, it is only natural to suppose that Sowerby’s type came from the same horizon, the words “Shaley Clay” notwithstanding. This supposition is indirectly confirmed by the fact of Phillips (1829) having referred, although in error, the common *Nerinea* of the Dogger to Sowerby’s species.

*Description.*—Specimen from the Dogger (zone 1), Peak? Leckenby Collection.

Length .....	31 millimètres.
Width .....	7           ”
Spiral angle .....	15°.
Height of whorl to width .....	58 : 100.

Shell elongate, subconical, spiral angle regular; whorls nearly twice as wide as high, upper portion of whorl very convex, lower portion constricted. The whorls are rather prominently sculptured with numerous spiral bands. These decussate on the upper or tumid portion of the whorl with short curved longitudinal costæ (characteristic of Sowerby’s figure): base of each whorl marked by a strong spiral varix.

Aperture concealed in matrix, but sufficiently shown as to render it probable that this shell is a *Nerinea* rather than a *Turritella*.

*Relations and Distribution.*—There seems but little affinity between such a fossil as this and the usual forms of *Nerinea* prevailing on low horizons. Neither can I find any indication of such a fossil having been found in the Inferior Oolite of other districts.

Even in Yorkshire it must be very rare, since the specimen now figured is the only one ever recognized by me in any collection.

Judging from the matrix there can be no reasonable doubt of its being a true Dogger fossil. But it most probably comes from one of the more sandy beds of the Dogger, and not from the *Nerinea*-bed. Altogether there is a mystery attaching to this species which is not yet quite satisfactorily cleared up.

#### 34.—*NERINEA GRANULATA*, Phillips, 1829. Not figured.<sup>1</sup>

<sup>1</sup> The type specimen, figured both by Phillips and Lycett, should be in the Scarborough Museum, but I have never been able to see it. Nor have I ever been able to see a specimen of this very scarce species until quite lately, when I discovered a fragment  $\frac{3}{4}$  inch in length in the Jermyn Street Museum. The apical portion is entirely gone, but five well-preserved anterior whorls, in a most undoubted Cornbrash matrix, are sufficient to show that this is the species figured and described by Lycett from Phillips’s type specimen. Lycett’s figure is  $1\frac{1}{4}$  inch long, and shows eight whorls, whilst Phillips’s figure is nearly 2 inches long, and shows thirteen whorls. Hence the available specimens have been continually getting shorter.

- 1829 and 1835. *Terebra granulata*, Phillips, G. Y. pp. 116 and 165, pl. vii. fig. 16.  
 1849. = *Cerithium tortile*, Desl. (M.L.S.N. 7, p. 200, pl. 11, fig. 15), D'Orb.  
 Prod. p. 302.  
 1854. *Cerithium granulatum*, Phil., Morris Cat. p. 240.  
 1863. *Nerinea granulata*, Phil., Lycett, Suppl. Great Ool. Moll. p. 10, pl. 31,  
 figs. 12, 12a.  
 1875. *Nerinea granulata*, Phil., G. Y. 3rd edition, p. 258.

Not having been able, until quite recently, to obtain a glimpse of any fossil which could be referred to this species, I had determined to exclude it from this memoir, which professes to deal with fossils actually seen. When the only specimen did turn up, it was too late to have it figured in Plate IV. I must, therefore, refer to Lycett's figure and description.

*Terebra granulata*, Phil., is undoubtedly a *Nerinea*, not hitherto discovered out of the Yorkshire Cornbrash, where it is excessively rare. It is very distinct from a shell, rather plentiful in the Yorkshire Corallian, usually referred to *N. Rœmeri* (= *N. fasciata*, Rœmer, non Voltz.).

35.—NERINEA, sp. Plate IV. Figs. 10 and 10a.

The specimen figured as above belongs to the Leckenby Collection, where it is labelled "*Nerinea fasciata*, Voltz.; Cornbrash, Scarbro'." The matrix is a little peculiar, but on the whole resembles that of the Scarborough Cornbrash more than any other.

Description—

Length of spire remaining.....	30 millimètres.
Width .....	4 "
Spiral angle .....	? 4°.

Shell very narrow, subcylindrical. Number of whorls remaining about 13; these are nearly flat, but with a slight constriction in the lower part, whence they rise suddenly to a conspicuous spiral varix at the base. There are about 6 fine spiral lines on each whorl, somewhat unequally distributed, the two centre ones being rather the strongest. Aperture involved.

*Relations and Distribution.*—From *Nerinea granulata* this shell is clearly distinguished by its smaller spiral angle, more cylindrical outline, by the fewer number of spiral lines, and especially by the spiral varix at the base of each whorl. With *Nerinea Rœmeri* (i.e. *fasciata*, Rœmer), a common Corallian fossil,<sup>1</sup> its affinities are closer. However, it would seem to have a smaller spiral angle even than the Corallian species, whilst the spiral lines are finer, and little, if at all, granulated. Hence it seems to me not quite identical with the Corallian form.

Each of the Cornbrash *Nerineas* is at present represented by an unique specimen if we except the fragment of a Nerinean cast in the Scarborough Museum.

EXPLANATION OF PLATE IV.

- FIG. 1. *Cerithium* (?) *caninum*, sp.n. Dogger, Blue Wyke. British Museum.  
 ,, 1a. Front view of same specimen.  
 ,, 2. *Cerithium* (?) *caninum*, sp.n. Dogger, Blue Wyke. Leckenby  
 Collection.

<sup>1</sup> See Corallian Gasteropoda.



- FIG. 3, 3a. *Nerinea cingenda*, Phil. Dogger, Blue Wyke. Leckenby Collection:  
 ,, 4, 4a. *Nerinea cingenda*, Phil. Same locality and Collection.  
 ,, 5, 5a. *Nerinea cingenda*. Young specimen. Dogger, Blue Wyke. York  
 Museum.  
 ,, 6, 6a. *Nerinea*. Dogger, Blue Wyke. Leckenby Collection.  
 ,, 7. *Nerinea*. Whitwell Oolite. York Museum.  
 ,, 8. *Nerinea*, Millepore Rock, Cloughton. Herries Collection.  
 ,, 9, 9a. *Nerinea cingenda*, Sow. Dogger, Blue Wyke. Leckenby Collection.  
 ,, 10, 10a. *Nerinea* "*fasciata*, Voltz." Cornbrash, Scarborough. Leckenby  
 Collection.

(To be continued.)

IV.—REMARKS ON THE GENUS *MEGALICHTHYS*, AGASSIZ, WITH  
 DESCRIPTION OF A NEW SPECIES.

By Dr. R. H. TRAQUAIR, F.R.S., F.G.S.

(PLATE V.)

THERE can be no doubt that the name *Megalichthys* was originally suggested to Agassiz by the gigantic teeth of the great round-scaled fish first brought into notice by the researches of Dr. Hibbert, in the quarries of Burdiehouse, though indeed some of its remains had long previously been figured by Ure in his "History of Rutherglen and East Kilbride." Incontrovertible evidence of this may be found by referring to the Proceedings of the British Association for 1834, and to Dr. Hibbert's original memoir on the Burdiehouse Limestone published in the Transactions of the Royal Society of Edinburgh, vol. xiii. 1835. But with the remains of this enormous creature were also associated and confounded certain rhombic glistening scales, belonging really to a considerably smaller fish of a totally different genus, and when Agassiz, subsequently to the meeting of the British Association at Edinburgh in the year above quoted, found in the Museum at Leeds a head of this latter form, or at least of an allied species, he adopted *it*, by description and by figure, as the type of his *Megalichthys Hibberti*,<sup>1</sup> relegating the other to the genus *Holoptychius*. This latter, the real "big fish," is now known as *Rhizodus Hibberti*, the founder of the genus being Prof. Owen; and though it may be a matter of regret that it did not retain the name *Megalichthys*, the laws of zoological nomenclature do not admit of any alteration now.

The brilliantly enamelled scales, head-plates, and teeth of *Megalichthys* are among the commonest vertebrate remains found in the estuarine beds of the Carboniferous epoch in Great Britain; nevertheless, specimens showing the fish itself in any but a very fragmentary state are rare, and though the head is very well known, from the magnificent specimen at Leeds figured by Agassiz, no concise description of the configuration of the body or of the arrangement of the fins has yet been given. It was classed by Agassiz in his heterogeneous group of "*Sauroides*," but the resemblance of its scales and head-plates to those of the Old Red Sandstone genera *Osteolepis* and *Diplopterus* did not escape the attention of Sir Philip

<sup>1</sup> Poissons Foss. vol. ii. pt. 2, pp. 89-96, pl. 63, 63a, and 64.

Egerton, who, in Morris's "Catalogue of British Fossils," proposed its reference to the family of "Sauroidei-dipterini" (*Sauroidei-dipterini*) instituted by Agassiz for *Dipterus* and the genera just mentioned. From this group, however, M'Coy very properly struck out *Dipterus*,<sup>1</sup> which from its rounded scales he classed as a "Coelacanth," and which we now know is in fact a Dipnoan, allied to *Ceratodus*. The probable position of *Megalichthys* in the "Sauro-dipterini" was also indicated by Pander, who mentioned its close relationship to *Osteolepis* in the arrangement of its head-bones, the shape of its scales and teeth, and, above all, in the microscopic structure of its hard parts, though he also seemed to hesitate on account of our want of knowledge of the conformation and position of its fins.<sup>2</sup> A similar opinion, coupled with a similar hesitation, is expressed by Prof. Huxley in his well-known essay on the Classification of the Devonian Fishes.<sup>3</sup>

Prof. Young, in a paper on "Carboniferous Glyptodipterines,"<sup>4</sup> makes some observations on *Megalichthys*, including a statement that "since 1861 specimens illustrating the form of the fins have been acquired by the Museum (Jermyn St.); but the description and illustration of these parts are reserved." I am not aware of any account of these specimens having been yet published. An important point is however his abolition of M'Coy's genus *Centroodus*, as a mere synonym of *Megalichthys*. *Centroodus* was founded upon a detached tooth from the Coal-measures of Carlisle, Lanarkshire.

Mr. J. Ward, in a paper on the fishes of the North Staffordshire Coal-field, classes *Megalichthys* in the family Saurodipterini, and states, moreover, that in a specimen in his collection the pectoral fins are well preserved;—"They are lobate, *i.e.* the central portion, of the fin is covered with scales, the fin-rays forming a fringe round the lobe."<sup>5</sup>

There can be no doubt that the position of *Megalichthys* is in the family of Saurodipterini, as defined by Pander, and adopted by Huxley and other writers. In every matter of "family" importance its structure conforms closely to that of *Osteolepis*.

The resemblance of the scales in external form is sufficiently obvious to every one, and their close correspondence in microscopic structure may be seen by comparing the figures of transverse sections given by Williamson in *Megalichthys*,<sup>6</sup> by Pander in *Osteolepis*.<sup>7</sup>

As regards the osteology of the head, the resemblance is exceedingly close between *Megalichthys* and the Old Red Saurodipterines, as is at once evident on comparing the figure of the head of *Megalichthys* given by Agassiz with those of *Osteolepis* given by himself, by Hugh Miller,<sup>8</sup> and by Pander. It is not within the scope of the present paper to enter into a minute or even a general account of

<sup>1</sup> British Pal. Foss. pp. 590-502.

<sup>2</sup> Die Saurodipterinen, &c., des devonischen Systems, p. 5.

<sup>3</sup> Dec. Geol. Survey, x. 1861, p. 12

<sup>4</sup> Quart. Journ. Geol. Soc. vol. xxii. 1866, pp. 596-608.

<sup>5</sup> North Staffordshire Nat. Field Club; Addresses and Papers, Hanley, 1875, p. 228.

<sup>6</sup> Phil. Trans. 1849, pl. xlii. fig. 18.

<sup>7</sup> Saurodipterinen, etc., pl. v. fig. 8.

<sup>8</sup> Footprints of the Creator.

Saurodipterine cranial osteology ; a few points may however be conveniently alluded to.

1. The polygonal plates covering the ethmoidal region between the frontals and the præmaxillæ are often more or less distinct in *Megalichthys*, as in small specimens of *Osteolepis*; often they are fused with each other, and with the adjacent bones named above, as seems always to be the case in *Diplopterus*.

2. Though Agassiz made a singular mistake with regard to the nasal openings of *Megalichthys*, he was perfectly correct in recognizing the anterior position of the orbit, and in assigning to it a situation exactly corresponding to that in *Osteolepis*. Prof. Young, of Glasgow, has, however, in a brief notice of a head of *Megalichthys* belonging to Mr. John Smith, Kilwinning, Ayrshire,<sup>1</sup> stated that the two outer plates of the posterior half of the cranial shield, which he calls "anterior frontal" and "squamosal" (*posterior frontal* and *squamosal* of the nomenclature adopted by myself), bound the orbit above. This would certainly put the orbits into a position very different from that which they occupy in *Osteolepis*. By the kindness of Mr. Smith, I have had an opportunity of examining the specimen in question, and though I find that on one side there is in the position indicated a triangular space formed by a displacement of the adjacent cheek-plates, I fail to see how it can be interpreted as an orbit, while, on the other hand, the position of the real orbit can, I think, be readily enough recognized in the place where we would expect to find it.

3. I have not seen in any specimen of *Megalichthys* the foramen which occurs between the frontal bones in *Osteolepis* and *Diplopterus*,

4. Although omitted in Miller's and Pander's figures, lateral jugular plates are undoubtedly present in *Osteolepis* and *Diplopterus*, as well as in *Megalichthys*.

The microscopic structure of the teeth of the Old Red Sandstone Saurodipterines is not yet fully elucidated; so far however as external shape goes, there is nothing of sufficient importance to exclude *Megalichthys* from the group.

Then as regards the fins. The Saurodipterini have obtusely lobate pectoral and ventral fins, two narrow dorsals, one similarly shaped anal, and a caudal, which may be heterocercal (*Osteolepis*) or diphycceral (*Diplopterus*). *Triplopterus* of McCoy, supposed by him to have only one dorsal fin, is a genus which is really non-existent, as it was founded on a specimen of *Osteolepis* compressed in such a manner as to show both ventral fins, one of which was mistaken for the single dorsal. The dorsal fins vary in position in *Osteolepis* and *Diplopterus*, being in the latter opposite the ventrals and anal respectively, while in *Osteolepis* the first dorsal is in advance of the ventrals and the second opposite the space between the ventrals and the anal. Now we have already seen that the lobate form of the pectoral in *Megalichthys Hibberti* was not unknown; it is noticed by Mr. Ward,<sup>2</sup> and was indeed incidentally alluded to long before by Agassiz<sup>3</sup> himself, in describing what he supposed to be the ventral

<sup>1</sup> Pr. G. S. Glas. iii. 1868, 202-3.    <sup>2</sup> *l.c.*    <sup>3</sup> Poiss. Foss. du vieux Grès rouge, 63.

fin of *Glyptolepis*, but which was in reality a portion of the pectoral.<sup>1</sup> A specimen from the Coal-measures of Dalkeith, in the Edinburgh Museum of Science and Art, shows also very clearly the obtuse scaly central lobe, with its fringe of fin rays.

As regards the other fins, their number and position are clearly shown in a specimen from the Coal-measures of Airdrie, Lanarkshire, in the British Museum. There are two posteriorly situated dorsal fins, which are placed as in *Diplopterus*, the first opposite the ventrals, the second very nearly opposite the anal. Part of the caudal is shown, but it is unfortunately not in a very perfect condition.

The best display which I have seen of the fins of *Megalichthys* is, however, the specimens from Burdiehouse, which form the especial subject of the present communication.

No doubt, in applying the name *Megalichthys Hibberti* to the specimen at Leeds, Agassiz believed that he had before him the head of the same species, whose rhombic enamelled scales he had previously seen from Burdiehouse at the Edinburgh meeting of the British Association: there was not indeed material at the time for deciding otherwise. But the Burdiehouse *Megalichthys* is now represented by more than a few detached scales and bones, the entire contour of the fish, the arrangement of the fins and many details regarding the head being displayed in specimens in the Edinburgh Museum and in other collections. Now there are certain points which satisfy me pretty fully that the Burdiehouse fish is different specifically from the common Coal-measure form, of which the head at Leeds is the type, and it might indeed be disputed whether the former has not a prior claim to the specific name "*Hibberti*," especially as some of its scales and bones were actually figured under that name, along with remains of *Rhizodus*, by Dr. Hibbert in his classical memoir before the publication of Agassiz's account of the latter in the "Poissons Fossiles." But the fact that Agassiz, the founder of the genus and species, definitely adopted the Leeds specimen as the type of the first scientific description of *Megalichthys Hibberti*, coupled with the natural feeling that except on really imperative grounds it is not wise to disturb long-established names, is, I think, sufficient justification for allowing it to retain the name which it has borne now for forty years.

Proceeding now to the description of specimens, the first which may be noticed is one in the Edinburgh Museum (Hugh Miller Coll.), which is pretty entire though small (Pl. V. Fig. 1). It measures  $10\frac{3}{4}$  inches in length, though it must be noted that the rays of the caudal fin are somewhat frayed and broken at their extremities: the greatest depth of the body is  $1\frac{3}{4}$  inch; the length of the badly-preserved head is  $2\frac{5}{8}$  inches. The pectoral fin is not shown, but all the others are, though perhaps not in so complete a state of preservation as might be wished. There are two dorsal fins, of which the anterior one is the smaller, and commences  $6\frac{1}{4}$  inches from the front, while the second arises  $1\frac{1}{2}$  inch further back. The ventral arises opposite a point rather behind the origin of the first

<sup>1</sup> Pander, *op. cit.* p. 68; Huxley, *op. cit.* p. 7.

dorsal, while opposite the second dorsal is an anal fin of moderate size, but whose rays are unfortunately rather broken up. The caudal is pretty well shown, but not so well as in the next specimen, in which the form of the tail and of the second dorsal and anal are exceedingly well displayed. Fig. 2 represents the caudal extremity of this specimen, which is 14 inches in length, but originally it must have been considerably longer, as it wants the head, and I should imagine also a good bit of the body. The caudal fin here shown may be said to be somewhat intermediate between the diphyccercal and heterocercal types, at least it is not quite so heterocercal as that of *Osteolepis*, and in general form reminds us of that of *Tristichopterus*. Rays arise from both the upper and lower margins of the body-continuation, but those of the lower side commence in advance of those of the upper. After the commencement of the rays, the upper margin of the body-prolongation slopes very little downwards, while on the other hand the lower one slopes very rapidly upwards; the two margins then converge to a point which is lost among the fin-rays, the scaly covering being lost at this part. The posterior margin of the fin slopes obliquely upwards and backwards, the greater number of the rays arising from the lower aspect of the body-prolongation, while the apex, cut off in the specimen, would seem to be formed by rays arising from the upper or dorsal side of the axis.

On the dorsal aspect of the specimen, and just in front of the caudal, is the second or posterior dorsal fin. The anterior margin of this fin measures  $2\frac{3}{4}$  inches; it has a narrow scaly base, and expands somewhat distally; its apex is bluntly pointed. Opposite this upon the ventral aspect is the anal fin, of the same length, but rather more lanceolate in shape.

The pectoral fins are well shown in a specimen in my own collection: they are short, and obtusely rounded, with an obtuse basal scaly lobe fringed with rays. The lobation of the ventrals seems to be not quite so marked. All these fins are composed of numerous closely-set rays, divided by very close transverse articulations, except quite at their proximal extremities, which are covered by the scales of the body: they dichotomise towards their extremities, and their free surfaces are brilliantly ganoid and punctated like the scales.

*Scales.*—The scales present the same appearance externally as in *M. Hibberti*, and are not to my eye distinguishable. Their internal surfaces are seldom seen, and appear sometimes furnished with the prominent keel seen in *M. Hibberti*, while in other instances this appears to be absent.

*Vertebral Column.*—A specimen in the Museum of Science and Art shows the presence of ring-shaped vertebral centra, as in *M. Hibberti*.

*Head.*—Fig. 3 represents, reduced in size, a very instructive head in the Hugh Miller Collection, in which the cranial shield is very well shown. This is as usual divided across into two portions, an anterior or fronto-ethmoidal, and a posterior or parietal; but in this instance the anterior portion is longer by one-seventh than the posterior one in *M. Hibberti*; on the other hand, the posterior moiety is the longer. Taking the parietal part of the buckler, it may also

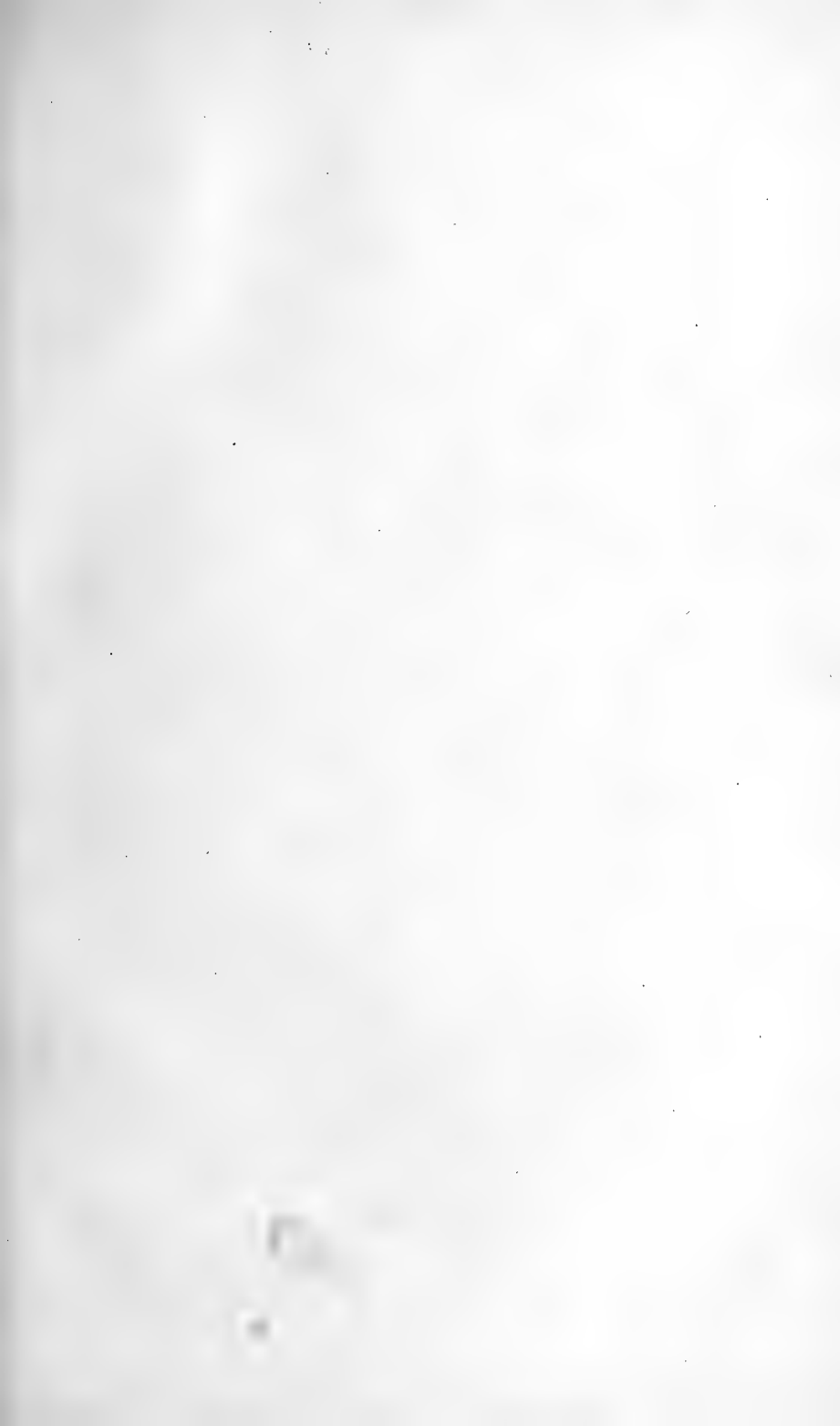
be seen to differ in shape from that in the ordinary species, in being proportionally broader in front. The plates of which it is composed seem pretty completely fused together, as the indications of their original separation are slight and principally seen posteriorly. Near the hinder margin are also seen certain grooves like those observable in a similar situation on the cranial shield of *Osteolepis* and *Diplopterus*. One of these passes transversely across the middle of the squamosal element: another is V-shaped, one leg of the V continuing the direction of the former across the posterior part of the parietal, from the outer margin to about the middle of the bone, whence the other leg then diverges outwards and backwards towards the posterior margin. These grooves in *Osteolepis* were supposed by Pander<sup>1</sup> to indicate the original presence here of elements equivalent to the transverse supratemporal chain in *Polypterus*, but a careful examination of the under surface of Saurodipterine cranial shields, showing the sutures and centres of ossification, proves that this is not the case, and that the grooves in question are mere superficial markings. The supratemporals are according to my interpretation represented in this family and in allied forms by the three plates, one median and two lateral, which lie immediately behind the shield, and which are lettered by Prof. Huxley in *Glyptolæmus* as supraoccipital and epiotics.<sup>2</sup> The anterior or fronto-ethmoidal part of the shield in this specimen has its constituent elements completely ankylosed, so that not even the frontals are separately recognizable. On each side the margin is slightly excavated for the upper boundary of the orbit; the anterior margin is convex and expanded to form the rounded snout; the nasal openings are not visible. The whole surface of the buckler, besides the minute punctation of the glittering enamel, is covered with small scattered rounded openings, apparently the orifices of "mucous" ducts.

The posterior part of the cranial shield, detached, is well shown in another specimen. This, when compared with the corresponding part in *M. Hibberti*, shows the same greater proportional breadth in front seen in the last described example, but the sutures between its six constituent bones, viz. the paired parietals, squamosals and posterior frontals, are distinctly marked, and the slime-canal apertures, similarly scattered over the surface, are very much smaller. The peculiar grooves on the posterior part of the shield, alluded to above, are also here so slightly marked as to require a lens for their definition.

Returning to the former head (Fig. 3) we find that though the operculars are gone, and most of the other superficial bones fractured and badly seen, the maxilla and mandible occupy their positions. The *maxilla* (*mx*), the anterior portion of which is deficient in this specimen, at once attracts attention by its narrow shape. It is shown in its entirety in the specimen represented in Fig. 4, where it is seen to differ from that of *M. Hibberti* in the much smaller depth of its posterior expanded portion, that being contained  $4\frac{1}{3}$  times in its length, whereas in that species it is only contained about 3 times.

<sup>1</sup> *op. cit.* p. 11.

<sup>2</sup> *op. cit.* p. 2, fig. 2. On this subject see my memoir on *Tristichopterus alatus*, Trans. Roy. Soc. Edinb. vol. xxvii. (1875) p. 386.



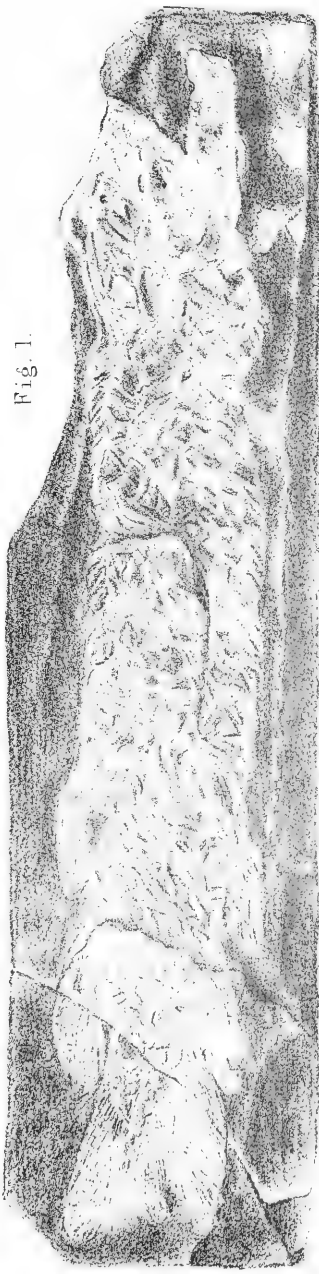


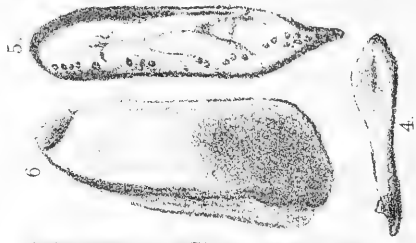
Fig. 1.



2



3



5.

6

4

R. H. Traquair del.

*Megalichthys labiceps*, Traquair



The same fact being observable in two separate specimens, it cannot be looked upon as a mere accidental variety in shape.

The *mandible* (Fig. 5) seldom exhibits the oblique groove, indicating the original separation of the dentary element, which is so often observed in *M. Hibberti*. Jugular plates were present; *principal* (Fig. 6), *median* and *lateral*, but these do not call for any special comment; nor do the opercular bones, which are sometimes found detached, and exhibit the ordinary shape.

The teeth are seldom seen: when visible, they appear rather smaller in proportion than in *M. Hibberti*, though of the same general appearance. The scales and superficial bones of the head have their free surface covered with a layer of smooth and brilliant ganoine, which under a lens shows a minute punctation quite similar to that in *M. Hibberti*.

The difference in shape of the maxilla and of the parietal portion of the cranial shield are to my mind sufficient evidence that the *Megalichthys* of Burdiehouse is specifically different from *M. Hibberti*; but I have no doubt that when both species are more minutely examined and described, many other points of distinction will be found. For the form above described, which is certainly still less likely to be confounded with either the *M. coccolepis* or *M. rugosus* of Young and Thomson,<sup>1</sup> I propose the name of *Megalichthys laticeps*. Possibly its remains may include those of *Diplopterus Robertsoni*, Ag.; but as this is a mere MS. name, to the original of which there is now no clue, it must be simply cancelled.

Its remains are for the most part considerably smaller than those of the common Coal-measure species, though patches of scales occur showing that it sometimes attained a size nearly as great.

The fact that this species, of Calciferous Sandstone age, is distinct from any yet found in the Coal-measures, is in accordance with the result of all my experience in the domain of British Carboniferous Ichthyology, namely, that very few species of Ganoids are common to the strata above and below the Millstone Grit. As regards *Megalichthys*, however, it must also be mentioned that its scattered remains are not uncommon in the estuarine beds of the Scottish Carboniferous Limestone Series, but as yet I have seen no specimen on which any secure determination of species can be founded.

#### EXPLANATION OF PLATE V.

All the specimens figured are in the Edinburgh Museum of Science and Art.

- FIG. 1. *Megalichthys laticeps*, Traq. Entire specimen, reduced: original  $10\frac{3}{4}$  inches in length. Hugh Miller Collection.  
 ,, 2. Hinder extremity of another specimen, showing the second dorsal, anal, and caudal fins: reduced one-half.  
 ,, 3. Head of another specimen showing the cranial buckler, maxilla and mandible: reduced more than one-fourth. Hugh Miller Collection.  
 ,, 4. Maxilla, from another head: natural size. Hugh Miller Collection.  
 ,, 5. Mandible reduced, placed upright to save space: original  $2\frac{1}{2}$  inches long.  
 ,, 6. Principal jugular plate, reduced: original  $2\frac{1}{2}$  inches in length.

<sup>1</sup> Proc. Brit. Assoc. 1869 (Exeter), Trans. of Sections, p. 102. As regards other species of *Megalichthys*, *M. maxillaris*, Ag., was never described or figured; *M. priscus*, Ag., from Orkney, was afterwards referred by Agassiz himself to *Polyphractus* (i.e. *Dipterus*); while *M. Fischeri*, Eichwald, is pronounced by Pander to be portion of the cranial shield of an *Osteolepis*.

V.—SOME GEOLOGICAL NOTES ON THE NEIGHBOURHOOD OF  
NEWBURY, BERKS.

By T. RUPERT JONES, F.R.S., F.G.S.

**T**HE Oyster-bed (*Ostrea Bellovacina*) in the lowest part of the "Woolwich-and-Reading" series is well known as constituting an interesting horizon in the Lower Eocene formation; but, as it is not throughout persistent in the range of this group of strata, every instance of its occurrence is worth recording. It is well known in Berkshire at Clay Hill, Shaw, about a mile N.E. of Newbury; and it occurs further westward near Hungerford (Prestwich, Quart. Journ. Geol. Soc. vol. x. pp. 85 and 87). We now know of its occurrence to the South of Newbury, from the works of the new railway intended to connect Newbury and Southampton.<sup>1</sup>

Thus, at a mile W. by S. from Newbury a temporary well was sunk at about 10 yards on the north side of the first road-bridge after the junction of the new cutting with the main line, and the Chalk was reached at 20 feet below the surface; and on the Chalk lies loamy sand, greenish, containing the well-known Oyster-Shells. This is covered by about 12 feet of the Kennet valley-gravel, and a thin soil.

Continuing the geological observations made along this new cutting, we noted that at about 80 yards south-west of the *second* bridge (nearly  $\frac{1}{4}$  mile from the first), and beneath 6 feet of the coarse mixed valley-gravel,<sup>2</sup> is a brownish tough clay, about 4 feet thick, overlying white sand, sunk into for 3 feet. These appear to belong to the "Reading-and-Woolwich" Series. Further to the S.W., at about 120 yards, is a cutting in a rising ground, with a dark-blue stiff clay (London Clay), covered with five feet of yellow sand (an outlier of Bagshot Sands), which thins out on the slope of the hill towards Newbury, under the valley-gravel, which is four feet thick on the top. The section is not complete here, but a little further on is hollow ground, with a stream, under Cop Hall; and then in another rising ground is a brick-pit in the London Clay, on the Enborne Road, near the line of railway where it turns to the south, and three-quarters of a mile from the well above mentioned.

Further on,  $1\frac{1}{2}$  mile from the well, there is a deep cutting in the London Clay (without any gravel at the top) in Mr. Valpy's Wood (Enborne Lodge). In August, 1882, the writer noticed that the London Clay here has a dip of nearly  $3^{\circ}$  to the south.

The Valley of the En, with the cottages known as Enborne Row, succeeds at 2 miles distance from the well: at a mile and a half

<sup>1</sup> John Drysdale, Esq., C.E., obligingly aided the writer in taking these notes.

<sup>2</sup> In this gravel the writer found a waterworn block of flint-conglomerate, similar to the "Hertfordshire Puddingstone." Some observations on this great river-gravel of the Kennet are recorded in the "Memoirs of the Geological Survey," Explanation of Sheet 12, 1862, p. 46; and "the green sands of the Woolwich-and-Reading beds" are mentioned as having been noticed under this gravel at the Cemetery on the southern side of Newbury, one mile east of the railway-well above mentioned. There are other green sands near the Railway Station on the Greenham side of the town, not far off, but their relationship is not clearly seen.

from the En the new line in its south-easterly course has a deep cutting in Penwood, through Tot Hill. Here the Bagshot Sands, upwards of 30 feet thick, with a dip of about  $3^{\circ}$  to the southward, rest on clay,<sup>1</sup> and are covered with 12 feet of coarse, ochreous, and loamy gravel. The sands at one part of the cutting were seen (in August, 1882) to consist of—at top—

Yellowish, brown, and grey laminated sands, 16 feet.

Brownish-blue shale (bluish inside, brown outside), 4 feet.

Blue-black shale, 6 feet.

White clay, 2 feet 6 inches.

White sand—not cut through when the observation was made.

To return to the Oyster-bed, I was informed by Mr. Drysdale that he had met with these Oyster shells in the railway-cutting by Hockley Hole, 2 miles east of Highclere and 3 miles west of Kingsclere. The Woolwich-and-Reading beds have their outcrop along this line, forming part of the southern limit of the so-called "London Basin." Prof. Prestwich's sections of some localities hereabouts are reproduced in the "Memoirs Geol. Survey," vol. viii. pp. 102, 103.

Recurring to the first part of these Notes, we may say that, *if the dip of the beds be about  $3^{\circ}$  south* (as it is apparently at Enborne Lodge Wood and Tot Hill), the thickness of the Lower Eocene strata between the well and the London Clay near Cop Hall (N. and S. distance =  $\frac{3}{4}$  mile) will be about 60 feet, approximately coinciding with the known thickness of the Woolwich-and-Reading series on the other side of Newbury.

---

## VI.—A FAULTED SLATE.

By G. H. KINAHAN, M.R.I.A.

**I**N the interesting description of a faulted slate (GEOL. MAG. Jan. 1884, p. 1) by Mr. J. J. Harris Teall, the writer appears to consider that all faults are due to up-and-down movements; while he seems to ignore the horizontal or transverse heaves, that is, movement of the strata from side to side.

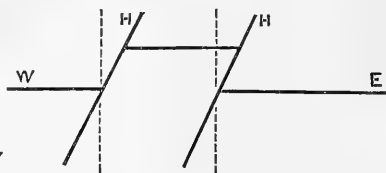
In the newer strata, which are not much moved from their original horizontal position, such as those of the South Staffordshire Coalfield, or of the Weald, the majority of the dislocations appear to be due to upward or downward movement; but this is not the case among the older contorted and crumpled rocks, where in general the horizontal heaves usually equal, if they do not exceed, the up-and-down faults in number. Consequently, while reverse faults are rare in nearly horizontal rocks,<sup>2</sup> they are not uncommon among the contorted and crumpled strata.

A good example of one of these reverse faults occurs in the Cronebane Mineral Channel, co. Wicklow. To the west there is a left-hand heave that jumps the lode northward, but further east there

<sup>1</sup> This now forms the floor of the cutting and gives rise to slips. It is probably the London Clay.

<sup>2</sup> Those that I have been able to examine appear to be more the result of a horizontal heave, than of a thrust upward.

is a right-hand heave that jumps the lode southward, adding to the lode an equal length to that which in the perpendicular was cut off by the left-hand heave. This lengthening of the lode could not have taken place by the means of an upward or downward throw, unless the strata alongside the right-hand heave was shoved upward; while it could quite easily be due to a northern heave of the strata between the two parallel fault lines.



H. H. = "Heave."

If we now turn to that beautiful portrait for which we have to thank Mr. Teall, we find reverse breaks, but on a very small scale. In the portion below the main fault, in the riban between the two dark portions, we have, beginning at the bottom, *R.H.* (a right-hand heave); *L.H.* (a left-hand heave); *L.H.*; *R.H.*; *R.H.*; and *L.H.*; the left-hand heaves being reverse faults; but the overlaps are not well exemplified, on account of the faults being perpendicular to the layer. If, however, we go above the main fault, we find a faulted riban in the light portion; this gives, going up from the main fault; *R.H.* (a right-hand heave); *L.H.* (a left-hand heave); *R.H.*; *L.H.*; *L.H.*; *L.H.*; *R.H.*; *R.H.*; *L.H.*; *L.H.*; and *R.H.*, the three principal left-hand heaves being oblique to the riban, and therefore causing overlaps. It is also worthy of observation that most of the faults in this riban do not extend out of the light portion into the dark; also, that the margin of the latter does not coincide with the plane of the riban; this can also be seen, but not so conspicuously, in the portion to the south of the main fault.

These faulted slates and the riban are very interesting, and have long attracted my attention. The riban in general is supposed to be the stratification; but I have found in various places in the Carboniferous slate of the co. Cork, in some beds in the Killaloe slate quarry, and in the slate veins of Slieverne, co. Wexford, the riban crossing the vein. This is very conspicuous in the variegated slates of the latter locality, as the veins extend eastward and westward, while the riban crosses them in wavy lines, sometimes dipping eastward, other times westward. I do not, however, mean to say that the riban never coincides with the stratification, because, as far as my experience goes, it in general does.

Somewhat similarly these minute faults appear to be confined to certain beds, while they do not extend into the strata above or below. I have observed this in beds of slate in the cos. Cork, Waterford, Wexford, Wicklow, and Galway; while the same thing occurs but on a much larger scale in the Lough Muck beds (Silurians), near the north boundary of the co. Galway, a certain series of ribaned shales being excessively faulted, the faults not extending into the beds above and below them. The fact that the beds thus faulted are of unequal thicknesses, as can be seen in the lower portion of Mr. Teall's Plate, has lead me to believe that these dislocations

are not faults, in the ordinary sense of the word, but heaves due to the contraction of an individual bed or of a series of beds. An oblique riban in certain argillaceous beds, has already been discussed in a paper read before the Geological Society of Dublin (Nov. 11, 1863).

---

VII.—ON CHANGES OF CLIMATE DURING LONG PERIODS OF TIME, AND THE CONJOINT ACTION OF PRECESSIONAL MOVEMENTS AND OF THE ELEVATION AND DEPRESSION OF MOUNTAIN RANGES IN PRODUCING THEM.

By JOHN GUNN, M.A., F.G.S.

**I**N my former Paper (see GEOLOGICAL MAGAZINE, 1884, Decade III. Vol. I. pp. 73-78) I endeavoured to show that as the elevation of mountain-ranges caused cold, so their subsidence in long periods of time was the cause of a warm temperature.

Astronomical agencies were expressly excepted from consideration, because they are independent of, and are the same under all changes of the level of the land and the consequent changes of the Fauna and Flora.

My object in this paper is to point out what those astronomical agencies are, such as the Precessional and Perihelionic Cycles, which are constantly in operation.

They are well described in the late Mr. Mitchel's popular work, "The Orbs of Heaven," p. 116, as follows:—

"The line of equinoxes divides the earth's elliptic orbit into two unequal portions. The smaller part is passed over in the fall and winter, causing the earth to be nearer the sun in this season than in summer, and making a difference in the length of the two principal seasons, summer and winter, of some seventeen and a half days. This inequality, which is now in favour of summer, will eventually be destroyed, and the time will come when the earth will be furthest from the sun during the summer, and nearest in the winter. But at the end of a great cycle of more than 20,000 years, all the changes will have been gone through, and in this respect a complete compensation and restoration will have been effected."

Thus he describes the Precessional Cycle, and then proceeds to give the following account of the Perihelionic. "The Precessional epoch of subordinate restoration will find the perihelion of the earth's orbit located in space far distant from the point primitively occupied. Five of these grand revolutions of upwards of 20,000 years must roll round before the slow movement of the perihelion shall bring it back to its starting-point. 110,000 will then restore the axis of the earth's orbit and the equinoctial line nearly to their relative positions to each other, and to the same region of absolute space occupied at the beginning of this grand cycle."

Next Mr. Mitchel describes the still more extended cycle of all the Planetary orbits, when all their perihelia meet together in their original position. "If now," he says, "we direct our attention to other planets, we find their perihelion-points all slowly advancing

in the same direction. That of the orbit of Jupiter performs its revolution round the sun in 186,207 years, while the perihelion of Mercury's orbit occupies more than 200,000 years in completing its circuit round the sun. To effect a complete restoration of the planetary orbits to their original position with reference to their perihelion-points will require a grand compound cycle amounting to millions of years. Yet the time will come when all the orbits will come again to their primitive positions, to start once more on their ceaseless journeys."

Of these three great astronomical cycles, we have to deal, geologically, chiefly with the first, the Precessional; the second, the Perihelionic, affects us mainly by shortening the Precessional orbit; the third is supposed to act in extremely long periods of time, millions of years, which are invoked by a very high authority, to account for the Great Ice Age.

I propose first to consider the effects produced upon the Fauna and Flora by Precession, which are independent of the elevation of mountain-ranges.

Herbert Spencer (*Essays*, 1863, Second Series, p. 87) gives an admirable and precise detail of the phenomena attendant upon the Precessional cycle.

"It seems," he observes, "beyond all question that there must have been a consequent rhythmical change in the distribution of organisms, a rhythmical change to which we here wish to draw attention, as one cause of minor breaks in the succession of fossil remains. Each species of plant and animal has certain limits of heat and cold within which only it can exist, and these limits in a great degree determine its geographical position. It will not spread north of a certain latitude, because it cannot bear a more northern winter, nor south of a certain latitude, because the summer heat is too great; or else it is indirectly restrained from spreading further by the effect of temperature, on the humidity of the air, or on the distribution of the organisms it lives upon. But now, what will result from a slow alteration of climate produced as above described? Supposing the period we set out from is that in which the contrast of seasons is least marked, it is manifest that during the progress towards the period of the most violent contrast, each species of plant and animal will gradually change its limits of distribution, will be driven back, here by the winter's increasing cold, and there by the summer's increasing heat—will retire into those localities which are still fit for it. Thus during 10,000 years each species will ebb away from certain regions it was inhabiting, and during the succeeding 10,000 will flow back into those regions. From the strata there forming, its remains will disappear; they will be absent from some of the superimposed strata, and will be found in strata higher up. But in what shapes will they reappear? Exposed during the 20,000 years of their slow recession and their slow return, to changing conditions of life, they are likely to have undergone modifications; and will probably reappear with slight differences of constitution, and perhaps of form—will be new varieties, and perhaps new species."

As these are observations well known to geologists, it is unnecessary to do more than refer to them.

It may be safely affirmed that there is no part of the world in which, from the continuity and duration of the deposits, the effects of the Precessional movements are more clearly and fully developed than in the County of Norfolk. The consequence of this is that, if the definite extent and number of these deposits could be ascertained, their precise age and duration would also be arrived at, by multiplying them by the length of each Precessional cycle; and if five such can be counted, then the Perihelionic will be completed, amounting to 110,000 years.

In the circumpolar regions the Precessional agency is very powerful, from the accumulating effects of the greater length of  $17\frac{1}{2}$  days of the summer portion of the earth's orbit at either Pole alternately. This is unceasingly going on, adding to and diminishing the store of ice and snow in the Arctic and Antarctic regions by turns. And wherever the more powerful and violent phenomena of the elevatory process of mountain-ranges may be traced, in concurrence with Precession, the result is very great.

This is shown in Sir C. Lyell's account of the glaciated condition of Greenland, Student's Manual, p. 147.

This is so well known that a reference to it also will suffice.

“Greenland is a vast unexplored continent buried under one continuous and colossal mass of ice that is always moving seaward, a very small part of it in an easterly direction, and all the rest westward, or towards Baffin's Bay. All the minor ridges and valleys are levelled and concealed under a general covering of snow, but here and there some steep mountains protrude abruptly from the icy slope, and a few superficial lines of stones or moraines are visible at certain seasons, when no snow has fallen for many months, and when evaporation promoted by the wind and sun has caused much of the upper snow to disappear. The height of this continent is unknown, but it must be very great, as the most elevated lands of the outskirts, which are described as comparatively low, attain altitudes of 4000 to 6000 feet. The icy slope gradually lowers itself towards the outskirts, and then terminates abruptly in a mass about 2000 feet in thickness, the great discharge of ice taking place through certain large friths, which at their upper ends are usually about four miles across. Down these friths the ice is protruded, in huge masses, several miles wide, which continue their course grating along the rocky bottom like ordinary glaciers long after they have reached the salt water. When at last they arrive at parts of Baffin's Bay deep enough to buoy up ice-bergs from 1000 to 1500 feet in vertical thickness, broken masses of them float off, carrying with them on their surface not only fine mud and sand but large stones. These fragments of rock are often polished and scored on one or more sides, and as the snow melts they drop down to the bottom of the sea, where large quantities of mud are deposited, and this muddy bottom is inhabited by many molluscs.”

The extent to which the glaciers and icebergs from Greenland

and other districts are carried sea-ward bears most importantly on the geology of the county of Norfolk. Precisely as Lyell describes them, the Boulder-clays with striated rocks, and containing arctic shells, appear to have been stranded and impinged upon the shores of the eastern coast. A striking instance of this, north of Cromer, was pointed out on an excursion of the British Association in 1868, where an iceberg seems to have driven up the Laminated beds, and as a proof that they had been imported from the north-east, it may be stated, on the authority of Mr. Lartet, that no Boulder-clays are discovered on the French coast or in France.

The effects produced by these glaciers and icebergs appear to belong to the concurrent agency of the elevation of mountain heights, and Precessional movements, and it is difficult to separate the one from the other. In this country we may observe the peaks of mountains, which have never been submerged, projecting above the lowlands, as it were islands above the sea, just as islands may be observed rising above the Pacific Ocean.

In order to understand what the Northern Hemisphere has undergone, we may with advantage turn our attention to what is now passing in the Southern Hemisphere. So far as its condition can be made out through the observations of voyagers and charts, there appears to be a reproduction of the so-called Glacial epoch, just as it prevailed in the Northern Hemisphere. There is the like over-spread of ice and snow, and numerous islands exist in the adjacent ocean, which, if upraised, would form the mountains of a continent or vast tract of land, so that it is difficult not to recognize a correspondence between the present condition of the Antarctic and that of the Arctic during the Glacial epoch.

This correspondence is well described by the Rev. W. S. Symonds, F.G.S., in his admirable treatise on the "Severn Straits," page 51.

"The Antarctic Continent," he observes, "may be said to be passing through a Glacial epoch. Ships cannot pass the 70° of latitude for ice, and the Antarctic lands are not known to possess a single land animal. The Ice King reigns everywhere.

"What the Antarctic regions are now, the Arctic regions of the distant north must have been during the Glacial periods, and the musk-ox, the polar bear, the walrus, and the rein-deer, must have migrated southwards, for they could not have existed there."

With respect to the causation of these Glacial phenomena at either Pole, we have a remarkable and beautiful coincidence of cause and effect, the greater length of the earth's orbit traversed in the summer portion, compared with that traversed in the winter portion, causes an alternate increase and diminution of heat and cold in the two hemispheres, as we have seen, and a corresponding change in the Fauna and Flora.

Still it must be allowed that there is an excessive irregularity to be accounted for, arising from the conjoint action of the uniform and unvarying Precessional movements, and the changes of climate induced by the elevation of mountain-ranges.



The correctness of this theory is attested by the concurrent elevation of the principal mountains, as the Alps, the Andes, and the Himalayas, at the close of the Miocene, and of its continuance, with some variations probably, through the Pliocene into the Pleistocene periods, when the climax was reached.

A no less strong proof is afforded by the return of a warmer climate and coincident change of animal and vegetable life on the subsidence and partial wearing down of the mountain-ranges.

Besides the above, no other cause has been assigned, which, in respect of power, or time, seems to be admissible.

The Precessional orbit has revolved for ages without any signs of striated and glaciated rocks being left, which was pointed out in my former paper as its relics, and the necessary accompaniments of the elevatory process of mountain ranges.

The Perihelionic orbit consists merely in the repetition of five Precessionals, and mainly acts upon the earth by reducing the length of the Precessional.

With respect to the larger compound orbit, which requires millions of years for its completion, it is obviously too lengthened and extensive to fall in with, or to act upon, the shorter and more limited changes that have been brought under our notice.

In regard to the views of those who would confine the agency of all the causes of glaciation to the annual revolutions of our Globe, they appear to be scarcely less extravagant, than the having recourse to the most extended orbit of the Heavenly bodies that astronomy can supply, in order to account for the Great Ice Age or Glacial Epoch.

On these grounds I humbly submit that the elevation of mountain-ranges, from whatever source they may arise, and their alternate subsidence or depression, offer, in conjunction with the Precessional movements, the most probable solution for the changes of Climate and of the Fauna and Flora.

---

#### VIII.—NOTES AS TO POSITION OF MOA BONES IN NEW ZEALAND.

By CHARLES SMITH, Esq.

[THE following list of localities in New Zealand where the remains of the *Dinornis* have been discovered has been most obligingly drawn up for me by Mr. Charles Smith, an old resident in New Zealand, and I gladly publish it as a useful list for reference. —EDIT. G. M.]

##### NORTH ISLAND, WEST COAST.

A few bones have been found on the coast at Awitu, about six miles south of Manukau Harbour. They were six feet from the surface, and belonged to *Dinornis giganteus*.

Moa bones are continually found in many places on or near the shore from about the Waingongoro River southwards, especially in the sand flat Te Rangatapu near the mouth of the Waingongoro. At the Awamoa Creek and about the Wanganui Heads. They are in the sand hills, often in little heaps which are noticed when partly uncovered by the wind.

They are often in and around native ovens and frequently mixed with fragments of egg shells.

Some bones were found about the sides of Evans' and Lyall's Bays, Wellington Harbour.

#### ON THE EAST COAST.

A few bones have been found in the North between Ngunguru and Whangarei Heads; the exact place is an indentation of the coast between Pataua and Kowhaitaki Creek, on the sand hills.

Also on the coast opposite the Island of Kawau.

A few bones have (I think) been found at Tauranga.

A few bones have been found in Poverty Bay.

A few in Hawkes Bay, scattered and broken. They are generally near the mouths of rivers.

#### SOUTH ISLAND (BEGINNING AT THE NORTH).

Bones have been found in some large Limestone Caves near Collingwood.

Also, near Cape Campbell, about four or five miles to the north-west between the sea and a lagoon.

Again about five miles to the south of the Cape near the mouth of a creek.

A nearly perfect egg was found at the Kaikora Peninsula buried with a human body.

Very large deposits of loose bones were found near Montunau in clay, gravel and peat, mostly *Dinornis elephantopus*, a few of *D. casuarinus* and *D. didiformis*.

Another large deposit (distinct from the last, I think) was found at Glenmark, near the mouth of the Waipara.

Large deposits were found at Moa-bone Point Cave near Sumner, N. of Banks' Peninsula. The cave was cut into in making a road from Christchurch to Sumner. Also near the same place, at the head of the Avon and Heathcote estuary, with fragments of shells, the bones belong principally to *D. robustus*.

Bones have also been discovered in the Malvern Hills

Also at the mouth of the Rakaia; and between Lake Ellesmere and the sea fragments of bones are very numerous, but no shells.

All over the Canterbury and Otago Plains bones were found by the earliest settlers, scattered over the surface, and easily seen after fires; many of them belonged to *Dinornis crassus*.

Some bones were found on the banks of the river below Lake Tekapo.

An egg was found near Oamaru.

On a sand spit at the mouth of the Shag River, which confines the stream to near the north bank, Moa bones were found in large quantities; some of the ovens in which some of the fragments were found were below the level of the present high-water mark. The bones belonged principally to *Palapteryx crassus*, *Euryapteryx rheides*, and *Palapteryx elephantopus*, and some to *Dinornis robustus*.

Some bones were found at Island Point, Waikouaiti.

A very perfect skeleton of *Dinornis robustus* was discovered with

portions of integument and feathers near Tiger Hill on Manuherikia plains. It is now in the York Museum.

Some large deposits have been found near Hamilton, in Moa swamp, and some on the surface of Moa flat in the neighbourhood of the Clutha river.

A Moa's egg with embryo chick was found in a road cutting at Cromwell.

Some bones were found in the neighbourhood of Lake Wanaka; also on the south side of Lake Wakatipu in a cave a quarter of a mile from the lake.

In a cave one mile from Queenstown, near the Gorge Road, were found some very perfect double-shafted feathers of the Moa, but no bones.

Some remains were found at the foot of the Obelisk range near Alexandra.

On the Clutha just above Roxburgh a skeleton was found by tunnelling on the bed rock under 40 feet of shingle.

Fragments of bones have been found with broken egg-shells in ovens in the Maniatoto plain, Taieri river.

A neck was found about 40 miles further inland in a cave near Earnsclough valley of the Conroy and neighbourhood of the Dunstan, and some feathers between Alexandra and Roxburgh. Some bones were found in the same district in a gully 5000 feet above the sea.

Between Havelock and the Kaokaoroa valley some bones were found imbedded in limestone.

Remains of the Moa on the west coast of the South Island are very rare. But some have been found at Marsden in the north of the Westland Province.

GOthic HALL, STAMFORD HILL.

CHARLES SMITH.

---

## REVIEWS.

---

I.—DISCOVERIES IN THE MORE RECENT DEPOSITS OF THE BOVEY BASIN, DEVON. By W. PENGELLY, F.R.S., etc. [Trans. Devon Assoc. vol. xv. 1883.]

THE deposits that rest on the Eocene (or Miocene) clays and lignites of Bovey Tracey in Devonshire have yielded a number of interesting remains. These include *Betula nana*, and other species of plants indicative of a colder climate than we have at present; bones of Deer, Ox, and Man; Cockles and Oysters; a Bronze Spear-head, and two stone moulds for casting bronze weapons; a wooden Doll or Idol, probably used as a symbol in phallic worship; and lastly a Canoe. In the paper now before us Mr. Pengelly discusses the evidence he has been enabled to gather respecting the various objects discovered, and their probable ages. Somewhat startling, however, is the conclusion, or rather (as Mr. Pengelly puts it) the Confession of *Faith* (not of *Knowledge*), "That the Canoe found deep in the Clay, below the 'High-Level Head,' at the Great Western Potteries, in the parish of Bovey Tracey, in 1881, is of, at least, Glacial Age."

The Canoe was found twenty feet deep in a bed of Brick-clay, and this again was covered by about ten feet of the "Head," or ordinary accumulation of Clay and Sand, with angular and subangular stones.

Mr. Pengelly states that "its site was not only above the ordinary level of the adjacent rivers, but by estimation fully twenty-two feet above the level reached by the highest floods ever known to have occurred in the district;" and the clay in which the Canoe was found must evidently have been deposited in some depth of water. The suggestion of its Glacial age is unfortunately of a very indirect character. The Bovey Beds are overlaid at the large "Coal pit" by an irregular accumulation, or "Head," of sandy clay with fragments of granite, metamorphic, and other rocks from the north-west; and this has been looked upon by Dr. Heer and Mr. Nathorst as Boulder-clay. Above this are deposits of white clay and sand, and in the former occur *Betula nana* and *Salix cinerea*. These superficial deposits are regarded by Mr. Pengelly as of Glacial age: and as the Canoe was found beneath a similar "Head," the inference is that the Canoe is older than the *Betula-nana* clays.

Of course one might at once question the value of any correlation of "Head" in different places, especially in a river-valley where the older deposits are likely to be re-assorted in the formation of the newer. Mr. Pengelly makes a difference between the above deposits of High-Level Head, and others occupying a lower position—the Low-Level Head. The Doll and Spear-head were found in Low-Level Head. But the Rapier moulds were found in the High-Level Head at Chudleigh Knighton, and they all evidently belong to the same Bronze age. Mr. Pengelly gives reasons for concluding that the moulds were intentionally lodged where they were found, which if true, is a satisfactory way of getting out of the difficulty.

The question is, could the Canoe have been deposited where it was found, without any change in the levels? Might the Bovey Basin have been dammed up, naturally or artificially, in the Bronze period, when we know that Lake-dwellings were in fashion not only amongst Beavers but amongst Men? Of course there is no reason why Palæolithic Men should not have been able to paddle their own Canoes, but we must be content to wait further evidence before we confess the faith announced by Mr. Pengelly.

H. B. W.

II.—CATALOGUE OF THE FOSSIL SPONGES IN THE GEOLOGICAL DEPARTMENT OF THE BRITISH MUSEUM (NATURAL HISTORY); WITH DESCRIPTIONS OF NEW AND LITTLE-KNOWN SPECIES. (Illustrated by 38 Lithographic Plates.) By GEORGE JENNINGS HINDE, Ph.D., F.G.S. 4to. pp. 297. (London, printed by order of the Trustees of the British Museum, 1883.)

WE congratulate Dr. Hinde on the completion of his three years' arduous labours on the Fossil Sponges in the British Museum, which have culminated in the publication of this admirable Descriptive Catalogue.

Every such well-finished piece of work as the present, which forms a solid addition to our knowledge, is like a carefully pre-

pared and polished block added to the Temple of Science, to the building up of which so many earnest workers have devoted their lives.

The group of organisms which form the subject of the present volume had, owing to their obscurity, been only imperfectly worked out or understood in this country by Toulmin Smith, Mantell, Phillips, Sowerby, Benett, but they have in later years been more ably treated by Bowerbank, Carter, and Sollas; and the works of Goldfuss, Roemer, Michelin, Quenstedt, Reuss, Geinitz, de Loriol, Fromentel and especially those of Professor Dr. Karl Zittel, attest the interest taken in this class amongst continental palæontologists.

A more intimate and careful study of the Spongida in the past fifteen years has led most observers to the conviction, that in this primitive group of animals, mere external form is insufficient to enable one to speak definitely, at least, of a great many of the fossil genera. Certain forms, like *Cæloptychium*, *Peronella*, *Ventriculites*, *Craticularia*, seem definite enough; but we are by no means sure that even these can always be determined by external form alone, without recourse to the microscope.

“The classification of the Sponges (writes Dr. Hinde), recent as well as fossil, rests upon the characters of their skeletal structures. The existing forms of the class have been divided into the following orders:—

“1. MYXOSPONGIÆ, Haeckel.

“Sponges destitute of a solid skeleton.

“2. CERATOSPONGIÆ, Bronn.

“Sponges with skeletons of horny fibres.

“3. MONACTINELLIDÆ, Zittel.

“Sponges with skeletons of horny fibres, with cores of uniaxial siliceous spicules, or built up wholly of uniaxial siliceous spicules.

“4. TETRACTINELLIDÆ, Marshall.

“Sponges with skeletons of siliceous spicules, usually with four rays or arms, one generally elongated to form a shaft, the other three disposed in a pyramidal form; uniaxial and star-shaped spicules are also present.

“5. LITHISTIDÆ, O. Schmidt.

“Sponges with skeletons of siliceous spicules, either four-rayed, or irregular in form, which are intimately interwoven together into a continuous mesh.

“6. HEXACTINELLIDÆ, O. Schmidt.

“Sponges with skeletons of six-rayed siliceous spicules, either loosely interwoven together, or organically united to form a continuous mesh.

## "7. CALCISPONGIÆ, Blainville.

"Sponges with skeletons of calcareous spicules.

"The first of these existing orders, the *Myxospongiæ*, is of course quite unknown in the fossil state, and it is also very doubtful whether any remains of the next order, the *Ceratospongiæ*, have been preserved. Certain casts of cylindrical bodies from the Cretaceous system have been regarded as belonging to horny sponges; but in the absence of all other characters but that of outward form, these bodies cannot be definitely placed in this group.

"The *Monactinellidæ* have comparatively few representatives in the fossil state, and they present a striking contrast to the abundance of this order in the present seas. Their rarity as fossils, however, is not to be accepted as an indication of their scanty existence in the past, but is more probably owing to the fact that the spicular structure of these sponges is unsuitable to their preservation as fossils.

"The structure of the *Tetractinellidæ*, like that of the order just mentioned, is also but little adapted to the retention of the form of these sponges in the fossil state; but the constituent spicules of many of these sponges are relatively large and robust, so that they are capable of preservation, and they are frequently met with detached and scattered through the rocks. In some instances they are sufficiently numerous to form thin beds, almost exclusively composed of spicules. It is therefore probable that this order of sponges flourished as abundantly in the seas of the Neocomian period as at the present day.

"Lithistid and Hexactinellid sponges, unlike those of the previous groups, are more numerous and varied in the fossil, than the recent state. The spicular components of the skeleton in these sponges are firmly attached together; consequently the form of the sponge is frequently preserved intact, even in cases where the spicules themselves have subsequently been destroyed. The occurrence of detached spicules and fragments of the skeleton scattered through the rocks plainly shows, however, that only under favourable conditions of fossilization has the form of the sponges been retained, and those now remaining probably comprise but a small proportion of the number which previously existed.

"Fossil calcareous sponges are abundant in certain strata, but they belong to a family which differs to such an extent from existing *Calcispongiæ* that the relationship has been greatly doubted. Recent discoveries, however, prove that the component spicules in the fossil *Calcispongiæ* possess the closest resemblance to those of the living examples of the order."

The formations in which fossil sponges most commonly occur are those with calcareous or arenaceous beds; they are rarely met with in shales or deposits formed from muddy sediments. Cherty layers and nodules of flint frequently abound in fossil sponges. Both arenaceous and calcareous deposits seem to have been favourable to the preservation of Tetractinellid and Lithistid Sponges; for they occur alike in the Lower and Upper Greensands and in the Chalk.

The Hexactinellid sponges on the other hand favour more par-

ticularly the deeper-formed deposits of limestone and chalk, they are more rare in the Upper Greensand. (But Manzoni records them as comparatively numerous in the Miocene of Italy associated with shallow-water organisms.)

The *Calcispongiæ* are most abundant in arenaceous or shallow-water deposits and thus resemble in habitat the living members of this order.

Dr. Hinde furnishes us with much interesting and valuable information as to the alterations produced by fossilization in the structure of sponges, a subject of the utmost importance in dealing with these organisms, when their classification (as already stated) depends entirely on their skeletal structures, not upon the modified forms of the sponge-mass. He points out that "not only does all the soft part of the sponge disappear, but that even the mineral portion is seldom, if ever, in the same condition as in recent spicules; the amorphous silica and calcite have been replaced by crystalline silica and crystalline calcite, as well as by peroxide of iron and iron pyrites; whilst not infrequently the entire mineral structure has been dissolved and removed, leaving the empty moulds of the spicular skeleton in the matrix. As a result of these changes, siliceous sponges now occur with skeletons of calcite, and calcareous sponges with fibres composed of silica. These changes are intimately connected with the character of the strata in which the sponges are imbedded, but the causes producing them have not up to the present been satisfactorily determined. In general the sponges in calcareous strata have undergone the greatest alteration, the siliceous structures being replaced either by calcite or iron peroxide, or dissolved away altogether, whilst the structures of calcareous sponges, in common with the shells of molluscs in the same strata, are oftentimes replaced by silica. In arenaceous or glauconitic strata, on the other hand, the changes, whether of siliceous or calcareous sponges, have been much less extensive than in strata of a calcareous character" (p. 4).

"The first step," says Dr. Hinde, "in arranging a series of fossil sponges in natural order is to ascertain the characters of the spicular skeleton; and as in the majority of examples no spicular structure is preserved on the outer surface, it is necessary to make a section through the sponge in order to discover, if possible, any indications of structure in the interior. It sometimes happens that all traces of the spicular skeleton have disappeared throughout the central portions of the sponge, as well as on the outer surface; and in this case the systematic position of the sponge remains somewhat conjectural. But even when all structure has disappeared in the sponges of certain horizons and localities, we oftentimes find the same sponges from the corresponding strata in other places with their skeletal structures in good preservation." Thus the sponges of the Upper Chalk of Flamboro' and the southern counties of England, in which merely the outer form and canal structure is retained, can be determined by comparison with those from the same geological horizon in North Germany, in which the spicular skeleton remains intact (p. 14).

The following is a summary of Dr. Hinde's tabular list of species arranged in zoological sequence (see pp. 212-222):—

Genera.	Species.	Cambrian.	Ordovician.	Silurian.	Devonian.	Carboniferous.	Triassic.	Jurassic.	Cretaceous.	Tertiary.	
DIVISION I.											
SILICEOUS SPONGES.											
Order MONACTINELLIDÆ, Zittel.....	8	11	...	...	I	I	2	...	I	4	2
" TETRACTINELLIDÆ, Marshall...	6	12	...	...	...	...	2	...	...	10	...
" LITHISTIDÆ, O. Schmidt.....			...	...	...	...	...	...	...	...	...
Fam. Rhizomorina, Zittel.....	17	50	...	...	...	...	...	17	33	...	...
" Megamorina, Zittel.....	8	14	...	...	...	...	I	...	12	...	...
" Anomocladina, Zittel.....	5	5	...	...	I	...	...	2	2	...	...
" Tetracladina, Zittel.....	21	60	...	...	I	...	...	...	59	...	...
Order HEXACTINELLIDÆ, O. Schmidt.											
Sub-ord. <i>Dictyonina</i> , Zittel.....											
Fam. Astylospongidae.....	2	6	...	...	6	...	...	...	...	...	...
" Euretidae, Zittel.....		25	...	I	...	...	...	13	11	...	...
" Coscinoporidae, Zittel.....	4	8	...	...	...	...	...	...	8	...	...
" Mellitionidae, Zittel.....	I	I	...	...	...	...	...	...	I	...	...
" Ventriculitidae, Zittel.....	11	33	...	...	...	...	...	7	26	...	...
" Staurodermidae, Zittel.....	13	20	I	...	2	I	...	10	6	...	...
" Meandrospongidae, Zittel.....	6	22	...	...	...	...	...	I	21	...	...
" Calodictyonidae, Zittel.....	5	6	...	...	...	...	...	...	6	...	...
" Cœloptychidae, Zittel.....	I	6	...	...	...	...	...	...	6	...	...
Sub-ord. <i>Lyssakine</i> , Zittel.....											
Fam. Monakidae, Marshall.....	2	3	...	...	2	...	...	...	I	...	...
" Pollakidae, Marshall.....	2	8	...	2	...	...	5	...	I	...	...
<i>Incertæ sedis.</i>											
<i>Amphispongia oblonga</i> , Salter.....	I	I	...	...	I	...	...	...	...	...	...
<i>Mortiera vertebralis</i> , de Koninck ...	I	I	...	...	...	...	I	...	...	...	...
DIVISION II.											
CALCAREOUS SPONGES.											
Order CALCISPONGIÆ, Blainv.....											
Fam. Pharetrones, Zittel.....	26	105	...	...	...	...	16	42	47	...	...
" Sycones, Haeckel.....	I	I	...	...	...	...	...	I	...	...	...
<i>Incertæ sedis.</i>											
<i>Bactronella pusillum</i> , Hinde.....	I	I	...	...	...	...	...	I	...	...	...
151	399	I	3	14	2	11	16	96	254	2	2

It thus appears that out of a total of 399 species described, there are 292 or about 73 per cent. of siliceous sponges, and 107 or 27 per cent. of calcareous forms. The geological distribution of the group presents some peculiar features. From the Palæozoic rocks only 31 species of siliceous sponges are recorded, and whilst all the different orders of siliceous sponges are represented, the large majority of the forms belongs to the order of the Hexactinellidæ, which is generally regarded as the most highly organized division of the Spongidæ. From the Mesozoic strata, 366 species, or more than nine-tenths of the entire collection, are described, and of these no fewer than 254 species have been derived from the Cretaceous system; whilst 96 species are from the Jurassic and 16 (all calcareous) from the Triassic. Only two species are noted from Tertiary strata, but it must not be supposed that this insignificant number fairly represents the Sponge-life of this era, since numerous forms have in the last few years been discovered in beds of Miocene age in Italy and Algiers, though specimens have not yet found their way into the Museum collection.



The following table is a summary of pp. 223-229:—

FORMATIONS.	DIVISION I. SILICEOUS SPONGES.								DIVISION II. CALCAREOUS SPONGES.		Incertæ sedis.
	Monactinellida.		Tetractinellida.		Lithistidae.		Hexactinellidae.		Calci-spongiae.		
	gen.	sp.	gen.	sp.	gen.	sp.	gen.	sp.	gen.	sp.	
<i>Tertiary or Kainozoic.</i>											
Pliocene, and } Miocene	1	{ 1									
Eocene	1	1									
	2	3									
<i>Secondary or Mesozoic.</i>											
Maestricht Beds and Upper Chalk	3	6	6	10	31	70	29	66	5	7	
Lower Chalk, Chalk-marl, and Grey Chalk	...	...	...	...	6	8	10	14	...	...	
Chloritic Marl and Upper Greensand (Cenomanian)	...	...	...	...	17	32	9	13	9	19	
Gault	...	...	...	...	1	1	...	...	...	...	
Lower Greensand (Neocomian)	...	...	...	...	1	1	3	3	9	23	
Jurassic System	1	1	...	...	9	20	14	31	16	44	1
Triassic System	...	...	...	...	...	...	...	...	...	16	
	4	7	6	10	65	132	65	127	39	109	1
<i>Primary or Palæozoic.</i>											
Carboniferous System	2	2	2	2	1	1	2	6	...	...	1
Devonian	1	1	...	...	...	...	1	1	...	...	1
Silurian	1	1	...	...	2	2	5	10	...	...	1
Ordovician	...	...	...	...	...	...	1	3	...	...	
Cambrian	...	...	...	...	...	...	2	1	...	...	
	4	4	2	2	3	3	11	21	...	...	2
<i>Summary.</i>											
Tertiary	2	3	...	...	...	...	...	...	...	...	1
Secondary	4	7	6	10	65	132	65	127	39	109	1
Primary	4	4	2	2	3	3	11	21	...	...	2
	10	14	8	12	68	135	76	148	39	109	3

One of the results of the modern and more exact method of classification of the Spongiæ by their structure is to remove a vast number of genera and species very familiar to English geologists, especially to those who have made the Cretaceous rocks their study. The old group of *Choanites* of Mantell being composed of a mixture of Lithistid and Hexactinellid forms, has been abolished, as is also the case with *Brachiolites*, *Cnemidium*, *Cupulospongia*, *Discoelia*, *Manon*, *Scyphia*, *Spongia*, *Spongites*, *Spongus*, *Tragos*, *Verrucospongia*, and a number of other genera. In the list of genera and species we do not find any notice taken of *Spongia paradoxica* from the Red Chalk of Hunstanton (Woodward's Geology of Norfolk, p. 54; Morris's Cat. p. 30). This is (*structurally*) perhaps incapable of determination, but it would have been desirable to refer to it, in the index of species.

A very useful feature of this Monograph is the Bibliography at the end (p. 231-237). Marshall's name, however, is not given,

although he is credited with the order *Tetractinellidæ* and the families *Monakidæ* and *Pollakidæ* (Marshall, "Ideen über die Verwandtschaftsverhältnisse der Hexactinelliden," Zeitschr. für Wiss. Zool. 1876). But these are mere sun-spots and cannot be seen by ordinary eyes!

We must not omit to commend the beautiful series of 38 quarto lithographic plates with 503 illustrations of sponges and sponge-structures, reflecting much credit on the lady-artists Mesdames M. Suft and G. M. Herschel, and upon Mr. A. Gawan.

If we bear in mind the fact that every specimen described has been examined microscopically by Dr. Hinde, and, whenever practicable, sections prepared, showing the minute microscopic structure of each species, the labour of the task now completed will be more fully appreciated and understood by our readers. The sections drawn under the microscope have been transferred to stone by Miss Suft.

III.—CHINA. ERGEBNISSE EIGENER REISEN UND DARAUFGEGRÜNDETEN STUDIEN. VON FERDINAND FREIHERRN VON RICHTHOFEN. Viertes Band. Palaeontologischer Theil. Enthaltend Abhandlungen von Dr. WILHELM DAMES, Dr. EMANUEL KAYSER, Dr. G. LINDSTRÖM, Dr. A. SCHENK und Dr. CONRAD SCHWAGER.

CHINA. RESULTS OF PERSONAL TRAVELS AND STUDIES FOUNDED THEREON. Fourth Volume. Palaeontology. Containing Memoirs by Dr. W. DAMES, Dr. E. KAYSER, Dr. G. LINDSTRÖM, Dr. A. SCHENK, and Dr. C. SCHWAGER. 4to. pp. 288, with 15 Woodcuts and 54 Lithographed Plates. (Berlin, Dietrich Reimer, 1883.)

IN spite of the obstacles incident to the collection and transportation of fossils in the course of a series of rapid journeys through a previously unknown country, where the traveller is always exposed to the jealous suspicion and sometimes to the hostility of the inhabitants, Baron Richthofen succeeded in obtaining a fairly large number of fossils from the vast series of sedimentary strata described in the second volume of this work. On his return from China he entrusted the collection for description to several authorities eminent in different departments of palaeontology, and the results of their investigations are contained in the present work, which possesses so much the greater interest since it is the first, with the exception of the short notice of Professor Newberry on the plant-impressions obtained by Pumpelly, in which the localities from whence the fossils proceed are definitely known. Davidson and others have described a few Brachiopods of Devonian age, and Sir R. Owen some Mammalian teeth; but these fossils were procured from the shops of native druggists, who use them extensively for medicinal purposes. The fossils referred to in this work are for the most part of Palaeozoic age; they are now in the Collection of the Royal Mineralogical Museum at Berlin. The author states that the collection, from the causes above referred to, but imperfectly represents the rich fossil fauna abundantly present in the sedimentary strata of the mountainous districts of Northern China, and as the lowest Cambrian

deposits in these areas have suffered but slightly from metamorphic influences, there is reason to hope that more detailed research will lead to the discovery of an earlier fauna than that at present known.

The first memoir, by Dr. W. Dames, is on the Cambrian Trilobites of Liao-tung. Unfortunately the specimens preserved are mere fragments, and mostly consist of the glabella with the fixed cheeks and the pygidia; not a trace of a thorax is present. They are referred to the genera *Conocephalites*, *Anomocare*, *Liostracus*, *Agnostus* and a new genus *Dorypyge*. These Chinese trilobites present an astonishing resemblance to American forms, as well as to those from Norway and Sweden; the differences, in fact, consist in very minute details, which, however, are considered to be of specific value. The general facies of the forms (with the exception of *Dorypyge*) indicates that the rocks in which they occur are homotaxial with the lowest Potsdam Group of North America and the Andrarum Limestone of Scandinavia. From the resemblance of two American species, *Dikellocephalus gothicus*, Hall, and *D. quadriceps*, Hall, from the Quebec group of Utah, to *Dorypyge Richthofeni*, Dames, it is concluded that the rocks containing this species belong to a similar geological horizon. Dr. Dames states that the two above-mentioned American species referred by Hall to *Dikellocephalus* have in reality hardly a single feature in common with type forms of this genus, and they are therefore included in the genus *Dorypyge*.

The second memoir, by Dr. E. Kayser, contains descriptions of two undetermined species of *Lingulella* and of a new species of *Orthis*, *O. Linmarssoni*, from the Cambrian strata of Liao-tung. Entire beds of limestone are filled with this *Orthis*, which has a close resemblance to forms from the Andrarum-Kalk of Sweden, referred by Linmarsson to *O. Hicksii*, Salt., and *O. exporrecta*, Lin.

The next treatise, also by Dr. Kayser, gives descriptions of Middle and Upper Silurian fossils from the mountain district of Tshau-tien. These consist of fragmentary Trilobites belonging to the genera *Asaphus*, *Calymene* and *Trinucleus*; a new species of this latter genus is present in such numbers that the rock is nearly entirely composed of its detached head-shields. The Brachiopoda are represented by the genera *Orthis*, *Leptæna*, *Strophomena*, *Spirifera*, *Rhynchonella*, *Atrypa*, *Merista*, and *Nucleospira*. The majority of the species are identical with the commoner forms which exist in the Trenton, Cincinnati, and Niagara groups of North America, and the Bala and Wenlock series of England and their equivalents in the Baltic Silurian basin.

The fourth memoir, on the Silurian Corals of Tshau-tien by Dr. G. Lindström, has already been noticed in the GEOLOGICAL MAGAZINE.<sup>1</sup>

In the fifth memoir Dr. E. Kayser describes the fossils of Devonian age from South-westerly China. With the exception of three species of Corals belonging to *Chætetes* and *Aulopora*, and two forms of *Spirorbis* and *Cornulites*, they consist of Brachiopods, for the most part of the same genera as are above enumerated from the

<sup>1</sup> Dec. II. Vol. X. 1883, p. 86.

Silurian strata, with the addition of *Pentamerus*, *Cyrtia*, *Strophalosia*, *Productus*, and *Crania*. Of the total number of twenty-eight species, there are but six limited to China, and only two of these can be regarded as characteristic Chinese forms. No fewer than thirteen species, or nearly one-half, are cosmopolitan forms, whilst nine species are also found either in Western Europe, North America, or Australia. But whilst the Devonian fauna of China is thus of a decidedly cosmopolitan character, it has on the whole a nearer relationship to the Middle and Upper Devonian strata of Western Europe than to the corresponding rocks in North America.

A few unimportant Brachiopods, of Devonian and Carboniferous age, found at Tshau-tien, in close proximity to the localities from which the Silurian fossils already referred to were obtained, form the subject-matter of the sixth memoir, by Dr. Kayser.

In the seventh memoir, Herr Conrad Schwager gives a very full and elaborate description of the Carboniferous Foraminifera of China and Japan, illustrated by four plates, drawn and lithographed by the author. Representatives of the following genera are present, *Fusulina*, *Schwagerina*, *Fusulinella*, *Lingulina*, *Tetrataxis*, *Endothyra*, *Valvulina*, and *Climacammina*. In all, fifteen species are described, two of which are also found in Russia, and one occurs in Sumatra. There is a great probability that the rocks in which the Foraminifera are present belong to the upper portion of the Carboniferous Limestone.

The eighth memoir, by Dr. Kayser, treats of the Upper Carboniferous fauna of Lo-ping. All the new species, as well as the most important of those already known, are figured in the accompanying eleven plates. No fewer than fifty-five species are recorded from this locality; they are found in thin beds of limestone in close proximity to productive coal-seams. Amongst these species there is a fish-tooth, believed to belong to a Squalodont; one species of *Phillipsia*; four of *Nautilus*; and three of *Orthoceras*. The Gasteropoda are represented by a single species of *Macrocheilus*, and the Lamellibranchiata include species of *Lucina*, *Allorisma*, *Schizodus*, *Macrodon*, *Pinna*, *Myalina*, *Avicula* and *Aviculopecten*. The Brachiopoda form the most important group; there are twenty-five species belonging to the following genera, *Terebratula*, *Retzia*, *Athyris*, *Spirifera*, *Orthis*, *Streptorhynchus*, *Meekella*, *Syntrielasma*, *Strophalosia* and *Producta*. Besides the above there are a few imperfect Polyzoa and Corals. The abnormal form *Richthofenia* (*Anomia*) *Lawrenciana*, De Koninck, sp., is regarded by the author as an Operculate Coral, but its real character is still doubtful.

A remarkable feature of the Lo-ping fauna is the fact that more than one-half of the species are identical with the commoner fossils of the European and American Carboniferous strata, whilst at the same time there are a number of species which distinctly characterize the Upper Carboniferous strata of Russia in Europe and Western North America, so that the Lo-ping strata most probably belong to the horizon of the Upper Carboniferous.

The second division of the work contains descriptions of the fossil

plants by Dr. A. Schenk, and twenty-five plates are devoted to illustrating the various forms. A study of this fossil flora from many different localities conclusively shows that the Coal-beds of China belong to two different periods, Carboniferous and Jurassic. From the earlier or true Carboniferous about forty species from twelve different localities are recorded, and it appears that the most important and extensive of the known Coal-fields belong to this horizon. From seven other localities nearly thirty species of Equisetacæ, Ferns, Cycads, and Conifers are enumerated, and the identity or close affinity of most of these species with those met with in the Lower and middle Jurassic strata of England, Germany, Russia, Siberia, and Spitzbergen, conclusively shows their relative age. G. J. H.

---

REPORTS AND PROCEEDINGS.

---

GEOLOGICAL SOCIETY OF LONDON.

I.—January 23, 1884.—R. Etheridge, Esq., F.R.S., Vice-President, in the Chair.—The following communications were read:—

1. "On the Serpentine and associated Rocks of Porthalla Cove." By J. H. Collins, Esq., F.G.S.

In a paper read before the Royal Geological Society of Cornwall in November, 1879, the author described the rocks at Porthalla Cove as consisting of much-contorted strata of slaty green and red serpentine and hornblende-rocks, which he regarded as "highly altered Lower Silurian stratified rocks." Prof. Bonney has since (Q. J. G. S. vol. xxxix. p. 1) described the same rocks, and explained the structure of the district quite differently, correlating the rocks with those of his "Archæan metamorphic series" at the Lizard. The author in the present paper argued in support of his previously expressed opinion.

He stated that within a space of little more than 100 yards the following varieties of rocks may be distinguished:—1. Crumpled shales and slates, sometimes containing veins and layers of quartz and flakes of mica; passing into 2, greenish slates of talcose appearance; passing into 3, soft and shaly mudstone; passing into 4, red and green bands of serpentine; often passing into 5, hornblende-schists of the type characterizing the locality; and 6, pinkish or greyish granulite. No. 1 he regarded as belonging to a younger series than the rest; Nos. 2 and 6 are the rocks supposed to represent Prof. Bonney's micaceous group of the Archæan series; and No. 4 was regarded by the latter as intrusive.

The author stated that the slates, shales, serpentine, and hornblende-schist appeared to him to be distinctly interstratified, and the granulite to be distinctly intrusive. At Nelly's Cove, about half a mile north of Porthalla, there are a few thin bands of black limestone, like those of Gerrard's Bay, and also containing fragments of Crinoids; these were regarded by the author as of Lower Silurian age, and as underlying the Porthalla rocks considered by Prof. Bonney to represent the Archæan metamorphic series of the Lizard Head. The author discussed at considerable length the

arrangement and relations of these rocks, and gave chemical analyses of many of them, dwelling especially upon the comparative analyses of a "talcose slate" from Porthalla and of one from the Lizard, the latter regarded as characteristic of Prof. Bonney's Archæan micaceous series at that locality. The differences shown by these analyses he considered incompatible with the identity ascribed to the two rocks. The serpentine of Porthalla he regarded as produced from the hornblende-schist (itself a metamorphosed Silurian rock) by an extreme alteration caused by the action of the magnesian salts existing in sea-water, probably during a period of marine submergence. Although regarding the granulite as well as the gabbro of the district as intrusive, he thought that the existing contortions of the rocks need not be referred to the introduction of any intrusive rock, but to a more general agency, namely, that which produced the ancient axis of elevation off the east coast of Cornwall, in the line of the Eddystone, and parallel to the general granitic axis of the Cornish peninsula.

2. "Outline of the Geology of Arabia." By C. M. Doughty, Esq. Communicated by Prof. T. G. Bonney, D.Sc., F.R.S., Sec. G.S.

The author described the general outline of the geology of a considerable district in the western part of Arabia, over which he had travelled. It was not in his power to enter into details, especially as regarded the sedimentary rocks, because the circumstances under which his journey was undertaken made it impossible to bring back specimens. There was, however, considerable simplicity in the geological structure of the country. The igneous rocks consisted of granites and basalts, the latter breaking through the former. The sedimentary rocks, which are newer than the granites and, in fact, rest upon them, consist of—

(a). A yellowish sandstone, with stains of a reddish or greenish colour and veins of ironstone. In this, for example, the rock-tombs, etc., of Petra have been excavated. These sandstones, in the author's opinion, may be traced as far as Medina, and occur all about Kasim. They often weather in a singular way; pebbles are scarce in them; fossils he had not seen.

(b). The limestone contains bands of flint, and appears to be identical with that which occurs in Palestine, and is, he thinks, probably of Cretaceous age.

(c). Of much later date is a coarse flat gravel which overspreads a considerable tract of country, as, for example, at Mount Seir in Edom, altogether about 250 square miles. The flints are doubtless derived from the limestone, and are often polished by drifting sand. It occurs on plateaux at very considerable elevations above the sea, sometimes forming the highest ground in the neighbourhood; and sections had shown this gravel to be more than 20 feet deep. In it the author had discovered two or three flint weapons of palæolithic type, rude, but very like those of Hoxne or St. Acheul.

The granite by its aspect and mode of occurrence recalls that of Sinai. It is cut by dykes of basalt; now and then the author had observed other intrusive igneous rocks, which he must be content to

classify as traps. The dykes of basalt, however, were not the only modes of occurrence of this rock; there were considerable flows of basaltic lavas and occasional small craters. These volcanic districts bear the name of Harra; the principal are the Aneryid, the Khaybar, and the Kesshub. The last lies between Nejd Arabia and the Mecca country. These masses of lava, etc., are comparatively modern; eruption, indeed, has in one or two localities occurred in historic times, and steam has been seen to issue from certain craters.

II.—February 6, 1884.—J. W. Hulke, Esq., F.R.S., President, in the Chair.—The following communications were read:—

1. "Delta in Miniature.—Twenty-seven Years' Work." By T. Mellard Reade, Esq., F.G.S.

The author described a delta deposit, which, during a period of twenty-seven years, had formed in the Rake reservoir (Rivington Waterworks) from materials brought down by a stream of that name. The reservoir at this part was divided by a road, water communication being maintained by a culvert, once 8 feet high, now almost silted up. The author described the stratification of these deltas; that near the influx of the Rake consisted of peaty matter, gritty sand, gravel, shingle, and boulders of Millstone-grit up to about one foot diameter. The other chiefly of fine sand with some peaty matter. The former covered an area of 2508 yards, with an average thickness of 2 yards; the latter, an area of 430 yards, with an average thickness of 3 yards. These materials had come from the drainage-area of the Rake. This is estimated as 1.176 square mile, and the delta being estimated at 6306 cubic yards, and the time being 27 years, gives, as the annual rate of denudation over the whole area,  $\frac{1}{432}$  inch per annum, or 1 foot in 5184 years. The mean rainfall of the Rake Brook watershed for the last 10 years was 49.57 inches per annum. In this calculation no account is taken of the finer materials which have doubtless been distributed over the rest of the bed of the reservoir. The author pointed out that this rate of denudation was rather more rapid than that of the Mississippi (1 foot in 6000 years), and that the arrangement of the materials under the varying condition of the stream illustrated the phenomena of larger deltas.

2. "On the Nature and Relations of the Jurassic Deposits which underlie London." By Professor John W. Judd, F.R.S., Sec.G.S. With an Introductory Note on a Deep Boring at Richmond, Surrey, by Collett Homersham, Esq., A.M.Inst.C.E., F.G.S.

The wants of the growing town of Richmond, in Surrey, have necessitated the deepening of a well some years ago put down into the Chalk, the water derived from which proves inadequate to the present demand. The well has now been carried from a depth of 434 feet to one of 1310 feet. The work of boring has been performed by Mather and Platt's flat-rope machine, under the superintendence of Mr. S. C. Homersham, C.E. Only insignificant quantities of water have as yet been obtained; but that this water is derived from a deep-seated source is proved by the following facts:—it is

capable of rising 130 feet above the surface of the ground, and it has a temperature considerably higher than that of the surrounding air.

This well, the bottom of which, reckoning from the Ordnance datum-line, is now 150 feet lower than that of any other well within the London Basin, has revealed a number of facts which are of the greatest interest to geologists.

The Tertiary strata passed through present their usual characters. The London Clay has a thickness of 160 feet, the Woolwich and Reading Series of 60 feet, and the Thanet Sand of 23 feet. The usual band of green-coated flints separates the Tertiaries from the Chalk.

The Chalk was proved to be 671 feet thick under Richmond. Two important horizons, the Chalk Rock and the zone of *Belemnites plenus*, were recognized in it, and it was thus proved that the Upper Chalk, or Senonian, is 300 feet thick, the Middle Chalk, or Turonian, 150 feet, and the Lower Chalk, or Cenomanian (including the Upper Greensand, which is normal in character and about 16 feet thick), less than 250 feet.

The Gault presents its usual characters, subdivisions, and fossils; it is  $201\frac{1}{2}$  feet in thickness. At its base is the usual band of phosphatic nodules.

Beneath the Gault was found 10 feet of impure sandy limestone, with but few and imperfect fossils, and a second junction-bed at its base. These beds are probably referable to the Neocomian.

At this point the boring entered thick beds of oolitic limestone with some subordinate bands of clay. The careful examination of these has revealed the presence of many fossils, Brachiopoda, Bryozoa, and Echinodermata being especially abundant, some of them in a very perfect state of preservation. These fossils prove the strata in which they occur,  $87\frac{1}{2}$  feet in thickness, to be of the age of the Great Oolite.

A careful re-examination of the evidence in the case of the boring made in 1878 at Meux's Brewery, proves that the 64 feet of oolitic limestone, which was there found overlying the Devonian rocks, is also of Great-Oolite age, though deposited under somewhat different conditions from those at Richmond.

The Great-Oolite strata of Richmond rest on beds of red and variegated sandstones and "marls," the former exhibiting much false-bedding. These strata have not yielded any fossils; but their lithological characters seem to indicate that they belong to the New Red Sandstone formation. These discoveries have an important bearing on several very interesting geological problems.

(1) The Great Palæozoic Ridge beneath the London Basin is shown to have been overlapped, in part or altogether, by strata of the Lower Oolites, the Lias being absent! That representatives of the Middle Oolites were also present is shown by the derived fossils in the Neocomian strata along the base of the North Downs.

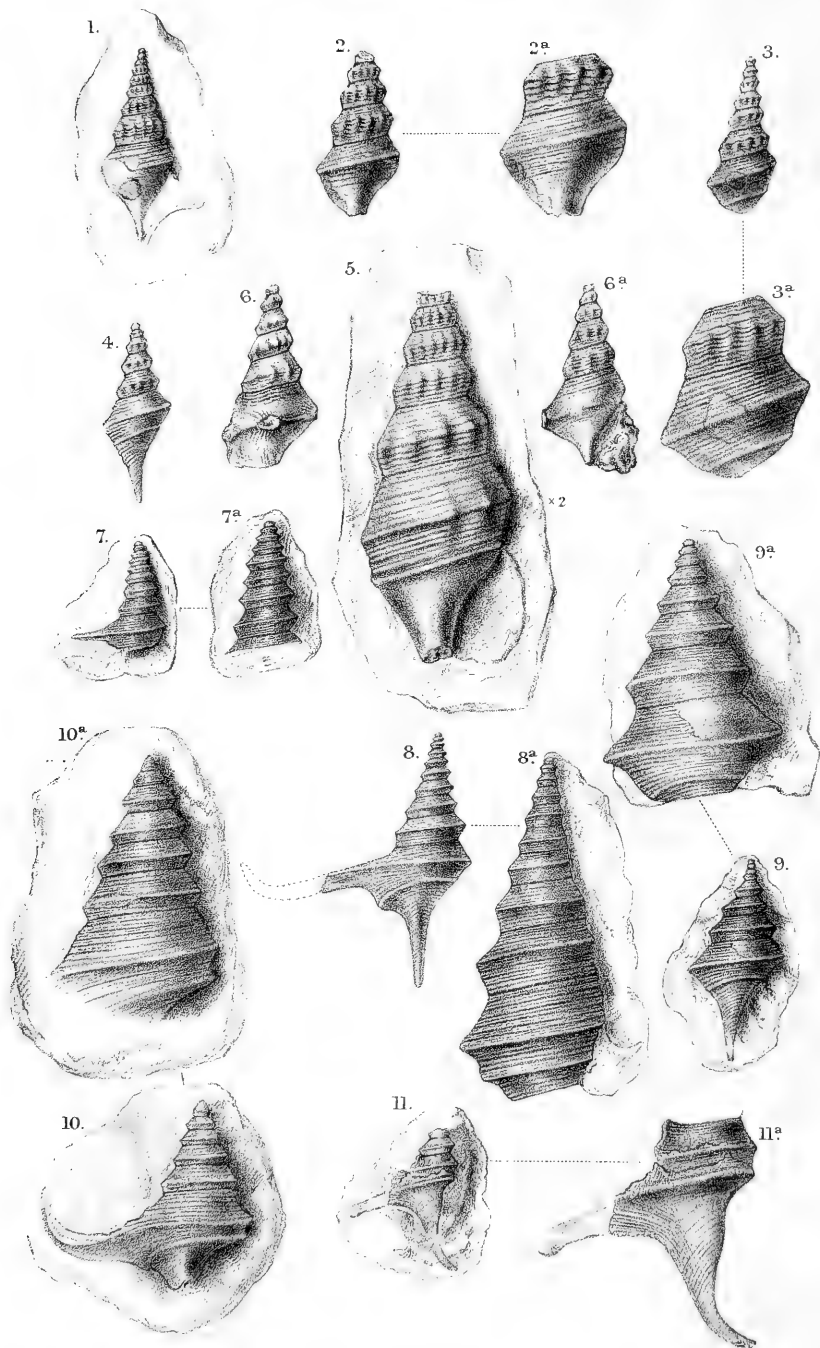
(2) Pervious beds of the Lower Greensand, which probably underlie part of the Southern Metropolitan area, are proved not to reach so far north as Richmond. The presence of pervious beds of the New Red may possibly be found to compensate in some degree for the absence of the Neocomian as a source of water-supply.

(3) The discussion of these facts throws some new light on the problem of the existence of Coal-bearing strata at workable depths under London. Small particles of anthracite were found in several of the deeper beds at Richmond, these being probably derived from Coal-seams in the great Palæozoic axis; but the presence of Jurassic and Triassic strata shows that a greater thickness of strata will probably have to be pierced in order to reach the coal than was formerly supposed.

The paper concludes with some notes on the very interesting and beautifully preserved fossils from the Great Oolite beds under London.







A S Foord del et lith.

Mintern Bros. imp.

Oxfordian & Lower Oolite Gasteropoda.  
(Yorkshire.)

THE  
GEOLOGICAL MAGAZINE.

NEW SERIES. DECADE III. VOL. I.

No. IV.—APRIL, 1884.

ORIGINAL ARTICLES.

I.—CONTRIBUTIONS TO THE PALEONTOLOGY OF THE YORKSHIRE  
OOLITES.

By WILFRID H. HUDLESTON, M.A., F.G.S.

(Continued from Decade III. Vol. I. p. 115.)

(PLATE VI., excepting Figs. 11 and 11a.)

Genus *ALARIA*, Lycett, 1850.

AS in the case of *Nerinea*, so also in this genus, we are dealing with its earliest representatives in so far as this district is concerned, since Tate and Blake make no mention of the occurrence of *Alaria* in the Yorkshire Lias. Piette, who accepts with modification Morris and Lycett's genus for this section of the winged shells, is of opinion that no truly winged shell has ever been found in the Lower Lias of France, though he describes species from the Middle and Upper Lias, none of which, according to his views, pass upwards. It was in the Lower Oolites that the genus *Alaria* first began to flourish, and we find in most places that it became tolerably well represented as low down as the Inferior Oolite or Bajocian subdivision.

The following are the principal generic characters of *Alaria* as defined by Piette (Pal. Franç. Terr. Jur. iii. p. 16) in the continuation of the Paléontologie Française. Want of sinus, absence of posterior canal, slight importance of the columellar callosity; the form of the wing finger, separated alike from the canal and the first whorls of the spire; the nakedness of the first whorls, which are smooth and convex, the keel on the later ones: lastly, the power of developing varices, spurs, and protuberances at various periods of increase—evident traces of rudimentary wings, which appeared usually on the side opposite the actual (definitive) wing.

Compared with other districts the Yorkshire Oolites cannot be said to be very rich in species of *Alaria*, or of the allied genera, such as *Chenopus*, *Pterocera*, etc. This poverty may be partly due to the imperfect preservation of specimens, whereby the small differences which are held to separate species cannot be made out with certainty. Thus in the "Corallian Gasteropoda" I only ventured to record

one species, viz. *Al. bispinosa*,<sup>1</sup> and even this was scarcely entitled to appear, as there is no proof that it ascends above the Lower Calcareous Grit. The representatives of the Brown Jura are somewhat better off in this respect, the Dogger (zone 1), and the Kelloway Rock (zone 5) contributing the greater number—of individuals certainly. Owing to the difficulty of obtaining unmutated specimens of these easily broken shells, it has been found impossible to institute any very close comparison with forms from other districts. However, we can perceive that there is a *general analogy* in the respective forms according to the several horizons, whilst *in detail*, especially in the Inferior Oolite, there appears a considerable amount of difference, thus necessitating the making a greater number of subspecies than is altogether satisfactory. The forms which occur in the Dogger cannot be exactly fitted either with those from Dundry as described by Mr. Tawney, or with those from Bradford Abbas, etc., in my own collection. Curiously enough, the Yorkshire Dogger and Millepore Rock yield specimens more like Deslongchamps' *Rostellaria hamus* than do the Dorset-Somerset beds. There are several specimens of the *hamus* group, mostly small,—both from the Millepore Rock and Scarborough Limestone, which are so badly preserved that they must perforce go under the general designation of *Alaria Phillipsii*.

The Kelloway Rock, which, as I have often pointed out, is a far more comprehensive series than the Kellaways Rock of the South of England, is our principal repository for the Oxfordian forms, and here we obtain, in a spathic condition, fossils which in the clays of the south are compressed and in a totally different mineral condition. Some of these also appear as compressed casts in the Oxford Clay of Yorkshire. The *bispinosa-trifida* group here seems to culminate.

Subjoined is a table, where an attempt is made to show the groups of *Alaria* and their distribution in the Oxfordian and Lower Oolites of Yorkshire.

1. The *Hamus*-group (monodactyls)
  - a. *Alaria hamus*, var. *Phillipsii*, Dog., Mil., Sc.L.
  - b. „ *unicarinata*, Dogger.
  - c. „ *pseudo-armata*, Dogger.
2. The *bispinosa-trifida* group (partly monodactyl, partly didactyl).
  - a. *Alaria bispinosa*, var. *elegans*, Cornbrash.
  - b. „ „ „ *pinguis*, K. R.
  - c. „ „ „ *communis*, K. R., L. C. G.
  - d. „ „ „ *trifida*, K. R., O. C.
3. The *Myurus*-group (didactyl).
  - a. *Alaria myurus*, Millepore, Cornbrash.
  - b. „ „ „ var. *teres*, Cornbrash.
4. *The exhaustive division*,—includes other forms whose affinities and specific position are more or less doubtful.

Out of these four groups there are two which, in Yorkshire, are at once distinguished as characteristic of certain horizons. All three zones of the Inferior Oolite, viz. the Dogger, Millepore Rock, and Scarborough Limestone, are characterized by one or other of the varieties of the *hamus*-group, and in no single instance that has come to my knowledge has a specimen of any of the

<sup>1</sup> GEOL. MAG. 1880, p. 532.

varieties of the *bispinosa-trifida* group been found in any of these three zones. On the other hand, the *hamus* group is entirely absent from the Cornbrash, and all the Oxfordian beds. This complete separation of the two groups does not seem to occur elsewhere to such a marked extent.

Amongst the specific characters of *Alaria* the most important, according to Piette, are—the form of the canal, its direction and mode of increase; the number of digitations, their form and direction; the number of keels on the last whorl, their relative size. The prolongation of the spire is more or less great, the convexity of the whorls is more or less strong, but never in the same species does a hollow replace a convexity; the number and arrangement of the fine spiral lines is not of specific importance. Unfortunately, we can but guess at some of the characters above indicated in dealing with the specimens from the Yorkshire Oolites.

36.—*ALARIA HAMUS*, Deslongchamps, var. *Phillipsii*, D'Orbigny. 1842. Plate VI. Figs. 3, 3a, 4.

1829 and 1835. *Rostellaria composita*, Sow. Phillips, G. Y. pp. 124, 129, 165, pl. ix. fig. 28.

1842. *Rostellaria hamus*, Deslongchamps. Mem. Soc. Linn. Norm. vol. vii. p. 173, pl. ix. figs. 32-36.

1849. *Pterocera Phillipsii*, D'Orbigny, Prod. i. p. 270.

1850. *Alaria Phillipsii*, D'Orb. ? *Rost. hamus*, var.  $\beta$  Desl., Morris and Lycett, Great Ool. Moll. p. 111, pl. xv. figs. 15, 15a.

1875. *Alaria Phillipsii*, D'Orb. Phillips, G. Y. 3rd edition, p. 258, pl. ix. fig. 28.

*Bibliography, etc.*—The original *Rostellaria composita*, Sowerby (Min. Conch. t. 558, fig. 2), may truly be described a composite species. "One specimen more strongly costated than the others was picked up at Weymouth in the Oxford Clay; others have been sent us from Scarborough, but the only ones that have the lip preserved were collected at Brora in the stone immediately above the coal." Although Sowerby did not happen to figure any of the Scarborough specimens, there is no question that he was referring to such as are found in the Scarborough Limestone and Millepore Rock, and hence Phillips had some excuse for referring them to Sowerby's lately constituted species.<sup>1</sup>

It should be noted that Phillips described the Yorkshire species now under consideration as occurring both in the "impure limestone" of Cloughton and Brandsby, and likewise in the Inferior Oolite Sand

<sup>1</sup> On examining the collection of Sowerby's types at the British Museum, in company with Mr. Etheridge and Mr. Newton, we found that, besides the two figured forms, there were several other specimens fixed to the card. One of these comes from the Dogger of the Peak, and is almost identical with the form in the accompanying Plate (VI. Fig. 5). Two others are from the Millepore Rock, or from the ferruginous bed of the Scarborough Limestone, and are good examples of *Al. hamus*, var. *Phillipsii*. Of the figured types themselves, the one from Weymouth has been preserved in a hard concretionary limestone strongly reddened, which probably came from the base of the Oxford Clay, here devoid of any specialized Kellaways Rock. The other, from the roof of the Brora coal, is likewise on the same horizon. Hence, *Rostellaria composita*, Sow., is to be regarded as a Callovian form, very similar to, if not identical with, *Rostellaria seminuda*, H. and D., from the Callovian of Montreuil Bellay.

or Dogger. His type specimen belonged to Bean, and should be either at York or in the British Museum. I have not seen it.

It is perhaps of more importance to know how far this rather abundant form is related to *Alaria hamus*, Desl., which that author describes as not uncommon in the Inferior Oolite of Normandy, though rare in the Great Oolite of that country. In 1850 Morris and Lycett (Grt. Ool. Moll. pp. 16 and 18, pl. iii. figs. 2 and 5) described *Al. hamus* from the Great Oolite of Minchinhampton, and *Al. Phillipsii* from the "Great Oolite" of Scarborough, pointing out what they conceived to be the differences. But Piette (*op. cit.* p. 46) says that these authors have wrongly identified Deslongchamps' species; and, as far as I can understand the point without having actually seen Deslongchamps' Inferior Oolite types, the accusation is not unfounded. Moreover, at page 111, these authors say, "The Yorkshire shell appears to be identical with *Rostellaria hamus*, var.  $\beta$  of M. Deslongchamps, from the Great Oolite of Ranville," and Morris indorses this view of the case in his Catalogue. Yet this identification with var.  $\beta$  is not a happy one, since the Ranville type, which is in the Tesson Collection at the British Museum, has the upper or major keel of the body-whorl nodular (carinâ . . . nodulosâ, nodulis parvis, crebris), whereas the Yorkshire specimens are like var.  $\alpha$  from the Normandy Inf. Oolite, where the keel is plain. Hence Morris and Lycett were mistaken on both points.

*Description.*—Specimen from the Dogger (zone 1), Peak (Blue Wyke). Leckenby Collection. Pl. VI. Figs. 3 and 3a.

Length <sup>1</sup> .....	22 millimètres.
Width of last whorl to length of shell .....	41 : 100.
Approximate spiral angle .....	26°.

Shell elongate, turritid. Whorls about 9 or 10 (the 3 anterior ones alone are perfect). The visible whorls of the spire are angular, with a prominent keel, which is central. The posterior half of the keel slopes outwards, whilst the anterior portion is nearly straight. These whorls are ornamented by numerous fine spiral lines of nearly equal strength, though they become rather finer on the body-whorl. About 10 short stout longitudinal costulæ are arranged in a circlet, chiefly on the anterior half of each whorl (medio angulato-nodosis, nodulis plus minusve crebris, *Desl.*). In the penult these costulæ are little more than large tubercles, but in the higher whorls they are relatively longer and slope slightly from right to left. The body-whorl seems to have suffered from exposure, whereby the spiral lines are almost effaced, but it is gibbose and bicarinate, the upper keel being much the stronger. Both keels are plain, though it is not improbable that a spine existed where there is a partial break in the continuity.

As this specimen is involved in matrix, the digitation that sprang from the upper keel is only just visible, and beyond this nothing

<sup>1</sup> In the following measurements of *Alaria* "length" means the full length of the shell restored, without the canal. In other respects no great accuracy is claimed, since all the specimens are more or less mutilated, and for the most part enveloped in matrix.

more can be made out of the specimen, though there is every reason to suppose that the lower keel terminated at the margin as in the case of *Al. hamus*.

*Another specimen.* Fig. 4. From the Millepore Rock (zone 2). Cloughton (Sycarham). Leckenby Collection. The condition of this specimen forbids any close comparison, but it is fairly similar to the one above described, more especially when we bear in mind the difference of the matrix. This may be taken as representing the general appearance of fairly preserved specimens of *Alaria Phillipsii* from the Millepore Rock and Scarborough Limestone.

*Relations and Distribution.*—These may be inferred from what has been said under the head of bibliography. The typical *Al. hamus* would seem to be a somewhat more robust shell, with rather a wider spiral angle, and with the tuberculations that form the circlet round each whorl more closely set. Common to all three zones of the Inferior Oolite in Yorkshire.

*Description of a spinulose variety.*—Specimen from the Dogger (zone 1), probably from the Peak. My collection. Fig. 5, magnified twice.

Length .....	23 millimètres.
Width of last whorl to length of shell .....	38 : 100.
Approximate spiral angle .....	30°.

Six whorls are preserved. They are slightly less angular than in *Al. Phillipsii*, and the outline produced by the longitudinal costulæ is not quite so much that of a mural circlet. Moreover, in the upper whorls, the costulæ extend very nearly from suture to suture, though this is not the case in the penultimate. But the chief difference occurs in the body-whorl, which is not quite so gibbose as in the more typical form, though this appearance is partly due to scraping; the upper keel is spinulose, instead of being plain. The other differences shown in the figure are in a great measure the result of *status*.

*Relations and Distribution.*—It is presumed that there is no considerable difference between this and more typical forms of *Al. Phillipsii*; but as all the specimens are more or less mutilated, something must be left to conjecture. Only two specimens of this variety are known to me, viz. the one figured and the one previously mentioned, in a foot-note, as being in the collection of Sowerby's types. Both are from the Dogger.

### 37.—*ALARIA UNICARINATA*, sp.n. Plate VI. Figs. 1, 2, 2a.

*Description.*—Specimen from the Dogger (zone 1), Peak (Blue Wyke). York Museum.

Length .....	22 millimètres.
Width of last whorl to length of shell .....	44 : 100.
Mean spiral angle .....	30°.

Shell turritid. The complete spire would consist of about 9 or 10 whorls: 7 are visible. The apical whorls are apparently but slightly ornamented, and the very earliest ones were probably quite smooth. The other whorls are full, the penult and antepenult being subangular, but without any very strongly developed carina. The

spiral lines are sharp, rather wide apart, and somewhat unequal. The longitudinals consist of about 9 stoutish ribs, which have a tendency to be spinulose here and there. These are feebly developed on the upper part of the whorls, but strong in the anterior portion, though scarcely reaching the suture: they have a slight inclination from right to left.

Body-whorl moderately large in proportion to the rest of the spire, rounded, and divided nearly equally by a plain keel. The spiral lines are continued in the upper part of the body-whorl, but have left only slight traces in the anterior portion. The wing has one lateral digitation (broken off), though both this and the canal were probably rather short.

*Another specimen.*—Same horizon and locality. Bean Collection, British Museum. Figs. 2, 2a.

Length .....	25 millimètres.
Width of last whorl to length of shell .....	45: 100.
Approximate spiral angle .....	30°.

In this fragment the character of the ornamentation is unusually well shown; there are 5 whorls preserved. Whilst the shell itself is more robust, the spiral striæ are finer and more numerous than in the other specimen; the longitudinal costæ are also very prominent and somewhat longer, with a marked inclination from left to right. The peculiarities of the body-whorl are almost the same, only one keel being visible, and that quite plain.

*Relations and Distribution.*—The two specimens figured are the only ones known to me. From *Al. Phillipsii* this form differs in the smoother outline of all the whorls, and notably of the body-whorl, in the greater length of the longitudinal costulæ, and above all in the absence of any clearly developed anterior keel in the body-whorl.

There can be very little doubt that the above three forms, whether we call them species or varieties, were pretty closely related; the differences being such as a variable genus like *Alaria* would easily cover. Unfortunately, when this is the case, such differences are often so local as to be of little value for purposes of comparison.

### 38.—*ALARIA PSEUDO-ARMATA*, sp.n. Plate VI. Figs. 6 and 6a.

*Description.*—Specimen from the Dogger (zone 1), Peak (Blue Wyke). Leckenby Collection.

Length .....	26 millimètres.
Width of last whorl to length of shell .....	48: 100.
Approximate spiral angle .....	34°.

Shell strongly turritid. The complete spire consisted probably of 10 whorls: portions of 7 are visible. They are extremely sharp and angular in outline, the dividing carina occurring about  $\frac{2}{3}$ ds down—a feature which is very marked in the penultimate. Each whorl has about eight short, tuberculated costulæ, which are quite axial in direction, and do not affect the upper part of the whorls. The condition of the shell does not permit of any certainty as to the character of the spiral lines, but they seem to have been very unequal. The body-whorl is largely developed and extremely angular: it has one



large median keel which supported one or two immense spines. Although some of the spiral lines on the body-whorl are stronger than others, there is nothing which could fairly be called a second keel. The aperture is broken away anteriorly and the outer lip obscured, so that there is no absolute certainty as to the character of the wing, or as to the length and shape of the canal.

*Relations and Distribution.*—Probably not far from *Alaria armata*, M. and L. (Grt. Ool. Moll. p. 16, pl. iii. figs. 1, 1a), though that species is described as having three carinæ. On looking over a large collection of these Great Oolite forms, there are several where the last whorl has only one keel; but these seem to be all immature or stunted specimens—perhaps a reversion to the older type. There is one other specimen of *Al. pseudo-armata*, now in the Jermyn Street Museum: this also is from the Dogger.

39.—*ALARIA BISPINOSA*, Phillips, 1829. Plate VI. Figs. 7–10.

1829 and 1835. *Rostellaria bispinosa*, Phillips, G. Y. pp. 112 and 180, pl. iv. fig. 32, and pl. vi. fig. 13.

1854. *Alaria bispinosa*, Phil. Morr. Cat. p. 234.

1875. " " Phillips, G. Y. 3rd ed. p. 258, pl. iv. fig. 32.

1880. " " Phil. GEOL. MAG. 1880, p. 532, Pl. XVII. Figs. 6 a, b, c.

*Bibliography, etc.*—This must be regarded as a group rather than as a species. In his earlier edition Phillips referred the fossil from the Lower Calcareous Grit (pl. iv. fig. 13) and the fossil from the Kelloway Rock (pl. vi. fig. 13) both to *Rostellaria bispinosa*, though with a query; but in the edition of 1875, although *Al. bispinosa* is quoted from the L. C. G. and K. R., the fossil, depicted in pl. vi. fig. 13, is referred to *Al. myurus*, Desl., and as coming from the Cornbrash. It is perfectly true that there are representatives of *Al. myurus* in the Yorkshire Cornbrash, but none of them are like Phillips's figure (vi. 13), which represents a wide-angled variety of the *bispinosa* group. Both Phillips's types were provided by Williamson. I have not been able to trace them.

The question whether the fossils of the L. C. G. and K. R. should be placed under the same specific designation was partly discussed in the Corallian Gasteropoda<sup>1</sup> (GEOL. MAG. 1880, p. 532), and allusions were made to the possible foreign equivalents. It would be a hopeless task to attempt to follow the synonymy or to correlate with accuracy the various modifications of this wide-spread group, which has been further complicated by its having been confounded with *Alaria trifida*, a still more widely extended species. Although there are, doubtless, important differences between some specimens which I have referred to *Al. bispinosa*, yet such differences are chiefly those of size; the general character of the spire, body-whorl and ornaments in all being very similar. For Yorkshire this species culminates in the Kelloway Rock, and here it is that the

<sup>1</sup> In describing a specimen from the L. C. G. it was suggested that it might have a two-fingered wing. This I now believe to be a mistake. The chief characteristic of the *bispinosa* group is the one lateral digitation, which together with the canal sheath or tail constitute two long processes almost at right angles to each other.

robust wide-angled variety is most conspicuous, though the narrower forms are not deficient.

*Description*.—var. *elegans*. Specimen from the Cornbrash (zone 4), Scarborough. Leckenby Collection. Plate VI. Figs. 8, 8a.

Length .....	26 millimètres.
Width of last whorl to length of shell .....	42 : 100.
Approximate spiral angle .....	32°.

Shell turritid, somewhat elongate, the spire increasing with great regularity. The complete spire would consist of about 12 whorls, of which 7 are in good preservation. The earlier whorls are short, tumid, and scarcely angular; they are ornamented with spiral lines of great regularity, one of which presently begins to develop as a keel rather below the middle of the whorls, which, in that part of the spire immediately posterior to the body-whorl, become more angular, the upper half projecting outwards to meet the keel, whilst the lower half is slightly constricted. The spiral lines continue about the same in number, but increase in size with the increasing whorls. These keels are split by a very shallow spiral groove. Sutures close. The spiral lines in the anterior portion of the whorls are fewer and wider apart than those in the upper portion. A similar style of ornament pervades the body-whorl, where a very sharp and prominent upper carina occupying a median position is developed, and a very subordinate anterior one. This upper keel is prolonged in a very stout digitation, which is broken off. There is no trace of any digitation in connection with the anterior keel, which seems to die out towards the margin. The canal sheath, or tail, is broken off just where an apparent curvature is commencing: all this portion of the shell is ornamented with spiral lines, which are rather finer than those on the spire.

*Relations, etc.*—If I am correct as to the absence of a second lateral digitation, the general characters of the spire fairly support a relationship to the more typical fossils of the K.R. and L.C.G. The spiral ornaments are bolder, and the whole shell is more vigorous and more elegant than such a form as Fig. 7, which represents a Kelloway Rock variety. From the L.C.G. fossils they differ in the keel being a trifle higher in the whorls of the spire. The specimen figured is the only one known to me from the Cornbrash.

Var. *pinguis*.—Specimen from the Kelloway Rock (zone 5), Scarborough. Leckenby Collection. Plate VI. Figs 9, 9a.

Length .....	17 millimètres.
Width of last whorl to length of shell .....	58 : 100.
Approximate spiral angle .....	42°.

Eight whorls are visible: the two highest without ornament and almost globular, the others with spiral lines of great regularity and fineness, those in the upper part of each whorl being the most delicate. Keels prominent, median; whorls slightly constricted anteriorly. Body-whorl very large. Upper keel median, prominent, sharp; lower keel very subordinate. Regular spiral lines on the columella, decussating with finer lines. Processes broken off.

Fig. 10, 10a. Another specimen. Same horizon, locality, and collection.

Length .....	22 millimètres.
Width of last whorl to length of shell .....	56 : 100.
Approximate spiral angle .....	41°.

Portions of 6 whorls are visible. This is a very massive specimen : the shell substance is extremely thick ; the body-whorl much inflated, the keels prominent and slightly lower than in Figure 9. The spiral lines are proportionally coarse and salient. The body-whorl carries a very large and prominent median keel, and this supports a very stout digitation, which extends for more than 10 millimètres at right angles to the axis and then curves upwards. The lower keel is observed distinctly to fade away and terminate at the margin, beneath this great digitation. The base of the shell is marked with spiral lines which decussate with an axial system of lines producing an elegant mesh : this is especially the case below the second or abortive keel.

Notwithstanding differences, which are striking at first sight, this specimen, it seems to me, is nothing more than a very robust example of the wide-angled section of *Al. bispinosa*. Except in the stoutness of the shell substance and the comparative coarseness of the ornamentation, its elements are the same as those of Fig. 9. The stoutness of the shell is probably the cause of so large a portion of the wing-finger having been preserved.

*Relations and Distribution of the bispinosa-group generally.*—All the indications seem to point to the fact that, as regards Yorkshire, a group of shells having one long up-curved digitation, proceeding from a body-whorl with one principal carina, extended from the Cornbrash (rare) through the Kelloway Rock into the Lower Calcareous Grit. The process containing the canal was long, but with us its actual termination is unknown, owing to the imperfection of the specimens. Within considerable limits as to width of angle, there is much similarity in the character of the spire, which, in all cases, is entirely devoid of longitudinal costæ or tuberculations. Specimens from the Lower Calcareous Grit seem to have the keel placed rather more anteriorly than is the case with specimens from the lower beds, and this is the principal difference that can be noted. As regards there being only one lateral digitation springing from the body-whorl, the following figures bear testimony, viz. Plate VI. Figs. 7, 8, 10, to which may be added the figures of the Lower Calcareous Grit fossils (GEOL. MAG. 1880, Pl. XVII. Figs. 6a and 6c), my former supposition to the contrary notwithstanding. Hence, the shell has *two* processes ; one being the lateral digitation, and the other the canal sheath, or tail, so that Phillips's term *bispinosa* is also structurally descriptive.

Although there is no positive evidence of this form having been observed in the Oxford Clay of Yorkshire, it may be seen in collections from that formation, as it occurs in the south of England, the processes being usually longer than in the species with two lateral digitations known as *trifida*. I doubt not that a fuller examination

of all the collections would place the subject on a more satisfactory footing, and that ultimately the group, with all its modifications, may be thoroughly diagnosed.

## EXPLANATION OF PLATE VI.

THE *Hamus* GROUP.

- FIG. 1. *Alaria unicarinata*, sp.n. Dogger, Blue Wyke. York Museum. Front view.  
 ,, 2, 2a. *Alaria unicarinata*, sp.n. Dogger, Blue Wyke. Bean Collection, British Museum. Back view and whorl enlarged.  
 ,, 3, 3a. *Alaria Phillipsii*, d'Orb. Dogger, Blue Wyke. Leckenby Collection. Back view and whorl enlarged.  
 ,, 4. *Alaria Phillipsii*. Millepore Rock, Cloughton. Leckenby Collection. Back view.  
 ,, 5. *Alaria Phillipsii*, spinulose variety. Dogger (?), Peak. My Collection. Front view, enlarged twice.  
 ,, 6, 6a. *Alaria pseudo-armata*, sp.n. Dogger, Blue Wyke. Leckenby Collection. Back and front view.  
 [The *Hamus*-group extends thus far only.]  
 ,, 7, 7a. *Alaria bispinosa*, Phil. (variety). Kelloway Rock, Scarborough. York Museum. Back view, and spire enlarged.  
 ,, 8, 8a. *Alaria bispinosa*, var. *elegans*. Cornbrash, Scarborough. Leckenby Collection. Back view and spire enlarged.  
 ,, \*9, 9a. *Alaria bispinosa*, var. *pinguis*. Kelloway Rock, Scarborough. Leckenby Collection. Back view and spire enlarged.  
 ,, 10, 10a. *Alaria bispinosa*, var. *pinguis*. Kelloway Rock, Scarborough. Leckenby Collection. Back view and spire enlarged.  
 ,, \*11, 11a. *Alaria trifida*, Phil. Kelloway Rock, Scarborough. Leckenby Collection. Back view and whorl enlarged.

\* The specimens thus marked occur on the same block of stone.

(To be continued.)

## II.—GRAPHICAL METHODS IN FIELD-GEOLOGY.

By A. HARKER, B.A., F.G.S.,

of St. John's College, and  
 Demonstrator in Petrology in the Woodwardian Museum, Cambridge.

*Introduction.*

IN determining the actual position of strata from the appearances presented by their exposed edges in natural and artificial sections, certain mathematical problems are of constant occurrence. To a field-geologist who is not content with rough guesses founded on judgments by eye, the solution of these problems is a matter of importance, and methods have accordingly been given for some of those most frequently met with. These solutions take the form of (1.) trigonometrical formulæ, which can be applied only with the aid of trigonometrical and logarithmic tables; (2.) tables specially prepared from these formulæ for use in the field; (3.) graphical methods, requiring only a ruler, scale and protractor, which may be conveniently combined in one instrument. Of the first kind is the formula for deducing the true dip of strata from two apparent dips, given in Green's *Geology* (p. 341, 1st ed.), etc. Among special tables are those of Mr. Jukes for finding the apparent dip in any

direction from the true dip, and for connecting the dip, thickness and depth of beds: these tables are given in the appendix to the Survey Memoir on the Geology of the South Staffordshire Coal-field, and reproduced in Jukes's "Manual of Geology." Graphical methods have been used for finding the true dip from two apparent dips: a method partly graphical but requiring a table of cotangents is given in Phillips's "Treatise on Geology" (p. 298, 5th ed.), and also by the Rev. E. Hill (GEOL. MAG. 1876, p. 334); a purely graphical method by Mr. W. H. Dalton (GEOL. MAG. 1873, p. 332); and an approximate method by Mr. Penning (GEOL. MAG. 1876, p. 236), reproduced in his "Field Geology." As Prof. Green has pointed out (*ib.* p. 377), the last-named method is equivalent to taking the angle for its tangent, and so applicable only to small angles of dip.<sup>1</sup> Mr. Dalton's solution (*loc. cit.* p. 334) of another question, to find the effect on strata already inclined of a second tilt in a new direction, is only an approximation, and cannot be applied if the dips are considerable. It is erroneously assumed that the inclination of the strata in a direction at right angles to that of the second tilt is unaltered by the tilting.

I propose to show that graphical methods are capable of wider and simpler application than they have yet received, and may be made really useful in field-work.

#### Various Modes of Treatment.

Questions relating to the intersection of planes, etc., may be treated in various ways, all equally simple. Firstly, we may draw figures to represent the planes themselves. For instance, let  $ABC$ , Fig. 1, represent the position of certain strata,  $ABD$  a horizontal plane,  $CD$  being vertical; then  $AB$  is the line of strike and  $AD$ , perpendicular to it, the direction of true dip; the angle  $CAD$  ( $= X$  say) is the amount of dip and  $CBD$  ( $= Y$ ) the apparent dip in a section making with the direction of true dip an angle  $ADB$  ( $= Z$ ). Then we have directly (Fig. 1)

$$AD = CD \cot X, \quad BD = CD \cot Y, \quad AD = BD \cos Z.$$

Therefore	$\cot X = \cot Y \cos Z,$	}	..... (a)
or	$\tan Y = \tan X \cos Z,$		

which are the formulæ from which Mr. Jukes's tables are calculated.

Again, we may conveniently consider instead of the planes themselves the normals to them from a fixed origin  $O$ , and represent them by the points in which the normals meet a sphere of unit radius. For instance, in Fig. 2, let  $Z$  represent the horizontal plane,  $P$  the plane of the strata,  $Q$  that of the surface of the ground; then  $ZP$  represents the dip of the strata ( $= X$ ),  $ZQ$  the slope of the ground ( $= Y$ ),  $MN$  or  $PZQ$  the angle ( $Z$ ) between the direction

<sup>1</sup> To indicate the degree of the approximation, suppose the two observed dips to make an angle of  $60^\circ$  with one another; then if the amounts of the dips be  $15^\circ$  and  $20^\circ$  respectively, the error in determining the direction of true dip by Mr. Penning's method is less than  $1^\circ$ ; if the dips be  $30^\circ$  and  $40^\circ$ , it is about  $4^\circ$ ; if  $45^\circ$  and  $60^\circ$ , it is  $11^\circ$ ; and if  $60^\circ$  and  $80^\circ$ , the error amounts to  $29^\circ$ !

of dip and that of slope. Then  $PQ$  represents the angle ( $U$ ) at which the surface of the ground cuts the strata, and we have at once

$$\cos U = \cos X \cos Y + \sin X \sin Y \cos Z \quad \dots (b).$$

This enables us to find the true thickness of a bed from the breadth of its outcrop, for the ratio of the former to the latter is evidently  $\sin U$ . Further, if the great circle  $PQ$  meet the horizontal great circle in  $R$ ,  $R$  represents a vertical plane through the outcrop; so  $OR$  is perpendicular to the direction of outcrop, and since  $OM$  is perpendicular to the direction of strike,  $RM$  represents the deviation ( $V$ ) of outcrop from strike. We readily obtain

$$\tan X \sin V = \cot PRM = \tan Y \sin (V - Z)$$

and so  $\tan V = \tan Y \sin Z \div (\tan Y \cos Z - \tan X) \dots (c).$

The problem of the "secondary tilt" is troublesome trigonometrically, though its graphical solution is sufficiently simple. I give only the results: if strata having an original dip  $X$  receive a secondary tilt of amount  $T$  in a direction making an angle  $S$  with that of the original dip, then the final dip  $Y$ , and the angle  $Z$  which it makes with the original dip are given by

$$\cos Y = \cos X \cos T - \sin X \sin T \cos S$$

and

$$\tan Z = \sin S (\cos X \cos \frac{1}{2} T - \sin X \sin \frac{1}{2} T \cos S)$$

$$\div \{ \sin X \cos T + \cos X \sin T \cos S + 2 \sin X \sin^2 S \sin^2 \frac{1}{2} T \} \dots (d).$$

For trigonometrical calculation the spherical projection is of course the most convenient, but as suggesting graphical constructions another projection presents advantages. The planes are represented by the points where they cut, not a sphere, but a horizontal plane at unit distance above the origin. Let the normals to the strata, the ground-surface and the horizontal plane, drawn through  $O$ , meet the plane of projection in  $P$ ,  $Q$  and  $Z$  respectively; then  $OZ$  is unity,  $ZP$  is  $\tan X$  and  $ZQ$  is  $\tan Y$ ,  $X$  being the dip of the strata and  $Y$  the slope of the ground, and  $PZQ = Z$ , the angle between the directions of dip and slope (Fig. 3). In practice only the plane of projection with the traces on it of the various lines and planes is required ( $ZPQ$  in Fig. 4). In Fig. 3  $POQ = U$ , the angle at which the strata are cut by the ground; if we imagine the triangle  $POQ$  turned about  $PQ$  into the plane of projection, we get Fig. 4, which at once leads to the construction given below (Problem vii.).

The constructions given for Problems x. xi. xii. and xiii. follow from equally simple considerations.

By this kind of projection we can represent the dip of any strata both in direction and amount by a line drawn from  $Z$  in a diagram on the plane of projection, for the line may be drawn to indicate by its direction the direction of the dip, and its length will be the tangent of the amount of dip. Similarly the slope of the ground can be represented by a line drawn from  $Z$ .

*Use of the Protractor.*

In accordance with the foregoing we require some convenient means of laying down at once on a diagram a length proportional to the tangent of any given angle. Such a means is furnished by a common protractor of the oblong form, graduated along a straight edge. This instrument serves not only as ruler, scale and protractor, but also as a rough table of tangents and cotangents. For the last purpose it is convenient to have it graduated with a second set of figures in addition to those usual on protractors, the second set increasing both ways from zero at the middle point  $Z$  of the straight edge. Take the breadth of the protractor  $OZ$  as unity; if the point  $P$  corresponds to say  $35^\circ$  reckoned from  $Z$ , then the angle  $ZOP$  is  $35^\circ$  and  $ZP$  is  $\tan 35^\circ$  (Fig. 5). It will be seen that for high angles (for angles greater than  $60^\circ$  in the figure) the application of this principle is less ready: for instance to lay down  $\tan 70^\circ$ , it is necessary to dot in the positions of  $O$  and  $Q$  and produce the lines  $ZP$  and  $OQ$  to meet in  $R$ , then  $ZR$  is the required length. The longer the protractor is in proportion to its breadth, the more degrees will be marked on the straight edge directly, but since the scale on which the tangents are represented depends on the breadth  $OZ$ , this should not be too small; say double the dimensions of Fig. 5. There would be some advantage in having  $O$  and  $Z$  not in the middle, but at one end of the protractor.

In the constructions which follow, a straight line will be said to represent the dip of any given strata when it is drawn from a fixed line  $Z$  —

- (1) in the *direction* of the said dip, like the arrows on a common geological map, and
- (2) of length corresponding to the *amount* of the dip, that is, the length given on the edge of the protractor from zero to the proper degree-mark.

In this way the observations of the compass and clinometer are graphically recorded by one stroke, the protractor being used for the former purpose in the usual way, and for the latter in the manner described above. Similarly the slope of the ground or the inclination of any axis may be indicated, both in direction and amount, by a line on the diagram, the lines being always drawn from a fixed point of reference,  $Z$ .

*Practical Applications.*

(i.) Given the direction and amount of full dip, to find the apparent dip in any given direction.

In Fig. 6 draw  $ZA$  to represent the full dip,  $ZB$  in the other given direction,  $AB$  perpendicular to it; then  $ZB$ , the part cut off, represents the apparent dip in magnitude as well as direction, and the amount of apparent dip may be read off by applying the edge of the protractor. The proofs of this and the two following constructions are evident from the second of the equations (a).

(ii.) Given the apparent dip in one direction, and the direction of full dip, to find the amount of the latter.

FIG. 2.

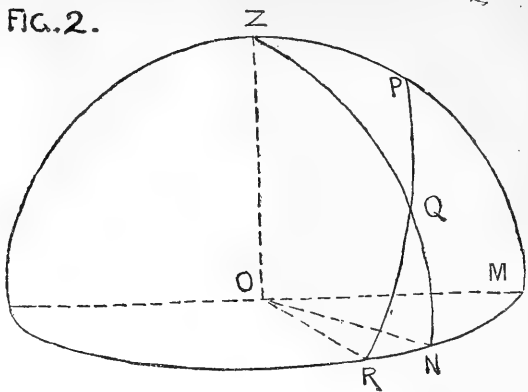


FIG. 1.

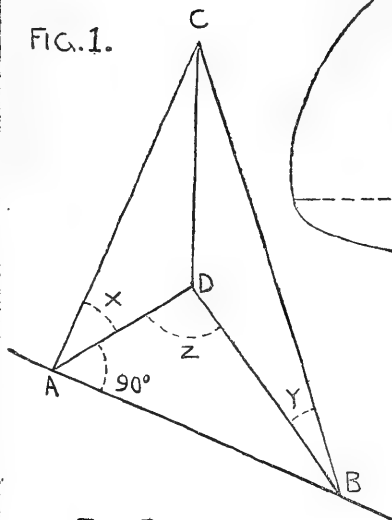


FIG. 4.

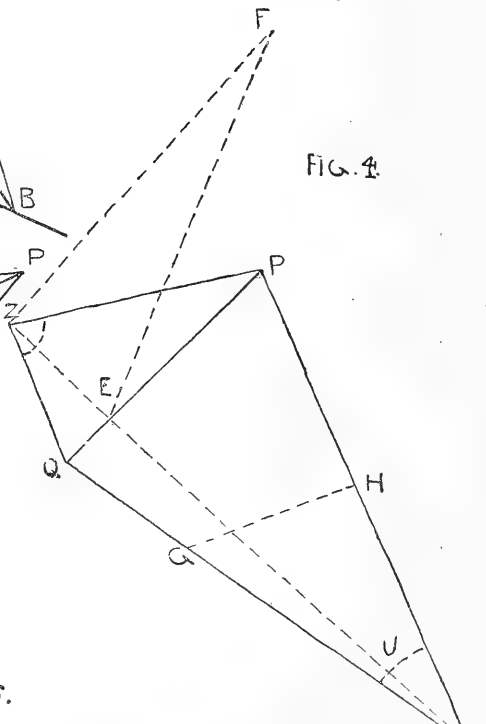


FIG. 3.

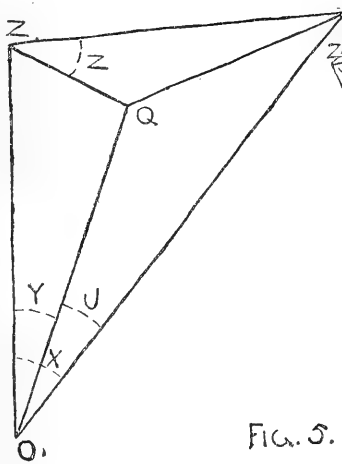
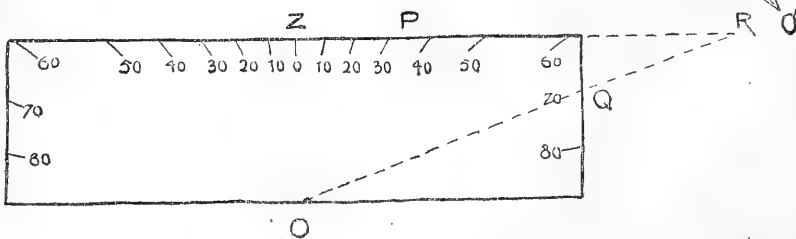


FIG. 5.



To illustrate Mr. Alfred Harker's paper on Graphical Methods in Field-Geology.



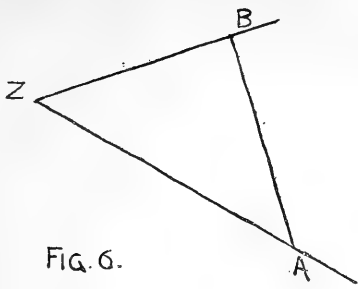


FIG. 6.

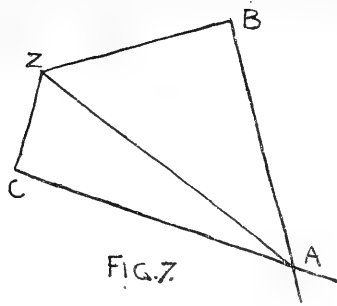


FIG. 7.

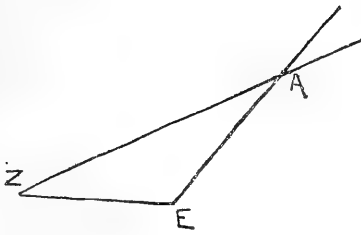


FIG. 8.

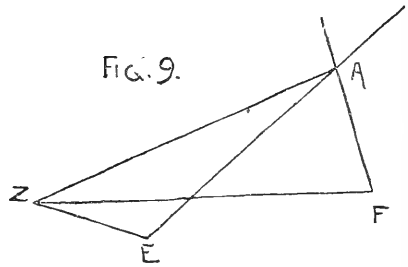


FIG. 9.

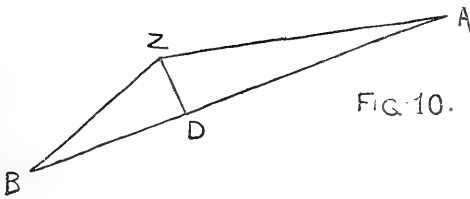


FIG. 10.

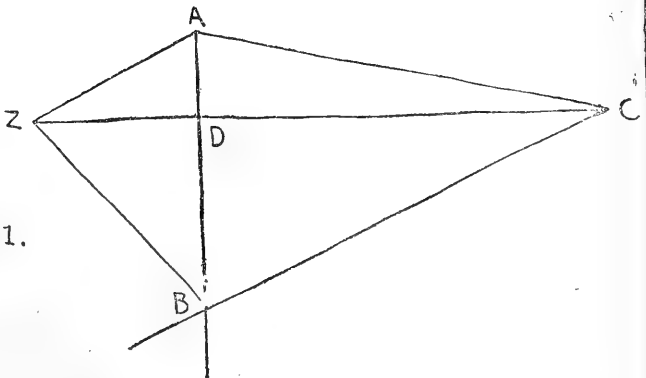


FIG. 11.

In Fig. 6 draw  $ZB$  to represent the apparent dip and  $ZA$  in the direction of full dip, the perpendicular  $BA$  will cut off a length  $ZA$ , which will represent the full dip.

(iii.) Given the apparent dip in two directions, to find the direction and amount of full dip.

In Fig. 7 draw  $ZB, ZC$  to represent the two observed dips, and perpendiculars to them at  $B$  and  $C$ , meeting in  $A$ ; then  $ZA$  represents the full dip.

(iv.) Given the direction and amount of the dip of the strata and of the slope of the ground, to find the direction of outcrop.

In Fig. 8 draw  $ZA, ZE$  to represent the dip and the slope; then the direction of outcrop is perpendicular to  $AE$ .

To prove this and the two following constructions it is sufficient to notice that a horizontal line ( $OR$  in Fig. 2) drawn perpendicular to the direction of outcrop lies in the plane containing the normals  $OP$  and  $OQ$ . Equations (c) also give a proof.

(v.) Given the directions of strike and outcrop, to find the dip, the slope of the ground being known in direction and amount.

In Fig. 8 draw  $ZE$  to represent the slope, and from  $Z$  and  $E$  respectively draw lines perpendicular to the given strike and outcrop, meeting in  $A$ ; then  $ZA$  represents the dip.

(vi.) Given the direction of outcrop in each of two localities where the slope of the ground is known in direction and amount, to find the direction and amount of the dip, supposed uniform (Fig. 9).

Draw  $ZE, ZF$  to represent the two slopes, and from  $E, F$  draw lines perpendicular to the respective directions of outcrop, meeting in  $A$ ; then  $ZA$  represents the dip.

(vii.) Given the direction and amount of the dip and of the slope of the ground, to find the angle at which the strata are cut by the ground.

In Fig. 4 draw  $ZP$  and  $ZQ$  to represent the dip and the slope,  $ZE$  perpendicular to  $PQ$ ,  $ZF$  perpendicular to  $ZE$  and equal to the breadth of the protractor; produce  $ZE$  until  $EO'$  is equal to  $EF$ , then  $PO'Q$  is equal to the angle required.

(viii.) In the foregoing problem, given the breadth of the outcrop of any bed, to find its true thickness.

Measure off  $O'G$  along  $O'Q$  to represent on any convenient scale of magnitude the given breadth, then the length  $GH$  of the perpendicular drawn to  $O'P$  will represent on the same scale the true thickness.

(ix.) Given in direction and amount the dips on the two sides of an inclined anticlinal axis, to find the direction and inclination of the axis.

In Fig. 10 draw  $ZA, ZB$  to represent the two dips, then the perpendicular  $ZD$  on  $AB$  represents the direction and inclination of the axis. A trigonometrical solution of this problem is given by Capt. F. W. Hutton, *GEOL. MAG.* 1874, p. 44.

(x.) Strata having a dip given in direction and amount receive a secondary tilt given in direction and amount; to find the direction and amount of the resulting dip.

In Fig. 11 draw  $ZA$  to represent the original dip, and a line  $AB$  in the direction of the secondary tilt; draw  $ZD$  perpendicular to  $AB$  and produce until  $DC$  is equal to the breadth of the protractor; join  $AC$  and make an angle  $ACB$  equal to the amount of the secondary tilt; the lines  $AB$  and  $CB$  meet in  $B$ ; then  $ZB$  represents the resultant dip.

(xi.) If in the foregoing problem the direction of the secondary tilt be at right angles to that of the original dip, the construction is much simplified.

Draw  $ZB$  (Fig. 6) to represent the original dip, and  $BA$  from  $B$  to represent the secondary tilt; then  $ZA$  represents the final dip.

When the angle the direction of the secondary tilt makes with that of the original dip does not differ widely from a right angle, and the amount of the tilt is small, the same construction gives an approximation to the true result; for instance, if the original dip be  $30^\circ$ , the amount of the tilt  $20^\circ$ , and the angle between their directions  $60^\circ$ , the error in the direction of the resulting dip is  $3^\circ$ , and in its amount  $2^\circ$ . For a strict solution the method in (x.) must be employed.

(xii.) Given the direction and amount of dip of strata which have suffered a tilt of known direction and amount, to find what the direction and amount of their dip was before tilting.

This is the same problem as (x.) worked backward, and a similar construction will suffice.

(xiii.) To find the direction and amount of the tilt required to change the dip of strata from a given initial direction and amount to a given final direction and amount.

In Fig. 11 draw  $ZA$ ,  $ZB$  to represent the initial and final dips, draw  $ZD$  perpendicular to  $AB$  and produce until  $DC$  is equal to the breadth of the protractor; then  $AB$  is the direction of the required tilt and  $ACB$  its amount.

#### *Further Remarks.*

When an angle is near 90 degrees, its tangent is very great, and therefore the line representing it very long. Some of the above constructions are then slightly modified. For instance, if strata have a vertical position the line representing their dip in the manner described above would be of infinite length, but it is only necessary to draw this line for a short distance, and if another line has to be drawn to the infinitely distant extremity of the former, make it parallel to it, according to the geometrical principle that "parallel straight lines meet at infinity."

In some cases it is convenient to use a construction which employs not the angle of dip or slope, but its *complement*, that is, its defect from 90 degrees. The line indicating the dip is drawn in the direction of the dip, but of a length corresponding on the edge of the protractor to the complement of that angle. This line will be proportional to the cotangent of the angle of dip and will be longer or shorter according as the dip is small or great. As an example we will take the problem of finding the true dip from two observed

dips, and the method will be found to have some advantages over that given above (iii.).

Using Fig. 10, from  $Z$  draw  $ZA$  and  $ZB$  in the directions of the observed dips, but of lengths representing their complements; draw  $AB$  and  $ZD$  perpendicular to it; then  $ZD$  is the direction of full dip and corresponds in length to the complement of that dip. The edge of the protractor must be applied to  $ZD$ , and the reading thus obtained subtracted from 90 degrees to obtain the true dip itself. The proof of this is evident from the first of the equations (a). The method is equivalent to that of Mr. Hill cited above.

All the above constructions, with the exception of the second one in problem (xi.), are theoretically exact: the accuracy actually attained will of course depend upon the precision with which the drawing is performed. In some cases a small error in the drawing may give rise to a large error in the results, but this is due not to any fault in the method, but to the inadequacy of the data. For example, in problem (vi.), Fig. 9, if the slope of the ground in the two localities be nearly the same, and the directions of outcrop nearly the same, the lines  $EA$  and  $FA$  will meet at a small angle, and any error in drawing them will produce a magnified error in the position of  $A$ , and therefore in the direction and magnitude of  $ZA$ ; but this is because the observations are insufficient to determine the dip of the beds with any degree of accuracy.

The foregoing examples are enough to illustrate the wide applications of graphical methods; solutions of other problems on similar lines will suggest themselves.

### III.—NOTES ON THE APPENDAGES OF TRILOBITES.

Note to accompany Three Woodcuts of *Asaphus megistos*, a Trilobite discovered by Mr. James Pugh, near Oxford, Ohio, in the upper portion of the Hudson River Group.

WE are indebted for the Woodcuts accompanying this note to the courtesy of Dr. John Mickleborough, whose paper on the Locomotory Appendages of Trilobites we published in our February Number, p. 80.

They serve admirably to confirm the observations of Mr. E. Billings (published in the GEOLOGICAL MAGAZINE for 1871, Vol. VIII. Pl. VIII. pp. 289–294) on the appendages of *Asaphus platycephalus*. In Fig. 1,  $a, a$ , mark the position of the anterior pair of appendages;  $b, b$ , the 10th pair;  $c$ , the articulation between the carpus and propodos;  $d$ , the articulation between the propodos and dactylus;  $e$ , the lines to the letter  $e$  mark the position of the lamelliform? branchiæ beneath the pygidium.

Fig. 2 represents the upper surface of specimen reduced to nearly one-third natural size.

Fig. 3 shows the mould into which Fig. 1 fits.  $a, a$ , mark the moulds of the bases of the anterior pair of appendages.  $b, b$ , of the 10th pair of appendages; the lines leading to  $c$  inclose the probable space to which the lamelliform? branchiæ were attached;  $d$  marks the position of the left maxillipede;  $e$  the left angle of the hypostome.

FIG. 1. Nat. size.

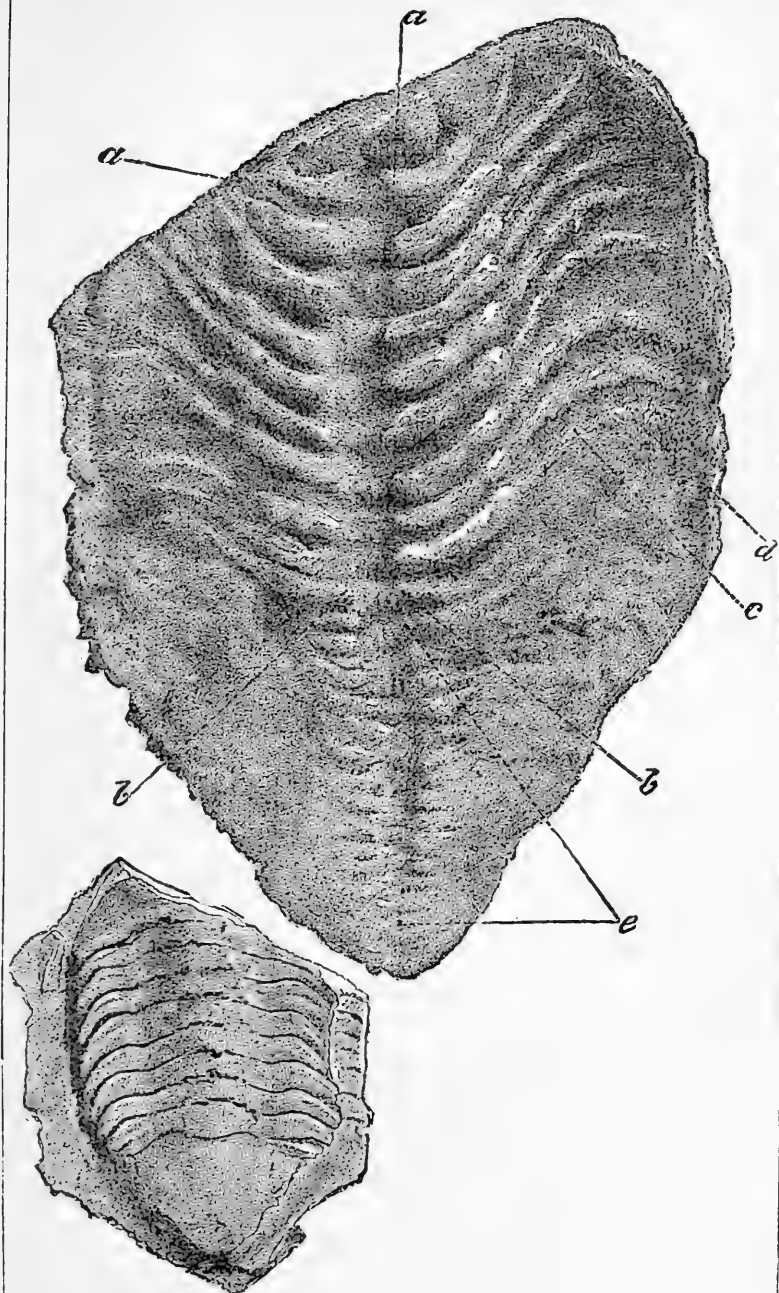


FIG. 2. One-third nat. size.

Fig. 1. Under side. Fig. 2. Dorsal surface of *Asaphus megistos*, Hudson River Group, Oxford, Ohio, U.S.A.

FIG. 3. Nat. size.

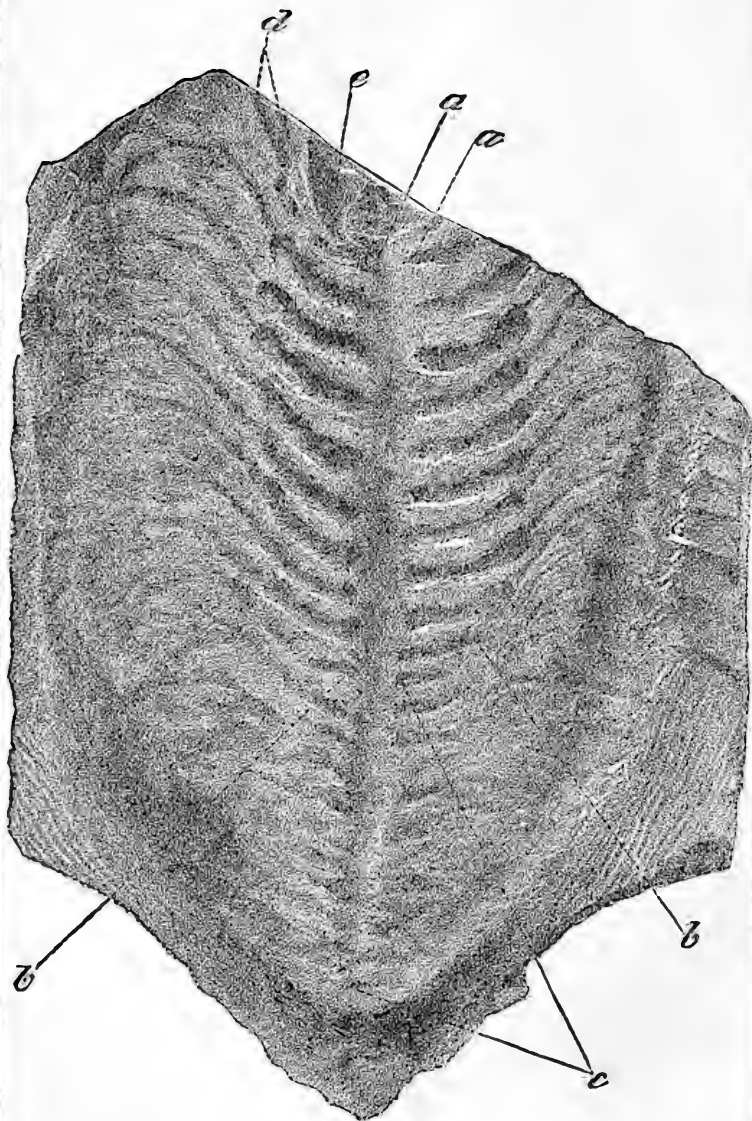


Fig. 3. Mould, into which Fig. 1 fitted, showing impressions occupied by the appendages of *Asaphus megistos*, from the Hudson River Group, Oxford, Ohio.

In Mr. C. D. Walcott's admirable paper on "The Trilobite, New and Old Evidence relating to its Organization," (Bulletin of the Museum of Comparative Zoölogy at Harvard College, vol. viii. No. 10, Cambridge, 1881), in his restoration of the ventral surface of *Calymene senaria*, plate vi. fig. 1, he gives 26 pairs of appendages, all, with the exception of the posterior cephalic pair, of a similar simple cylindrical 7-jointed structure, and extending to the extremity of the pygidium. Assuming this restoration to be more or less conjectural, we venture to suggest that the last seven pairs, belonging to the pygidium, were more probably lamelliform branchigerous appendages, as in *Limulus* and in living Isopods.—H. W.

#### IV.—DUST AND SOILS.

By CLEMENT REID, F.G.S.,

of the Geological Survey of England and Wales.

IN Darwin's recently published work on vegetable mould, allusion is made to the fact that "In countries where the summer is long and dry, the mould in protected places must be largely increased by dust blown from other and more exposed places." A few lines further on, however, he states that "In humid countries like Great Britain, as long as the land remains in its natural state clothed with vegetation, the mould in any one place can hardly be much increased by dust."<sup>1</sup> To this statement no exception can be taken, if we remember that it only applies to a period when the climate is *humid*, and to a country *clothed with vegetation*.

Nearly all writers on the surface geology of England and Western Europe speak of the connection between the soil and subsoil as most intimate, the soil being normally formed from the weathering of the subsoil. Taking a manual which is considered a standard authority on the subject, we find the following:—"The *general* result of this comparison has been, that in almost every country the soils, as a whole, have a resemblance to the rocks beneath them, similar to that which the loose earth derived from the crumbling of a rock before our eyes bears to the rock of which it lately formed a part. The conclusion, therefore, is irresistible, that soils, generally speaking, have been formed by the crumbling or decay of the solid rocks.

. . . . The cause of the diversity of soils in different districts, therefore, is no longer obscure. If the subjacent rocks in two localities differ, the soils met with there are likely to differ also, and in an equal degree."<sup>2</sup>

Were it correct that the character of the soil can be known from the nature of the underlying rock, we might accept without hesitation the above rather sweeping statement. But unfortunately soils

<sup>1</sup> Darwin, The Formation of Vegetable Mould through the Action of Worms, pp. 236, 237.

<sup>2</sup> Johnston and Cameron, Elements of Agricultural Chemistry and Geology, 13th edition, p. 90.

commonly contain constituents unknown in the subsoil—not only organic constituents obtained from the air or rain, but abundance of inorganic substances. Those who have been obliged to pay much attention to soils and superficial deposits are well aware how often the soil does not show what lies underneath. In districts where sections are scarce this has been found one of the greatest of the difficulties in the way of an accurate survey. Time after time districts with a distinctly loamy soil have had to be mapped as sand, and still oftener a thin sandy soil overlies clay. Often these anomalies may be accounted for by rain-wash from higher levels; but during the examination of large areas in Holderness and Norfolk, I have been much struck by the curious fact that not only is there a fertile soil over large raised tracts of sand and gravel, but even isolated sand hills have also a loamy soil. This fact is often overlooked, for soils are seldom more than a foot or two thick, and the character of the vegetation largely depends on the nature of the subsoil. A thin soil, which if deep would be wet and clayey, if it rest on sand becomes well drained or even parched; whilst a sandy soil lying on clay may be perfectly waterlogged. Trees are of little value as evidence of the nature of the surface soil, for their roots generally penetrate deeply into the underlying subsoil, where quite different conditions may exist; this, however, makes them much more useful than shallow-rooting plants as indications of the geology.

A particularly good example of the non-correspondence of the soil and subsoil is seen in the Chalk Wolds and Downs; for the composition of the Chalk is so simple that the transported material in the soil can be at once detected. Besides this neither the Wolds nor Downs are, or have been, commanded by higher ground from which the material could be washed. It is necessary, however, to confine ourselves to areas over which Boulder Clay stones are absent, and therefore where the Drift, if ever deposited, has been entirely denuded—the last trace of Drift remaining would be the *stones*, not the sand or clay. The Chalk is generally covered with a thin clayey or loamy soil, and sometimes with a thicker deposit of unworn flints in a clayey matrix, known as the “clay with flints.” These deposits have been generally explained by the dissolving action of rain water on the Chalk, which in time leaves a non-calcareous soil formed from the insoluble residue. Probably to a large extent this is correct, though the insoluble residue ought generally to consist of a much larger proportion of flint and less clay than is found. It is this excess of clay, and also the clay soils on sandy land, which I now attempt to explain.

Chemical analyses of soils from the Chalk Wolds and Downs, though showing a great difference between the soil and subsoil, leave it still possible that the one may be formed by the weathering of the other. Microscopic examination, however, yields a quite different result. The sand in the soil is at once seen to be *quartz*, not *flint*, and therefore it cannot be derived from the Chalk.

In the Lincolnshire Wolds the origin of this sand is clear, for sand is still occasionally blown up from the low-lying country to the



westward.<sup>1</sup> Probably, however, it would not travel far at the present day, were it not for the plough destroying the vegetation which would otherwise stop it. This travelling of the sand is well known, but curiously it seems often to be overlooked that the same wind that moves the sand must necessarily raise clouds of dust, which from its lightness would rise in larger quantities, travel further, and be dispersed widely over hill and dale.<sup>2</sup>

It is not uncommon on these Wolds, and still more on the light soils of the Norfolk coast, for the whole of the finer portion of the soil, and the seed, to be blown away by the equinoctial gales. A few years ago a field near Cromer was sown three times in succession in one spring, and finally was left fallow, as the whole of the soil was banked like a snow-drift against the hedge.<sup>3</sup>

The dust that annoys us so much in March, and hurts one's eyes, is coarse and gritty, the finer dust that is constantly moving is noticed, and troubles us no more, than the more purely carbonaceous and organic dust of towns. That the air is full of dust is a well-known fact: every one has probably noticed the dust-haze which obscures the view after a long spell of dry weather, to disappear directly the dust is washed down by a shower. Dust, to some extent, however, meteoric, occurs even on the snow, and the recent eruption of Krakatoa proves to what a distance the finer particles may be carried. Ordinary dust from our fields will travel, when once it has been raised, as far and as easily as that of a volcano. If instead of a Chalk Wold, we examine the flat top of a church tower, we often find in each sheltered corner of the leads a small heap of dust in which plants have taken root. Lately I observed this dust on the leaded tower of Immingham Church, a church standing in the middle of a wet marshy country, and therefore, one would think, even less likely to receive dust than most. Recent British dust deposits are so largely due to the agency of man in laying bare the soil, that it is doubtful how far we can appeal to them as evidence of the former movement of the dust. Still, as I attempt to show below, with a colder climate the destruction of the vegetation to a large extent takes place naturally; thus, perhaps, the present deposition of dust is below, not above, the ancient amount.

Perhaps a mistake is made in considering that the dust blows most in hot summer weather. If my own observations, made during the last nine years, can be trusted, dust rises most during the winter, when the vegetation has died down, and especially with the dry east winds of March. An unexpected instance of this was observed in the North Yorkshire Moors during the winter of 1879–80. Great part of these Moors are quite uncultivated, and rise to about a thousand feet above the sea. Here and there are patches of shale

<sup>1</sup> There is very little sandy land in other directions.

<sup>2</sup> See however Proctor, "Pleasant Ways in Science," p. 379; von Richthofen, "China," vol. i.; and von Richthofen, "On the Mode of Origin of the Loess," *GEOL. MAG.* Dec. II. Vol. IX. p. 293.

<sup>3</sup> See also Johnston and Cameron, *op. cit.* p. 191.

utterly bare of vegetation, but so flat that they evidently could not have been bared by the action of rain. During the summer these bare places had been looked upon simply as evidence of the extreme poverty of the soil; but happening to be on the Moor during a severe frost and easterly breeze, I was surprised to find the frozen shale blowing away in small clouds of dust, having been finely divided by the frost. Tufts of heather may thus be left projecting higher and higher above the soil, till they are undermined and destroyed, and the bare patch increases. On the other hand, a mild season may allow the plants to re-take their old dominion, and prevent any movement of the soil for many years.

At first sight what takes place on a moor a thousand feet above the sea, may seem to have little connection with the origin of the present soils of the lowlands of England. But, a few thousand years ago the climate was much colder. During this period the vegetation of the lowlands corresponded with that now found on our highest mountains—as is clearly proved by the occurrence of the *Betula nana* as a fossil in various parts of England, though this plant is at present confined to the mountains of Scotland. The climate being colder, the vegetation died down much more in winter and the close matted turf which now so effectually binds the soil, was replaced by a thin scrubby covering of dwarf birch and willow. The more exposed tracts were probably unprotected by vegetation, as is the case in many parts of the Arctic regions. Not only was the climate colder, but great part of the North Sea being land, the east winds were sharper and *drier*.

It is, I believe, to the keen east winds of spring that we owe in a great measure the fertility of our country.

This may seem an extraordinary conclusion; but if one examines analyses of rocks, it is curious what an exceedingly poor soil the decomposition of the majority of them would yield. Some one or two essential ingredients are missing, though everything else may be there. To make a good soil a mixture of material from different rocks is usually necessary. In alluvial flats or on hill-sides this mingling is done by running water; but up-hill, or over dry sands, or pervious rocks, the wind only can act. That it did act much more effectually at a former period necessarily follows from what we know of the climate.

Leaving out of account for the present the wide-spread Loess deposits, which Baron von Richthofen refers to the agency of the wind,<sup>1</sup> I think that we can find, even in England, abundance of evidence of its action: evidence that has been overlooked from its very familiarity. In high-lying Chalk districts we constantly find hollows filled with loam and sand, more or less stratified, full of small roots, but without other fossils. It is clear that these could not have been deposited by water, for the rain would immediately sink into the porous Chalk. Former Æolian action seems also evidenced by the abundance of land shells in other similar hollows.

<sup>1</sup> *Op. cit.*

One of the most abundant of these shells is the *Succinea oblonga*, a species almost confined to blown sand. This species, once widely spread over England, is now, apparently owing to changed conditions, confined to the sand dunes of our western coast. The other shells found with it seem to point, though not so conspicuously, in the same direction.

At present these thin superficial deposits are seldom properly examined, but they are well worthy of study, as is proved by Darwin's valuable book on soils, and by Prof. Prestwich's curious discoveries in beds lying immediately below.

---

## REVIEWS.

---

I.—THE BONE-CAVES OF OJCOW IN POLAND. By Professor Dr. FERDINAND ROEMER, Director of the Mineralogical and Palæontological Museums of the Royal University of Breslau. Translated by JOHN EDWARD LEE, F.G.S., F.S.A. 4to. pp. 57, with 14 Plates.) (London, Longmans, Green & Co., 1884.)

WE are indebted to Mr. John Edward Lee,—the translator of Keller's *Lake Dwellings*, and of Merk's *Kesslerlock Cave*,—for another contribution to the list of works on prehistoric archæology in Europe. Many years have elapsed since any contribution has appeared in Germany to the history of Cave-exploration, and we cannot but feel thankful to Prof. Dr. Ferd. Roemer for initiating the present inquiry.

The Caves—writes the author—now about to be described, have for a length of time been partially known to the inhabitants of the district; but they first attracted general attention some years since, when the bottoms of the Caves were worked for manure, the bed of earth being rich in bones, and containing a large quantity of phosphoric acid. The Cave of Jerzmanowice more especially has yielded those results since the year 1872. The author obtained his first information respecting these works from the mining officials of Upper Silesia, who had to visit professionally these places in Poland, and at the same time he received from this Cave some single bones and teeth of the Cave-bear, and also some prehistoric flint implements. In the year 1874 a visit was made to the cave of Jerzmanowice, and proof was obtained that it contained a great quantity of bones of extinct animals, and also of implements of the ancient inhabitants.

This led to the determination of undertaking a thorough investigation of these Caves, and of doing this if possible before the Caves were cleared of their deposits for agricultural purposes, by which all the scientific data would be utterly lost."

The specimens obtained differ in no important respect from other well-known bone-caves; they especially resemble those of Moravia. Geographically they are interesting as being the most easterly of any European caves north of the Carpathians.

We agree with Prof. Roemer that "It is most certainly to be re-

gretted, with respect to the specimens found in the Caves of Ojcow, (pronounced Oizoff), that it cannot be always positively stated from which bed in the caves they were taken, but the case is the same with most of the caves which have been excavated in Germany."

The Caves all occur in the White Oolitic Limestone, which consists of a series of beds in all several hundred feet in thickness, often forming precipitous cliffs. The entrances to the caves vary from 10 to 30 feet above the level of the valley. Probably they were at the same level, originally, as the bottom of the valley; but this has been cut down deeper by subaerial erosion leaving the caves at their present elevation. In their physical aspect these caves closely agree with those of the Oolite of Franconia.

The solid rock is very seldom seen on the floor of the caves. As a general rule, there is a deposit more or less thick of broken stones and earth. The pieces of stone are angular fragments from an inch in diameter to the size of the fist, and consist of White Jurassic rock, similar to that forming the sides of the cavern. Amongst them are a few larger blocks of limestone, varying from the size of a man's head up to several cubic feet. The earth fills the intervals between these angular stones; it very seldom forms a distinct bed of itself. It is of a dark brown colour, and when carefully examined seems to be a calcareous clay consisting of extremely fine particles; when moist, it is plastic and very adhesive. This mixture of limestone fragments and brown earth forms a more or less considerable deposit, sometimes as much as six or eight feet thick on the bottom of all the caves. If we ask how this deposit was formed, it may be replied almost undoubtedly that the pieces of limestone thus heaped up gradually crumbled from the top and sides of the cavern. The limestone, although firm and compact when fresh, is permeated by numerous fine cracks or fissures which when weathered are more distinctly seen, and in course of time cause the rock to fall in angular fragments. On isolated walls of rock this disintegration of the stone may be distinctly seen, as small pieces become loose and fall down. People who have remained some time in the caves have occasionally heard small pieces fall from the roof. In no single case had the stones forming the floor of the cave been subjected to the action of water. This theory cannot be maintained for a moment, as may be shown both from the angularity of form and from the similarity of the rock. Rounded pebbles, such as are found in the brooks flowing in the valleys beneath, are never found in the caves; there are no pieces of any other rock except the limestone forming the sides of the cavern.

There is a little more difficulty in deciding positively the origin of the brown earth. The idea of its having been washed in from the outside is probably not worth considering; the more probable explanation is that it is the argillaceous residuum of the limestone which has been acted upon by the carbonic acid contained in the water. Some small amount of clay is in fact a peculiarity of the limestone.

In most of the cases there are horizontal layers of coarsely crystal-

line stalagmite on the floor; they are usually only some inches thick, but in some cases the thickness is more than a foot. Numerous root-like stalactites hang down from the roof, but none have been noticed of any peculiar size or beauty. In most of the caves the formation of stalactites and of stalagmites on the floor still continues, as water containing lime is continually dropping from the roof.

In all the caves yet examined in this district both animal and human bones have been found in large or small quantities. They occur in rubbish at the bottom of the caves at various depths; sometimes they are under a covering of stalagmite, and not unfrequently they are imbedded in it. Most of the bones are completely changed chemically, so that everything which is gelatinous and soluble in water has disappeared, and only the lime of the texture remains. Even this is so porous that, for instance, if water be poured through the broken end of a thigh bone of the Cave-bear, it will immediately run out through any chance opening at the other end.

The bones and skulls occur separately, and skeletons are never found entire. Thus in excavating, bones and teeth of several hundred individuals of the Cave-bear were discovered, but in no one instance was there a complete skeleton; there was not even a single case of the lower jaw being united with any of the numerous skulls of this animal. Even the two halves of the under jaws were almost always separated; they were only united in one single instance.

The bones and skulls lying in the damp parts of the ground were quite soft and fragile, and great care was required to secure them uninjured. But after exposure to the air they became so solid as to require no further attention. Only the teeth, and more especially the canines of the Cave-bear, cracked and flew to pieces on being dried in the air; they had either to be soaked in lime-water, or dried gradually with the greatest care.

The human remains and works of art, like the animals found in these caves, seem to be of very varied degrees of antiquity.

We have thus a silver denarius of the reign of Antoninus Pius (A.D. 140); an Iron lance-head; a Bronze fibula; Hand-made vessels of burnt clay; Polishing stones; Beads of Bone, Amber, and Glass; Ivory and Bone ornaments and bone needles, and awls; spindle-whorls and flint flakes and knives.

The list of animals shows a large proportion of modern forms.

The following is a list of the animals whose remains have been found in the Bone-Caves of Ojcow. Human remains and works of industry abundant, but of varying date, mostly neolithic—some certainly still later.

\* Marked thus are the most ancient or extinct forms.

† Those marked thus have migrated from this region to the North or South.

\* *Ursus spelæus* (Cave-Bear).

\* *Felis spelæa* (Cave-Lion).

† — *Lynx* (the Lynx).

— *catulus* (Wild Cat).

\* *Hyaena spelæa* (Cave Hyaena).

*Canis lupus* (the Wolf).

— *spelæa*.

*Canis vulpes* (Fox).

† — *lagopus* (Arctic Fox).

*Meles taxus* (Badger).

*Mustela martes* (the Marten).

*Putorius fœtidus* (Polecat).

*Plecotus auritus* (Long-eared Bat).

*Vesperugo pipistrellus* (Dwarf-Bat).

<i>Vesperugo scrotinus</i> (Late-flying Bat).	† <i>Myodes lemnius</i> var. <i>Obensis</i>
<i>Vespertilio murinus</i> (Mouse-coloured [Bat]).	<i>Sciurus vulgaris</i> (common Squirrel).
<i>Talpa europæa</i> (the Mole).	<i>Myoxus glis</i> (Dormouse).
<i>Erinaceus europæus</i> (Hedgehog).	<i>Cricetus frumentarius</i> (Hamster).
<i>Sorex vulgaris</i> (Shrew).	<i>Mus sylvaticus</i> (Wood-mouse).
† <i>Cervus tarandus</i> (Reindeer).	<i>Arvicola glareolus</i> .
† <i>Alces malchis</i> , Linn. (the Elk).	——— <i>amphibia</i> .
<i>Cervus elaphus</i> (Red Deer).	——— <i>ratticeps</i> .
——— <i>capreolus</i> (Roebuck).	——— <i>arvalis</i> .
<i>Ovis</i> , sp. (Sheep).	——— <i>agrestis</i> .
<i>Capra</i> , sp. (Goat).	<i>Syrnium aluco</i> .
† <i>Antilope saiga</i> ?	<i>Merula torquata</i> .
* <i>Bos primigenius</i> .	<i>Fringilla linota</i> .
——— <i>taurus</i> .	——— <i>carduelis</i> .
——— <i>priscus</i> .	<i>Emberiza</i> sp.
<i>Equus fossilis</i> (?) (Horse).	<i>Corvus cornix</i> .
* <i>Elephas primigenius</i> (Mammoth).	<i>Garrulus glandarius</i> .
* <i>Rhinoceros tichorhinus</i> .	<i>Hirundo</i> sp.
<i>Sus scrofa</i> (Wild-boar).	<i>Tetrao urogallus</i> .
——— sp.	<i>Perdix cinerea</i> .
<i>Lepus europæus</i> (Hare).	<i>Gallus domesticus</i> .
——— <i>variabilis</i> (Mountain Hare).	<i>Anser</i> .
<i>Myodes (Cuniculus) torquatus</i> (Lemming.)	<i>Bufo</i> sp.
	<i>Rana temporaria</i>

The most ancient (six in number, marked \*) are the Cave-bear and Lion; the Hyæna; Great Ox; the Mammoth, and the tichorhine Rhinoceros. To these may be added (marked †) the Lynx, the Arctic Fox; the Reindeer; the Elk; the Lemming and the Saiga Antelope, all living now in Europe or Asia. In analysing the list of animals, it must be borne in mind that the interest attaching to these remains is greatly modified by the fact of their geographical position on the continent. Had the same animals been met with in England, they would have invoked a far higher interest than in Silesia, where in adjacent countries many of them still survive, whereas with us most of them have been exterminated in prehistoric times.

The twelve lithographic plates of Implements and Bones are well executed. The frontispiece is a photograph of a huge skull of the Cave Bear from Oizoff.

II.—BEITRÄGE ZUR GEOLOGIE UND PALEONTOLOGIE DER LIBY-  
SCHEN WÜSTE UND DER ANGRENZENDE GEBIETE VON ÆGYPTEN.  
Unter mitwirkung mehrerer Fachgenossen herausgegeben von  
KARL A. ZITTEL. I. Geologischer Theil von K. A. ZITTEL mit  
einer Uebersichtskarte.

CONTRIBUTIONS TO THE GEOLOGY AND PALEONTOLOGY OF THE  
LIBYAN DESERT AND THE ADJACENT EGYPTIAN TERRITORY. By  
KARL A. ZITTEL, assisted by several scientific colleagues. I.  
Geological part by Prof. ZITTEL. With a Geological Map. 4to.  
pp. 147. (Cassel, Theodor Fischer, 1883.)

THE main portion of this volume contains a description of the geological structure of the Libyan desert, based on the observations made by the author, who acted as geologist to the Expedition which, under the leadership of Gerhard Rohlfs, traversed this district in the winter of 1873-4. The author, however, has not limited his

description merely to the territory which came under his own notice; but, by bringing together the scientific investigations made by various travellers in the desert regions of North Africa, he has given, in the first portion of the work, a clear and instructive account of the geological history of the great African Sahara, of which the Libyan desert forms the north-easterly portion.

Over nearly the entire breadth of North Africa, between 17° and 30° north latitude, embracing an area of about 160,000 square miles, the surface layer is formed either of sand or naked rock, and the rainfall is either altogether wanting or so slight that there is a consequent poverty or complete absence of plant and animal life. Throughout this territory the geological structure is of an extremely regular and simple character. The surface of the Sahara is anything but a depressed basin; for, without reckoning the mountain ranges of Tuareg, Tripoli, and Tibesti, of which the highest summits are from 1500 to 2000 mètres S.L., the average elevation of the whole country is from 300 to 400 m. above the sea. It presents an elevated central portion which gradually slopes to the west, east, and south, but more towards the north, so that near the Mediterranean the surface is even below the sea-level.

The author remarks that although the causes of desert formation are of themselves independent of the surface characters, and wholly controlled by meteorological laws, yet there is a connection between the characters of a desert country and certain geological conditions. Countries with a strongly developed relief, with frequent diversities of mountain and plain, are very seldom destitute of rainfall; the moisture-laden clouds collect round the mountains, and their contents are deposited on the adjoining plains. Only where the wind blows unhindered over wide, level land-surfaces, does it become dry, and the land is changed into desert. Level plains or widely extended table-lands are almost without exception formed of horizontal strata, and this is the case in the Sahara, where, as far as known, all the sedimentary rocks are either horizontal or very slightly inclined. Mountains composed of arched or vertical rocks like those of Europe and Asia are unknown in the Sahara; the mountain-ranges of this region are merely so many platforms one rising over the other.

Three typical conditions of surface structure prevail throughout the Sahara; (1.) The plateau-desert or Hammâda. (2.) The erosion-desert (Sebcha, Djûf, Schott) and (3.) The sand-desert proper (Erg or Areg). To these the mountain-desert may be added, as constituting another type peculiar to the mountain ranges.

The commonest type is that of the Hammâda, which is a level stony surface destitute of elevations or depressions, without springs or water-courses. The surface is a hard rock or harder clay, covered with stony blocks and fragments of various sizes, which under the influence of the strong changes of temperature, have been formed by the splitting up of the surface strata. In many instances labyrinthic passages have been worn in the horizontal strata and isolated columns and masses of rock bear witness to the amount of denudation which they have undergone. Some of these masses are from 30 to 50 m.

in height, and they stand out, as so many islands, not infrequently miles in advance of the main body of the rock with which they were formerly continuous.

In the central districts of the Sahara, where the terraces reach an elevation of 800 to 1000 m. S.L., the Hammâda type of desert passes into the mountain-desert type characterized by plateaux from 500 to 1000 m. higher than the surrounding country, bordered by vertical walls which have been deeply furrowed into gullies by water and wind. From these mountain plateaux, water-courses now dry extend, often hundreds of miles into the desert.

Independent of these water-courses, the Sahara has numerous basin-like depressions of various dimensions, frequently inclosed by steep rock-walls, which belong to the erosion-desert type. The bottom of these depressions is nearly level and covered with a crust of salt or clay containing gypsum; when it rains, the surface is changed into a swamp.

The sand-desert proper, to which fortunately only about one-ninth of the Sahara belongs, consists of a wave-like carpet of pure quartz sand, from which groups or parallel chains of dunes, from 50 to 150 m. in height, project.

The most important facts relating to the geology of the Sahara as a whole are epitomized by the author as follows:—

1. The Sahara is distinguished by a remarkably simple geological structure, by the horizontal position of the major part of the sedimentary rocks, and the absence of important discordances, folds and faults.

2. At the south foot of the Morocco Atlas, rocks of Devonian and Carboniferous age are exposed, and further southwards, sandstones and Palæozoic slates, occasionally broken through by granite and porphyry, and also quartzitic and Azoic clay-slates, appear.

3. In the depression between the range of the Atlas and the Ahaggar Mountains, there is a surface layer of Quaternary fresh-water sands and clays holding gypsum and rock salt, which overlies rocks of the age of the Middle and Upper Chalk.

4. Similar Cretaceous deposits compose the surface of Hammâda el Homra and of the Harudj Mountains in Tripoli. To the south, Devonian sandstones appear, which, with subordinate beds of limestone and shale, extend to the southern borders of the desert.

5. Formations of Permian, Triassic, Jurassic, and Lower Cretaceous age do not appear to exist either in the Sahara or in the Egyptian border ranges.

6. The great mountain plateau of the Ahaggar in Aïr and Tibesti appears to be principally composed of Palæozoic sandstone, clay-slate, gneiss and granite, and of eruptive rocks of a later age.

7. Marine Tertiary deposits are only known to the north of the Schotts of Tunis, and also covering a considerable area in the Lybian and Arabian deserts.

8. Eocene Nummulitic rocks in the North-east Sahara and Egypt reach southwards as far as the latitude of Esneh, whilst the southern limit of the Miocene is found in the oasis of Siuah and the hills between Cairo and Suez.



9. The Southern, and part of the Central Sahara, have been land since the close of the Devonian period; the greater part of the remainder of the Sahara became dry after the Cretaceous period, and only in the Libyan desert did the sea extend during the Eocene, and, in the northern portion, until the middle of the Miocene period.

10. The eruption of basaltic, phonolitic and trachytic rocks in Tripoli, the Libyan and Arabian deserts, and also probably those in the mountain territory of Ahaggar and Tubu, caused but slight disturbance and metamorphism in the surrounding rocks, and may probably have taken place in the newer Tertiary period.

11. During the Quaternary period (*Diluvialzeit*) the Sahara as well as a portion of the southern and eastern area of the Mediterranean was dry land.

12. The hypothesis of a Quaternary sea over the Sahara is not supported either by the geological structure or by the surface characters of the desert. At the utmost only the region of the Tunisian Schotts was connected with the Mediterranean, and the slight depression between Alexandria and the Ammon oasis may have been united with the Red Sea.

13. During the Quaternary period a moist climate prevailed in North Africa, which probably continued until the commencement of the present period.

14. The characteristic surface features of the Sahara, such as the excavation of the numerous dry water-courses and basin-like depressions, the formation of the steep precipices and isolated rock masses, may be attributed to the eroding action of fresh-water.

15. The desert-sand results from the decomposition of the sandstone strata, which is the prevailing rock throughout the Central and Southern Sahara. Its distribution and its heaping up into dunes have been effected by the wind.

16. The salt bogs and also the surface incrustations of salt and gypsum have been derived from the solution by water of these materials in the older rocks and the subsequent evaporation of the water in depressed areas.

17. There is no proof of any important change in the climatic conditions of the Sahara during the historic period.

The second part of the work, relating more particularly to the Libyan desert, commences with a review of the literature which has already appeared on the geology of this district and Egypt proper. It is followed by a detailed description of the character, the boundaries, and the fossil contents of the various strata. The geological character of the entire territory west from the Nile is astonishingly simple. With the exception of some inconsiderable landslips bordering the escarpments, there is no alteration of the strata worth mentioning, not even a single well-marked fault. All the sedimentary rocks appear to the observer to be horizontal, and it is only by extended investigations that a slight incline towards the north and east can be distinguished. From this it results that the oldest strata are in the south and the newest in the north. The former belong to the Cretaceous, and the latter to the Tertiary period.

1. *The Cretaceous System.*—The Cretaceous system of the Libyan desert can be divided into four series.

I. The Nubian sandstone, which is the oldest sedimentary rock west of the Nile. It was largely employed in the gigantic temples of Upper Egypt and Nubia, and the mighty Memnon Colossi of Thebes; and its regular bedding and the presence of thin bands of soft clay and marl greatly facilitated the excavation of enormous monoliths and cubical blocks. In the neighbourhood of Assuan, this sandstone rests on granite and its lowest beds consist almost everywhere of small quartz pebbles in a matrix of a kaolinic material. The only fossils discovered in this sandstone are fragments of wood belonging to two species, *Nicolia Ægyptiaca*, Unger, and *Araucarioxylon (Dadoxylon) Ægyptiacum*, Unger, sp. There is no doubt of the identity of this sandstone in Assuan, Nubia, and the Libyan desert, and that it is of Middle or Upper Cretaceous age; most probably the equivalent of the Cenomanian. Very various opinions have been put forward by different observers as to its age, arising from the fact that it has been confounded with strata of similar petrographical characters in Palestine, the Peninsula of Sinai, and Abyssinia. The Abyssinian sandstone has been described by Blanford as either Permian or Triassic, and from some imperfect fossils found in the Sinaitic strata it is probably of Carboniferous age. It follows, therefore, that the term "Nubian" sandstone should be restricted to the beds exposed in Nubia, Assuan, and the Libyan desert.

II. Strata with *Exogyra Overwegi*. These consist of beds of marl, clay, and limestone, with rock-salt and gypsum, in all about 150 m. in thickness. Fossil wood, fish teeth (*Otodus* and *Lamna*), and shells of *Exogyra* and *Inoceramus*, and also of Ammonites, occur in this division.

III. Greenish and Ashy-grey Laminated Clays. These vary from 30 to 80 m. in thickness. The beds in places are even black in tint, and are always bituminous and gypsiferous. The fossils are distinctively of Upper Cretaceous age, and though the species are not very numerous, yet the individuals are so abundant that in places the surface is completely covered with their casts in iron oxide.

IV. Snowy-white bedded Limestone or Earthy Chalk. This summit division of the Upper Chalk varies from 20 to 50 m. in thickness; it frequently forms vertical walls bordering the summits of the hills and plateaux. In some localities it is nearly entirely composed of Coccoliths and Foraminifera (*Textularia*, *Cristellaria* and *Rotalia*), as well as larger fossils, some of which, particularly *Gasteropoda*, bear a certain resemblance to Eocene forms. The presence of *Ananchytes ovata* and *Ventriculites*, as well as other Upper Chalk fossils, clearly defines its geological horizon.

The Upper Chalk of the Libyan desert is characterized not only by its great development of over 400 mètres in thickness, but also by its varied petrographical characters, and its astonishing richness in well-preserved fossils. It is probable that when the fossils are fairly well known, the North African facies of the Upper Chalk

will be regarded as the true normal development of the Senonian division of the system.

2. *The Tertiary System.*—There is no sharp demarcation line between the Chalk and the Tertiary rocks in the Libyan desert. There is no gap in the stratification, no interval of fresh-water deposits, or any appearance of eruptive rocks to mark the interval between the two systems, but the chalky sediments of the older Eocene follow those of the Upper Chalk with hardly any variation in their characters. And yet palæontologically the boundary between the Chalk and the Eocene is clearly defined, notwithstanding the continuity of marine deposits. The author had never observed either in or above the oldest Nummulitic bed a single characteristic Chalk fossil; neither a Nummulite in the Chalk strata. This remarkable continuity of deposition is in striking contrast with the hiatus, which, nearly everywhere in Europe, exists at this horizon, and can only be paralleled with the deposits of similar age in the Western territories of North America.

A. The Eocene deposits of the Libyan desert are subdivided as follows :

I. *The Libyan series (Lower Eocene).*—This series is mostly of a calcareous nature, though its lowest beds are occasionally clayey or sandy, and then always thin-bedded and saliferous; it reaches a thickness of about 500 m. Prof. Zittel separates it into a lower and upper division; the lower, typically shown in the Nile valley between Esneh and Thebes, and in the border precipices of the Oasis of Chargeh, has for its characteristic fossil *Operculina libyca*, Schwager, which fills entire beds; this species is accompanied by several forms of Nummulites, *Alveolina*, etc. The upper division of the Libyan series is best displayed in the Nile valley between Siut and Cairo, and its principal fossils are long fusiform *Alveolinas* of the group of *A. oblonga*; as well as a great variety of species of *Miliola*. This division is regarded as homotaxial with the London Clay.

II. *The Mokattam series.*—This name is derived from the well-known Mokattam hills in the neighbourhood of Cairo, where sections of the familiar limestone rocks so largely composed of Nummulites are clearly shown, with a thickness of about 250 mètres. The distinguishing fossils are *Nummulites Gizehensis*, *N. curvispira*, *N. Beaumonti* and *sub-Beaumonti*. The Mollusca of this series according to Prof. Mayer-Eymar show that it is of corresponding age to the Lower Parisian.

In many localities in the desert the Mokattam limestones are filled with flint nodules similar to those of our Upper Chalk. These nodules, by the weathering away of the limestone, remain to form a complete surface layer, and the Nummulites, as well as other fossils, frequently occur in the same situation in a silicified condition. Prof. Zittel noticed the remarkable fact that whilst the uncovered and air-exposed portions of these fossils are silicified, the covered parts remain calcareous. He says: "Limestone blocks are abundant which have a crust of silica an inch in thickness,

whilst the interior portion is completely unaltered; also the Numulites and other fossils are often silicified on their upper surface, whilst the under side retains its calcareous constitution. These phenomena indicate a process of slow superficial silicification, which may be explained by minute portions of silica dissolved in dew, which gradually take the place of the carbonate of lime."

III. Upper Eocene Series.—These were only seen in the extreme westerly portion of the desert traversed by Rohlfs' expedition, and consist of limestone beds of about 10 m. in thickness, nearly entirely composed of organic remains. The character of the Mollusca indicates that these beds belong to the horizon of the Barton Clay. Upper Eocene or Oligocene strata of a probably somewhat newer date were discovered by Prof. Schweinfurth in a small island in the Lake Birket-el-Qurûn; the vertebrate remains from these beds have been already described by Dr. Dames.

B. Miocene deposits are clearest shown on the northern margin of the Oasis of Ammon, near the small town of Siuah, where an escarpment 130 m. in height, of limestone and calcareous clays, with abundant fossils, is displayed. This Miocene limestone near Siuah is the last marine deposit in the Libyan desert, though it may probably continue towards the north over the Cyrenaish plateau. In some localities in the sandy desert between Regenfeld and Siuah, beds of freshwater limestone overlaid by quartz and sandstones, from 10 to 12 m. in thickness, are exposed; the shells in them are insufficient to determine their distinctive horizon, but from their intimate connection with the Lower Miocene marine beds, they may probably belong to the Middle Tertiary period. Petrographically the sandstones resemble those which near Cairo contain the well-known silicified trees. These trees are naked trunks, without branches or roots, and destitute of bark; they are strewn in great profusion irregularly over each other in a horizontal direction. The wood has been completely silicified, and the fibrous structure is so beautifully preserved that it can be distinguished by the naked eye. Schenk has recognized no fewer than nine species belonging to eight genera, amongst which is a palm, a conifer, and seven dicotyledonous forms. The age and the origin of these forests of silicified trees are both uncertain. Considering their gigantic dimensions—some reaching from 20 to 30 m. in length, and 3·5 m. in circumference,—and their condition, it is impossible to suppose that they can have been transported any distance by water; and it is probable that they grew near where they are now found. The circumstance that these trees belong to extinct species, and mostly to genera, which, if not extinct, do not now exist in Egypt, points rather to their Tertiary than to their Quaternary age.

3.—*Quaternary and Recent Formations.*—In the Libyan desert these are comparatively rare, but it is probable that during the Quaternary period the now southern desert regions were exposed to the influence of an abundant freshwater supply, which excavated the valleys and formed the steep terrace-margins and the island-like hills. There is no doubt that the Nile at an earlier period was a

much mightier stream than at present, and it is not improbable that it may then have emptied itself into the Red Sea.

Among the Quaternary deposits may be mentioned beds of Calcareous Tuff in the oasis of Chargeh containing reeds and leaves of *Quercus ilex*, a tree which now grows in Southern France and Corsica. The position of the tuff beds and their contents clearly show that the outline of the country was the same at the period of their formation as at present, and that strong springs then sprang from what is now a sterile limestone plateau.

Not the least wonderful of the phenomena of the Libyan desert are the springs and artesian wells of thermal water, which has a temperature between 24° and 38° C. This water is probably derived from the rainy zones of Central Africa, from whence it has filtered through the gently inclined beds of Nubian sandstone, the intervening clayey strata preventing its descent to lower levels.

This chapter concludes with a reference to the flint implements which are found in many places in the valley of the Nile: near Thebes; more particularly at Helouan, near Cairo, and also in localities in the Sahara no longer habitable, thus showing the presence of man in the country when a more favourable climate prevailed than that now existing. Much stress has often been laid, by those who are so anxious to restrict human existence to the traditional 6000 years, on the untrustworthy character of the evidence afforded by these flint implements, and the probability that many of them result from natural influences; and it is therefore worth while to quote Prof. Zittel's own experience in this matter. He says, "During our journey I had noticed with special astonishment the form of the numberless fragments of brown and black flints which for miles covered the surface of the limestone plateau. Every possible form appeared present in these naturally splintered fragments, but never those elongated small and thin lamina which are so well known to the Archæologist as palæolithic knives and scrapers. Only once did I find near Regensfeld, thus in the barrenest and most inaccessible part of the Libyan desert, in a small depression surrounded by steep escarpments, a number of such knives, whose manufacture by human hands could not be doubted."

The foregoing notes and extracts will serve to show the complete and exhaustive description which Prof. Zittel has given in this work of the geology of North Africa. However barren the desert may be in most respects, Prof. Zittel has shown that it is certainly a fruitful region for geological observation, and that he has reaped a rich harvest therein.

G. J. H.

### III.—TRANSACTIONS OF THE CUMBERLAND ASSOCIATION FOR THE ADVANCEMENT OF LITERATURE AND SCIENCE. NO. VIII. 1882-83.

THE work before us comprises the Proceedings of the Association at the annual meeting held at Ambleside, the Papers communicated to affiliated societies during the session, and a number of local notes and memoranda. The plan of the Association, which is carried

out to some extent in other English counties, might well be adopted in all, where more than one local society exists; for it is a great advantage to have registered in one yearly volume all the important work done in various branches of Natural History. The Cumberland Association embraces societies at Whitehaven, Keswick, Workington, Maryport, Longtown, Carlisle, Ambleside, Silloth, Brampton, Penrith, and Windermere: and the Presidents of these local societies are Vice-Presidents of the Association. Botany, Zoology, Geology, Mineralogy, and Archæology are well represented in the present volume.

The contributions to Geology include a paper on the "Water Supply in the Carlisle Basin," by T. V. Holmes. He concludes that it would be impossible to mention any part of the British Isles, of similar extent, in which the geological construction of the district more decidedly favours water supply, by means of deep artesian wells, than does that of the Carlisle Basin.

An account of the "Graptolites of the Skiddaw Slates" is given by Mr. J. Postlethwaite; he furnishes lists of species and of localities. Of about 250 British species, forty have been found in the Skiddaw Slates.

Mr. J. F. Crosthwaite discourses about "The German Miners at Keswick," who settled in the parish in the reign of Queen Elizabeth.

Probably the most interesting paper is the biography of "Professor Robert Harkness, F.R.S., F.G.S.," by Mr. J. G. Goodchild. The life and labours of this eminent geologist are intimately connected with the Lake District; for although he held the post of Professor of Geology at Cork for five-and-twenty years, his earliest geological work was done in Lancashire, Cumberland, and Dumfriesshire; and he returned again and again to study the rocks of the Solway Basin and of the mountainous region of the Lake country. His papers, many of them published in the Quarterly Journal of the Geological Society, are well known to geologists; and Mr. Goodchild, who has had excellent opportunities of studying in the same field, observes in reference to the labours of Prof. Harkness in Edenside: "Here and there the Geological Survey has been led to differ from the author in matters of minor detail; but in the main, the points of agreement are so numerous as to form matter for surprise to every one that realizes the full extent of the difficulties that Harkness dealt with and overcame single-handed so many years ago."

Space forbids our entering into further particulars of the work of Prof. Harkness, but we cannot refrain from drawing attention to a passage in a letter from J. B. Jukes, who remarks (1862), "I believe the Lower Old Red to be uppermost Silurian, and the uppermost Old Red to be lowermost Carboniferous." Other interesting letters from Sedgwick, Murchison, and Lyell are inserted in this Biography. In one of Sedgwick's (1865), he says, "I proved many a long year since that the fossils of the Magnesian Limestone group were essentially Palæozoic. But physically the group seemed part of the New Red. So the matter stood. I suggested no change of correlation. So a year afterwards Phillips proposed (at the Geological

Society) that we should cut the group off from the Trias—as it was Palæozoic. . . . *Murchison objected!* (he was the *only one* that stood out) and he continued his objections, arguing that *Reptiles* were secondary groups.”

Mr. Goodchild also contributes the second part of “Contributions towards a list of the Minerals occurring in Cumberland and Westmorland.”

The Local Scientific Notes and Memoranda form a useful feature in this volume, and the Association may be congratulated on the careful way in which the work has been edited. H. B. W.

---

## REPORTS AND PROCEEDINGS.

---

### GEOLOGICAL SOCIETY OF LONDON.

I.—ANNUAL GENERAL MEETING.—February 15th, 1884.—J. W. Hulke, Esq., F.R.S., President, in the Chair.

The Secretaries read the Reports of the Council and of the Library and Museum Committee for the year 1883.

In presenting the Wollaston Gold Medal to Prof. A. Gaudry, F.M.G.S., the President addressed him as follows:—Prof. A. Gaudry,—The Council of the Geological Society has awarded you the Wollaston Medal in recognition of the value of your palæontological researches and the important scientific generalizations you have deduced from long and laborious observations. The numerous papers on topographical geology and on palæontology you have contributed during the past 30 years, your important “*Recherches Scientifiques en Orient entreprises par les ordres du Gouvernement pendant les années 1853–1854,*” your “*Animaux fossiles et géologie de l’Attique,*” and, lastly, your work “*Les Enchaînements du monde animal dans les temps géologiques,*” have made your name so familiar, wherever our branch of natural science is cultivated, that in receiving you, we feel we are not receiving a stranger, but a scientific brother, and one who, by his labours and singleness of aim, has achieved a position as a palæontologist such as few can hope to attain. Personally, it affords me great and sincere pleasure that it has fallen to my lot to hand you this Medal, which, by the consent of all, has never been more worthily bestowed.

Prof. GAUDRY, in reply, said:—Mr. President,—I regret much that I speak English too imperfectly to express well the sentiments which I feel in my heart. I can only say that my pleasure in receiving the Wollaston Medal is in proportion to my admiration for the labours of the illustrious Geological Society of London and to my affection for many of its Fellows. I beg the Geological Society and its distinguished President to accept my best thanks.

The PRESIDENT then presented the Balance of the Proceeds of the Wollaston Donation Fund to Mr. E. Tully Newton, F.G.S., and addressed him as follows:—Mr. Newton,—The Council has voted you the Balance of the proceeds of the “Wollaston Donation Fund,” in recognition of the value of your researches amongst the Pleistocene Mammalia of Great Britain, and to assist you in the prosecution of further investigations. Your Memoirs published by the Geological Survey of England and Wales “*On the Vertebrata of the Forest-bed series of Norfolk and Suffolk,*” and on “*The Chimæroid Fishes of the Cretaceous Rocks,*” and your papers published in our Journal, are considered by the Council to evince great merit; they regard them as a bright earnest of future work which they hope may be promoted by this award.

Mr. NEWTON, in reply, said:—Mr. President,—Most highly do I appreciate the honour which the Council of the Geological Society have conferred upon me to-day by awarding me the proceeds of the Wollaston Fund,—an honour wholly unexpected, and valued the more because of the kind manner in which you, Sir, have been pleased to speak of my work among the fossil vertebrata, which it has been a pleasure and, in part, my duty, to undertake. Such work is always a source of pleasure and profit in itself; but its recognition by those who are most capable of judging of its value is certainly the greatest satisfaction and highest reward one can receive. In accepting

this award, I do so with the greater pleasure because I feel that it is not only an honour to myself, but is an indication of the goodwill which exists between the Geological Society and the members of the Geological Survey. If anything could enhance the value of the award in my estimation, it would be receiving it, as I do to-day, from the hands of one who, standing in the foremost rank of anatomists and palæontologists, is so competent to judge of such work as mine, and who by kind and gentle sympathy has not only encouraged investigation, but gained the warmest regards of all who have come within the circle of his influence.

In presenting the Murchison Medal to Dr. Henry Woodward, F.R.S., the President said:—Dr. Henry Woodward,—The Council has awarded you the Murchison Medal and a grant of ten guineas in recognition of your valuable researches into the structure and classification of the fossil Crustacea especially of the Merostomata and Trilobita, and your services to the progress of geology in Great Britain by your conduct of the GEOLOGICAL MAGAZINE for nearly twenty years. Your Monograph on the “Merostomata,” published by the Palæontographical Society, and your “Catalogue of British Fossil Crustacea, with their synonyms and the range in time of each genus and order,” will long continue to be works of reference indispensable to every student of these interesting life-forms. But valuable as are these written records, they discover but a small part of the services you have rendered in the advancement of our science. How much more you have done by the assistance you have so freely given to all who have sought your help at the Museum in deciphering some difficult matters in palæontology will never be fully known.

Dr. WOODWARD, in reply, said:—Mr. President,—I cannot, I fear, adequately express my thanks to the Council for the honour they have conferred upon me this day in awarding me the Murchison Medal. This mark of their esteem is peculiarly appropriate, since its founder, Sir Roderick Murchison, was for many years one of the most active of the Trustees of the British Museum, under whom I have now had the honour to serve for the past twenty-six years. Since my election to the Geological Society, twenty years ago, I cannot but recall that the Council has upon two former occasions (in 1866 and 1879) encouraged and assisted me in my scientific work by an award. I feel, however, that the Medal now bestowed by you, Sir, is a far higher recognition of my scientific labours, and one which gives them the stamp of the approval of the Geological Society. I thank you for alluding to the GEOLOGICAL MAGAZINE, now in its twentieth year, and which (saving the first year, when it was edited in conjunction with Prof. P. Rupert Jones) I have personally carried on since its commencement. I believe it has had its uses, serving not only as a sluice-gate in times of emergency to let off the overflowing productions of pen-up Fellows thirsting for publication, but also as a convenient and ready method of printing *short papers*, which might be deemed too ephemeral for admission into the Society's Journal. Although, for the past four years, my time has been so very largely taken up with the removal of the Geological Collections from Bloomsbury and their rearrangement in Cromwell Road as to preclude almost entirely the possibility of doing original scientific work, I trust it will not always be so, but that shortly I may give some evidence of being worthy of the honour I have received this day; and those palæontologists who have visited and consulted the collections since their removal can best appreciate how those four years have been spent, and with what result, in the better display of the great collections now under my charge.

The PRESIDENT then handed the balance of the proceeds of the Murchison Geological Fund to Mr. R. Etheridge, F.R.S., for transmission to Mr. Martin Simpson, of Whitby, and addressed him as follows:—Mr. Etheridge,—The balance of the proceeds of the Murchison Donation Fund has been awarded by the Council to Mr. M. Simpson, Curator of the Whitby Museum. He has devoted much attention to the fossils of that district, and he is the author of two books descriptive of them. The Council hopes that this cheque may be of assistance to him in continuing the useful extra-official work he has long been carrying on in that locality.

Mr. ETHERIDGE, in reply, expressed the pleasure that it gave him to receive, on behalf of Mr. Simpson, this testimony of the Society's appreciation of the life-long labours of one who had pursued palæontological studies with so much devotion, and read a letter which he had received from Mr. Simpson.

The PRESIDENT next handed the Lyell Medal to Professor W. H. Flower, F.R.S., for transmission to Dr. Joseph Leidy, F.M.G.S., and addressed him as follows:—Prof. Flower,—The Council has bestowed on Dr. J. Leidy the Lyell Medal, with a



sum of £25. in recognition of his valuable contributions to palæontology, especially as regards his investigations on the Fossil Mammalia of Nebraska and the Sauria of the United States of America. These vast and, in comparison with our own country, but little-explored territories have for some years past yielded a harvest of fossil vertebrate remains of exceeding richness, of which we have no example here. How well this harvest is being garnered by our Transatlantic *confirères* the flood of memoirs published by them during the last quarter of a century bears witness. Amongst these scientific labourers in the palæontological harvest-field, Dr. J. Leidy has held a foremost place. Careful in observing, accurate in recording, cautious in inferring, his work has the high merit which trustworthiness always imparts. The well-nigh astounding number of papers written by him between 1845 and 1883, amounting to 187, his Reports on the "Extinct Vertebrate Fauna of the Western Territories," his "Synopsis of the Extinct Mammalia of North America," and his "Cretaceous Reptiles of the United States," testify to the fertility of his pen.

Professor FLOWER, in reply, said:—Mr. President,—As I have profited so deeply by Dr. Leidy's palæontological writings, and also have the pleasure of his personal friendship. I was much gratified by his request, communicated to me by telegraph a few days ago, that I would represent him on this occasion, and receive from your hands the award which the Council has so worthily bestowed. By the same means of communication, he mentions the interesting incident, that it was by Sir Charles Lyell's advice, given to him in Philadelphia about thirty years ago, that he was induced to abandon the study of medicine and take up palæontology.

The following letter has been received from Dr. Leidy:—

Philadelphia, Pa., 1302, Filbert St., Feb. 7th, 1884: My dear Sir,—I have this minute received your note of Jan. 25th, and hasten to reply, that there may be no delay in my answer, for the Anniversary Meeting of Feb. 15th. I was equally surprised and delighted at the action of the Council of the Geological Society in awarding to me the Lyell Medal and its accompaniment. Such approbation of my services I regard as rich compensation added to the pleasure derived from my labours. I must add that I feel as if Sir Charles Lyell himself was expressing satisfaction, in consideration of my having complied with his wish, when thirty years ago, in my own home here, he said he hoped I would devote my time to Palæontology, instead of Medicine. Please present to the Geological Society my warmest thanks for the honour it has conferred upon me.—With sincere regards, JOSEPH LEIDY.—Mr. Warrington W. Smyth, For. Sec. Geol. Soc."

In presenting to Prof. C. Lapworth, F.G.S., the balance of the Lyell Geological Fund, the President said:—Prof. Lapworth,—The Council has awarded to you the balance of the proceeds of the Lyell Donation Fund in recognition of the value of your researches into the palæontology and physical structure of the older rocks of Great Britain, carried on frequently under unfavourable circumstances and to the injury of your health, and to aid you in similar investigations. Your papers on "The Girvan Succession," "The Moffat Series," published in our Journal, and "The Graptolites," and "The Secret of the Highlands," contributed to the GEOLOGICAL MAGAZINE, were the outcome of an extremely laborious and detailed exploration of the districts to which they refer—an exploration in conducting which you spared no pains and shrank from no hardships. No one who desires to know the structure of these districts can safely omit a careful study of these very instructive papers.

Professor LAPWORTH, in reply, said:—Mr. President,—I am very grateful to the Council of the Geological Society for this proof of their continued interest in my geological work, and to yourself, Sir, for the generous and kindly manner in which you have spoken of what I have done. I am at present too little recovered to hope that I shall soon be in a position to resume my studies of the ancient British rocks and fossils; but you may rest assured that immediately my ordinary health is restored, I shall of necessity gravitate again, if I may so express myself, to the old familiar fields. As this award has been made me from the Lyell bequest, I shall hold it both a pleasure and a duty to endeavour to devote it to working out a few fresh facts for discussion in this Society, along the lines laid down in the "Principles." Whether that endeavour will ever be realized is for the future to determine. Even the most I ever hope to accomplish will be to show, that, vast as is the mass of geological material hitherto collected, how insignificant it actually is in comparison with that which remains for discovery, and what a mighty future waits that great science to which we are all devoted.

The PRESIDENT then handed to Professor Bonney, D.Sc., F.R.S., for transmission

to Dr. J. Croll, a portion of the proceeds of the Barlow-Jameson Fund, and said:—Professor Bonney,—The Council, in recognition of the value of Dr. James Croll's researches into the "Later Physical History of the Earth," and to aid him in further researches of a like kind, has awarded to him the sum of £20 from the proceeds of the Barlow-Jameson Fund. Mr. Croll's work on "Climate and Time in their Geological Relations," and his numerous separate papers on various cognate subjects, including the "Eccentricity of the Earth's Orbit,"—"Date of the Glacial Period," the "Influence of the Gulf Stream," the "Motion of Glaciers," "Ocean Currents," and the "Transport of Boulders," by their suggestiveness have deservedly attracted much attention. In forwarding to Dr. Croll this award, the Council desires you to express the hope that it may assist him in continuing these lines of research.

Professor BONNEY, in reply, said:—Mr. President,—I have been charged by Dr. J. Croll to express to the Society his regret that his weak health and the great distance at which he resides prevent him from being present in person to-day to receive this award. He desires me to express his deep sense of the honour which is done to him in this renewed mark of the appreciation of his work, and he gives us the cheering news that though still at times suffering, he is now able to do a little work, a proof of which, in a paper on Mr. Wallace's remarks on the theory of Climate, reached me yesterday. Deeply though I regret Dr. Croll's absence, I feel honoured in representing a man who has done such original suggestive and valuable work.

In handing to Professor Seeley, F.R.S., a second portion of the proceeds of the Barlow-Jameson Fund for transmission to Prof. Leo Lesquereux, F.C.G.S., the President spoke as follows:—Professor Seeley,—The Council has awarded to Professor Leo Lesquereux the sum of £20 from the proceeds of the Barlow-Jameson Fund, in recognition of the value of his researches into the Palæobotany of North America, and to aid him in further investigations of a similar kind. Professor Lesquereux's "Contributions to the Fossil Cretaceous and Tertiary Flora of the Western Territories," published in the "Reports of the United States Geological Survey," are works which, for their matter, typography and illustrations, leave nothing to desire. In transmitting this award to Professor Lesquereux, you will convey to him the hopes of the Council that it may assist him in prosecuting further investigations in the difficult branch of research in which he has already accomplished so much.

Professor SEELEY in reply, said:—Mr. President,—I feel much honoured in receiving this award on behalf of Professor Lesquereux. His valuable researches not only contribute systematic descriptions of the American Secondary and Tertiary floras, but furnish almost the only data for comparing those floras with the plant life from similar strata on this side of the Atlantic. All Professor Lesquereux's work is marked by such exactness and care, that I am glad we are thus able to honour it, and offer assistance in its progress.

The PRESIDENT then read his Anniversary Address, in which, after giving obituary notices of some of the Members lost by the Society in 1883, he passed in review the principal work done by the Society since the last Anniversary Meeting, and finally referred more in detail to some important results obtained elsewhere in connexion with the comparative osteology of the Vertebrata, dwelling particularly upon the question of the existence in the lower jaw of an unpaired bone occupying, or anterior to, the symphysis—the "os pré-symphysien" of M. Dollo, the "mento-Meckelian" of Cope, the "inferior intermaxillary element" of W. K. Parker,—and upon certain cranial and pelvic characters of the Dinosauria.

The ballot for the Council and Officers was taken, and the following were duly elected for the ensuing year:—*President*: Prof. T. G. Bonney, D.Sc., F.R.S. *Vice-Presidents*: W. Carruthers, Esq., F.R.S.; John Evans, D.C.L., LL.D., F.R.S.; J. A. Phillips, Esq., F.R.S.; Prof. J. Prestwich, M.A., F.R.S. *Secretaries*: W. T. Blanford, Esq., F.R.S.; Prof. J. W. Judd, F.R.S. *Foreign Secretary*: Warrington W. Smyth, Esq., M.A., F.R.S. *Treasurer*: Professor T. Wiltshire, M.A., F.L.S. *Council*: H. Bauerman, Esq.; W. T. Blanford, Esq., F.R.S.; Prof. T. G. Bonney, D.Sc., F.R.S.; W. Carruthers, Esq., F.R.S.; John Evans, D.C.L., LL.D., F.R.S.; Col. H. H. Godwin-Austen, F.R.S.; Henry Hicks, M.D.; Rev. Edwin Hill, M.A.; G. J. Hinde, Ph.D.; J. Hopkinson, Esq.; Prof. T. McKenny Hughes, M.A.; J. W. Hulke, Esq., F.R.S.; J. Gwyn Jeffreys, LL.D., F.R.S.; Prof. T. Rupert Jones, F.R.S.; Prof. J. W. Judd, F.R.S.; J. A. Phillips, Esq., F.R.S.; Prof. J. Prestwich, M.A., F.R.S.; F. W. Rudler, Esq.; Warrington W. Smyth, Esq., M.A., F.R.S.; J. J. H. Teall, Esq., M.A.; W. Topley, Esq.; Prof. T. Wiltshire, M.A., F.L.S.; Henry Woodward, LL.D., F.R.S.

II.—February 20, 1884.—Prof. T. G. Bonney, D.Sc., F.R.S., President, in the Chair.—The following communications were read :

1. "On a recent Exposure of the Shelly Patches in the Boulder-clay at Bridlington." By G. W. Lamplugh, Esq. Communicated by Dr. J. Gwyn Jeffreys, F.R.S., F.G.S.

During some long-continued windy weather in the early part of the winter of 1882–83, the Boulder-clay, usually hidden by sand and shingle, was laid bare on the foreshore at Bridlington Quay. The beds thus exposed belong to the lowest recognized part of the glacial series of Yorkshire, the "Basement Boulder-clay." Over this, parted occasionally by a little sand or gravel, comes the Purple Boulder-clay, the Laminated Clay being wholly absent. The Basement Clay thus exposed contained angular and subangular boulders, with rounded pebbles occasionally scratched, besides many crushed masses of sand, sandy gravel, and clay, forming nearly a third of the whole mass. The last, which generally contained marine remains, were very variable in shape and in lithological character. The fauna of the masses varied greatly, both in abundance and in species, those common in one mass being rare or absent in another. The shells were commonly much crushed, though whole specimens occur occasionally. The author considers that these shell-bearing patches had once formed a part of the bed of a glacial sea, which had been invaded and ploughed up by ice, which had transported them to their present locality. He gives reasons for thinking that they have not come from the immediate neighbourhood, but probably from the north-east, having been floated by icebergs to their present places.

The paper concludes with lists of the fossils discovered (obtained, for the most part, by washing parts of the included masses). The result has been that the number of the Mollusca (examined by Dr. J. Gwyn Jeffreys) has been raised from 67 to 101, five of the additions being new to science. Four species of *Balanus* and one of *Verruca* have been identified. More than eleven species of fish have been identified with more or less certainty, and these, Mr. E. T. Newton remarks, seem to be either Norwich-Crag, Red-Crag, or London-clay forms; and all may have been derived from the last-named deposit. The Ostracoda and Foraminifera, which are numerous, were described by Dr. Crosskey in an appendix.

2. "On the so-called *Spongia paradoxica*, S. Woodward, from the Red and White Chalk of Hunstanton." By Prof. T. McKenny Hughes, M.A., F.G.S.

The author described a branched structure found in the Red and White Chalk of Hunstanton, which was named *Spongia paradoxica* by S. Woodward, and has since generally been known as *Spongia* or *Siphonia paradoxica*. The beds in which this supposed sponge occurs contain fragments of various organisms, including sponge-spicules, but no trace of structure can be found in sections of the *Spongia paradoxica*. The fragmentary state of the undoubted organic remains would indicate that they were drifted into their present position, and therefore a state of things quite unfitted for the growth of a slender branching sponge; the so-called sponge commonly

occurs in layers along the bedding-planes, but frequently rises through the whole thickness of one bed and extends up into the overlying layers. It does not seem likely that it was the root of a *Siphonia* or some similar organism. Another body which has been also called *Spongia paradoxica* consists of masses of more crystalline texture, exhibiting upon weathered surfaces a network of small ridges inclosing cup-like depressions. These appearances were compared by the author to the weathered surfaces often seen in certain beds of the Mountain Limestone and in gypsum; the masses show no traces of internal structure.

The author stated that sections of these bodies show exactly the same characters as the containing rock, except that the material is more compactly crystalline; it contains the same fragments of shell, etc., and the same sand and pebbles. He regarded them as of concretionary origin, and explained their symmetry of form and regularity of arrangement by their being formed at the intersections of joints with the bedding-planes or with one another. Phosphatic nodules occur in the lower parts of the White Chalk, and had these bodies been sponges, they would probably have been phosphatized; but analyses have shown no marked difference in this respect between their substance and that of the surrounding rock.

3. "Further Notes on Rock-fragments from the South of Scotland imbedded in the Low-level Boulder-clay of Lancashire." By T. Mellard Reade, Esq., C.E., F.G.S.

In his paper on the Drift-beds of the north-west of England, Part II. Q. J. G. S. 1883, p. 119, the author noticed that the discovery of Criffel-granite erratics in the Lancashire drift, first made by Mr. Mackintosh, had been confirmed by Mr. P. Dudgeon, from specimens forwarded by the author in 1882. In August of last year, he had an opportunity of travelling from Dumfries through Kirkcubright to Wigtonshire, and of examining the rocks and the boulders derived from them. Two masses of granite have broken through Silurian strata in Kirkcubright; the eastern of these granite masses forms the isolated mountain of Criffel, 1800 feet above the sea, the western rises to 2331 feet, and is known as Cairnsmore of Fleet. The granite of the former is, as a rule, finer than that of the latter. Numerous boulders derived from both are found in the surrounding country.

The author pointed out in detail how different varieties of granite observed on Criffel and Cairnsmore of Fleet are clearly the rocks of which fragments are found in the drift of Lancashire; and also showed that the Silurian "Greywackés," through which the granite of the mountains named has burst, are also represented by unmistakable specimens in the Lancashire Boulder-clay. The "Greywacké" varies in texture from a fine-grained sandstone to a coarse gritty sandstone, and in colour from dark blue and grey to deep purple-red. These beds, which belong to the Queensbury-grit gravels, are well seen in a line of cliffs called the Craigs of Garheugh, at the side of the road from Glenluce to Fort William. Specimens identical with these rocks have been found in the low-level Boulder-

clay of various parts of Lancashire, as at Great Crosby, Innewick Fishery, and the Isle of Whithorn.

These identifications go far towards completing the identification of the rocks represented in the low-level Boulder-clay of Lancashire, and confirm the views already expressed by the author that all stones in the Drift of North-western England are derived from the basins of the Irish Sea, and of rivers draining to it, except some stray fragments that may have come from the Highlands of Scotland.

4. "Ripple-marks in Drift." By T. Mellard Reade, Esq., F.G.S.

Amongst published notices of drift-deposits the author has never met with any description of ripple-marks, though, if the drift was formed under water, some should be found. In a spot to which his attention was called by Dr. Callaway, the Old Park Field sand-hole at Ketley, near Wellington, Salop, in a stratified drift-deposit, he had found early in 1883 three distinct beds of ripple-marked laminae. One of the ripple-marks in the highest bed measured 9 inches from crest and  $1\frac{1}{4}$  inch in height, and had been produced by a wind from the N.W.

In July, 1883, the author found ripple-marking in hard, fine loamy brown sand underlying a compact mass of Boulder-clay at Tranmere, Cheshire, in one of the approaches to the Mersey Tunnel. The marks were on a sloping bank, and the sand was faulted in places with a throw of from 2 to 4 inches. In the sand shell-fragments occurred, some of them being recognizable as those of *Turritella terebra*, *Cardium edule*, *Tellina balthica*, and a *Pholas*.

The position of this section in a hollow between higher ground was favourable to the preservation of ripple-markings. The beds undoubtedly are those named by the author the Low-Level Boulder-clays and Sands.

---

III.—March 5, 1884.—Prof. T. G. Bonney, D.Sc., F.R.S., President, in the Chair.—The following communications were read:—

1. "On the Structure and Formation of Coal." By E. Wethered, Esq., F.G.S., F.C.S.

The author, having referred to the work of previous investigators, pointed out that seams of coal do not always occur in one bed, but are divided by distinct partings, some of which, as in the case of the Durham main seam, contain *Stigmaria*. It was important to notice this feature for several reasons, but especially as the beds of coal, defined by the partings, showed differences both in quality and structure. In the case of the shallow seam of Cannock Chase, they had at the top of a bed of coal 1 foot 10 inches thick, the brown layers of which were made up of macrospores and microspores. The bright layers were of similar construction, except that wood-tissue sometimes appeared, also a brown structureless material, which the author looked upon as bitumen. He, however, objected to that term, and thought that hydrocarbonaceous substance would be preferable. What this hydrocarbonaceous material originated from was a question for investigation. In the lower bed of the Welsh "Four Feet" seam wood-tissues undoubtedly contributed to it; whether

spores did was uncertain; it was true they could be detected in it. In the second bed of the shallow seam they had a very different coal from the upper one. It was made up almost as a whole of hydrocarbonaceous material. Very few spores could be detected. It was possible that the scarcity of these objects might be due to decomposition; but the author's investigations seemed to show that spores resisted decomposing influences more effectually than wood-tissue, which seemed to account for the fact that where they occur, they stand out in bold relief against the other material composing the coal. Below the central bed of the shallow seam came the main division. In it the author detected a large accumulation of spores, but hydrocarbon formed a fair proportion of the mass. The author referred to other seams of coal from various parts of England, and pointed out the structure of each bed composing them. The conclusions on the evidence elicited from his investigations were (1) that some coals were practically made up of spores, others were not, these variations often occurring in the beds of the same seam; (2) the so-called bituminous coals were largely made up of the substance which the author termed hydrocarbon, to which the wood-tissue undoubtedly contributed.

An appendix to the paper, written by Prof. Harker, Professor of Botany and Geology at the Royal Agricultural College, Cirencester, dealt with the determination of the spores seen in Mr. Wethered's microscopic sections. Taking the macrospores, the resemblance to those of *Isoëtes* could not fail to strike the botanist. He had procured some herbarium specimens of *Isoëtes lacustris* in fruit, and compared the spores with those from the coal. When gently crushed, the identity of the appearance presented by those forms from the coal was very striking. The triradiate markings of the latter were almost exactly like the flattened three radiating lines which mark the upper hemisphere of the macrospores of *Isoëtes lacustris*. The writer therefore concluded that the forms in the coal were from a group of plants having affinities with the modern genus *Isoëtes*, and from this Isoëtoid character he suggests the generic title of *Isoëtoides*, pending further investigation.

2. "On Strain in connexion with Crystallization and the Development of Perlitic Structure." By Frank Rutley, Esq., F.G.S.

In a paper read before the Society and published in the "Quarterly Journal" (vol. xxxvii. p. 391) some observations were made upon microscopic areas of depolarization in an obsidian tuff from Montana, U.S. The paper now read related to a further examination of similar phenomena in an obsidian from Java. The glass adjacent to the numerous crystals occurring in this rock exhibits depolarization, as in the case of the Montana tuff. In some instances a perlitic structure surrounds the crystals, and the depolarization then ends abruptly at the fissure. One instance is described in which such a fissure only partially encircles a crystal, and the depolarization is then seen to end abruptly at the fissure and also to fade away gradually in those directions which are not thus limited. The conclusion was, that the depolarization is the result of strain, and that the perlitic

fission is due to the same cause. It was also suggested that the development of the crystals may in some cases account for this strain, while in other instances similar evidence of strain is seen in perlitic areas where no crystal is visible. Other details concerning perlitic and spherulitic structure were also discussed.

3. "Sketches of South-African Geology. No. 1. A Sketch of the High-level Coal-field of South Africa." By W. H. Penning, Esq., F.G.S.

In this paper the author gave a sketch of the High-level Coal-field of the Transvaal and the neighbouring region. This Coal-field was described as extending 400 miles from north to south, with an average breadth of 140 miles, so that its area is about 56,000 square miles. The tract consists of an elevated plateau forming the "High Veldts" of the Transvaal and the plains of the Orange Free State. It slopes away to the north-west, and is scarped to the south and east by the heights known as the Stormberg and Drakensberg mountains; nearly all the principal rivers of South Africa take their rise in this tract of land. The coal-bearing beds forming the plateau rest unconformably in the north upon deposits probably of Upper Palæozoic age, described as the Megaliesberg beds. In the south-west the Lower Karoo beds underlie the coal-beds, also unconformably. The beds of the high grounds consist above of sandstones, called the "High Veldt beds" by the author, and below of shales, for which the name of "Kimberley beds" is proposed, after the chief town of Griqualand West, in which district they form nearly the whole surface. These two series are conformable, and generally lie horizontally. In the shales coal occurs only in minute patches; the seams of coal are interstratified with the sandstones, into which the shales pass up gradually, and which sometimes include thick-bedded grits and conglomerates. Both shales and sandstones contain interstratifications and numerous dykes of trap, which have rarely produced much alteration in the sedimentary beds, from which the author concludes that the eruptions were subaqueous and contemporaneous or nearly so. Owing to the persistent horizontality of the rocks, the mountains and valleys are merely carved out of the plateau, so that the thickness of the deposits is easily measured. The author gave 2300 feet as the minimum thickness of each series. By a comparative section it was shown that the coal-bearing sandstones ("High Veldt beds") are the "Upper Karoo" of Stow, and the "Stormberg beds" of Dunn. The "Kimberley beds" are the Upper Karoo beds of Dunn.

In the latter part of his paper the author noticed briefly the different localities where coal has been found, namely, Newcastle. Lange's Nek, the Lebelelasberg mountains, near New Scotland, several places on the High Veldt, Wemburg, Brandfoote, Cornet Spruit, Burgersdorf, and Indwe, twenty miles east of Dordrecht. The most northerly point of the Transvaal where coal has been found is on the Letsebo river. West of the Drakensberg coal occurs at a lower level.

---

## CORRESPONDENCE.

## ELEVATION AND SUBSIDENCE.

SIR,—I have just seen the December Number of the GEOLOGICAL MAGAZINE containing a short article called "The Pleistocene Geology of the Firth of Tay and the Elevation and Subsidence Question." The writer remarks on the depression of the land to a depth of at least 500 feet during the earlier part of the Glacial Period, and adds that, as the marine stratified deposits rest "upon the ground moraine of the ice-sheet," whatever this may mean, it is conclusively shown that when the sea sands were deposited, "the ice was very greatly reduced, had retired from the coast-line, and possibly disappeared altogether." He further thinks it evident that this submergence was relatively short, and that a greater, which deposited an extensive raised plain, occurred "when the glaciers were in their final retreat," and deduces from these facts that "at any rate the Glacial and Post-Glacial history of Scotland gives no countenance to the theory," *i.e.* that additions of weight produce subsidence. Original observations of fact are valuable, and any inferences fairly deducible from such have a right to be tacked on, if the observer pleases; but in this case there do not appear to be any new facts quoted, and certainly none that justify any approximation to the sweeping assertion just cited. The continued depression of the land by the accumulation of ice would naturally lead to encroachments of the sea, which would melt the ice and deposit on the top of the "ground moraine," if any existed, stratified sand, or mud. The Firth of Tay would, in fact, become a fiord. Why this replacement of ice by sea-water on an area should lead to the belief that the thickness of ice on adjacent and more elevated areas had diminished, I cannot think. Ice even in Greenland seldom reaches the sea-shore, except at the heads of fiords, while an accumulating ice-cap, such as the Vatna-jökul, which is 3000 miles in extent, might be exerting considerable influence in the direction of depression without coming near the sea. Not long since an equally valuable criticism was advanced, namely, that because elevation had commenced before the disappearance of the ice-sheet, it could not have been caused by it, as if an ice-cap of a thousand feet thickness or so would not get very sensibly lighter before it disappeared.

J. STARKIE GARDNER.

ON *PALÆOCYCLUS FLETCHERI*, EDW. H.

SIR,—In the Quarterly Journ. Geol. Soc. for February, 1884, Prof. Duncan demurs as to the identity of *Palæocyclus Fletcheri* with *Pholidophyllum tubulatum*, Schlotheim (= *Phol.* (*Cyathophyllum?*) *Lovéni*, E. H.), chiefly on the ground that Prof. Duncan has never seen in English specimens a trace of the peculiar scaly coating, which covers the epitheca of *Pholidophyllum*. I have, amongst other specimens of this coral from Dudley, sent through the kindness of Mr. John Gray, of Hagley, two of the low depressed variety



commonly called *Palæocyclus Fletcheri*. One of them so exactly resembles the figures 3, 3a, on plate 57 of M. Edwards' British Fossil Corals, that it might well have been the original of that figure. Now on this, as well as on the other specimen mentioned, *the epithecal scales are as plainly visible as on the Gotland specimens*. I have not the least doubt that on closer examination more English specimens with scales *in situ* will turn up. In consequence of the fact now adduced, the assertions of Prof. Duncan cannot any longer be upheld. But even if the epithecal scales had not been found, there are such fundamental discrepancies in the intimate structure of *Cyathophyllum* and *Pholidophyllum*, as shown in the numerous figures of von Koch and even in my memoir, that it is inconceivable how anybody still can persist in placing *Pal. Fletcheri* or *Phol. Lovéni* amongst the *Cyathophylla*.

I avail myself of this opportunity to correct some errors which have crept into Prof. Duncan's quotations of my paper, on pp. 176 and 177 of the Quart. Journ. Geol. Soc., and for which I am not responsible. In the translation of the generic description of *Pholidophyllum*, Prof. Duncan has the following passage: "Loculi filled with 'like-formed' stereoplasma, numerous in the midst of the coral, most frequently in regular equidistant tabulæ." What this means I for one am unable to understand. According to the Swedish original there ought to stand: "Loculi filled with homogeneous stereoplasma, in the midst of the coral are numerous tabulæ, in most specimens regularly distantiated." This description covers the English specimens, as well as the Swedish, North American and Russian ones, which I have examined. Further, Prof. Duncan has "*Triplasma*" instead of *Tryplasma*, "*Scarithodes*" (!) for *Acanthodes*, "*Haliophyllum*" for *Heliophyllum*, "*Acanthocœnium*" for *Acanthoconium*, *Palæocyclus*, "*porcatus*" for *P. præacutus*, etc.

As to the genus *Palæocyclus* of Milne-Edwards, it contains at least three generic types, viz.:

1. *Palæocyclus sensu*, pr. Type *P. porpita*, L., which probably only occurs in Gotland.

2. *Pholidophyllum*—*Pal. Fletcheri*.

3. Genus novum. *Pal. rugosus*, altogether differing from the former and pertaining to a special, as yet not defined genus.

The retaining of *Palæocyclus* as an independent genus with *P. porpita* as a type, does not imply that it must of necessity be kept amongst the Fungidæ. Already in 1865, I expressed my opinion that it was to be regarded as a Rugose, in my first paper on the operculated corals. The translation of this point in the GEOLOGICAL MAGAZINE, Vol. III. p. 144, not being exact, I give anew from the original. "Its (= *Pal. porpita*) compact and solid structure, not perforated nor spongy as in the *Fungidæ*, its septa, which alternate with the exterior folds (costæ), give it a place in the Zoantharia rugosa." G. LINDSTRÖM.

## SPACE BETWEEN GRAINS OF SAND.

SIR,—In his article on Miniature Domes in Sand, Mr. Mellard Reade compares (p. 22) the interstitial air-space between grains of sand with that between small round shot of uniform size. The former he finds by an experiment to be about five-twelfths or  $\cdot 4167$  of the whole volume, the sand therefore occupying seven-twelfths or  $\cdot 5833$ . The proportion of space occupied by the round shot he supposes to be the ratio of a sphere to its circumscribing cube, that is,  $\cdot 5236$ . This assumes that the shot arrange themselves in "square order," that is, adjacent shot have their centres at the corners of a cube and each shot touches six others; but in reality they would be more closely packed, falling into what may be called "pyramidal order," in which the centres of adjacent shot are at the corners of a regular triangular pyramid and each sphere is in contact with twelve others. The shot will then occupy  $\cdot 7405$  of the whole volume, leaving only  $\cdot 2595$  for air. Sand is therefore much less compact than small round shot; this is probably due partly to the inequality in the sizes of grains of sand, but mainly to their irregular shape. Perhaps the degree of compactness of any particular kind of sand, determined as in Mr. Reade's experiment, might serve as an index of how far the grains have been rounded by attrition.

A. HARKER.

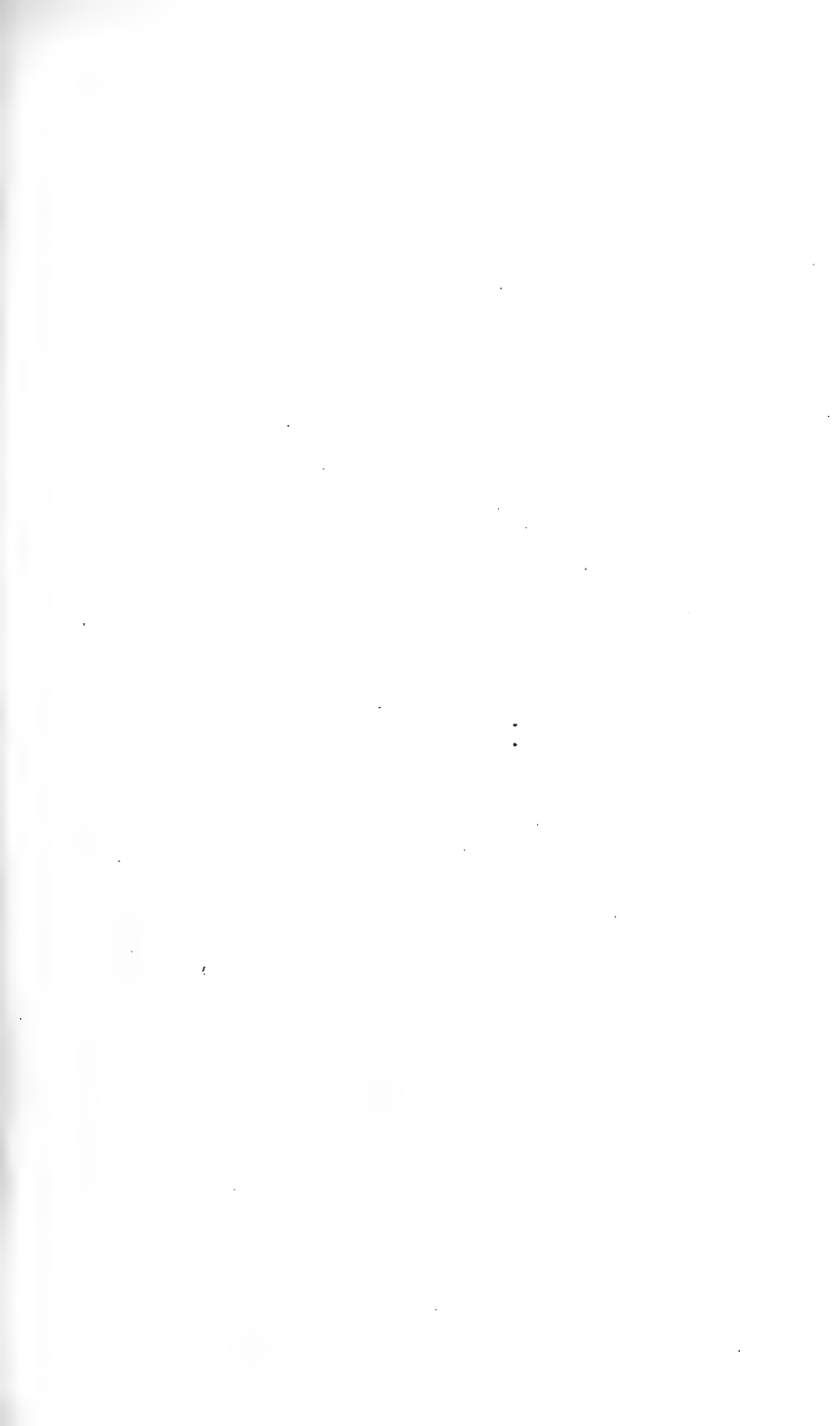
ST. JOHN'S COLLEGE, CAMBRIDGE.

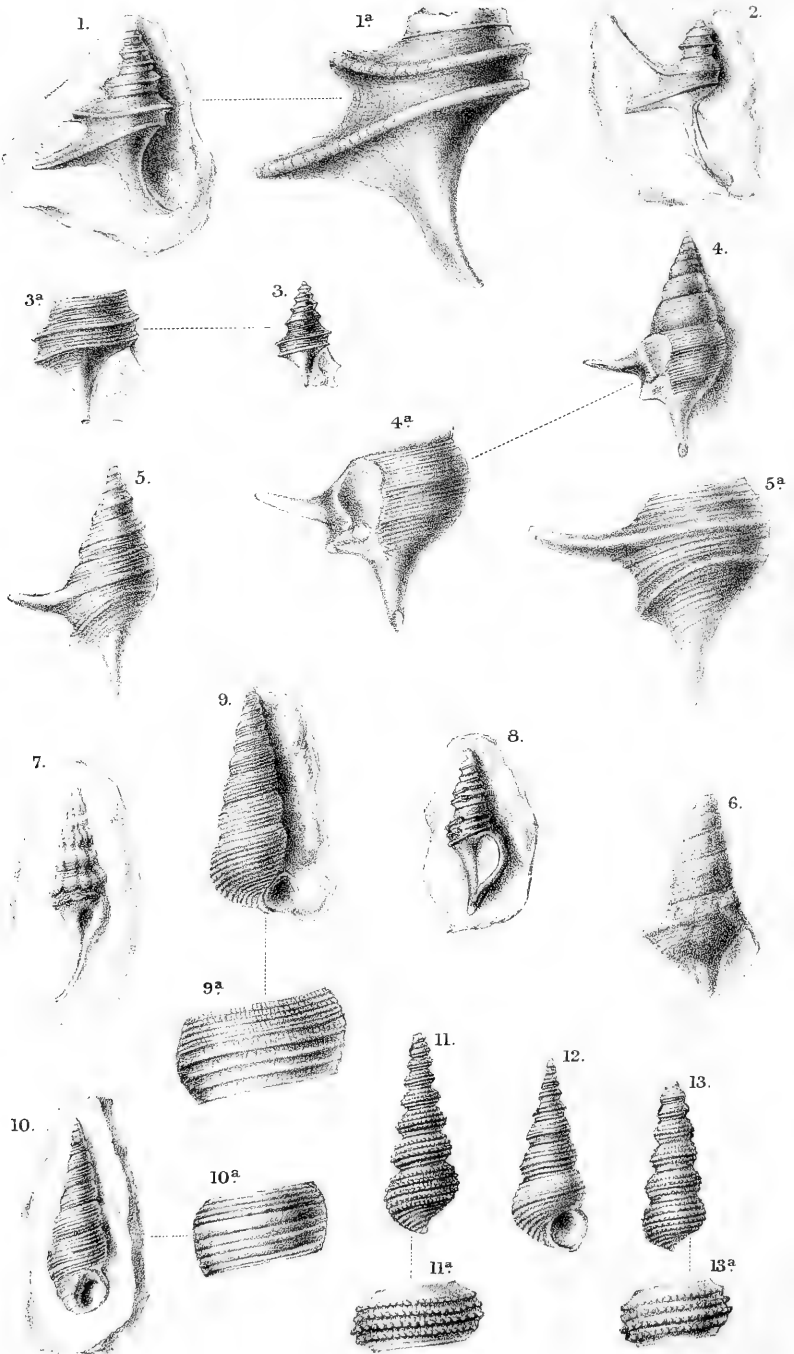
## THE PERMIAN-TRIAS QUESTION.

SIR,—Will you oblige me with space for one or two brief remarks by way of a rider to M. Marcou's paper on the "Permian-Trias Question," in the March Number of the *GEOL. MAG.*? The letter of mine in the January Number, to which M. Marcou refers, was intended merely to point out that although the name "Permian" might possibly continue to be of value as a *local* name for the rocks of that age in the Russian area, it was not only undesirable, but even misleading, as a term for Europe in general. Of course, if, by general consent, the great cupriferous series of sandstones and marls, which overlie the true Dyassic strata in European Russia, be assigned to the Trias, the name "Permian" ceases to have any accurate meaning even for the Russian series. The only question to my mind is as to the true Triassic age of those sandstones and marls. I suppose that Ludwig, d'Eichwald, and others to whom M. Marcou refers, have seen their way to the elimination of the difficulty presented by the Palæozoic facies of the few plant-remains that are found in the cupriferous sandstones and marls (= Murchison's 'Upper Permian'); but until this difficulty is removed, it seems safer to regard these strata (which have no equivalents in Britain or Central Europe) as a *transition-series* between the Dyas and Trias. This idea, to say the least, ought not to be overlooked in any future mapping of the Russian area.

A. IRVING.

WELLINGTON COLLEGE, *March 9th*, 1884.





A.S. Foord del et lith.

Mintern Bro's. imp.

Oxfordian & Lower Oolite Gasteropoda.  
(Yorkshire.)

THE  
GEOLOGICAL MAGAZINE.

NEW SERIES. DECADE III. VOL. I.

No. V.—MAY, 1884.

ORIGINAL ARTICLES.

I.—CONTRIBUTIONS TO THE PALÆONTOLOGY OF THE YORKSHIRE  
OOLITES.

By WILFRID H. HUDLESTON, M.A., F.G.S.

(Continued from Decade III. Vol. I. p. 154.)

(PLATE VI. FIGS. 11, 11a; PLATE VII.)

40.—*ALARIA TRIFIDA*,<sup>1</sup> Phillips, 1829. Plate VI. Figs. 11, 11a;  
Plate VII. Figs. 1, 1a, 2, 3, 3a.

1829 and 1835. *Rostellaria trifida*, Bean MS. Phillips, G. Y. p. 109, pl. v. fig. 14.

1842. *Rostellaria trifida*, Phil. Deslongchamps, Mem. Soc. Linn. Norm. vii.  
p. 171, pl. 9, figs. 27, 28, 29, non figs. 30, 31.

1849. *Pterocera trifida*, D'Orb. Prod. i. p. 357.

1850. *Alaria trifida*, Phil. Morris and Lycett, Great Ool. Moll. p. 21, pl. 3,  
figs. 11, etc.

1854. *Alaria trifida*, Phil. Morr. Cat. p. 235.

— *Alaria trifida*, Phil. Piette, Cont. de la Pal. Franç. 1<sup>re</sup> série, p. 149, pl. 37,  
figs. 1—5.

Compare also

1836. *Fusus curvicauda*, Rœm. Ool. Geb. p. 140, pl. 11, fig. 6.

1837. *Chenopus Philippi*, Dunker and Koch, Beitr. p. 34, pl. 2, fig. 13.

1844. *Rostellaria bicarinata*, Münst. Goldfuss, iii. p. 15, pl. 170, fig. 1.

18— *Alaria cochleata*, Quens. Piette, *op. cit.* p. 110, pl. 22, figs. 1—6.

*Bibliography, etc.*—This widely-spread, and, on the whole, well-marked species, has been in so many cases, as it appears to me, confounded with *Alaria bispinosa*, that it would be a task of no small difficulty to trace out the mistakes that have arisen in consequence. The imperfect figures of Phillips have, no doubt, been the principal cause of thus confounding the two species. Deslongchamps queried the identification, but yet was inclined to adopt it. Morris and Lycett seem to have had no doubt on the subject. "Having had the advantage of examining a large number of specimens, comprising every variety both in form and stage of growth, we feel no hesitation in uniting the two species here indicated." It is extremely probable that the Great Oolite specimens of *Alaria trifida* present varietal differences from the Oxfordian types, and they may also in some cases have assumed forms having only one lateral digitation;

<sup>1</sup> Owing to an error on p. 146 of the April Number, *Alaria trifida* is represented as a variety of *Alaria bispinosa*. According to my views the species are very distinct, although they constitute a group having certain features in common.

but higher up in the Jurassic rocks they seem to be very fairly separable for such a genus as *Alaria*, which is so prone to effect changes in its shell. Such was doubtless the opinion of Morris, who quotes *Al. bispinosa* from the Lower Calc. Grit and Kel. Rock, whilst *Al. trifida* is quoted as a distinct species from the Oxford Clay and Kel. Rock of Yorkshire, the Great Oolite form being referred to a variety.

As far as the beds of Oxfordian age testify, and it is in these alone in Yorkshire that either species occurs, Phillips and Morris were justified in separating them, and it remains for us to decide how far the specimens available bear out their views. Until this question is settled it would be useless attempting to follow the mazes of the Continental synonymy. Certain it is that forms with much resemblance to the well-known Oxfordian *Al. trifida* occur both in the Inferior Oolite of Normandy and of the south of England. When a rational system of nomenclature prevails, such forms will receive an appropriate distinction under the chief group. At present, we must be satisfied to hunt up and down the pages and plates of such a work as Piette's for some haphazard title to bestow upon our fossils.

*Description.*—Specimen from the Kelloway Rock (zone 5), Scarborough.<sup>1</sup> Leckenby Collection. Plate VI. Figs. 11, 11a.

The body-whorl, including the greater part of the tail, and the penultimate, is all that remains, but these are in an excellent state of preservation. In the penultimate the keel is almost exactly in the middle of the whorl, very large and not at all sharp; anterior portion of whorl but slightly constricted, and rising again to a slight basal belt before reaching the suture, which is rather wide. The system of spiral lines is exceedingly fine, and scarcely traceable in the body-whorl below the anterior keel. The body-whorl develops two large, thick, but not sharp keels, which are nearly of equal strength. The posterior keel, owing to the shape of the whorl, is rather the most prominent; but the anterior keel is the stoutest, and carries the most important digitation. In this specimen the upper digitation is entirely broken away, faint spiral striæ may be noted on the lower keel, which is also very slightly notched, corresponding to a system of fine axial striæ, which ornament the wing and base of the body-whorl. The tail, or canal-sheath, is connected with the lower finger by an expanse of wing, and itself commences to curve almost immediately. Termination imperfect.

*Specimen* from the same horizon, locality and collection. Plate VII. Figs. 1, 1a.

Length .....	20 millimètres.
Width of last whorl to length of shell .....	45 : 100.
Approximate spiral angle .....	34°.

Although there is far more of this specimen preserved than of the last, yet the condition is scarcely so good. The body-whorl with its two lateral digitations and tail curving at once from the spire give us an excellent insight into the characteristics of *Alaria trifida*, as

<sup>1</sup> On the very same piece of stone occurs the specimen of *Al. bispinosa*, Plate VI. Figure 9: hence a good opportunity for comparison.

it appears in a spathic condition in the hard calciferous grit of the Scarborough Kelloway Rock. All three processes are shortened by fracture. The two keels on the body-whorl are stout, but not sharp: as in the previous specimen, the upper one is slightly the more salient, but the lower one is the stouter, and evidently carries the strongest digitation. Both possess a slight appearance of notching, which, in the hands of foreign artists, assumes considerable proportions. The extremely fine spiral lines which pass over the whole shell, including the keels, are scarcely visible; still less the fine axial lines on the wing and base of the body-whorl.

This specimen may be regarded as representing Piette's rendering of *A. cochleata*, Quens., said to be a Callovian form.

*Specimen* from the Oxford Clay (zone 6), Scarborough. Leckenby Collection. Plate VII. Fig. 2.

This specimen seems to throw light on Phillips's remarkable figure. It is much compressed, as is usually the case with fossils from the Oxford Clay of Scarborough. The fine spiral lines, and the fretting in the keels is noticeable; whence we may infer that it is not a mere internal mould, although all the shell substance is gone. The specimen serves to show us the number and nature of the digitations to a degree seldom seen in the Yorkshire beds. None of the terminations are quite complete; the middle one, which is the stoutest, being the most deficient. The upper finger commences to curve at once on quitting the spire, whilst the middle one continues nearly in line with its keel, though with a slight anterior inclination, so that the intercarinal space widens towards the margin of the whorl. The tail begins to curve at once; it would seem to be about as long as the entire spire.

*Specimen* from the red-stained Oolite of the Kelloway Rock (zone 5), Scarborough. Leckenby Collection. Plate VII. Figs. 3, and 3a.

Six whorls are visible, and about three more may have existed: length, excluding canal, 14 mm. The shell substance is in a corroded condition, and the indications, as regards ornament, not thoroughly reliable. The penult and antepenult show the broad median keel, and the nearly straight outline of the anterior half of the whorls: the spiral lines are strong. The last whorl is strongly and equally bicarinate. The aperture is large, and angular in the direction of the outer lip, which is produced outwards with a slight curve towards a point where it forms an obtuse angle, and then runs nearly straight towards a second angle, beyond which there are no indications.

From the above I am inclined to regard this specimen as representing the front view of at least a variety of *Al. trifida*. The only difference, other than those arising from position and the absence of the wing-processes, consists in the coarser nature of the spiral lines. This may be a result of mineral condition.

It will be observed that most of the specimens of *Alaria* figured on the two plates are back views. The collections of Yorkshire fossils seem deficient in specimens yielding a front view; and when we do get one, the wing is nearly always imperfect.

*Relations and Distribution of Alaria trifida.*—But little more need be said on this subject, which would require very extensive treatment in order to do it thoroughly. It may be useful to recapitulate the chief points in which the Yorkshire specimens differ from those of *Al. bispinosa*, selecting in both cases our examples from the “chert” bed of Kelloway Rock, as being identical in *status*.

As regards the whorls of the spire, the keel is less sharp than in *Al. bispinosa*, and the lower half less constricted: the spiral lines are also finer throughout. On comparing the body-whorls, the difference is immense: in *Al. trifida* the lower keel is largely developed, supporting a stout digitation which is connected by a wide expanse of wing with the tail, which itself commences to curve at once. Unfortunately there are no available specimens of *Al. bispinosa* with a complete tail from the Yorkshire beds. It would appear to proceed nearly straight for a considerable distance, and then probably terminates with a sharp anterior curve, as is the case with some specimens from the Oxford Clay of the South of England which I refer to *Al. bispinosa*. But the chief difference consists in the absence of a second, or lower lateral finger in *Al. bispinosa*. Granted that there are cases where such a process might be broken off, it is at least singular that where certain conditions are noticeable, amongst which is a marked attenuation of the lower keel, no lower finger can be found. Practically, whether wide-angled or narrow-angled, specimens of *Al. bispinosa* always have a feebly-developed lower keel, which has every appearance of being about to terminate at the margin. This is most certainly the case in the very vigorous specimen (Plate VI. Fig. 10), where the upper keel carries one immense curved finger, and the lower keel reaches the margin almost aborted. To sum up, *Alaria bispinosa* is a Pasha of Two Tails, and *Alaria trifida* is a Pasha of Three Tails.

*Alaria trifida* is rare in the Kelloway Rock, but rather more abundant in the Oxford Clay of Scarborough Castle Hill.

41.—*ALARIA MYURUS* (?), Deslongchamps, 1842. Narrow variety.  
Plate VII. Fig. 6.

1842. *Rostellaria myurus*, Deslongchamps. Mem. Soc. Linn. Norm. vol. vii. p. 176, pl. ix. figs. 23, 24, 25.

18—. *Alaria myurus*, Deslong. Fiette, *op. cit.* p. 30, pl. 2, figs. 8–11.

Compare also—

1850. *Alaria levigata*, Morr. and Lyc. Grt. Ool. Moll. p. 17, pl. 3, fig. 3.

*Bibliography, etc.*—Not admitted as British by Morris in his Catalogue. According to Deslongchamps, its occurrence is limited, in Normandy, to the Inferior Oolite, where it is rare. As to Morris and Lycett's species, *Al. levigata*, from the Great Oolite, the absence of striae, on which they relied as a distinguishing feature, is simply due to the nature of the matrix, and is of no value whatever.<sup>1</sup> If, as they tell us, this is the only difference, then *Al. myurus*, Desl., is a fossil of the Great Oolite, and *Al. levigata* has no justification.

<sup>1</sup> The Minchinhampton fossils, though very beautiful and often entirely preserved, are not exactly favourable to the study of ornamentation of the finer kind.



Mention has already been made of the identification by Phillips, in his third edition, of his figure (G. Y. pl. vi. fig. 13), with Deslongchamps' species. This I conceive to be very unlikely, but it does not materially affect the case.

*Description.*—Specimen from the Millepore Rock (zone 2), Cloughton (Sycarham). Leckenby Collection.

The spire, which is only indifferently preserved, has an angle of about  $30^{\circ}$ ; length of the restored specimen without the tail about 34mm. The whorls towards the apex are moderately convex (the suture not being deep), and marked by very faint spiral lines, which are rather stronger in the anterior whorls: no longitudinal costæ are visible, though there are some obscure markings, the nature of which is not easy to determine. In the penult a very faint keel is developed. The body-whorl is not very tumid, but carries a strong median keel, with a large spine opposite the wing. The nature of the wing is by no means clear. There is a considerable callus on the columella.

*Relations and Distribution.*—The comparatively unornamented spire, the slight keel of the penult, and the strong keel of the body-whorl, seem to connect this form with Deslongchamps' species; the amount of callus on the columella also bears a resemblance to Deslongchamps' figure. There is one other specimen from the Cornbrash, also in the Leckenby Collection, which may perhaps be referred here. None others are known to me from the Yorkshire beds.

42.—*ALARIA MYURUS*, var. *TERES*. Plate VII. Figs. 4, 4a.

*Description.*—Specimen from the Cornbrash (zone 4), Scarborough. Leckenby Collection. Plate VII. Figs. 4, 4a.

Length.....	23 millimètres.
Width of last whorl to length of shell.....	50: 100.
Approximate spiral angle .....	$42^{\circ}$ .

Shell fusiform, scarcely turritid. Seven whorls are visible, and the complete spire would probably consist of about ten. All the whorls are extremely tumid: those towards the apex are, in this specimen, devoid of ornament; but this may be an accidental circumstance due to usage. The three lowest whorls are spirally striated: the furrows are narrow and shallow: there are about 20 on the penultimate, the intervening space being about three times the width of each groove, and presenting a flat, strap-like appearance. One of these straps, towards the middle of the whorl, is rather wider than the rest, but scarcely more prominent. This represents the median keel. Precisely the same kind of ornament is continued throughout the body-whorl, which develops two keels: these are of slight prominence, being in fact like two straps somewhat wider than the rest. The digitations are broken; but there can be little doubt that the lower keel was continued, and that the specimen was trifid.

*Relations and Distribution.*—The smoothness and convexity of this form is remarkable. The features of *Al. myurus* seem to be exaggerated until the identity is lost, and this almost becomes a new species. It

differs from *Alaria myurus* in the shorter and more tumid spire, and above all in the very slight prominence of the keels. It is, in fact, very near to the *Al. lævigata*, M. and L., of Hébert and Deslongchamps (*op. cit.* pl. vi. fig. 10), which occurs in the Callovian of Montreuil Bellay, and several of the numerous figures given by Piette of *Al. lævigata*, M. and L., bear considerable resemblance. Hence the form is not uncommon, though none of these represent the *Al. lævigata* of Morris and Lycett in anything but the impression conveyed by the name.

From the Yorkshire beds no other specimen is known to me.

43.—*ALARIA*, sp. Plate VII. Figs. 5, 5a.

*Description*.—Specimen from the Dogger (zone 1), Peak (Blue Wyke). Leckenby Collection.

There has been a slight compression of the body-whorl, which interferes with correct measurements, otherwise the proportions and size are not dissimilar to those of *Alaria teres*.

Shell fusiform, turrated. Five whorls are visible, and there were probably three more to complete the spire. The highest visible whorls are tumid, but apparently without keel, and are separated by a wide suture. The anterior whorls become, each more angular than the preceding one, with a proportionate development of keel: the posterior half slopes outwards, the anterior half is nearly perpendicular. A rather coarse and unequal system of raised spiral lines ornaments the shell, including the body-whorl, which has an upper broad keel supporting a thick curved process or digitation, and a lower ill-defined keel, which may or may not have terminated in like manner.

This fossil is in the matrix (though not drawn so), and there are indications that, in addition to the compression of the body-whorl, it has received some further mutilation; hence its affinities must remain problematical, since it is not possible to say for certain whether it is bifid (monodactyl) or trifid (didactyl). In the latter case it might have a remote connexion with such a form as *Alaria teres*. No other specimen so distinct as this has come into my hands, but two specimens of a small thick stunted *Alaria* (?) were lately obtained by Mr. Herries, one from the Scarborough Limestone of Cloughton, the other from the Millepore Rock at Gristhorpe. Such fossils may indeed represent portions of the spire of *Chenopus* (*Aporrhais*) or *Pterocera*.

44.—*ALARIA ARENOSA*, sp.n. Plate VII. Fig. 7.

*Description*.—Specimen from the Dogger Sands (lower part of zone 1), Blue Wyke. Leckenby Collection.

Length .....	19 millimètres.
Width of body-whorl to length of shell .....	31 : 100.
Approximate spiral angle .....	25°.

Shell elongate, strongly turrated. The spire increases with great regularity, and consists of about ten whorls, of which seven are visible. Each whorl has a median carina, which is strongly tuber-

culated. In the upper whorls this tuberculation is extended axially so as almost to reach from suture to suture; but in the last two whorls it is confined to the region of the keels, and thus becomes a real tuberculation. The whole of the spire is marked with rather strong spiral lines. The body-whorl carries two keels: the upper one is the strongest, and has tubercles very similar to those on the keel of the penult: the tuberculations of the lower keel are less strong. The nature of the wing is uncertain, there being no outer lip preserved (N.B. The thick appearance is due to a quantity of matrix being left for purposes of preservation): the columella is thin and straight for some distance; canal long and moderately curved.

*Relations and Distribution.*—This species possesses some interest as the earliest example of *Alaria* at present known from the Yorkshire Jura. Some of the peculiarities of the figured specimen are partly due to the matrix and mode of development, which tend somewhat to narrow the spire. Bearing this in mind, I observe that, as regards the tuberculations on the lower whorls, it has some resemblance to the figures of *Rostellaria subpunctata*, Müntz. (Goldf. vol. iii. p. 14, pl. 169, fig. 7). Piette (*op. cit.* p. 23) alludes to a variety figured by Terquem from the *opalinus* zone.

A comparison with *Al. Phillipsii* shows closer affinities. In both species the ornaments of the apical whorls are of a somewhat similar character, but whilst, in *Al. Phillipsii*, the longitudinal costulæ are chiefly developed on the keels and anterior thereto, in this species they have rather a tendency towards the posterior half. But the chief difference lies in the tuberculated keels of the body-whorl, in the coarseness of the spiral lines, and perhaps in the more attenuated form of the shell.

There are two specimens in the Leckenby Collection, and the matrix shows at once that they belong to the Dogger Sands, though such is not always the case with specimens so marked in that collection.

45.—*ALARIA* (?) sp. Pl. VII. Fig. 8.

18—. "*Fusus*, Scarborough," Bean MS.

*Description.*—Specimen from the Kelloway Rock (zone 5), Scarborough. Bean Collection, British Museum.

The remains of three whorls may be traced, the probable spiral angle being 28°. All three are strongly bicarinate. Owing to the polished condition of the fossil, an unnatural smoothness results, due very probably to the action of blown sand on the spathic shell during weathering. The matrix is the red-stained Oolite-grit of the Kelloway Rock. It is not unlikely that the keels were crenulate, whilst distinct spiral lines are traceable on some of the whorls. An axial row of spinous tuberculations is a characteristic feature, and considerations of symmetry would suggest that a similar row must exist on the opposite side: these tubercles spring from the keels, the lower one in each case being the strongest. A portion of the shell has, I think, been broken off, so that we do not possess the complete spire, much of the body-whorl being in all probability missing.

It has been suggested that this shell is a *Spinigera*. Since we cannot see whether there is an opposite row of tubercles, and since a portion of the body-whorl is missing, we may fairly be excused from deciding positively either as to the genus or the species. I know of no *Spinigera* with two keels on the whorls of the spire: hence if it is a *Spinigera*, it should be called *Sp. biarmata*.

Genus *TURRITELLA*, Lamarck, 1799.

There seems to have been, on the part of some authors, an indisposition to extend the genus *Turritella* so far back as the period of the Oolitic rocks, and consequently, since some of Phillips's Jurassic *Turritellæ* were *Cerithiæ*, he apparently came to the conclusion, in the edition of 1875, that they all were. Consequently, in the list of *Turritellæ* at page 258, none are quoted either from the Lias or the Oolites. Yet Tate and Blake quote three species of *Turritella* from the Yorkshire Lias, all of them forms recognized as Liassic by foreign authors. I think it must be conceded that a small group of shells exists somewhat sparingly in the Dogger, which are also best referred to *Turritella*. They are elongate, many-whorled, spirally striated, and without longitudinal costæ: the whorls are separated by a wide suture, and the aperture, where visible, is rounded and entire. I do not know that any shells fairly referable to *Turritella* occur in the Yorkshire Oolites higher than the Millepore Rock, where poor specimens, assigned to *T. quadrivittata*, have been found; but we note *Turritella* here and there on several well-known horizons, such as the Callovian of Montreuil Bellay, where the genus is represented by more than one form. Whether these several forms should be classified under the *Turritella* of Lamarck, may be a fair question. If not, it would be necessary to constitute a new genus to receive them.

46.—*TURRITELLA OPALINA*, Quenstedt, 1858, var. *CANINA*.

Plate VII. Figs. 9, 9a, 10, 10a.

1832. *Turritella elongata*, Zieten. Pl. 32, figs. 5, 6.

1849. *Cerithium elongatum*, D'Orb. Prod. i. p. 250 (Toarcien).

1858. *Turritella opalina*, Quenstedt. Jura, p. 326, pl. 44, fig. 15.

*Bibliography, etc.*—Zieten seems to have been the first to point out the occurrence of a fine species of *Turritella* in the debatable ground between the Lias and the Oolites, but he fixed upon a name already appropriated by Sowerby for a Tertiary fossil not so very dissimilar. Hence Quenstedt's name has the preference, and there is this further advantage, inasmuch as it describes the horizon where his fossil occurs, viz. in the upper part of the Brown Jura, *Alpha*, which is on a slightly lower horizon than our Dogger: more about the horizon of the Dogger Sands in fact, though we cannot claim its companion, *Trigonia navis*, as a Yorkshire fossil.

*Description. Section A.*—Specimen from the Dogger (zone 1), Peak (Blue Wyke). Bean Collection, British Museum. Figs. 9, 9a.

Length restored.....	about 40 millimètres.
Width .....	10½
Height of whorl to width .....	50 : 100. "
Spiral angle .....	23°.

Shell elongated, turrated. The spire probably consisted of about 14 whorls; eight now remain; of these the anterior ones are in a good state of preservation. They are separated by a wide and tolerably deep suture; the upper part of each whorl is constricted, the middle nearly flat, and the lower very sharply constricted, the effect being to produce a tumid whorl, flattened towards the middle, but curving towards either suture, the posterior curved area being longer than the anterior one.

The whole shell is ornamented with prominent spiral bands, which, on the penult, are distributed as follows:—(1) In the upper part, close to the suture, a narrow and not very conspicuous band, followed by an immediate increase in the convexity; then a broad conspicuous band, a wide sulcus which includes a faint spiral line, another spiral band, and then a second sulcus which contains a spiral line somewhat stronger than the preceding one. (2) The middle part is composed of three nearly equal strap-like bands, the upper being slightly the strongest and representing the most angular portion of the otherwise globose whorl; these seem to have undergone a certain amount of polishing. (3) The anterior region, which is the shortest and most sharply constricted, contains two bands separated by a sulcus, in the bottom of which is a faint spiral line. There are no traces of a longitudinal system of ornament, beyond a general appearance of fine vertical striæ, which have the effect of producing a slight ornamentation of the spiral band. This may extend to the sulci, but it is not certain that it does so as represented in Fig. 8.

The base of the shell is ornamented by a similar system of spiral bands. The columella is short and straight, and the aperture appears to have been entire and rounded; but a small portion of the anterior margin is wanting, and the outer lip is partly involved in matrix.

*Another Specimen. Section B.*—Same horizon and locality. Leckenby Collection. Figs. 10, 10a.

Length restored .....	about	30 millimètres.
Height of whorl to width .....		60 : 100.
Spiral angle towards the apex about .....		20°.

Contains more of the apical whorls than the preceding; ten remain, and about 3 or 4 more would be necessary to complete the spire; the body-whorl is smashed. There is an irregularity about this fossil which may be due to compression of the lower part. The apical whorls are short, globose, and separated by a large suture, which has the effect of giving a strangulated aspect to this part of the spire; three are ornamented by numerous fine spiral lines. Presently the whorls assume an outline which is slightly more angular, and the spiral banding is more distinct. Their general character is similar to those in the preceding specimen, but with certain important differences. The bands are broader and more strap-like, and the sulci limited correspondingly.

If these peculiarities can be explained as the result of usage, then we could agree to refer both *A* and *B* to the same section of the *opalina* group. *B* (Fig. 10) has considerably more resemblance to Quenstedt's figure than has *A* (Fig. 9). But if we cannot allow

that they are the same, then this must be regarded as the better representative of *T. opalina*, and Bean's specimen will have to be quoted as *T. canina* absolutely.

*Relations and Distribution.*—The two forms classed under the head of *T. opalina*, var. *canina*, represent a group of elongate *Turritellæ* which have a slender apex, and numerous short globose apical whorls with a crowded system of spiral lines. The anterior portions of the spire present whorls slightly more angular in outline, and with a well-defined system of spiral bands, of which there are about seven without counting any finer lines which may happen to exist. There are two varieties of these elongate *Turritellæ*, allied to *T. opalina*, which occur in the Inferior Oolite of the Sherborne-Yeovil district. One of these has ornaments not dissimilar to the Dogger shells, such differences as exist being partly due to difference of matrix; but its whorls are much higher, so that an equal number of whorls produces a much longer spire. The vertical striæ are also well shown in the south country specimens. I merely mention this to show that the Inferior Oolite of England is by no means deficient in fossils of this class.

As regards the distribution of the *T. opalina* group in Yorkshire, most of the small fragments with a globose whorl and deep suture, which are sparingly found in Museums, belong here rather than to the next named species. The number of spirals shows this at once. For the same reason I would refer specimens from the Millepore Rock to a pygmy variety of this group, and not to *T. quadrivittata*, which is a rarer species.

There is a fossil, only a few millimètres long, in the York Museum marked "*Terebra melanioides*," which may represent the apical condition of Section *A*. Curiously enough, it occurs in precisely the same variety of Dogger rock.

#### 47.—TURRITELLA QUADRIVITTATA, Phillips, 1829. Plate VII.

Figs. 11, 11a, 12.

1829 and 1835. *Turritella quadrivittata*, Phillips, G. Y. p. 129, pl. xi. fig. 23.

1849. *Cerithium quadrivittatum*, D'Orb. Prod. i. p. 271. (Bajocien.)

1854. *Turritella quadrivittata*, Phil. Morr. Cat. p. 284.

„ *Cerithium quadrivittatum*, Phil. *Ib.* p. 240.

1875. *Cerithium quadrivittatum*, Phillips, G. Y. 3rd edition, p. 258, pl. xi. fig. 23.

*Bibliography, etc.*—As a matter of course, D'Orbigny placed Phillips' species under *Cerithium*. In so doing he had a double motive. Morris seems to have been in doubt, since he makes a double entry, which is rather unusual. Mr. Leckenby was not disposed to regard this fossil as a *Cerithium*, yet Phillips in his last edition quotes it as such.

*Description.*—Specimen from the Dogger (zone 1), Peak (Blue Wyke). York Museum. Fig. 11 magnified twice, Fig. 11a magnified four times.

#### TYPE SPECIMEN RE-FIGURED. Magnified twice.

Length restored .....	14 millimètres.
Width .....	4½ „
Height of whorl to width .....	60 : 100.
Spiral angle .....	28°.

The complete spire consisted of from 10 to 12 whorls: 8 are visible, though the 5 anterior ones alone preserve their ornaments. Whorls *plano-convex*, and slightly angular, sutural excavations very wide, with a faintly-marked rim in the centre, constituting the base of each whorl. These are further ornamented by 4 deeply granulated spiral bands, the granules are slightly drawn out spirally: the third row the strongest, fourth row almost smooth. In the body-whorl the raised line, previously noted in the sutures, occupies the edge of the shell, beneath which the base is rather flat and ornamented with numerous spiral lines. Indications of longitudinal striae faint.

There is nothing about the aperture to indicate that the specimen is a *Cerithium*; still the state of preservation is not favourable to accurate description.

Another specimen, Dogger Sands (lower part of zone 1), Blue Wyke. Leckenby Collection. Fig. 12, magnified twice.

Dimensions nearly the same as in the preceding, and the ornaments, where visible, identical. The sutural hollow is more filled up with matrix, and the ornaments partially obscured from a similar cause. The aperture is almost perfectly circular, although there is a slight indentation in the anterior margin—a mere irregularity, as I believe, owing to the gritty nature of the matrix.

*Relations and Distribution.*—This form represents a wide-angled variety of a group of *Turritella* with four strongly marked spirals on the whorls. If we are to regard it as distinct from the next “species” (Fig. 13), it is rare, though occurring both in the Dogger and the Dogger Sands.

#### 48.—TURRITELLA. Plate VII. Figs. 13, 13a.

*Description.*—Specimen from the Dogger (zone 1), Peak (Blue Wyke). Leckenby Collection.

Length .....	13 millimètres.
Spiral angle .....	20°.

Except in its being more slender, and perhaps with a less wide suture, there does not seem much difference between this variety and the typical *T. quadrivittata*, which it serves to connect with such a species as *T. eucycla*, H. & D. (*op. cit.* p. 47, pl. i. fig. 11), a yet more slender form occurring in the Callovian of Montreuil Bellay.

This also is rare, but Mr. Walford obtained a specimen very similar to the one now figured during a recent visit to the Dogger.

#### EXPLANATION OF PLATE VII.

- FIG. 1, 1a. *Alaria trifida*, Phillips. Kelloway Rock, Scarborough. Leckenby Collection. Back view and body-whorl enlarged.
- „ 2, *Alaria trifida*, Phillips. Oxford Clay, Scarborough. Leckenby Collection. Back view.
- „ 3, 3a. *Alaria trifida*, Phillips. Kelloway Rock, Scarborough. Leckenby Collection. Front view and whorl enlarged.
- „ 4, 4a. *Alaria myurus*, Deslongch., var. *teres*. Cornbrash, Scarborough. Leckenby Collection. Back view, and body-whorl enlarged.
- „ 5, 5a. *Alaria*, sp. Dogger, Blue Wyke. Leckenby Collection. Back view and body-whorl enlarged.

- FIG. 6. *Alaria myurus*, Deslongch. Millepore Rock, Cloughton. Leckenby Collection.  
 ,, 7. *Alaria arenosa*, sp.n. Dogger Sands, Blue Wyke. Leckenby Collection.  
 ,, 8. *Alaria* ? "*Fusus*," Bean, MS. Kelloway Rock, Scarborough. British Museum.  
 ,, 9, 9a. *Turritella opalina*, Quenst., var. *canina*. Dogger, Blue Wyke. British Museum. Front view and whorl enlarged.  
 ,, 10, 10a. *Turritella opalina*, Quenst. Same horizon and locality. Leckenby Collection. Front view and whorl enlarged.  
 ,, 11, 11a. *Turritella quadrivittata*, Phillips. TYPE SPECIMEN. Same horizon and locality. York Museum. Back view magnified twice, and whorl further enlarged.  
 ,, 12. *Turritella quadrivittata*, Phillips. Dogger Sands, Blue Wyke. Leckenby Collection. Front view, magnified twice.  
 ,, 13, 13a. *Turritella* ? sp. Dogger, Blue Wyke. Leckenby Collection. Back view, magnified twice, and whorl further enlarged.

## II.—ON FAULTING, JOINTING, AND CLEAVAGE.

By the Rev. O. FISHER, M.A., F.G.S.<sup>1</sup>

### PART I.

#### GEOMETRICAL CONSIDERATIONS.

THE following propositions respecting faults apply to strata, which are either horizontal, or which have a uniform dip. If they have a uniform dip, the country, faults and all, may be supposed turned back through the angle of dip, and the strata will become again horizontal. We need then only think of horizontal strata, if we bear in mind that "horizontal" and "vertical" really mean only, parallel and perpendicular to the bedding. This artifice will simplify the subject; but it does not imply that the faulting took place before the beds were tilted, which may, or may not, have been the case.

In practice, the strata of a country are tested by means of a trial bore-hole. We will therefore call a straight line drawn perpendicular to the bedding a "trial line."

FIG. 1.

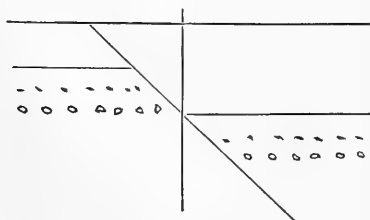
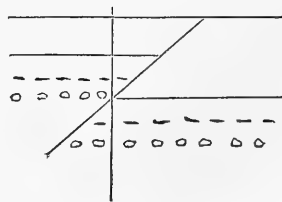


FIG. 2.



(1.) If a trial line fails to cut a given thickness of beds, then there is a "downcast" or "direct" fault, of vertical throw equal to the thickness of beds that are missed: and the strata are, on the whole, stretched horizontally, and compressed vertically.

<sup>1</sup> The author has had the advantage of the criticisms of A. Harker, Esq., B.A., F.G.S., Demonstrator of Petrology in the Woodwardian Museum, Cambridge, on Parts I. II. III., from whom he has received some important suggestions.



(2.) If a trial line cuts any given bed twice, the fault is an "upcast" or "reversed" fault and the amount of vertical throw is equal to the thickness of the beds which are twice encountered by it; and the strata will be on the whole compressed horizontally and stretched vertically.

From these two self-evident propositions many results more complicated immediately follow.

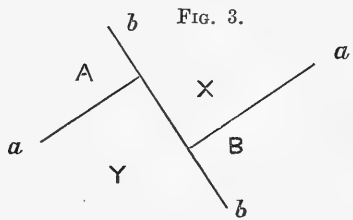
§ I.—Of Direct Faults.

(3.) If there are two direct faults of vertical throws  $a$  and  $b$  (that is, of  $a$  and  $b$  feet or other unit of measure), a trial line cutting both faults will have missed a thickness  $a$  of beds as soon as it has crossed the first fault, and an additional thickness  $b$  of beds as soon as it has crossed the second fault. It will therefore on the whole have missed a thickness  $a + b$  of beds when it has crossed both faults.

It follows immediately that, if two faults intersect one another, the trial line through their intersection will have crossed both of them at once, and will therefore miss a thickness of beds equal to  $a + b$  at that one place. This however, being a case of a "trough" fault, is deserving of somewhat fuller consideration.

(4.) *Trough faults.*—Let there be two "direct" clean-cut faults hading inwards towards the same vertical. Their outcrops may, or may not, intersect. And let the first fault  $a a$  be faulted by the second  $b b$ .

The figure is supposed to be a vertical section. The masses of rock  $A, X, B, Y$ , were originally unsevered. When the fault  $a a$  occurred,  $A$  and  $X$  moved towards the left, and also got a throw  $a$  downwards with respect to  $B$  and  $Y$ , which remained stationary: when the second fault  $b b$  occurred,  $B$  and  $X$  moved to the right, and got a throw  $b$  downwards with reference to  $A$  and  $Y$ , which this time remained stationary. Now although the two downward throws, which have affected  $X$ , might have been the result of a single movement, yet its horizontal movements, having been in opposite directions, could not have been simultaneous. This shows that the fault  $b b$  must have been subsequent in time to the fault  $a a$ , although the interval may have been either short or long.



It will be observed that the mass  $Y$  has remained stationary during both movements, and may therefore serve as a base, to which the throws may be measured.

Then the throw of	$A$	with respect to	$Y$	is	$a$ .
"	"	"	$B$	"	$b$ .
"	"	"	$X$	"	$a + b$ .
The throw of	...	$X$	"	$A$	" $b$ .
"	"	$X$	"	$B$	" $a$ .
"	"	$A$	"	$B$	" $a - b$ .

The relative throw of *A* and *B*, however, might be called equally well  $b - a$ . The choice between the two expressions depends upon whether any given point in *A* got the greater throw downwards at the first or at the second movement.

(5.) To obtain these results at once by trial lines, suppose  $a, b$ , to be the outcrops of two faults, the arrows showing the directions of their hades.

Then it is evident that  $a$  hades under *X* and *B*, but not under *A*; while  $b$  hades under *X* and *A* but not under *B*. Hence a trial line put down in—

<i>A</i>	indicates a throw	<i>b</i> .
<i>B</i>	„	<i>a</i> .
<i>X</i>	„	$a + b$ .

We further see that one put down in *Z* will cut neither fault. Hence *Z* is not thrown, and must therefore be continuous with the hidden mass *Y* below, as upon consideration it will be seen to be.

The relative throw of any two masses will be the difference of their total throws; so that the relative throw of—

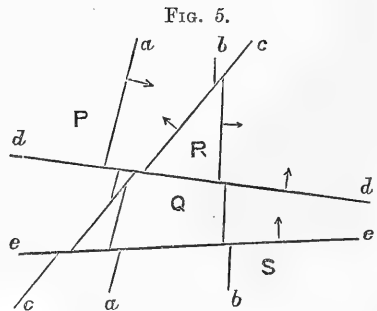
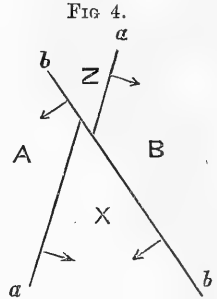
<i>A</i>	and	<i>B</i>	is	$a - b$ ;
<i>A</i>	„	<i>X</i>	„	$a$ ;
<i>B</i>	„	<i>X</i>	„	$b$ .

It might happen that the throws of the first and second faults were equal, or  $a = b$ ; and then the throw of *A* with respect to *B* would be nothing, that is the beds of *A* and *B* would be left on a level with each other. The beds of *X* however would be depressed through  $a$  with respect to either *A* or *B*. In such a case, the throws of *A* and *B* being the same with respect to *Y* (see Fig. 3), the two faults would cross one another at the apex of the wedge *X*, and a trial line passing through the apex would miss a thickness  $2a$  of beds all at once.

This method is easily extended to any number of faults. Suppose the figure to represent the outcrops of a system of faults, hading in the directions indicated by the arrows, and having throws  $a, b, c, d, e$ , respectively, and having occurred in that order in time. Then to take four instances only, we have merely to notice which faults a trial line would cut. Thus—

The total throw of	<i>P</i>	will be	$c + d + e$ ,
„	<i>Q</i>	„	$a + e$ ,
„	<i>R</i>	„	$a + d + e$ ,
„	<i>S</i>	„	$a + b$ ,
The relative throw of <i>P</i> and <i>Q</i>		„	$c + d - a$ ;
„	of <i>Q</i> and <i>R</i>	„	$d$ ;

and so on.



(6). Suppose three faults all hading inwards towards the enclosed space *X*.

By putting down trial lines we see that,

<i>A</i>	will be thrown	$b + c$ ;
<i>B</i>	"   "	$a + c$ ;
<i>C</i>	"   "	$a + b$ ;
<i>X</i>	"   "	$a + b + c$ .

The relative throws of *A*, *B*, and *C*, will be the differences of their total throws; so that the relative throw of

<i>A</i> and <i>B</i>	will be	$b - a$ ,
<i>A</i> " <i>C</i>	"   "	$c - a$ ,
<i>B</i> " <i>C</i>	"   "	$c - b$ .

If it should then happen that the throws of the three faults were all equal, we should find *A*, *B*, and *C*, each of them thrown through  $2a$ , and therefore left with their beds on the same level; while *X* would be thrown through a space  $3a$  with respect to the subjacent hidden mass *Y*, and would have a relative throw  $a$  with respect to *A*, *B*, and *C*. In this case *X* would terminate downwards in a point, and the appearance would be that of a pointed pyramidal mass, forced down like a wedge in the midst of *A*, *B*, and *C*, without these latter seeming to be disturbed.

As for the areas *P*, *Q*, *R*, the total downthrow of each would be  $a$ , so that *A*, *B*, *C* would be thrown through  $a$  with respect to *P*, *Q*, *R*.

A vertical fault must be regarded as hading towards the downthrow side, and be included among the faults cut by a trial line on that side; which may be supposed to happen to it at an infinite depth.

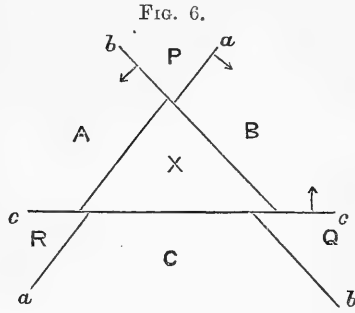
To obtain the throw of the beds at any specified depth we must omit the throws of the faults cut by the trial line before reaching that depth.

### § II.—Reversed Faults.

(7.) Propositions analogous to the above will hold for reversed faults if for "throw" we substitute "lift," and remember that, by every fault which hades under them, a thickness of beds equal to the "lift" of the fault is reduplicated instead of missed. Thus, in the case analogous to (6),

<i>A</i>	will be lifted through	$b + c$ .
<i>B</i>	"   "	$a + c$ .
<i>C</i>	"   "	$a + b$ .
<i>X</i>	"   "	$a + b + c$ .

A trial line put down in *X* will encounter an additional thickness of beds equal to  $a + b + c$ ,  $a$  of which will be reduplicated after passing through the fault  $a$ ,  $b$  after passing  $b$ , and  $c$  after passing  $c$ . If  $a$ ,  $b$  and  $c$  are all equal, *A*, *B*, *C* will be left at a uniform



level, and  $X$  will be lifted  $3a$  with respect to the hidden mass  $Y$ ; so that a thickness of beds equal to  $3a$  will be twice encountered at the vertex of  $X$ , which in such a case will form a pointed wedge-like pyramid.

In natural instances of reversed faults much greater complication usually occurs than with direct faults, because the compression, to which they are due, tends to flex the strata. These are almost always bent at the fault-plane, sometimes on one side of it, sometimes on both, sometimes up, and sometimes down. Sometimes a short cross fault orthogonal to the main fault cuts the ends of the strata, and the beds are bent up against the main fault on one side of this, and down against it on the other. Indeed the parallelism of the strata, which is assumed in the above reasoning, can seldom be invoked in the case of reversed faults.

## PART II.

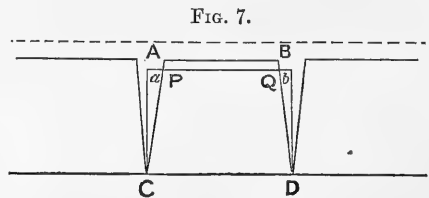
## THE MECHANICS OF FAULTING AND JOINTING.

§ I.—*Direct Faulting and Jointing.*

There can be no doubt that direct faulting is, in many instances, the consequence of settlement, when the strata contract through solidification. Let us suppose a certain thickness of sediments to have been deposited upon a bottom, which had already attained its final density. It is evident that the tendency will be, for the sediment, as it solidifies, to contract, both vertically and horizontally. But the layer next to the bottom is held fast by friction, which has there its greatest value, because the pressure is greatest there; and also by adhesion; and the surface being horizontal, gravity cannot assist the contractile force to overcome it. In the Fig. (7) let the broken line indicate the height that the sediment would reach if it had not contracted. The tendency will be, for it to settle down, owing to the vertical contraction; and also to be split up into blocks, owing to the horizontal contraction. But the gaps need not be at any time actually formed, because the internal movements, which we are now considering, will keep pace with the tendency to gape, and prevent any wide gaps from being actually opened.

The problem then consists in devising the manner of cutting up the mass, consistently with mechanical laws, so that gaps should not be produced during the settlement. The readiest way to conceive how this may happen will be, to suppose them to have been formed, and to consider how they might then be closed.

Let  $ABCD$  be one of the blocks; and  $abCD$  the rectangular block of equal volume, into which it must be deformed, in order to fill the two half gaps at either end of it. Then  $ABQP$  is the volume which is available for this

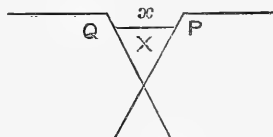


purpose. It is to be observed that, since the mass is supposed to

have now contracted, the matter of which it consists is stable, except in so far as gravity may affect it. It seems however certain that faulting, without some amount of deformation, cannot completely fill the void spaces. But since in nature the movements will go on while the mass is solidifying, this very condition implies that it still possesses a certain degree of plasticity.

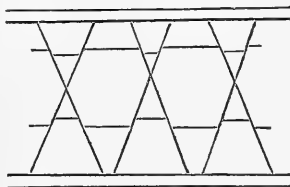
On account of the fixity of the matter along the bottom  $CD$ , the faults must die out when they reach that depth. But a total throw, through the height of  $AB$  above  $ab$ , is available for the throw at the surface. We may feel sure that the result proposed is never fully accomplished, for, if it were, it would imply that the surface became strictly horizontal under the action of gravity, which would mean that the material was liquid; which it is not. But nevertheless horizontality of surface is the result to be approximated to. Crossed faults will effect this most readily; for let there be two faults affecting two areas  $P$  and  $Q$  (Fig. 8), with an area of length  $x$  intervening; and suppose for simplicity that they have equal hade,  $\theta$ , and that  $P$  and  $Q$  at the surface are thrown equally through  $a$  with reference to the fixed bottom. Then, as shown in (4) of Part I., these will be left level; while the area  $X$  will occupy a trough, and be depressed through  $a$  with respect to either of them. A horizontal extension of the surface equal to  $2a \cot \theta$  will be gained, and a volume,  $ax + a^2 \cot \theta$ , will be available towards filling the gaps.

FIG. 8.



In the further case (Fig. 9) of a certain thickness of sedimentary matter inclosed between two beds, of which the upper as well as the lower does not contract, the top layer of the upper half will be under similar conditions to the bottom layer of the lower half. And if we take, in the uncompressed matter, a horizontal layer anywhere between the top and bottom, this will become broken up by crossed faults, into portions dovetailed into one another. The throws of the faults will on the whole diminish, both upwards and downwards, as we recede from this, until they die out when they reach the two beds which do not contract.

FIG. 9.



Examples of what are perhaps such faults on a minute scale may be seen in Mr. Teall's slate,<sup>1</sup> only it must be recollected that their hade may not be what they appear to be, because the plane of cleavage is probably not perpendicular to the planes of faulting.

In connection with this subject of faulting, we cannot regard the rocks either as decidedly rigid or as decidedly plastic. They must partake of the quality of rigidity, inasmuch as the forces acting upon them produce fractures along certain surfaces; and they must

<sup>1</sup> GEOL. MAG. DEC. III. Vol. I. Pl. I.

be considered plastic, inasmuch as they yield to pressure; so that, after rupture, spaces become filled up, which would be left vacant after the subsequent movements, if the material were rigid.<sup>1</sup> The rationale of the mechanical action appears to be of the following kind.

Let  $ACBD$  (Fig. 10) be the medial section, parallel to the vertical sides of a parallelepiped of unit thickness, within a mass of rock; and suppose this portion to be subjected to a horizontal stress in the direction perpendicular to  $AC$  and  $BD$ , which may be either a pressure or a tension.

As far as regards the disruption of this mass, we need only take into account equal stresses upon its opposite sides; for, if the opposite stresses are unequal, the excess of the one over the other will tend only to move the mass as a whole. Let then the horizontal stress at the place under consideration be  $P$  pounds upon a square unit of vertical section. This assumption, that the pressure varies as the area on which it acts, introduces the idea of plasticity. If we then have regard to the vertical slice of unit thickness, of which our parallelepiped forms part, the stresses upon  $AC$  and  $BD$  will be each equal to  $P \times AC$ , or  $P \times AB \sin \theta$ .

The parallelepiped is also subjected to the stress, which arises from the weight of the rock above it and the reaction of the bottom which is supposed to be fixed; and, upon a similar assumption as to its constitution,  $W$  being the pressure upon a square unit, the pressure upon  $AD$  will be  $W \times AB \cos \theta$ , which will act downwards upon  $AD$ , and upwards upon  $BC$ .

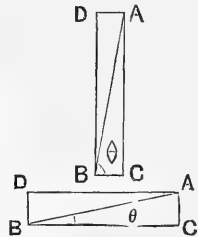
If now we resolve these two pairs of forces along the diagonal  $AB$ , the force which tends to push the half  $ADB$  in the direction  $AB$  will be the sum or difference of the resolved parts according as the horizontal stress is a tension or a pressure. Hence

$$\begin{aligned} \text{Force on } ADB \text{ along } AB &= W \times AB \sin \theta \cos \theta \pm P \times AB \sin \theta \cos \theta, \\ &= \frac{1}{2}(W \pm P) AB \sin 2\theta. \end{aligned}$$

Let this be resisted by a statical force per unit area along  $AB$ , whose measure is  $\mu$ . Then, so long as  $\frac{1}{2}(W \pm P) \sin 2\theta$  is less than  $\mu$ , no motion can take place along  $AB$ . But, as soon as this is equal to, or greater than,  $\mu$ , motion may ensue, other controlling circumstances being favourable. This force  $\mu$  will arise from the constitution of the material. If it is rigid, and continues rigid under the action of the shearing stress until it separates along  $AB$ , then  $\mu$  is a coefficient of adhesion.

But if the material continues rigid until the shearing stress attains a certain amount, and then begins to "flow" (as in M. Tresca's

FIG. 10.



<sup>1</sup> The writer offered some suggestions upon faulting in his *Physics of the Earth's Crust* (1881), which, although possibly applicable in some cases, he is now constrained to admit are not generally satisfactory. The appearance of Mr. Teall's notice of a faulted slate has led him to a review of the whole question.

experiments), the material will not separate, but after motion has commenced will behave like a viscous substance. It must, however, be remembered that our  $\mu$  is still a resistance to shearing stress, and not the coefficient of viscosity.

The tension  $P$  is evidently a force which increases in intensity during contraction. To determine how large it may become, we observe that  $P$  depends upon the horizontal cohesion of the rock, and upon the reaction of the fixed bottom. Let  $\kappa$  be the cohesion per unit area of a vertical section. Then, on account of the great energy of molecular forces, we may expect that  $P$  is capable of increasing until it becomes equal to  $\kappa$ . The tension arising from the contraction is resisted by the stress exerted by the bottom, and the whole tension along a length  $x$  will be proportional to the length; and will amount to  $P$ .

$$\therefore P = \lambda x \text{ (suppose).}$$

Now in order that the force may be sufficient to overcome the cohesion, we must have  $P = \kappa$ .

$$\therefore \lambda x = \kappa; \text{ and } x = \frac{\kappa}{\lambda}$$

If we knew the values of  $\kappa$  and  $\lambda$ , this would give an idea of the distance between two vertical cracks, which would be  $2\frac{\kappa}{\lambda}$ , because midway between two cracks the action of the bottom would be *nil*, and there would be no tension.

We observe that  $\kappa$  is a tensile, whereas  $\mu$  is a shearing force.

It seems probable that in hard rocks both  $\kappa$  and  $\lambda$  would be large, and in soft rocks both small. Since then the distance between the cracks depends on the ratio of these two quantities, the blocks between the joints might be of about the same size in soft rocks as in hard.

We have seen that the shearing force on  $ADB$  along  $AB$  is

$$\frac{1}{2} (W + P) \sin 2 \theta.$$

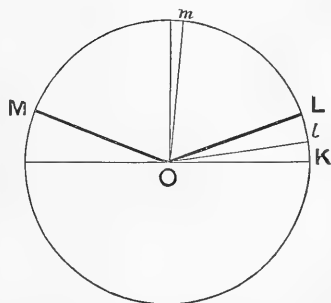
And if this were just sufficient to cause separation,

$$\frac{1}{2} (W + P) \sin 2 \theta = \mu.$$

There are two values of  $2 \theta$  which satisfy this condition, as indicated in Fig. (10). Let them be  $K O M$  and  $K O L$ , Fig. (11). If we bisect these angles by  $O m$  and  $O l$ , then  $K O m$  and  $K O l$  are the two angles  $\theta$  given by the above equation.

It appears that if  $P$  were to increase until it was large enough to produce separation, this would occur with the least value of  $P$  capable of doing it, and with the largest value of  $\sin 2 \theta$ . Hence, so far as the mere magnitude of the force is concerned, separation would take place along  $A B$  when inclined

FIG. 11.



when inclined

at the angle  $45^\circ$ ; and the requisite value of  $W + P$  would be given by the relation

$$\frac{1}{2}(W + P) = \mu.$$

Hence, if other conditions permitted separation, and faulting, it would always be ready to occur at the angle  $45^\circ$ .

But there are two other conditions to be satisfied.

The first of these is that there must be room for the mass to move. This, as we have assumed in our preliminary considerations, will result either from cracks being opened by the contraction, or from there being a tendency set up to open them. Their formation may be thus explained.

The stress normal to  $AB$ , tending to produce separation by cracking, is,

$$P \times AB \sin^2 \theta - W \times AB \cos^2 \theta.$$

And  $\kappa$  being, as before, the coefficient of cohesion, we must have, in order that the rock may be pulled asunder,

$$P \sin^2 \theta - W \cos^2 \theta = \kappa.$$

Suppose, as before, that  $P$  increases gradually until this condition is satisfied. It will be so when  $\theta = 90^\circ$  and  $P = \kappa$ .

We shall then have a vertical joint formed, or tending to be formed, according as the material is not or is ductile. And another will be similarly formed at a distance from this one of  $\frac{2\kappa}{\lambda}$ .

We may thus get a system of equidistant vertical joints.

As soon as the rock is ready to separate, the contractile force will begin to draw the blocks together as in Fig. (7). Being held extended at the bottom by the force  $\lambda$ , a horizontal shearing force will be generated tending to cut up the blocks along horizontal planes. This force will be the excess of the contractile force over the extensile stress at any height. The contractile force may be regarded as constant, but the extensile stress will diminish with the diminishing friction as the cover diminishes. Hence their difference, which is the force tending to draw the rock together horizontally, continually increases upwards, and at every interval at which this difference becomes large enough to produce rupture, a horizontal joint will be produced.

If, however, the substance is of such a ductile nature, that the weight makes the friction too great for separation before a viscous shearing is set up, we may have a kind of horizontal laminated cleavage induced, such as occurs in some coals.

The contractile force of which we have just spoken is not a compressing force of the character which we have attributed to  $P$ . It acts upon the parallelepiped almost entirely in one direction; for the difference of intensity on the two faces may be neglected.

We have then now no compressing force left to consider except  $W$ . Consequently the shearing force along  $AB$  will have become  $\frac{1}{2}W \sin 2\theta$ ; and, in order that separation may take place, we must have

$$\frac{1}{2}W \sin 2\theta = \mu.$$

There is no doubt that in the case of solid rocks  $\mu$  will be a very large



force, for it is only by it that any lofty prismatic column of masonry can stand. Nevertheless, there would be a limiting height to any such a column, and that will no doubt be exceeded by the depth of cover in such cases as we are considering.

We have then the two limiting angles  $\theta$  given by the relation  $\sin 2\theta = \frac{2\mu}{W}$  between which the shearing force is sufficiently great to cause separation.

The second condition requisite is that motion can take place.

In order that faulting along  $A B$  may be possible, we must have the force along  $A B$  greater than the friction; or, if  $\nu$  be the coefficient of friction, it must not be less than  $\nu \times$  the pressure on  $A B$ .

Now it is easily seen that, in the general case, the pressure on  $A B$  will be equal to,

$$W \cos^2 \theta + P \sin^2 \theta,$$

or in the present instance to  $W \cos^2 \theta$ . Therefore we must have

$$W \sin \theta \cos \theta \geq \nu. W \cos^2 \theta.$$

$$\text{or } \tan \theta \geq \nu.$$

In other words, the hade of the fault surface cannot be less than the angle of repose.

The choice of the angle of hade will evidently depend upon the shearing force, and the friction, conjointly. At a given depth the shearing force  $\frac{1}{2} W \sin 2\theta$ , will be greatest when  $\theta = 45^\circ$ . In that case  $\frac{1}{2} W = \mu$ ; and any smaller value would render  $\sin 2\theta$  impossible.

Hence, if the angle of repose is less than  $45^\circ$ , the hade of the fault surface will be  $45^\circ$ . But, if the angle of repose is greater than  $45^\circ$ , the hade will be the angle of repose, provided it lie within  $l O m$ . But if it do not, faulting cannot be induced.

It seems however, that the considerations connected with room for motion, may come into play in determining the hade between the possible limits within the angle  $l O m$ . And faults with different hades will be formed subsequently to one another, during the process of contraction. They would intersect one another, and the faults of steepest hade might be expected to be formed before those of less steep hade, because the tendency to gape would increase more at the upper part of the cracks than at the lower as time went on.

We have considered the disturbances as if they took place only in one direction, say E. and W. Those in the orthogonal, N. and S., will be governed by similar laws. But it will be observed that, whereas the tension  $P$  in one of these directions will be wholly independent of that in the other, yet the weight of rock, which gives rise to  $W$ , is unique. Consequently that part of the potential energy of  $W$  which goes to form faults in one system, say E. and W., will not be available to form them N. and S. There is no reason, except accidental circumstances, to rule in which direction  $W$  shall be chiefly operative. Hence, though the jointing will be probably as strongly developed in one direction as in the other, the faulting will probably be developed chiefly in one direction, and less pronounced in that orthogonal to it.

(To be continued.)

III.—NOTES ON THE SHELL STRUCTURE OF *EICHWALDIA CAPEWELLI*,

By JOHN YOUNG, F.G.S.

Hunterian Museum, University, Glasgow.

RECENTLY, while reading Dr. Davidson's description of his *Eichwaldia Capewelli*, Brit. Sil. Brach. Sup. pp. 140-1, I was much interested with that paragraph in which he states, "It had been suggested to me that the appearance of the sculpture of the surface of *E. Capewelli* is precisely that of certain *Polyzoa* one is accustomed to meet with in Palæozoic rocks, a fact that had struck Mr. R. Etheridge, jun., as well as Prof. Nicholson; but to accept the ornamentation as that of an encrusting *Polyzoan* we must suppose that the shell had been entirely replaced by the parasite, as sometimes occurs with *Hydractinia*. Sections, however, show a perfectly homogeneous structure of the whole thickness of the shell."

Remembering that we possessed a single example of this shell in our Museum, a ventral valve, I determined on having a close examination of its surface, to see whether it would reveal any points of structure other than that already noted. Dr. Davidson, Mon. Brit. Sil. Brach. pp. 193-4, describes the ornamentation of the shell as follows:—"Surface of both valves closely covered with raised, thread-like ridges, forming all over the shell a network of more or less regular six-sided cells, the bottom of the cells being flat, and margined by slightly raised hexagonal ridges. The sculptured surface is very peculiar, and nearly resembles that seen on *Discina (Trematis) punctata*. The cells (not punctures or perforations) vary much in size and shape, are small at the umbone and on the beak, but gradually become larger as they near the middle of the shell, becoming again smaller as they approach the frontal and lateral margins. When there has been an interruption in the growth of the shell, and which is indicated by a sharp concentric line, the cells often begin again by being smaller. They also assume a greater or lesser degree of regularity in their shape, some being almost triangular, lozenge-shaped, or more or less regularly five or six-sided."

An examination of our Hunterian specimen showed the ornamentation of the surface to be as above described; but on a portion of the valve, where the raised hexagonal ridges that bound the cells had been worn down through weathering of the surface, I noticed that these ridges covered over and concealed, on other parts of the shell, a numerous group of polygonal cells, that are at least one-fourth the size of the regular hexagonal cells seen at the surface. On communicating this fact to Dr. Davidson, he expressed interest in what I had found, and very kindly sent me all his specimens of *E. Capewelli* (British and American) to examine, and has also allowed me to etch with acid and to polish certain of the specimens, so as to prove whether this small polygonal shell structure existed in any other of the specimens in which it is not visible on the surface of the shell. I was glad to find that several of Dr. Davidson's specimens confirmed what I had already found, and in a more clear

and satisfactory manner; also, that those he allowed me to etch and polish showed in every instance the existence of this inner layer of smaller polygonal cells beneath the layer of larger hexagonal cells.

On *E. Capewelli* there is a curiously bare triangular spot on the back of the beak of the ventral valve, on which the external shell-ornamentation is now wanting. Dr. Davidson says the smooth triangular space on the beak has been noticed by several observers of this shell, and that he has seen it on all the English as well as foreign specimens that he has examined. Prof. Hall, as quoted by Dr. Davidson, *M. Brit. Sil. Brach. Sup.* p. 41, says: "The small triangular space near the ventral beak, which is destitute of marking, has the appearance of having been exfoliated." I am inclined to think that Prof. Hall is right, for an examination of this spot under the microscope shows that the edge of the ornamented shell-layer is torn and ragged around the triangular space in most specimens, and presents the appearance as if this portion of the shell had been broken away from some sort of attachment to which it adhered during life. In perfect specimens of the shell, it is only on this bare spot that one gets a glimpse of the inner layer of the shell, as on the rest of the surface it is hidden by the outer cellular structure. This inner layer is seen to be smooth, and dense in its structure, and presents a striking contrast to the outer cellular layers, which are of a more open texture. From the smallness of space exposed within the triangular area on the beak, I was not able to determine whether this inner shell-layer was perforated in any way. It therefore occurred to me that I might be able to throw some light on this point, if I could examine fragments of the inner surface of the shell; and fortunately I was able to do this, by having beside me some of the washed Wenlock shales in which the shell is found, kindly sent to me by Mr. G. Maw, F.G.S., at the time he was investigating these shales.

From the fragments of the shell that I have obtained, I have prepared two slides of specimens, which I have presented to Dr. Davidson, so that he might better understand the structure seen in his other specimens. One of these slides shows the inner surface of the shell in the condition in which the fragments were found. The other slide shows tangential sections, polished to a thin transparency, so as to enable the structure to be examined under the microscope.

So far as Dr. Davidson has been able to describe this shell, perforations of the inner shell-layer have not been noted; but the specimens I have found show that this inner layer is distinctly perforated by numerous minute circular tubes, that open on the inner surface of the shell, in some specimens, with slightly raised tubercle-like orifices. These perforations are visible to the eye in good light with a pocket lens, but are better seen under a low-power of the microscope, and in the transparent sections many of the tubes are seen to be filled with calcite, others with pyrites, and when this is the case, they appear in the section as a series of round black dots. The shell structure between the perforations is seen to be dense, and has a minutely granular texture which may be partly due

to slight change through the action of mineralization, as noticed in some other fossil shells.

My examination of this beautiful and interesting shell has led me to recognize three distinct layers in its structure as shown in the annexed woodcut:—First, the outer hexagonal cell layer, in which the walls are thin at the surface, but thicker at their base, and cover a layer of minute polygonal cells, that are bounded by thin walls. These polygonal cells form the second layer inwards, and are not seen on the surface, except where the outer cell layer has been eroded or not well developed. A certain number of these cells rise above the bottom of the larger cells, and enter the outer cell-walls. In eroded or polished specimens, as many as from six to eight of these smaller cells may be seen in the wall around each larger hexagonal cell, one being generally situated in each of the angles, and sometimes one between; but, as already stated, they do not appear to reach the outer surface of the shell in perfect or unworn specimens.

The third or innermost layer of the shell is the dense portion that is perforated by the minute circular tubes. These tubes are as small as those seen in the shell structure of the Carboniferous *Terebratula hastata*, but they are only about one-third as numerous as seen in that shell. They agree in character with that seen in many other of the Brachiopoda; but the outer shell layers of *E. Capewelli*, Dav., are so unlike what is known to exist in this group, that one is not surprised to learn that they have been suspected to be of Polyzoal origin, and the resemblance of the cell arrangement to that seen in some forms of *Monticulipora* is further increased by finding that the outer cell-walls enclose a series of smaller polygonal cells, as is common in some of the members of this group. I do not, however, know any form of Silurian Polyzoa or *Monticulipora*, that has exactly the same external form of cells, and my examination of *E. Capewelli*, strongly inclines me to the belief that, although the structure is peculiar for a Brachiopod shell, yet it is one that naturally belongs to it, although, at first, I was inclined to regard it, as some others have done, as probably Polyzoal.

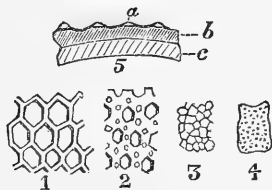
As just stated, I am inclined to regard the external celluliferous structure of *E. Capewelli* as natural, and have been gradually led to this conclusion by the careful study of Dr. Davidson's specimens, and from sections of portions of the shell that I have made.

If the outer celluliferous layer is examined, it will be observed that it is thin at the beak of the ventral valve, where the bare triangular spot is seen. From this point it very gradually increases in thickness as it reaches the front margin of the shell. In a vertical section, through both valves, and from fragments picked from the shale, I find that the outer celluliferous layer is just about equal in thickness to that of the dense inner layer of the shell. From the way in which this outer layer has parted from the inner, in every instance, on the bare spot on the beak of the ventral valve, it would almost lead to the supposition that, previous to fossilization of the shell, along this line there was a weak connection between the two layers, although now they seem to be firmly united;

through mineralization of the shell. Such a weak line I have found in the shells of *Productus*, existing between the perforate and imperforate layers.

In a vertical section through the thickness of the shell, the outer celluliferous and inner dense layers are seen to be very distinct; but there is no apparent line of separation of the shell substance between the two layers. I have examined carefully under the microscope the minute circular tubes that are seen in the inner dense layer, but I have failed in finding evidence that they extend upwards in the shell structure beyond this layer. It is probable they do not, as they do not show themselves in the cross or tangential sections I have made, and in the one vertical section of the shell that I have prepared, they do not appear to exactly correspond, either in number or position, with the larger cells that lie over them. This, however, is a point that can only be satisfactorily determined by the examination of more numerous sections of the shell.

There is less difficulty in explaining the difference of structure that exists between the outer and inner cell layers. In these, we see that certain of the small polygonal cells, in regular spots, ceased to be further developed, while other of these cells continued to grow a little higher along certain lines. These cells of the second layer were afterwards covered and concealed by the growth outwards of a boundary wall, that in the latest stage separates the hexagonal cells from one another. This is well illustrated in a partly eroded shell from Dudley in Dr. Davidson's collection, and may be shown to exist in every specimen in which the shell structure is not too much crystallized, if a portion of the surface be ground down a little way so as to show the inner cell layer.



1. Hexagonal cells of the outer surface of the shell in unworn specimens.
2. Small polygonal cells in walls of hexagonal cells as seen in worn or polished specimens.
3. Polygonal cell layer between outer hexagonal cells and inner dense layer.
4. Perforations of inner dense layer of the shell.
5. Vertical section of the shell; *a*, outer hexagonal cell-walls; *b*, polygonal cell-layer; *c*, inner dense layer with minute perforations.

All the sketches more or less magnified.

There is no evidence of perforations in this outer shell wall, and I have only to remark, before bringing these notes to a close, that a farther examination of the outer cell-layers around the bare spot on beak of the ventral valve, confirms what has been already stated, as to the probability of that portion of the shell having once been attached, and afterwards broken away from its attachment; for besides the rough, ragged, edges of this cell-layer, that I have

already indicated, there is no finish to the edges of the cells around the bare spot, which one would naturally have expected had this outer shell layer never extended beyond its present margin.

I hope the new points of structure here noticed in *Eichwaldia Capewelli*, Dav., will lead to farther examination of this interesting shell by those who have opportunities of examining specimens from various localities, so that our knowledge of both its internal characters and external structure may be extended beyond that now known; and this can only be done by the discovery and examination of specimens in which the shell-structure has suffered little change through crystallization.

NOTE.—Since this paper was written and sent to the Editor of the GEOLOGICAL MAGAZINE, Dr. Davidson has informed me that in his "Supplement to the British Silurian Brachiopoda," p. 141, he had omitted to note, while making reference to what Professors Angelin and Lindström had figured and described of the external and internal characters in *Eichwaldia Capewelli*, Dav., from Swedish specimens in their "Fragmenta Silurica," viz. that they had also in the same work, p. 25, pl. ii. fig. 16-20, described and figured two distinct layers in this shell, both of which are perforated by two different sets of tubules—an outer layer running obliquely inwards and downwards, and a second or inner layer, in which the tubules perforate the shell in a horizontal manner from the inner surface.

This being the case, they have therefore the merit, of having been the first to put upon record the points of structure which I here notice more fully than they have done; and which I had independently discovered for myself. In the description of Professors Angelin and Lindström, they only notice two layers in the thickness of the shell. In my paper, I call attention to a third outer layer, that forms the external hexagonal cells, and which, when present, on perfect portions of the surface of the shell, conceals the inner or second layer, which is formed of small polygonal cells, as noted in the paper.

#### IV.—NOTES ON PROGRESSIVE METAMORPHISM.

By C. CALLAWAY, D.Sc. F.G.S.

ON no branch of geology has there been more imaginative writing than upon metamorphism. Some speculations have, indeed, diverged into the humorous. Keen-eyed observers, with vision capable of piercing through miles of solid rock, have described to us those processes of subterranean cookery by which Pluto has converted sandstones and shales into granite, metamorphic schists and porphyries. If water was used, the rocks were "stewed"; if not, they were only "baked" or perhaps "melted." Furthermore, it was declared, and text-books submissively taught, that rocks of almost every epoch have sometimes undergone these mystic changes. In North America, some metamorphic schists were "Triassic"; while in the European Alps we had granite and gneiss of "Eocene" age. In Britain, men were more moderate, and we were not asked to extend our faith beyond the limits of the Palæozoic formations. The evidence on which these conclusions were advanced was

mainly of two kinds. A metamorphic rock associated with unaltered beds was proved to be of the same age as the latter, because either it *overlay* or *passed into* them. Thus, as an illustration of the former, the newer gneissic rocks of the Northern Highlands were said to be Ordovician, because they rested on Ordovician limestone and quartzite. Murchison saw the gneiss lying on the top of the limestone or the quartzite, and he said that the upper beds were the younger. Everybody believed him, except Nicol, who died discredited and disheartened. Now, we know that Nicol was right, and the great authority, misled by superficial appearances, was wrong. This line of evidence, however, I do not for the present follow; but confine myself to the latter fallacy. I propose to examine a few of the cases in which a passage has been or might be alleged to exist between metamorphic masses and contiguous unaltered strata.

Perhaps I cannot commence better than by exposing one of my own mistakes. In an early stage (1879) of my investigation into the metamorphic rocks, I examined similar sections at Twt Hill, near Caernarvon, and Nebo, near Amlwch, Anglesey; and, under the influence of the popular teaching, I believed there was in both cases a passage between gneissic rock and conglomerate. Professor Hughes, supported by Dr. Roberts, subsequently attacked this view, and my own observation has convinced me that they are right. At Twt Hill, the arkose, being composed of the same constituents as the adjacent granitoid rock, looked so much like the latter that I was deceived, and I followed my predecessors into the error of the old school. This mistake carried with it the section at Nebo. Believing by analogy that the Nebo conglomerate was Archaean, I was bound to make the overlying shales unconformable; and the very singular way in which the shales are thrust on to the conglomerate and squeezed into its hollows, gave a colour to the interpretation. However, having been once bitten, I hope I shall be twice shy.

Other examples in Anglesey will be given in a paper now in the hands of the Secretary of the Geological Society. I discussed an alleged case of progressive metamorphism in the district south of Wexford in this MAGAZINE, November, 1881.

*Alleged Passage between the Llanberis Slates and the Metamorphic Rocks of Anglesey.*

A good example, on a large scale, of the fallacy which I am discussing is furnished by the reasoning by which Sir A. C. Ramsay attempts to prove the Cambrian age of the green schists west of the Menai Straits. The Llanberis series becomes, he says, more altered towards the west, first, by the "porphyry" of Llyn Padarn, and then by the granitoid mass north of Caernarvon; or, to represent the view which he seems to prefer, these crystalline rocks are themselves portions of Cambrian and Silurian formations melted down. I will not stop to discuss the possibility of the conversion of slate and conglomerate into felsite, to which the chemist might raise some objections. It is sufficient to point out that the conglomerates on Llyn

Padarn contain numerous pebbles of the very rhyolite into which they are supposed to pass. It is therefore impossible that the igneous rock, being older than the Cambrian, can have melted it up. Similar evidence is furnished in the Caernarvon area. Thus we see that the *cause* of the alleged progressive metamorphism being proved non-existent, one branch of the argument breaks down. But, of course, metamorphism may be produced by an agent which is to us invisible, and we are brought to the inquiry: Does this progressive metamorphism exist? Can we (1) connect the Llanberis beds with their (alleged) equivalents at Bangor, and (2) those at Bangor with their (alleged) equivalents on the other side of the Straits? I unhesitatingly affirm that no such connection can be established. The Bangor region has been worked by Professors Bonney and Hughes; but I have seen enough of the ground to be able to form an independent opinion on the question. The area between the "porphyry" mass south of Bangor and the undoubted Cambrian rocks which come in near the city is occupied by a fragmental series of very varied character. The most marked types are agglomerates, felspathic grits and slates, the materials being either derived from the "porphyry," or consisting of volcanic ejectamenta. Even the slates, under the microscope, are shown to be made up of volcanic dust. Some of the grits are undistinguishable from typical volcanic rocks of the Wrekin. On the Survey Map, the lower part of the Bangor series is represented as partially metamorphosed, presumably on the ground that the rocks bear some resemblance to the contiguous "porphyry." But the similarity is simply due to the fact that the conglomerates and grits are largely composed of pebbles and lapillæ of volcanic rock. There is no *progressive* metamorphism, for there is no metamorphism at all in either group. The "porphyry" is an igneous rock, and the clastic series, being younger, cannot have been altered by it.

Crossing the Menai Straits, we find ourselves suddenly landed in a truly metamorphic region. Around us are chloritic and hornblende schists, underlain by thin-bedded grey gneiss, the whole lying in foliation planes which have undergone intense contortion. These rocks form a band about three miles wide, and strike to the south-west. They are too well known to need further description.

These, then, are the three terms of our series, (1) *Clay-slates*; (2) *Volcanic agglomerates and tuffs*; (3) *Schists and gneisses*. The Llanberis slates pass through the state of volcanic ejecta into gneiss and schist! I presume that in these pages the mere statement of this hypothesis is a sufficient refutation.

*Cases of an Apparent Passage between rocks of the Ordovician and Caledonian groups in the Northern Highlands.*

I have much pleasure in supplying the followers of Murchison with some excellent material for refuting the views of Professor Lapworth and myself on the Highland succession. Some of these facts are indicated in my recent paper,<sup>1</sup> but its scope did not permit

<sup>1</sup> Quart. Journ. Geol. Soc. August, 1883.



the elaboration of every point. In some localities, where the Archæan gneiss has been brought (by folding or thrust) over the Assynt Group, the latter grows progressively metamorphic towards its junction with the gneiss.

Some of the most interesting examples are found in Glen Coul,<sup>1</sup> in the Assynt district. This wild valley, walled in on both sides by vertical precipices, and accessible only by dangerous mountain paths, or from the sea, contains some of the most remarkable and sublime geological phenomena in the British Isles. In the perpendicular cliffs of the fiord of which the glen is a continuation, the Hebridean gneiss lies in almost horizontal masses upon the crushed and contorted fragments of Ordovician limestone and quartzite. Here, however, although the actual contact between the older and newer groups can be seen at several points, the alteration of the Ordovician is very slight. The probable cause of this I will notice further on. The phenomena to which I call special attention occur about a mile up the glen, just under the escarpment of Caledonian gneiss, where it rises into the peak called the Stack of Glen Coul.

About fifty yards from this gneiss, the quartzite, dipping easterly, begins to lose its distinctive character. It grows flaky, as if affected by a rough cleavage; the grains of quartz become indistinct, but on careful examination they can be seen to be flattened out; and the rock acquires a glazed appearance, as if by the introduction of a new mineral. The alteration, however, has not obliterated the "worm-holes," which are quite distinct, though greatly distorted and lengthened out, as if by a force pushing from the east. The following is Professor Bonney's account<sup>2</sup> of the rock under the microscope: "Chiefly quartz (fragmental) and sericite (?), evidently much compressed, as shown by the flattening-out of the grains." A second specimen<sup>3</sup> is taken from about the same distance from the Caledonian, but perhaps a little further off. The rock is from the lower part of the quartzite, and displays clearly the characteristic grains of felspar. The alteration does not appear to be so far advanced as in the first example. The microscopic structure is thus described:—"It consists of quartz and felspar, . . . separated by thin films of a micaceous mineral, more or less dotted with opacite. The structure is undoubtedly fragmental; the rock has undergone great compression, the fragments being crushed, flattened out, and 'packed' together, as one sees in slates."

Towards the contact with the Eastern Gneiss, the alteration increases, and, at the contact, nearly every trace of a clastic structure is obliterated, and the rock assumes the appearance of a quartz-schist. Indeed, when I first saw it, I supposed it was a band at the base of the Caledonian, and so described it in my note-book. A similar change is to be seen also in the Erriboll district. We will take one example. In Ben Arnaboll, the quartzite is folded in with the Arnaboll gneiss, and the syncline is bent back to the west, so that the

<sup>1</sup> *Ibid.* pp. 373, 378, 384, 390.

<sup>2</sup> See his appendix to the above paper for this and the following descriptions.

<sup>3</sup> In Prof. Bonney's Notes, p. 418, Nos. 97 and 102 should be transposed.

gneiss appears to conformably overlies the quartzite, the whole dipping easterly. The bed of quartzite in contact with the overlying gneiss looks very much like a quartzose gneiss, and would no doubt be so regarded by many geologists. But, in addition to the evidence furnished by the section, the microscope affords valuable testimony to the true nature of the rock. A specimen from this locality is grouped with one from the base of the Stack of Glen Coul in the following description:—"They may be called quartzites; for the mineral is chiefly quartz, but it is extremely difficult, especially in the former (from Glen Coul), to detect with certainty the original fragments. Viewed with crossed Nicols, the slide appears to be composed of minute granules of quartz of chalcedonic aspect; among these are wavy, somewhat parallel bands, which appear almost homogeneous, but break up like the rest as the stage is rotated, though occasionally an irregular nucleus appears to remain homogeneous. These give a streaky or somewhat foliated aspect to the slide. There is a little sericite, which enhances the structure. In the Glen Coul specimen, however, which contains a little hæmatite, some few original grains of quartz may be recognized, together with a little microlite. I should suppose these rocks to be exceptional varieties of the quartzite group; but the obliteration of the characteristic structure, and the resemblance to the quartzose part of many highly-altered mica-schists, suggests that the rock may have been originally rather a fine-grained sand or silt, and then, by the action of heat, pressure, and water, almost reduced to a gelatinous silica: so that, as in a schist, many of the minute grains of quartz now visible are of secondary origin."

We thus see that a gradation may be traced between ordinary quartzite and a rock which has many of the characters of a true schist; but in which, under the microscope, slight traces of the fragmental structure may still be detected. A Murchisonian would, therefore, be almost certain to quote such examples as these in support of the theory to which his leader, by the sheer force of authority, compelled the assent of the scientific world.

While examining these interesting rocks, I became convinced that pressure has had more to do with metamorphism than has commonly been supposed. On Loch Glen Coul, where masses of Hebridean gneiss rest upon the Assynt group, I could detect no material alteration in the latter; and here accordingly there is no evidence of extraordinary pressure. Up the glen, however, where the progressive alteration is seen, we are in the focus of an enormous squeeze. The quartzite is reflexed again and again in closely adpressed folds, as if it were too tightly folded in with the Hebridean to suffer fracture. But on the loch, the quartzite and associated beds are shivered into a chaos of fragments, as if, being unsupported from behind, they had relieved the pressure by giving way. Here, they are not folded with the Hebridean; but great masses of the gneiss have been thrown over on to the top of them. The mere-weight of these overlying beds must have exerted a pressure incomparably less than the great earth-thrust which has so intensely squeezed and contorted

the quartzite in the Glen section. I have before me a piece of the squeezed quartzite, taken from under the Caledonian gneiss, with which it was in immediate contact; and it will be seen from the figure how powerful must have been the lateral thrust.

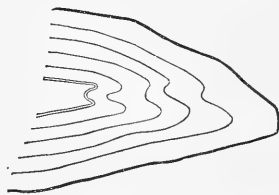
In this sketch I have inserted only the principal divisional lines, merely to show the degree of contortion; but the spaces between these are, in the specimen, filled in with numerous finer lines, so as to display the schist-like structure, to which I have referred.

A three-fold change, we have seen, has taken place in the quartzite. The quartz grains have been flattened, they have been rendered chalcedonic, and sericite has been deposited between them. The flattening is easily explained by the pressure, but will the same cause account for the other two effects? Before I answer, I would remark that in other localities, where the same conditions, minus the pressure, have been reproduced, the metamorphism is wanting. Masses of gneiss frequently rest immediately upon quartzite; and the felspar of the gneiss may well have supplied the material of the sericite. However, little chemical change has taken place. But excessive pressure appears to have induced not only mechanical, but chemical, alteration. The *modus operandi*, it seems to me, may have been the following.

The probability that the gneiss, as well as the quartzite, contained water will, I presume, be admitted. It is more than probable that the enormous pressure generated heat. I do not call in the aid of secular heat, for I do not suppose that in the Silurian epoch the rocks in question were depressed to a sufficient depth. The heated water would certainly be capable of extracting from the felspar of the gneiss the material necessary for the production of a hydrous mica. How this solution was introduced into the quartzite, we can but guess. Capillarity, aided by the heat; osmose between the water in the quartzite and the denser fluid in the gneiss; pressure; any or all of these may have been concerned in causing the necessary motion. Finally, it is not difficult to understand the deposition of sericite between the particles of quartz, now flattened out into continuous folia, or the conversion of the quartz into chalcedony. The quantity of heat required would not, I think, be very great.

The progressive alteration of a sedimentary rock towards its junction with an adjacent metamorphic mass is thus seen to prove nothing with reference to a passage between the two groups.

In the Highlands, a false appearance of a gradation between two series is sometimes produced by changes in the older rock at the contact with the newer mass. In some places, the Hebridean gneiss, thrown over on to the Ben More grit, which is often little more than



Squeezed quartzite in Glen Coul,  
Sutherland.

an arkose of the gneiss, has suffered such intense crushing as to resemble a grit for a thickness of several feet or yards. It is thus very difficult to distinguish between the true grit and the smashed Hebridean, even in good specimens of the two; and it is of course more difficult to determine where the one leaves off and the other begins.

Great pressure often produces an appearance of conformity between rock-groups. In Glen Coul, for example, the Hebridean usually strikes to the north-west at a high angle; but, just when it is folded over the dolomite of the Assynt series, the strike twists round through  $70^{\circ}$  or  $80^{\circ}$ , and the old gneiss dips to the south-east in perfect conformity with the underlying dolomite. A similar change takes place up the glen, where the great squeeze has pushed or folded the Caledonian gneiss over the quartzite. The Hebridean maintains its normal strike until we reach the point where the newer gneiss overhangs. Here the pressure has brought the strike round into accordance with that of the overlying rocks, gneiss and quartzite.

Few delusions have done more to retard the progress of our science than the current hypotheses on metamorphism. It has been taken for granted, even by those who claimed to be our geological pastors and teachers, that the upper of two rock groups, conformable or otherwise, must be the younger. Thus the Highland gneiss was "proved" to be "Silurian." Yet no fact is more familiar than that in mountain chains inversion is rather the rule than the exception. Our recent work in the Highlands has demonstrated that the structure of the country is in accordance with this principle. I have walked on beds of rock lying flat as they were deposited, and, without removing my feet from them, have followed them yard by yard, till I have stood on them, again lying flat, but *upside-down*. I have seen these inverted strata bent into folds, in which, of course, the tops of the anticlines were formed of the *oldest* beds. One day, I climbed up the south-western shoulder of Ben More of Assynt, and, at a height of 2500 feet, found myself on vertical Hebridean gneiss, *capped by horizontal conglomerate*. Without leaving the bare rock, I descended the slope a distance in vertical height of 1500 feet, and there saw the gneiss *lying flat upon the top of the conglomerate*, the conglomerate itself being turned bottom upwards. Many a weary mile have I paced round the precipitous coast of Sutherland in the north of Assynt, keeping always to the same ledge of quartzite, with steep cliffs of gneiss rising on the inland side. Winding in and out of the fiords, I ever saw the Hebridean reposing as uninterruptedly upon the quartzite as if the "fundamental" gneiss were mere beds of chalk overlying a band of greensand. Yet, climbing the cliffs and striking inland for a mile or two, never leaving the gneiss, I found it *underlying* the same quartzite, with its accompanying flags and dolomite, just as in the escarpment I had left behind me. These are not mere speculations; but statements of facts which I saw as plainly as I see the paper on which I write. It is by such proof as this that the "conquest of the Highlands" is now challenged, and it remains for the followers of Murchison to find a refutation, if they can.

## V.—THE ISLAND OF SOUTH GEORGIA.

By T. MELLARD READE, F.G.S.

THE German Expedition to South Georgia has brought back the interesting information that this island, situated in the Antarctic Ocean, Lat.  $54^{\circ}$  S., Long.  $37^{\circ}$  W., is composed of clay-slate.<sup>1</sup> Not only the part the members of the expedition were able to inspect was found to be composed of this slate-rock, but the glaciers brought down the same rock from the central portion of the island. In some places the slate was interspersed with varieties of quartz. No metals were found, but the rock contained a little iron, a quantity insufficient to affect the magnetic needle.

It has been stated, and in fact generally thought, that the whole of the oceanic islands were composed of igneous rocks; and principally on this slender foundation of negative evidence has been erected an immense superstructure of theory as to what is termed the "Permanence of Oceans and Continents."

The term Oceanic Island is rather an arbitrary one, and, by what seems to me to be reasoning in a circle, those islands which, like New Zealand, though surrounded with deep water, and far from any other land, happen to be composed largely of sedimentary rocks are denied an oceanic character, and are annexed as outliers to the nearest continent. Thus islands are made to do double duty: first, to show us, by the absence of sedimentary rocks, that the ocean is "permanent"; and secondly, if sedimentary strata be present, to prove that they are children of the land, and not of the sea. The obvious reply to this is, that the igneous nature of peaks rising from the ocean is no proof that the strata they rest on is non-sedimentary; whereas, on the contrary, the sedimentary character of the rocks of an island is a proof that there exists in the sea-bed about, an extension of rocks of a similar nature.

The case of the island of South Georgia will, however, be difficult to meet, though I should not be much surprised to hear its oceanic character denied by parity of reasoning. I find by measurement on my map that it is not less than 1200 miles from the nearest continent, viz. South America, and about 800 miles from the Falkland Islands. It is also about one-third of the way between Cape Horn and the Cape of Good Hope. The "Challenger" soundings did not come as far south as this island, but directly to the northward stretches a tongue of the Antarctic Ocean, with soundings of 2900 fathoms. Although the soundings extend only to the 40th parallel, there are certain indications, derived from the currents and the deep-sea temperature, that an area of depression extends from the Falkland Islands to the meridian of the Cape of Good Hope.<sup>2</sup>

Whether we label the island of South Georgia "Oceanic" or not, the fact remains, that it is much further from any continent than the Azores, St. Paul's Rocks, or Ascension, and about the same distance from South America as is Tristan da Cunha from Africa; and all these

<sup>1</sup> *Nature*, March 27, 1884, p. 509.<sup>2</sup> *Thalassa*, p. 18.

islands which are igneous—except St. Paul's Rocks, about which there exists some doubt<sup>1</sup>—have been classified as oceanic.

In Jules Marcou's Geological Map of the World the island appears to be about the size of Cyprus. The scenery, according to the Expedition, in spite of its desolateness, possesses a beautiful Alpine character, the tranquillity of which was only broken by the constant thunder of avalanches. The mountains are from 2000 to 3000 mètres high, and in places they plunge abruptly into the sea. Now, as we do not find high mountains composed of sedimentary strata, excepting the strata be of vast extent and thickness, it is reasonable to infer that these sedimentary rocks are not confined to the island, but extend far under the ocean bottom. It is also a self-evident truth that these sediments must have been derived from a pre-existing land of great area, probably continental. The curious in such matters may speculate whether it lay to the north, south, east or west. As there is at present absolutely no data to go by, each inquirer may solve it in a way to suit his own views best, which is comforting.

If the foregoing reasoning be admitted as valid, it not only reclaims a very large area of land from the ocean, but strikes a vital blow at the "permanency" hypothesis, as built up on the supposed non-sedimentary character of oceanic islands.

I have in former Numbers of this MAGAZINE given my views on the untenability of the reasoning in favour of Permanence of Oceans and Continents,<sup>2</sup> and a somewhat similar class of arguments to mine and to the same end have since been advanced by Mr. W. O. Crosby.<sup>3</sup>

It would be interesting to have soundings round the island, to see if the mountain range extends under the sea as a submarine ridge.

It may be added, that no land mammals were found on the island. Their absence has been held by Mr. Wallace to prove that such islands were ever islands. It has always appeared to me that this generalization—hinging as it does on negative evidence—has been elevated into too much importance.

---

## REVIEWS.

---

### DR. J. PETERSEN ON SOME CHEVIOT ROCKS.

MIKROSKOPISCHE UND CHEMISCHE UNTERSUCHUNGEN AM ENSTATIT-PORPHYRIT AUS DEN CHEVIOT HILLS. Inaugural Dissertation von JOHANNES PETERSEN. (Kiel, 1884.)

**T**HE specimens which Dr. Trechmann collected during my second visit to the Cheviot district were forwarded by him to Prof. Rosenbusch, and form the material on which the observations recorded in this communication are based. Coming as it does from one of the first petrological laboratories in the world, we are not

<sup>1</sup> Report on the Petrology of St. Paul's Rocks, by M. Renard (Challenger Reports). Récifs de St. Paul, par M. Renard, Annales de la Société belge de Microscopie.

<sup>2</sup> Oceans and Continents, GEOL. MAG. Sept. 1880, p. 385, and Oceanic Islands, Feb. 1881, p. 75.

<sup>3</sup> Origin of Continents, GEOL. MAG. Decade II. Vol. X. June, 1883.

surprised to find that it contains work of the very highest order. As the rocks have already been described to some extent by myself in the pages of the GEOLOGICAL MAGAZINE, it will probably interest readers to know how far the observations of Dr. Petersen tend to confirm my own, and how far they are opposed to them. It may be as well to state at the outset that the rock which I first recognized as belonging to the group of the so-called augite-andesites, and subsequently ventured to call hypersthene-andesite, when Prof. Rosenbusch had taught me how to recognize the rhombic pyroxene, is denominated by the author enstatite-porphyrite. The term enstatite being selected as the representative of the entire group of rhombic pyroxenes, and the term porphyrite being given to the rock because it is of Pre-Tertiary age.

The fresh rock ("pitchstone porphyrite" of the older authors) is described as follows. In a black, or brownish-black ground-mass, having a pitchy or greasy lustre, lie glassy feldspars, with sharp boundaries, which are usually elongated in the direction of the *a*-axis and which often show twin-striation. A pyroxenic mineral is not clearly recognizable by macroscopic examination. Narrow brick-red veins traverse all the specimens examined by the author. Thin sections of this rock show under the microscope hematite, magnetite, apatite, pyroxene, feldspar, and a glassy base. The pyroxene, which is by far the most interesting constituent, belongs to two crystal systems, the monoclinic and rhombic; the latter form largely predominating.<sup>1</sup>

The rhombic pyroxene is described in detail, but it will only be necessary here to call attention to certain points not referred to by myself. The author observed in many cases brown or black leaf or rod-like interpositions which are arranged parallel to the vertical axis. He describes also a well-marked pinacoidal cleavage, which I was not able to make out. The pleochroism referred to the crystallographic axes is thus described: rays vibrating parallel to the *c*, *b*, and *a* axes are green, yellow, and reddish-yellow respectively. The polarization tints of the rhombic pyroxene are dull, whereas those of the monoclinic mineral are bright. The author agrees with Becke in regarding this as an important means of distinguishing between the two pyroxenes.

After separating the two pyroxenes from the other constituents by means of the Sonstadt solution, the author succeeded in obtaining the rhombic mineral in a state of great purity by means of the solution of borotungstate of cadmium. It was found that in a concentrated solution of the latter salt both varieties swam, but that by slight dilution the rhombic mineral was caused to fall whilst the other floated. One gramme of the mineral thus isolated, having a specific gravity of 3.331, gave the following analysis. I add my own analysis by way of comparison:—

<sup>1</sup> It seems hardly necessary to give additional evidence of the distinctness of these two pyroxenes. I may mention, however, that I have recently mounted a specimen of the monoclinic mineral, so that I can rotate it round the *c*-axis under the microscope. It is green in colour, and does not show a trace of pleochroism in any position.

		I. (P.)		II. (T.)
SiO <sub>2</sub>	... ..	52·53%	... ..	53·06
Al <sub>2</sub> O <sub>3</sub>	... ..	3·38	... ..	4·90
FeO	... ..	9·89	... ..	16·62
MgO	... ..	26·66	... ..	19·64
CaO	... ..	6·19	... ..	4·09
H <sub>2</sub> O	... ..	0·26	... ..	—
		98·91		98·31

The author concludes that his analysis indicates bronzite. Comparing the two analyses, he considers that the differences may be accounted for on the assumption that I analyzed a mixture of the two pyroxenes. This view appears to me improbable for two reasons: (1) the microscopic examination of the material which I analyzed showed it to be remarkably pure, although, as the author states, I took no special steps to remove the monoclinic augite; (2) the amount of lime in my analysis is less than that in his, a fact which seems in itself conclusive against the view which he suggests. A comparison of the two analyses to my mind leads rather to the conclusion that the mineral varies in composition in different portions of the same rock, or at any rate in different specimens from the same district.

His analysis is especially interesting to me, because it tends to confirm an opinion that I was led to form after isolating the pyroxene of the Steinerne Mann rock, viz. "that lime enters more largely into the composition of some of these rock-forming hypersthènes than the earlier analyses of this mineral would lead one to expect." (GEOLOGICAL MAGAZINE, 1883, p. 346.)

The monoclinic augite is then described. The boundaries in the prismatic zone are not so sharp as in the bronzite; indeed, the mineral occurs rather in the form of crystalline grains. Longitudinal sections show parallel cleavage cracks; cross sections indicate both prismatic and pinacoidal cleavage. There is no trace of pleochroism. The maximum extinction angle in the prismatic zone is 44° (this is exactly the figure obtained by myself).

The polarization tints as a rule belong to a higher position in Newton's scale than those of the bronzite. The rod-like interpositions, so frequent in the bronzite, are entirely absent from the monoclinic augite. Twinning parallel to the orthopinacoid is frequently present.

The author then makes one very interesting observation which I can fully confirm, although I had not observed it at the time my paper was written. Intergrowths of augite and bronzite are not unfrequent.<sup>1</sup> The bounding surfaces are irregular, and the cleavage cracks are parallel to each other in the two pyroxenes.

The bronzite was formed before the augite according to the author. In one instance, he observed a bronzite crystal completely surrounded by augite.

The felspar belongs to two, if not three generations. The larger

<sup>1</sup> Tripke recognized intergrowths of enstatite and diallage in the olivine inclusions in basalt. Orthopinacoidal lamellæ of diallage are in this case arranged parallel to the macropinacoid of the enstatite. Naumann-Zirkel, *Elemente der Mineralogie*, 1881, p. 598.



felspars were isolated and analyzed, and my determination of them as labradorite is confirmed. Their specific gravity lies between 2.70 and 2.65.

The constituents of the ground-mass comprise microlites of pyroxene, felspar, small crystals of hematite and magnetite, together with globulites, longulites, belonites, and other devitrification products.

The ultimate base is perfectly isotropic; but after heating a thin slice on platinum foil, it gives a distinct reaction with polarized light. Inasmuch as the natural glass contains water, we appear to have in this most interesting experiment a proof of the conclusion that the passage from the glassy to the crystalline condition is at any rate in certain instances dependent on a loss of water.

The glassy base was isolated by the author and analyzed by R. Ebert. Sp. gr. 2.437.

SiO <sub>2</sub>	...	...	...	...	66.25
Al <sub>2</sub> O <sub>3</sub>	...	...	...	...	13.59
Fe <sub>2</sub> O <sub>3</sub>	...	...	...	...	3.11
CaO	...	...	...	...	2.75
MgO	...	...	...	...	0.28
K <sub>2</sub> O	...	...	...	...	4.95
Na <sub>2</sub> O	...	...	...	...	2.25
H <sub>2</sub> O	...	...	...	...	5.89

---

99.07

Some interesting chemical observations were made upon the red veins (see *GEOL. MAG.* Decade II. Vol. X. p. 106). When these veins are wide (1 mm.), the central portion is colourless; the marginal portion is always a deep red. The specific gravity of the clear substance is 2.440, and the amount of water 2.89 per cent.; specific gravity of the red substance 2.071, and amount of water 7.07 per cent. Qualitative analysis in both cases furnished only silica, ferric oxide and water. The clear substance is therefore chalcedony; the red substance opal.

Microscopic examination shows that the veins do not arise through the alteration of the surrounding rock, which is perfectly fresh, even up to the junction.

The altered rocks or normal porphyrites are then referred to. Some of these are undoubtedly the altered representatives of rocks similar in mineralogical composition to the "pitchstone-porphyrity" (my hypersthene-andesite). I do not think however that they were identical in composition with this rock. My own view is that they (I am speaking now only of those rocks which I regard as having been in the first instance hypersthene-andesites) differed originally in the physical condition or chemical composition of the ground-mass by reason of which they were more readily affected by the agents of alteration. The author does not seem to be aware that the fresh rock is completely subordinate to an immense development of normal porphyrite which shows traces of alteration throughout its entire mass. Had the hypersthene-andesite been equally liable to alteration, I do not think it would have been preserved. The green mineral which results from the alteration of the pyroxene

received the author's careful attention. It is a leafy fibrous substance polarizing with a beautiful blue tint and showing marked pleochroism—emerald green to yellowish green. The polarization is not uniform, the different fibres giving different tints. This mineral is associated with carbonates and small colourless strongly refracting grains which may be regarded as quartz, also with other strongly refracting grains of a yellow colour.

The green substance gelatinizes with hydrochloric acid. Examined by means of convergent light, the leaves of which it is composed show a bisectrix with a not inconsiderable axial angle. The yellow grains associated with the green substance were carefully considered by the author. Precisely similar grains associated with chlorite in a diabase-porphyrity from Bocksteinwald were examined qualitatively by the micro-chemical methods due to Bořický<sup>1</sup> and Behrens.<sup>2</sup> Lime, iron, alumina and silica were determined, and the conclusion arrived at that they are epidote.

The chloritic substance was purified as far as possible and analyzed with the following results.

		I.		II.
SiO <sub>2</sub>	... ..	38·24	... ..	39·98
Al <sub>2</sub> O <sub>3</sub>	... ..	23·15	... ..	19·05
FeO	... ..	12·99	... ..	15·18
CaO	... ..	6·40	... ..	3·46
MgO	... ..	8·13	... ..	13·77
H <sub>2</sub> O	... ..	10·21	... ..	9·14
Na <sub>2</sub> O	... ..	trace	... ..	—
		99·12		100·58

The differences in the analyses are attributed to the difficulty of obtaining pure material and to experimental errors due to the small quantity available for analysis— $\frac{1}{2}$  gramme.

These results lead to the conclusion that the substance analyzed was a mixture of chlorite, epidote and silica with water. As the chlorite is biaxial, it is regarded as clinocllore. In the altered rocks the base is doubly refracting. It is regarded as having been produced by the devitrification of a glass similar to that of the unaltered rock.

The base of one of the slightly altered rocks from a point two miles up Allerhope Burn was isolated and analyzed.

SiO <sub>2</sub>	... ..	65·16
Al <sub>2</sub> O <sub>3</sub>	... ..	17·49
Fe <sub>2</sub> O <sub>3</sub>	... ..	3·01
CaO	... ..	0·84
MgO	... ..	2·34
Na <sub>2</sub> O	... ..	3·68
K <sub>2</sub> O	... ..	5·54
H <sub>2</sub> O	... ..	1·76

99·82    Sp. gr. 2·640

<sup>1</sup> Bořický, Elemente einer neuen chemisch-mikroskopischen Mineral und Gesteins-analyse. Prag, 1877.

<sup>2</sup> Behrens, Mikrochemische Methoden zur Mineralanalyse. Neues Jahrbuch; Ref. Band II. 1882.

On comparing this with the analysis of the base of the unaltered rock, it is seen that the per-centage of water is much less. The specific gravity of the altered base is higher.

The author then gives analyses of the normal porphyrites.

	I.	II.	III.	IV.
SiO <sub>2</sub> ... ..	63·0 ... ..	61·17 ... ..	64·2 ... ..	59·05
Al <sub>2</sub> O <sub>3</sub> ... ..	14·9 ... ..	16·87 ... ..	16·0 ... ..	15·69
Fe <sub>2</sub> O <sub>3</sub> ... ..	4·7 ... ..	2·10 ... ..	4·3 ... ..	1·80
FeO ... ..	— ... ..	2·94 ... ..	— ... ..	4·72
CaO ... ..	4·8 ... ..	4·86 ... ..	1·7 ... ..	1·79
MgO ... ..	2·8 ... ..	3·00 ... ..	2·5 ... ..	4·29
K <sub>2</sub> O ... ..	1·9 ... ..	1·81 ... ..	5·9 ... ..	2·88
Na <sub>2</sub> O ... ..	4·0 ... ..	2·67 ... ..	2·9 ... ..	3·97
H <sub>2</sub> O ... ..	4·0 ... ..	3·09 ... ..	3·3 ... ..	3·16
	100·1	98·51	100·8	97·45
Sp. gr. ... ..	2·54 ... ..	2·543 ... ..	2·56	

I. Coquet  $\frac{1}{4}$  m. above Windy Haugh (T. Waller, *GEOL. MAG.* Dec. II. Vol. X. 108):

II. Carhope on Coquet (Petersen).

III.  $\frac{1}{2}$  m. above Shillmoor Farm, Coquet (T. Waller, *GEOL. MAG.* Dec. II. X. 151).

IV.  $\frac{1}{4}$  m. above Shillmoor Farm, Coquet (Jäger).

In discussing analysis III. the author is under the impression that I regard the rock as derived from the hypersthene-andesite by alteration. This is not the case. He has entirely misunderstood the sentence in which I refer to this analysis, and I agree with him that the opinions he attributes to me are inconceivable.

We now have to consider the question of nomenclature, and as this is a point of considerable importance, it will be as well to allow the author to speak for himself, as far as this is possible in a translation:—

“I take the liberty of adding a few words to justify the designation of the described rock as enstatite-porphyrite. When the rock is fresh, Mr. Teall calls it an andesite; when it is altered, a porphyrite. In my opinion it is inadmissible to give a different name to different hand-specimens obtained from the same rock-mass according to the state of freshness of the components. Mr. Teall himself acknowledges that the porphyrites are in the main only altered andesites. In his first paper he defines the andesite more particularly as an augite-andesite; in his paper in the April Number of the *GEOL. MAG.* he introduces the term hypersthene-andesite. In defence of the term andesite he points out that the rock has the closest resemblance to the Santorin lavas, characterized as andesites by Fouqué. This resemblance certainly exists to a large extent. The name “andesite” has, however, so far only been applied to younger Tertiary or Post-Tertiary rocks. Mr. Teall makes use of this name for a rock which he speaks of as in all probability belonging to the Old Red Sandstone period. In justification of this, the argument is advanced that a petrologist ought to be in a position to define a rock regardless of its age, as it is frequently difficult to determine the latter.

“In my opinion this is unnecessary. Just as it is the problem of the palæontologist to determine the age of sedimentary deposits, so is it an important question for the petrologist to determine the

relative age of the rocks under his consideration; otherwise petrology would speedily cease to be one of the most important branches of geological teaching, which it at present undoubtedly is. That a difference in age should, to a certain degree, find expression in nomenclature, I hold to be quite justifiable; for it is in almost every case accompanied by a great difference of general habit, and in part even of mineralogical constitution—a case in point is for instance the restriction of hauyne and leucite to the Tertiary period.

“It cannot be denied that it is frequently very difficult to decide upon the age of eruptive rocks, and that occasionally it may be impossible to do so; yet the present status of petrology enables us, by comparison with other well-known rocks, in most cases to arrive at a very probable—if not a perfectly precise—determination of the age.

“Really doubtful cases, whether a rock be Pre- or Post-Tertiary will be very rare, and for such we do not require a new classification and nomenclature which leaves geological age out of consideration.”

The first point which requires notice in the above quotation is the one raised with reference to the meaning which is to be attached to the term porphyrite. In the Cheviot district we have an immense development of rocks to which every one would apply the term porphyrite. These are all of them more or less altered. Indeed it is their alteration which gives them many of their distinctive characters. These porphyrites are sharply to be distinguished from the rock which I have called hypersthene-andesite, although some of them are undoubtedly due to the alteration of a rock of similar mineralogical composition. Inasmuch as these altered rocks have a distinct character of their own, I see no objection to giving them a distinct name. The author seems to consider that under no circumstances should pathological characters be used for purposes of petrological classification. On this point I cannot agree with him. If the altered rocks have a definite character, in virtue of their alteration, and are widely distributed in space, I see no reason why they should not receive a distinct name. The principle is well established in geological nomenclature, as, for instance, in the use of the term serpentine.

I may say, *en passant*, that I have seen among porphyrites rocks that I should describe as altered augite-hypersthene-hornblende-and mica-andesites.

The next point referred to is the use of the term andesite. It is with very great pleasure that I see the author admits the resemblance between the unaltered rock and modern andesites. No attempt is made to show that there is any essential distinction either in structure or composition. This reduces the difference between us to the simple question—should geological age in itself be made a point of classificatory value in petrology? On this point I feel compelled to differ from the author.

He says, “Just as it is the problem of the palæontologist to determine the age of sedimentary deposits, so is it an important question for the petrologist to determine the relative age of the

rocks under his consideration." I hold that it is not the primary duty of the palæontologist to determine the age of rocks. His primary duty is to describe the relations of the forms of life with which he has to deal with other forms, both living and extinct, and to define his genera, species, etc., without reference to geological age. It then becomes his duty to ascertain the distribution of his types both in space and time, and in this branch of his work he is led to the conclusion that certain types are limited in their vertical range, and become therefore most valuable for purposes of chronology, whereas other types are persistent and range through several geological periods. He does not fix on some arbitrary period and assert that one and the same type shall receive two different names according as it occurs on the one or other side of his selected line. If a Trilobite were discovered in Secondary or Tertiary formations, or if it were found living at the present day, it would still be called a Trilobite.

Now I consider that a petrologist should deal with his rocks in precisely the same way. His primary duty is to describe his rocks and define his types in the clearest possible manner, but without reference to age. The introduction of geological age for this purpose is unnecessary if there be a radical distinction between all the Pre-Tertiary and later rocks; and if in certain cases there be not this distinction, then its introduction obscures natural differences and implies relationships which do not exist. If, after having defined his types, the petrologist discovers that some of them are limited as to their range in time, then these may be utilized for chronological purposes. As a matter of fact, there are certain types which appear to be limited in their range, and other types which are persistent. The case is to a certain extent analogous to that of the palæontologist. It must be remembered, however, that the history of geological science shows clearly that petrology is not a very safe guide in the determination of chronological relations. It will be seen then that such cases as the existence of leucite and haüyne only in Tertiary rocks has nothing to do with the question at issue between us. Where there are differences between Pre-Tertiary and later rocks, these differences can be utilized for purposes of classification.

As the question is one of so much importance, I will endeavour to put my position from another point of view.

The whole fabric of science is constructed on the assumption, justified by experience, that the causal relations of natural phenomena are independent of situation in space and time. Given similar conditions, similar phenomena occur. Now it seems to me that the refusal to give the same name to two rocks which are similar in structure and composition, merely because they have been produced at two different periods, is equivalent to denying the uniformity on which the whole of science is based. It could only be justified, at least so it seems to me, and it must be distinctly understood that I am only endeavouring, with all diffidence, to make my own position perfectly clear, by the assumption that an entire

change in the order of nature occurred in the interval which elapsed between the Cretaceous and Tertiary periods. Holding these views, it is of course impossible for me to acquiesce in the principle accepted by the author, because it appears to me to lead to the giving of *two names to one and the same thing*.

In discussing this question, I have carefully avoided any expression of opinion as to the nature of the differences between Pre-Tertiary and later igneous rocks. I hope to deal with this question independently on some future occasion. J. J. HARRIS TEALL.

---

## REPORTS AND PROCEEDINGS.

---

### GEOLOGICAL SOCIETY OF LONDON.

I.—March 19th, 1884.—Professor T. G. Bonney, D.Sc., F.R.S., President, in the Chair.—The following communications were read :

1. "On *Rhytidosteus capensis*, Owen, a Labyrinthodont Amphibian from the Trias of the Cape of Good Hope." By Sir Richard Owen, K.C.B., F.R.S., F.G.S.

The author first noticed the discovery of certain forms of Amphibia belonging to the genera *Labyrinthodon*, *Brachyops*, *Petrophryne*, and *Rhinosaurus*, and called attention to certain typical peculiarities in the structure of the teeth, the form of the bony palate and the double occipital condyle.

An imperfect cranium of the species now described as *Rhytidosteus capensis* was procured by Heer Swanepoel, from the Trias on his farm at Beersheba, near Smithfield, in the Orange Free State, and deposited by him in the Bloemfontein Museum.

This specimen, which was brought to England and submitted to the author by Dr. Exton, consists of the anterior portion of the skull with part of the mandible attached. The general form is batrachoid, and one of the hinder palato-vomerine teeth, on being examined microscopically, exhibited the characteristic labyrinthodont structure.

The surface of the skull, and the characters of the premaxillary, nasal, frontal, and prefrontal bones were described. The parietals and postfrontals are imperfect, the hinder part being lost. The rami of the mandible are also imperfect behind, but a broken fragment shows the articular surface. The vomerine bones were also described, with the posterior nostril and the teeth before and behind this opening. The breadth of the bony palate at its hinder fractured border is 5 inches ; the length of the part preserved  $4\frac{1}{2}$  inches ; the mandible, when perfect, was probably from 11 inches to a foot in length. The author also gave an account of the dentition wielded by the premaxillary, maxillary, vomerine, palatine and mandibular bones.

The author pointed out that the type of air-breathing vertebrates to which the present genus belongs reached its highest development in the Triassic period in Britain, Russia, North America, Hindostan, and South Africa. The only known antecedent form from which

the labyrinthodont structure of tooth might have been derived is a genus of fishes named *Dendrodus*, in the Old Red Sandstone. The Liassic Ichthyosaurs also show some similarity in tooth-structure; but in them there is far greater simplicity.

2. "On the Occurrence of Antelope-remains in Newer Pliocene Beds in Britain, with the Description of a New Species, *Gazella anglica*." By E. Tully Newton, Esq., F.G.S.

Part of the skull and horn-core of a small cavicorn Ruminant, which had been obtained by Mr. H. B. Woodward from the Norwich Crag of Thorpe, was described, the chief points noticed being the almost erect position of the horn-core upon the frontal bone, its oval section and enlargement just above the pedicle, the presence of a deep pit on the outer side of the pedicle, and a well-marked frontal fossa, from which a large foramen passed directly into the orbit. The frontal suture being well preserved, the precise direction of the horn-cores could be ascertained.

The presence of a frontal fossa with a foramen passing directly into the orbit, was held to indicate an affinity with the Antelopes; and after comparison with the available recent specimens in the British Museum and Royal College of Surgeons, it was regarded as most near to the Gazelles,—*Gazella dorcas*, *G. subgutturosa*, *G. picticauda*, and *G. Bennettii*, being most like the fossil, and agreeing with it in having the skulls more or less compressed in the frontal region, nearly upright horns, and a well-marked frontal fossa and foramen, but differing in the form of the fossa and in the position of the pit on the pedicle. On the whole *G. Bennettii* was regarded as nearest to the fossil.

The perfect condition of the frontal bone allowed a cast of the interior to be taken, which reproduced the form of the frontal lobe of the brain, and it became possible therefore to compare this part of the fossil with the brains of recent forms, which was then done, special reference being made to the casts taken from *Gazella picticauda* and *G. Bennettii*. In the form of the convolutions of the frontal lobe, *G. Bennettii* was again found to be the most like the fossil.

Among the known fossil forms only a few were thought sufficiently near to render a comparison with them necessary; the following, however, were mentioned, and attention called to the points in which they differed from the Norwich specimen, namely *Antilope deperdita*, *A. brevicornis*, *A. porrecticornis*, *Tragoceros Valenciennesi*, and *Palæoryx parvidens*. Seeing that all the important characters of this fossil are found among the recent Gazelles, it is referred to that genus; but as it differs in certain points from each of them, it is necessary to give it a new specific name; the author therefore called it *Gazella anglica*.

Fortunately this interesting discovery is corroborated by two other similar examples of horn-cores with frontals from the same locality and horizon. One of them is in the British Museum, and the other in the possession of Dr. Arthur King, of Norwich.

A short appendix, by Mr. H. B. Woodward, on the horizon from which these fossil Gazelles were obtained, was also read.

3. "A Comparative and Critical Revision of the Madreporaria of the White Lias of the Middle and Western Counties of England, and of those of the Conglomerate at the Base of the South-Wales Lias." By Robert F. Tomes, Esq., F.G.S.

After referring to previous memoirs on the subject by MM. Tawney, C. Moore, Tate, and Bristow, and to the conflicting conclusions arrived at by those geologists, the author insisted that the Madreporaria are not necessarily contemporaneous with the beds in which they are found imbedded. He took exception to some of the identifications of these forms by Dr. Duncan, and suggested that their nearest analogues are to be found in the St. Cassian beds.

The few and imperfect corals of the White Lias of Warwickshire, the author believes to have resemblances with the coral fauna of the Sutton Stone on the one hand, and the St. Cassian beds on the other. The Mollusca found in the same beds, however, are those of the zone of *Ammonites angulatus*.

While the Brocastle Conglomerate is, according to the author, a local deposit with uncertain relations, the Sutton Stone is a much more regular stratum, and is quite distinct from the conglomerate which immediately overlies it, and which is seen at Southerndown. He regarded the Sutton Stone as the equivalent of the White Lias, and of Rhætic, not Liassic age.

The revised list of corals found in the St. Cassian beds, the White Lias, the Sutton Stone, and the Brocastle Conglomerate respectively, shows, according to the author, that nearly all the White-Lias forms occur at St. Cassian; that a certain number of the Corals of those two formations occur also in the Sutton Stone, but that none of them occur at Brocastle; and, furthermore, that the coral faunas of Sutton are quite distinct.

In conclusion, the author contested the views of the late Mr. C. Moore concerning the existence of a series of conglomerates below the base of the Sutton Stone, and insisted that the presence of a Hettangian molluscan fauna in these beds and the White Lias is not sufficient to counterbalance the evidence of Rhætic affinities afforded by the corals. The Brocastle Conglomerate, however, contains corals with Liassic affinities.

Detailed descriptions of the new species of corals formed the conclusion of the paper.

II.—April 2, 1884.—Prof. T. G. Bonney, D.Sc., F.R.S., President, in the Chair.—The following communications were read:—

1. "The Rocks of Guernsey." By the Rev. E. Hill, M.A., F.G.S. With an Appendix on the Microscopic Structure of some of the Rocks, by Prof. T. G. Bonney, D.Sc., F.R.S., Pres. G.S.

The southern part of the island is a high plateau consisting entirely of gneiss. This is very coarse, and the bedding is seldom well marked. The bedding, when visible, coincides with the foliation, and the author hopes that hereafter an order of succession may be established. At Rocquaine Castle occur a few slaty beds intercalated in the gneiss, the origin of which is somewhat difficult to understand.



The northern part, low ground with hummocks, consists principally of a group of crystalline or subcrystalline rocks, in constitution diorites or syenites. They are described by Ansted as sedimentary rocks metamorphosed into syenites; but they show no bedding either in the many quarries, or, in general, in the shore outcrops, nor do their varieties occur in any manner indicating an order of succession. They appear at Castle Cornet to meet the gneiss intrusively, and their microscopic structure is igneous. A remarkable appearance of bedded structure at Fort Doyle is the only strong argument for a metamorphic origin, and this may be explained as a caught-up mass in conjunction with crushing-planes. The author therefore regards them as igneous.

An oval area between St. Sampson's and St. Peter's Port is occupied by hornblendic rocks, locally called "birdseye," which may be described as hornblende-gabbros. These also have been called metamorphic. They too, at Hogue-à-la-Perre and at another point, present appearances of bedding; but on the same general grounds as for the preceding group, these also are regarded as igneous.

Two granitic masses are described: the coarse pink granite of Cobo, on the west coast, and the finer-grained grey granite weathering pink of Lanresse, on the north. Each is seen to intrude: the Cobo granite into gneiss at Hommet Barracks; the Lanresse granite into diorite at Fort le Marchant. Besides these are some smaller masses.

Dykes are remarkably abundant and various. Granites and elvans are plentiful everywhere; felsites very rare. The majority of the dykes are diorites, varying in coarseness and often of enormous size; there is also mica-trap. In some of these dykes a cleavage has been developed, so that some resemble slates. Infiltration veins are abundant.

In relative age the gneiss appears to be the oldest rock, the hornblende-gabbro to be next, then comes the diorite group, while the granites are newer still. Of the dykes the newest are the compactest diorites. As to the absolute geological age of the rocks no satisfactory evidence at present is known; it will have to be sought for in the other islands and in France.

2. "On a New Specimen of *Megalichthys* from the Yorkshire Coal-field." By Prof. L. C. Miall, F.G.S.

A large and unusually complete example of this fish was recently found in the roof of the Halifax Hard bed, at Mr. S. B. Ellison's Firebrick works, Idle, near Leeds. The fossil is in good preservation, the ventral surface is uppermost, the pectoral, ventral, anal, caudal fins can be more or less satisfactorily made out; the dorsal surface is absent. The length is 3 feet 8½ inches, of which the head measures about 10 inches, and the tail (from the end of which 5 or 6 inches may be wanting) about a foot. Judging by the large skull figured by Agassiz and preserved in the Leeds Museum, *Megalichthys* may have attained a length of from 4 to 5 feet.

The skull shows the mandible and mandibular teeth, the end of the snout, the opercula, and the jugular plates. The pectoral fins

show the obtuse lobate character, previously suspected by Huxley to obtain in this genus. Large basal scales lie on each side of each pectoral fin.

The ventral fins are abdominal. The right, which is best preserved, exhibits the arrangement of the scales which is described, and which gives a clue to the disposition of the underlying bones or cartilages. This must have closely resembled that in some Elasmobranchs. The same type of fin may be traced, though with important modifications, in *Polypterus*, *Polyodon*, and *Acipenser*, whilst in other recent Ganoids and in Teleostei the arrangement is widely different.

Between the ventral fins are three large scales, one median and two lateral. On the left side of the median scales lies what appears to be the anus. A similar arrangement seems to occur in *Pterichthys*. This region is rarely exposed in fossils.

The anal fin has also its pair of large basal scales. The caudal fin cannot be well made out. There are indications of the underlying skeleton, but nothing can be distinctly made out.

All the features of the present fossil confirm the opinion long ago expressed by Pander and Huxley as to the near affinity of *Megalichthys* to *Osteolepis* and *Diplopterus*.

3. "Studies on some Japanese Rocks." By Dr. Bundjiro Kotô. Communicated by Frank Rutley, Esq., F.G.S.

The author has studied a series of Japanese rocks from the collections of the Tokio University and the Geological Survey of Japan. The microscopical investigation was carried on at the Mineralogical Institute of Leipsic, under the direction of Prof. Zirkel, and the chemical analyses were made in the laboratory of Prof. Knop.

The most abundant rocks are the pyroxene-andesites, which are not of a glassy texture, but for the most part holocrystalline. The most abundant mineral in these rocks is a plagioclase felspar with twinned and zonal structure, which is proved by its extinction-angles and by the chemical analysis of its isolated fragments, to be labradorite. Sanidine is present in small quantities.

The augites of these rocks present many peculiarities; they are all decidedly pleochroic; and they exhibit the oblique extinction in basal sections, first pointed out by Mr. Whitman Cross, and which is characteristic of triclinic and not of monoclinic crystals. A careful examination of the question has led the author to conclude that the mineral, which has lately been regarded as a rhombic pyroxene (probably hypersthene), is really only ordinary augite cut parallel to the optic axis. He does not regard the property of pleochroism as distinctive of hypersthene, while the absence of a brachypinacoidal cleavage and the presence of 10 per cent. of lime in the mineral forbids our referring it to that species.

The other abundant minerals in these augite-andesites are magnetite, which is always present, and quartz, which occurs in some of them, both as a primary and a secondary constituent. Hornblende is very rare in these rocks, and when present the peripheral portions of the crystals are seen to be converted into augite, probably by the action of the caustic magma upon them. Enstatite is rare in these

rocks, but apatite is always found in them, while tridymite occurs not unfrequently.

The author described a number of structural variations in the augite-andesite from different localities. Among the most interesting is a variety containing as much as 69 per cent. of silica.

Among the less abundant rocks are the enstatite-andesite, the quartz-augite-andesite, and the hornblende-andesites. The plagioclase-basalts of Japan can only be distinguished from the augite-andesites by the presence in them of olivine. Magma-basalts are rare, most of the varieties being of the dolerite type; but under the name of "basalt-lavas" the author describes varieties with a glassy base.

In an Appendix some account is given of a number of pre-Tertiary rocks, including granite, one variety of which contains the new mineral, reinite, of Fritsch (the tetragonal form of the ferrous-tungstate), quartz-mica-diorite, diorite-porphry, and diabase.

---



---

## CORRESPONDENCE.

---

### REPLY TO PROFESSOR LINDSTRÖM.

SIR,—I am much obliged to Prof. Lindström for giving a correct translation of the generic diagnosis of *Pholidophyllum*. He has possibly a right to complain that in my communication to the Geological Society the word *likformigt* was translated *like-formed*, but I am free to confess that I do not understand the term which he uses, "homogeneous stereoplasma." With regard to the unfortunate mistakes in the spelling of generic names, I find, thanks to Mr. Dallas, that my manuscript is still in existence, and that I was correct. My reliance on the able reader of the printers of the Society was unfortunately in this instance impossible, for he was taken from amongst us. Hence the errors in print.

Prof. Lindström, when he comes over to England, will find at the Museum in Jermyn Street, and at the British Museum, specimens of what he calls *Pholidophyllum* from the Upper Silurian of England. On the other hand, he will find specimens of all the species of *Palæocyclus*, Ed. and H., without a trace of the characteristic exothecal (or whatever they may be) structures of *Pholidophyllum*. In many the outside is so well preserved that there is no trace of the structures any more than there is to the eye in the lithograph, fig. 20, plate viii. of Prof. Lindström's work on the Operkelbärande Koraller, Stockholm, 1882. I have looked into the subject with some care, and I still believe that his curiously covered corals are not of the same genera as those described by Edwards and Haime. Those authors do not mention these structures, which would have been palpable enough to their sight if they had existed in their forms.

But there is another way of looking at the question, which interferes with the value of *Pholidophyllum* as a genus. What is the true

meaning and what is the classificatory value of these exterior bodies, which I find also in the mud filling up the calices? As soon as time will permit, and drawings can be made, I will trouble you with my views on these questions.

P. MARTIN DUNCAN.

---

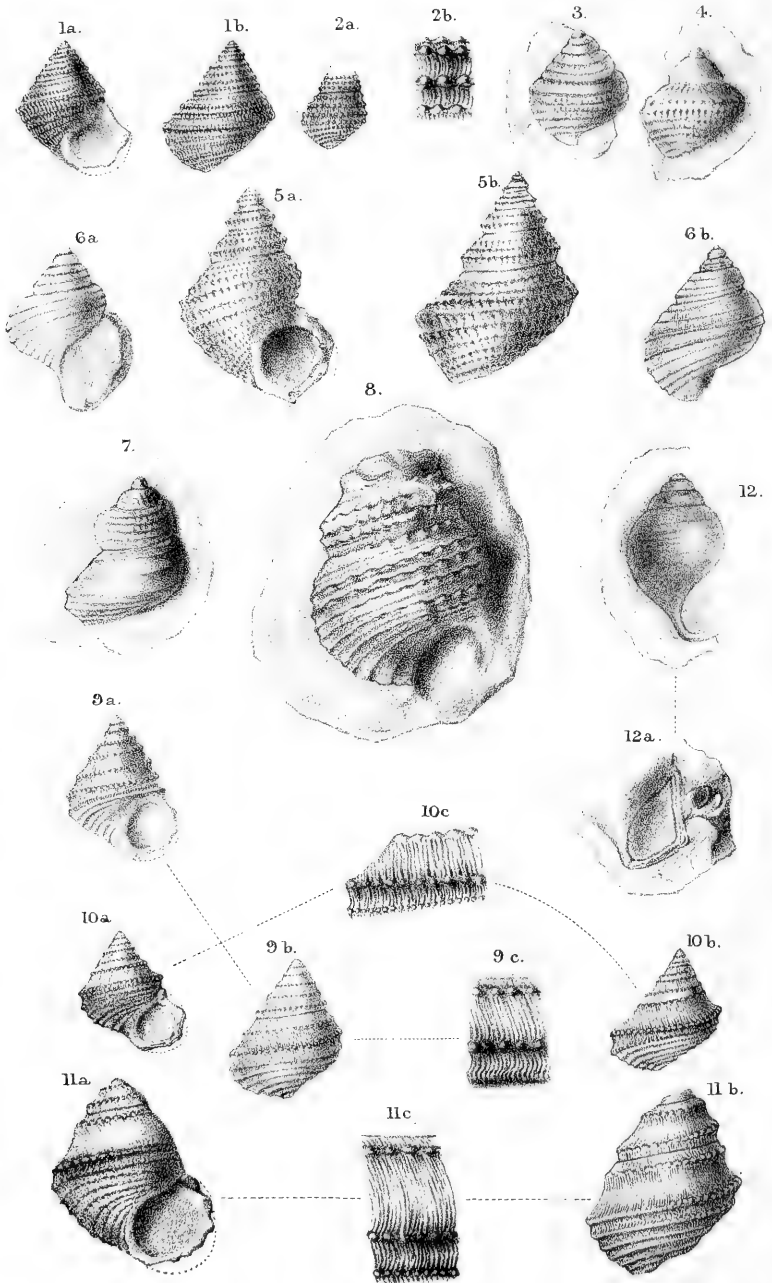
THE COMPLETION OF THE ONE-INCH MAP OF THE GEOLOGICAL SURVEY OF ENGLAND AND WALES.

SIR,—An interesting article on the above subject appeared in the "Times" of February 15th, and was reprinted in "Nature" of the following week. No fault can be found with its general accuracy, but I shall be glad to be allowed to say a few words on some omissions that deserve notice.

It is obvious that the goodness of a geological map depends largely on the accuracy of the Ordnance Map on which the geology is placed. No mention, however, is made in the above article of the fact that the one-inch Ordnance Map of England and Wales is a work of various periods and of men with very variable standards of accuracy. Now the six northern counties had accurate six-inch and one-inch maps when the geological survey was begun in them, and their geology has been worked-out on the six-inch maps and thence transferred to the one-inch maps. But in the southern counties the geological work has been done on old and inaccurate one-inch maps. Every year new and accurate six-inch and one-inch Ordnance Maps of the counties around London are published, yet there is no allusion in the "Times" article to the desirability of having the geology of the district put upon these new maps. Should any one think this work unnecessary, let him test the matter himself by trying to transfer the geology of some part of Kent or Surrey from the old Ordnance Maps, on which it now appears, to one of the new sheets, and he will soon find he has undertaken an impossible task, and be convinced of the necessity of a resurvey on accurate maps. And as regards the completion of the survey of the superficial deposits, mentioned in the "Times" as one of the things remaining to be done, it is obvious that to do this on old one-inch Ordnance Maps would be simply to waste the time of the Geological Surveyors and the money of the public. Of course it may or may not pay to publish six-inch geological maps of any given area, but the advantages of working on maps of that scale are enormous (even when the production of one-inch maps is the sole object in view) both as regards the amount and the accuracy of information displayed on the latter. When the whole of England and Wales shall have been geologically surveyed on the six-inch scale, and the result transferred to accurate one-inch maps, the duties of the Geological Survey of that part of the United Kingdom will consist simply in keeping the maps up to date—but not till then.

T. V. HOLMES.





A. S. Foord del.

Mintern Bros. imp.

Oxfordian & Lower Oolite Gasteropoda.  
(Yorkshire.)

THE  
GEOLOGICAL MAGAZINE.

NEW SERIES. DECADE III. VOL. I.

No. VI.—JUNE, 1884.

ORIGINAL ARTICLES.

I.—CONTRIBUTIONS TO THE PALÆONTOLOGY OF THE YORKSHIRE  
OOLITES.

By WILFRID H. HUDLESTON, M.A., F.R.S., F.G.S.

(Continued from Decade III. Vol. I. p. 204.)

(PLATE VIII.)

“LITTORINA” and AMBERLEYA.

THE group of shells figured on Plate VIII. (excepting Fig. 12, whose position is doubtful) constitute a natural section of turbinate or trochiform species, which should be classed under one and the same genus, or at most only separated subgenerically. They are characterized, for the most part, by a conical spire, having a rather wide angle; are few whorled, separated by a widish suture, and imperforate. The sculpture is rich, consisting of spiral bands of more or less prominence, which sometimes constitute varices, single or double, as the case may be. These spiral bands are usually granulated or tuberculated, and are continued into the base of the shell, which is convex and much produced. Between these spiral bands is a fine system of axial (radial) lines or striæ, sometimes bifid, and probably forming crenulations in connection with the more prominent spiral ornaments.

The body-whorl exceeds in height the rest of the spire: aperture very large and nearly circular. The outer lip follows the direction of the angle of the shell with little or no curvature as far as the posterior angle, which marks the termination of the most prominent spiral: below this the margin of the aperture sweeps round in a full curve towards the inner lip, which is slightly produced to meet it.<sup>1</sup> The columella is slightly hollowed out, and has a moderate

<sup>1</sup> This producing of the pillar in the direction of the base causes a slight point, which is held by Lycett to remove such a species as *Turbo Phillippsi* from the *Littorinae*. If this be the case, then all the so-called *Amberleyas* must be placed in the same category, and the general name of *Turbo* restored provisionally to the entire group. There are existing species of *Turbo* possessed of an aperture in every respect identical with that which is characteristic of the fossils now under consideration. Nevertheless, Hébert and Deslongchamps appear to have had no hesitation in regarding the pointed extremity of the base as compatible with *Littorina*. (See their description and figure of *Littorina sulcata*, *op. cit.* p. 55, pl. iii. fig. 3.)

callus: the margin of the aperture elsewhere is crenulated, corresponding with the termination of the spiral belts.

These shells, as is well known, were formerly referred—the majority to *Turbo*, some to *Trochus*; until certain authors, notably Deslongchamps in France, and Lycett in England, proposed to place them in the Littorine family. The more elongated forms with salient spiral ornamentation were placed under *Amberleya*, Lycett (= *Eucyclus*, Deslongchamps), whilst the smaller and less belted species received a location under *Littorina*.

This arrangement has generally found favour in England, so that we find Prof. Tate enumerates 10 species of *Eucyclus* and 2 species of *Littorina* from the Yorkshire Lias. Yet there are some authors to whom it does not commend itself, especially amongst Deslongchamps' own countrymen. Terquem and Jourdy, for instance, writing in 1869, describe a fossil said to be rather common in one<sup>1</sup> locality under the name of *Trochus trispidus*, which is evidently an *Amberleya*: in the text they give their reasons for dissenting from the views of Deslongchamps. Brauns, writing the same year, adopts *Littorina* for N. W. Germany. For further remarks on this subject I must refer to the "Corallian Gasteropoda."<sup>2</sup>

The only point for which I contend is, that the group about to be described forms a natural one, and may some day receive a distinctive appellation. The difference between the so-called *Littorina* and *Amberleya* is one of size and outward ornament most probably, rather than of internal structure.

#### 49.—LITTORINA (TURBO) PHILLIPSII, Morris and Lycett, 1850.

Plate VIII. Figs. 1a, 1b.

1850. *Turbo Phillipsii*, Morris and Lycett, Great Ool. Moll. p. 117, pl. 15, figs. 12, 12a, 12b.

1875. *Turbo Phillipsii*, L. and M., Phillips, G. Y. 3rd edition, p. 259.

*Bibliography, etc.*—The authors described this species as coming from the "Great Oolite" near Scarborough. Phillips in his last edition quotes it from the Cornbrash, Grey Oolite of Scarborough, and Millepore Oolite of Cloughton. Quoted by Wright (Q. J. G. S. vol. xvi. p. 30) from the Grey Limestone, and (*vol. cit.* p. 15) from the Dogger. Mr. Leckenby's specimens are on a card marked "Millepore Bed, G. L. Scarbro." The matrix would do for either Millepore Rock, or Scarborough Limestone.

*Description.*—Specimen said to be from the Millepore Bed. Leckenby Collection.

Length, full .....	19 millimètres.
Height of body-whorl to entire shell .....	58 : 100.
Spiral angle .....	68°.

Shell very little longer than wide, conical, pointed. Spire composed of about 5 whorls, of which the body-whorl is much larger

<sup>1</sup> Bathonian of the Moselle, p. 57, pl. ii. figs. 24, 25.

<sup>2</sup> GEOL. MAG. 1880, pp. 533 and 536.



in every way than the rest of the spire. Angle of increase regular, except as regards the keels of the body-whorl, which project beyond. The entire shell is covered with spiral bands having deeply incised granulations: those of the upper whorls are somewhat effaced by usage. The last two whorls are separated by a widish suture; each is furnished with 4 granulated spiral bands, the lowest two being the most prominent; in the body-whorl these almost amount to a double keel; the anterior one is especially prominent, and has large and equal granulations, which are nearly circular. The base of the shell, which is very much produced, is likewise occupied by granulated spiral bands with fine axial striæ in the interspaces.

The aperture is large in all directions; the outer lip is prolonged without curvature as far as the posterior angle, from which the margin is nearly circular, or with a slight flattening towards the base where it meets the point at the termination of the pillar-lip. Doubtless the edges were crenulated to correspond with the termination of the spiral bands.

*Relations and Distribution.*—*T. Phillipsii* is most probably the local representative of the *Turbo Meriani* group, which Goldfuss recognized as occurring on several horizons from the Lias upwards, and which doubtless contains forms varying through successive ages, though in many cases the differences are very little more than those due to size, state of preservation, matrix, etc. The specimens in the Leckenby Collection are mostly smaller than the one figured, which must be regarded as above the average in respect of size.

As regards distribution in Yorkshire, such well-preserved and definite forms are rare, and according to Mr. Leckenby's arrangement, chiefly confined to the Millepore Rock, though we may well expect to find them on higher horizons. I am not at present in a position to say whether there is any representative of the *T. Meriani*-Group in the Lower Oolites of other parts of England, but a shell very similar both in size and ornament to our *T. Phillipsii* occurs in what is stated to be the Brauner Jura, *delta*, of Germany.<sup>1</sup> A form very similar to specimens from the Millepore occurs in the Yorkshire Cornbrash.

50.—LITTORINA, species or variety. Plate VIII. Figs. 2a, 2b.

*Description.*—Specimen from the Dogger (zone 1), Peak (Blue Wyke). York Museum.

Only two whorls are preserved: probable number in the complete spire 5 or 6, with a spiral angle about 45°. Whorls flat, and the penult separated from the body-whorl by a wide suture. The ornaments consist of four granulated spiral bands, differing somewhat in character, the highest being the least prominent: the three anterior bands are of nearly equal strength, but differ in detail, as indicated in Fig. 2b. Base of the shell convex, produced and ornamented with granular spiral bands. The outer lip and margin

<sup>1</sup> Specimens are to be seen amongst the Foreign Jurassic Gasteropoda at the British Museum marked "Brown Jura, *delta*, P. Mohr," and in pencil "*T. ornatus*."

of the aperture are destroyed, but sufficient of the inner lip remains to show the little point at the anterior extremity. Axial lines in the sulci well cut, and very conspicuous in the body-whorl.

*Relations and Distribution.*—This pretty little shell differs from *T. Phillipsii* in its smaller spiral angle, in the sharpness and salience of the granulations and in the greater space between each, though this may be partly the result of difference in condition and matrix. None of the spiral belts approaches a keel in character. It may be the form referred to by Dr. Wright as *T. Phillipsii* (List of Dogger fossils, vol. cit. p. 15). One can hardly fail to notice its resemblance to forms occurring in the Coral Rag of Yorkshire, which are generally classed with the *Turbo (Littorina) muricatus* group, though presenting certain differences. As with *Cerithium muricatum*, so with this great group, forms which occur in the Corallian rocks seem to have been foreshadowed in the Dogger.

The specimen figured is the only one that I have seen.

51.—LITTORINA. Cf. *Phillipsii*, M. and L. Plate VIII. Figs. 3 and 4.

Compare—

*Turbo Phillipsii*, M. and L., ut antea.

*Turbo Meriani*, Goldf. iii. 91, pl. 196, 16.

*Description.*—Specimen from the red-stained Oolite of the Kello-way rock (zone 5), Scarborough. Leckenby Collection. Fig. 3.

The substance is in a great measure gone, leaving a somewhat compressed and indistinct outline of what was once a sharp conical shell with about five whorls, divided by a rather wide suture, and ornamented with granular spiral belts, of which three are traceable, the lowest being the most prominent.

*Another Specimen.*—From the Oxford Clay (zone 6), Scarborough. Leckenby Collection. Fig. 4.

The shell-substance is entirely gone, but there is a very fair cast of the body-whorl with its ornaments: the rest of the spire is completely wrecked. This too was a short conical shell with granulated spiral bands, the lowest being the most prominent. In the base the spiral belts are better preserved and make more show in consequence.

*Relations and Distribution.*—A comparison of these ill-preserved specimens from the Lower Oxfordian of Scarborough, either with the *T. Phillipsii* of the Millepore rock, or with the figures of *T. Meriani* in Goldfuss and D'Orbigny, would be very much like comparing a man in full dress with another who had been rolled in the gutter and his face battered to pieces. There is a general resemblance, and that is all one can say. It would be only natural to suppose that Time had wrought some changes from the Millepore type, and if such changes could be correctly diagnosed, we might enter these specimens as distinct varieties, characteristic of the locality and the horizon.

I can scarcely doubt that these forms are more or less connected with that section of the *Littorina (Turbo) muricata* group described as variety A in the "Corallian Gasteropoda" (GEOL. MAG. 1880, p. 534, Pl. XVII. Fig. 7). The difficulty is to know where to draw

the line. If we call Figure 3 *Turbo Phillipsii*, and Figure 4 *Littorina muricata*, as was done by Mr. Leckenby, we shall put a double accent on differences, never perhaps very great, though somewhat increased by conditions of preservation in a different matrix. Any one tabulating this kind of nomenclature would record two forms practically identical, not only as differing specifically, but also generally. In this fashion the Kelloway rock of Scarborough would be credited with *Turbo Phillipsii*, and the Oxford Clay with *Littorina muricata*, and thus would be created a gap in the Geological Record, which had no existence except in an imperfect system of nomenclature.

Doubtless many such gaps have had a similar origin.

52.—AMBERLEYA ARMIGERA, Lycett, 1863. Plate VIII. Figs. 5a, 5b.

1863. *Ambereleya armigera*, Lycett, Suppl. Great Ool. Moll. p. 20, pl. 31, fig. 6.

1866. *Turbo armigera*, Lycett, Leck. Cat. of Cornbrash Fossils.

1875. *Ambereleya armigera*, "L. and M." Phillips, G. Y. 3rd edition, p. 258.

*Bibliography, etc.*—This is probably the *Purpurina ornata* of Dr. Wright's Cornbrash List (*vol. cit.* p. 27), and is most likely the *Littorina ornata* of Brauns (Mitt. Jura, p. 177), from the beds of *Ostrea Knorrii*.

*Description.*—Specimens from the Cornbrash (zone 4), Scarborough. Leckenby Collection.

Length .....	30 millimètres.
Width of last whorl to length of shell .....	55 : 100.
Spiral angle.....	55°.

Shell conical, pointed, eucycloid; outline of spire oblique, sutures wide, almost gaping, especially as between the body-whorl and the rest of the spire. Whorls about 7: those posterior to the penult carry three spiral bands, somewhat widely nodular, the nodules being more or less connected by axial lines across the sulci. The penult shows four spirals, the second being very subsidiary: the two lowest spirals form a nodulous double belt, the anterior one the most prominent: on this the nodes are more spinous in character. The base has numerous granulated spiral bands.

The margin of the aperture in this specimen is slightly broken towards the anterior extremity, so that the point at the termination of the columellar lip is not quite so well seen, but the aperture itself corresponds in all essential respects with that in *T. Phillipsii*, and in the group generally.

*Relations and Distribution.*—This particular form, in Yorkshire, would seem to be confined to the Cornbrash. It differs from *T. Phillipsii* in the rather smaller spiral angle, and in the greater number of whorls, and more generally pronounced eucycloid character: as regards ornaments, the granulations of the spiral belts are wider apart, less numerous and nodular, larger and more spiny. There are specimens, however, in the Millepore Rock, which, small though they be, seem to prefigure this form. *Ambereleya armata* belongs to the *Turbo ornatus* group, but the differences are not inconsiderable as compared with typical forms of *T. ornatus* from

the South of England. *Amberleya Stricklandi*, from the Coral Rag of the Scarborough district (see "Corallian Gasteropoda," GEOL. MAG. 1880, p. 536, Pl. XVII. Fig. 10), is its representative on a higher horizon.

Fairly abundant in the Cornbrash of Scarborough.

53.—"TURBO" *SULCOSTOMUS*, Phillips, 1829. Plate VIII. Figs. 6, 6a, 7.

1829. *Turbo sulcostomus*, Phillips, G. Y. p. 112, pl. vi. fig. 10.

1849. *Turbo sulcostomus*, Phil. D'Orbigny, Prod. i. p. 333.

*Bibliography, etc.*—Stated by Phillips to occur as casts at Hackness and South Cave, and described as having "three or four sharp spiral costæ, the right lip grooved within." The type should be in the York Museum, but I have not seen it. D'Orbigny, in describing *Turbo Meriani* (T. J. vol. ii. p. 355), suggested a connection with *T. sulcostomus*.

*Description.*—Specimen from the Kelloway Rock (Zone 5). Leckenby Collection. Figs. 6a, 6b.

This fossil is from the red-stained Oolite Grit, and is nearly in the condition of a cast. The spiral angle would probably be about 65°. Three complete whorls and part of a fourth remain: suture wide. On the last two whorls traces of 4 spiral bands are visible, the lowest two forming a sort of double keel, the anterior being the most prominent. The spiral bands are continued throughout the base. The fine axial lines of the intercostal spaces are well preserved in some places.

*Another Specimen.*—Same horizon. Bean Collection, British Museum. Fig. 7.

This also is from the red-stained Oolite Grit, and is marked "*Turbo sulcostomus*" in Bean's own handwriting. A considerable amount of inner shell-layer yet adheres on the penult, whilst the body-whorl is absolutely stripped, with the exception of a little on the base. This specimen is instructive as showing that the strong spiral bands of the shell produce but little corresponding mark on the internal cast.

*Relations and Distribution.*—People might well recoil from attempting to make out the relations of such a fossil as that shown in Fig. 7; nor is Phillips's own figure very reassuring, though it is perfectly clear that D'Orbigny was on the right track when he connected *T. sulcostomus* with *T. Meriani*. That they are absolutely the same one need not suppose, but well-preserved specimens from the Oxfordian of the *roches noires* present characters which suggest what *T. sulcostomus* might have been under thoroughly spathic conditions—something in fact between *T. Phillipsii* and *Amberleya armigera*. With the latter species also *T. sulcostomus* has affinities which the more or less complete destruction of the ornaments seems to mask. It is my belief that if the Kelloway fossil could be obtained in the same condition as the Cornbrash one, the differences between them would not be great.

Not common.

## 54.—AMBERLEYA (TURBO) CLAVATA. Bean MS. Plate VIII. Fig. 8.

*Description.*—Specimens from the Oxford Clay (Zone 6), Scarborough. Bean Collection, British Museum.

None of the shell-substance is retained, but we seem to have a tolerably faithful outline of the exterior and ornaments. For a fossil in the O.C. the shape is well maintained, though not sufficiently to attempt any measurements. The specimen was probably upwards of 50 millimètres in length. The aperture is not really preserved, the appearance of one shown in the figure merely representing the fancy of the person who originally developed the fossil, subsequently rendered with almost grotesque fidelity by the artist.

Shell eucycloid, turbinated; whorls tumid, yet angular, with a wide sutural hollow. The penult probably had 4 nodular spiral bands, the central pair constituting the double keel. In the body-whorl the uppermost spiral is close to the suture, the granulations being wide apart and spinous; the second spiral is a somewhat faint line, slightly nodular at wide intervals: the third and fourth spirals constitute the double keel, the tuberculations on the upper of these (3) are wider apart than on the lower one (4), which is slightly the more salient; the fifth spiral has close tuberculations resembling those of the fourth. Of the actual base of the shell only a portion remains. It is rounded and spirally lineated at wide intervals by lines alternately sharper and fainter, which are slightly nodulous. Traces of the fine radial or axial ornament are faint throughout the specimen.

*Relations and Distribution.*—The appearance of such a fine Gasteropod as this in the Oxford Clay of Scarborough is so wholly unexpected that, apart from the difficulties connected with imperfect preservation, one hardly knows what to make of the phenomenon. It evidently belongs to the group to which *Turbo ornatus*, Sow., *Turbo capitaneus*, Münt., and *Turbo spinulosus*, Münt., belong. These were all regarded by Mr. Tawney (Dundry Gasteropoda, p. 19) as specifically the same. The real facts of the case are that a number of forms occur where the group is at all plentiful, as is the case in the I. O. of Bradford Abbas. For instance, the very handsome and characteristic specimen figured by Mr. Tawney (*op. cit.* pl. i. fig. 9) bears no very special resemblance to Sowerby's type figure, though it represents the prevailing form at Bradford Abbas. If there was more certainty, I would not hesitate to call the fossil now under consideration *Amberleya ornata*, var. *clavata*. There are, however, very considerable differences in the ornamentation of Bean's shell, as compared with that of the prevailing representative of the *ornata* group in the Inferior Oolite of the far south-west.

Both this species and *Amberleya armigera* represent the *ornata*-group in their respective horizons; but whilst the latter is fairly plentiful in the Cornbrash, only one other specimen of *A. clavata* is known to me from the O.C. of Yorkshire. That also was Bean's specimen, and is now in the York Museum.

## The "TROCHUS" BISERTUS Group.

There is considerable difficulty in dealing with the rare and beautiful fossils which make up the above-named group (see Figures 9, 10, and 11). In a general way Phillips's "*Trochus*" *bisertus* (G. Y. plate xi. fig. 27) is representative of it; hence there would be no uncertainty in accepting this name, provided we knew to which form it is more especially applicable. The type was provided by Williamson, but I have never seen it. Bean recognized a species, evidently belonging to the same group, which found admittance, though without either figure or description, in Phillips's first edition (p. 129), as *Turbo unicarinatus*, Bean MS., and which in the third edition is recorded as *Littorina unicarinata*, Bean MS.

As a result of an examination of the collections, it appears to me that there are two forms which may be fairly separable as species, or very marked varieties: each of them is small, under 20 millimètres in height (compare Figs. 9*b* and 10*b*), but each of them is represented by a megalomorph, occurring as a larger and more vigorous variety. If we are to lump the whole under one designation, "*Trochus*" *bisertus* is the correct one; and where specimens are imperfectly preserved, showing only the trochiform spire, this is by far the safest plan. Yet it is equally certain that we are not dealing with a *Trochus* in any of these specimens, but with shells belonging to the so-called Littorines, and which may belong either to *Littorina* or to a section of *Turbo*. Adopting names already in use, but without asserting that I am using them in the precise sense intended by the authors, I put forward *Littorina biserta*, Phil., with its megalomorph *Amberleya biserta*, and *Littorina unicarinata*, Bean, which is the commoner form of the two, and is also represented by a large variety, which I believe to have been the original *Trochus bisertus* of Phillips. This latter is not figured, as I have only quite lately obtained a specimen.

55.—LITTORINA (TROCHUS) BISERTA, Phillips, 1829. Plate VIII. Figs. 9*a*, *b*, *c*.

1829 and 1835. *Trochus bisertus*, Phillips, G. Y. p. 129, pl. xi. fig. 27.

1854. *Trochus bisertus*, Phil. Morr. Cat. p. 281.

Compare also, both for this and for *Littorina unicarinata*.

*Turbo generalis*, M. Goldf. Petrefact. iii. 92, pl. 194, 4.

*Turbo subangulatus*, M. Goldf. Petrefact. iii. 92, pl. 194, 5.

*Bibliography, etc.*—D'Orbigny, who generally quotes Phillips's species, omits this one from the list of *Trochus* in the étage Bajocien, nor am I aware that the species is in any way referred to in the Prodrôme, either under a synonym or otherwise. Neither can I identify it amongst the numerous small trochiform shells figured in the Pal. Franç. *Turbo generalis*, M., from the Lower Oolites of the neighbourhood of Amberg, has some slight resemblance.

*Description.*—Specimen from the Dogger (zone 1), Peak (Blue Wyke). Leckenby Collection.

Length .....	19 millimètres.
Height of body-whorl to entire shell.....	58 : 100.
Spiral angle .....	60°.

Shell short, conical, acute, not umbilicated. The spire consists of 5 or 6 whorls, which increase with regularity; outline trochiform and nearly equilateral: sutural excavation wide. Each whorl carries a pair of strong spiral belts (hence probably the name *T. bisertus*), one in the upper, the other in the lower part: in the upper belt the tuberculations are large and wide apart; in the lower and more prominent belt the tuberculations are much closer, and individually smaller. The space between these two belts forms a wide sulcus, which is sculptured by a system of axial lines in connexion with the tuberculations on the belts. Below the anterior of the two belts previously detailed the whorl is much constricted, but rises again to form a third and subordinate belt, which occupies the bottom of the sutural hollow, and is not readily observed in the whorls of the spire. The flanks of the body-whorl are similarly ornamented, but here the third and lowest keel assumes considerable proportions. Base tumid and long, with regular spiral belts closely granulated, and fine axial lines in the sulci.

The aperture is large and nearly circular, but as the margin is not quite perfect, the point at the extremity of the inner lip is scarcely to be made out. Columella solid.

*Relations and Distribution.*—The spire of this species is so thoroughly trochiform that few would object to Phillips's arrangement in this case. The aperture, at the same time, is so similar to those of the supposed Littorines (*Amberleya*, "*Littorina*," etc.), that "*Trochus*" *bisertus* should share their lot, whatever it may be. I have not seen specimens from any of the numerous localities of Inferior Oolite fossils, excepting the Dogger, which could with certainty be referred to Phillips's species. It is true that, in some collections, there are specimens labelled *Trochus bisertus*, Phil., but some of them have no relationship even generically with the Dogger fossil. This is not to be wondered at, when we bear in mind the nature of Phillips's figure, coupled with the absence of any description.

Extremely rare, and confined to the Dogger.

56.—*AMBERLEYA BISERTA*, believed to be a megalomorph of the above. Pl. VIII. Figs. 11a, b, c.

*Description.*—Specimen from the Dogger (zone 1), Peak (Blue Wyke). Jermy Street Museum.

Length restored .....	32 millimètres.
Approximate ratio of body-whorl .....	54: 100.
Spiral angle .....	58°.

The body-whorl and a portion of the spire alone are preserved; hence the above measurements are subject to correction. Shell conical, not umbilicated. The spire would probably consist of 6 or 7 whorls separated by a very wide sutural hollow. The penult carries 2 principal spiral bands; the upper one is widely tuberculated, and not very prominent, the lower forms a strong keel, and is slightly granulated; below this the whorl is very much constricted, and terminates in a third subordinate keel above a wide suture. The body-whorl presents these features on a larger scale, with the

exception that the third keel shows some fine granulations. The base has strong spiral bands slightly granulated. Fine axial lines ornament the entire shell, which has the wide aperture characteristic of every specimen figured on the accompanying Plate (VIII.), which has hitherto been described.

*Relations and Distribution.*—The specimen is unique; but if we could imagine that *Littorina biserta* was ever in the habit of developing another whorl, the body-whorl of the present specimen is just what we might expect as the result of the effort. Possibly we see in the Jernyn Street fossil the effects of good keep and favourable conditions upon an otherwise stunted race; whilst the evident relationship which exists between *Amberleya biserta* and specimens of the *T. capitaneus* group, from about this horizon in other districts, serves on the other hand to show how wonderfully these forms run into each other, and that a comparatively humble fossil like *Littorina biserta* has intimate relations with the most noble forms, Liassic as well as Oolitic.

57.—LITTORINA UNICARINATA. Bean MS. Pl. VIII. Figs. 10a, b, c.

*Description.*—Specimen from the Dogger (zone 1), Peak (Blue Wyke). Leckenby Collection.

Length .....	18 millimètres.
Height of body-whorl to entire shell .....	56 : 100.
Spiral angle .....	68°.

Shell short, conical, acute, not umbilicated. The spire consists of 5 or 6 whorls: outline trochiform, but somewhat inequilateral. Sutural hollow of moderate width. Each whorl has two spiral belts situated near either extremity. The posterior belt is close to the suture, and consists of a row of large and regular tuberculations, the anterior belt forms a prominent keel (*unicarinata*), and is finely and regularly granulated. The flanks of the shell are ornamented by a system of very fine axial lines. In the body-whorl a third and subordinate spiral belt is shown.

Base of the shell a little less tumid than in the preceding species; outer lip rather more angular, but so much of the aperture is broken away that the indications are not perfect.

*Relations and Distribution.*—From the specimen (Fig. 9) previously described this form differs in the wider spiral angle, and greater inequality of the sides, in the less gaping character of the sutural hollow, and the slightly more quadrate form of the aperture. Both of them differ entirely from *Trochus*, however; in the lengthened and tumid base, and in the wide and, on the whole, circular character of the aperture, though they might very well, in common with the whole of these *Littorinas*, be ranked under a section of *Turbo*.

As regards ornaments, *L. uncarinata* differs from *L. biserta* in having the upper spiral band merely developed as a row of tuberculations close to the suture, and not in the form of a keel, and in the absence from the whorls of the spire of any exhibition of a third keel. The second spiral band predominates therefore, and gives a



certain character to the shell. I do not attach great value to these variations in ornament, although they are just the points which first arrest attention. Yet they differ much in individual specimens. The greater width of spiral angle and the less gaping suture are of more consequence.

Recently I have obtained an impression in gutta-percha from a mould of an exterior, which belongs to the Yorkshire Philosophical Society. This specimen exhibits a fine trochiform spire, but without the aperture. The proportions of the spire are nearly the same as in *L. unicarinata*, but the ornamentation is bolder, and the shell nearly twice the size. This seems to me the nearest approach to Phillips's figure.

58.—“TURBO MELANIOIDES,” Bean MS. Pl. VIII. Figs. 12, 12a.

*Description.*—Specimen from the Dogger (zone 1), Peak (Blue Wyke).

Length .....	23 millimètres.
Height of body-whorl to entire shell .....	75 : 100.
Spiral angle .....	75°.

Shell short, turbate, imperforate. The spire consists of about five whorls, which increase under a regular angle, and are extremely tumid, with a slight flattening of the posterior third. The whorls are smooth. A fine spiral line is noticed on the penult, and there are three on the body-whorl. Of these lines the middle one is situate on the very widest part of the shell, and the area between it and the two other lines is slightly flattened, so as to produce two indistinct flat belts on either side of the centre. There are also other fine spiral lines, and a few rugose longitudinal lines, which may represent lines of growth.

The aperture is very large, and, if the outline as it now exists is the natural one, must be described as having the inner lip circular, the outer lip angular (see Fig. 12a).

*Relations and Distribution.*—This fossil is also unique, but, unlike the last one, its relations are not easy to trace. It is presumed that the peculiar shape of the outer lip is due to compression. If we make the outer lip circular like the inner one (Fig. 12), we should obtain an aperture something like the “*Littorinas*” previously described; but it will be at once observed that the spiral angle and ratio of body-whorl are quite different to what obtains in that group, whilst the spiral lines are against its being a *Natica*. At present we must be content to let it remain as “*Turbo melanioides*.”

EXPLANATION OF PLATE VIII.

- FIGS. 1a, 1b. *Littorina Phillipsii*, Morris and Lycett. Millepore Rock of Clough-ton. Leckenby Collection. Front and back view.  
 ,, 2a, 2b. *Littorina* species, or variety. Dogger, Blue Wyke. York Museum. Back view and portion enlarged.  
 ,, 3, *Littorina* cf. *Phillipsii*, M. and L. Kelloway Rock, Scarborough. Leckenby Collection.  
 ,, 4. *Littorina* cf. *Phillipsii*, M. and L. Oxford Clay, Scarborough. Leckenby Collection.  
 ,, 5a, 5b. *Amberleya armigera*, Lycett. Cornbrash, Scarborough. Leckenby Collection. Front and back view.

- FIGS. 6a, 6b. "*Turbo*" *suleostomus*, Phillips. Kelloway Rock, Scarborough. Leckenby Collection. Front and back view.
- " 7. "*Turbo*" *suleostomus*, Phillips. Kelloway Rock. ? Hackness. British Museum.
- " 8. *Amberleya clavata*, Bean, MS. Oxford Clay, Scarborough. British Museum.
- " 9a, b, c. *Littorina biserta*, Phillips. Dogger, Blue Wyke. Leckenby Collection. Front, back, and portion enlarged.
- " 10a, b, c. " " var. *unicarinata*, Bean. Dogger, Blue Wyke. Leckenby Collection. Front, back, and portion enlarged.
- " 11a, b, c. *Amberleya biserta*. Dogger, Blue Wyke. Jermyn Street Museum. Front, back, and portion enlarged.
- " 12, 12a. "*Turbo melanioides*," Bean, MS. Dogger, Blue Wyke. York Museum. Front view, and *facsimile* of aperture.

## II.—THE PRINCIPAL CHARACTERS OF AMERICAN JURASSIC DINOSAURS BELONGING TO THE ORDER THEROPODA.<sup>1</sup>

By PROFESSOR O. C. MARSH, M.A., F.G.S.

Of Yale College, Newhaven, Ct., U.S.A.

THE carnivorous *Dinosauria* form a well-marked order, which the writer has called the *Theropoda*, in his classification of this group.<sup>2</sup> Although much has been written about these reptiles since Buckland described *Megalosaurus* in 1824, but little has really been made out in regard to the structure of the skull, and many portions of the skeleton still remain to be determined.

The fortunate discovery of two nearly perfect skeletons of this order, as well as a number of others with various important parts of the skeleton in good preservation, has afforded the writer an opportunity to investigate the group, and some of the results are here presented. A more detailed description of these fossils, and others allied to them, will be given in another communication.

Of the carnivorous Dinosaurs from the American Jurassic, there are four genera, which each represents, apparently, a distinct family. These genera are *Allosaurus*, *Cœlurus*, *Labrosaurus*, and the new genus *Ceratosaurus*, here described. In the present article, *Allosaurus* and *Ceratosaurus* will be mainly used to illustrate the more important characters of the order, and the relations of the other genera to them will be indicated in the classification presented in conclusion.

The specimen of *Ceratosaurus* here first described presents several characters not hitherto seen in the *Dinosauria*. One of these is a large horn on the skull; another is a new type of vertebra, as strange as it is unexpected; and a third is seen in the pelvis, which has the bones all cœssified, as in existing Birds. *Archæopteryx* alone among adult birds has the pelvic bones separate, and this specimen of *Ceratosaurus* is the first Dinosaur found with all the pelvic bones ankylosed. Another feature of this skeleton, not before seen in the *Theropoda*, is the presence of osseous dermal plates. These extend from the base of the skull along the neck, over the vertebræ. The plates appear to be ossified cartilage.

<sup>1</sup> From the American Journal of Science, vol. xxvii. April, 1884.

<sup>2</sup> Silliman's Journal, vol. xxiii. p. 81, January, 1882. See also vol. xxi. p. 423, May, 1881; p. 339, April, 1881; and vol. xvii. p. 89, January, 1879.

This interesting fossil is quite distinct from any hitherto described, and, as it represents a new genus and species, may be called *Ceratosaurus nasicornis*. It also belongs to a new family, which may be named the *Ceratosauridæ*.

The skeleton, which is almost perfect, is over seventeen feet in length by actual measurement. The animal when alive was about half the bulk of the species named by the writer *Allosaurus fragilis*, which is from the same geological horizon. A second skeleton, some parts of which, also, are here described, is referred to the latter species.

THE SKULL.—The skull of *Ceratosaurus nasicornis* is very large, in proportion to the rest of the skeleton. The posterior region is elevated, and moderately expanded transversely. The facial portion is elongate, and tapers gradually to the muzzle. Seen from above, the skull resembles in general outline that of a crocodile. The nasal openings are separate, and lateral, and are placed near the end of the snout, as shown in Fig. 1.

Seen from the side, this skull appears Lacertilian in type, the general structure being light and open. From this point of view, one special feature of the skull is the large, elevated, trenchant horn-core, situated on the nasals (Fig. 1, *b*). Another feature is the large openings on the side of the skull, four in number. The first of these is the anterior nasal orifice (*a*); the second, the very large triangular antorbital foramen (*c*); the third, the large oval orbit (*d*); and the fourth, the still larger lower temporal opening (*e*). A fifth aperture, shown in the top view of the skull, is the supra-temporal fossa. These openings are all characteristic of the *Theropoda*, and are found also in the *Sauropoda*, but the antorbital foramen is not known in any of the other *Dinosauria*.

The plane of the occiput, as bounded laterally by the quadrates, is inclined forward. The quadrates are strongly inclined backward, thus forming a marked contrast to the corresponding bones in *Diplodocus*, and the other *Sauropoda*. The occipital condyle is hemispherical in general form, and is somewhat inclined backward, making a slight angle with the long axis of the skull. The basi-occipital processes are short, and stout. The par-occipital processes are elongate and flattened, and but little expanded at their extremities. They extend outward and downward, to join the head of the quadrate.

The hyoid bones appear to be four in number. They are elongate, rod-like bones, somewhat curved, and in the present specimen were found near their original position.

The parietal bones are of moderate size, and there is no parietal foramen. The median suture between the parietals is obliterated, but that between these bones and the frontals is distinct.

The frontal bones are of moderate length, and are closely united on the median line, the suture being obliterated. Their union with the nasals is apparent on close inspection.

The nasal bones are more elongate than the frontals, and the suture uniting the two moieties is obsolete. These bones support entirely the large compressed, elevated horn-core, on the median

line. The lateral surface of this elevation is very rugose, and furrowed with vascular grooves. It evidently supported a high, trenchant horn, which must have formed a most powerful weapon for offence and defence. No similar weapon is known in any of the *Dinosauria*, but it is not yet certain whether this feature pertained to all the members of this family, or was only a generic character.<sup>1</sup>

The premaxillaries are separate, and each contained only three functional teeth. In the genera *Compsognathus* and *Megalosaurus*, of this order, each premaxillary contained four teeth, the same number found in the *Sauropoda*. In the genus *Creosaurus*, from the American Jurassic, the premaxillaries each contain five teeth.

The maxillary bones in the present specimen are large and massive, as shown in Fig. 1. They unite, in front, with the premaxillaries by an open suture; with the nasals, laterally, by a close union; and, with the jugal behind, by squamosal suture. The maxillaries are provided each with fifteen functional teeth, which are large, powerful, and trenchant, indicating clearly the ferocious character of the animal when alive. These teeth have the same general form as those of *Megalosaurus*, and the dental succession appears to be quite the same.

Above the antorbital foramen on either side, is a high elevation composed of the prefrontal bones. These protuberances would be of service in protecting the orbit, which they partially overhang.

The orbit is of moderate size, oval in outline, with the apex below. It is bounded in front by the lachrymal, above this by the prefrontal, and at the summit the frontal forms for a short distance the orbital border. The post-frontal bounds the orbit behind, but below, the jugal completes the outline.

The jugal bone is L-shaped, the upper branch joining the post-frontal, the anterior branch uniting with the lachrymal, above, and the maxillary below. The posterior branch passes beneath the quadrato-jugal, and with that bone completes the lower temporal arch, which is present in all known Dinosaurs.

The quadrato-jugal is an L-shaped bone, and its anterior branch is united with the jugal by a close suture. The vertical branch is closely joined to the outer face of the quadrate.

The quadrate is very long, and compressed antero-posteriorly. The head is of moderate size, and is enclosed in the squamosal. The lower extremity of the quadrate has a double articular face, as in some birds. One peculiar feature of the quadrate is a strong hook, on the upper half of the outer surface. Into this hook of the quadrate, a peculiar process of the quadrato-jugal is inserted, as shown in Fig. 1.

The pterygoid bones are very large, and extend well forward. The posterior extremity is applied closely to the inner side of the quadrate. The middle part forms a pocket, into which the lower extremity of the basi-ptyergoid process is inserted. To the lower

<sup>1</sup> The "horn" of *Iguanodon* described by Mantell, and since regarded as a carpal spine, proves to be the distal phalange of the thumb.

FIG. 1.

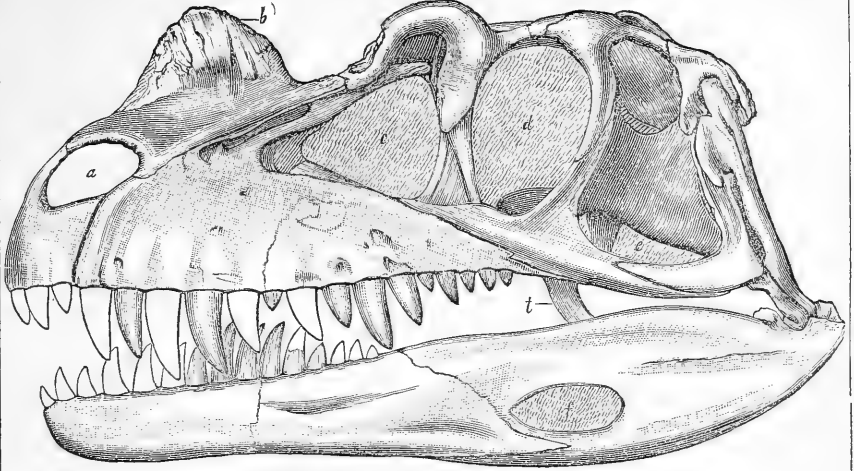


FIG. 2.

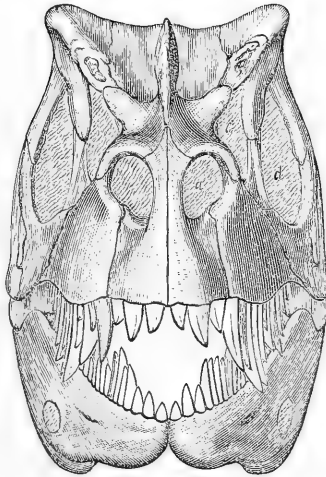


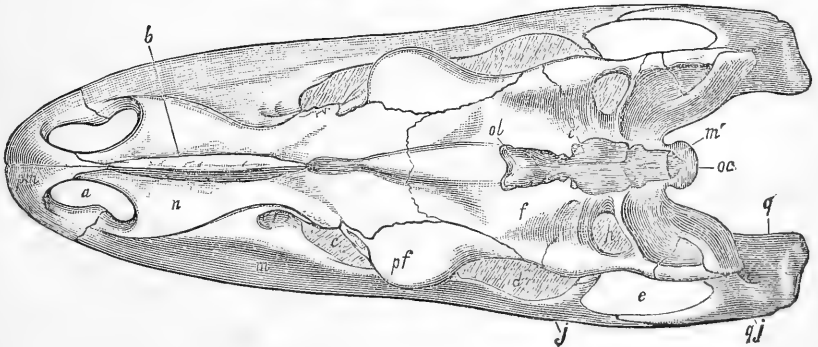
FIG. 1.—Skull of *Ceratosaurus nasicornis*, Marsh; side view.

FIG. 2.—The same skull; front view.

FIG. 3.—Skull and brain-cast of *Ceratosaurus nasicornis*, Marsh; seen from above, one-sixth natural size. *a*, nasal opening; *b*, horn-core; *c*, antorbital opening; *c'*,

cerebral hemispheres; *d*, orbit; *e*, lower temporal fossa; *f*, frontal bone; *h*, supratemporal fossa; *j*, jugal bone; *m*, maxillary bone; *m'*, medulla; *n*, nasal bone; *oc*, occipital condyle; *ol*, olfactory lobes; *pf*, pre-frontal bone; *pm*, pre-maxillary bone; *q*, quadrate bone; *qj*, quadrato-jugal bone.

FIG. 3.



margin of the pterygoid is united the strong, curved, transverse bone, which projects downward below the border of the upper jaws, as shown in Figure 1, *t*.

There is a very short, thin, columella, which below is closely united to the pterygoid by suture, and above fits into a small depression of the post-frontal.

The palatine bones are well developed and, after joining the pterygoids, extend forward to the union with the vomers. The latter are apparently of moderate size.

The pre-sphenoid is well developed, and has a long pointed anterior extremity.

The whole palate is remarkably open, and the principal bones composing it stand nearly vertical, as in the *Sauropoda*.

**THE BRAIN.**—The brain in *Ceratosaurus* was of medium size, but comparatively much larger than in the herbivorous Dinosaurs. It was quite elongate, and situated somewhat obliquely in the cranium, the posterior end being inclined downward. The position of the brain in the skull, and its relative size, is shown in Fig. 3.

The foramen magnum is small. The cerebellum was of moderate size. The optic lobes were well developed, and proportionally larger than the hemispheres. The olfactory lobes were large, and expanded. The pituitary body appears to have been very large.

**THE LOWER JAWS.**—The lower jaws of *Ceratosaurus* are large and powerful, especially in the posterior part. In front, the rami are much compressed, and they were joined together by cartilage only, as in all Dinosaurs. There is a large foramen in the jaw, similar to that in the crocodile, as shown in Fig. 1, *f*. The dentary bone extends back to the middle of this foramen. The splenial is large, extending from the foramen forward to the symphyseal surface, and forming in this region a border to the upper margin of the dentary. There were fifteen teeth in each ramus, similar in form to those of the upper jaws.

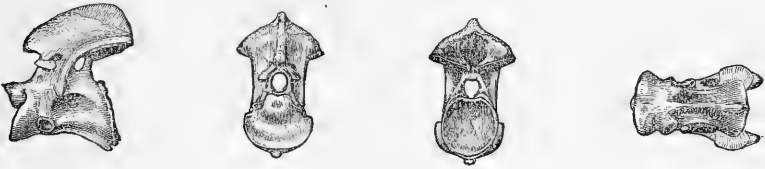
A peculiar dentary bone, recently found, and here referred to *Labrosaurus*, is edentulous in front, and the posterior portion is much decurved. The teeth are more triangular than in the other genera of this order. The species it represents may be called *Labrosaurus ferox*.

**THE VERTEBRÆ.**—The cervical vertebræ of *Ceratosaurus* differ in type from those in any other known Reptiles. With the exception of the atlas, all are strongly opisthocelium, the cup on the posterior end of each centrum being unusually deep. In place of an equally developed ball on the anterior end, there is a perfectly flat surface. The size of the latter is such that it can only be inserted a short distance in the adjoining cup, and this distance is accurately marked on the centrum by a narrow articular border, just back of the flat anterior face. This peculiar articulation leaves more than three-fourths of the cup unoccupied by the succeeding vertebra, forming, apparently, a weak joint. This feature is shown in Fig. 4.

The discovery of this new form of vertebra shows that the terms opisthocelium and procelium, in general use to describe the centra

of vertebræ, are inadequate, since they relate to one end only, the other being supposed to correspond in form. The terms convex-concave, concavo-convex, plano-concave, etc., would be more accurate, and equally euphonious.

FIG. 4.

Axis vertebra of *Ceratosaurus nasicornis*.

In *Ceratosaurus*, as in all the *Theropoda*, except *Cœlurus*, the cervical ribs are articulated to the centra, not coössified with them, as in the *Sauropoda*. The latter order stands almost alone among Dinosaurs in this respect, as both the *Stegosauria* and the *Ornithopoda* have free ribs in the cervical region.

The dorsal and lumbar vertebræ are bi-concave, with only moderate concavities. The sides and lower surface of the centra are deeply excavated, except at the ends. These vertebræ show the diplophenal articulation seen in *Megalosaurus*, and also in *Creosaurus*.

All the pre-sacral vertebra are very hollow, and this is also true of the anterior caudals.

There are five well-coössified vertebræ in the sacrum in the present specimen of *Ceratosaurus nasicornis*. The transverse processes are very short, each supported by two vertebræ, and they do not meet at their distal ends.

In the type specimen of *Creosaurus*, there are only two sacral vertebræ coössified. In the *Megalosaurus*, there are five, and the number appears to vary in different genera of the *Theropoda*, as it does in the *Sauropoda*.

The caudal vertebræ are bi-concave. All the anterior caudals, except the first, supported very long chevrons, indicating a high, thin tail, well adapted to swimming. The tail was quite long, and the distal caudals were very short.

THE FORE LIMBS.—The fore limbs in *Allosaurus*, and in fact in all known *Theropoda*, were very small. The scapula and coracoid resembled those of *Megalosaurus*. The humerus was short, and somewhat sigmoid in form. The shaft was hollow, as in all the limb bones of this genus. The manus was peculiar in having some of its digits armed with powerful compressive claws, which formed most effective weapons. These claws, in some allied forms, have been referred to the hind feet, but the latter, in all the known *Theropoda*, have their claws round, and not compressed. The fore limb of *Allosaurus fragilis* is shown in Fig. 8.

THE PELVIC ARCH.—The pelvic bones in the *Theropoda* have been more generally misunderstood than any other portion of the skeleton in Dinosaurs. The ilia, long considered coracoids, have been since usually reversed in position; the ischia have been regarded

as pubes; while the pubes themselves have not been considered as part of the pelvic arch.

Fortunately, in the present specimen of *Ceratosaurus*, the ilium, ischium, and pubes are firmly coössified, so that their identification and relative positions cannot be called in question. The ilia, moreover, were attached to the sacrum, which was in its natural place in the skeleton, and the latter was found nearly in the position in which the animal died. The pelves of *Ceratosaurus* and of *Allosaurus* are shown in Figs. 5 and 6.

The ilium in *Ceratosaurus* has the same general form as in *Megalosaurus*. In most of the other *Theropoda*, also, this bone has essentially the same shape, and this type may be regarded as characteristic of the order. In *Creosaurus*, the anterior wing is more elevated, and the emargination below it wider, but this may in part be due to the imperfection of the border.

The ischia in *Ceratosaurus* are comparatively slender. They project well backward, and for the last half of their length the two are in close apposition. The distal ends are coössified, and expanded.

The pubes in *Ceratosaurus* have their distal ends coössified, as in all the known *Theropoda*. They project downward and forward, and their position in the pelvis is shown in Figs. 5 and 6. Seen from the front, they form a Y-shaped figure, which varies in form in different genera. The upper end joins the ilium by a large surface, and the ischium by a smaller attachment. The united distal ends are expanded into an elongate, massive foot, as shown in Figs. 5 and 6, which is one of the most peculiar and characteristic parts of the skeleton.

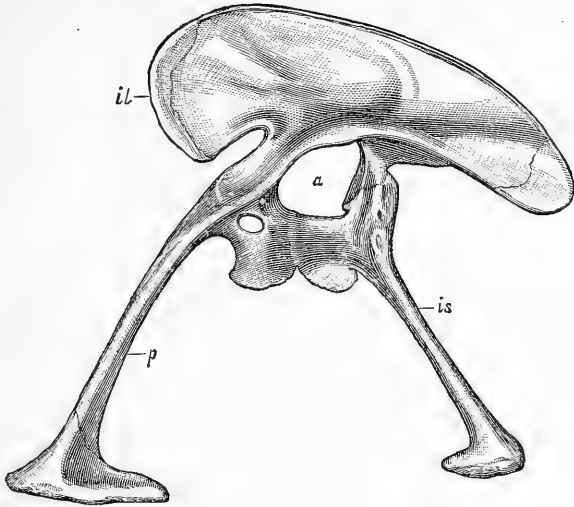
The pubes of *Megalosaurus* have not yet been identified, but there can be little doubt that they are of the same general type as in *Ceratosaurus* and *Allosaurus*. The pubes of *Cœlurus* pertain to a new species, which may be called *Cœlurus agilis*. This animal was at least three times the bulk of the type. Owen has figured the pubes of another species of this genus, under the name *Poikilopleuron pusillus*, but he regarded the specimen as an "abdominal hæmapophysis and hæmal spine." (Palæontographical Society, vol. xxx. plate i. 1876.)

The extremely narrow pelvis is one of the most marked features in this entire group, being in striking contrast to the width in this region in the herbivorous forms found with them. If the *Theropoda* were viviparous, which some known facts seem to indicate, one difficulty, naturally suggested in the case of a reptile, is removed.

Another interesting point is, the use of the large foot at the lower end of the pubes, which is the most massive part of the skeleton. The only probable use is, that it served to support the body in sitting down. That some Triassic Dinosaurs sat down on their ischia is proved conclusively by the impressions in the Connecticut River sandstone. In such cases the leg was bent so as to bring the heel to the ground. The same action in the present group would bring the foot of the pubes to the ground, nearly or quite under the centre of gravity of the animal. The legs and ischia would then naturally

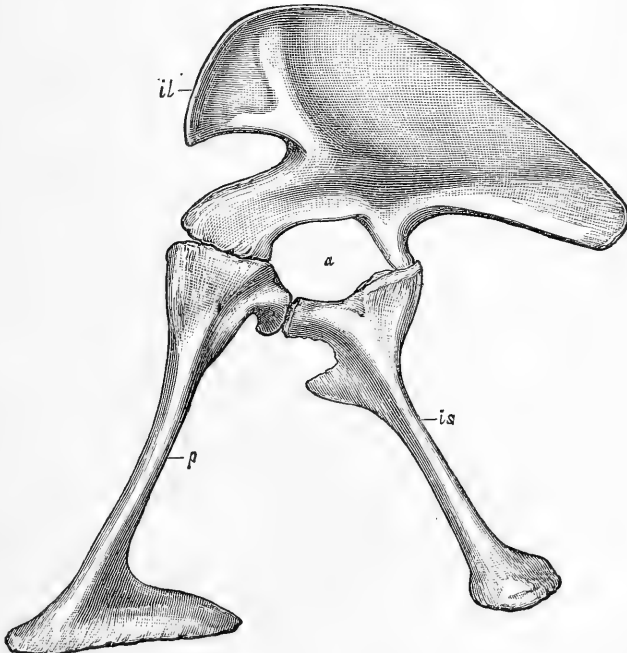


FIG. 5.



Pelvis of *Ceratosaurus nasicornis*, Marsh ; side view, seen from the left.

FIG. 6.



Pelvis of *Allosaurus fragilis*, Marsh ; the same view. *a*, acetabulum ;  
*il*, ilium ; *is*, ischium ; *p*, pubis.

Both figures are one-twelfth natural size.

aid in keeping the body balanced. Possibly this position was assumed habitually by these ferocious biped reptiles, in lying in wait for prey.

**THE HIND LIMBS.**—Several restorations of the posterior limb of *Megalosaurus* have been attempted, but the imperfect material at hand was not sufficient to ensure entire success. In the restoration of *Allosaurus*, given in Fig. 7, only the bones found together have been placed in position. The relative proportions of the femur and tibia are shown in this figure, and the general structure of the foot. The astragalus and calcaneum are distinct from the tibia and fibula, as in all the known *Theropoda*, although their coalescence has been regarded as certain in some of the genera.<sup>1</sup>

In the foot of *Allosaurus fragilis*, represented in Fig. 7, no tarsal bones of the second row were found, although the adjoining bones were nearly in their natural position. Whether the former were imperfectly ossified, or lost, in this instance cannot be determined with certainty, but there is evidence of the presence of these bones in several other members of the group. In the present foot, there were three functional digits. The metatarsals are very long, and fitted closely to each other, especially at their upper ends. The phalanges and claws were mostly found near the positions here assigned to them.

The specimens of *Theropoda* here first described, including the type specimen of *Ceratosaurus nasicornis*, are from the *Atlantosaurus* beds of the Upper Jurassic, in Colorado, where they were found by Mr. M. P. Felch. The associated fossils are various *Sauropoda*, *Stegosauria*, and *Ornithopoda*, together with Jurassic Mammals.<sup>2</sup>

#### CLASSIFICATION.

The main characters of the order *Theropoda* and of the families now known to belong to it, are as follows:—

##### Order THEROPODA.

Premaxillary bones with teeth. Anterior nares at end of skull. Large antorbital opening. Vertebrae more or less hollow. Fore limbs very small; limb bones hollow. Feet digitigrade; digits with prehensile claws. Pubes projecting downward, with distal ends coössified.

- (1.) Family *Megalosauridae*. Anterior vertebrae convexo-concave; remaining vertebrae bi-concave. Pubes slender. Astragalus with ascending process.

Genera, *Megalosaurus* (*Poikilopleuron*), *Allosaurus*, *Caelosaurus*, *Creosaurus*, *Dryptosaurus* (*Laelaps*).

- (2.) Family *Ceratosauridae*. Horn on skull. Cervical vertebrae plano-concave, remaining vertebrae bi-concave. Pubes slender. Pelvic bones coössified. Osseous dermal plates. Astragalus with ascending process.

Genus, *Ceratosaurus*.

<sup>1</sup> *Compsognathus* is cited as an instance of this union, but in a careful study of the original specimen in Munich, the writer found evidence that the astragalus is distinct, although closely attached to the tibia. Baur has since proved this conclusively (*Morpholog. Jahrbuch*, viii.). In the *Stegosauridae* alone, among known Dinosaurs, is the astragalus coössified with the tibia. This, however, is not a character of much importance.

<sup>2</sup> The presence of various genera of Dinosaurs closely allied to these American forms in essentially one horizon in the Isle of Wight, suggests that the beds in which they occur are not Wealden, as generally supposed, but Jurassic.

FIG. 7.

FIG. 7.—Bones of left hind leg of *Allosaurus fragilis*, Marsh.

FIG. 8.—Bones of left fore leg of *Allosaurus fragilis*.

Both figures are one-twelfth natural size.

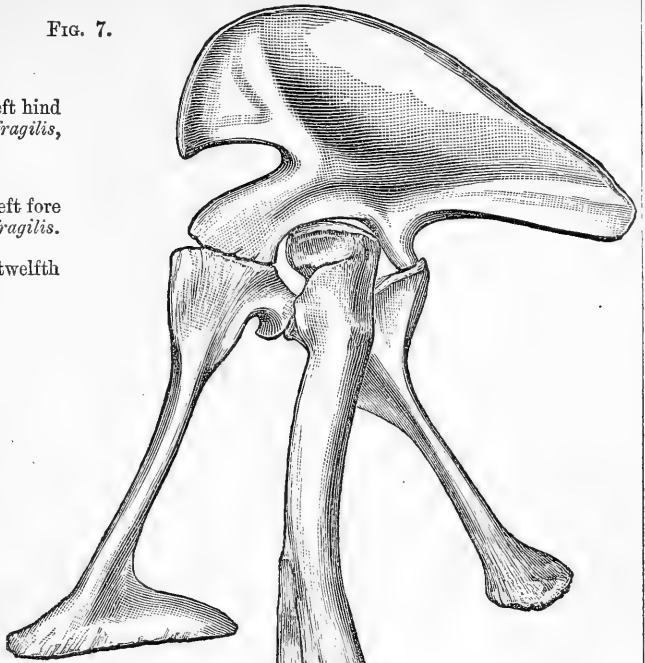
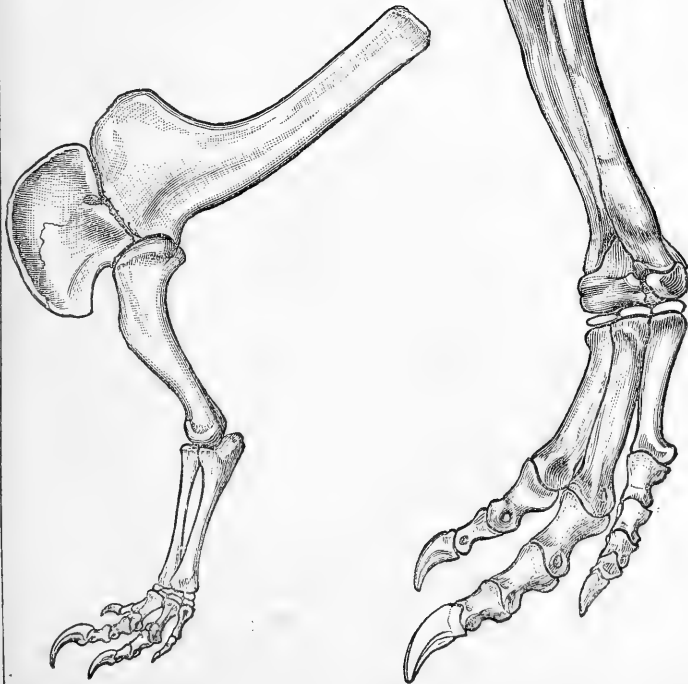


FIG. 8.



- (3.) Family *Labrosauridæ*. Lower jaws edentulous in front. Cervical and dorsal vertebræ convexo-concave. Pubes slender, with anterior margins united. Astragalus with ascending process.  
Genus, *Labrosaurus*.
- (4.) Family *Zanclodontidæ*. Vertebræ bi-concave. Pubes broad elongate plates, with anterior margins united. Astragalus without ascending process. Five digits in manus and pes.  
Genera, *Zanclodon*, ? *Teratosaurus*.
- (5.) Family *Amphisauridæ*. Vertebræ bi-concave. Pubes rod-like. Five digits in manus, and three in pes.  
Genera, *Amphisaurus* (*Megadactylus*), ? *Bathynathus*, ? *Clepsysaurus*, *Palæosaurus*, *Thecodontosaurus*.

## Sub-order CÆLURIA.

- (6.) Family *Cæluridæ*. Vertebræ and bones of skeleton pneumatic. Anterior cervicals convexo-concave; remaining vertebræ bi-concave. Cervical ribs cossified with vertebræ. Metatarsals very long and slender.  
Genus, *Cælorus*.

## Sub-order COMPSOGNATHA.

- (7.) Family *Compsognathidæ*. Cervical vertebræ convexo-concave; remaining vertebræ bi-concave. Three functional digits in manus and pes. Ischia with long symphysis on median line.  
Genus, *Compsognathus*.

Of these seven well-marked families, the *Amphisauridæ* and *Zanclodontidæ* are Triassic, the *Megalosauridæ* are Jurassic and Cretaceous, while the others are all Jurassic alone.

There are still some very diminutive carnivorous Dinosaurs that cannot at present be referred to any of the above families; but this may in part be due to the fragmentary condition in which their remains have been found.

The peculiar orders *Hallopoda* and *Aëtosauria* include carnivorous reptiles which are allied to the *Dinosauria*, but they differ from that group in some of its most characteristic features. In both *Aëtosaurus* and *Hallopus*, the calcaneum is much produced backwards. In the former genus, the entire limbs are crocodilian, and this is also true of the dermal covering. In *Hallopus*, the calcaneum is greatly lengthened, and the whole posterior limb is especially adapted to leaping. In both of these genera, there are but two sacral vertebræ, but this may be the case in true Dinosaurs, especially from the Trias. Future discoveries will probably bring to light intermediate forms between these orders and the typical Dinosaurs.

## III.—LAND SHELLS IN THE RED CRAG.

By ROBERT G. BELL, F.G.S.

PERHAPS very few Tertiary formations have received a greater amount of attention from geologists and collectors of fossils; during the last forty years, than the Red Crag of Suffolk and Walton-Naze; and it seems singular that so few traces of land life have resulted from so much research. Although in its southern portions it is strictly a marine deposit, yet its distance from shore could not have been very great at any point; but putting aside the few plants and mammalian remains, most of which in the coprolite portion of the Red Crag are derivative, there is little evidence of its proximity.

In that part of Suffolk near Chillesford and around the small

village of Butley, the later beds of the Red Crag appear, and land and freshwater shells are found in small numbers, but still exceedingly rare and scattered: they occur in most of the pits of that neighbourhood intermixed with marine mollusca, principally of an arctic and boreal type, and with some American forms of *Pleurotoma*, which have not been noticed elsewhere; but there is no evidence of a freshwater or even estuarine formation here, no shells of that character being present; there are no Hydrobiæ, only one *Conovulus (pyramidalis)*, an occasional Periwinkle, *Cardium edule*, fairly plentiful but always of marine form, and the whole of the shelly and sandy beds indicate, as Mr. Searles V. Wood has observed, a foreshore deposit.

The land and freshwater shells are all of living British species, are generally common in the recent state, and make their appearance in these beds for the first time. They are as follows:—

<i>Helix hispida.</i>		<i>Planorbis spirorbis.</i>
<i>Bulimus lubricus.</i>		<i>Limæa palustris.</i>
<i>Pupa marginata.</i>		„ <i>truncatulus.</i>
<i>Planorbis complanatus.</i>		„ <i>pereger.</i>

It is observable that all these species have a very wide range, extending through the whole of Europe from north to south, and the *Pupa* even into Iceland, so that in character they precisely agree with the whole of the marine fauna found with them, which is undoubtedly boreal, perhaps nearly arctic, in its general appearance.

In the older portion of the Red Crag, that is, from most of the pits and sections which occur about the rivers Deben and Orwell, and from Boyton and the cliff at Walton-on-Naze, which seem to be the oldest of all the beds, only one land-shell has been recorded since the specimen of *Helix Rysa* was described and figured by Mr. Searles Wood in 1848. This shell, which is of the same species, is in the Canham Collection at the Ipswich Museum, and came from the deep pit at Waldringfield close to the river. Lately, however, some careful work at Walton-on-Naze has resulted in the discovery of three more land shells in the lower beds, which it is desirable to notice, in the hope that future collectors at this well-known section may be able to increase the number.

With the exception of one fragment, these *Helices* have all been found in the lower and more tranquilly deposited beds of the Cliff. This portion is mainly composed of fine grey sand or silt, and lies between the London Clay and that band of single valves of *Pectunculus* and *Mactra arcuata* which occurs about the same horizon in several parts of the cliff; immediately under this band the sand is finest, and the following shells have been found at various times:—

*Helix Rysa*, S. Wood.

*Helix lens*, Férussac. Figured in Reeve's "Conchologia Iconica," vol. vii. pl. 178, fig. 1221.

A small and not quite adult shell was found about three years ago by Mr. Larcher, of King's College, and was at first supposed to be a young specimen of *H. Rysa*; unfortunately, in consequence of the death of Mr. G. S. Gibson, of Saffron Walden, in whose collection the type specimen was placed, no comparison with it could be made,

and the shell did not appear to the writer to quite agree, either with the engraving or description given of that species by Mr. Wood, nor did it appear to have relation to *H. rufescens*, to which Dr. Jeffreys had assigned *H. Rysa* as a variety; but after a careful examination of a large series of European *Helices* in the cabinet of Mr. J. H. Ponsoby, it was recognized as identical with *H. lens*, a shell that has an entirely southern range in Europe, occurring only in Morea and the Greek islands (Pfeiffer); in this identification both Dr. Jeffreys and Mr. Ponsoby concur.

*Helix incarnata*, Müller. Figured, Moquin-Tandon, Moll. de France, pl. 16, fig. 6 and 7.

This shell was found by the Prince of Mantua (Mr. Groom-Napier), in the course of some extensive excavations made at Walton, in 1882, which resulted in the fine collection of Red Crag Mollusca shown at the Fisheries Exhibition last year. It is not perfect, but the mouth, first whorl, and base of the shell remain, and seem quite identical with this continental species; hitherto this shell has not been noticed earlier than the Copford deposits, where it is associated with several others now extinct in Britain.

*Helix lactea*, Müller. Figured, Reeve, Con. Icon., vol. vii. pl. 147, fig. 955a.

A fine example nearly perfect was found by the writer last summer; the first and second whorls, the base and mouth of the shell, are quite perfect, and it retains its bands of brown colour; in a recent state this species is limited to the Mediterranean shores of Spain, France, and North Africa, where it is plentiful; it was compared with a large series from various localities, and resembles an Algerian form more than any other; a fragment of this species was also found in the Upper Red Crag bed by the same collector.

A comparison of the present geographical range of the above three recent species with that of the land shells of the Butley beds will exactly carry out the deductions which can be made from a similar comparison with the Marine faunas of the two places. At Walton it is mainly southern; at Butley the number of northern, American, and even arctic shells is very considerable—such species as *Amaura candida*, *Cardium Greenlandicum*, *Trophon scalariforme*, *Natica Greenlandica*, and several of those species of *Pleurotoma* which only occur in cold latitudes, indicate a northern character. But the presence or absence of certain species in any given bed of Crag (the fauna of which is by no means worked out yet) is not such good evidence as the numerical preponderance or scarcity of the individuals of common forms. The immense numbers of cold area shells, such as *Tellina obliqua*, at Butley, with its extreme scarcity at Walton, where *Natica multipunctata* (extremely scarce at Butley), is perhaps the most prevalent and representative form, whose range is entirely southern, will show a fairly characteristic difference in the two deposits. The whole evidence shows the very considerable change which came over the character of the Mollusca of the British Seas, indicating the gradual lowering of temperature and the setting in of arctic currents, which had already begun to take place in the earliest times of the Red Crag.

IV.—NOTE ON REMAINS OF THE EMU FROM THE WELLINGTON CAVES,  
NEW SOUTH WALES.

By WILLIAM DAVIES, F.G.S.

A FEW bones of birds are recorded by Mr. Gerard Krefft<sup>1</sup> as having been found in association with the remains of the extinct mammalia, which abound in the breccias of the caves and fissures in the limestone rocks of the Wellington Valley, New South Wales. The bird bones belong to various genera and species, but only those of the Emu seem, as yet, to have been identified, and these were in the possession of the late Rev. W. Branthwaite Clarke.<sup>2</sup> They do not appear to have been described, nor is the number of fragments in the collection stated. Unfortunately Mr. Clarke's valuable collection was deposited for exhibition in the "Palace Garden," a temporary building erected for the Intercolonial Exhibition at Sydney in 1879-80, and was consumed in the disastrous fire which destroyed the building and its contents soon after its close; and, as regards Mr. Clarke's specimens, the destruction of the material evidence on which the early appearance of the Emu in Australia was founded. However, there is preserved in the palæontological collections in the British Museum, South Kensington, a portion of a shin bone, that I discovered some years ago in a collection of fragmentary remains from the Wellington caves, presented to the National Collection by the Trustees of the Australian Museum, Sydney. The specimen is the distal end of a right tibia, somewhat mutilated, but is interesting as being additional evidence, still existing, of the Emu having been contemporary with the great extinct Marsupials; as such, and on account of the rarity of its remains, I have thought it worthy of a short notice. Compared with the tibia of an adult Emu (*Dromaius Novæ-Hollandiæ*), it is indistinguishable from it, but has belonged to a larger individual, as shown by the annexed few measurements, in inches and tenths.

	Fossil.	Recent.
Length of fragment .....	2 7 ..	
Transverse diameter at base of shaft ..	1 6 ..	1 4
Antero-posterior diameter ditto .....	1 0 ..	0 8

The condyles are too imperfect for comparative measurements, as the anterior portion of the outer condyle is wanting, and the margin of the inner is abraded.

Fossil remains of birds are rare in Australia, and, with the exception of the large Struthious bird (*Dromornis Australis*) described by Sir Richard Owen,<sup>3</sup> "such bones as have been found do not differ much from those of living genera."<sup>4</sup>

<sup>1</sup> Catalogue of the Natural and Industrial Products of New South Wales forwarded to the Paris Universal Exhibition of 1867, p. 112.

<sup>2</sup> Guide to the Australian Fossil Remains exhibited by the Trustees of the Australian Museum, Sydney, 1870. 8vo.

<sup>3</sup> Trans. Zool. Soc., 1873, vol. viii. p. 381.

<sup>4</sup> G. Krefft, "Australian Vertebrata—Fossil and Recent," p. 37, Sydney, 1871.

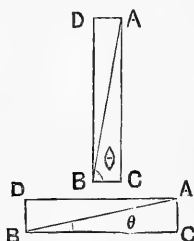
## V.—ON FAULTING, JOINTING, AND CLEAVAGE.

By the Rev. O. FISHER, M.A., F.G.S.

*(Continued from p. 213.)*

## PART III.

## REVERSED FAULTS.



WHEN the horizontal stress is a compressing stress, and exceeds the vertical stress, if motion of  $ADB$  is caused, it will take place in the direction  $BA$ ; and our formula becomes

$$\frac{1}{2} (P - W) \sin 2\theta = \mu. \quad (1.)$$

Where  $P$  is the horizontal and  $W$  the vertical compressing stress and  $\mu$  the force along  $BA$  which resists motion, all per unit area.

This condition must be satisfied in order that motion along  $BA$  may take place by shearing.

If, as before,  $\nu$  be the coefficient of friction, the friction upon unit area will now be,

$$\nu (W \cos^2 \theta + P \sin^2 \theta). \quad (2.)$$

Since  $P$  is always greater than  $W$  in the case of reversed faulting, this will be least when  $\sin \theta$  has the least ratio to  $\cos \theta$  which the conditions admit of. Hence the lesser angle which satisfies the condition (1) will, when other circumstances are favourable, determine the hade of the fault. We have already seen that a direct fault must have a higher hade than  $45^\circ$ . We may therefore conclude, on both accounts, that any fault having a lower hade than  $45^\circ$  must be a reversed fault.

But the converse conclusion does not hold, viz. that a reversed fault will necessarily have a lower hade than  $45^\circ$ . It will depend upon the room available for the motion, as well as upon other circumstances which cannot be easily appreciated. It is, however, clear that a fault cannot be formed unless the shearing force along  $BA$  is greater than the friction, or

$$(P - W) \sin \theta \cos \theta > \nu (W \cos^2 \theta + P \sin^2 \theta),$$

$$\text{or } \tan \theta < \frac{P - W}{2\nu P} + \sqrt{\left(\frac{P - W}{2\nu P}\right)^2 - \frac{W}{P}}. \quad (3.)$$

The highest possible value of  $\theta$  will be given when  $P$  is infinitely greater than  $W$ , and then we must have  $\tan \theta < \frac{1}{\nu}$

$$\text{or } \cot \theta > \nu.$$



That is to say, the inclination of the fault to the vertical (*i.e.*  $90^\circ - \theta$ , which we may call the co-hade) must be greater than the angle of repose, or else a fault cannot be formed, because the friction will be too great to allow of the surfaces moving past each other. It will be shown in Part IV. that this condition has an important consequence.

It must be recollected that  $W$  is the vertical compressing stress, and not the weight of the cover. Failure of support from beneath would therefore cause  $W$  to vanish.

A reversed fault would probably be the earliest consequence of horizontal compression affecting a tract of country. As the compression still further increased, and crumpling of the rocks supervened, the fault itself would be overturned, and perhaps so broken up as to be no longer recognizable as a fault, and certainly have lost its original hade. As the compression died away, in its later phases, faulting might again be sufficient to satisfy its energy. We might then find a highly disturbed tract affected by faults cutting up the distorted strata with a considerable degree of symmetry. For instance, in Dr. Stapff's section of Mont St. Gothard,<sup>1</sup> several faults are inserted. No doubt they must be to a certain extent imaginary, the only available data being the section as seen in the tunnel, and the outcrops of the strata. But probably we may rely upon the correctness of the section to a considerable extent. These faults do not reduplicate the nearly vertical strata, so that they are direct faults as regards verticality. They will, therefore, be reversed faults as regards horizontality, and have been produced by horizontal compression. The steepest has a co-hade of about  $22^\circ$ , and the least steep of about  $50^\circ$ . The existence of these various hades may be thus explained. Suppose a given value of the ratio  $\frac{W}{P}$ . Then the

relation (3) gives a limiting value of  $\theta$ , and sliding along a fault plane will not be possible for any larger value of  $\theta$ , *i.e.* for any steeper fault. Hence, if a fault has been already formed, and, as the pressure dies away, another fault is needed, sliding along the old fault is no longer possible, and a new one must be started which is less steep, to relieve the now lesser pressure.

Upon a large slate ( $27 \times 21\frac{1}{2}$  inches) from Cumberland, in the Woodwardian Museum, are two crossed faults, which reduplicate the horizontal strata, and together show a horizontal compression of about 2 inches. The hades of these faults are on an average about  $25^\circ$  and  $40^\circ$  respectively. There is a slight deviation from rectilinearity in their traces on the slate. They have evidently been formed along the lesser angles given by the relation,

$$\sin 2\theta = \frac{\mu}{\frac{1}{2}(P - W)};$$

and correspond to the surfaces of least friction given by (2).

These two miniature faults are perpendicular to the cleavage, and appear to have been formed while the sediment was still slightly ductile,

<sup>1</sup> Studien über die Wärmevertheilung im Gotthard. Bern 1877.

and before it was cleaved. The slate shows alternations of bedding of coarse and fine sediment, and evidence of extreme commotion of the sea-bottom at one interval of time. The question is, to what cause may the compression be attributed which produced the faulting? Possibly it was due to the contraction of two beds, above and below, exceeding that of the material between them, so that the latter became compressed horizontally to the extent of 2 inches. The faults pass beyond the slate, rendering it impossible to verify this explanation. But in similar cases *in situ* it might be tested.

The expression (3) gives a limiting value for the ratio of  $P : W$ , for we must have  $\frac{(P-W)^2}{4 \nu^2 P^2} > \frac{W}{P}$ ,  
or  $\frac{P}{W} > 2 \nu^2 + 1 + \sqrt{(2\nu^2 + 1)^2 - 1}$ .

If, for instance, the co-efficient of friction has a low value, as 0.3, which is its value for wet clay on wet clay, then  $\frac{P}{W} = 1.8$ ; or the horizontal compressing force must be 1.8, or nearly twice, the vertical, to allow of reversed faulting at all. If the co-efficient of friction has a higher value, as 0.7, which is that for dry masonry, then  $\frac{P}{W} = 2.8$ , or the horizontal force must be nearly three times the vertical to allow of reversed faulting at all.

There can be little doubt that some of the most important faults are not produced by such a disposition of forces as we have contemplated; but are the result of a direct elevatory force acting upon one side of the fault, or else by a failure of support upon the other side.

#### PART IV.

##### ON CLEAVAGE.

Cleavage is the property possessed by some rocks of splitting readily into laminæ of any desired thinness. The cleavage surfaces, which are approximately planes, are, within moderate areas, parallel to each other, and maintain a certain fixed direction.

Dr. Sorby's examination of the structure of slates convinced him, that the property of cleavage is due to the rearrangement of minute plates of crystals, and other unequiaxed particles, on the average along the planes of cleavage. The observations which he has recorded were made on thin sections examined by transmitted light.<sup>1</sup> If the surface of an ordinary roofing slate be examined under the microscope as an opaque object, it will be seen to be covered with minute striæ, that are scarcely perceivable when the light falls along them, but are sufficiently apparent when it falls across them. Small fragments of crystals, such as apparently of felspar, are arranged with their longer dimensions in the direction of the striæ. But there is no appearance of their being distorted. In coarse slates composed of volcanic agglomerate, from Borrowdale, such as is figured and

<sup>1</sup> Edinburgh New Phil. Journ. 1853. The writer hopes to recur to this part of the subject.

described by Phillips, the structure is easily observed, because the included masses are quite large. In a specimen from the same locality in the Woodwardian Museum at Cambridge, angular masses, of what was perhaps originally hornblende schist, are imbedded in a coarse greenish ground-mass. They are of various sizes, up to an inch and a half in length by three-quarters of an inch wide.<sup>1</sup> Sharpe's description of these slates, quoted by Phillips, exactly applies to this one. "In all these slaty breccias the included masses are flatter between the planes of cleavage than in any other direction. Their flattest sides are always parallel to the cleavage planes—they are usually rather longer on the line of dip of cleavage than along the strike." In the specimen in the Woodwardian, the included fragments now form small separate patches of a comparatively fine-grained slate with fine striæ running in the direction of the cleavage, so that the contrast of surface shows very clearly the different effect of the same action upon fine and coarse-grained rocks. These fragments are all thin, and none of them can with certainty be identified as passing through on the two faces of the slate; which is about three-eighths of an inch thick. They appear to have retained their original outlines, but to have been flattened to their present thinness by pressure, and rearranged so that they lie with their longer dimensions in the direction of the dip of the cleavage.

The internal action which could produce all these results is undoubtedly a pressure combined with a *shear*. A shear may be defined as a movement, by which the material on the opposite sides of any selected surface of shear are constrained to move with different velocities, the velocity increasing more and more as we advance further in one given direction. Fixing the attention on any one surface, as if it were at rest, the effect will be the same as if the material was moving in opposite directions on the two sides of it. The difference of action on the upper and under sides would tend to turn long, or flat, particles round, until they lay nearly in the direction of the surface; while a similar difference of action arising from unhomogeneity in the material would have the effect of placing them symmetrically with respect to the direction of the shear. These are the characteristics of a cleavage plane. A hard particle would be anchored in the material either on one or the other side of the surface, and would protect the material behind it, attaching it to its train, and thus a kind of "craig and tail" on a minute scale would be formed by it; thus giving rise to the striæ on the surfaces of cleavage. These would consequently be scarcely observable in slate formed out of very fine sediment, as is the case. The thinning of the particles points to great compression, and the same compression it has been, which has kept the molecules in cohesive contact, and enabled them to flow like a viscous substance, as in M. Tresca's experiments. Such shearing, however, has no effect to cause the section of any merely geometrical solid figure by one of the shearing surfaces to become elongated. Further investigation is perhaps de-

<sup>1</sup> Report of British Association on "Cleavage," 1856, p. 389. London, 1857.

sirable in the case of the green spots seen on many purple slates; for their elliptic form cannot be relied upon to prove elongation, unless we knew that they were originally spherical. The author has seen a family of these spots covering a slate laid down as a paving stone, in which the spots are of various shapes; and most of them contain traces of some foreign body as a nucleus, which has probably determined, not only their shapes, but also their positions: for the dark streak representing the fragment of former foreign matter lies as usual with its length parallel to the cleavage. This would lead one to suppose that the discolouration took place after the shearing.<sup>1</sup>

Fig. 1



The diagram (Fig. 1) illustrates the effect of a shear in altering the forms of a square, and of a circle, both without and with compression. We may regard the square as a section of a cube, and the circle as that of a sphere, and we see how they will be distorted into rhomboids and ellipsoids respectively. It will be remarked that every section of either rhomboid, parallel to the shear, and perpendicular to the plane of the paper, will be a square, equal to the section by the same plane of the original cube; and every section so made of the uncompressed ellipsoid will be a circle equal to the section of the sphere, and, in the case of the compressed ellipsoid, it will be a circle equal to the section, made by the same plane, of the oblate spheroid, into which a like compression would deform the sphere. The corresponding distortion of fossils may then be readily comprehended.

Professor Phillips wrote, "Cleavage is a peculiar structure impressed on certain rocks and in certain regions by the operation of some very extensive cause, operating after the stratified rocks had undergone great displacement. For this fundamental generalization we are, I believe, entirely indebted to Sedgwick."<sup>2</sup> The principal generalizations stated in his report are, that the direction of the cleavage usually coincides with the *mean* strike of the beds; and that the dip, or hade, of the cleavage is greatest where the disturbance has been greatest. He, however, told the author in conversation, during the meeting of the Brit. Assoc. in 1862, that the two great laws of cleavage are, that its strike is always very nearly coincident with the strike of the beds, and at anticlinals and synclinals it is normal to their surface and varies slightly from

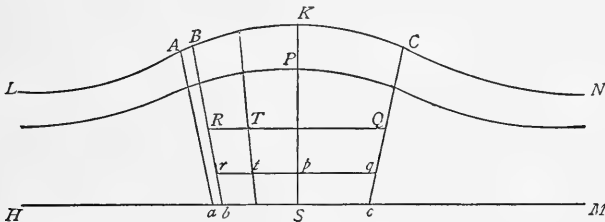
<sup>1</sup> The slate is in the yard of the Eagle Tavern at Cambridge.

<sup>2</sup> Phillips on Slaty Cleavage, Brit. Assoc. Reports of the meeting, 1856. Reports 1857, p. 373.—See Sedgwick, "On the Structure of large mineral masses," Trans. Geol. Soc. 2nd series, vol. iii. 1835, pp. 473, 474.

parallelism to this direction at intermediate points. In other words, that it is vertical at synclinals and anticlinals, and slightly inclined to the vertical between these.

Sharpe had remarked, "There are several circumstances which tend to show that the centre of an elevated district may have somewhat sunk down again after the completion of the original elevation, and of the cleavage."<sup>1</sup> The concluding words make it clear that he supposed the cleavage to have been established before the sinking. That it was subsequent to the elevation, and accompanying contortion and disruption of the strata, is evident, because it has not itself been affected by the contortion. But if cleavage was established after the elevation, and before the sinking, it is difficult to imagine to what mechanical action it can have been due. The suggestion now offered is that it was this very sinking, which Sharpe appears to have suspected from independent evidence, that originated the cleavage. We know that cleavage has been accompanied by pressure; and it is clear that an elevated ridge, on settling down, would be affected by a powerful horizontal pressure across it. But it is surely a mistake to suppose, that pressure across what became cleavage planes, could by itself be sufficient to induce cleavage. Some additional exhibition of force is requisite to produce that *quasi*-viscous shearing of the rock along the planes of cleavage, which we have pointed out to be the immediate cause of slaty structure. Let us then enquire whether a sinking and settling downwards of the elevated and contorted tract would induce a shearing of the rocks of which it was composed, and in the directions required for the phenomena of cleavage.

FIG. 2.



First conceive the simplest case of a single crest at *K*. Let *H S M* be the horizontal line within the elevated tract occupying at the moment under consideration such a position that the downward settlement would tend to compress the parts above it and distend those below it. At *L H* and *N M*, where the tract abuts on the undisturbed crust, there is no tendency to sink, and it is obvious that the greatest tendency in that direction will be along *K S*.

Take *A a*, *B b*, two surfaces very near together. Then the condition of their being surfaces of shear and cleavage will be that the velocity during settlement along one of them shall be uniform and shall differ from that along the other by the same difference everywhere, so that it also is uniform.

<sup>1</sup> Journ. Geol. Soc. vol. iii. p. 98.

The first question is whether these surfaces will be inclined synclinally or anticlinally towards the crest at *K*. The horizontal compression is caused by the tendency in the tract as a whole to become flattened by the excess of its weight over the support from below. It is clear, therefore, that the movement by which this flattening is effected, must tend to increase the horizontal stress. The planes of shearing must therefore have away from those portions of the tract which sink most, as at *P*, *Q*, and *R* in Fig. 3 (below), and if there be any such, towards those which rise relatively to the others, as at places intermediate between *P* and *Q* and *Q* and *R*.

Let *Cc* be a surface on the opposite side of the crest, so situated that the velocity along it is uniform, and equal to that along *Bb*. If, then, we draw two horizontal lines, *RQ*, *rq*, we have the velocities at *R*, *Q*, *r*, *q*, all equal to one another. But it is obvious that, whereas the whole mass *BbcC* is tending to pass, relatively to the rest of the tract, through *bc*, the passage being kept from being dilated by the horizontal pressure, the particles along *rq* must, on the average, be moving downwards faster than those along *RQ*, because *rq* is the narrower passage. But at *R*, *Q*, *r*, *q*, the velocities are all equal. Therefore the velocity must increase faster on going from *r* towards *q* than it does on going from *R* towards *Q*. If then we seek two points *T*, *t*, where the velocity shall be the same, the interval *RT* will be greater than *rt*. And points so determined will give another surface of shear and cleavage. We see then that, because *RT* is greater than *rt*, the cleavage planes will become more and more nearly vertical as they are less and less distant from the crest. And at the crest, where their inclination changes, they will be vertical. But, the change of velocity close to the crest being small, we may expect the cleavage there to be ill developed.

We will now approximately estimate the pressures within the tract under consideration. Draw a curve through *P*, which holds everywhere the same relative position between *LKN* and *HSM*; and let,

$$KS = h, KP = x,$$

*w* = the weight of unit mass,

*S* = the upwards pressure from below at *S*;

*P* = the tangential pressure through *P* upon unit area of the vertical section,

*r* = the radius of curvature at *P*.

Then the downward force acting on the column *KS* of unit section is *wh*—*S*; and this will produce an acceleration  $\frac{wh-S}{h}$  on all parts of the column.

Treating every curved slice, such as that through *P*, independently, it results from a well-known proposition that the tangential stress at *P* will be,

$$P = \frac{wh-S}{h} r.^1$$

<sup>1</sup> See "Physics of the Earth's Crust," p. 36, where the calculation in a somewhat similar case is made.

The tangential pressure anywhere across  $KS$  will be horizontal, but not quite so the tangential pressure across any other ordinate where it meets the successive curves. But the total resolved part of all the tangential pressures must be everywhere nearly equal to that supported at  $MN$  and  $LH$ , and consequently the same everywhere, so that we may take the value of  $P$  just found as fairly representing the horizontal pressure at any point of the curve that we have drawn through  $P$ .

To find the compressing force  $W$  we observe that the acceleration on  $KP$  is  $g - \frac{W}{KP}$ . And that on  $PS$  is  $g + \frac{W}{PS} - \frac{S}{PS}$ . And these must be equal whence we obtain

$$W = \frac{KP}{KS} S = \frac{x}{h} S$$

$$\text{Whence } \frac{W}{P} = \frac{x}{r \left( \frac{wh}{S} - 1 \right)}$$

$$= \delta \text{ suppose.}$$

Unless  $S$  is nearly equal to  $wh$ , *i.e.* unless the column is supported from below, this will be always small, because  $r$  is much greater than  $x$ ;  $\delta$  will therefore be always small while the settlement is going on.

We can now see why the conditions supposed will in general produce cleavage and not faulting. For if we take a parallelepiped within the mass as in the previous Parts of this paper, we know that faulting cannot be induced unless

$$\tan \theta < \frac{P-W}{2\nu P} \pm \sqrt{\left(\frac{P-W}{2\nu P}\right)^2 - \frac{W}{P}}$$

If we substitute  $1 - \delta$  for  $\frac{P-W}{P}$  and neglect the higher powers of  $\delta$ , we shall find that this condition is equivalent to

$$\cot \theta \geq \nu (1 + (1 + \nu^2) \delta).$$

*A fortiori*  $\cot \theta$  must be greater than  $\nu$ .

This implies that the relation between the pressures which is the consequence of the supposed conformation of the tract necessitates as a condition for faulting that the co-hade, or inclination to the vertical, of the surface of shearing shall be greater than the angle of repose for the particular kind of rock affected, a condition which is not compatible with a steep hade such as we have seen will occur in the neighbourhood of the crest of the ridge. Therefore we cannot have faulting there, but only viscous shearing, without separation of the rock along the surfaces of shear.

The distance between two surfaces of shear near enough together to be regarded as parallel must of course be measured along their common normal. If they encounter a layer of harder rock which does not shear so easily, any two surfaces of uniform velocity must recede from one another in crossing it. This will necessitate a change in

the hade of the shear (as it were a refraction)—a phenomenon known to occur under such circumstances, and if it should happen that the co-hade of the surface of shear when it crosses the harder bed should become greater than its angle of repose, that bed will be faulted or jointed instead of being cleaved. Instances of both these effects are figured by Phillips in his report,<sup>1</sup> and may be frequently seen accompanied by slickenside where a hard band crosses a coarse slate.

The downward acceleration being  $g - \frac{S}{h}$  will be greater where  $\frac{S}{h}$  is less, *i.e.* where  $h$  is greater. This justifies the assumption already made that the downward velocity will be greatest at the crest.

We have hitherto considered only the simple case of a single crest, and of one corresponding place of greatest sinking. But it is probable that, in an elevated and contorted tract, when settlement took place, it would not be uniform. Although the absolute movement might be everywhere downwards, nevertheless the movement of different regions relatively to the adjoining ones might be in some places downwards, and in others upwards. Where it was upwards, the conditions just now described would be reversed, and the surfaces of shear would slope in the opposite direction, that is, in an anticlinal manner towards the axis of greatest upward relative movement.

At some place intermediate between the synclinal and anticlinal cleavage, the relative movement would be *nil*, and in the neighbouring region the surfaces of shear would correspond nearly to the value of  $\theta$ , which would satisfy our equation,

$$\frac{1}{2} (P - W) \sin 2\theta = \mu :$$

where  $\mu$  expresses the force per unit area which would suffice to cause the rock to shear, or flow. This force being small in argillaceous rocks,  $\sin 2\theta$  need not be so large as to make the angle  $90 - \theta$  that is, the co-hade, greater than the angle of repose. If it should be so, there will be no cleavage developed in that region, but faults will supply its place, if there is relative movement at all. Such an arrangement of the cleavage surfaces accords with natural appearances.

In crossing the cleavage planes in the direction towards which they dip, the downward settlement increases at every step we take: and when the whole comes to be summed up for a distance of many miles, we must arrive at a surprising total, which must itself be measured by miles. Is such an amount of sinking conceivable? Let us inquire.

It seems impossible to account for the intense movements of various kinds, to which the earth's crust has been subjected, except on the hypothesis, that it rests on a yielding substratum. If this be true, the substratum must necessarily be more dense than the crust. This hypothesis will explain the simultaneous relative up-and-down movements, as well as the amount of sinking, required by the theory of cleavage now proposed.

Assuming that, when the contortion or disruption of the strata,

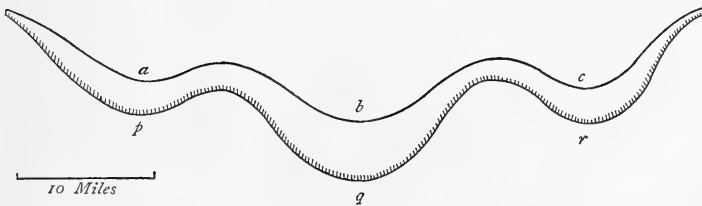
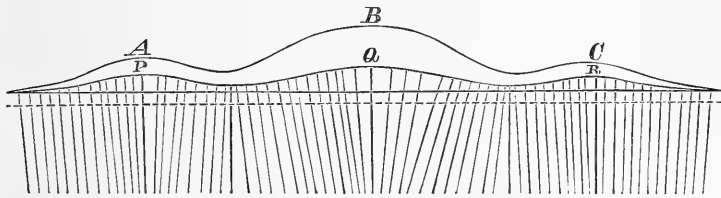
<sup>1</sup> *Loc. cit.* p. 384.



and the accompanying elevation, were produced, part of the thickened portion will have been forced relatively upwards, and part downwards; if the movement was not almost infinitely slow, the substratum, owing to its inertia and viscosity, would not allow of the position of hydrostatic equilibrium being assumed at once.

Hence, the cessation of the elevatory action will have left the disturbed tract in too elevated a position, in which it could not remain, but must sink more or less slowly, according as the substratum was more or less viscous; until at last the position of hydrostatic equilibrium will have been attained. It is of course impossible to predicate in what position the strata, which are now seen after many vicissitudes to occupy known positions, will have been originally left, when newly elevated. But if we assume an initial position, and the ratio of the densities of the crust and substratum, we can roughly indicate by a diagram the subsequent settlement. Let us take, for the ratio of the densities, that of granite to basalt, or of 2.68 : 2.96. This is very nearly the same as of ice to water, so that the behaviour of ice floating on water will closely illustrate the hydrostatic position of the crust when in equilibrium.

FIG. 3.



In the figure, *ABC* is supposed to be the mean initial outline of the elevated portion which has been forced upwards, *abc* of that which has been forced downwards. The broken line is the effective level of the substratum. If *ABC* sinks to *PQR*, *abc* will sink to

*pqr*, and the proportions, as defined by the shaded line, of the downward protuberance, or "roots of the mountains," will be about that required for equilibrium. The height, to which the disturbed tract is represented to have been forced up, is no doubt very great. But so little is known of the sort of positions, in which the rocks of elevated regions were left when first raised, that it cannot be *a priori* pronounced impossible. The laws, which govern the initial positions and height of mountainous regions after great disturbance, are an unsolved problem in geology. It must not be understood, because the mean surface is represented as undulating, that the rocks are asserted to have been plicated in curves parallel to it. Much less is it meant to be implied by the diagram, that the present surface is identical with the original elevated surface, sunken. It will be rather some part of the crust below the sea-level in the diagram, re-elevated and denuded.

In a few words then, Cleavage is due to an internal movement of the rocks, rendered necessary by the disturbed region having been left, after elevation, in a position too lofty for equilibrium. This internal movement would have been accomplished by faulting, had not the friction been too great, owing to pressure, to allow of sliding along surfaces of separation.<sup>1</sup> Viscous shearing therefore performed the office, and produced cleavage surfaces.

---

## REVIEWS.

---

- I.—THE GEOLOGICAL HISTORY OF THE SERPENTINES, INCLUDING STUDIES OF PRE-CAMBRIAN ROCKS. By THOMAS STERRY HUNT, M.A., LL.D., F.R.S. From the Trans. Roy. Soc. Canada, vol. i. sec. iv. 1883. (Montreal, Dawson, Brothers.)

THIS communication is, to a certain extent, one of the results of the International Congress of Bologna (1881), where great interest was evinced in the question of Serpentine, a special meeting having been held under the presidency of Dr. Hunt, in which both French and Italian geologists of high standing took a part.

Serpentine, even by itself, is a very slippery subject, and when it is allowed to shade off through innumerable ophiolites, ophicalcites, etc., into the sparry and earthy carbonates on the one hand, and through the serpentized gabbros into the felspar-pyroxene rocks on the other, there is endless scope for mystification. Moreover, if to all this be added certain "Studies of Pre-Cambrian Rocks," we have the elements of a considerable amount of that geological theorizing for which the writer is so celebrated. Nevertheless we are bound to admit that many of Sterry Hunt's ideas, both in the Serpentine and Pre-Cambrian connection, are not so much regarded in the light of mere theories as they were a few years ago. He has lived to see the old doctrines of the regional metamorphism of

<sup>1</sup> This appears to be the rationale of M. Tresca's experiments, by which he proved that solid, ductile, or pulverulent bodies, can, without changing their states, flow in a manner analogous to that of liquids, when sufficiently great pressure is exerted on their surface.

Palæozoic and Mesozoic sediments getting more and more into disfavour every year, and if his diagenic notions as to the origin of serpentine are not yet generally accepted, he can point to several men of eminence who hold these views with more or less modification.

Subjoined is an abstract of the author's summary of the chief points regarding serpentine and ophiolitic rocks as set forth in the paper before us:—

1. History of opinion.
2. To show how, from the hypothesis of their eruptive origin, came the application of that of metasomatism, and also to set forth the hypothesis of the aqueous origin of serpentine, explaining how silicates of magnesia may, on chemical grounds, be looked for at any geological horizon.
3. To indicate the various horizons at which serpentines are found in the Archæan rocks of North America, all being regarded as indigenous stratified rocks.
4. The occurrence of serpentine amongst the gypsiferous rocks of the Silurian series at Syracuse, N.Y.
5. Having noticed some points regarding the nomenclature of serpentine and related rocks, and Bonney's account of the serpentines of Cornwall, and parts of Italy, the author considers the serpentine-bearing rocks of the Alps, in which he shows four great groups in ascending order, viz. (*a*) the older gneiss, (*b*) the *pietre-verdi* or greenstone series, (*c*) the newer gneisses and mica schists, and (*d*) the still younger lustrous schists. Of these *b*, *c* and *d* contain interstratified serpentines; the youngest of these groups includes the marbles of Carrara.
6. This youngest group not Mesozoic; relations of these crystalline schists to the fossiliferous rocks of the mainland of Italy and the islands; their Pre-Cambrian age. The ophiolites, etc., which have been referred to the Tertiaries, are but exposed portions of these Pre-Cambrian rocks.
7. The crystalline rocks of the Simplon and the St. Gothard, and those of Saxony and Bavaria are considered, and are compared with the younger gneisses of North America.
8. The serpentine mass of Monteferrato regarded as Archæan.
9. The genesis of serpentines.
10. The geognostical history of olivine is discussed, and the essentially Neptunian origin of many olivine rocks maintained.

11. Geognostical relations of serpentine: the appearances of intrusion to be explained by subsequent movements of the strata in which the serpentines are included.

The geological history of serpentines, as above set forth by Dr. Hunt, may therefore be divided into two principal branches, one of which deals with theories as to the origin of the rock, and is mainly chemical; the other, relating to its geognosy, is intimately mixed up with the study of the Archæan rocks, in which, for the most part, the serpentines are said to be interstratified.

*The Genesis of Serpentine.*—Out of some half-dozen theories, accounting for this most unaccountable rock, mentioned by Dr. Hunt, we may select three principal ones for consideration.

I. The most improbable is the doctrine of unlimited substitution, whereby an integral conversion of ordinary types of felspathic rocks into serpentine takes place through the complete elimination of the alumina, alkalies, and lime, and the replacement of these bases by magnesia. Both Sterry Hunt and his antagonist, Professor Bonney, are strongly opposed, as is well known, to this hypothesis, which the former characterizes as nearly obsolete. Not but what rock substitution has certainly taken place on a considerable scale, whilst pseudomorphs of serpentine after pyroxene and even more aluminous

minerals are far from being unknown. Yet the difficulties presented by the removal of such large quantities of alumina are such as to leave it very doubtful whether the substitution theory can be accepted in the case of large masses of the nearly pure magnesian, or more correctly speaking, ferromagnesian, hydrous silicate.

II. The plutonic theory has of course many supporters, and may on the whole be described as the one generally adopted. This again is much subdivided: some, like Daubrée, maintaining the direct ejection of the hydrous silicate; others, like Bonney, that serpentine results from the hydration of eruptive olivine rock: and there is also another hypothesis which Hunt characterizes as hydroplutonic, and which has many supporters among Italian geologists. This might almost be placed in a separate category; but as an eruptive origin is claimed, it must be classed with the other plutonic theories. It supposes that the material was ejected from the earth's interior, not in a state of igneous fluidity, but as an aqueous magma or mud, consisting essentially of a hydrous silicate of magnesia, which subsequently consolidated into serpentine, and ultimately into olivine and enstatite, thereby reversing the usual supposition as to the hydration of these minerals having been the origin of serpentine rock, which is itself regarded simply as a preliminary stage towards the formation of the anhydrous silicates.

It is not at all improbable that such eruptions of magnesian mud may have occurred; indeed, the very curious phenomena of the South African diamond fields seems to be best explained on some such hypothesis: nevertheless it merely postpones the difficulty one stage, since such magmas could only proceed from a mass analogous to, if not identical with serpentine, which was seated at some depth below, and subjected to heat and pressure sufficient to cause an extravasation with the constitutional water entangled in the viscous mass and acting partly as the carrier. Dr. Hunt regards these ideas of the Italian geologists as merely an attempt to accommodate the presumed igneous origin of serpentine with certain stratigraphical conditions in which they are seen to occur. But his merriment at the notion of a subterranean providence "which could send forth at pleasure from its reservoirs alike granite and basalt, olivine rock and limestone, quartz rock and magnetite," is somewhat beside the mark, if indeed it is not a kind of device for producing a false impression, by associating rocks for the most part of eruptive origin with those that are not so.

III.—The author himself asserts the *aqueous origin* of the masses of native magnesian silicates, and their formation by reactions between the soluble silicates of lime and alkalis, derived from decaying rocks, and the magnesian salts of natural waters. Thus would be formed, we suppose, even the anhydrous magnesian silicates, just as augite and the felspars may be formed in the wet way. Dieulafait's notion is an improvement on Hunt's idea, since he regards serpentine as having been formed in estuaries of the sea by the reactions between the siliceous matters derived from the decay of pre-existing rocks and the magnesian salts of sea-water.

Doubtless since the masses of rock known as serpentine occur in such various ways, and are so heterogeneous in composition, they may well be allowed to have had more than one origin. Dr. Hunt long ago pointed out the differences between the ophiolites of the quondam Laurentians<sup>1</sup> associated with *Eozoon*, and the more massive rocks consisting mainly of serpentine, which are so often associated with small quantities of nickel. Professor Bonney, too, has always been desirous of showing that his views as to the alteration of olivine rock being the chief source of serpentine, do not necessarily extend to what he calls "serpentinous" rocks, which he admits may be the result of the alteration and hydration of mixed silicates. On the other hand, Dr. Hunt (p. 168), as a concession to those who maintain the occurrence of eruptive serpentine, allows that the final result of heat aided by water on silicated rocks would be their softening and in certain cases their extravasation as plutonic rocks, which are to be regarded as, in all cases, altered and displaced sediments. Sterry Hunt has, in fact, a rooted objection to internal magmas, although he allows that some basalts may possibly be portions of an original igneous mass, which antedated the appearance of liquid water at the surface of the globe.

The fundamental difference between Dr. Hunt and Professor Bonney is more especially shown where the former considers the subject of olivine rocks in their relations to serpentine. He sees no reason why the olivine and enstatite found in greater or less quantities in serpentine rocks should not represent the crystallization of anhydrous silicates in the midst of amorphous hydrous silicates; and in this way he endeavours to outflank those who insist upon the presence of these minerals, and especially of olivine, as proof that serpentine has been derived from their hydration. It is, in fact, a battle between the chemist who can point to the paragenesis of hydrous and anhydrous minerals—as for instance, grains of corundum in bauxite—and the microscopist who can show how readily olivine is pervaded by cracks filled with serpentine as a proof of the instability of that mineral.

It is certain that recent discoveries have made us acquainted with conditions where it would be difficult to assign any other than an aqueous origin to large masses of olivine, unless we are prepared to assert that such rocks as the schists of Mount Ida in the Troad for instance are igneous. Indeed, it would seem that the more we accept the "Archæan" as opposed to the metamorphic origin of the crystallines, the more doubtful shall we become as to the eruptive character of many of these magnesian rocks, or of the massive serpentines having been derived from the hydration of olivine. At any rate, if such hydration has taken place on a large scale, it must have been made under conditions very different from those which now obtain on the surface of the earth.

The difficulty with regard to the oxygen ratios, to which the

<sup>1</sup> If we understand the present Director of the Canadian Survey, he no longer regards the Grenville series as Laurentian, that designation being restricted to the *gneiss without limestone*, which alone represents the fundamental series.

author alludes, is perhaps more apparent than real. In the first place, it does not follow that, supposing a change from olivine to serpentine to have taken place, the amount of silica should remain constant; secondly, allowing, for the sake of argument, that the silica underwent no augmentation or diminution, there is every probability of the existence of sufficient of the bisilicate, enstatite, in the original rock to bring up the amount of silica in the resulting serpentine to the normal standard. It seems, however, that Scheerer, influenced partly by considerations of this sort, was led to reject the notion of the derivation of the serpentine of Snarum, in Norway, from a previously-formed olivine.

*The Stratigraphical Relations of Serpentine.*—But little space is left for us to discuss this section of the subject, which, as treated by the author, involves that of the Archæan rocks themselves. There is a great amount of information as to Alpine and Italian geology in this portion of the paper, and the numerous references to those who have written on these questions makes it a valuable compendium. Practically there seems to be a fair consensus of opinion amongst most of the recent writers on fundamental points, the old metamorphic theories as to many of these schists being of Triassic or Jurassic age seeming to be generally abandoned. Thus, Professor Bonney, in his recent lecture at the Royal Institution on the "Building of the Alps," gave the following sequence of the presumably Archæan rocks from above downwards :

- C. Lustrous schists.
- B". Friable gneiss.
- B'. Pietre-verdi.
- B. Bedded gneiss.
- A. Central gneiss.

In this arrangement we have three primary groups, though the central one is made to consist of three members, which, in some cases perhaps, replace each other.

Comparing this in the same order with the correlations of Dr. Hunt—

The Lustrous schists	=The Taconian.
The Mica schist series	=The Montalban.
The Pietre-verdi	=The Huronian.
The central granitoid gneiss	=The Laurentian.

We have already seen that serpentines occur in all three groups above the central granitoid gneiss, but are especially abundant in the Pietre-verdi, or zone of greenstones. Since the crystalline rocks of Italy, according to the majority of writers quoted by the author, are merely the Alps deflected and brought up again, it follows that the Italian serpentines occupy for the most part positions analogous to those in the Alps.

This is known and admitted in many cases to be so, but Dr. Hunt will not hear of any Tertiary serpentines at all. Even the celebrated mass of Monteferrato, in Tuscany, which Bonney maintains (*GEOL. MAG.* Aug. 1879) to be of late Cretaceous or early Tertiary age, is set down as Archæan, just as are certain serpentines in connexion with Triassic strata near the city of New York, which are described

in the second chapter of the present paper. The appearance of intrusion into the adjacent sedimentary beds in such cases is delusive, and is better explained on the supposition of a knob of hard rock which had resisted atmospheric erosion better than the encasing schists, so as to form a boss against which beds of a later age were deposited. Subsequently movements took place resulting in such complicated geognostic relations between these hard old knobs and the softer Mesozoic or Tertiary sediments, as to simulate the appearance of intrusion.

Lastly, it should be mentioned that Dr. Stapff, "the learned and acute geologist of the St. Gothard tunnel," speaks of movements arrested by the hard and tough mass of the serpentine, met with during the excavation, as having produced in the neighbouring rocks "perturbations much more intense than would have resulted from similar movements acting upon a more tender rock." Dr. Stapff regards the serpentine of St. Gothard tunnel as "originally a deposit of hydrated silicate of magnesia, formed by springs, and enclosed between the sediments which gave rise to the mica-schists." W.H.H.

II.—BEITRÄGE ZUR KENNTNISS DER SPONGIEN DER BÖHMISCHEN KREIDEFORMATION. VON PHILIPP POČTA. I. Abtheilung: Hexactinellidæ. Mit 5 litho. Tafeln und 19 fig. im Texte, 1883. II. Abtheilung: Lithistidæ. Mit 2 lith. Tafeln und 26 fig. im Texte, 1884. (Abhandlungen der Königlichen böhm. Gesellschaft der Wissenschaft, VI. Folge, 12 Band.)

UEBER ISOLIRTE KIESELSPONGIENNADELN AUS DER BÖHM. KREIDEFORMATION. VON PHILIPP POČTA. Mit 2 Tafeln. (Aus den Sitzungsberichten der k. böhm. Gesellschaft der Wissenschaften. Prag, 1884.)

CONTRIBUTIONS TO THE KNOWLEDGE OF THE SPONGES OF THE BOHEMIAN CHALK-FORMATION. By PHILIPP POČTA. Part I. Hexactinellidæ. With 3 lithograph plates, and 19 figs. in the text 1883. Part II. Lithistidæ. With 2 lithograph plates, and 26 figs. in the text. 4to. (Memoirs of the Royal Bohemian Science Association. Prague, 1884.)

ON DETACHED SILICEOUS SPONGE SPICULES FROM THE BOHEMIAN CHALK-FORMATION. By PHILIPP POČTA. With 2 plates. 8vo. (From the Sessional Reports of the Royal Bohemian Science Association. Prague, 1884.)

THE stimulus which has been given to the study of fossil sponges by the publication of Professor Zittel's elaborate work on the structure and affinities of these organisms, is shown by the various memoirs now appearing in this and other countries, in which these forms are arranged according to the new system of classification proposed by Zittel. Herr Počta has undertaken the laudable task of investigating the minute characters of the sponges met with in the Cretaceous rocks of Bohemia, and the works quoted above contain the results of his studies of the Hexactinellidæ, Lithistidæ, as also of the detached spicules of the Monactinellidæ and Tetractinellidæ. The form and other macroscopic characters of many of these sponges

have been already made known in the works of Reuss, Geinitz and Römer; but this is the first attempt to ascertain systematically their minute structure. It is rather unfortunate, however, that the author could not obtain access to the original types of Reuss's species, described in the "Versteinerungen der böhmischen Kreideformation," and could therefore only rely on the descriptions and figures for comparison; as, however, the sponges described by the author, now forming part of the collection in the Royal Bohemian Museum at Prague, were obtained for the most part from the same localities as Reuss's types, there is less liability to mistake in identifying his species.

The lowest strata of the Cretaceous series of Bohemia in which fossil sponges are found—the Korytzaner beds—are referred to Cenomanian age. They consist mainly of calcareous and marly materials deposited in fissures in gneiss. From these beds by far the larger majority of the sponges have been obtained, as from the accompanying tables of species it appears that out of a total number of 99 species of Lithistids and Hexactinellids, 77 are present in them. In the overlying Weissenberger and Malnitzer strata, of Turonian age, only 15 species have been observed; and from the succeeding Senonian strata, divided respectively into Iser, Teplitzer, Priesener, and Chlomek-schichten, 22 species are recorded.

As regards their state of preservation, the Bohemian fossil sponges present nearly similar conditions to those of this country. In some examples the siliceous skeleton is but little altered by fossilization, so that by treatment with dilute acid the sponges may be nearly entirely freed from the matrix, but in the majority of instances the original structures have been altered to a greater or lesser degree, and the delicate siliceous spicular mesh has been masked by accretions of silica or replaced by crystalline calcite, iron pyrites or iron peroxide. The author notices as a peculiar fact that even in the same locality the condition of the sponges is very variable, and not infrequently, examples with perfectly preserved skeletons occur in the same beds with others in which the skeletal structure has been destroyed or replaced.

The first part of the work treats of the Hexactinellids, of which there are 31 species ranged under the following genera: *Craticularia*, *Leptophragma*, *Pleurostoma*, *Guettardia*, *Petalope*, nov. gen., *Synaulia*, nov. gen., *Lopanella*, nov. gen., *Botroclonium*, nov. gen., *Stauronema*, *Ventriculites*, *Plocoscyphia*, *Tremabolites*, *Cyrtobolia*, nov. gen., *Diplo-dictyon*, and *Cæloptychium*. No fewer than 21 species are regarded as new. The Lithistids, described in the second part, are placed under 46 species; of which 21 are new forms, though the author has only constituted a single new genus, *Paropsites*. The greater number of forms belong to the Rhizomorina family, and the following genera are represented, *Bolidium*, *Astrobolia*, *Chonella*, *Seliscothou*, *Chenendopora*, *Verruculina*, *Stichophyma*, *Cælocorypha*, and *Scytalia*. A single species each of *Doryderma* and *Isoraphinia* belong to the family of the Megamorina. The Tetracladina family are represented by the genera *Phymatella*, *Siphonia*, *Jerea*, *Polyjerea*, *Astrocladia*, *Thecosiphonia*, *Racodiscula*, *Paropsites*, *Ragadinia*, and *Plinthosella*.



There appears to be in reality but few of the species described, common to the Cretaceous series of Bohemia and this country; the author has in some instances, however, been led astray by the similarity of the old names, and has erroneously identified some English forms with Bohemian species. Thus, for example, *Scytalia* (*Spongia*) *terebrata*, Phill. sp., is referred to *Seliscothon Mantelli*, Goldf. sp., *Manon marginatum*, Sharpe, a calcareous sponge from Farringdon, is placed as synonymous with *Verruculina Phillipsi*, Reuss. sp., and *Scytalia* (*Spongia*) *radiciformis*, Phill. sp., is referred to *Phymatella elongata*, Reuss. sp.

In the same strata with the above-mentioned Hexactinellid and Lithistid sponges there also occur detached spicules of Monactinellid and Tetractinellid forms which are referred to the genera *Reniera*, *Geodia*, *Stelletta*, *Pachastrella*, and *Tisiphonia*.

Accompanying the descriptions of the new species, the author has given figures of the sponges themselves in the text, and representations of the magnified spicular structure in the five lithographed plates at the end of the work. The woodcuts are not altogether satisfactory, but probably their indefinite outlines result from the unfavourable state of the specimens themselves. G. J. H.

---

## REPORTS AND PROCEEDINGS.

---

### GEOLOGICAL SOCIETY OF LONDON.

I.—April 23, 1884.—Prof. T. G. Bonney, D.Sc., F.R.S., President, in the Chair. —The following communications were read:—

1. "On the Geology of the Country traversed by the Canada Pacific Railway from Lake Superior to the Rocky Mountains." By Principal J. W. Dawson, C.M.G., F.R.S., F.G.S.

This paper recorded observations made by the author with reference to the geology of the north-west territories of Canada, in an excursion in the summer of 1883, along the line of the Canada Pacific Railway as far as Calgary, at the eastern base of the Rocky Mountains.

After referring to the labours of the Canadian Geological Survey, and more especially of Dr. G. M. Dawson, F.G.S., in this region, the author proceeded to notice the Laurentian, Huronian, and other Pre-Silurian rocks of the west of Lake Superior and the country between that Lake and the Red River. Good exposures of many of these rocks have been made in the railway-cuttings, and important gold-veins have been opened up. The Laurentian rocks present a remarkable uniformity of structure over all the vast territory extending from Labrador to the Winnipeg river, and where they reappear in the mountains of British Columbia. They are also similar to those of South America and of Europe; and there was on the table a collection of Laurentian rocks from Assouan, in Upper Egypt, made by the author in the past winter, which showed the reappearance of the same mineral characters there. In Egypt there is also an overlying crystalline series, corresponding in some respects with the Huronian. The Huronian rocks west of Lake Superior are, however, more crystalline than those of Lake Huron, and may be of greater age.

The Palæozoic rocks are exposed in places on the western side of the old crystalline rocks near the Red River, and show a remarkable union and intermixture of Lower and Upper Silurian forms, or rather, perhaps, a transition from the one fauna to the other in a very limited thickness of beds. The collections of Mr. Panton, of Winnipeg, were referred to in this connexion.

The Cretaceous and Eocene beds of the plains were then noticed, and certain sections showing the coal-bearing series described; and comparisons were instituted between the Cretaceous and Eocene succession in Canada and that in the United States and elsewhere.

The Pleistocene drift deposits constitute a conspicuous feature on the western prairies. Along the railway, Laurentian, Huronian, and Palæozoic boulders from the east may be seen all the way to the Rocky Mountains, near which they become mixed with stones from these mountains themselves. The vast amount of this drift from the east and north-east, and the great distance to which it has been carried, as well as the elevation above the sea, are very striking. The great belt of drift known as the Missouri Coteau is one of the most remarkable features of the region. It was described in some detail where crossed by the railway, and it was shown that it must represent the margin of an ice-laden sea, and not a land-moraine, and that its study has furnished a key to the explanation of the drift deposits of the plains, and of the so-called "Terminal Moraine," which has been traced by the geologists of the United States, from the Coteau round the basin of the Great Lakes to the Atlantic.

2. "On the Dyas (Permian) and Trias of Central Europe and the true divisional line of these two formations." By the Rev. A. Irving, B.Sc., B.A., F.G.S.

The author, having shown (in previous papers, which appeared in the GEOLOGICAL MAGAZINE during the year 1882) the inapplicability of the "Permian System" of Murchison to the British Post-Carboniferous rocks, and having had reasons for doubting the supposed conformity between the Zechstein and the Bunter in Central Europe (on which Murchison and his collaborateurs have laid so much stress), has, with the aid of Professors Geinitz and Liebe and Dr. Von Hauer, investigated the subject independently, both by examination of sections in the field, and by the study of the evidence preserved in the Museums, especially those of Dresden, Vienna, and Freiberg. The sections described in this paper are from:—(1) *Silesia* (Ostran), in which Dr. A. Dittmarsch is followed; (2) *Murane* (Saxony); (3) *Northern Thuringia*. Those in districts (2) and (3) are from the author's own observation last summer. The stratigraphical evidence shows that there is a *very marked break in time* between the Zechstein and the Bunterschiefer of Murchison, which he included in the "Permian System." Almost every kind of discordance that can possibly occur between two successive series of strata is shown to occur in Central Europe between the Dyas and Trias, and in particular between the Bunter and the Zechstein; physical and stratigraphical evidence therefore confirm the classification adopted by Geinitz on palæontological grounds.

The meaning of the name "Dyas," which has become well established abroad, was illustrated, since it is often overlooked by English geological writers; and a Dyassic order was pointed out as existing to some extent in the English series.

Some general reasons, based on the *physical* characteristics of the Dyas-group, were given for regarding it as much more closely allied to the preceding Carboniferous than to the succeeding Trias.

The last portion of the paper was more speculative, and in it an attempt was made to trace, in the facts we know of the geology of Central Europe, and the inferences drawn from them, the causes of the apparent anomaly between the fauna of the Post-Carboniferous strata of more northern Europe and that of the Alpine Trias.

---

II.—May 14, 1884.—1. "On the Pre-Cambrian Rocks of Pembrokeshire, with especial reference to the St. David's District." By Dr. Henry Hicks, F.G.S., with an Appendix by Thomas Davies, Esq., F.G.S.

The author, in this paper, gave further detailed evidence in addition to that already submitted by him, to show that the Geological Survey Map of the district of St. David's and of other parts of Pembrokeshire is incorrect in some of its most essential features, and inaccurate in very many of its petrographical and stratigraphical details. Some new areas in South Pembrokeshire were also referred to. He replied also to the criticisms contained in the paper by the Director-General of the Survey, read last year before the Society, and indicated that Dr. Geikie had completely misunderstood the sections and the order of succession of the rocks at St. David's. He pointed out that the views so elaborately worked out by the Director-General, to show the evidence of metamorphism in the rocks, were based on the entirely false supposition that the granitoid rocks were intrusive in the Cambrian rocks, and that the felsites were merely peripheral masses. He showed, by producing abundant fragments of the Granitoid rocks and of the Felsites from the basal Cambrian conglomerates, that the granitoid rocks were the very oldest rocks in the district, and that they must undoubtedly be of Pre-Cambrian age. He proved, from microscopical evidence, that the rocks supposed to have been altered by the intrusion of the granitoid rocks, were in the condition in which they are now found before the Cambrian rocks were deposited, and moreover, that the supposed concretions in the Porcellanites and Conglomerates, claimed to have been due to metamorphism, had turned out, on microscopical evidence, to be actually fragments of old Pre-Cambrian rhyolites enclosed in the sediments. It was shown also that at the points indicated by the Director-General, where the evidences of intrusion were supposed to be seen, there was not the slightest change of a metamorphic character induced in the sedimentary rocks in contact with the granitoid rocks. The only difference that could possibly be recognized in them by the aid of the microscope was such as is well known to be the result of crushing when in the neighbourhood of faults. Indeed there was the clearest evidence possible to show that the junctions were merely fault-junctions. The supposed fold in the Pebidian

rocks, the author stated, was impossible if petrological evidence was of any value. The author also produced many facts to show that the conglomerates at the base of the Cambrian constantly overlapped the different members of the series which he claimed to be of Pre-Cambrian age, and that the unconformity was very marked and to be clearly seen in many coast-sections. The conglomerates were shown also to contain well-rolled pebbles of all the series included under the names Dimetian, Arvonian, and Pebidian, as proved by careful microscopical examination of the fragments by Mr. T. Davies and himself. An Appendix, by Mr. Davies, describing the microscopic character of the rocks, accompanied the paper.

---

### CORRESPONDENCE.

---

#### *TRIGLYPHUS*, FRAAS; AND *TRITYLONDON*, OWEN.

SIR,—I have been favoured by Prof. Neumayr with an extract from the "Neues Jahrbuch für Mineralogie," 1884, containing a passage from the work by Prof. Fraas "Vor der Sündfluth," which I regret not to have seen, and of which I add a translation. With the above passage Prof. Neumayr adds a woodcut of the fossil tooth in question:—

"Fraas describes in his work, 'Before the Deluge,'<sup>1</sup> a peculiar little tooth from the Bone-bed, near Stuttgart; under the name *Triglyphus*, and he supplies the above figured very accurate woodcut of this unique specimen, which was, unfortunately, afterwards lost.

"This *Triglyphus* corresponds in a marked manner with the *Tritylodon* from the Cape; both show exactly the same fundamental type, although there are differences in the structural details and there may be good reason for a generic separation. In both the tooth is subquadrate the upper (masticating) surface is divided by two deep furrows from the front backwards into three longitudinal crests resembling each other, each of which is again divided by oblique incisions (cross furrows) into separate protuberances. It appears also that the number of those protuberances nearly corresponds, as the number in each row, "which come first in sight," is three, as well in the one as in the other specimen.

"Unfortunately we know only one tooth of *Triglyphus*, but it is sufficient by its marked configuration to confirm a very remarkable and close affinity between a South African and a central European 'Trias mammal.'"

RICHARD OWEN.

---

#### ARE THE BLACKDOWN BEDS THE EQUIVALENTS OF THE GREY CHALK AT DOVER?

SIR,—A paper on British Cretaceous Nuculidæ was published in the Quarterly Journal of the Geological Society for February. In it I show (p. 142) that three out of four of the Grey Chalk species are identical with those of Blackdown and with no others. Mr. Downes has since this publication found what I believe to be the fourth species, named *N. pectinata*, var. *cretæ*, at Blackdown, so that all the Grey Chalk species are now known to be common to the two formations.

<sup>1</sup> Vor der Sündfluth, p. 215.

I think that had I seen Mr. Downes' specimen I should have separated it under a distinct specific name instead of considering it merely a variety. It is singular that Dr. Fitton included *N. pectinata* in his list of Blackdown fossils; but as no specimen was known, I thought it likely that a specimen of *N. antiquata*, exhibiting pectinate structure, and which is still preserved in his original collection at Bristol, had been mistaken for it. I had previously noticed Blackdown species in the Grey Chalk, and think that when allowance is made for the different quality of sea-bottom, and the much greater probable depth of the Chalk sea, enough species will remain in common to prove that the two formations are practically of about the same age, or that at least the Blackdown Beds are much newer than the Gault.

J. STARKIE GARDNER.

“ELEVATION AND SUBSIDENCE.”

SIR,—I either fail to comprehend Mr. Starkie Gardner's argument, or he seems strangely to misunderstand the value of the evidence afforded by the presence of stratified sand with marine shells at an elevation of 500 feet in Scotland. He seems to admit that it means the total disappearance of all ice below that level. Now this implies that the larger proportion of the ice-sheet, which he assumes was the cause of the depression of the land, had been entirely removed, and further that a very considerable part of it must have been floated off long before that degree of submergence was reached—assuming with Mr. Gardner that the land was depressed during glacial conditions, which is not the belief of the most competent authorities upon the glaciation of Scotland.

Mr. Gardner says that in the course of submergence “the Firth of Tay would in fact become a fiord.” I do not wish to repeat Mr. Gardner's slighting phrase, but I really do not know what he means by that. I understand that fiord and firth are convertible terms, or perhaps that the latter is a fair attempt to spell out in English the Norse pronunciation of the former word. But what the Forth of Tay would actually become were the land depressed 500 feet would be part of a wide sea joining the North Sea to the Atlantic, and stretching from the flanks of the Grampians to the Southern Uplands, a sea certainly studded with innumerable islands, but few if any of them of sufficient area to bear an ice-cap, and not only would the great central valley of Scotland be turned into an archipelago, while vast tracts all round the coast as well as the Great Glen (through which the Caledonian Canal passes) would be deeply submerged, but even the mountainous regions that remained would be invaded in all directions by great firths occupying what are now the highland glens.

But apart from this sweeping removal of the ice, foot by foot, as the land sank down, the load of ice would be proportionately lightened, so that it would really be an instance of depression accompanied by unloading, not, as the new theory demands, depression by loading, and in proportion to the amount of the loading.

Mr. Gardiner writes somewhat contemptuously of the phrase

“ground moraine.” I lay no claim to having invented it; I find, indeed, that it was used by Sir Andrew Ramsay at least as far back as the publication of his “Physical Geology of Great Britain.” Perhaps I may be permitted to commend it to Mr. Gardner as a useful English equivalent for the French phrase so much in use.

JAS. DURHAM.

#### PACKING OF SAND GRAINS AS COMPARED WITH ROUND SHOT.

SIR,—I am indebted to your correspondent, Prof. A. Harker, for his suggestion and for recalling my attention to this subject (p. 192). No doubt, as he states, round shot could be so packed as to leave much less interstitial space than what would result from my hypothetical arrangement. But even if perfect spheres of absolutely the same size could be obtained and friction eliminated, they could not fall together naturally in perfect “pyramidal order,” *i.e.* each shot having points of contact with twelve others; because their arrangement is conditioned by the packing which takes place against the sides of the vessel. If on the other hand they were unconfined as in a heap, their arrangement would be one of disorder.

To thoroughly test what practically happens, I filled a rain-gauge measurer up to the mark 30 with No. 4 shot carefully put in layers, and shaken to get them as close together as possible. A second rain-gauge measurer being filled also up to 30 with water, I poured sufficient from it among the shot to fill up the interstices. I found that 18 remained in the gauge, leaving 12 among the shot, a relation of 4 to 6.<sup>1</sup> This shows somewhat less interstitial space than my hypothetical arrangement assumed, but considerably more than the “pyramidal order” arrangement. It is plain to see through the glass that the number of points of contact of the shots vary, and leave variable open spaces in places. This shows that minute differences in size, imperfection of spheroidal shape, and to a large extent the packing against the sides of the vessel and friction, are disturbing elements. Some time ago for the purposes of a paper on sandstones I repeated the experiment mentioned in “Miniature Domes in Sand” on a larger scale, and in a somewhat different way, taking great care to shake the sand well together in layers, as I afterwards did with the shot. Curiously enough, the result was within a third decimal place of that I now give for the shot. The grains are mostly well-rounded, but some of them are angular, and the sizes of the grains vary considerably. It is surprising how the sand will keep on packing closer and closer by shaking, whereas the shot is affected to the extent of a reduction of its bulk by only  $\frac{1}{30}$ . The question is one of considerable practical interest. I find if a trench for a sewer intersects another trench which may have been filled up for years, and all in apparently homogeneous siliceous sand, the filling in of the old trench discovers itself by falling into the new one, while the sides cut in the “growing” sand remain vertical. Thus it appears that percolation of rain assisted by gravity is slowly moving and packing the grains of sand until they reach the point of maximum consolidation. It is in fact a natural building operation which may be likened to the fitting together of rubble, shot from a cart, to form a wall. Pouring water on filled-up sand will consolidate it, and I am in the habit of having this done where a floor has to be made on filled-up sand. It is remarkable how solid sand becomes in time left only to natural influences. I have frequently built large houses on sandhills without failure of foundation.

PARK CORNER, BLUNDELSANDS,  
April 5th, 1884.

T. MELLARD READE.

<sup>1</sup> If this experiment were repeated with larger vessels, the proportions might differ more.

THE  
GEOLOGICAL MAGAZINE.

NEW SERIES. DECADE III. VOL. I.

No. VII.—JULY, 1884.

ORIGINAL ARTICLES.

I.—NOTES ON THE GEOLOGY OF THE NILE VALLEY.

By Professor J. W. DAWSON, C.M.G., LL.D., F.R.S., F.G.S., etc.  
Principal of McGill College, Montreal.

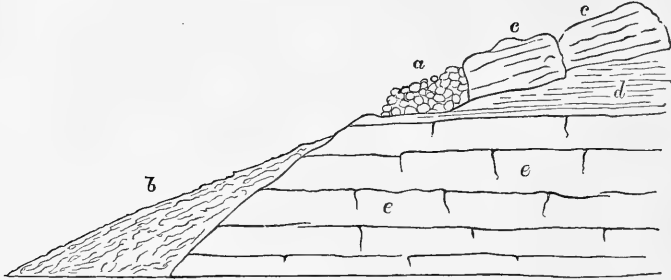
1. *Raised Sea Margins.*

SHORTLY after my arrival in Cairo, Dr. Schweinfurth, of that city, was so kind as to conduct me to a remarkable sea-terrace at the foot of the Mokattam hill, behind the tombs of the Caliphs, and stated, on the authority of Col. Ardagh, R.E., to be at an elevation of about 200 feet above the level of the sea, and which, I believe, was first described by Oscar Fraas. At this place a cliff of hard Eocene limestone, about 30 feet in height, has been perforated by *Lithodomi*, whose burrows are now filled with a grey calcareous deposit, and valves of a small species of oyster are also attached to the surface of the rock. The burrows resemble those of an ordinary Mediterranean species of *Lithodomus*, but I did not see the shells. The oyster has been described by Fuchs as a new species, under the name *O. pseudo-cucullata*; but, according to Dr. Schweinfurth, it does not seem distinguishable, except as a variety, from *O. cucullata*, Born. (= *O. Forskali*, Chemn.), of the Red Sea. Since the locality was observed by Fraas, Dr. Schweinfurth has discovered other shells in the crevices of the rock, more especially a *Pecten*, a *Terebratula*, and a *Balanus*, all modern species. The recent character of these shells and their mode of occurrence and state of preservation, oblige us, I think, to assign them to the Pleistocene, or at farthest the later Pliocene period, though I am aware that they have been regarded as Miocene.

Shortly after visiting this place, I was so fortunate as to discover on the opposite side of the Nile a similar exposure, associated with an old sea beach, which I subsequently examined more carefully in company with Dr. Schweinfurth. It occurs at the summit of a rocky knoll, called by the Arabs Het-el-Orab, or the Crow's Nest, a short distance to the south-west of the Pyramids of Gizeh, and separated from the plateaux of the Pyramids by the depression which contains the Sphinx, and which is partly natural, but in great part produced by excavation, of which evidences exist not only in the remaining chips of stone, but also in the Sphinx itself, and in the tomb crowning an isolated mass of rock farther to the west.

I may remark here that in the vicinity of the Pyramids the great succession of Eocene beds, 600 feet in thickness, which, in the Mokattam hill, appears in a perfectly regular manner,<sup>1</sup> has been so

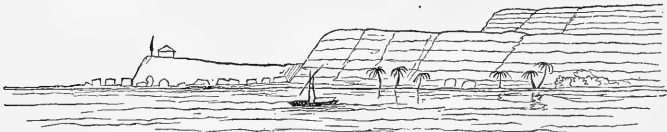
FIG. 1. RAISED BEACH AT GIZEH.



a. Beach. b. Sand. c. Brown Limestone. d. Clay and Marl. e. Limestone.

affected by lines of fault that some of the higher beds are brought down to a comparatively low level, and consequently in the Het-el-Orab a portion of the series which in the Mokattam is at a height of at least 400 feet, descends to an altitude of about 160 feet above the

FIG. 2. MOKATTAM TERRACES FROM THE NILE.



sea-level. The throwing down in this way on the Lybian side of the Nile valley in contrast with the comparatively undisturbed condition of the beds on the Arabian side, has no doubt borne an important part in determining the present position of the river.

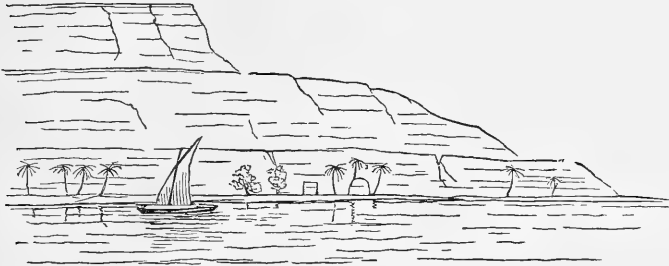
The side of the Het-el-Orab next the Pyramids presents a vertical quarried face, with a slope of débris below and at top some beds of marl and gypseous clays, surmounted by coarse limestone containing Upper Eocene fossils, for the identification of which I am indebted to Dr. Schweinfurth. On the opposite, or south-east side, the hill is in its natural state, and shows a sea-worn cliff, in which the upper hard beds have been partially let down and disturbed by the undercutting of the marls and clays beneath them. Here the edges of the limestone have been perforated with *Lithodomi*, and are covered with oyster shells, often showing both valves in contact, and better grown than those in the locality of the Mokattam. There are also a few

<sup>1</sup> Schweinfurth, Proc. German Geol. Survéy, 1883.



*Balani*, but we observed no other species. Under and against the edges of the rock has been piled a very coarse sea beach, composed of rounded fragments of limestone, with a few basaltic-like pebbles

FIG. 3. TERRACES IN EOCENE LIMESTONE ABOVE ASSIOUT, ON ARABIAN SIDE OF THE NILE.



not native to the locality. The interstices of these are often packed with loose oyster shells. The pebbles of the beach are somewhat cemented together by calcareous matter, but otherwise the whole is as fresh as if only recently deserted by the sea. The old beach has however been cut by subsequent aqueous erosion since it became consolidated, as it now stands on the side of the cliff with a vertical face about forty feet above the sandy plain below.

A little way over this plain to the southward are the well-known beds containing *Clypeaster Ægyptiacus*, *Pecten benedictus*, and *P. aduncus*. Dr. Schweinfurth has recently found *O. Forskali*, and other modern species in these beds, which he states in some places pass into a solid breccia. He regards their age as probably Pliocene, and I have little doubt that they belong to the same sea-bottom with the beach of Het-el-Orab. I am aware that they have been regarded as Miocene, but the evidence of the fossils is against this. Dr. Schweinfurth informs me that ancient Egyptian tombs have been excavated in the breccia associated with the *Clypeaster* beds.

It is evident that the submergence indicated by these sea-margins would with the present levels carry the sea far up the Nile Valley, as the top of the cataract at Assouan is only 300 feet above the sea-level. I noticed at various points on the Nile as far up as Alsilis, a terrace corresponding with the height of the raised beaches, and probably a continuation of the same shore, indicating that in the Pliocene or Pleistocene age the Nile valley was an arm of the sea. With this submergence I would also associate the older beds of consolidated gravel seen at Thebes and elsewhere in the Nile valley, and the transport of boulders from the hills east of the Nile into Lybia as seen at Denderah. The Theban gravels above referred to are those in which flint flakes supposed to be of human workmanship were found by General Pitt Rivers. If really of this origin, they would prove the residence of man in Egypt at a time when only the higher parts of the country were above the level of the sea. For

reasons stated elsewhere, however, I doubt very much whether they can be attributed to man.<sup>1</sup>

We may also connect this recent submergence with the sandstones and raised beaches holding modern shells in the vicinity of Alexandria and of the Red Sea, and also the similar sandstones of the maritime plains of Syria, which near Jaffa and at Beyrout attain to elevations of about 200 feet. We thus have evidence of a very extensive Pleistocene submergence, extending all around the eastern end of the Mediterranean. It is limited in date by the Middle Tertiary on the one hand, and by the elevated land of the Post-glacial on the other, and was not improbably coincident with that great submergence of the Pleistocene which affects so generally the Northern hemisphere.

There is, I think, evidence at Cairo that this submergence was in its earlier period of still greater magnitude. The elevation of the Mokattam Hill is 640 feet, and it consists of horizontal Eocene deposits, the lower part of which are for the most part pure marine limestones, while about one-third of the upper part consists of coarse brown limestone with marly beds and clays. At the height of about 500 feet, and near the junction of these two members, there is a broad flat terrace, especially on the western side; and though no marine shells have been found in this, it is scarcely possible to pass along it and examine its bounding cliffs, without being convinced that it has been produced by surf erosion. The continuation of this terrace may be observed here and there along the Nile as far as Assouan, beyond which place I had less opportunity to trace it. With this second terrace, older no doubt than that at a lower level, I would connect the denudation of the probably Miocene sandstones containing silicified trees of which Gebel Ahmeen, near Cairo, is a remnant, and also the denudation of the Judæan Hills and the lower slopes of Lebanon, and the higher marine terraces of the Red Sea.

In contrast with these evidences of subsidence, I may now refer to the fact that at a later date, and more immediately preceding the historic period, the land of Egypt was probably higher than at present. The occurrence of patches of sand projecting through the Nile mud of the delta, and the fact ascertained by the recent borings by Col. Ardagh, that at a depth of 30 to 40 feet the alluvial mud rests on desert sand, show that in post-Glacial or early modern times the plain of the delta was a part of the desert, through which the Nile probably ran in a narrow and deep channel, and more to the eastward than at present.<sup>2</sup> A subsequent slight depression near the beginning of the historical period placed it in a position to receive and retain the inundation mud. This, with the further protection afforded by the line of raised beaches along its northern edge, rendered the formation of the delta easy, and enabled its alluvial soil to be deposited in a much shorter time than would have been required had the Nile poured its deposits into a maritime bay of any considerable depth, and unsheltered on its leeward side.

<sup>1</sup> Trans. Victoria Institute, 1884.

<sup>2</sup> The fresh-water deposits found in the central part of the Isthmus of Suez may belong to this period.

II.—CONTRIBUTIONS TO THE PALÆONTOLOGY OF THE YORKSHIRE OOLITES.

By WILFRID H. HUDLESTON, M.A., F.R.S., F.G.S.]

(Continued from Decade III. Vol. I. p. 252.)

(PLATE IX.)

Genus *ONUSTUS*, Humphrey, 1797.

SEVERAL trochiform shells found in the Jurassic rocks, which were formerly referred either to *Trochus* or to *Solarium*, have in more recent years been regarded as related to the genus *Onustus*. I am not aware who was the first author to adopt this view, but we find Hébert and Deslongchamps (1860) recognizing the genus in the Callovian of Montrueil Bellay. Subsequently Lycett (Suppl. to the Great Ool. Moll. p. 103) gave a diagnosis, more especially as applicable to the Jurassic species, and described *Onustus Burtonensis* from the Forest Marble of Burton Bradstock.

The Jurassic species referred to *Onustus* form a well-marked group characterized by a wide-angled cone, made up of whorls which overlap so as to hide the suture; the width exceeds the height; the ornamentation is longitudinal (axial); the base is nearly flat, as in *Trochus*, but with a convexity towards the centre. The Yorkshire specimens, however, as far as can be seen, exhibit but small trace of an umbilicus. Aperture depressed and very oblique. S. P. Woodward observes that shells extremely like the recent *Phorus* (i.e. *Onustus*) are met with even in the Carboniferous Limestone. In the Jurassic rocks of Yorkshire no specimens which could be referred to *Onustus* have been found to my knowledge elsewhere than in the Dogger.<sup>1</sup>

59.—*ONUSTUS ORNATISSIMUS*, D'Orbigny. Plate IX. Fig. 1.

1849. *Trochus ornatissimus*, D'Orbigny, Prod. i. p. 264 (Et. Bajocien).

1852. " " Terr. Jurass. ii. p. 272, pl. 312, figs. 5-8.

*Bibliography, etc.*—D'Orbigny describes his species as of medium size, and having a spiral angle of 85°. He distinguishes it from "*Trochus*" *heliacus* and *lamellosus* principally through the character of its ornamentation; the longitudinal costæ terminating in points, which give to the periphery of the base a spinous aspect.

*Description.*—Specimen from the Dogger (zone 1), Peak (Blue Wyke). Leckenby Collection.

Height.....	14 millimètres.
Width .....	21 "
Spiral angle .....	83°.

The shell is trochiform, the spire being slightly hollowed out; base unseen. Whorls about 7 in number, excavated posteriorly and overlapping sufficiently to hide the suture. The longitudinal costæ are but slightly developed in the anterior portion of the last two

<sup>1</sup> Some might be disposed to think that the fossils classed by Deslongchamps and Lycett under *Onustus* present more resemblance to such modern genera as *Calcar* and *Uranilla*.

whorls, but in the apical whorls extend throughout; they are stout, and occur at intervals about three times their width. A system of fine lamellar lines or striæ crosses the shell obliquely from left to right, and is especially conspicuous in the posterior half of the body-whorl.

*Relations and Distribution.*—The Yorkshire specimen figured on Plate IX. may perhaps be regarded as a variety rather than an actual representative of the Normandy "*Trochus*" *ornatissimus*. Moreover, some of the most distinctive features, such as the pointed ends of the ribs, have been modified by abrasion, whilst the adherence of the matrix prevents a full examination of the basal periphery; yet I apprehend that this was crenulated, and not plain as in *Onustus pyramidatus* (*lamellosus*). Moreover, the greater space between the ribs presents a clear character for separating the two, though I doubt not the existence of intermediate forms. Indeed, the Yorkshire specimen itself would in some respects serve to illustrate this.

Though probably the majority of the Dogger specimens quoted as "*Trochus*" *pyramidatus* are the representatives of *Onustus lamellosus*, yet here and there one meets with fragments more resembling this species. "*Trochus*" *ornatissimus* is quoted by Lycett from the Inferior Oolite of the Cotteswolds, and the White Oolite (Inferior Oolite) of Ponton in Lincolnshire.

60.—*ONUSTUS PYRAMIDATUS*, Phillips, 1829. Plate IX.

Figs. 2a, 2b, 3a, 3b.

1829 and 1835. *Trochus pyramidatus*, Bean MS. Phillips, G.Y. p. 129, pl. xi. fig. 22.

1852. *Trochus lamellosus*, D'Orbigny. Terr. Jurass. ii. p. 270, pl. 311, figs. 11-13.

1875. *Trochus pyramidatus*, Phillips, G.Y. 3rd edition, p. 259, pl. xi. fig. 22.

*Bibliography, etc.*—Lycett (*op. cit.* p. 103) considered Phillips's species to be the same as *Onustus lamellosus*. This is described by D'Orbigny as a large species with a spiral angle ranging from 84°-90°, very much wider than high, infundibuliform, and with a well-marked umbilicus. General structure as in "*Trochus*" *ornatissimus*. He observes that the whorls have no prominence, and that they are ornamented "en travers" by oblique flexuous ribs rather close together, and all crossed by fine oblique striæ.

*Description.*—Specimen from the Dogger (zone 1), Peak (Blue Wyke). York Museum. TYPE REFIGURED. Figs. 2a, 2b.

Height .....	17 millimètres.
Width .....	23 "
Spiral angle .....	80°.

Shell short, trochiform, scarcely umbilicated. The flanks of this specimen have undergone so much polishing that the ornaments are somewhat abraded. Hence the concavity of the upper part of the whorls is less obvious, and the whole outline of the spire more like that of a *Trochus*. To this circumstance may also be due the apparently smaller spiral angle. The costæ are separated by a space about twice their width: the anterior portion of the body-whorl is entirely destitute of these axial costæ and shows a series of lamellæ sloping from left to right.

The type specimen is especially valuable as showing us the base of "*Trochus*" *pyramidatus* in a good state of preservation. This is moderately concave, the chief depression occurring somewhat outside the centre, the base rising again towards the columella. The umbilical region is marked by a shallow depression, exhibiting the rudiments of an umbilical groove. The periphery is plain, but the base itself is ornamented by a system of fine radial lines, while here and there a few spiral lines may be noted. Aperture very oblique.

*Another specimen.*—From the same horizon and locality. Leckenby Collection. Figs. 3a, 3b.

Height.....	17 millimètres.
Width.....	25 "
Spiral angle.....	86°.

The sides are less abraded than in Phillips's type: consequently the excavation of the posterior part of the whorls is more apparent, and the somewhat flexuous ribbing is better seen. The body-whorl is devoid of this ribbing and shows the scaly or lamellar structure more plainly in consequence. The base is not well preserved, but the periphery was evidently plain, and there are no obvious traces of an umbilicus.

*Relations and Distribution.*—Phillips's species is perhaps not exactly the same as "*Trochus*" *lamellosus*. D'Orbigny's figures show the ribbing as continuous throughout the body-whorl, though the description is perhaps compatible with its absence. We have already seen that Lycett regarded them as identical. Making due allowance for difference of matrix, the original differences were probably only such as might be expected to occur in areas wide apart. All specimens of *Onustus* are represented by D'Orbigny as being more umbilicated than are the Yorkshire ones.

*Onustus pyramidatus* is not very uncommon in the Dogger, though really good specimens are extremely scarce. It may generally be distinguished from *O. ornatissimus*, even in bad specimens, by the closer pattern of the ribbing. This species is quoted by Lycett from the Supra-Liassic Sands and Inferior Oolite of Gloucestershire. Mr. Tawney does not mention the occurrence of *Onustus* at Dundry, but I have evidence that specimens of an *Onustus* marked like *lamellosus* (*i.e. pyramidatus*) occur in the Inferior Oolite of Dorset.

#### Genus *NERITA*, Linnæus, 1758.

The Inferior Oolite of Yorkshire contains three species which seem fairly referable to the genus *Nerita*. One species occurs sparingly in all three zones, but the other two would seem, according to my present knowledge, to be confined to the Dogger. Of these the only one at all abundant is *Nerita minuta* (*i.e. tumidula*). The occurrence of any Nerite in the Yorkshire Oolites above the Inferior Oolite is unknown to me: accordingly none were described in the "Corallian Gasteropoda." As regards its occurrence on lower horizons, we find that Tate and Blake describe a single species, *Nerita alternans*, from the *spinatus*-zone of the Yorkshire Lias.

61.—*NERITA MINUTA*, Sowerby, 1824, var. *tumidula*, Phillips.  
Plate IX. Figs. 4a, 4b, 5a, 5b, 6.

1824. *Nerita minuta*, Sowerby, Mineral Conchology, table 463, figs. 3 and 4.  
1829 and 1835. *Natica tumidula*, Phillips, G. Y. p. 129, pl. xi. fig. 25 (*Nerita minuta*, Sow.).  
1854. *Nerita minuta*, Sow. Morr. Cat. p. 264.  
" *Natica tumidula*, Phil. Morr. Cat. p. 262.  
1875. *Natica tumidula*, Phil. G. Y. 3rd edition, p. 257, pl. xi. fig. 25.

Compare also

*Nerita ovata*, Rœm. Ool. Geb. p. 156, pl. x. fig. 6.

*Bibliography, etc.*—In his first edition Phillips seems to have had an idea that there was a connection between the Dogger shell and Sowerby's very small species (3 mm.) from the Oolite of Ancliff. It must be admitted that Sowerby's enlargement yields a figure very like the Dogger fossil. Morris, however, did not favour this notion, since he quotes *Nerita minuta* from Ancliff without any reference to "*Natica*" *tumidula*, which he evidently regarded as distinct. But he refers to *Nerita ovata*, Rœm., which, although it comes from the "Upper Coral Rag" along with *Nerinea nodosa*, has a most striking resemblance to the Dogger species. On the whole, I am inclined to believe that Phillips had reason in his first reference, and that *Nerita minuta*, of Ancliff, may be regarded as a micromorph of the Dogger fossil now under consideration. Moreover, Sowerby figured *Nerita costata* (= *costulata*, Deshayes) from the same beds at Ancliff, and this species likewise occurs sparingly in the Inferior Oolite of Yorkshire. It is true that Sowerby regarded his species as a doubtful *Nerite*, because of the entire edge of the columella. In *Nerita minuta* (*tumidula*), and possibly in *N. ovata*, Rœm., this is perhaps more apparent than real.

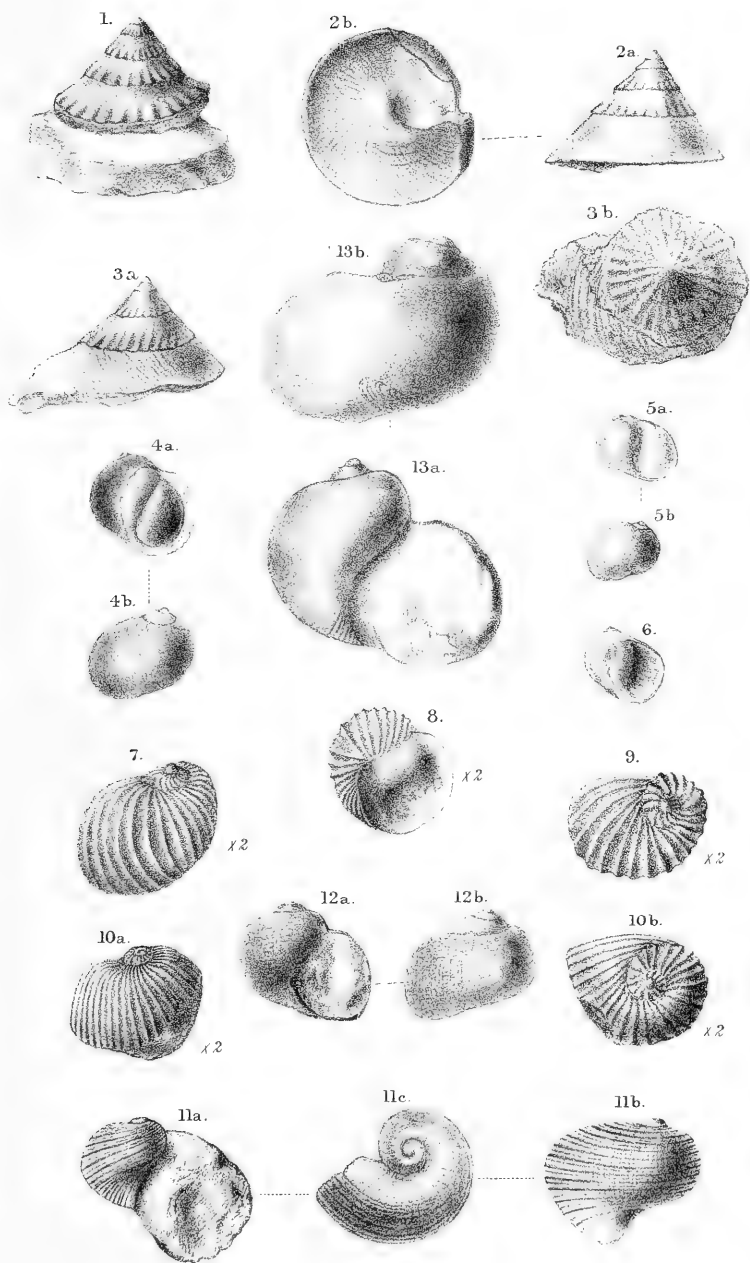
Lastly, the Yorkshire fossil has been labelled *Nerita minuta*, Sow., in the Lycett Collection at the Jermyn Street Museum, presumably in accordance with the identification of Lycett himself, who seems to have been satisfied of its character as a *Nerite*. Under these circumstances there seems no alternative but to adopt Sowerby's name for the fossil so long known in collections as *Natica tumidula*, Phil.<sup>1</sup>

*Description.*—Specimen from the Dogger (zone 1), Peak (Blue Wyke)—Jermyn Street Museum. Figs. 4a, 4b.

Height .....	15 millimètres.
Ratio of body-whorl to entire height ....	about 85: 100.
Spiral angle .....	125°.

Shell transversely oval, tumid, imperforate. The spire consists of a small button-like apex, which expands within the course of two or three widely separated volutions into a very large body-whorl;

<sup>1</sup> The fact that the Ancliff Oolite was supposed to be of Great Oolite age may have had something to do with the unwillingness of some excellent authorities to recognize the relationship of *Natica tumidula* to *Nerita minuta*. Although I have made numerous inquiries, I have never been able to obtain any very satisfactory account of the beds whence Sowerby obtained his "Ancliff" fossils, mostly, I believe, either micromorphs or very small species.



A. S. Foord del.

Mintern Bros. imp.

Oxfordian & Lower Oolite Gasteropoda.  
(Yorkshire.)





a slight flattening of the posterior area may be noted; the rest of the whorl is uniformly tumid, and entirely plain, with the exception of fine lines of growth. There are also certain coarse markings (not shown in the figure) which probably indicate stages of increase.

The aperture is large in every direction; the outer lip is crescent-shaped and produced, the substance being rather thin, although the adherence of matrix on the inside seems to show the contrary. The inner lip is straight, with a wide callus on the flattened columella. It is not certain whether there were any denticulations on the edge of the pillar-lip, since this part of the specimen is somewhat worn; there are indications which might be thus interpreted.

*Another specimen.*—Same horizon and locality. Leckenby Collection. Figs. 5a, 5b.

Height ..... 9 millimètres.

Represents a smaller shell, and one where the apex is rather less conspicuous, or else in a worse state of preservation than the preceding. The body-whorl is well preserved in a fine black spathic material, and shows extremely delicate lines of growth, but none of the rugosities of the larger and older specimen.

*Another specimen.*—Same horizon and locality. York Museum. Phillips's TYPE REFIGURED. Fig. 6.

Height ..... about 11 millimètres.

The apical portion of the spire is not well preserved, but in the body-whorl may be noted the characters previously described. The aperture is very fairly preserved, though there can be no doubt that a portion of the outer lip has been broken away. Phillips's figure (*op. cit.* pl. xi. fig. 25) is enlarged about  $1\frac{1}{2}$  times, and is a remarkably faithful representation of the shell. The wide semicircular sweep of the outer lip is there well given, as also the straight pillar-lip with the wide callus on the flattened columella area—all in complete contrast to the Naticas of the Dogger, as may be seen on referring to the first plate of the present Memoir (GEOL. MAG. 1882, Pl. V.).

*Relations and Distribution.*—In the Yorkshire Dogger this smooth Nerite is perhaps larger and probably more numerous than on the same horizon further south. Nevertheless it should be borne in mind that here also its size varies wonderfully, the specimen, figure 4, being exceptionally large. Still the average is probably three times the size of Sowerby's type. Being fairly abundant in the Yorkshire Dogger, one would expect to find this species low down in the Inferior Oolite of other districts. Can the *Natica neritoidea*, quoted as common in the Northampton Sand (Judd, Geology of Rutland), represent it? A species of *Nerita* is quoted by Mr. Walford from the Inferior Oolite of Hook Norton (Q.J.G.S. 1883, p. 240). Dr. Wright quotes "*Natica*" *tumidula*, Phil., as one of the fossils of the Oolite Marl of Cheltenham (Q.J.G.S. vol. xvi. p. 13), whilst from the Pea Grit (p. 11) he quotes *Nerita minuta*, Sow. Perhaps the difference is only one of size. No Nerite is quoted by Mr. Tawney from Dundry, nor anything that could in any way be taken to represent *Nerita minuta*.

Neither is any species of *Nerita* quoted by Brauns from the Middle (Brown) Jura of N.W. Germany.

An unornamented species like this would naturally pass upwards with but little modification. Although nothing of the kind is known to me from higher beds in Yorkshire, yet in *Neritina Cooksonii*, Deslong.<sup>1</sup> (*vol. cit.* p. 133, pl. 10, figs. 8 and 9), we see a considerable outward resemblance; but in specimens from the Great Oolite of Normandy the pillar-lip, judging by the figure, seems to have encroached to an amazing extent upon the aperture. Allusion has already been made to the resemblance of *Nerita ovata* from the Coral Rag of N. W. Germany.

- 62.—*NERITA PSEUDO-COSTATA*, D'Orbigny, 1849. Plate IX. Figs. 7, 8 and 9. Each enlarged twice.  
 1829 and 1835. *Nerita costata* (Min. Conch.), Phillips, G. Y. p. 129, pl. v. fig. 32. York. Mus.  
 1849. *Nerita pseudo-costata*, D'Orb. Prod. i. p. 264. (Et. Bajocien.)  
 1854. *Nerita pseudo-costata*, D'Orb. Morr. Cat. p. 264.  
 1875. *Neritopsis pseudo-costata*, D'Orb. Phillips, G. Y. 3rd ed. p. 258, pl. ix. fig. 32.

Non *Nerita pseudo-costata*, D'Orb. Morris and Lycett, Gt. Ool. Moll. p. 114, pl. xv. fig. 3.

*Bibliography, etc.*—The history of *Nerita* in the Yorkshire Oolites seems doomed to be involved in an ever recurring tissue of mistakes. In the first place Phillips appears to have been wrong in his identification of the Dogger shell now under consideration, though small blame can attach to him for regarding Sowerby's *Nerita costata* (from Ancliff) as identical with his Yorkshire fossil. D'Orbigny set him right; but that author; it should be observed, does not describe or figure *N. pseudo-costata* in the Terrain Jurassique, whence we may infer that no such form had been noted from any locality in France. Then came Morris and Lycett, who described and figured as the *Nerita pseudo-costata* of D'Orbigny a shell which "appears to be identical with the well-known Inferior Oolite species." This was stated to occur near Scarborough (*i.e.* in the Scarborough Limestone), and also in the Inferior Oolite (*i.e.* the Dogger).

Their mistake seems to have been exactly the converse of that of Phillips. The fossil figured by them was indeed and in truth no other than Sowerby's Inferior Oolite fossil. Subsequently (1875) Phillips referred the species now under consideration to *Neritopsis*, on what grounds I am at a loss to conceive.

*Description.*—Specimens from the Dogger (zone 1), Peak (Blue Wyke).<sup>2</sup> Leckenby Collection.

Height ..... 9 millimètres.  
 Body-whorl to total height ..... about 90 : 100.

<sup>1</sup> D'Orbigny, Terr. Jurass. p. 231, gives the following extraordinary synonymy :

*Nerita minuta*, Sow. 1824.

*Nerita costata*, Sow.

*Nerita costulata*, Desh.

*Neritina Cooksonii*, Deslong. p. 133, pl. 10, figs. 8 and 9.

<sup>2</sup> Since the three specimens figured were all attached to a card, it was thought best not to interfere with this arrangement. The dimensions refer to Figure 7, which is slightly the largest.

Shell small, transversely ovate, not umbilicated. Spire low, but not exactly depressed, yielding a spiral angle of about  $150^\circ$ . The flanks of all the whorls are ornamented with very strong transverse (longitudinal or axial) costæ, regular and separated by sulci, about twice the width of each rib. Aperture wide, the outer lip semi-lunar, the pillar lip nearly straight: columellar area flattened, and with a wide callus which is somewhat encroached upon towards the middle.

*Relations and Distribution.*—It is possible that *Nerita pseudo-costata* is nothing more than a variety of the species next to be described, occurring on a low horizon of the Inferior Oolite both here and in the Cotteswolds. In Yorkshire it is confined to the Dogger, where it must be rather rare, Mr. Leckenby's specimens being the best I have seen. The aperture is so different from that of the Jurassic species referred to *Neritopsis*, that we must agree with D'Orbigny in referring it to *Nerita*.

63.—*NERITA COSTULATA*, Deshayes=*NERITA COSTATA*, Sowerby, 1824.  
Plate IX. Figs. 10a, 10b. Enlarged twice.

1824. *Nerita costata*, Sowerby. Min. Conch. Tab. 463, figs. 3 and 4.

1838. *Nerita costulata*, Deshayes. Lam. Anim. sans vert. 2nd ed. vol. viii. p. 617.

1850. *Nerita costulata*, Deshayes. Morr. and Lyc. Gt. Ool. Moll. p. 57, pl. viii. fig. 6.

„ *Nerita pseudo-costata*, D'Orb. *op. cit.* p. 114, pl. xv. fig. 3.

*Bibliography, etc.*—Not having seen the reference in Deshayes's work, I accept this name on the authority of Morris and Lycett and of D'Orbigny. In the Prodrôme this species is ranked as Bathonian, whilst we have already seen how, in the Terrains Jurassiques, it has been mixed up with *Nerita minuta*, Sow. Morris and Lycett (p. 57) observe that "it has not been found in the Minchinhampton Great Oolite, but occurs occasionally in the Inferior Oolite of that district." There is no evidence, as far as I am aware, of its having been found in the Great Oolite of this country, except perhaps at Stonesfield. Phillips makes no allusion to this species in his third edition.

*Description.*—Specimen from the Scarborough Limestone (zone 3), White Nab. Herries Collection.

Too much broken for accurate measurement, this fragment represents a shell about 8 or 9 mm. in height. In outline it resembles *N. pseudo-costata*, except, perhaps, in being more depressed and in the deepening of the sutural channel, but the ornaments are very different. The ribs are finer, and more than twice as numerous as in *N. pseudo-costata*: there is also a slight tendency to angularity in the middle of the body-whorl, and a thickening of the ribs where they pass over the widest part, as though prefiguring the formation of a varix.

*Relations and Distribution.*—This shell is sufficiently near to Sowerby's type of *Nerita costata* from Ancliff to be ranked with that species, although there may be certain differences which a very close comparison might bring to light. A specimen from the Millepore Rock, in Mr. Leckenby's collection, has more the appearance of Sowerby's figure, and is to a certain extent represented by Morris

and Lycett's figure (pl. xv. fig. 3). The only Dogger specimen ever seen by me is in the Lycett Collection at Jermyn Street; in this one the ribbing is bolder and shows an approach to *Nerita pseudo-costata*.

Thus *Nerita costulata*, Deshayes (*N. costata*, Sow.), occurs, though very rarely, in all three zones of the Inferior Oolite in Yorkshire, whilst *N. pseudo-costata* is confined to the Dogger. It is also quoted as rare in the Northampton Sand (Judd, Geology of Rutland, p. 282), and we have seen that it occurs occasionally in the Inferior Oolite of the Cotteswolds, but has not yet been noted in England further south than Ancliff.

#### Subgenus NERITOPSIS, Grateloup, 1832.

With reference to *Neritopsis*, see "Corallian Gasteropoda," in the GEOLOGICAL MAGAZINE for the year 1881, p. 49, D'Orbigny (Terrains Jurassiques, ii. p. 221) says that the shell is analogous to that of the Nerites; but, judging partly from his description and partly from his figures, we arrive at the conclusion that the Jurassic representatives of *Neritopsis* present considerable differences as regards the inner lip to the ordinary Nerite. Instead of the large flattened columellar area covered with callus, and in most cases denticulated on its very straight margin, the inner lip is hollowed out, and D'Orbigny says is without teeth. Yorkshire specimens of *Neritopsis* are seldom sufficiently well preserved to make us feel sure on this latter point, but we may fairly accept D'Orbigny's statement, since he had the handling of so many excellent specimens. The Jurassic species are also for the most part characterized by spiral ornamentation, with more or less transverse decussation.

These beautiful fossils, rare enough in the Corallian beds, are still rarer and worse preserved in our Oxfordian and Lower Oolites. None are quoted from the Yorkshire Lias.

#### 64.—NERITOPSIS BAJOCENSIS, D'Orbigny, 1849. Dogger Variety. Plate IX. Figs 11a, b, c.

1849. *Neritopsis Bajocensis*, D'Orb. Prod. i. p. 264.

1852. " " " " Ter. Jurass. p. 223, pl. 300, figs. 8-10.

Compare also

*Neritopsis Philea*, D'Orbigny, Terr. Jurass. p. 222, pl. 300, figs. 5-7 (Et Toarcien).

*Bibliography, etc.*—We obtain most of our information regarding the Jurassic species of *Neritopsis* from the pages and exquisite plates of the Paléontologie Française. The earliest species recorded is *N. Hebertana*, from the Middle Lias of Fontaine-Étoupe-Four. This is a smallish and very rugose species, whose exact counterpart occurs in the Dorset-Somerset district, and most probably on, or near, the same horizon. Next come two species which greatly resemble each other—*Neritopsis Philea* is quoted from the Toarcian of the environs of Semur (Côte d'Or), and *N. Bajocensis* from the I.O. of Moutiers (Calvados). The Yorkshire specimen does not exactly agree with either, but seems to be an intermediate form.

*Description.*—Specimen from the Dogger (zone 1), Peak (Blue Wyke). York Museum.

Length .....	18 millimètres.
Width .....	21 „

The shell-substance has been partly eaten away, the columella having entirely perished. Hence the appearances of the front aspect of the shell (Fig. 11a) must be taken for no more than they are worth. The apical view discloses a very short spire composed of about three tumid whorls, largely hollowed at the suture, and developing rapidly into a large body-whorl, which shows a slight flattening posteriorly, but is otherwise tumid and rounded throughout. The ornaments consist of spiral lines of varying strength, somewhat irregularly spaced. About a dozen, stronger than the rest, may be counted on the body-whorl. There does not seem to be any transverse ribbing, but a certain kind of reticulation is produced by occasional thickening due to periodical arrestation of growth, and also by fine transverse striæ. Other indications are wanting.

*Relations and Distribution.*—From Normandy specimens of *Neritopsis Bajocensis*, the Dogger fossil, is distinguished by the absence of the transverse undulations on the posterior region, whilst from *Neritopsis Philea* it is distinguished by the absence of the transverse tuberculated lines. In the Inferior Oolite of Bradford Abbas a *Neritopsis* occurs very similar to this one, but with a perfectly flat posterior area, such as appears never to have existed in the Dogger specimen. Hence both in Yorkshire, in Dorset-Somerset, in Normandy, and in the East of France fossils occur, in or about the same horizon, which present a general similarity, but with differences of detail. The Bradford Abbas fossil is so well preserved as to warrant its being described as a distinct variety. No specimens from the Yorkshire Dogger are quite good enough for this. It is extremely rare, and is one of the species which altogether escaped the notice of Phillips.

No variety of *Neritopsis Bajocensis* seems to have been noted in the Inferior Oolite of any other part of England, until we reach Somersetshire. Mr. Tawney recorded three specimens from Dundry, and no doubt many more have been added since then to the Collection at the Bristol Museum. Brauns does not record *Neritopsis* from the Middle (*i.e.* Brown) Jura of N.W. Germany, but Laube (*Gast. des braunen Jura von Balin*, p. 6, pl. i. fig. 9) figures a rather typical form of *N. Bajocensis*.

65.—NERITOPSIS CANALICULATA, D'Archiac, 1843. Pl. IX.

Figs. 12a, 12b.

1843. *Turbo canaliculatus*, D'Archiac. Mem. Soc. Géol. de France, 5, p. 379, pl. 29, fig. 6.  
 1849. *Turbo Archiaci*, D'Orbigny. Prod. i. p. 300 (Bathonien).  
 1852. *Turbo Archiacii*, D'Orbigny. Terr. Jurass. ii. p. 351, pl. 334, figs. 8—10.  
 1863. *Neritopsis Archiaci*, D'Arch. species, Lycett, Suppl. p. 21, pl. 31, figs. 7, 7a.

*Bibliography, etc.*—Not quite comprehending why D'Archiac's specific name should be suppressed, and believing that no other

species of *Neritopsis* bears it, I have ventured to restore the original title. It is rather singular that D'Orbigny, who knew *Neritopsis* so well, should have let this one pass for a *Turbo*. If we can judge from the figure in the T. J. his specimen had undergone exactly the same treatment as ours—viz. the anterior portion of the aperture had been broken off.

*Description.*—Specimen from the Cornbrash (zone 4), Scarborough. Leckenby Collection. Lycett's TYPE REFIGURED.

The following is Lycett's description: "Shell ovate, depressed: spire elevated, consisting of three or four volutions, which are narrow, inflated, their sutures deeply channeled; the last volution has some obscurely marked, irregular and unequal transverse costæ decussated by encircling striations: the striations are regular, very closely arranged, faintly impressed, with small wave-like undulations: the aperture is large and rounded."

*Relations and Distribution.*—An apical view best exhibits the characters of this peculiar species, which has to a certain extent the aspect of a hybrid. The delicate spiral lines with the "wave-like undulations" partly remind one of *Neritopsis*, from which it chiefly differs in the excessive fineness of the ornamentation, and somewhat also in the general outline. The two specimens in the Leckenby Collection and a small one in the York Museum are the only instances of its occurrence within my cognizance. The species nearest to it is one, not extremely uncommon in the Dogger, usually known as *Turbo lævigatus*,<sup>1</sup> Phil. These two species seem to form a group by themselves, which for the present at least, may be held to constitute a section of *Neritopsis*.

66.—NERITOPSIS, species. Pl. IX. Figs. 13a, 13b.

Compare—

1852. *Neritopsis Baugierana*, D'Orbigny. Terr. Jurass. ii. p. 224, pl. 300, figs. 11–13.  
 1860. *Neritopsis Guerrei*, Hébert and Deslongchamps, Bull. Soc. Linn. Norm. vol. v. p. 185, pl. i. figs. 4a, b, c, d.

*Description.*—Specimen from the Kelloway Rock (zone 5), Scarborough. Leckenby Collection.

This is a cast, from the red-stained oolite of the Kelloway Rock, 28 mm. in height by 32 mm. in width. The fossil is so completely skinned, that we can only guess the spiral ribbing was rather fine; it is not clear whether there was any transverse ribbing. The posterior and anterior muscular scars are well shown.

Mr. Leckenby was inclined to refer the great *Neritopsis* of the Kelloway Rock to *N. Guerrei*, more perhaps because of the presumed similarity of the horizon than from any marked resemblance. Strong transverse ribbing is one of the features of *N. Guerrei*, and there is no trace on the Scarborough fossil that any such existed. The Leckenby specimen is exceptionally large; there is another belonging to the Scarborough Museum about half the size, in the same condition, and from the same horizon and locality. Rare.

<sup>1</sup> To be figured and described in the next part of this Memoir.

EXPLANATION OF PLATE IX.

- FIG. 1. *Onustus ornatissimus*, D'Orb. Dogger, Blue Wyke. Leckenby Collection. Back view.  
 ,, 2a, b. *Onustus pyramidatus*, Phillips. Dogger, Blue Wyke. York Museum. TYPE REFIGURED. Back and basal views.  
 ,, 3a, b. *Onustus pyramidatus*, Phil. Dogger, Blue Wyke. Leckenby Collection. Back and apical views.  
 ,, 4a, b. *Nerita minuta*, Sowerby, var. *tumidula*, Phil. Dogger, Blue Wyke. Jermyn St. Museum. Front and back views.  
 ,, 5a, b. *Ib.* *Ib.* var. *tumidula*, Phil. Dogger, Blue Wyke. Leckenby Collection. Front and back views.  
 ,, 6. *Ib.* *Ib.* var. *tumidula*, Phil. Dogger, Blue Wyke. York Museum. TYPE of *Natica tumidula*, Phil., REFIGURED. Front view.  
 ,, 7, 8, 9. *Nerita pseudo-costata*, D'Orbigny. Dogger, Blue Wyke. Leckenby Collection. Three specimens, each enlarged twice.  
 ,, 10a, b. *Nerita costulata*, Deshayes. Scarborough Limestone, White Nab. Herries Collection. Back and apical views, enlarged twice.  
 ,, 11a, b, c. *Neritopsis* near to *Bajocensis*, D'Orbigny. Dogger, Blue Wyke. York Museum. Front, back, and apical views.  
 ,, 12a, b. *Neritopsis canaliculata*, D'Archiac. Cornbrash, Scarborough. Leckenby Collection. Front and back views.  
 ,, 13a, b. *Neritopsis ? Guerrei*, Héb. and Desl. Kelloway Rock, Scarborough. Leckenby Collection. Cast. Front and back views.

(To be continued.)

III.—ON THE OCCURRENCE OF THE GENUS *DALMANITES* IN THE LOWER CARBONIFEROUS ROCKS OF OHIO.

By Prof. E. W. CLAYPOLE, B.A., B.Sc. (Lond.) F.G.S.,  
 of Buchtel College, Akron, Ohio, U.S.A.

OF the abounding Trilobites which mark the faunas of the Lower and Middle Palæozoic rocks few survive into the Upper Palæozoic. Three genera, if indeed they really deserve that name, have been described from the Carboniferous beds in England—*Phillipsia*, *Griffithides* and *Brachymetopus*. Only the first of these is yet known to occur in American Palæozoic strata. But on the other hand two species of *Proetus* have been announced from America—a genus not yet recognized in England.<sup>1</sup> It is true that the distinctions are so slight that possibly these last might be as correctly referred to *Phillipsia* as to *Proetus*. As they stand, however, the distribution of the North American Carboniferous Trilobites is as follows:—

DISTRIBUTION OF NORTH AMERICAN CARBONIFEROUS TRILOBITES.	
COAL-MEASURES	<i>Phillipsia Cliftonensis</i> , Shum. 1858.
	,, <i>major</i> , Shum. 1858.
	,, <i>Sangamonensis</i> , M. and W. 1865.
	,, <i>scitula</i> , M. and W. 1865.
CHESTER GROUP	,, <i>Meramecensis</i> , Shum. 1855.
	,, <i>Stevensoni</i> , Meek, 1871.
KEOKUK GROUP	,, <i>Lodiensis</i> , Meek, 1875.
	<i>Proetus</i> <sup>2</sup> <i>auriculatus</i> , ? Hall, 1861.
CUYAHOGA SHALE	<i>Phillipsia bufo</i> , M. and W. 1870.

<sup>1</sup> Dr. Woodward noticed a pygidium of *Proetus* from the Carboniferous Limestone of Dublin. See GEOL. MAG. 1883, p. 446 (woodcut).—EDIT. GEOL. MAG.

<sup>2</sup> Assigned in Miller's Catalogue of N. A. Palæozoic Fossils to the Chemung Gr.

	<i>Phillipsia Portlocki</i> , M. and W. 1865.
BURLINGTON GROUP	„ <i>insignis</i> , Win. 1863.
	„ <i>tuberculata</i> , M. and W. 1870.
KINDERHOOK	„ <sup>1</sup> <i>Doris</i> , Win. 1865.
	„ <i>Rockfordensis</i> , Win. 1865.
	„ <sup>2</sup> <i>Missouriensis</i> , Shum. 1858.
	„ <i>Tennesseensis</i> , Win. 1869.
	<i>Proetus ellipticus</i> , M. and W. 1865.

Two other Canadian species of uncertain horizon complete the list :

	<i>Phillipsia Howi</i> , Billings, 1863.
	„ <i>Vindobonensis</i> , Hartt, 1868.

On both sides of the Atlantic therefore, so far as I am aware, the Carboniferous Trilobites without exception belong to the type possessing a pygidium with definite, even outline, like that of the two genera given above. It is true, Meek says, in his description of *Phillipsia Lodiensis* (Pal. of Ohio, vol. ii. p. 324) : “The fimbriated character of the posterior and lateral margins of the pygidium is very peculiar and hitherto unknown, I believe, in either of the above-mentioned genera” (*Phillipsia* and *Griffithlides*), “though it occurs in one section (*Phaethon*) of the allied genus *Proetus*; hence, it is possible that our species should be called *Proetus (Phaethon) Lodiensis*, as it would not be very surprising that this genus should be found in this oldest member of the Carboniferous, though hitherto, I believe, only known in the Silurian and Devonian.”<sup>3</sup>

The crenate character of the margin of the pygidium here alluded to must have been exceedingly slight in the typical specimen, as not a trace of it appears in the figure (pl. xviii. fig. 3). Prof. Meek says of this feature, “The segments are continued down upon and across the sloping border, at the edge of which they terminate in little pointed projections so as to present a fimbriated appearance around the posterior and lateral margin. (This latter character is not represented in the figure).”

It is obvious from the terms here employed that the crenation alluded to in no wise resembles the pointed and almost spinous margin of the species described below. I may add that specimens of *Phillipsia Lodiensis* from the Cuyahoga shale of this county (Summit), only a few miles from the locality of Prof. Meek’s type, show no perceptible crenation.

In regard to the two species of *Proetus* on the list given above, *P. ellipticus* and *P. auriculatus*, a few words may be added. I have not seen specimens of either, but the description of the former by its authors shows that it differs very slightly, almost imperceptibly from *Phillipsia*. They remark in conclusion, “It is very probable that we should call this species *Phillipsia elliptica*, as it seems to present most of the characters of that genus. Unfortunately, the

<sup>1</sup> Omitted from Miller’s Catalogue.

<sup>2</sup> Assigned to the Coal-measures in Miller’s Catalogue.

<sup>3</sup> In writing this sentence, 1875, Prof. Meek seems to have forgotten his own *Proetus ellipticus* of 1865, and Prof. Hall’s *Proetus auriculatus* of 1861, the former from the Kinderhook, and the latter from the Waverley Sandstone.

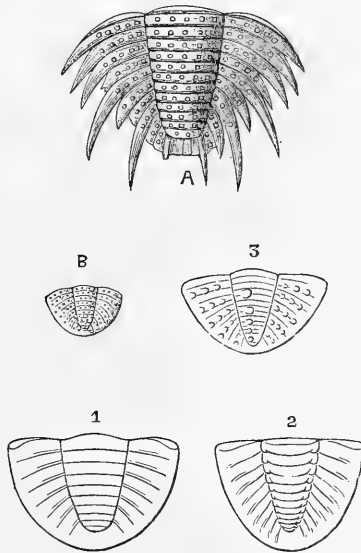


characters distinguishing these groups seem not to have been very clearly pointed out." (Proc. Acad. Nat. Sci. Phil., 1865, p. 267-8.)

The pygidium of *Proetus auriculatus*, Hall, is not certainly known. That which is supposed to belong to this species is "marked by seven or eight ribs terminating in a wide spreading border." (15th Report on State Cabinet of New York, 1862, p. 107.)

In *Proetus Verneuli*, as figured by Prof. Hall in his Illustrations of Devonian Fossils (pt. xv. fig. 18), the lateral ribs extend partly across the border, forming a line of marginal tubercles, but there is no crenation of the edge. This is the nearest approach to the appearance described by Prof. Meek (*loc. cit.*), with which I am acquainted.

A. *Dalmanites?* *Cuyahogae*, s.n. x 2.      B. *Phillipsia Lodiensis*, Meek, x 2.



1. *Griffithides globiceps*, De Kon.      2. *Phillipsia Derbiensis*, Mart.  
3. *Brachymetopus discors*, M'Coy.

It follows, therefore, that with the single possible exception of *Phillipsia Lodiensis*, as described by Prof. Meek, no Trilobite has been announced from the American Carboniferous rocks in which the pleural ridges of the pygidium extend beyond the border. The occurrence, therefore, of the form figured and described above is of considerable interest to palæontologists. It was found in the Cuyahoga Shale, the uppermost member of the Lower Carboniferous system in Northern Ohio, and its description so far as the specimen allows is as follows:—

## DALMANITES? CUYAHOGAE, sp. nov.

Head and thorax unknown. Pygidium about as broad as long, exclusive of the spinous processes to be mentioned below; distinctly trilobate. Middle lobe occupying a full third of the breadth, extending nearly to the hind extremity, distinctly separated by a furrow from the lateral lobes, and containing 11 or 12 ridges or partial rings. Lateral lobes as wide as the median lobe, their segments or ribs produced for the most part about half their length beyond the marginal line formed by their union and ending in points, the 3rd, 7th, and 9th produced to double the distance and having the appearance of spines. The 3rd pair curve backward so that their points are level with the hind end of the pygidium. No marginal tract. Whole surface set with tubercles, of which there are five on each of the three parts of the first ring, the number gradually diminishing toward the hind extremity; part of segment prolonged beyond the marginal line free from tubercles.

*Horizon and Locality.*—Cuyahoga Shale of Lower Carboniferous, Akron, Ohio.

It will of course be understood that the reference of the specimen to the genus *Dalmanites* is provisional only, and must await for confirmation the discovery of other parts of the carapace. I may add that since the above description was written I have found a second specimen and seen a third, both very imperfect, and only sufficient to support the statement of the existence of this type in the Lower Carboniferous rocks.

It may be advisable to add a few lines containing a summary of the evidence on which rests our belief of the Carboniferous age of the Cuyahoga state. The section composing this part of the geological column in Northern Ohio is as follows:—

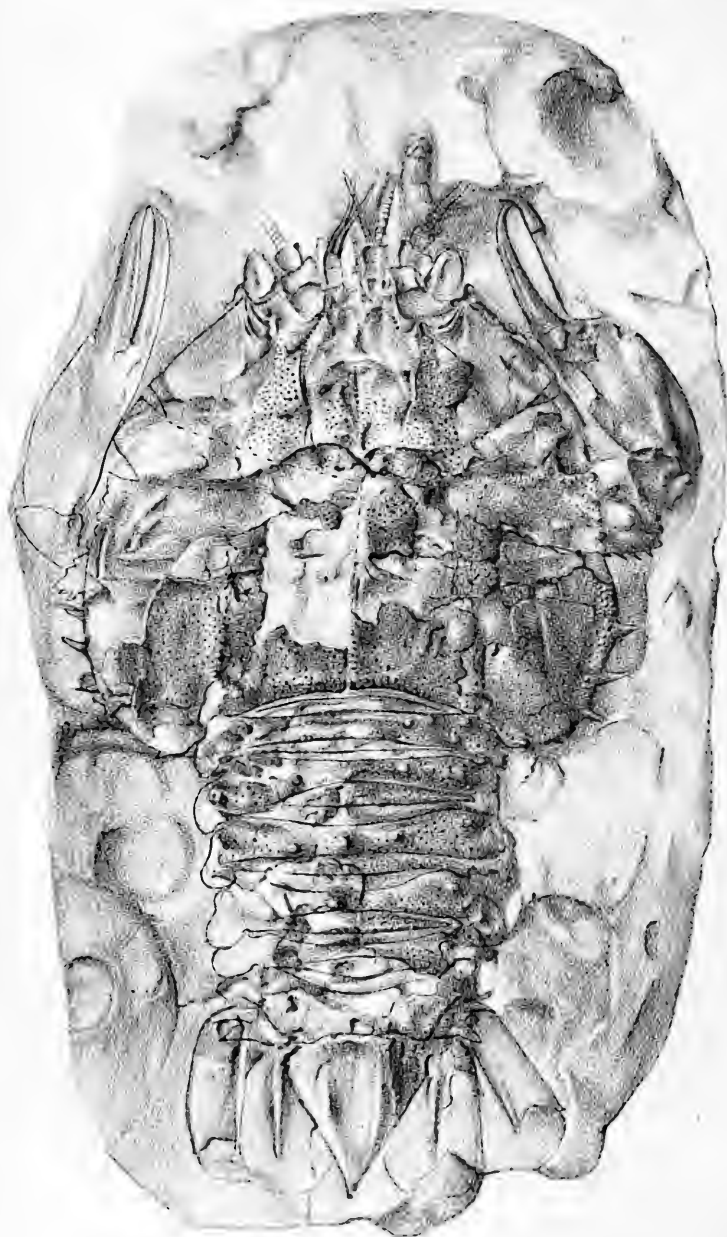
Lowest Coal.	Berea Shale.
Conglomerate.	Bedford Shale.
Cuyahoga Shale.	Cleveland Shale.
Berea Grit.	Erie Shale.

In this series the line separating the Carboniferous proper and the Lower Carboniferous is drawn by Dr. Newberry, ex-State Geologist, between the Conglomerate and the Cuyahoga Shale, and that separating the Lower Carboniferous and Devonian is placed between the Erie and Cleveland Shales. The evidence from the contained fossils is given in full below.

## FOSSILS OF LOWER CARBONIFEROUS ROCKS OF N. OHIO.

CUYAHOGA SHALE	....	<i>Ctenacanthus formosus</i> , Newb.
BEREA GRIT	....	<i>Ctenacanthus formosus</i> , Newb. <i>Annularia longifolia</i> , Brong.
BEREA SHALE		
BEDFORD SHALE	....	<i>Ctenacanthus formosus</i> , Newb. <i>Orthis Michelini</i> , L'Eveille. <i>Streptorhynchus crenistriatum</i> , Phil. <i>Chonetes Loganii</i> , Mor. and Pratt. <i>Rhynchonella Sagerana</i> , Win. <i>Spiriferina solidirostris</i> , White. <i>Syringothyris typus</i> , Win.





E. C. Woodward del. et lith.

West, Newman & Co<sup>s</sup> Imp.

*Archæastacus Willemœsii*, Spence Bate. 1883.  
(= ? *Eryon crassichelis*, H. Woodw. 1866.)

*L. 1122*

*Lyme Regis, Dorset*

CLEVELAND SHALE	....	<i>Ctenacanthus formosus</i> , Newb. <i>  furcicarinatus</i> , Newb. <i>Cladodus Patersoni</i> , Newb. <i>Orodus variabilis</i> , Newb. <i>Polyrhizodus modestus</i> , Newb. <i>Palæoniscus</i> , 2 sp.
ERIE SHALE	....	<i>Leiorhynchus mesocostale</i> , Hall. <i>Spirifera disjuncta</i> , Bly.

In regard to the fish quoted above from the Cleveland shale, Dr Newberry remarks (Pal. of Ohio, vol. ii. p. 94):—

“To the palæontologist it is scarcely necessary to say that such a group of fossils as that enumerated above could only come from Carboniferous rocks, most of the genera here represented being exclusively confined to that formation. The only exception is *Ctenacanthus*, of which one or two doubtful species have been described from the Devonian rocks of the Old World, and we have obtained one well-marked and beautiful species from the Huron shale (Portage) (*Ct. vetustus*, Newb.)”

Writing of the fossils of the Berea Grit, the same author says (p. 90):—

“The most interesting fossil found in this formation is a plant that covers some of the surfaces of the layers at Bedford, and which I have been unable to distinguish from *Annularia longifolia* of the Coal-measures.”

In regard to the Brachiopods in the list given above, *Orthis Michelini* was described from the Lower Carboniferous rocks of France; *Streptorhynchus crenistriatum* from those of Yorkshire; *Chonetes Loganii* from the Burlington group of Iowa; *Rhynchonella Sagerana* from the Marshall Group of Michigan, and of *Spiriferina solidirostris* and *Syringothyris typus* Dr. Newberry writes (p. 92):—  
 “They are characteristic of the Lower Carboniferous rocks of other States.”

The evidence of the age of the Cuyahoga Shale, and therefore of the Trilobite above described, could scarcely be more complete.

IV.—*ARCHÆASTACUS* (*ERYON*) *WILLEMESII*, A NEW GENUS AND SPECIES OF *ERYONIDE*.<sup>1</sup>

By C. SPENCE BATE, F.R.S.

(PLATE X.)<sup>2</sup>

THE several species of *Eryon*, described by various authors, appear to be distinguishable as separate genera, which are as definable from one another as from the recent forms of *Polycheles* and *Willemoesia*; but the variability appears not to be greater than in those that are separated in time through geological æons, than in those that are contemporaneous in geographical space.

<sup>1</sup> Read before Section C., British Association, at Southport, 1883.

<sup>2</sup> Mr. Spence Bate had most obligingly sent up to the Editor a pencil drawing, being a restoration of Mr. Lee's fossil, for the Artist to copy; but as Mr. Lee subsequently kindly allowed the original specimen to be drawn, it was deemed advisable to reproduce the actual fossil without additions from recent specimens.—EDIT.

While studying the fossil forms of the *Eryonidæ*, for comparison with those recently brought to our knowledge through the deep-sea explorations, I have found in the collection of Mr. J. E. Lee, F.G.S., of Torquay, a specimen from the Lower Lias at Lyme Regis, that appears to connect the ancient forms with the recent more intimately than has been illustrated in the comparison of any previously known fossil specimen.

The specimen is in a fragile and imperfect condition, but one-half of the dorsal surface is tolerably well preserved, while the other half exhibits the impress of the form only. The two conditions are shown in the accompanying figure by a different depth of shading, the more dark by that where the external texture is preserved; the less where the impression of form alone is retained; while the outline exhibits the restoration of structure in conformation with known parts.

*Archæastacus*, the generic name by which I propose to call the present genus, has the dorsal surface of the carapace almost circular, the anterior margin being nearly straight between the orbital notches, while beyond them the anterior lateral angles are produced anteriorly beyond the frontal margin. The anterior two-thirds of the lateral margin are smooth, whereas the posterior third is armed with five prominent teeth. The median dorsal line is longitudinally armed with three or four strong teeth, one not being distinct, on the frontal margin a second almost hypothetically present over the gastric region, a third and fourth over the post-gastric and cardiac regions, and evidence exists of a double row of small tubercles traversing the dorsal median line from the posterior to probably the frontal margin. The inner line of the branchial region is posteriorly defined by a small ridge that is furnished with three or four small tubercles or teeth. From the post-gastric region to the lateral walls a strong ridge traverses the line of the cervical fossa in recent crustacea, a circumstance that I believe to be due to the compression of fossilization, the weaker parts yielding, while the stronger and more rigid resist. Thus the fossa, which is due to a reflexion or folding of the dermal tissue, resists more decidedly the compression of fossilization, and thus remains rigid while the surrounding tissue has yielded to pressure. The cervical fossa, or as it may in this specimen be called ridge, bifurcates at half its length, forming an anterior and posterior branch, which incloses what I have in recent species called the *Siagnitic* region, or that part to which the *Siagnos*, or mandible is attached. The posterior portion of the animal, the pleon (or abdomen), is broad and evenly tuberculated; each somite generally carrying (or supposed to carry) one large tubercle on the posterior margin in the median line, a similar one near the margin, centrally situated above the coxal plate, and another between this and that on the median line, but of smaller dimensions, and standing on the posterior margin.

The animal appears to have no ophthalmopod, or eye-stalk, although a semicircular notch appears to exist. This may arise, as I believe it does, from the organ having, from its softer condition, perished

during fossilization, or it may be from the organ being hid or reduced to a minimum value, as observed in the recent forms of *Willemæsia*, or from its entire absence, as in *Eryoniscus*; but the presence of an orbital concavity determines that this ancient form has retrograded from a species in which the organ was an important feature.

The first pair of antennæ has three short joints to the peduncle, and the remains of a pair of multiarticulate flagella to each.

The second pair of antennæ has very little of it preserved in the specimen, but evidently carries an ovate scaphocerite; that on the right side is half lost, that on the left has the impression only; the rest of the organ is wanting on each side, except what I took to be the impression of the distal joint of the peduncle, and the first of the flagellum on the right side.<sup>1</sup>

On the right side the first large chelate pereopod is well defined, although part of it exists only as an impression. That on the left has been restored in outline from the right side, only a part being preserved.

All the other appendages are absent or hid beneath the body of the animal, except those that go to form the *Rhipidura* or tail fan.

The outer plates are only determinable by the impression left in the rock. They are broad, leaf-like, and rounded at the extremity, without any sign of a *diæresis* or division in the outer plate, or a tooth on the outer margin of the latter;<sup>2</sup> the telson is broad, double-ridged, and abruptly tapering.

This species bears a generic resemblance with *Polycheles crucifera* in the form of the carapace and *P. Mülleri* and *baccata* in that of the pleon, but differs from both in having no great dorsal ridge or prominent teeth traversing the median line of the pleon, which in this aspect more resembles that of some recent forms of *Astacus*.

The fossil also differs from the recent *Eryonidæ* in having a broad open orbital notch, instead of a narrow cleft, in the dorsal surface of the carapace, that is filled up with the upper surface of the base of the rigidly attached ophthalmopod.

The first pair of antennæ, as far as I am able to interpret the evidence at my disposal, has not the inner margin of the first joint of the peduncle produced to an elevated ridge on the inner margin; this circumstance I think is largely due to the distance at which these appendages are laterally separated from each other.

The second or outer pair of antennæ, if I have understood the parts represented in the specimen correctly, approximates that in the recent, and differs from that of *Eryon* in carrying a distinct scaphocerite at the base. It is true that Desmarest states that it is provided with a large scale; but he does not show it in his figure of the animal, and although it has been so accepted by authors, I am not

<sup>1</sup> The Artist has since succeeded in making out distinctly the three short basal joints of the second pair of antennæ.—EDIT.

<sup>2</sup> The Artist has indicated a division in the broad outer plate on the right side, probably not clearly seen when the above description was penned by the author.—EDIT.

aware of a figure or specimen in which it has been shown to be present.<sup>1</sup>

Taken as a whole the specimen that I have named *Archæastacus Willemæsii* resembles the form of the recent *Polycheles* as nearly as it does that of the ancient *Eryon*, and in the breadth of the pleon and the absence of its dorsal carina, it exhibits conditions that demonstrate a no very distant departure from the modern genus *Astacus*, which would be more appreciated, if, instead of being dorsally depressed, it had a stronger lateral compression, more especially as relates to the carapace.

It therefore appears to clearly demonstrate that the genus *Eryon* has departed from an unknown ancestor of *Astacus*, and that the recent *Polycheles* is in direct descent from *Archæastacus* of the European Lias.<sup>2</sup>

#### V.—METALLIFEROUS DEPOSITS.

By CARL OCHSENIUS, Phil. Dr. Sc. Geolog. and Geogr.,  
of the University of Marburg.

THE origin of metalliferous deposits has long been a subject of discussion. Professor Joseph Le Conte, however, seems to have arrived at a very decided opinion on this question, for in a contribution to the "American Journal of Science" (3rd series, xxvi. p. 1—19, July, 1883), after referring to Sulphur Banks and Steamboat Springs in California, he says: "Thus then subterranean waters of any kind, but especially alkaline, at any temperature, but mostly hot, circulating in any direction, but mainly upcoming, and in any kind of waterway, but mainly in open fissures, by deposit, form metalliferous veins."

At the meeting of the German Geological Society in the month of August, 1881, the formation of metalliferous veins was treated by me as being one of those phenomena which must be attributed to the action of mother liquor salts; the following are translated extracts from the journal of that Society.<sup>3</sup>

"As a consequence of my investigations concerning rock salt beds

<sup>1</sup> The scale at the base of the outer antenna in *Eryon Barrovensis*, M'Coy, is figured by Dr. H. Woodward (see Quart. Journ. Geol. Soc. 1866, vol. xxii. pl. xxv. fig. 1) from specimens in the British Museum and the collection of the Rev. P. B. Brodie, F.G.S. Dr. Woodward writes:—"Each of the outer antennæ has a large oval scale attached to its broad basal joint" (*op. cit.* p. 496).—EDIT.

<sup>2</sup> Whatever decision may ultimately be arrived at, as to the advisability, or otherwise, of abolishing the genus *Eryon*, and adopting Mr. C. Spence-Bate's proposed genus *Archæastacus*, for these Liassic Crustaceans, there is little doubt that the specimen here described as *A. Willemæsii* is the same as *Eryon crassichelis*, H. Woodw., 1866, Quart. Journ. Geol. Soc. vol. xxii. p. 497, a reduced figure of which only was given on pl. xxv. fig. 2 (*op. cit.*), in which the characters are not well shown. Capt. Hussey's specimen figured as *E. crassichelis* is moreover preserved with the underside exposed, whereas Mr. J. E. Lee's specimen exhibits the dorsal aspect. The detached carapace of *E. crassichelis*, from Mr. Day's Collection (see *op. cit.*), now in the British Museum, appears, however, identical with Mr. Lee's specimen. In Mr. Day's specimen the eye can also be detected.—EDIT.

<sup>3</sup> Zeitschrift der Deutschen geologischen Gesellschaft, 1881, 507—511; 1882, 288—372.



and their formation, it is clear that the mother liquor salts or their solutions must be looked upon as very important geological agents or elements. Mother liquor salts are one of the results of the sequence of consecutive changes which occur in a bay or an estuary separated from the ocean by a horizontal bar. When an influx of fresh water takes place in such an estuary, it is only a question of the height or configuration of the bar whether such a bay contains fresh, brackish, or salt water, the sediments in the interior of the estuary being of course of the same nature as the water which it contains. Now the changes in the size of the bar, whether from ocean storms, from land floods, or from other disturbing causes, produce the series of different layers which are found so characteristically marked in the Tertiary basin of Paris (which at the Tertiary epoch received the Loire) and in other localities.

“The precipitations which take place in such a bay, without fresh water influx, and which receives within the bar only so much sea-water as is necessary to compensate for the loss of water in the bay by evaporation, form a rock-salt bed which, in the absence of disturbing causes, is constituted of gypsum, rock-salt, and anhydrite, together with salt-clay, which represents the inorganic detritus from the shore. Mother liquor mainly composed of magnesium salts remains in a state of solution, and as soon as the level of this solution reaches the lower level of the bar, it flows out of the bay over it, in consequence of its specific gravity, which is much greater than that of the incoming sea-water. The marine animals having power of motion have long before this left the bay, as the concentration of its contents in its earlier stage makes their stay there impossible, the remainder are afterwards destroyed, leaving only traces of their existence in the first layers of gypsum. The contemporary presence of a comparatively well-developed fauna and flora in or near salt water basins or bitter lakes, with concentrated contents, is never observed.”

These views were brought forward at Jena in 1876, and have since been embodied at greater length in a treatise on the formation of rock-salt beds and their mother liquor salts.<sup>1</sup> The (if the expression be allowed) mathematical result of the process described, that is, the complete filling up of the salt-forming bay with gypsum, rock-salt, and anhydrite with salt-clay, must have occurred only in the rarest instances. The alternations, etc., observed in rock-salt layers are not now referred to, excepting to say that they are to be easily explained as resulting mainly from differences in the height of the bar. It seems quite certain, that in the majority of cases the surface of the anhydrite, instead of being level, contained many depressions which retained mother liquor in considerable quantities, and this mother liquor forms the subject of the following observations. Mother liquor, in contradistinction to sea-water, contains no sulphate of calcium; less chloride of sodium than ocean water, but more chloride of magnesium, potassium and lithium; and besides these all the bromides and iodides. The borates, notwithstanding that

<sup>1</sup> Carl Oehsenius, “Die Bildung der Steinsalzlager und ihrer Mutterlaugensalze,” Halle, 1877, and *Nova Acta*, 1878.

they are the least soluble of the sea-salts, still remain in the mother liquor, and their prominent presence in any form enables geologists clearly to distinguish mother liquor from ocean water, even when in a concentrated state. Now, as the formation of rock-salt can only occur on the coasts, and as the volcanic action of our earth takes place also on coasts or in regions adjacent, it follows that upheavals of rock-salt layers, with quantities of mother liquor in the depressions of the anhydrite, must have been of frequent occurrence. From these considerations a very simple explanation is found of those phenomena which are clearly the result of marine salts in solution, but which cannot possibly have resulted from a direct covering of the sea, and which cannot be connected with the operation of even concentrated ocean water with its contents of ordinary marine salts and organic beings. Such a phenomenon is seen in the formation of the nitrate of soda beds of Tarapacá and Atacama in South America. The enormous salt wealth of the Andes is well known; there the mother liquors carried up with the salt layers ultimately forced their way down the mountain slopes, either over or underground, eastward and westward into the lower levels on their way to the sea, leaving evidence of their passage in metalliferous veins in the form of chloride, bromide, and iodide of silver, etc.; in Tarapacá and Atacama, however, the Coast Cordilleras, composed of granite and mica schist, stopped their course, and the mother liquors, having been subject to the action of volcanic carbonic acid, became partially transformed into carbonate of sodium, and the latter, coming into contact with guano dust, carried inland from the coast by the strong predominant westerly winds, furnished the material for the formation of nitrate of sodium, the beds of which contain, and contain exclusively, the characteristic mother liquor salts or their immediate derivatives. An intelligible explanation is thus given of the enormous altitude of some of the nitrate of soda fields (Maricunga upwards of 4000 m. above the level of the sea), of the want of uniformity in the different salt beds; of the common prevalence of the borates; the total absence of fossils; the preponderance of phosphates in the coast guano south of Arica as against the absence of phosphates in the guano of the interior of the provinces of Tarapacá and Atacama; and the consequent absence of phosphoric acid in the nitrate of soda, the nitric acid of which is supplied by light phosphorless guano dust. Eastward of the Andes (in the Argentine Republic) mother liquor salts are found as salt-swamps. With reference to the formation of the carbonate of soda, it must be further remarked that such a product is only found where inorganic carbonic acid has come into contact with mother liquor salts; the effects of which are to be observed on a large scale in the west of the United States.

As to this it was stated before the same society in my treatise: "Geologisches und Montanistisches aus Utah." In addition to the foregoing remarks upon the thermal and salt springs of Utah, some observations upon carbonate of soda must be made, as the absence of this salt in Utah throws great light upon its genesis. The report

of the Utah Board of Trade for the year 1879 says, "The first settlers there found sufficient soda for household purposes in the Emigration Cañon lying to the east of Salt Lake City;" but this report is the only work in which the existence of carbonate of soda in Utah is noted. Cl. King adverts to this striking circumstance in these words:—"It is a noticeable fact that in such a dense saline solution (sc. the Great Salt Lake) one in which the solid matter is approximately 15% of the entire weight, there are none of the alkaline carbonates which are characteristic elements in the saline lakes farther west. In the absence of carbonates, Great Salt Lake resembles the Dead Sea; but in the enormous predominance of chloride of sodium over all other salts, and in the entire absence of carbonates, it is unlike any other large lake the analysis of whose waters has been published."

Now it is very clear that the continued presence of carbonate of calcium in the water of the lake is impossible, because carbonate of lime is precipitated from sea water of a specific gravity of 1.0506, and the water of Great Salt Lake has such a specific gravity only in the margins of the lake after winter rains, and in the mouths of rivers or streams running into it and occupying limited spaces, whereas the specific gravity of the general body of water is 1.107. The carbonate of lime contained in the influx water never reaches the main body of the Great Salt Lake water of comparatively great specific gravity, because it has already been deposited in its passage through the narrow marginal band of water of less density, and this is fully confirmed by the description of tufaceous limestone found in some places on the shore, which according to Cl. King contains opaque, dust-like particles in mechanical combination and organic matter like the roots of water plants, as well as minute mollusks enveloped in the mass.

Such deposits occur of course during the whole year at the mouths of the constantly flowing rivers Jordan, Weber, and Bear, but at other parts of the shore only during the wet season, when the rain water drains lime into the lake. Sea water (as is evidenced by Usiglio's exhaustive experiments) deposits, as has already been mentioned, carbonate of lime when of the specific gravity of 1.0506; that is, as soon as its volume has been decreased to about half by evaporation; when the concentration is continued however, until the water occupies  $\frac{1}{3}$  of its original volume, traces only of carbonate of calcium are deposited; but when the reduction goes on until the water occupies only about 19% of its original volume (specific gravity 1.1304), a second precipitation of carbonate of calcium appears nearly as heavy as that which first occurred containing 0.053 as against 0.064 of the first deposit. This latter deposit occurs in consequence of the interchange of components of carbonate of sodium and sulphate of calcium forming sulphate of sodium and carbonate of calcium. Gypsum and carbonate of soda remain unchanged only in weak solutions. Usiglio has determined with great exactitude the two periods of precipitation of carbonate of lime from sea water. The concentration of the Great Salt Lake water is not

yet nearly sufficient to produce the second deposit of carbonate of lime. It occupies only about  $24\cdot5\%$  (specific gravity 1·107) of the volume of pure sea water, so that still further reduction down to  $19\%$  (specific gravity 1·1304) is required before the second deposit can take place. If carbonates of soda were formed in the neighbourhood of the Great Salt Lake from limestone formations and salt matter, then these must have been drained into the lake and would be found in its waters, or at any rate in the mineral springs of the neighbourhood. This, however, is not the case, and no carbonate of soda at present exists there. With reference to this Cl. King says :

“Along the base of Wahsatsch Range at Salt Lake City and north of Ogden, are important hot springs pouring a large volume of heated waters into the lake drainage. They contain sulphuretted hydrogen, carbonates of lime and magnesia, sulphate of soda, and chloride of sodium, the latter being in all cases much the largest factor. From a qualitative examination of numerous salines, besides those whose quantitative analyses are given in the accompanying table, it seems that the predominant salts of this whole basin are chlorides of sodium and magnesium, with sulphates of soda, lime, and potash, the latter always in much less quantity than the chloride salts. The efflorescence at the sink of Deep Creek is the only alkaline carbonate observed; and even if in the localities not visited by us there should be found other sources of alkaline carbonates, they must remain as exceedingly unimportant and exceptional salts in this basin.” (40th Par. vol. i. p. 500.)

Now no carbonate of soda exists in the district of the Great Salt Lake although so plentiful in the neighbourhood of the rich soda basin of Lahontan in Nevada, and this surprising circumstance, which King looks upon as difficult to explain, is very intelligible if a glance be given at the map No. vi. in the first volume of his work. In the whole region of the Great Salt Lake, only two trachyte masses of any importance exist, that of Clayton's Peak and the less important mass through which the Jordan flows. Beyond these in the whole of the immediate drainage-region of the Lake there are only the insignificant trachyte mountains to the south of the Utah Lake in the neighbourhood of the watershed, and isolated basalt cones scattered about. The Lahontan Basin lying westward with its many lakes is rich in carbonate of soda, and is in striking contrast to the absence of this salt in Utah. The cause of this great difference between the two basins arises from the fact, that the Lahontan district is covered with innumerable volcanic upheavals of basalt, rhyolite, trachyte, dacite, andesite and propylite. The salts which came into contact with them were formed from the same mother liquor as in Utah; the only difference being, judging from their comparatively large proportion of borates, that in Nevada the mother liquor existed perhaps in a more concentrated state. Many isolated eruptions created large areas of disturbance and large quantities of carbonic acid, the latter forming with some of the mother liquor salts carbonates of sodium. This has been the case not only in the west of the United States, but also in all cases where

Trona is met with in large quantities, for instance, in Hungary, Egypt, Fez, India, etc. In face of these facts, the hypothesis that soda is the result of an interchange of the components of carbonate of lime and chloride of sodium is quite untenable. It cannot possibly be the result of such an interchange; for where do more favourable circumstances exist to produce Trona, etc., as in Utah and in the Sahara? There the mother liquor salts are found in the closest contact with limestone-formations under the most favourable climatic conditions, but in neither place is carbonate of soda to be found, although most diligent search has been made for it.

In proximity to the carbonates of sodium are found also those of potassium and magnesium, and these, combining with animal detritus, formed the nitrate of potash in the plains of Hungary, and the nitrates of potash and magnesia in India. The predominating presence of saline substances in these salts leaves no doubt but that they belong to the category of mother liquor salts, which were formed in rock-salt layers of the Carpathians, the Himalaya, etc. The influence of mother liquor sufficiently accounts for many other phenomena; such for example as the origin of the materials found in salt springs and salt lakes. These do not originate, as has been wrongly supposed, directly from waters permeating rock-salt layers of prior formation, and which supposition has already been refuted by von Dechen, but a rock-salt bed was in all cases the main product, and the salt materials of mineral springs and salt lakes, the secondary product of the same process. This sufficiently explains the great distance which is sometimes observed between rock-salt layers and the salt springs, the materials of which originally formed in the same locality afterwards flowed away. The mother liquors on their course sometimes part with some of their constituents, for instance, borates; and the separation of chlorides and sulphates can be readily observed in salt-swamps in the Argentine Republic, and in the west of the United States, etc., and similar separations are the cause of the variety of contents of salt springs. The exhalations of boracic acid in Tuscany, as well as the appearance of the borates in California, Tibet, etc., and even the saline substances thrown up by mud-volcanos, are all dependent upon the presence of mother liquor salts. Solutions of these salts transform limestone into dolomite; and serpentine must probably also be looked upon as the product of the transformation of various kinds of rocks under the influence of mother liquor- (magnesian-) salts. Sulphur layers formed by hydro-chemic action also owe their origin to the co-action of mother liquor salts. Petroleum is formed when a stream of downcoming mother liquor suddenly destroys all flora and fauna contained in an oceanic bay. The accumulated cadaverous remains become thus covered with an impermeable sediment of silt, clay, etc., furnishing then the material for the liquid carbon-hydrogen compounds; these sometimes becoming free, impregnated other strata.<sup>1</sup> It is even possible that overflows of mother liquor salts were the cause, in some cases, of the sudden extinction of vegetable life in forests, thus forming the materials for coal-fields; for the presence of certain marine salts

<sup>1</sup> Ochsenius, Petroleum-Bildung, Natur, No. 29, 1882, Halle.

(bromides, iodides, etc.) in coal, points more to this conclusion than to any other; for instance, to the opinion that they were formed out of masses of Fucus.<sup>1</sup>

An immense field of inquiry is opened out by the consideration that mother liquors are a solvent of every known metallic substance, not excepting even gold; and consequently that the majority of metalliferous veins and layers owe their existence to the action of mother liquors upon disseminated particles of metals, which become thus collected and deposited in fissures, cavities, etc.

Now with reference more particularly to the sentence of Professor Le Conte's article, already mentioned, I may be allowed to refer to the expression "subterranean," because it is quite certain that they were *not* underground waters which carried the contents of silver and copper to the silver-bearing sandstones of South Utah near Leeds.

Many theories have been propounded as to the origin of the metalliferous contents of these sandstones, and they have even been attributed to volcanic metallic vapours; although in the Rio Colorado district, where copper-bearing sandstone forms immense beds, there is no sign of volcanic agency. The volcanic masses in the Leeds region certainly belong to a much more recent period than the sandstones. To the south-west of these sandstone beds however, at distances from 9 to 14 miles, rock-salt layers are found; as well as in the north-east of the same (Washington) county; 15 miles from St. George on the border of the Virgin River; and in many other places within these territories. The mother liquors flowing away from these layers dissolved the metals met with in their course and carried them to the sandstones. The presence of rock-salt in the silver-bearing sandstones of Leeds is easily detected, inasmuch as the residuum of a drop of water, in which pulverized sandstone has been placed, shows under the microscope the characteristic cubes of chloride of sodium.

Similar metallic impregnations to those of Leeds are noticed in the sandstones of the coast of California (silver and mercury), of the Blind Springs and other localities of Mono County, California (antimonial silver ore), of New Mexico, of Arizona, of Texas, of New Jersey, of Lake Superior region (copper), etc., etc. In the same manner the sulphides of arsenic have been carried into the clay-layers of the Coyote mining district of Southern Utah.

Thus the expression subterranean is not applicable to all cases; certainly not to the cases where metals already deposited in veins have subsequently undergone a change from contact with mother liquor salt solutions coming from above, as for instance in the silver veins of Chile. There the chloride of silver is always found in the highest regions of the veins; then follows bromide; and lastly iodide.

This invariable sequence is in perfect conformity with the different degree of solubility of the mother liquor salts; of which the iodide salts are most soluble and therefore permeate to greater depths; after the chlorides and the bromides have given over to the metals their

<sup>1</sup> There is no evidence to be derived from Palæobotany in support of this theory; on the contrary, there is abundant evidence to prove that Cryptogamic Land-Plants built up the Coal-measures.—EDIT.

chlorine and bromine. The salt solutions which changed the character of the veins in this case therefore were not subterranean before they reached the deposited metals.

The expression "*alkaline*" which Le Conte has already used before in his "*Elements of Geology*" (1879), when treating of the formation of metalliferous ores, should also give place to the word *saline*; for chloride of magnesium, which certainly plays a very important part in the dissolving process of metallic substances, belongs just as little to the alkalies as does sulphate of magnesia, which is another large constituent of mother liquors. It is well known that many metallic sulphides crystallize out of mother liquor salts, evidenced by the finding of masses of crystallized pyrites in kieserite and galena in anhydrite. Silicates are also formed from solutions of mother liquor (quartz-crystals in carnallite; tourmaline in anhydrite changed into gypsum). The proof that gold is contained in many cases in American silver ores in the form of chloride, has been already demonstrated.<sup>1</sup>

That mother liquor has been an agent in the formation of Sulphur Banks and Steamboat Springs is very clear; the presence of borium in them is of itself a sufficient evidence of that.

The view of G. Bischof that uprising waters are stopped in their progress by their own depositions can only be partially correct. The same chemist says that deliquescent chlorides (chloride of calcium and chloride of magnesium) never occur in a solid state, notwithstanding that the latter (named by me Bischofit) occurs in massive bulk at Leopolds-hall, near Strassfurt.

Haidinger has already advanced the view that the changes of many calcareous formations into dolomite must have been produced through the agency of sulphate of magnesia, although it was not then known how such large quantities of the solutions of magnesium-salts originated, and this problem was not solved until my views on the subject were brought forward.

The foregoing answers a very important question, which might be put to Professor Le Conte as to the source of the alkaline solutions, to which he attributes the formation of metalliferous veins. My long investigations in various parts of the world enable me to answer this question incontrovertibly, and beyond this they enable me to designate mother liquor as one of the most influential of geological agents.

I must remark here, however, that the opinion that adjacent rocks furnished materials for metalliferous veins has already been expressed by Forchhammer (1847), and consequently that Sandberger, against whose views Le Conte's expressions were partially directed, does not stand alone in that opinion.

If saline solutions, or let me say mother liquors, do not come into contact with metallic substances on their flow from higher levels; then salt springs, but not metalliferous beds, are formed.

Now as to the concluding words of Le Conte's sentence, "Subterranean waters of any kind, but especially alkaline, at any temperature, but mostly hot, circulating in any direction, but mainly

<sup>1</sup> Zeitschrift, etc., vol. xxxiv. p. 519.

upcoming, and in any kind of waterway, but mainly in open fissures, by deposit form metalliferous veins," I consider that these words should be supplemented by, "if they contain sufficient quantities of ores in solution," as we possess very many alkaline and saline springs and waters, which form no metalliferous veins and no metallic deposits.

*Metalliferous deposits are in fact constituted of metallic particles, extracted from rocks by mother liquors, either with or without the co-operation of carbonic acid, and accumulated in fissures, cavities, or depressions.*

*Mineral springs found in many metalliferous regions evidence the former activity of mother liquors.*

Space will not allow more detailed explanations of the points touched upon here to be given; these must be sought for in a work which I hope shortly to put before the public. It is gratifying to me to learn that Professor Le Conte, as a result of his very valuable investigations in California, has arrived at nearly the same conclusion about metalliferous deposits, as I did some years ago.

## VI.—ON THE CLASSIFICATION OF SEDIMENTARY STRATA.<sup>1</sup>

By W. T. BLANFORD, F.R.S., Sec. Geol. Soc.

**T**HE true test of the classification adopted for European sedimentary formations is to endeavour to apply it in distant parts of the earth. It will then be seen whether the classification in question is real, or whether it is founded on local and accidental peculiarities of the rocks in a particular region.

So far as the geology of India has been studied, it appears doubtful whether the sedimentary formations of that country can be accurately classified by means of the European subdivisions. The difficulty, it is true, is partly due to the paucity of fossils in Indian rocks, but partly also to the circumstance that the breaks in the sequence do not correspond with those especially remarkable in Europe. For instance, it has not been found easy to draw an exact line of separation between the uppermost Palæozoic and lowest Mesozoic strata at one of the very few localities where both are marine and fossiliferous, the Salt Range of the Punjab. There is, so far as is known, no physical break, the two systems being perfectly conformable to each other, and the change in the fauna is, to say the least, more gradual than in Europe, several Triassic genera being found in the Upper Carboniferous series. Again, throughout Sind, Baluchistan and the Punjab on the western frontier of India, the uppermost Mesozoic strata underlie the lowest Cænozoic with perfect conformity, and in one stage an intermediate fauna is found between Cretaceous and Eocene.

It is unnecessary to point out that similar observations have been made in other parts of the world, and it follows as a reasonable con-

<sup>1</sup> This paper has been drawn up for the Committee of Nomenclature of the International Geological Congress to be held at Berlin, in September.



clusion that the European classification can only be applied to sedimentary formations in India and other distant countries as an artificial scale or measure of comparison, the divisions in which are founded on local phenomena existing in certain parts of Europe, and mostly of Western Europe.

The first essential condition to be observed in order that such a scale may be of universal application is that the principal divisions should be as nearly as possible of equal value. This value cannot be determined by the local development or thickness of each subdivision, nor by the evidence of discontinuity or break, usually represented by unconformity, between them. It is notorious that a thick system in one country may be represented by beds a few feet thick in another, and that unconformity may occur between two local stages not recognizable as distinct elsewhere. The only valid evidence is the distinctness of the marine fauna, considered as a whole, in each division, and in order to judge of this fauna rightly, a large number of the characteristic types belonging to different subkingdoms and classes must be taken into consideration. The value of plants, and of land and freshwater animals is doubtful; they must certainly be considered apart from the marine fauna.

At the same time any great change in the scale usually adopted in Europe would defeat the main object, that of having a standard classification for reference.<sup>1</sup>

With these preliminary remarks we may pass to a very brief consideration of the systems. It would, perhaps, be best to admit, as once proposed by Renevier, only two major Palæozoic divisions—(1) Cambro-Silurian, and (2) Devonian-Carboniferous-Permian. But it may be questioned whether there is any chance of such a proposition being accepted. The union of Cambrian and Silurian, however, has been agreed to by the Committee of Nomenclature at Zurich, and will in all probability be accepted generally on the Continent.

The Devonian system must probably be left. Permian is almost purely European, not having been clearly recognized in any other country. The fauna is not sufficiently distinct from the Carboniferous to justify the retention of the Permian as a separate system, and the division would in all probability never have been raised to that rank but for the practical importance of its beds, on account of their immediately overlying the valuable Coal-measures. The evidence of the Indian Salt Range section, in which the upper series of the Carboniferous or Productus Limestone system (Waagen, Pal. Ind. ser. xiii.) contains more Triassic forms than the Magnesian Limestone of Europe, is entirely opposed to the separation of a Palæozoic system above the Carboniferous. The general classification would be in every way improved by the Permian being considered as Upper Carboniferous.

Amongst Mesozoic divisions the Rhætic alone requires notice. The

<sup>1</sup> It will be found that the views here expressed have much resemblance to those of Professor Dana (Manual of Geology, 1863, p. 125) and of Professor Renevier (Bul. Soc. Vaud. Sc. Nat. xiii. pp. 229, etc.) It should therefore be stated that the paragraphs as they stand above had been written before either of the works named were consulted.

# GENERAL CLASSIFICATION OF FOSSILIFEROUS FORMATIONS.

SYSTEMS.	SERIES.	PRINCIPAL BRITISH REPRESENTATIVES.	TYPICAL EUROPEAN CONTINENTAL REPRESENTATIVES.	
CENOZOIC OR TERTIARY	PLIOCENE.	1. Upper or <i>Pleistocene</i> . 2. Middle or <i>Subapennine</i> . 3. Lower or <i>Messinian</i> .	Glacial and Inter-Glacial beds, Boulder-clay, drift, etc. Crag. <i>Wanting</i> .	Upper Sub-Apennine, or Asian and Plaisancian. Lower Sub-Apennine or Messinian. Faluns de Louraine. Tortonian and Helvetian.
	MIOCENE.	1. Upper or <i>Falunian</i> . 2. Middle or <i>Mayencian</i> . 3. Lower or <i>Oligocene</i> or <i>Aquitanian</i> .	<i>Wanting</i> ? Hempstead, Bembridge, Osborne, and Headon beds. Barton Clay and Upper Bagshot Sand.	Lower Marine Miocene of Vienna basin? Oligocene of Germany and the Alps.
	EOCENE.	1. Upper or <i>Bartonian</i> . 2. Middle or <i>Parisian</i> . 3. Lower or <i>Suessonian</i> .	Middle and Lower Bagshot and Bracklesham beds. London Clay, and Thanet, Woolwich, Reading, and Oldhaven beds. Chalk.	Gypse de Montmatre and sables marins moyens of Paris basin. Calcaire grossier—Nummulitic limestone of Alps. Sables de Bracheux—Lower Eocene of Belgium.
MESOZOIC OR SECONDARY	CRETACEOUS.	1. Upper or <i>Senonian</i> . 2. Middle or <i>Gault</i> . 3. Lower or <i>Neocomian</i> .	Upper Greensand and Gault. Lower Greensand, Wealden and Hastings sand. Purbeck, Portland, Kimmeridge Clay, and Coral Rag.	Danian, Senonian and Turonian stages. Cenomanian and Albian. Aptian, Urgonian and Neocomian. Malm or Weisser Jura of Germany.
	JURASSIC.	1. Upper or <i>Malm</i> . 2. Middle or <i>Dogger</i> .	Oxford Clay, Kelloway Rock, Cornbrash, Bradford Clay, Forest Marble, Great Oolite, Stonesfield Slate, Fuller's Earth, Inferior Oolite.	Dogger or Brauner Jura of Germany.
PALÆOZOIC.	TRIASSIC.	3. Lower or <i>Lias</i> . 1. Upper or <i>Rhaetic</i> . 2. Middle or <i>Keuper</i> .	Lias. Penarth beds and white Lias. New Red Marls and Keuper Sandstone	Lias, or Schwarzer Jura of Germany. Kossener Schichten and Dachstein of Eastern Alps. Kahl, Hailstadt and St. Cassian of Eastern Alps—Keuper of Germany.
	CARBONIFEROUS.	3. Lower or <i>Werfenian</i> . 1. Upper or <i>Permian</i> . 2. Middle or <i>Coal-measure (Dimetian)</i> . 3. Lower or <i>Bernician</i> .	Bunter or mottled sandstone and pebble beds. Permian sandstones, Conglomerates, etc., Magnesian limestone, marl slate. Coal-measures and Millstone Grit. Mountain Limestone.	Virgitoriakalk and Werfener Schichten of Eastern Alps—Muschelkalk and Runter of Germany. Zechstein, and Rothliegendes of Germany—Permian of Russia. <i>Fusulina</i> limestone of Russia. Lower Carboniferous of Belgium, France, and Germany.
	DEVONIAN.	1. Upper or <i>Famennian</i> . 2. Middle or <i>Esfejian</i> . 3. Lower or <i>Coblenician</i> .	Pilton and Pickwell Down group. Ilfracombe group. Lynton group.	Upper Devonian of Rhine and Belgium. Middle Devonian of " " Lower Devonian of " " Third Fauna of Bohemia—Etages F.F.G.H.
SILURIAN.	1. Upper or <i>Silurian</i> . 2. Middle or <i>Ordovician</i> . 3. Lower or <i>Cambrian</i> .	Lower Llandovery, Caradoc, Llandello, and Arenig beds. Tremadoc, Lingula Flags, Menevian and Hartlech beds.	Second Fauna of Bohemia—Etage D. First, or Primordial Fauna—Etage C.	

classification of Lower Mesozoic rocks should be founded not on the useless and untypical German sequence, with two subdivisions not marine, but on the Alpine sections, where nearly all the beds are marine, the Rhætic being the upper member or series of the Triassic system. By adding the Rhætic to the Trias the latter becomes more nearly equal in importance to Jurassic and Cretaceous than it would otherwise be.

Of the Tertiary systems hitherto proposed, none except the Eocene can be considered as of equal rank with the main Palæozoic and Mesozoic divisions. The method recommended by several German and Swiss geologists of dividing the whole of the Tertiary strata into two systems, Eocene, including Oligocene, and Neogene or Mollasique, comprising Miocene and Pliocene, would be a great improvement. But there appears so little probability of this classification being adopted, that the only practicable suggestion appears to be to unite the Oligocene with the Miocene, and to include the Pleistocene, which has no claim to recognition as a separate system, in the Pliocene.

These propositions lead to precisely the same conclusions as those of the Swiss Committee of 1881 (*Arch. Sc. Phys. Nat.* 1881, p. 510; and 1882, p. 536), and to the subdivision of each of the major categories<sup>1</sup> Palæozoic, Mesozoic and Cœnozoic into three systems. All the terms of inferior rank to systems are even more local, and it would greatly conduce to simplicity if a tripartite division of systems into series were adopted. If it be objected that such a subdivision is artificial, the reply must be that, beyond the limits of Europe, only an artificial scale is practicable. The accompanying is an attempt at such a scale. It will be at once recognized that Jurassic, Triassic, and Cambro-Silurian are easily divisible into three, whilst most of the other systems present no difficulty. The most doubtful series are Lower Pliocene and Middle Miocene. The names in italics are merely suggestions, and are in no case new.

It is possible that some of the subdivisions proposed may be improved. For instance, it is a question whether the Upper Greensand or Cenomanian should be classed as Middle or Upper Cretaceous, and there is much doubt as to the best division between Upper and Middle Jurassic. The important principle is that all subdivisions should be as nearly as possible of equal value, not locally but throughout the world.

## VII.—THE PERMIAN-TRIAS QUESTION.

By the Rev. A. IRVING, B.A., B.Sc., F.G.S.;  
of Wellington College.

AT the present stage of the controversy, it may seem, to those who have read carefully the paper of M. Marcou in the March Number of this MAGAZINE, that very little remains to be said. Yet, however much it is to be regretted, it must be feared that insular prejudice still finds place with English geologists, and prevents

<sup>1</sup> The use of the word *groups* for these major divisions of sedimentary strata does not appear acceptable to English geologists.

them from seeing so clearly as they otherwise might do the full bearing of the evidence which we possess. I have thought, therefore, that at the present juncture it would be useful if one gave a short historical résumé of a few facts, taken partly from the introduction to Geinitz's great Monograph on the *Dyas*. The title of this work is of importance as an index of the stage at which the battle between the followers of Murchison in this country and the advocates of what we may call German views had arrived in the year 1862, when Geinitz's great work was published in Leipzig. Some years before this, Murchison had propounded his view of a "Palæozoic Trias" in his *Siluria*, and subsequently he went over a good portion of Central Germany with Prof. Morris, and on his return gave to the Geological Society his long paper on the Thüringen and Hartz country. This appeared in the "Quarterly Journal" in the year 1855. These two (the paper just referred to and *Siluria*) being in English are readily accessible to every English geologist; they have been referred to more at length by me in the long paper which appeared in the pages of this MAGAZINE in the year 1882. Any one who will take the trouble to read the joint paper by Murchison and Morris will see plainly enough that in Germany, the Triassic system had been worked out before this by native geologists. It had by them (without exception, so far as I am aware) been made to include all the sandy and marly beds down to the dolomitic series of the Zechstein. When Murchison came upon the field, therefore, with his ready-made "Permian System" imported from Russia, it was from his side that aggression (if any there was) must be considered as having come. Geinitz's work had not yet appeared; but the materials for it were being collected, and the German geologists seem to have been pretty unanimous and clear in their ideas of the set of beds which remained to be described between the Carboniferous series and the Trias, as they understood the latter term. These remarks prepare us to understand the title of Geinitz's work as it appeared in 1862. It runs thus:—*Dyas, oder die Zechsteinformation und Rothliegende (Permische Formation zum Theil).*

The author does not raise the question of the value of the "Permian System" as applied to the Russian strata; he merely points out that in treating of the *Dyas*, he has rejected from his system the Bunter- and Mergel-Schiefer, which no German geologist had ever thought of bracketing with the Zechstein and Rothliegende, until it had been suggested by Murchison, so that the *Dyas* is a *part only* of the "Permian System." In his "Introduction," Geinitz expresses his obligations to Murchison's works, especially to *Siluria* and his *Geology of Russia*; but he dissents entirely from the view maintained by Murchison of a "Palæozoic Trias," including within it the Bunter-Schiefer. Geinitz points out that the so-called Bunter-schiefer do not belong to the end of the *Dyas*-period, but more properly to the beginning of the Trias; for (1) the deposition of these strata "first began after the upper layers of the *Dyas* were already hardened, fissured, and partly destroyed." (2) "The boundary

between the two is found to be as sharply defined as that between the Carboniferous and the lowest strata of the Dyas;" in fact, "the strata of the 'grey conglomerate' or lowest Rothliegende are never found unconformable with the Coal-measures, but here it is generally the case." It is absurd for any one to say that this is a mere 'fad' of Geinitz's: every one with whom I have discussed the question in Germany holds the same view, and I may especially mention Dr. Liebe of Gera, who has mapped a great part of the country in the Gera district, as supporting the view. Not a scrap of fossil evidence has ever come to hand, with the exception of the wretched (so-called) *Calamites arenaceus*, upon which Murchison laid so much stress. On this point, to set aside all further room for doubt, I quote from M. Marcou's *Dyas et Trias*, published in Geneva in 1859. On p. 10 he says: "Le *Calamites arenaceus*, Brong., n'est autre que l'*Equisetum columnare*, Brong., ainsi que l'ont prouvé Bronn, Quenstedt, et surtout le docteur Constantin von Ettingshausen dans *Beitrag zur näheren Kenntniss der Calamiten* (extrait des *Sitzung. der mathem. naturw. Classe der K. Akad. der Wissenschaften*, vol. ix. p. 684, Vienne, 1852).<sup>1</sup> M. Ettingshausen démontre, dans cet intéressant mémoire, que le *Calamites arenaceus* est la partie interne de l'*Equisetum columnare*, que ce fossile est exclusivement secondaire, et qu'il est l'un des plus caractéristiques (*Leitpflanzen*) du trias. Par conséquent, paléontologiquement, le bunter sandstein inférieur est du trias, et comme, d'un autre côté, les caractères lithologiques et stratigraphiques, sont entièrement en faveur de sa réunion avec le bunter supérieur, et non avec le zechstein, il s'ensuit que l'on ne voit aucune raison plausible pour l'enlever du trias."

Again, for any one to talk of the palæontological evidence of the Palæozoic affinities of the two great formations of the Dyas (Zechstein and Rothliegende) as depending upon the presence or absence of one or two miserable little shells (or casts of them), can only provoke a smile from any one who will take the trouble only to look leisurely even through the plates of Geinitz's splendid monograph; and if he will only seize the first opportunity of examining the splendid collection of Dyas fossils in the Zwinger Museum at Dresden, and compare them with the equally splendid collection in the same gallery of Carboniferous fossils; further, if he should be so fortunate as to go to Gera with an introduction to my delightful friend Herr Eisel, who has collected a great number of the most perfect and choice specimens of Zechstein fossils in the world (many single specimens of which furnished the originals from which Geinitz's drawings were made); if then he should go on to the Geologische Reichsanstalt at Vienna, and see the flora of the Coal-bearing Rothliegende of Bohemia there displayed side by side with the flora of the Coal-measures, I think the impression left upon his mind will be that, while, on the one hand, the fossil evidence furnished by our Post-Carboniferous Palæozoic strata is comparatively meagre, the evidence furnished by the strata of the Dyas of

<sup>1</sup> I merely note the fact that this was *three years prior* to the appearance of Murchison and Morris's paper in the Q. J. G. S.

Germany is simply overwhelming. In the light of such evidence the title and scope of Geinitz's great work on the Dyas is fully justified; and one can afford to let pass without further notice such a condemnation of Geinitz's action as Prof. Roemer of Breslau gave utterance to last year, when the subject was discussed in Section C. of the British Association.

All that I have seen in Middle Germany, both in Museums and in open sections in the field, shows me that there is an unconformity on a grand scale between the Trias and the Dyas, and also an unconformity (on a smaller scale) between the lowest Bunter strata and the Zechstein. This unconformity perhaps many members of the Survey, whose notions of unconformity seem limited to the particular form or kind of unconformity which is described in Prof. Ramsay's *Lectures on the Physical Geology of Great Britain*,<sup>1</sup> would not be prepared to recognize. There, is however, another kind of unconformity, which is quite a distinct thing from "contemporaneous erosion and filling up" (a term first used by the late Prof. Jukes), which is well described and illustrated in Geikie's edition of Jukes' *Manual of Geology*, and is recognized in the later text-books of Prof. Green and Prof. Geikie. In such cases erosion and partial destruction of one set of beds has gone on to a considerable extent, and the hollows formed by such erosion (whether aqueous or sub-aërial) have been filled up by subsequent deposits without any general divergence of dip of the two series of beds. Yet in such a case the terms of Prof. Jukes' definition of unconformity,<sup>2</sup> as including every case in which "the base of one set of beds rests in different places on different parts of another set of beds," are complied with. Of course, in places where the erosion of the lower set of beds is less pronounced (and the causes of inequality of erosion are too obvious to need mention here), there may be an *apparent conformity*; and so insufficiency of observation may mislead an observer whose opportunities of observation are limited. This is no doubt partly the cause of the error into which Murchison fell, when he insisted repeatedly upon a conformity between the Zechstein and the Bunter-Schiefer. In places, again, where an open section has been considerably weathered, it often happens that, if the upper set of beds is composed of friable material, the junction may be obscured by the mere washing down of material by rain; and this may perhaps have been the case in places in which Murchison speaks of a petrological transition from the Zechstein into the Bunterschiefer. Sections however, which are fresh and open, and about the reading of which there can be no mistake, are much more numerous in Central Germany than they were thirty years ago; and in no section that I have seen has there been anything like a petrological transition from the Zechstein into the Bunterschiefer, where the junction was exposed. Breccias composed of fragments of the underlying Upper Zechstein, and even in some cases of the Middle Zechstein strata, are common enough. I have seen cases, in which

<sup>1</sup> 5th edition, p. 36.

<sup>2</sup> Geikie's edition of Jukes' *Manual*, p. 230.

unequal underground solution of more soluble strata, as in the case of beds of gypsum in our midland counties and beds of chalk underlying drift in the southern counties, has led to a complete bouleversement of the stratification of the superjacent deposits; and nothing is more familiar to a German geologist than the phenomena known as *Erdfälle*, which are simply local sinkings of the ground, owing to unequal removal by chemical erosion of soluble underlying beds. It would be difficult, however, if not impossible, for the most ardent advocate of a theory, to imagine the inequalities produced by the erosion of a lower set of beds, having taken place subsequently to the deposition of another set of beds upon the top of them, while the beds of the upper set have preserved a perfect *regularity and horizontality of stratification* even down to the very bottoms of the hollows which they have filled. Yet this is the case at the junction of the Zechstein and Bunterschiefer as it is exposed in numerous sections in Central Germany, some of which I have described in a paper recently read before the Geological Society. Again, such underground erosion would leave a ragged and unworn upper surface of the Zechstein limestones; but in quarry after quarry I have seen, on the contrary, the upper eroded surface of the Plattendolomit of the Upper Zechstein, where it was laid bare in the quarrying operations, with the angles of its protuberances distinctly rounded off, just as one might expect from the scouring action of the finer *débris*, which must have been once suspended in the water and carried along by the currents, which deposited the thinly stratified (in places one may say laminated) materials of the Bunterschiefer.

Those who will weigh the evidence carefully will find, I think, that there is at least as great an unconformity between the Zechstein and Bunterschiefer in many places in Central Germany as there is in Lancashire between the lowest Bunter and the Magnesian Limestone series, or as that upon which Mr. Aveline insists between the lowest Bunter-strata and the Magnesian Limestone series in Nottinghamshire. The evidence of a break in time between the Zechstein and the Bunter is overwhelming: and it follows therefore, that wherever, in following Murchison, I have spoken in my former papers of a conformable sequence existing between the Dyas and Trias of Germany, all that must now be considered as unsaid.

I hold that this is far more than a quarrel about mere names. The name 'Dyas' may not be the best that can be found; but the classification which is adopted by those who have applied the name is undoubtedly that which *coincides most closely with the facts of nature*; and in all our investigations of, or inquiries into, the history of this earth, other considerations are bound to give way to this. The objections which I have heard alleged against the name 'Dyas,' while some of them scarcely deserve notice, apply with equal force to the name 'Trias.' The two words are of similar origin, and they are both connotative, as distinguished from geographical, terms. In his 'Introduction' Geinitz points out that, as Murchison had proposed the term "Permian" (which he admits might be a good *local*

name), so Hausmann in 1850 had proposed "Thüringer Formation" as a local name, and Marcou had with equal justice proposed the name "Terrain Saxonien" to include the Saxonia both of Germany and England. He goes on to say that "the well-chosen name *Dyas* ( $\Delta\acute{\iota}\alpha\varsigma$ , duality) removes all further ground for the scruple or discussion which attaches itself to every local name. We apply the name *Dyas*, however, not quite in the same sense as M. Marcou, who regards it as belonging to the Mesozoic series, but rather, with Murchison, regarding it as belonging much more to Palæozoic time." It was in 1859 that the name was first proposed by Marcou, then a Professor at Geneva.

A few more words may fairly be said here (since English geologists will not read German if they can help it), so as to give this obnoxious little name "*Dyas*" a fair hearing, now that it has been brought into court, before it is finally banished beyond sea.<sup>1</sup>

Geinitz defines the '*Dyas*' as including all the strata between the Carboniferous and the Trias, which both by intimate geological and palæontological character belong to the older formations, and mark the close of the Palæozoic time on our earth. (For a summary of Credner's masterly sketch of the evidence of this, I may refer to my former paper in this MAGAZINE, in 1882.) The name '*Dyas*' points to the close relationship existing between the two formations included under this head. This close relationship is true in a two-fold sense. We have not merely in the *Zechstein* a "marine formation with interstratified layers of gypsum, anhydrite, rock-salt, and saliferous clays," and in the *Rothliegende* an "essentially freshwater and land formation with eruptive rocks included among its strata;" but the latter is, in part at least, *parallel* with the *Zechstein*, as Gutbier first pointed out in 1849. Only those who have gone over the ground and seen this parallelism in the field, and the relation, in section after section, which there is between the granitoid conglomerate of the Ober-Rothliegende and the brecciated and conglomeratic sandstones and marls of the Unter-Rothliegende (the former being seen overlying the latter in repeated sections around the Thüringerwald), will feel the full force of the evidence of close relationship between the two great members of the German *Dyas*, which is drawn from this parallelism. The most important fact, perhaps, about the Ober-Rothliegende is the derivation of its materials entirely from the rocks near by, as shown both by the materials of which it is composed, and the subangular form of its contained fragments; and this remark is as true of this sub-formation in the syenitic country about Dresden as it is around the skirts of the Thüringerwald. In neither of these regions is it overlain by any but the upper stage of the *Zechstein*. These few remarks (which might be very much extended, if space permitted) prepare us for the following tabulation of the *Dyas* strata, as given by Geinitz in his 'Introduction.'

<sup>1</sup> It is worthy of remark that Professor Geikie has recognized the value and fitness of the term in his new text-book.



DYAS.

A. Zechstein Formation.

- a) *Oberer Zechstein* (Upper Magnesian Limestone).
- 1). *Plattendolomit* Dolomitscher Kalkschiefer, Stinkkalk, Stinkstein. (Upper Yellow Limestone, Conglobated Limestone of North of England, red and variegated, dolomite-bearing marls and shales in North-West of England.)
- b). *Mittler Zechstein* (Middle Magnesian Limestone).
- 2). *Rauchwacke or Dolomit.* Rauchkalk, Höhlenkalk, Riff-Zechstein, partly breccia and ash, interpolated with gypsum, anhydrite, saliferous clay, rock-salt beds or ironstone. (Concretionary- and Shell-Limestone, or Crystalline- and Fossiliferous-Limestone in England.)
- c). *Unterer Zechstein* (Lower Magnesian Limestone).
- 3). *Zechstein*, passing downwards into the Dachflötz and bituminous Mergelschiefer (Compact limestone in England.)
- 4). *Kupferschiefer* Bituminous mergelschiefer (*Marl-slates* in England).
- 5). *Weissliegendes* (Grauliegendes) *Ullmannia*-Sandstein (Ludwig) with interstratified cupriferous shales in Hesse, Mutterflötz or Sanderz in Thüringen, and an older dolomite near Gera. (Not known in England.)

B. *Rothliegendes.*  
(partly littoral and eruptive, parallel formation of the marine Zechstein.)

B. a. *Ober Rothliegendes.*  
in the neighbourhood of Dresden still overlaid by the "Porphyry" of Hämichen, and in Saxony generally by the Plattendolomit.

B. b. *Unteres Rothliegendes* (*Walchia*-sandstein of Ludwig)

with red and variegated shales and sandstones, feeble layers of limestone and coal, combustible shales, etc., with various eruptive rocks interpolated, especially felsite-porphry and pitchstone, melaphyre or basaltite with its green and brown mandelstein, commencing at the base with the region of the *grey conglomerates*. [In a recent letter the Dresden Professor has pointed out to me that in the contemporaneous igneous rocks of the Lower Rothliegendes we must recognize "three stages, an anteporphyritic, a porphyritic, and a post-porphyritic stage.]

*Nomenclature* (after Geinitz):

*Zechstein*: from 'Zeche' (Zunft) a company or corporation, name given from the numerous huts or houses (*Zechenhäuser* or company's houses) erected upon this formation in connection with the works for obtaining copper-ore from the *Kupferschiefer* and *Weissliegendes*. The word 'Zeche' also means a mine, and so that *Zechstein* may = mine-rock (Geinitz points out that the same is equally applicable to the formation in Durham and Northumberland, since the coal-pits are sunk first through the Magnesian Limestone in that locality).

*Rothliegende* (or *Tothliegende*) named from the prevalent red colour and from the general absence of metallic ores in the strata: 2000 feet thick in Saxony and in Thuringia; freshwater and partly volcanic in origin; has more local character than the marine deposits of the Dyas.

= Lower New Red Sandstone (*grès rouge*).

Omalus D'Halloy (1808) included Dyas and Trias under name of "*Formation du grès rouge*"; later *terrain péneen*."

One more word in conclusion, and that to enter a gentle protest against the importation of personal sentiment into the discussion of this question, as has been sometimes done during the past two years. The true scientific spirit must seek for truth before all things, even if in the pursuit of it a harsh brush is given occasionally to our personal feelings. No one can look at the vast amount of work which the illustrious Murchison left behind him without a feeling of admiration; in fact his enormous and indomitable energy had its weak side, as it did not allow him perhaps always to wait

with sufficient patience for the truth of his generalizations to be tested. Although, however, we must be prepared to find that he made some mistakes, as all enthusiastic pioneers have done in every department of thought, we may still, as Englishmen, feel proud of him, and share the admiration which I have heard Geinitz and others express for him abroad. Personally, I may say that not one word of what I have written has been dictated by any feeling of irreverence for so great a master, or any wish to tarnish the escutcheon of his fame: on the contrary, I have a grateful sense of the privilege which I enjoy, in that it has fallen to my lot to share the friendship of some who were Murchison's greatest friends.

---



---

R E V I E W S.

---

DR. D. STUR ON THE FOSSIL FERNS OF THE COAL-MEASURES.

I.—ZUR MORPHOLOGIE UND SYSTEMATIK DER CULM- UND CARBON-FARNE. By D. STUR. (Sitzb. der K. Akad. der Wissensch. Band lxxxviii. ; 1 Abth. pp. 214, 1883.)

**T**HIS book, in addition to the observations of previous workers, contains a great deal of original matter on the fructification of Carboniferous fossil ferns, which cannot but be of the greatest interest to all students of fossil botany.

The systematic arrangement of fossil ferns holds at present a very anomalous position. We have in fact to deal with two distinct systems of classification: those whose fruit is known are generally placed in genera founded upon characters derived from the form, arrangement and structure of the sporangia; those only known in the barren condition are classified from such characters as are afforded by the nervation and form of the pinnules, and their mode of attachment to the rachis. It has been shown on more than one occasion, that however similar in general appearance the barren fronds of different species may be to each other, such similarity gives no clue by which we can form any estimate of what their fructification may be. Some species of fossil ferns, which in the barren state are so similar that it is with difficulty they can be distinguished from each other, have been found to be essentially distinct when fruiting examples were discovered. Unfortunately, Dr. Stur has placed many species of which the fruit is still unknown in genera whose most important characters are derived from their fructification, thus combining a natural and artificial system (if we may so call it) of classification,—a classification which must be subject to constant change as our knowledge increases. If the barren fronds are kept in genera by themselves, as is at present most commonly done, it is easy to transfer them to other genera as their fruit becomes known.

By this plan, much less confusion will be caused than by placing species in restricted genera while we are still ignorant as to whether or not they possess the real generic characters. Unless such a method as this be strictly adhered to, it must inevitably lead to confusion and the creation of unnecessary synonyms.

RHACOPTERIS.—In the *Ophioglossaceæ*, Stur places the genus *Rhacopteris*, Schimper. The only member of the genus whose fruit is known is *Rhacopteris paniculifera*, Stur, which was previously described by him in his *Culm Flora*. He associates with this fern fifteen other species, of which, as far as we are aware, the fruit has not been observed.

NOEGGERATHIA, restricted to contain *N. flabellata*, L. and H., *N. foliosa*, O. Feistm. (not Sternb.), and *N. foliosa*, Sternb., is also included in the *Ophioglossaceæ*, a view we are not inclined to accept. If one may judge from the figures of the fruit of *N. foliosa* as given by Dr. Stur and other authors, its structure appears to point much more to the *Cycadaceæ* than to ferns. What Stur regards as fruiting pinnules appear to be bracts from a Cycadaceous male inflorescence. In recent Cycads the anthers are borne upon curiously modified bract-like scales, an arrangement with which the fruit of *N. foliosa* agrees very closely.

He retains associated with this species *N. flabellata*, L. and H., which we are inclined to regard as generically distinct, and for which Schimper created the genus *Psymphyllum*.<sup>1</sup>

MARATTIACEÆ.—Of the Carboniferous ferns whose fruit is known, many point to affinities with the *Marattiaceæ*, some approaching it very closely in the structure of their sporangia. Several of these fructifications are extremely interesting and carry the order back to a very early time in the world's history. The following genera are placed in this group by Dr. Stur.

SPHYROPTERIS, Stur.—The sporangia in this genus are produced at the extremities of the pinnules and extend laterally from the point of their attachment “as a hammer on its handle.”

HAPALOPTERIS, Stur.—It has already been pointed out by Zeiller that this genus does not differ from his *Renaultia*.<sup>2</sup> Stur places here a number of Sphenopteroids, the fruit of many of which is still unknown.

SENFENBERGIA, Corda.—It seems quite impossible to include here *Pecopteris exigua*, Renault,<sup>3</sup> which has exannulate sporangia, whereas the presence of an annulus is an essential character of the genus *Senftenbergia*. This genus, then, cannot be placed in *Marattiaceæ*, but *Pec. exigua* finds a suitable place in that order.

GRAND'EURYA, Stur.—This name has previously been appropriated by Zeiller<sup>4</sup> for a genus formed by him for the reception of *Sphen. coralloides*, Gutbier. The ferns now placed in *Grand'Eurya* by Stur are quite distinct from those for which Zeiller created the genus. In fact, from some cause, Stur seems to have been unaware that the name was previously appropriated, and now proposes it as new. Apparently Dr. Stur has founded his genus upon mistaken views of the structure of Renault's specimen, which we think might

<sup>1</sup> *Traité d. Paléont. végét.*, vol. ii. p. 192.

<sup>2</sup> *Ann. d. Scienc. Nat. Bot.*, vol. xvii. p. 4, 1884. *Fructifications de Fougères du terrain houiller.*

<sup>3</sup> *Cours d. botan. foss. Troisième Année*, p. 115, pl. xix. f. 13–18. 1883.

<sup>4</sup> Zeiller, *Ann. d. Scienc. Nat.*, 6<sup>e</sup> Sér. Bot., vol. xvi. p. 203, pl. xii.

be placed in *Scolecopteris*, Zenker. The sporangium of *Grand'Eurya*, Zeiller (not Stur), has a very prominent and curiously formed annulus, but in the ferns placed by Stur in his *Grand'Eurya*, the sporangia are exannulate.

OLIGOCARPIA, Göppert.—This genus is included in the *Marattiaceæ* by Dr. Stur, but the presence of an annulus on the sporangia of *Oligocarpia* excludes it from this order. The annulus is clearly shown on the enlarged drawings of the groups of sporangia given by him (figs. 14 and 15, p. 55). The single sporangium on fig. 15 exhibits the point by which it has been attached, turned uppermost. Dr. Stur has evidently mistaken the base for the apex of the sporangium. Zeiller thinks that the affinities of the *Oligocarpia* are with *Gleichinia*.

DISCOPTERIS, Stur.—It is probable that in this genus, as constituted by Stur, there are included two distinct types of fructification. *Discopteris Schumanni*, Stur, seems identical with the genus *Myriotheca*, Zeiller.<sup>1</sup>

The other fern, *Discopteris Karwinensis*, Stur, might be regarded as the type of his *Discopteris*, which would thus require to be emended. It is impossible, from the meagre evidence before us, to indicate the affinities of this genus.

SACCOPTERIS, Stur.—An example of the errors which are sure to arise from including barren species in genera founded on characters derived from the fruit is well illustrated here, for Stur includes in his *Saccopteris*, *Sphen. coralloides*, Gutbier, whose fruit has previously been described by Zeiller, but the paper in which the description occurs seems to have been unknown to Stur.<sup>2</sup>

In *Grand'Eurya coralloides*, Gutbier sp., the annulus is very prominent, and placed in five or six vertical lines, whereas in *Saccopteris* it is apical and very rudimentary. These differences preclude these two ferns from being placed in the same genus. The presence of an annulus (though rudimentary in *Saccopteris Essinghi*, Andr. sp.) also excludes it from the *Marattiaceæ*.

SCOLEOPTERIS, Zenker.—Included here are a great many *Pecopteroids*, but there is scarcely enough evidence amassed for bringing together the various species Stur places in this genus. The fruit of *Pecopteris* (*Scolecopteris*) *polymorpha*, Brongt., placed alongside of *Pecopteris* (*Scolecopteris*) *arborescens*, Schloth. sp., scarcely seems admissible. More intimate knowledge of the fruit of the genus *Pecopteris*, Brongt., must be obtained before any arrangement of this group can be formed on a satisfactory basis.

RENAULTIA, Stur.—The plants placed in this genus are quite distinct from those for which Zeiller proposed the name, so much so, that one can only again conclude that Stur was ignorant of Zeiller's genus *Renaultia*.<sup>3</sup> The ferns included in it by Stur have an apical annulus, whereas Zeiller's plants have exannulate sporangia. The presence of an annulus in *Pecop. intermedia*, Renault, the type of Stur's genus, excludes it from the *Marattiaceæ*.

<sup>1</sup> *loc. cit.* p. 186, pl. ix. f. 18-20.

<sup>2</sup> *loc. cit.* p. 203.

<sup>3</sup> *loc. cit.* p. 185, pl. ix. f. 16-17.

DANEITES, Göppert.—There is additional information given on this genus, which approaches closely in some points to the genus *Danæa*.

In "POLYPODIACEÆ???", evidently with considerable doubt, Stur includes the following genera:—*Thyrsopteris*, Kze.; (*Palæothyrsopteris*); *Calymmotheca*; *Sorothea*; and *Diplothemema*.

THYRSOPTERIS, Kze.—It would be much better to adopt the name *Palæothyrsopteris* for this genus, as Stur has proposed, in the event of the fossil proving to be different from *Thyrsopteris*. Their identity has not yet been determined, so the use of the genus *Thyrsopteris* for his fern (*T. schistorum*, Stur) appears scarcely admissible.

CALYMMOTHECA, Stur.—We are inclined to think that Dr. Stur has included in this genus, two distinct forms of fructification. Those originally described in the Culm Flora as *Calymmotheca* form one type, the other type is represented by *Caly. Avoildensis*, Stur, and *Caly. Frenzli*, Stur, which are described in the present work.

In the fructifications originally placed in *Calymmotheca*, we have a number of exannulate sporangia springing from a common point of attachment. This we believe to be the true explanation of the structure of this fruit, and was first pointed out by Renault,<sup>1</sup> but more fully elucidated by Zeiller.<sup>2</sup> Dr. Stur, however, still regards these sporangia as so many ribbon-like shreds of a split involucre or capsule, a view we regard as quite untenable, both from the evidence adduced by previous writers and the examination of beautifully preserved specimens which have come under our notice.

In *Caly. Avoildensis* and *Caly. Frenzli*, we have, however, a very different structure. Here we evidently have an involucre and in some specimens of another species, with the same type of fructification, we have been able to trace the involucre through all their stages of development,—they are at first globular, but at maturity split into four valves for the dissemination of the spores. There is a further difference between these two types of fruit. In *Calymmotheca* (as originally employed by Stur) the fruiting portions of the fronds are entirely deprived of foliage pinnules, whereas in the other type (*Caly. Avoildensis* and *Caly. Frenzli*) a very slight modification takes place in the fruiting fronds, which are not deprived of the ordinary foliage pinnules. These two forms are apparently generically distinct. The *Calymmotheca* proper probably belong to the *Marattiaceæ*, while the other type is perhaps related to the *Hymenophyllaceæ*.

SOROTHECA, Stur.—This genus is evidently similar to *Crossotheca*, Zeiller.<sup>3</sup> The specimens studied by Zeiller appear to have been more complete and in a better state of preservation than those examined by Stur. As the sporangia are exannulate, it is impossible to place this genus in the *Polypodiaceæ*.

DIPLOTHEMEMA, Stur.—This genus as at present constituted does not appear of much practical use, as it contains many species which have evidently little affinity with each other. Some time ago, Zeiller proposed for *Sphen. latifolia*, Brongt.; *Sphen. acuta*, Brongt.; *Pec.*

<sup>1</sup> *l. c.* p. 182, pl. ix. fig. 10, 11.

<sup>2</sup> *Cours d. botan. foss. Troisième Année.* p. 198, 1883.

<sup>3</sup> *l. c.* p. 180, pl. ix. figs. 1-11.

*nervosa*, Brongt.; and *Pec. muricata*, Schloth. sp., the genus *Mariopteris*,<sup>1</sup> which though founded on characters observed on barren fronds, brought together certain species apparently closely related and which stand between *Pecopteris* and *Sphenopteris*. Brongniart himself proposed in MS. the genus *Heteropteris* for this group, but his name has since been appropriated.

One of the chief characters of *Mariopteris* is taken from the bifurcation of the rachis of the primary pinnæ, each fork of which bifurcates a second time, these last bifurcations supporting the foliage-bearing tertiary pinnæ. Stur, on the other hand, regards the frond as once bifurcating or sometimes forming a double bifurcation, as has been figured by Zeiller.<sup>2</sup>

The main point of difference between these two authors lies in Stur regarding as a frond what Zeiller regards as a pinna; consequently, what is looked upon as a rhizome or stem by Stur, is regarded as the main axis of the frond by Zeiller.

From our own experience of this group of ferns, Stur's view of their structure seems to go against the evidence he has adduced in its support. Zeiller, in proof of his views, gives a very good figure of *Mertensia glaucescens*, Willd.,<sup>3</sup> where are shown, springing from the main rachis, similarly formed pinnæ to those which occur in *Mariopteris*. We believe Zeiller's interpretation of the structure of the ferns in question to be correct and his genus *Mariopteris* of real practical value, whereas, Stur's *Diplothemema*, as again employed by him, is little more than another name for *Sphenopteris*, Brongt.

He only describes one specimen in fruit, *Diplothemema* cf. *Zwickauense*, Gutbier sp., which scarcely affords enough evidence from which to form any opinion of the affinities of the fern. He also figures a bifurcating "fertiles Phylloin" of *Diplothemema subgeniculatum*, Stur; hence there are in his *Diplothemema* two modes of increase.

Although there are some points, in which we cannot agree with Dr. Stur, his communication deserves the careful study of all those interested in Fossil Botany, as it contains an amount of valuable information regarding the fructification of Carboniferous Fossil Ferns now for the first time brought together in book form. The value of his paper is much enhanced by the addition of forty-four beautifully executed woodcuts.

---

## REPORTS AND PROCEEDINGS.

---

### GEOLOGICAL SOCIETY OF LONDON.

I.—MAY 14th, 1884 (*continued*).

Prof. T. G. Bonney, D.Sc., F.R.S., President, in the Chair.

2. "Note on a Specimen of Iron Amianthus." By the Rev. J. Magens Mello, M.A., F.G.S.

The accompanying specimen was found at the bottom of one of

<sup>1</sup> Bul. Soc. géol. de France, 3<sup>e</sup> sér. vol. vii. p. 93.

<sup>2</sup> Bul. Soc. géol. de France, *loc. cit.* pl. v.-vi.

<sup>3</sup> Ann. des Scienc. Nat. 6<sup>e</sup> série. Bot., vol. xvi. pl. xi. f. 1.

the Wingeworth iron-furnaces, near Chesterfield, and was given to me by Mr. Arthur Carrington, one of the owners.

The furnaces have been lately blown out for repairs, and in the mass of slaggy refuse at the bottom a thin layer of the curious product known as Iron Amianthus was interposed between the sand and the iron refuse.

The red sand at the bottom of the furnace was converted in its upper part into a compact hard white sandstone, an inch or two in thickness, and upon the top of this the Iron Amianthus occurred in snow-white fibrous masses, the fibres radiating in a concentric manner, and forming more or less botryoidal concretions, somewhat resembling hæmatite in appearance, and separated by extremely thin plates or septa of iron, by which the entire mass is divided into irregular prisms of about half an inch in diameter.

A similar product is described by Percy as occurring in the blast-furnaces of the Harz, and is said to consist almost entirely of fibrous silica, with a few specks of iron and graphite, and minute cubes of nitro-cyanide of titanium. Both graphite and titanium occur in the Wingeworth refuse; the graphite is found in thin plates, the nitro-cyanide of titanium in masses of crystals.

Percy states that the origin of the Iron Amianthus is found in the oxidation of the silicon, which is separated in greater or less degree under the same conditions as graphite, and is oxidized at a high temperature.

II.—May 28, 1884.—Prof. T. G. Bonney, D.Sc., F.R.S., President, in the Chair.—The following communications were read:—

1. "The Archæan and Lower Palæozoic Rocks of Anglesey." By Dr. C. Callaway, F.G.S. With an Appendix on some Rock-specimens, by Prof. T. G. Bonney, D.Sc., F.R.S., President G.S.

The object of the author was to furnish additional proof of the Archæan age of the altered rocks of the island. He held that the Pebidian mass on the north was fringed by Palæozoic conglomerates, containing, amongst other materials, large rounded masses of limestone, derived from the calcareous series on the north coast, these conglomerates being probably a repetition by reflexed folding of those which lie at the base of the Palæozoic series. In like manner conglomerates which margined the western (Holyhead) schistose area contained angular pieces of altered slate undistinguishable from some of the Pebidian rocks of the north-west. These conglomerates, dipped to the east, forming the western side of a syncline. Near Llanfihangel were sections which showed not only the Archæan age of the gneissic and slaty (Pebidian) groups, but also the higher antiquity of the former. These conclusions were derived from the occurrence of granitoid pebbles in the slaty series, and from the presence of masses of the slate, as well as gneissic fragments, in the basement Palæozoic conglomerates. The author was at present unable to accept the Cambrian age of the lower Palæozoic rocks, and considered that the fossils he exhibited tended to confirm the views of the Survey on the correlation of those strata. The paper concluded with a sketch of the physical geography as it probably

existed in Ordovician times. An appendix furnished by Prof. Bonney tended, by microscopic evidence, to confirm the proof furnished by the paper.

2. "On the new Railway-cutting at Guildford." By Lt.-Col. H. H. Godwin-Austen, F.R.S., F.G.S., and W. Whitaker, Esq., B.A.

In this paper the authors described a section exposed in a new railway-cutting just north of Guildford station. The beds exposed are chalk and Eocene strata at the base, with overlying Pleistocene or drift-beds. The Eocene beds appear at each end of the cutting, the London Clay resting upon Woolwich and Reading beds as described in 1850 by Prof. Prestwich; and the interest of the section is due in part to this exposure of the Woolwich and Reading beds, which are rarely seen in this neighbourhood, and in part to the thick mass of Pleistocene clays and gravels overlying the Lower Tertiary deposits. The latter appear to be only the remnants of more extensive deposits in the gorge of the Wey, which were spread over the area to the north before the river had cut down to its present level. Some of them are in part of fluvial origin and composed of materials derived first from the Lower Greensand and afterwards from the Chalk, ironstone predominating in the former and flints in the latter. Resting unconformably upon these are deposits consisting of irregularly bedded coarse loamy sands, beds of large flints, with an admixture of fragments of chalk, and with nests or large lumps of red clay. These are regarded as glacial beds, and in the sands beyond the bridge at the London Road remains of Mammalia (*Elephas*, etc.) were found; these sands are exposed as far as Watford farm, where they terminate abruptly against a steep bank of Woolwich and Reading beds. On digging through them at this point the dark gravels with greensand ironstone were met with.

The authors pointed out that the most interesting questions connected with these high-level gravels and sands of the ancient Wey are as follows:—1. What was their relation to the topography of the country in the past? 2. What relation do they bear to the outlines of the country at the present day? 3. What is their age?

They showed that when the gravels and sands were deposited, the main drainage of the country was the same as it now is, though the river was 60 feet above its present level. The sands with mammalian bones were probably an accumulation in a re-entering bend of the river, similar to one now existing a little further north. The river appears at first to have been more rapid, when the lower ironstone gravels were deposited, then slower, when the sands accumulated. Some change of levels ensued, and a considerable portion of the deposits was removed before the upper strata of loam and flints were formed. It is probable that the gorge of the Wey was no longer an outlet to the north whilst these beds were being deposited. In general the loam and flint beds are horizontal, whilst in some localities they are displaced in a manner remarkably like what is seen in the glacial deposits of Alpine valleys. They contain land-shells in places. The land surface indicated by the lower gravels and sands at Guildford is of older date than that described Mr. R. A.



C. Godwin-Austen in the country to the southward, and especially in the valley of the Tillingbourne.

The deposits near Guildford belonging to the two epochs were noticed in some detail. Both are pre-glacial and have been formed when the climate was temperate. The overlying glacial deposits formed of chalk-detritus, flints and loam are attributed to the action of land-ice, and the probable effects of a low temperature are described and illustrated by those observed on the plateaux around Chang Cheumo in Tibet.

3. "On the Fructification of *Zeilleria* (*Sphenopteris*) *delicatula*, Sternb., sp., with remarks on *Ursatopteris* (*Sphenopteris*) *tenella*, Brongn., sp., and *Hymenophyllites* (*Sphenopteris*) *quadridactylites*, Gutb., sp." By R. Kidston, Esq., F.G.S.

In this paper the author noticed the fructification of those species of Ferns which have been described as belonging to the genus *Sphenopteris*, for two of which he proposed the establishment of new genera. *Sphenopteris delicatula*, Sternb., referred by Stur to *Calymmatotheca*, is made the type of one of these genera, *Zeilleria*, in which the involucre is borne at the extremity of the pinnule-segments, which are more or less produced to form a pedicel; in their earlier condition the involucre is globular, but when mature they split into four valves. In *Calymmatotheca* the fructification consists of a number of elongated sporangia arranged in a circle around a common point of attachment; in that genus also the fructifying portions are destitute of foliage-pinnules, while in *Zeilleria* there is little difference between the fertile and barren fronds. In the new genus *Ursatopteris*, established upon *Sphenopteris tenella*, Brongn., the barren and fructifying fronds are dissimilar, and the pinnæ of the latter bear two rows of alternate urceolate sporangia, which open at the apex by a small circular pore. Gutbier's *Sphenopteris quadridactylites* was shown to belong to the genus *Hymenophyllites*. The three species were described and their synonymy was indicated and discussed at some length.

4. "On the Recent Encroachment of the Sea at Westward Ho!, North Devon." By Herbert Green Spearing, Esq. Communicated by Prof. Prestwich, M.A., F.R.S., V.P.G.S.

The author stated that for the last nine years the sea has encroached near Westward Ho! at the rate of about 80 feet annually. The encroachment affects only about a mile of the coast-line, but the sea has gradually worn away part of the Northern Burrows—a sandy common forming the southern portion of the united delta of the Taw and the Torridge,—and partially removed a broad ridge of pebbles which formerly defended the coast line, the pebbles of which, derived from a raised beach, travel in a northerly direction towards the mouth of the river. The sea tends to cut a way through the lower part of the Burrows, isolating part of the pebble ridge and forming a new mouth to the river. The inroads of the sea have laid bare a submerged forest, composed chiefly of oak, birch, and hazel, and containing bones of ox, sheep, deer, dog, pig, and goat, with flint cores and chips, and shells of oysters, limpets, periwinkles, etc.

The woody layer, 18 or 20 inches thick, can be traced for 400 yards to extreme low-water mark; it rests on blue clay, which is four feet thick under the pebble-ridge, but thins to seaward. It contains estuarine shells. Below it is a layer of rounded pebbles. Near the mouth of the river patches of shelly sandstone rest on the clay, resembling that seen near Croyde, on the north side of the bay.

In 1874 a pebble beach sloped to the sea from the frontage of the building land at Westward Ho! The pebbles have now disappeared, and a cliff of clay, 15 feet high, occupies the spot. Near the Ladies' Baths this clay rests on rock of Carboniferous age, but nearer the Burrows, to the northward, a layer of sand intervenes, and, being easily washed away, facilitates the removal of the clay. To the north and east the clay thickens and is mixed with pebbles, many of which are broken. This may be due to glacial action, but no scattered stones have been observed. So long ago as 1600—1630 records of encroachments exist. A book published between 1600 and 1630 mentions the fact of a cairn having been washed away, but gives no precise indication of its situation.

5. "On Further Discoveries of Footprints of Vertebrate Animals in the Lower New Red of Penrith." By George Varty Smith, Esq., F.G.S.

Impressions of footprints were noticed by Prof. Harkness and Mr. Binney on the flaggy beds of the New Red Sandstone of Penrith, but they were of a somewhat indistinct character and compared unfavourably with those previously found at Brownrigg, in Plumpton. The author therefore gave a description of some which have been recently found in a quarry situate to the north of the Alston road, about three miles and a half east of Penrith. The rock consists of strongly false-bedded sandstone underlying the Magnesian Limestone.

Eleven footprints were found in the above quarry. Six of the impressions were discovered *in situ*; three of them (all different) were found on one stone near the top of the quarry; another was taken from a bed seven feet below that from which the three impressions were taken, and the last two were taken from a bed one foot and a half lower. The remainder were either found by the workmen while quarrying, and set aside, or else discovered by the author and his brother on the newly quarried stones.

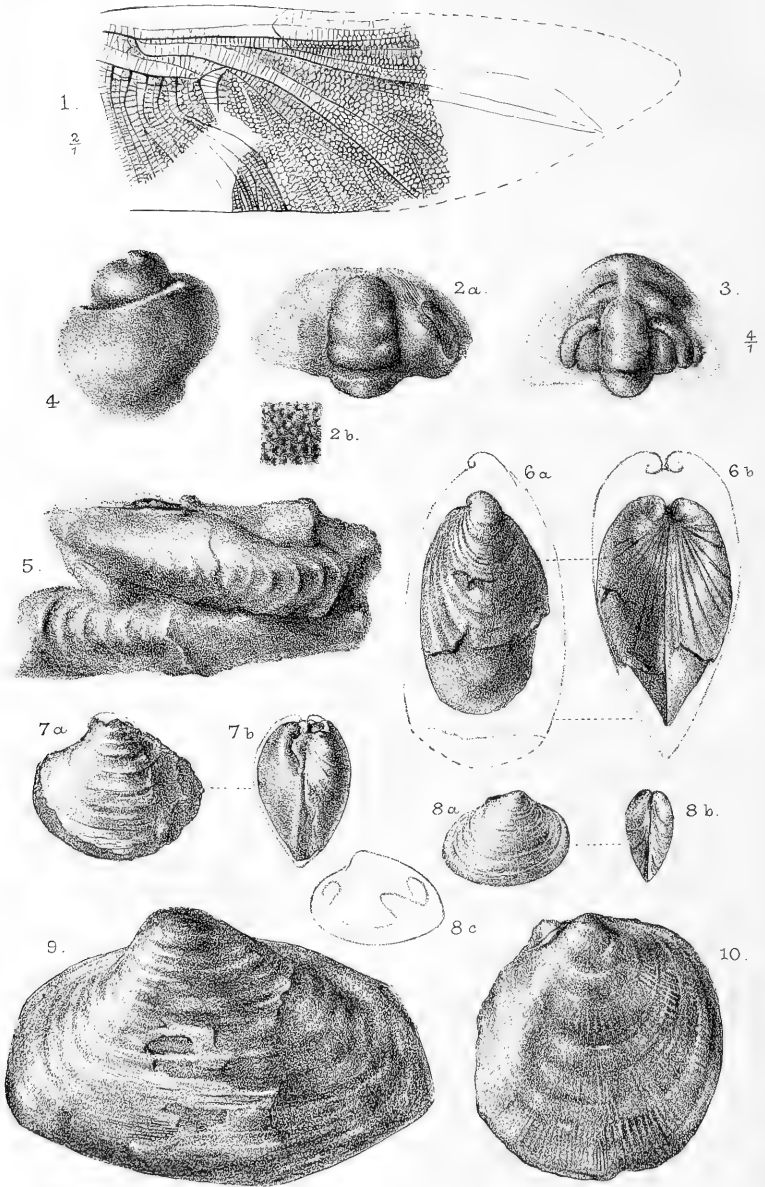
The surface of the two last-mentioned beds was in several places covered with footmarks, which in nearly every case took the same direction, namely, from west to east.

It has been suggested, from the difference in size and depth of some of the impressions, as compared with the length of pace and form of others, that they represent the impressions of several different species, if not of different genera of extinct Vertebrates.

The author also found in a quarry of the Penrith sandstone in Whinfell Wood, about three miles to the south-east of Penrith, a cast of some footprints less distinct than those previously found, and in an adjoining quarry a stone with several impressions of an entirely different character.

---





E. C. Woodward del et lith.

West, Newman & Co imp.

## GEOLOGICAL MAGAZINE.

NEW SERIES. DECADE III. VOL. I.

No. VIII.—AUGUST, 1884.

## ORIGINAL ARTICLES.

## I.—ON THE WING OF A NEUROPTEROUS INSECT FROM THE CRETACEOUS LIMESTONE OF FLINDERS RIVER, NORTH QUEENSLAND, AUSTRALIA.

By HENRY WOODWARD, LL.D., F.R.S., etc.

(PLATE XI. FIG. 1.)

I AM indebted to R. L. Jack, Esq., F.G.S., the Government Geologist of North Queensland, for permission to examine the remains of a Neuropterous wing (figured on Plate XI. Fig. 1), and which forms one of a collection of Cretaceous fossils transmitted by him to my colleague Mr. Robert Etheridge, jun., for description.

The specimen is imbedded in a dark chocolate-coloured limestone of Cretaceous age, associated with a small bivalve, *Aucella Hughendensis*, Eth., sp., from seven miles above Marathon Station on the Flinders River. This is, I believe, the first instance recorded of the occurrence of a Neuropterous Insect in a fossil state in Australia,<sup>1</sup> and, as will be seen in the sequel, it presents a problem of extreme interest for our consideration. The portion of a wing preserved is 25 millimètres in length, and nearly 15 mm. in depth; when perfect, it may have been 45 mm. in length.

It was evidently the proximal half of the *posterior* wing of a Libelluloid insect, and exhibits the "costal nerveure" forming the anterior border of the wing, followed in parallel order by the "sub-costal," the "median," the "sub-median," and "post-costal" nerveures: the three first-named nerveures pass along the anterior border until they reach the "node" or "cubital point"; after passing which, only the two anterior ones are continuous to the extremity of the wing, and support the "pterostigma." (This distal portion of the wing is unfortunately wanting.) The transverse "ante-cubital" nerveures can also be noticed which bind together the three most anterior costal nerveures.

Between the median and sub-median nerveures is placed a short transverse one, called the "arc": from it is given off a pair of main nerveures, the "sectors," which run in a nearly parallel course, curving downwards, to terminate in the posterior border of the wing, near the broken distal extremity.

The sub-median and post-costal nerveures are short, and end in a transverse vein, which, with another, inclose a somewhat transversely elongated interior space, known as the "triangle." From this triangle another pair of main nerveures ("sectors") are given off, which, like

<sup>1</sup> Several small Coleoptera were figured by the late Mr. Chas. Moore, F.G.S., in the Q.J.G.S. 1870, vol. xxvi. pl. xviii pp. 261-263, from Sydney Flat, N. S. Wales.

the preceding pair, terminate in the posterior border. Between these and the anal angle of the wing about five others pass from the post-costal nervure to the posterior border of the wing. The greater part of the wing between the nervures is composed of delicate hexagonal meshes, but near the triangle and between the main (sector) nervures the intermediate cellules form elongated meshes (discoïdal areolæ or "cellules pastrigonales,"—Hagen).

The very imperfect state of our specimen precludes our correlating it, with confidence, to any living genus; but sufficient is preserved to demonstrate that it is the posterior wing of a Neuropterous insect of the sub-order *Odonata*, Fabr., and perhaps referable to the sub-family *Gomphinae*,<sup>1</sup> one genus of which, *Austrogomphus*, de Selys, having five species, is characteristic of Australia and Tasmania.

Whilst engaged in making comparisons of this Australian fossil, I passed in review various specimens in our collection, both recent and fossil, when amongst the latter I had the good fortune to light upon one species represented by several specimens from the Purbeck Fresh-water Limestone of Durdlestone Bay, near Swanage, Dorset. One of these wings is figured by Prof. J. O. Westwood (see Quart. Journ. Geol. Soc., 1854, vol. x. pp. 378–396, plates xiv.–xviii.), who writes as follows (*op. cit.* p. 387):—

"Of naked-winged insects, there is a considerable collection of interesting fragments, amongst which those belonging to the *Libellulidæ* are pre-eminent, as usual, for their size.

"Plate xv. fig. 4 represents a portion (near the extremity) of one of the wings of a *Libellula* of very large size.

"Fig. 5 is one of the wings of a Dragon-fly, with very small meshes, and with the characteristic triangle occupying a higher position than in the typical *Libellula*."

The specimens above referred to were obtained by C. Willcox, Esq., and the Rev. P. B. Brodie, M.A., F.G.S., from the Lower Purbecks, Durdlestone Bay, Dorset.

After a careful examination of the specimens referred to above, and of others from the same locality and horizon, I have no hesitation in affirming that the two wings (the one from the Purbeck beds of Dorset, and the other from the Cretaceous of North Queensland) are so nearly identical in every detail, that, if not specifically the same, they quite certainly belong to the same genus.

The interest in this correlation is greatly increased when we recall the fact that it was from this same freshwater limestone of Durdlestone Bay, Dorset, that Professor Owen described<sup>2</sup> no fewer than eleven genera and twenty-five species of small Marsupial Mammals of polyprotodont and diprotodont types, the former resembling the *Peramelidæ*, *Dasyuridæ*, and *Didelphidæ*, being either of carnivorous or insectivorous habits; the latter resembling the *Phascotomydæ*, *Macropodidæ*, and *Phalangistidæ*, being almost purely vegetable feeders. This striking assemblage of Upper Jurassic Mammalia and

<sup>1</sup> See Monographie des Gomphines, par Edm. de Selys Longchamps et H. A. Hagen, Paris, 1857, 8vo.

<sup>2</sup> See Pal. Soc. Mon. 1871, "Monograph of Fossil Mammalia of the Mesozoic Formation."

Insects near Swanage, Dorset, seems not likely to remain long as an isolated group without a parallel. Prof. Marsh's explorations in the Rocky Mountains have brought to light a similar assemblage of small Jurassic Mammals, which conform in all their characters to those of the English Purbecks, some being even generically identical. I shall await with interest the discovery of Neuropterous insects from these American Jurassic deposits.

It only remains in conclusion to give to our insect-fragment a name; and as the generic name *Æschna* has been already applied to a Liassic form (*Æschna Brodiei*, Buckm.<sup>1</sup>), I will venture to designate Mr. Jack's discovery as *Æschna Flindersiensis*, as recognizing its locality on the Flinders River and one of Australia's earliest explorers and heroes.

II.—NOTES ON SOME MOLLUSCA FROM SOUTH AUSTRALIA, OBTAINED NEAR MOUNT HAMILTON AND THE PEAK STATION.

By WILFRID H. HUDLESTON, M.A., F.R.S., F.G.S.

(PLATE XI.)

THE molluscan fossils figured on Plate XI. were transmitted to the Editor<sup>2</sup> by Mr. Hy. Y. Lyell Brown, F.G.S., Government Geologist for South Australia. They are from two localities in that Colony, one near Mount Hamilton, 20 miles S.W. of Lake Eyre, but the greater part came from 40 S.W. of the Peak.<sup>3</sup> There is nothing in the collection which could be quoted as absolutely decisive of their age, though we may fairly regard them as Mesozoic. The conditions of fossilization remind us of the Jurassic fossils of this country, and the general facies is not dissimilar. But these resemblances should not be taken for more than they are worth, the more so since we fail to trace absolute specific identity.

Mr. R. Etheridge, junior, is of opinion that the fossils are Cretaceous, and this is by far the most probable conjecture, seeing that fossiliferous beds, known to be of Cretaceous age, are somewhat extensively developed on the Australian continent.

See Mr. Daintree's paper on the Geology of Queensland, Quart. Journ. Geol. Soc. 1872, vol. xxviii. pp. 271-359, and plates ix.-xxvii. See also Mr. Hy. Y. Lyell Brown's Reports.

NATICA, species. Pl. XI. Fig. 4.

Internal cast, in highly calcareous stone, of an umbilicated Naticoid shell. The whorls were probably inclined to be tabulate, and the size of the body-whorl would be about  $\frac{3}{8}$ ths of the total height of the shell. A trigonal bivalve not unlike *Sowerbya* is adherent.

It is interesting to observe in connection with this cast that a specimen of *Natica* (with the shell preserved), named *Natica lineata*,

<sup>1</sup> See Brodie's History of Fossil Insects in Secondary Rocks, 1845, pl. 8, fig. 1, and pl. 10, fig. 4; also Buckman's (Murchison's) Geology of Cheltenham (new edition), 1845, tab. 8, figs. 1 and 2.

<sup>2</sup> The Editor is greatly indebted to Mr. Hudleston for undertaking, on his behalf, the difficult task of describing these Australian Molluscan remains.—EDIT. GEOL. MAG.

<sup>3</sup> The explorers, by whom they were collected, did not keep the specimens from these localities distinct, and there is no evidence to enable one to separate the Mount Hamilton specimens from those collected from the Peak district.

is figured and described by Mr. R. Etheridge, F.R.S., from Cretaceous strata, Maryborough, North Queensland (see Quart. Journ. Geol. Soc. 1872, vol. xxviii. pl. xxi. fig. 1, p. 352). It is just possible that our shell may have been obtained from a similar (Cretaceous) horizon in South Australia.

MYACITES? AUSTRALIS, sp. nov. Pl. XI. Fig. 9.

Length .....	57 millimètres.
Width to length .....	0·67
Thickness to length .....	0·42
Proportional length of anterior area .....	0·40

Shell moderately elongate, inequilateral. The anterior area, which is angular and inflated, occupies about  $\frac{2}{3}$ ths of the length of the shell. Posterior area compressed. General shape of the shell sub-arcuate with a moderate gape. Hinge-area nearly straight. Valves fairly tumid in the umbonal region, but becoming attenuated towards all the margins.

Very little of the shell substance remains; it was thin, the granulations not very obvious, the markings, judging from the impressions on the cast, consisted of a rather prominent concentric ridge and furrow, with very fine concentric lines between.

Whether this shell should be referred to *Myacites* or *Panopæa* is not perfectly clear. It has a certain degree of resemblance to some well-known Mesozoic forms occurring in Europe. But in order to guard against a wrong identification, it is safest to bestow upon it a specific name, which may be temporary or permanent according as more and better specimens are obtained.

FIG. 9.—Although not absolutely identical with any of the Lamellibranchiata figured by Mr. R. Etheridge, F.R.S., in Mr. Daintree's paper on the Geology of Queensland, Australia (see Quart. Journ. Geol. Soc. 1872, vol. xxviii. pp. 317-358), it nevertheless has a general resemblance to these shells, and is most probably of Cretaceous age (compare Fig. 9, Pl. XI. with Daintree's pl. xxi. figs. 2, 2a). If our view be correct, this is most likely to have been collected from the Peak district, in which direction Cretaceous beds are believed to extend. Mr. Henry Brown having traced them as far as Lake Frome on the South, and Pandie-Pandie on the North, and as far West as the 139th degree of longitude.

CYTHEREA WOODWARDIANA sp. nov. Pl. XI. Figs. 8a, 8b, 8c.

There are three specimens of a small veneriform species. One of these is in a fair state of preservation, whilst another shows the internal mould, which appears to exhibit the mark of a pallial sinus. If this appearance is correctly interpreted, these fossils should most probably be referred to *Cytherea*.

Length .....	16 millimètres.
Width to length .....	80 : 100
Thickness to length .....	38 : 100

Shell oval, rather compressed, moderately inequilateral, longer than wide; anterior margin rounded, lunule shallow. Posterior area less compressed, margin rounded. Hinge-line curving posteriorly, with a longitudinal excavation for the passage of a short but prominent



ligament. Pallial margin curved. Umbones moderate (outer shell layer removed by erosion at the beak). Surface of shell nearly smooth, with flat concentric borders at rare intervals, crossed by very fine irregular radiating striæ.

Cast.—Anterior muscular impression better marked than posterior. Pallial sinus narrow.

CYPRINA? species. Pl. XI. Figs. 7a, 7b.

Width and length equal; posterior area but slightly larger, very thick towards the umbones, and compressed in the pallial area, the margin of which is much rounded. Hinge-area sloping sharply on both sides. Lunule wide and deep, ligamental excavation wide and short. Shell substance very thick towards the umbones, tapering towards the lower border (partly due to unequal corrosion). Shell probably without ornament beyond concentric bands at intervals.

Cast much corroded, no trace of pallial sinus visible.

MODIOLA LINGULOIDES, sp. nov. Pl. XI. Figs. 6a, 6b.

There are two rather well-preserved specimens of *Modiola*, which appear to belong to the same species, though there is a considerable difference in appearance at first sight, owing to different portions of shell and cast being preserved.

The smaller one, which is in the best condition of the two, measures 30 mm. from the umbones to the lower border. The shell is linguloid in outline, extremely inflated, anterior margin nearly straight, anterior area very full and without any inflection. Umbones subcentral, tumid and strongly curved anteriorly. Cardinal area well developed and projecting slightly beyond the posterior margin, which falls away nearly straight towards the lower border. Shell widely grooved concentrically, the grooves or flutings being cut deepest on the anterior side. Interior shell layer nacreous.

It is not often that fossil *Modiolas* display such well-preserved umbos. On the whole, the condition of the shell scarcely gives one the notion of a very high antiquity.

GERVILLIA ANGUSTA, sp. nov. Pl. XI. Fig. 5.

Two double valves of what appears to be a species of *Gervillia* partly cast, and partly shell, though no certain traces of auricles can be made out. The valves are narrow, and appear to have been disposed in concentric imbrications of considerable breadth. The shell substance has been in great part removed, being now chiefly represented by ferruginous flakes on a fine-grained calciferous grit. The shell was lanceolate, hardly at all curved, with a median ridge extending in the direction of the lower area, which was much compressed.

AVICULA ORBICULARIS, sp. nov. Pl. XI. Fig. 10.

There are two specimens of a species of *Avicula* with both valves in apposition, though more or less slipped out of place. The shell having been thin, they exist partly as casts and partly representing the original shell substance.

Shell orbicular, length and width almost equal, very nearly equi-

valve and equilateral. Posterior region compressed, anterior rather fuller, the shell being thickest a short distance from the umbones. No wing can here be traced, and it is probable that it must have been very short. In one of the valves of the smaller specimen what I take to be the ligamental groove with its nacreous lining may be seen. The surface bears traces of an ornamentation which consisted of numerous fine radiating ribs, which appear to have been pretty nearly equal in prominence. There are also traces of concentric costæ which seem to have been the strongest anteriorly.

There are so many features in these shells that fail to correspond with the general diagnosis of *Avicula*, which is usually inequivalve and very inequilateral, that the determination is open to doubt. The two specimens in question seem to belong to a group of Lima-like *Aviculas*, such as *Avicula echinata* of the Cornbrash, and *A. ovalis* of the Corallian.

### III.—NOTE ON THE REMAINS OF TRILOBITES FROM SOUTH AUSTRALIA.

By HENRY WOODWARD, LL.D., F.R.S., ETC.

(PLATE XI. FIGS. 2 and 3.)

HAVING, some time since, been favoured by Professor Ralph Tate, A.L.S., F.G.S., of the University of Adelaide, South Australia, with two fragments of Trilobites from the Parara Limestone, Yorke's Peninsula, I venture to place the same on record, and to add a few notes on their probable affinities

“The Parara Limestone” (writes Prof. Tate) “is apparently un-conformable to the Chloritic and Micaceous Schists and associated rocks constituting the elevated tracts of this Colony containing our chief metalliferous deposits. The determination of the horizon is therefore of great importance.”

Mr. Henry Y. Lyell Brown, F.G.S., Government Geologist for the Colony, has also kindly sent me some specimens of the same limestone from Yorke's Peninsula, containing what appears to be the remains of a Coral, the calices of which are about 12 millimètres in diameter. The septa are numerous and very short, with a thickened spongy columella; the corallites are irregular, and few in number, and appear to be united by a cellular cœnenchyma. It is difficult to pronounce upon the nature of these specimens, owing to their highly metamorphosed and mineralized condition; it is to be hoped therefore that other and better-preserved specimens may be met with, from which an accurate determination of the fossil may be arrived at; especially as these fossils do not appear to be of very rare occurrence.

In his “Introduction to the Cliffs and Rocks at Ardrossan, Yorke's Peninsula,” by Mr. Otto Tepper (Corr. Memb.), see Trans. and Proc. and Report of the Phil. Soc. of Adelaide, South Australia, for 1878–9, pp. 71–79, the author observes:—“Both varieties of the upper marbles contain distinct fossils and abundantly minute fragments of such, but the upper one by far the most; conspicuous among which occurs a *trilobite*, and *coral*-structure appears to perfection in sea-rolled pebbles, when the fossil shows in beautiful contrast of colour upon the smooth surface. Professor Tate holds the tentative opinion that

the fossils are of Lower Silurian age. The dense, light-coloured marble seems to contain no fossils." The same author mentions in a note on "Silurian Fossils from the Parara Limestone near Ardrossan," see Trans. and Proc. and Report Royal Society of South Australia, 1882, vol. iv. (for 1880-81) p. 145 :—(1) "Species of *Strophomena*, in shape like *S. spiriferoides*, McCoy, but an inch in breadth, with concentric undulating ridges, and without radial striæ. (2) Head of a Trilobite, apparently of the same species as previously found, but of a very much larger size, and showing details not observed in the other examples. The glabella is  $1\frac{1}{4}$ " long, and  $\frac{3}{4}$ " wide, with three pairs of oblique furrows; its surface is ornamented with numerous closely-set granules."

DOLICHOMETOPUS, Angelin. Plate XI. Fig. 3.

In the Palæontologia Scandinavica, by N. P. Angelin, Lipsiæ, 1854, p. 72, the author describes a new genus of Trilobites under the name of *Dolichometopus*, of which only the head appears to have been known.

"Head bordered on either side by an intramarginal furrow, outer margin angular, eyes large, with a semiorbicular orbital lobe; facial suture bent inwards behind the basal margin of the eyes, short and bent outwards in front; continuous near the front margin. Front distinct, subclavate, entire; glabella a little dilated." One species, *D. Suevicus*, tab. xxxvii. fig. 9, 9b. Angelin's specimen was obtained from Andrarum in Sweden, in his "regio B., *Conocorypharum*," = Lower Lingula Flags, Menevian (Hicks).

In Angelin's specimen, as well as in our own, the cheeks are wanting, or imperfect.

The glabella is nearly smooth, with only a slight indication of furrows, tumid, twice as long as it is broad, the neck-lobe wide, fixed cheeks shorter than the glabella, semicircular externally, and divided by a straight furrow from the glabella and neck-lobe; eyes smooth, elevated, long, semicircular, rounded; cheeks encircling the glabella in front, the outer border of head-shield encircled by a deep furrow, which is interrupted in front of the glabella where the raised margin is a little broader and slightly produced, as in *Anomocare* (Angelin).

The head, when perfect, was probably 6 mm. broad and 5 mm. long. The Swedish specimen is much larger, and the anterior border of the head shield is much narrower, the glabella being consequently more prominent in front. The eyes in the Australian specimen are larger in proportion.

I propose to name this little head *Dolichometopus Tatei* (Plate XI. Fig. 3).

CONOCEPHALITES, Zenker, 1833. Barrande, 1852. Plate XI. Figs. 2a, 2b.

This genus is framed to contain a number of Trilobites, possessing a semicircular head-shield, with a very distinct neck-segment; the glabella more or less conical, and divided by two or three short furrows; the axial grooves are deep and broad; eyes placed near the anterior part of the head-shield, near the angles of the glabella, or near the centre of the side-lobes of the head. The facial suture commences on the exterior margin of the head, turns inwards in

a curved line towards the eye, then bends towards the posterior angle, and cuts the margin obliquely.

Mr. Robert Etheridge, jun., in a paper published in the Proceedings of the Royal Society of Tasmania (read 13th June, 1882, p. 152, *et seq.*), discusses the characters of this genus most fully.

I have compared Fig. 2 with numerous species of these primordial forms, all in a more or less fragmentary condition, and whilst admitting that probably *Conocephalites* might with propriety be subdivided into two or more genera, at present sufficiently-well-preserved specimens are wanting to enable one to break it up.

In the specimen from Yorke's Peninsula, the sides of the glabella are tolerably parallel, broadly rounded in front, with two indistinct transverse furrows on each side; the neck furrow is broad and deep; the neck-lobe is rather broad; the fixed cheek remains on the right side; the facial suture is somewhat oblique, commencing in the margin near the anterior angle of the glabella, and bending outwards to the eye, which is placed on the anterior half of the head; oblique striæ can be seen on the cheek in advance of the eye which spread from it to the anterior border of the glabella; the eye was probably long and narrow, but is too much injured to be described; the surface of the glabella and fixed cheek are finely punctate (see Pl. XI. Fig. 2*b*).

Length of glabella including neck-lobe 17mm., breadth 10mm.

There is a general resemblance between this South Australian *Conocephalites* and many of the species figured on plates vii. and viii. of the "Sixteenth Report of the Regents of the University of the State of New York, on the Condition of the State Cabinet of Natural History," Albany Contributions to Palæontology (1863, 8vo. pp. 147-168). Compare our figure with that of the Potsdam Sandstone specimens figured on plate vii. *op. cit.* figs. 10, 24, 30, 31, 36, 37, and plate viii. figs. 5, 8, etc.; but it is quite distinct specifically from any and all of these. It is also distinct from those figured and described by Mr. R. Etheridge, jun., from the Lower Silurian of the Mersey River District, Tasmania.

This specimen, for the sake of convenience, might bear the trivial name of *C. Australis*.

These Trilobites are clearly of Lower Silurian age, being equivalent to the Swedish, Bohemian, Tasmanian, and North American beds with similar fossils.

#### EXPLANATION OF PLATE XI.

- FIG. 1. *Æschna Flindersiensis*, H. Woodw. Cretaceous; Flinders River, North Queensland.  
 ,, 2. *Conocephalites Australis*, H. Woodw. Cambrian, or Lower Silurian, Yorke's Peninsula, South Australia.  
 ,, 3. *Dolichometopus Tatei*, H. Woodw. ditto ditto.  
 ,, 4. *Natica*, sp. (cast). Cretaceous? South Australia.  
 ,, 5. *Gervillia angusta*, Hudl. Two double valves.  
 ,, 6*a, b*. *Modiola linguloides*, Hudl. Left valve and side view of both valves of same specimen.—N.B. The outline of the larger specimen is traced outside.  
 ,, 7*a, b*. *Cyprina*? species. Left valve and side view of same specimen.  
 ,, 8*a, b*. *Cytherea Woodwardiana*, Hudl. Right valve and side view of same.  
 ,, 8*c*. *Ib.* *Ib.* Internal cast showing pallial sinus.  
 ,, 9. *Myacites australis*, Hudl.  
 ,, 10. *Avicula orbicularis*, Hudl.

IV.—PRINCIPAL CHARACTERS OF AMERICAN CRETACEOUS  
PTERODACTYLS.PART I. THE SKULL OF PTERANODON.<sup>1</sup>

By Professor O. C. MARSH, M.A., F.G.S.,  
of Yale College, Newhaven, Conn., U.S.A.

THE first remains of Pterodactyls discovered in this country were found by the writer, in the autumn of 1870, near the Smoky Hill River, in Western Kansas. These belonged to a gigantic species, which was described by the writer in 1871, and is now known as *Pteranodon occidentalis*. The geological horizon of these fossils was in the Middle Cretaceous, in the same deposits that contain the *Odontornithes*, or Birds with teeth. In the following year, additional specimens were secured by the writer in the same region, and referred to two new species of the same genus.<sup>2</sup>

In 1872, the writer again visited this region, and made a careful search for other specimens, and for several subsequent years had parties exploring the same deposits systematically, with good results; so that at the present time the remains of more than six hundred individuals of these reptiles have been secured from this horizon, and are now in the museum of Yale College.

The most of these remains represent gigantic species, the largest having a spread of wings of nearly, or quite, twenty-five feet. These all belong to the genus *Pteranodon*, and pertain to five species. One species referred to this genus was comparatively small, having a spread of wings of not more than three feet. A few specimens were found, intermediate in size, and these represent the genus *Nyctodactylus*, of which only a single species is known.

All these Cretaceous Pterodactyls, so far as known, differ widely from the members of this group in the old world, especially in the *absence of teeth*, and hence have been placed by the writer in a new order, the *Pteranodontia*, from the typical genus, *Pteranodon*.<sup>3</sup> Other important characters of this order have since been made known by the writer, showing that these strange reptiles constitute a well-marked group, much more specialized than any hitherto discovered.

In the present paper, the skull of one species of *Pteranodon* is described and figured as typical of the order, and the remaining part of the skeleton will be discussed in subsequent communications.

THE SKULL.—The skull in the genus *Pteranodon* is very large, and much elongated. The facial portion is greatly produced forwards, and an enormous sagittal crest extends far backward, and somewhat

<sup>1</sup> From the American Journal of Science, vol. xxvii. May, 1884.

<sup>2</sup> *op. cit.* vol. i. p. 472, June, 1871; vol. iii. p. 241, April, 1872, and p. 374, May, 1872.

<sup>3</sup> *op. cit.* p. 507. vol. xi. June, 1876; p. 479, vol. xii. Dec. 1876, and vol. xxi. p. 342, April, 1881. See also vol. xxiii. p. 251, April, 1882.

upward, as shown in Figures 1, 2, and 3. Seen from the side, the jaws project forward like a huge pair of pointed shears. They are very long, sharply pointed in front, and entirely destitute of teeth. In no specimens examined, young or old, have any indications of teeth been detected. The margins of the jaws are smooth and thin, as in many species of recent Birds. The jaws were probably encased in a horny sheath.

The bones of the skull are nearly all of extreme tenuity. With the exception of the occipital condyle, and the lower ends of the quadrates, all seem to have been pneumatic.

Seen from above, the skull appears extremely narrow. A sharp ridge extends from the end of the premaxillaries along the median line to the true cranium, and is continued backward by the thin elevated crest. The large antorbital openings thus seem near the middle of the skull, and, as they are directly over the posterior nares, they form part of the vertical apertures in the cranium, seen in Figs. 2 and 3.

The palate is deeply concave, and covered with bone, as far back as the posterior nares.

The bones of the skull are nearly all firmly ankylosed together, and this makes it very difficult to determine the different elements.

The premaxillaries are very large, and have coalesced with the maxillaries. They appear to extend backward to the large antorbital vacuities. These apertures apparently include both the anterior nares, and the lachrymo-nasal fossæ, which are separate in most recent birds.

The orbit is of moderate size, and oval in outline, the apex being below. There was apparently no ring of bony sclerotic plates, since in the best-preserved specimens no traces of this have been found.

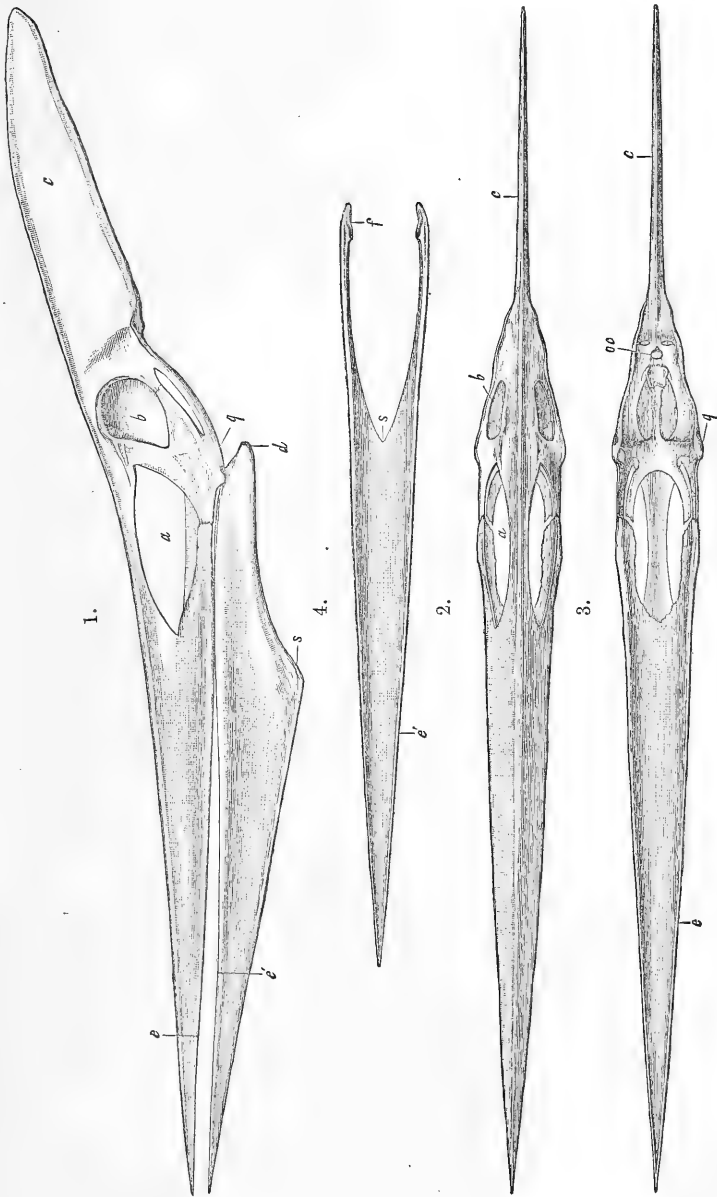
The quadrate is firmly coössified with the other cranial bones, and projects strongly forward. Its distal end is one of the most characteristic parts of the skeleton.

The sagittal crest is of enormous size, and serves to balance the elongated jaws. It is very thin transversely, and during life was probably more or less flexible. In form and direction, it resembles the corresponding crest in the recent genus *Basilicus*.

The occipital condyle is very small, and nearly hemispherical in form. It is directed backward, and but slightly downward, thus differing from this part in most of the members of the group.

**THE LOWER JAWS.**—The lower jaws are very long, and quite sharp in front, corresponding closely in this respect with the end of the upper jaws. The rami are closely united by a symphysis which extends from the apex to beyond the posterior extremity of the dentary bone, as in the mandible of *Rhynchops*, and some other birds. Behind the symphysis, the rami are comparatively slender. The upper face is strongly concave. The articulation for the quadrate is deeply grooved obliquely, and the joint is a very strong one. The front portion of this mandible during life was evidently protected by a horny covering, like that of the beak above.

The nearly complete skull here described may be regarded as a



SKULL OF PTERANODON LONGICEPS, MARSH. One-sixth natural size.

type of the genus *Pteranodon*. Its principal measurements are as follows:—

Length, from extremity of sagittal crest to end of pre-maxillary, about 30 inches, or.....	760 millimètres.
Transverse diameter of occipital condyle.....	8·4
Distance from occipital condyle to distal end of quadrate	105·
Length of lower jaw, about 23 inches, or .....	585·
Greatest depth .....	62·
Depth at articulation for quadrate .....	23·

The skull of *Pteranodon ingens*, described by the writer from the same geological horizon, is about four feet in length.

The skull of *Pteranodon* differs especially from that of the other known *Pterosauria* in the following particulars: (1) the absence of teeth; (2) the absence of anterior nasal apertures distinct from the antorbital openings; (3) the presence of the elongated occipital crest; (4) the whole jaws were apparently covered with a horny sheath, as in recent birds.

YALE COLLEGE, NEW HAVEN, April 24th, 1884.

EXPLANATION OF FIGURES on p. 347.

FIG. 1. Skull and lower jaw of *Pteranodon longiceps*, Marsh; side view.

„ 2. The same skull; top view.

„ 3. The same skull; bottom view.

„ 4. Lower jaw of *Pteranodon longiceps*; top view.

a. Antorbital aperture; b. orbit; c. sagittal crest; d. angle of jaw; e. lower margin of upper jaw; e'. upper margin of lower jaw; f. articulation of lower jaw; oc. occipital condyle; q. quadrate bone; s. symphysis of lower jaw.

All the figures are one-sixth natural size.

V.—ON SOME PALÆOZOIC PHYLLOPODA.

By T. RUPERT JONES, F.R.S., and H. WOODWARD, LL.D., F.R.S.

IN the GEOL. MAG. Dec. II. Vol. X. pp. 462–3, a Synopsis of the Genera of Fossil *Phyllopora* was offered as a basis for the study of these interesting, though often obscure, little fossils, and some of the Bivalved forms, namely, *Hymenocaris*, *Caryocaris*, and *Lingulocaris*, were more especially noticed. See also “Report British Assoc.” for 1882. The univalve forms (excepting *Dithyrocaris*) have since then been carefully studied; and the classification proposed last year is found to hold good, with some slight modification, on comparison of all the species of which specimens or published figures have come to hand. Thus the term “flat-shield” is not strictly correct, for some of these carapaces are subconical or slightly convex; and one at least (*Dipterocaris*) is bent like a low ridge along the back: *Pinnocaris* is possibly really bivalved, without the triangular rostral piece; and probably Barrande’s *Crescentilla* may be placed with *Pterocaris* and *Dipterocaris*.

LIST OF THE SPECIES OF THE FOSSIL UNIVALVE PHYLLOPODA (EXCEPT *Dithyrocaris*).

I. SHIELD NOT SUTURED ALONG THE BACK.

1. *Posterior margin entire and rounded: nuchal suture angular.*

1. DISCINOCARIS, H. Woodward, 1866. Cephalic notch broad.

1. *Browniana*, H. W. ....Shield circular.<sup>1</sup>

2. *dubia* (F. A. Roemer) ..... ” ”

3. *lata* (H. W.) ..... ” ”

<sup>1</sup> In all these cases an outline outside the notch or its triangular plate is taken for the real shape.



4. *triasica* (Reuss.) .....Shield oval.  
 5. sp. nov. .... ,, obovate.  
 6. *congener* (Clarke) ..... ,, oblong.  
 7? *gigas*, H. W. .... ,, ?
2. SPATHOCARIS, Clarke, 1882. Cephalic notch narrow.  
 1. *Emersonii*, Clarke .....Shield oblong.  
 1\* ———? small form..... ,, obovate.  
 2. *ungulina*, Clarke ..... ,, oval.
3. PHOLADOCARIS, H. Woodward, 1882. Cephalic notch broad; shield having radiate furrows and ridges.  
 1. *Leeii*, H. W. ....Shield cuneiform.  
 2. sp. nov. .... ,, obovate.
2. *Posterior margin angular; shield with radiate ridges; nuchal suture rounded.*  
 4. LISGOCARIS, Clarke, 1882.  
 1. *Lutheri*, Clarke .....Shield subpentagonal.
3. *Posterior margin entire; shield not ridged; nuchal suture rounded.*  
 5. ELLIPSOCARIS, H. Woodward, 1882.  
 1. *Dawalquei*, H. W. ....Shield oval.  
 2. sp. nov. .... ,, obovate.
4. *Posterior margin truncate, indented, or slightly notched.*  
 6. CARDIOCARIS, H. Woodward, 1882. Posterior margin truncate or indented; nuchal suture angular.  
 1. *Rœmeri*, H. W. ....Shield narrow obovate.  
 2. *bipartita*, H. W. .... ,, ,, ,,  
 3. *Veneris*, H. W. .... ,, broad ,,  
 4. *Koeneri*, Clarke..... ,, ,, ,,
5. *Posterior margin deeply notched; nuchal suture angular.*  
 7. DIPTEROCARIS, Clarke, 1883. Concentric ornament.  
 1. *pes-cervæ*, Clarke .....Shield obovate.<sup>1</sup>  
 2. *vetusta*, d'Arch. et de Vern. .... ,, ,,  
 3. *proœne*, Clarke ..... ,, subquadrate,  
 4. *pennæ-dædali*, Clarke ..... ,, suboblong.  
 5. *Etheridgei*, nobis ..... ,, oval.
8. PTEROCARIS, Barrande, 1872. Radiate ornament.  
 1. *Bohemica*, Barr.
9. CRESCENTILLA, Barrande, 1872. Smooth.  
 1. *pugnax*, Barr.
- II. SUTURED ALONG THE BACK.
10. APTYCHOPSIS, Barrande, 1872. *Nuchal furrow angular.*  
 1. *prima*, Barr. ....Shield obovate.  
 1\* ——— var. *secunda*, nov. .... ,, round.  
 2. *Wilsoni*, H. Woodward..... ,, ,,  
 3. *Lapworthi*, H. W. .... ,, obovate.  
 4. *glabra*, H. W. .... ,, round.  
 5. sp. nov. .... ,, obovate.  
 6. sp. nov. .... ,, obovate.  
 7. *Salteri*, H. W. .... ,, ovate.  
 8. sp. nov. .... ,, oblate.
11. PELTOCARIS, Salter, 1863. *Nuchal furrow rounded.*  
 1. *aptychoides*, Salter .....Shield oval.  
 2. ? *anatina*, Salter ..... ,, ?  
 3. sp. nov. .... ,, oblate.  
 4. sp. nov. .... ,, oblate.  
 5? *Harknessi*, Salter ..... ,, ?

<sup>1</sup> The measurement for the *shape* is taken as an outline all round the shield by its general contour outside both the notches.

12. PINNOCARIS, R. Etheridge, jun., 1878. Possibly bivalved, and without rostral piece.

1. *Lapworthi*, R. E., jr.....Shield triangular-obovate (if the two lateral pieces be laid out together).

It is well known that some of these Phyllopodous tests, shields, or carapaces were noticed and figured by early observers; and, from their general resemblance to the Aptychus of Ammonites, they were thought to be Aptychi of Goniatites. Such are—1. *Aptychus lævigatus* (Goldfuss), in Von Dechen's "Handbuch der Geognosie," 1832, p. 529 (not figured and undetermined). 2. The *Aptychus vetustus*, of Vicomte d'Archiac and E. de Verneuil, Trans. Geol. Soc. London, ser. 2, vol. vi. 1842, p. 343, pl. 26, fig. 9, from the Devonian rocks of the Eifel: this appears to be such a form as is now referred to *Dipterocaris*. 3. Count Alexander von Keyserling in 1846 figured and described some small Aptychus-like fossils in the "Wissensch. Beobacht. Petschora-Land," p. 286, pl. 13, figs. 3–7. These were found in Devonian strata, and he regarded them as the opercula or Aptychi of Goniatites; but their contours do not quite match the shape of the apertures of these shells, although some of the outlines given on the plates are nearly coincident. They approach closely the Phyllopod shields known as *Ellipsocaris*. 4. In 1850 F. A. Roemer described and figured his *Aptychus dubius*, from the Upper Devonian beds of the Hartz, namely, from the Goniatite-limestone of the Kelwasserthal, "Palæontographica," vol. iii. p. 28, pl. 4, fig. 18. Mr. J. M. Clarke has referred it to *Spathiocaris*, but it seems rather to be a *Discinocaris*. 5. In the same volume, p. 88, pl. 13, fig. 13, F. A. Roemer gave also another such fossil as an *Aptychus*, from the Goniatite-limestone of Altenau, Hartz. The figure suggests that it might be a *Pholadocaris*.

It has been argued that only some of these small, black, carbonaceous, filmy, shield-like bodies can have belonged to Phyllopods, and that many of them were really opercula or Aptychi of Goniatites.<sup>1</sup> It appears to us, however, that the little fossils under consideration resolve themselves into certain categories. Thus, for example, we have forms like *Discinocaris*, which could not, by reason of their shape in general, and the presence of their frontal piece in particular, have belonged to any Cephalopod, much less to a Goniatite, even if it possessed an operculum, which is by no means proved. Next a large series of forms occur in strata wherein no Goniatites have been found. As to such as have been met with in beds containing Goniatites, as in Nassau, the Eifel, the Hartz, and Petschora-Land, it is to be remarked that their outlines do not correspond exactly with the apertures of the shells of such Cephalopods. As other Phyllopods (such as *Estheria*) are imbedded in Devonian rocks, it is not strange that these Phyllocaridæ should be there present. Whilst, however, we do not deny that some forms now associated with undoubted shield-bearing Phyllopods may hereafter be shown to be Molluscan, where there is any possibility of doubt the *onus probandi* must rest with those who are dissatisfied with our views regarding their affinities.

<sup>1</sup> See Herr Dames, N. Jahrb. f. Min. etc., 1884, i. p. 275, etc.

We are the more strengthened in our opinion of the affinities of these Palæozoic Crustacean shields, because their ornamentation agrees with that of known Phyllopod carapaces, both in the minute ridge-like, concentric lines of growth, and, in some cases, in the delicate surface-ornament between them.

It is to be observed also that these circular or ovate shields were not originally flat discs or plates, but in many cases either subconical or ridged, and herein unlike *Aptychi*, but resembling some Phyllopods. Thus *Discinocaris Browniana* had a low conical surface: *Aspidocaris triasica* was evidently conical, for the outer rim has been radiately split owing to the flattening of the shield. *Spathiocaris Emersonii* and *Lisgocaris Lutheri* had elevated subconical carapaces. *Aptychopsis* not unfrequently shows breakage resulting from vertical compression; and in *Cardiocaris* we sometimes see a median line or mark caused by a depression along the central portion. Some forms, such as *Dipterocaris procne*, have the carapace bent ridge-like along the middle of the back. The species now regarded as characteristic and well defined are:—

I.—DISCINOCARIS.

1. *Discinocaris Browniana*, H. Woodward, 1866, Quart. Journ. Geol. Soc. vol. xxii. p. 504, pl. 25, figs. 4, 5, 7. From the Anthracitic Shales of the Moffat District, at Dobbs Linn, and Garpoolburn, and in equivalent Silurian beds at Coalpit Bay, Co. Down, Ireland.

2. *D. dubia* (Roemer), 1850. Referred to above.

3. *D. lata* (H. Woodward), 1882. GEOL. MAG. Dec. II. Vol. IX. p. 388, Pl. IX. Fig. 13.

This Mr. J. M. Clarke refers to *Spathiocaris*, but with us it is accepted now as a *Discinocaris*, having concentric striæ, and an angular notch. From the Upper Devonian of Budesheim in the Eifel, and Bicken in Nassau.

4. *D. triasica* (*Aspidocaris*, Reuss), 1867. Sitzungsab. k. Akad. Wiss. Wien, vol. 55, pp. 1, etc., pl. (not numbered), figs. 1–5.

Dr. A. E. von Reuss thought that this must be nearly allied to *Discinocaris*, and so did Dr. Woodward, in the GEOL. MAG. Dec. II. Vol. IX. p. 368. It seems, indeed, to be really of that genus, though a different species to any other we know. Von Reuss carefully described and figured this species from the Raibl beds near Hallstadt.

5. *Discinocaris*, sp. nov.

In the Cambridge Museum is a broadly sagittate fossil shield, without the cephalic portion, which appears to belong to a new species. From the Coniston Mudstone (Up. Silurian), Skelgill Beck, near Ambleside.

6. *D. congener* (Clarke), 1884. This is the *Spathiocaris* (*Cardiocaris*?) *congener*, Clarke, N. Jahrb. f. Min., etc., 1884, i. p. 183, pl. iv. fig. 5. It has the characters simply of *Discinocaris*. From the Upper Devonian of Bicken, near Herborn, Nassau.

7. *D. ? gigas*, H. Woodward, 1872. GEOL. MAG. Vol. IX. p. 564. Portions of a large carapace allied to *Discinocaris*, but somewhat uncertain as to shape, have been found in the Moffat beds at Ettrick-bridgend, Selkirkshire, and in the Upper Silurian (Coniston Mudstone) of Skelgill Beck.

II.—SPATHIOCARIS, J. M. Clarke, 1882. Amer. Journ. Sci. ser. 3, xxiii. p. 477, xxv. p. 120, etc., N. Jahrb. f. Min. 1884, i. p. 181, etc.

As characteristic of this genus we retain only those with a very narrow nuchal notch; the other forms referred to this genus having this feature broad, as in *Discinocaris* and *Cardiocaris*.

1. *Sp. Emersonii*, Clarke, 1882, *loc. cit.* fig. 1.

An elegant elliptico-oblong shield with narrow cephalic cleft.

1\*. *Sp. Emersonii*, young form, Clarke, *loc. cit.* fig. 2.

This seems to be too ovate for the species mentioned.

1\*\**. Sp. Emersonii*, Clarke, fig. 3.

This is figured as a side-view of a folded *Spathiocaris*, but it looks like one-half of an *Aptychopsis*; not having seen the specimen, we cannot decide.

These are from the Upper Devonian beds of the Portage and Chemung groups in the western part of the State of New York.

2. *Sp. unguilina*, J. M. Clarke, 1884, Neues Jahrb. f. Min. etc., 1884, i. p. 182, pl. iv. fig. 4.

A neat oval shield, with narrow notch. From Upper Devonian beds at Bicken, near Herborn, in Nassau.

III.—PHOLADOCARIS, H. Woodward, 1882. GEOL. MAG. Dec. II. Vol. IX. p. 388.

Surface of shield marked by two radiate lines behind, and by two shorter, curved lines in front of the centre.

1. *Ph. Leeii*, H. W., 1882, *loc. cit.* Pl. IX. Fig. 16.

Of a cuneiform outline. From the Upper Devonian of Bäddestheim.

2. *Ph. sp. n.* Figured by F. A. Roemer in 1850, as above mentioned.

IV.—LISGOCARIS, J. M. Clarke, 1882. Amer. Journ. Sci. ser. 3, vol. xxiii. p. 478, fig. 5; and xxv. p. 124.

The shield is here strongly radiate, behind with three ridges and in front by two, giving a subpentagonal outline by their angularities at the margin. The nuchal furrow is rounded at its apex (not angular). Mr. Clarke thought to reunite it with *Spathiocaris* on account of these two having no suture—neither has *Discinocaris*. The narrowness of the angle in *Spathiocaris* and the rounded notch in *Lisgocaris* should, we think, be regarded as leading characteristics.

From the base of the Hamilton beds (Devonian), State of New York.

V.—ELLIPSOCARIS, H. Woodward, 1882. GEOL. MAG. Dec. II. Vol. IX. p. 444.

Elegantly oval, with an oval notch. Its ornament of the usual concentric lines of growth is accompanied by the delicate interlinear sculpturing seen in *Estheria*. This shows the close relationship of these Phyllopora.

2. *Ellipsocaris*? sp. nov.

The little oblong, oval, and ovate tests found in Devonian strata in Petschora-Land, and figured by Count Keyserling in 1846, are mentioned above. They do not match in outline exactly the apertures of any of the *Goniatites* figured from the same beds.

VI.—CARDIOCARIS, H. Woodward, 1882. GEOL. MAG. Dec. II. Vol. IX. p. 386.

The tests referred to this genus are much like those of *Discinocaris*, but the posterior margin is irregular, not entire, in its outline, and in some cases is indented, leading, as it were, to the posteriorly notched forms of *Dipterocaris*.

1. *C. Roemeri*, H. W., 1882. *Loc. cit.* Pl. IX. Figs. 1—7.

Rather slipper-shaped, of various sizes. One of the small specimens preserves its triangular cephalic piece in place. This most interesting circumstance takes *Cardiocaris*, and by presumption its allies, out of the category of opercula, although *Goniatites*, which are thought by some to have *Aptychi*, abound in the same series of strata (Devonian) at Budesheim in the Eifel.

2. *C. bipartita*, H. W. *Op. cit.* p. 388, Figs. 14 and 15.

Near *C. Roemeri* in shape; marked along the back by a kind of linear fold or crumpling, owing to pressure on a somewhat convex test,—a condition seen in other specimens. From Budesheim, Eifel.

3. *C. Veneris*, H. W., 1882. *Op. cit.* p. 387, Pl. IX. Figs. 8—12.

Shield broader and shorter than *C. Roemeri*, with broad cephalic notch. From the same Devonian beds at Budesheim, Eifel.

4. *C. Koeneni* (*Spathiocaris* Clarke), 1884. *N. Jahrb. f. Min. etc.* 1884, i. p. 182, pl. 4, fig. 1.

A fine broad *Discinocaris*-like test, but truncate and somewhat sinuous on the posterior margin. Its wide notch separates it from *Spathiocaris*. It is from the Upper Devonian of Bicken, Nassau.

VII.—DIPTEROCARIS, J. M. Clarke, 1883. *Amer. Journ. Sci. ser. 3*, vol. xxv. p. 121.

The test or shield is here split on the posterior portion medially for a greater or less distance, as well as in front, leaving only an isthmus connecting the two lateral pieces. The front notch is broad; the hinder notch or cleft is usually longer than the other, and very wide, but in some cases it is very narrow. The several species are:—

1. *D. pes-cervæ*, J. M. Clarke, *loc. cit.* figs. 4, 5.

2. *D. vetusta* (d'Arch. et de V.), already noted. Devonian, Eifel.

3. *D. procne*, Clarke, *loc. cit.* figs. 2, 3.

4. *D. pennæ-dædali*, Clarke, *loc. cit.* fig. 1.

5. *D. Etheridgei*, nobis. *Fossils of Girvan, etc.*, 1880, p. 212, pl. 14, fig. 21. The last is from the Lower Silurian of Ayrshire, Scotland; and Mr. Clarke's specimens are from the Upper Devonian of Western New-York State.

It is difficult to determine whether the posterior cleft in the carapace was filled with a wedge-shaped median piece, as the anterior notch presumedly was.

The shield of *Pholadocaris* with its posterior triangular facet seems to present an analogous feature.

VIII.—PTEROCARIS, Barrande, 1872.

This somewhat obscure fossil is only a cast, but has certain characters which connect it with *Dipterocaris*, namely, its front and hind notches, the former of which retains the little triangular cephalic piece in the unique specimen figured and described as

*Pt. Bohemica*, Barrande, Syst. Sil. Bohême, vol. i. Suppl. p. 464, pl. 25, figs. 25, 26. From the Étage D (Lower Silurian) of Bohemia.

IX.—CRESCENTILLA, Barrande, 1872.

This is represented by very minute, smooth, subconvex, bicentric tests, that is, consisting of two nearly semicircular or short-reniform laterals, with symmetrical hornlike points or angles projecting outwards from the front and hind quarters. The dorsal joint or suture occupies only a small portion, owing to the convexity of the inner edges of the two wings; and the front notch is occupied by the usual small, triangular, cephalic piece. At least this impression is conveyed by the figure 1a (pl. 26, *op. cit.*) given by Barrande when looked at upside-down.

This curious little fossil occurs in varying numbers throughout the "quartzites D, d2, d3, d4, and d5," of Bohemia.

X.—APTYCHOPSIS, Barrande, 1872.

Syst. Sil. Bohême, vol. i., Suppl. p. 436, p. 455; and H. Woodward, GEOL. MAG. Vol. IX. p. 564; Report Brit. Assoc. for 1872, p. 323.

A circular or elliptical, subconvex, tripartite shield or carapace, divided by a median (dorsal) suture, and by a transverse angular suture in the front third of the shield. A concentric linear ornament, made up of lines of growth, is characteristic, as in *Discinocaris*, etc.

1. *A. prima*, Barrande, 1872. *Op. cit.* p. 457, pl. 33, figs. 1–21. These comprise a long obovate form, and a less number of short round shields. These latter we propose to recognize as a variety, and name it var. *secunda*, because M. Barrande years ago used to label the round forms as "*Aptychus secundus*," before he had determined its Crustacean relationship, and separated it from the more numerous and evidently allied form. They are from the limestone and shales, respectively, of Étage E, e 1 of Butowitz, Borek, etc., in Bohemia.

2. *A. Wilsoni*, H. W., 1872. GEOL. MAG. Vol. IX. 1872, p. 565, and the Sixth Report on Fossil Crustacea, Brit. Assoc. Rep. for 1872, p. 323.

A large round form, from the Riccarton beds, Upper Silurian, near Hawick, Scotland.

3. *A. Lapworthi*, H. W., 1872. *Locc. citt.*

A neat obovate tripartite shield (when complete). Sometimes retaining all three pieces in place. From the Moffat Shales of the Birkhill Group (Lower Silurian), Selkirkshire.

4. *A. glabra*, H. W., 1872. *Locc. citt.*

A round shield, smaller than *A. Wilsoni*, and different in outline from both that species and *Apt. prima*, var. *secunda*. From the Gala beds (Upper Silurian) of the Moffat district.

5. *Aptychopsis*, sp. nov.

In the British Museum is a lateral piece of an *Aptychopsis*, delicately ornamented, and shaped differently from the others. Unfortunately it has no locality noted.

6. *Aptychopsis*, sp. nov.

In the Museum of Practical Geology several specimens of lateral pieces, in different stages of preservation, from the Tremadoc Slates

of Garth, near Portmadoc, North Wales, are referable to this genus, but do not match any known species.

7. *A. Salteri*, H. W., 1882. GEOL. MAG. Dec. II. Vol. IX. p. 389, Pl. IX. Fig. 19.

A distinctly-marked species, with ovate outline (when complete); from the Upper Silurian of Pencarreg, Caermarthenshire.

8. *Aptychopsis*, sp. nov.

A small transversely oval, or oblate form, with broad notch; in the Cambridge Museum; collected by Mr. Marr in the Brathay (Lower Coniston) Flags at Troutbeck, Windermere.

A similar oblately circular *Aptychopsis* is in the British Museum from the Gala beds near Moffat.

XI.—PELTOCARIS, Salter, 1863. Q. J. Geol. Soc. vol. xix. p. 87.

This Phyllopora was at first referred by Mr. Salter to *Dithyrocaris*, then to *Ceratiocaris*; and at last, as his knowledge of these Crustacea extended, he was enabled to assign it to a proper place with a distinct name. It is discoidal, round or oval, tripartite, with straight median dorsal suture, reaching forward as far as a transverse curved nuchal suture.

1. *P. aptychoides*, Salter, 1852. *Loc. cit.* p. 88; and H. Woodward, Q. J. G. S. vol. xxii. 1866, p. 504, pl. 25, fig. 6.

Several specimens have been got from the Moffat beds (Lower Silurian), and from co. Down, Ireland (Middle or Upper Silurian).

2. *P. anatina*, Salter? 1873. In the "Catal. Palæozoic Fossils Cambridge," p. 93, this species is mentioned, but as yet it has not been satisfactorily identified.

3. *Peltocaris*, sp. nov.

A small shield, cordate in form without its cephalic piece, is in the British Museum, from the Moffat beds (L. Silurian) of Wasthope Burn.

4. *Peltocaris*, sp. nov.

A small transversely oval or oblate shield, with very broad notch, like No. 8, *Aptychopsis*, in general shape, seems to be quite new. From the Lower Silurian Shale of Moffat. Another, like it, but still smaller, is in the Cambridge Museum, from the Coniston Mudstone of Skelgill Beck (Marr).

5. *Peltocaris*? *Harknessi*, Salter, 1863. In the Quart. Journ. Geol. Soc. vol. xix. p. 89, fig. 2, Mr. Salter described a fragment of a carapace which he doubtfully referred to *Peltocaris*.

XII. PINNOCARIS, R. Etheridge, Jun., 1878. *P. Lapworthi*, R. E., Jun. Proc. Roy. Phys. Soc. Edinb. vol. iv. 1878, p. 167, pl. 2, figs. 3-5; and "Fossils of Girvan," 1880, pp. 207, 210, pl. 14, figs. 17-20.

Some separate laterals of apparently folded or sutured carapaces have been carefully treated of by Mr. R. Etheridge, Jun., as showing Phylloporous characters. The separated pieces have the shape of valves of the *Pinna*, broad and rounded at one end, narrow at the other. The lines of growth are concentric with a kind of umbo some way back from the front, about a third of the length of the test. There would be but little room, if any, for a rostral piece, if the carapace were flat; and possibly it was really bivalve.

The species is found near Girvan, Ayrshire, in a Lower Silurian stratum; and in an Upper Silurian bed near Kendal, whence there is a specimen now in the British Museum.

With regard to *caudal spines* appertaining to these little Apudi-form Crustaceans, we have not much to remark. At Skelgill, in the Upper Silurian (Coniston) mudstone, in which specimens of *Discinocaris* and *Peltocaris* occur, Mr. J. E. Marr found a small tapering caudal spine, 15 mm. long, and delicately striate. This may have belonged to one of the forms just mentioned. So also a small tail-spine in the British Museum from the Riccarton beds (Upper Silurian) of Shankend, near Hawick, probably belonged to an *Aptychopsis*; also two larger spines (apparently two of a set of three), one 35 mm. and the other 20 mm. long, are in the British Museum from the Buckholm bed of the Gala group (Upper Silurian), Meigle Hills, Galashiels. These are large enough for a small *Ceratiocaris*, but *Aptychopsis* only is known in these strata.

We may add that a few similar caudal spines (one 20 mm. long) have been found by Mr. Marr in the Upper Arenig Slates at Port Seiont near Caernarvon. Here they are associated with *Caryocaris*.

#### VI.—ON SOME CARBONIFEROUS ENTOMOSTRACA FROM NOVA SCOTIA.

By T. RUPERT JONES, F.R.S., and JAMES W. KIRKBY, Esq.

(PLATE XII.)

THE Entomostraca that form the subject of the following remarks are from the Carboniferous rocks of Nova Scotia, and were submitted to us for examination, at different times, by Principal Dr. J. W. Dawson, C.M.G., F.R.S., of McGill College, Montreal.

Certain of them are from the Lower Coal-measures of Horton, strata equivalent, probably, to the Sub-Carboniferous of Dana, and the Lower Carboniferous and Mountain-limestone series of British geologists.

Other specimens are from the Middle Coal-measures of the Joggins; and others are from the Upper Coal-measures of the South Joggins; both of which groups of strata are perhaps near representatives, in time, of the Coal-measures of Great Britain.

Altogether we have made out ten or eleven species and varieties, which are figured in the Plate accompanying this paper, and on which we proceed to make the following notes.

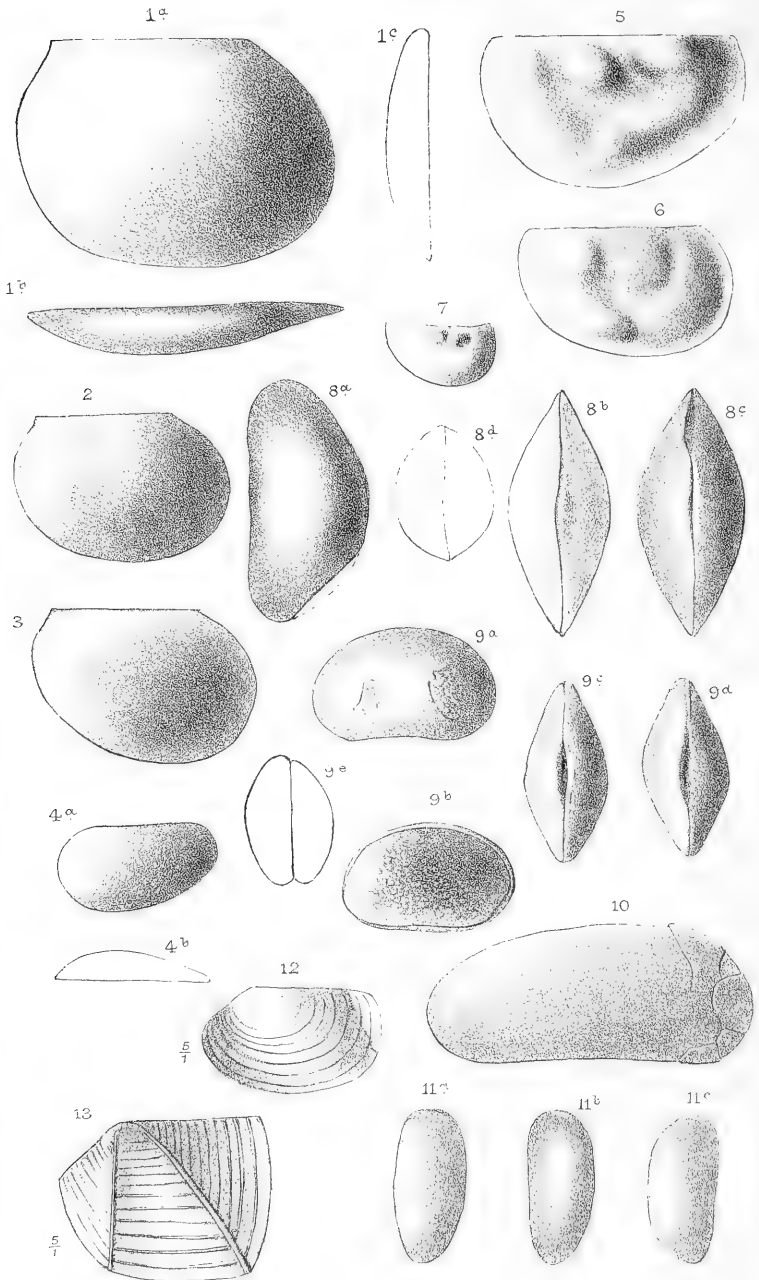
##### 1.—LEPERDITIA OKENI (Münster). Plate XII. Fig. 3.

*L. Okeni* (Münster), Jones and Kirkby, Ann. Mag. Nat. Hist. ser. 3, vol. xv. 1865, p. 406, pl. 20, figs. 1—3; and ser. 4, vol. xv. p. 54, pl. 6, fig. 1.

The most common forms from the Lower Coal-measures of Horton belong to the very wide-spread and abundant species, *Leperditia Okeni* (Münster). Some of our specimens received from this locality were separately mounted on cardboard; others occur plentifully in hand-specimens of hardish grey shale, where they are associated with species of *Beyrichia* and *Cythere* (?), hereafter noticed. Somewhat the lesser number of them are easily recognizable as typical







A.B.Woodward lith.

West Newman & Co imp.

Carboniferous Entomostraca, from Nova Scotia.

members of the species, by their narrower anterior extremity, and their pronounced posterior obliquity. These specimens are illustrated in Fig. 3. They are small, being only about  $\frac{1}{10}$  inch, or 1.4 millimètre long, and 1 mm. in height, of which size they occur in European strata, though they are as often found larger, even up to double the length.

This species has been described and figured by us from Bavarian specimens (supplied to us by Dr. Gümbel) and Russian material (from the late Dr. von Eichwald), in the Annals and Magazine of Natural History, ser. 3, vol. xv. 1865, p. 406.

2.—LEPERDITIA OKENI (Münster), var. *Scotoburdigalensis* (Hibbert).

*Leperditia Okeni*, Acadian Geology, 1868, p. 256, fig. 78b. *L. Scotoburdigalensis* (Hibbert), Jones, Proceed. Berwicksh. Nat. Club, vol. iv. 1884, p. 321.

Along with the just noticed specimens are other *Leperditia*, much less oblique, with extremities of about equal width (or height). These, in some instances considerably larger, are represented by Figs. 1 and 2; and we have no hesitation in identifying them with the form hitherto considered a variety of *L. Okeni*, under Hibbert's name of *Scotoburdigalensis*. Dr. Hibbert described and figured it, in his well-known paper on the Burdiehouse limestone, as a *Cypris*. In 1866 we had an opportunity of examining Dr. Hibbert's specimens, as well as others collected at Burdiehouse, by several friends, the result of which satisfied us that the Entomostracan in question is a *Leperditia* nearly allied to *L. Okeni*: Ann. Nat. Hist. ser. 3, vol. xviii. p. 34.

*L. Okeni* is a species with several near relations, for the present looked upon as varieties. Whether some of them, and *Scotoburdigalensis* among the number, may not ultimately have to be separated from it, as distinct species, is an open question; for a careful re-examination of these *Leperditia* has long been a matter to be desired, and it is one now that we hope soon to overtake.

At Burdiehouse, both in the limestone and in the shale associated with it, *L. Okeni*, var. *Scotoburdigalensis*, is extremely abundant. So much so that its carapace-valves (often more or less crushed) appear to compose or build up the rock in which they occur. It is just as plentiful in other beds, at many places in Scotland, more especially in Fife; but always in the Calciferous Sandstone (Tuedian) or Lower-Carboniferous portion of the series.

It is of especial interest to meet with so old a friend, as it were, so abundantly, and under so robust a habit—for we have never seen larger examples of it in Scotland—in Carboniferous rocks on the American side of the Atlantic, and occupying about the same stratigraphical position as in Britain.

3.—LEPERDITIA OKENI (Münst.), var. *acuta*. Plate XII. Figs. 4a, b.

*L. Okeni*, var. *acuta*, J. and K., Ann. M. N. Hist. ser. 3, 1865, vol. xv. p. 406.

*Cythere?* Dawson, Acadian Geology, 1868, p. 206, fig. 48c?

Fig. 4a represents the right valve of a comparatively small, but relatively long *Leperditia*, that has the anterior half much narrower,

or less high, than the posterior half, and agrees very well with the var. *acuta* of *L. Okeni*, as described by us in the Ann. Nat. Hist. 1865.

We have only seen a single example of this form, which is from the so-called "Cypris-shale" of the Joggins Coal-measures.

4.—*BEYRICHIA NOVA-SCOTICA*, sp. nov. Plate XII. Figs. 5 and 6.  
*Beyrichia*, Dawson, Acadian Geology, 1868, p. 256, fig. 78c.

This *Beyrichia* is found along with the two first-noticed forms of *Leperditia*, in the shale from the Lower Coal-measures of Horton. Its resemblance to D'Eichwald's *B. colliculus* and *B. gibberosa* is such that we have been disposed to refer it to them, which belong probably to one species. But the want of authenticated examples of these Russian forms for comparison, together with certain differences shown by D'Eichwald's figures from the form under notice, have led us to look upon the latter as undescribed.

The two valves figured are not exactly alike in outline; and it is probable that in Fig. 5 the posterior extremity is not perfect where it sweeps down to the ventral margin.

In Fig. 6, which represents a left valve, the dorsal line is seen to be straight and the anterior extremity narrower than the posterior, this is a generic feature in *Beyrichia*. The anterior extremity projects only a little way beyond the dorsal line or margin, and then curves rapidly backwards and passes into the evenly convex ventral margin; the posterior extremity is boldly rounded. The valve is divided into four bosses, lobes, or elongated, protuberant areas, by deep sulcations or depressions. The two uppermost swellings, which are submedial in position, are the most round and boss-like; behind and below the more posterior boss is an elongate, curved swelling; and another, similar, but smaller, lies in advance, parallel to the margin of the antero-ventral curve. A narrow, depressed area, follows the course of the free margins, and separates them from the main and convex portion of the valve. Surface apparently smooth. Length varying from  $\frac{1}{23}$  to  $\frac{1}{17}$  inch in length.

5.—*BEYRICHIA* or *PRIMITIA*? sp. Plate XII. Fig. 7.

From the Lower Coal-measures of Horton we have seen the single specimen here figured. It looks very much like a little *Primitia*, with central sulcus and an elevation on each side, one of which has been either broken in or bears a small central depression instead of a terminal tubercle. It may be an undeveloped form of *Beyrichia*. About  $\frac{1}{40}$  inch in length.

6.—*CARBONIA FABULINA*, Jones and Kirkby. Plate XII. Figs 9a-e.  
*Cytherella inflata*, Dawson, Acadian Geology, 1868, p. 206, fig. 48b.  
*Carbonia fabulina*, J. and K., 1879, Ann. Mag. N. H. ser. 5, vol. iv. p. 31, pl. 2, figs. 1—9; and var. *humilis*, loc. cit. figs. 11—14.

Perhaps the most interesting specimens from the Joggins Coal-measures are a series of *Carbonia fabulina* and varieties, occurring in a softish black shale which surrounds the base of the well-known reptiliferous tree-stumps that were discovered by Dr. Dawson and

so well described by himself and Sir C. Lyell. The majority of the specimens belong to the typical form of this very common and widely distributed species, there being no perceptible differences to be detected in them. The larger examples of the typical form are about  $\frac{1}{7}$  of an inch in length, and all of them show the punctate or pitted surface of well-preserved British specimens.

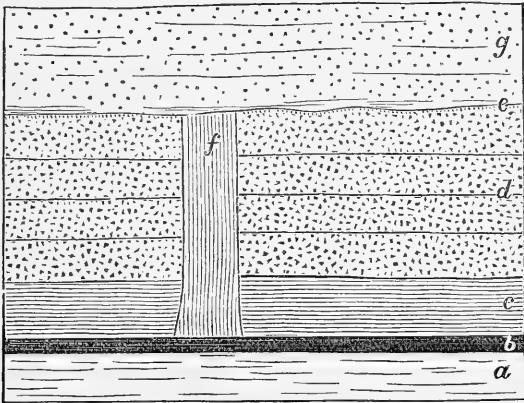
With the preceding are several examples of the less-arched form to which we have given the varietal name of *humilis*. This variety in Nova Scotia possesses the same thick shell, strong amount of overlap, and peculiar dorsal border that characterize British specimens. The surface is pitted or subreticulate, as in typical examples of the species; and the length is from  $\frac{1}{5}$ th to  $\frac{1}{2}$ nd of an inch.

7.—*CARBONIA* (?) *BAIRDIOIDES* (?), J. and K. Plate XII. Figs. 8a-d.

*Bairdia*, Dawson, Acadian Geology, 1868, p. 206, fig. 48a?

*Cythere*? (*Carbonia*?) *bairdioides*, J. and K., 1879, Ann. Mag. N.H. ser. 5, vol. iv. p. 38, pl. 3, figs. 24, 25.

There is also found in the tree-stump shale a larger and rarer form of *Carbonia* (?), which reminds us of some of the simpler



SECTION OF COAL-STRATA AT THE JOGGINS, NOVA SCOTIA.

- g. Sandstone.
- f. Tree, with remains of land-animals in its interior.
- e. Old land-surface.
- d. Sandstone, with plant-remains.
- c. Shale, with *Entomostraca*, *Spirorbis*, &c.
- b. Coal.
- a. Underclay.

forms of *Bairdia*. We have, however, for various reasons regarded it as a near ally of *C. fabulina*; and we have the same variety from the Upper Coal-measures of Fifeshire, Scotland; and a similar, if not the same, form from the Calciferous-Sandstone series of the same county. We have little doubt of its relationship to the foregoing species. It is fully  $\frac{1}{6}$ th of an inch long, and has a boldly

arched dorsal border, prominently and centrally swollen sides, with compressed extremities, and hence a regularly convex lenticular lateral contour. It comes near to our *C.?* *bairdioides*, and may possibly be a modification of that form. The genus is not well made out yet.

Along with these *Carboniæ* there are found ganoid scales of Fishes, the remains of a very thin shell resembling *Anthracomya*, a *Spirorbis* (probably *S. carbonarius*, or near it), pieces of carbonized wood showing structure, and abundant fragments of plants too obscure for determination.<sup>1</sup>

Dr. Dawson informs us that none of the Entomostraca are found inside the tree-stump with the reptilian remains, but that they are confined to a foot or two of shale in which the bases of the trees are imbedded.<sup>2</sup> The accompanying woodcut (see previous page), after a sketch by Dr. Dawson, will help to make their mode of occurrence clear. See also chapter xii. of Dr. Dawson's "Acadian Geology," 1868; and Quart. Journ. Geol. Soc., vol. x. 1853-4, p. 8, "Subdivision IX."

The fossils here associated with the *Carboniæ* are just the same in character as have occurred to us and our friends along with *C. fabulina* in numerous Coal-measure localities in England and Scotland. In fact, in the upper (later) portion of the Carboniferous series the fossils associated with this characteristic Coal-measure Entomostracan are always of this stamp. But in the lower (earlier) portions of the series, and thus in the earlier days of the history of *C. fabulina*, it had a somewhat wider range of associates. For in the Calciferous-Sandstone or Lower-Carboniferous series of the East of Scotland, it is found of very robust habit, together with *Leperditia Okeni* (type form), *L. Okeni*, var. *Scotoburdigalensis*, *Beyrichia subarcuata*, and *Cythere superba* (J. & K. MS.), all of which species occur at other times with undoubted marine Mollusca (*Schizodus*, *Myalina*, *Macrocheilus*, etc.), and other fossils. In these latter cases, however, *Carbonia* is absent; and when it is found with the *Leperditia*, and other named Entomostraca, plant remains and other indications of nearness of land are always present. So that everything points to *C. fabulina* having had its habitat in decidedly shallow water,—let it have been fresh, brackish, or marine.

While on this point it may be observed that the same remarks hold good as to the conditions under which the *Leaia* and *Estheria* (to be afterwards noticed) lived. All that is known of the physical surroundings of the species of these genera indicates shallow water with land close by. To some extent the Burdiehouse variety of *L. Okeni* may be included within these observations; for, though it was unmistakeably marine in its general mode of life, it is almost

<sup>1</sup> See GEOL. MAG. Dec. II. Vol. VIII. p. 95, 1881.

<sup>2</sup> Some of the hollow stems of the Coal period were evidently frequented by swarms of these ancient water-fleas. We have taken numerous specimens of the species, *C. fabulina*, from the interior of a flattened *Calamites*, in Coal-measures, Pirnie Colliery, Fife; and our friend, Mr. John Young, of Glasgow, found the same species very abundant inside of a stem of *Lepidodendron*, in the Coal-measures of the West of Scotland.

invariably found in deposits that appear to have originated in the shallow water to be found in estuaries, off low coast-margins, or where land or mud-flats were near, to account for the fragments of wood, branches of *Lepidodendron*, and the fronds and stems of Ferns that are so often found imbedded with this Entomostracan.

With the remains of these littoral, estuarine, or shallow-water-loving Entomostracans in similar Carboniferous deposits on each side of the North Atlantic, it seems reasonable to assume that, whether the migration has been from east to west, or from west to east, it must have been through regions where shallow-water conditions prevailed suitable to their existence. Whether such conditions obtained in the Carboniferous period across any portion of the area of what is now the North Atlantic,—or whether the migration took place by a route that is now occupied by the continental areas of Europe, Asia, and North America—there is scarcely evidence to decide. There is much difficulty, whichever way we look at it; and it must suffice for us to have pointed out the fact that some of the most common and characteristic of what have evidently been shallow-water Entomostraca of the British Carboniferous strata are found abundantly in equivalent rocks in Nova Scotia, as well as on this side of the ocean.

8.—*CANDONA?* *ELONGATA*, sp. nov. Plate XII. Fig. 10.

From the same shale as that in which the *Carbonia* occur, we have a single valve that has much the character of the recent genus *Candona* (ex. *C. candida*). It may be briefly described as follows:—

Elongate; ventral margin slightly concave, dorsal margin curving gently upwards to point of greatest width (or height), which is about a fourth of the length from the hinder end; posterior extremity wider than the anterior. Surface smooth. Length  $\frac{1}{4}$ th of an inch; greatest breadth  $\frac{1}{30}$ th of an inch.

This species—so far as it is known from this single valve—has some resemblance to *Carbonia? bairdioides*, J. and K.; but it approaches much nearer to a large *Candona* that we have from the Coal-measures of England, which was collected by the late Mr. W. Molyneux, F.G.S., from the shales of the North-Staffordshire Coal-field.

*CY THERE?* spp. indett. Plate XII. Figs. 11 a-c.

*Cythere*, Dawson, in part, *Acadian Geology*, 1868, p. 256, fig. 78a.

Figs. 11 a, b, c. represent some single valves of probably two species of *Cythere?*, that are found associated with *Leperditia* and *Beyrichia*, in the Lower Coal-measures of Horton. The outlines remind us of *Carbonia pungens*, J. and K., or of dwarfed specimens of *Cythere aequalis*, J. and K.; indeed, it is hard to say what known form they resemble. We figure the specimens to draw attention to them, and in the hope that better examples may turn up to allow of their affinities being spoken of with more precision.

9.—*ESTHERIA DAWSONI*, Jones. Plate XII. Fig. 12.

*Estheria*, Dawson, *Acadian Geology*, 1868, p. 256, f. 78d.

*Estheria Dawsoni*, Jones, 1870, *GEOL. MAG.* Vol. VII. p. 220, Pl. IX. Fig. 15; and Dec. II. Vol. II. 1878, p. 101, Pl. III. Fig. 2.

A simple subovate *Estheria*, with broad interspaces between the concentric lines of growth, destitute of any visible interlinear sculpture. It is from the Lower-Carboniferous rocks at Horton. Length 5 mm., height 3 mm.

Some specimens from Scotland, thought to be referable to *E. Dawsoni*, were figured and described in 1878 (*loc. cit.*). These have the posterior dorsal angle of the valves strongly pronounced. This feature is not clearly indicated by the lines of growth on the broken specimen from Horton; and we hope to have better examples to show whether or no the Scotch form is actually the same as that from Nova Scotia.

10.—*LEAIA LEIDYI*, var. *Salteriana*, Jones. Plate XII. Fig. 13.

*Leaia Leidy*, var. *Salteriana*, Jones, Monogr. Foss. Estheriæ, Pal. Soc. 1862, p. 119, pl. i. fig. 21.

*Leaia Leidy*, Dawson, Acadian Geology, 1868, p. 256, fig. 78e.

*Leaia Leidy*, Jones, GEOL. MAG. Vol. VII. 1870, p. 219, Pl. IX. Fig. 11.

This is the subquadrate form of *Leaia*, which is found in Wales and elsewhere in association with the more oblong and other varieties. We have not yet seen our way to define them as distinct species (see GEOL. MAG. *loc cit.*). It is about 6 mm. long, by 4 mm. From Horton.

EXPLANATION OF PLATE XII.

(All the figures except Figs. 12 and 13, are magnified about 25 diameters.)

- FIG. 1 and 2. *Leperditia Okeni*, Münt., var. *Scotoburdigalensis*. *a*, left valve; *b*, edge view; *c*, end view. 2, left valve. Lower Coal-measures, Horton.
- „ 3. *Leperditia Okeni*, Münt. Left valve. Lower Coal-measures, Horton.
- „ 4. *Leperditia Okeni*, var. *acuta*. *a*, right valve; *b*, edge view. Coal-measures, Joggins.
- „ 5. *Beyrichia Nova-Scotica*, sp. n. Right valve. Lower Coal-measures, Horton.
- „ 6. *Beyrichia Nova-Scotica*, sp. n. Left valve. Lower Coal-measures, Horton.
- „ 7. *Primitia* or *Beyrichia*, sp. indet. Left valve. Lower Coal-measures, Horton.
- „ 8. *Carbonia? bairdioides*, Jones and Kirkby, *a*, left valve; *b*, ventral view; *c*, dorsal view; *d*, end view. Coal-measures, Joggins.
- „ 9. *Carbonia fabulina*, J. & K. var. *humilis*. *a*, right valve; *b*, both valves; *c*, ventral view; *d*, dorsal view; *e*, end view. Coal-measures, Joggins.
- „ 10. *Candona elongata*, sp. nov. Valve. Coal-measures, Joggins.
- „ 11. *Cythere?* sp. indet. *a*, *b*, *c*, side views of different valves.
- „ 12. *Estheria Dawsoni*, Jones. Left valve, magnified five times.
- „ 13. *Leaia Leidy*, var. Left valve, magnified five times.

VII.—ON A NEW METAMORPHIC AREA IN SHROPSHIRE.

By C. CALLAWAY, D.Sc., F.G.S.

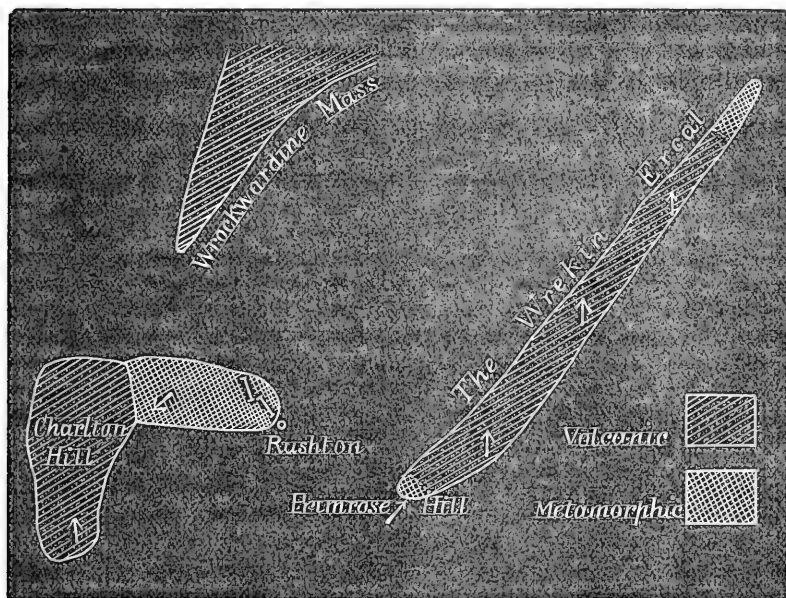
THE occurrence of two Archæan groups<sup>1</sup> in Shropshire is now well known to geologists. The chain of hills which strikes to the south-west from Lilleshall, north-east of Wellington, to the region south of Church-Stretton, is mainly composed of bedded volcanic rocks; but gneissic and granitoid types have been recognized at the Ercal and at Primrose Hill, the elevations forming the opposite extremities of the Wrekin, and a small exposure was detected near Hope Bowdler, east of Church-Stretton. A second<sup>2</sup>

<sup>1</sup> Quart. Journ. Geol. Soc. Nov. 1879.

<sup>2</sup> *Ibid.* May, 1882.



axis of the old rocks, ranging parallel to the Wrekin chain, consists of volcanic ejecta and highly indurated grits, which are probably to be referred to the younger of the two Archæan groups hitherto recognized in the county. The relations between the volcanic and the gneissic systems is clearly defined by the Charlton Hill (see map) conglomerate (a band in the volcanic series), which contains numerous well-rounded pebbles of rock precisely similar to the granitoid gneiss of Primrose Hill. This fact implies a considerable break between the two groups.



Scale : One inch to the Mile.

Map showing the relation of the Rushton Schist to the neighbouring Archæan masses, Shropshire.

Some time since, I discovered another patch of Archæan rock of a type hitherto unknown in England. This mass lies between the Wrekin and Charlton Hill (see map, *supra*). On the Survey Map, the entire breadth of this interval is occupied with the quartzite, described as "altered Caradoc." This rock I have shown<sup>1</sup> to be older than the Hollybush Sandstone, and that it everywhere laps round the Archæan masses. It probably extends continuously from the Wrekin to the village of Rushton, but from this point to Charlton Hill we are on the rock now to be described.

At the west end of Rushton, just where three roads meet, there is a slight outcrop of metamorphic rock, with a clear foliation strike to the north-west. About two furlongs to the north-north-west, there is similar schist, but the strike is more northerly. To the west of

<sup>1</sup> *Ibid*, August, 1878.

the village, at a distance of three furlongs, there is another outcrop, of which I could not with certainty determine the strike. Some of the schist here is very quartzose. The last locality to be noted is in a field about six furlongs to the west-north-west of Rushton. This is the best section, for we can ascertain the dip, which is at a high angle to the west-south-west. It will be noted that all the strikes vary between north-west and north.

The rock is similar in all these localities. It is a fine-grained, quartzose, mica-schist. Some of it might, indeed, be called quartz-schist. It is not exactly like any rock I have yet met with, but its nearest analogue is the quartz-schist of Durness and Tongue. It is, however, of a still finer grain than the Sutherland type.

Prof. Bonney has been kind enough to examine a series of slides cut from rocks typical of the localities named above. The following is a summary of his conclusions, extracted by me from his rough notes.

*Rushton* (134).—This rock is mainly quartz and a green mineral, which is probably an alteration product after a magnesian mica. There are also a hydrous white mica, epidote, and replacements after felspar. The rock is very distinctly foliated. It is a mica-schist of by no means a very modern type.

*Three furlongs west of Rushton* (135).—Constituents similar to last, but rather more minute. Aspect more modern. The rock suggests some of the upper group of Alpine schists ("schistes lustrées" of Lory) and of the newer gneisses of Scotland, *e.g.* part way up Glen Docherty.

*Two furlongs north-north-west of Rushton* (136).—Similar, but contains some irregular clusters of small light-coloured garnets, seemingly partly replaced by a chloritic mineral. Well foliated, but not banded. It is either one of the same group of rather late schists, or, just possibly, an older metamorphic rock crushed *in situ*.

*Six furlongs west-north-west of Rushton* (137-139).—Nos. 137 and 138 are rather similar to 135. No. 137 is traversed by more definite (but very thin) mineral bands. The larger grains of 138 are even more suggestive than 135 of a fragmental origin. One of the grains shows the striping of a plagioclastic felspar. The rock, however, is distinctly metamorphic, and this is more evident under high powers. No. 139 is also metamorphic.

I may state that the resemblance between the Rushton rocks and some of the newer of the Highland schists was noticed by me in the field before I sent specimens to Prof. Bonney; at the same time I am quite prepared to admit the possibility of his suggestion that No. 136 is an old gneiss crushed *in situ*; and if it is so, I know no reason why the whole mass of schist should not be placed in the same category. The facts which lend some support to this view are the following:—

(1) The strike of the Rushton schist is in the same direction as that of the gneiss of Primrose Hill, whereas in the Highlands the strikes of the older and the younger gneisses are widely discordant. Too much importance, however, must not be attached to this coin-

vidence, since, in the contortion of a region, rocks may suffer distortion of strike, and be involved in the dominating movements of another formation. Such facts are familiar to us in the Highlands and elsewhere.

(2) The gneiss of Primrose Hill is faulted against the Wrekin volcanic group, and towards the dislocation shows progressive signs of great crushing.<sup>1</sup> The fault apparently strikes to the north-west, and may very well pass a little to the north of Rushton.

(3) Some of the rocks of Primrose Hill are very quartzose, and these types, though coarser than the Rushton schist, do not widely differ from it.

On the other hand, it may be urged:—

(1) If the Primrose Hill gneiss, which is certainly near a fault, is not crushed into a fine-grained schist, we are hardly justified in applying the crushing hypothesis to the Rushton schist, whose proximity to a fault is not proved.

(2) While the Rushton schist is uniformly highly quartzose, contains hardly any felspar, and is very fine-grained, the Primrose Hill gneiss is sometimes very felspathic, and is coarsely foliated.

(3) At Malvern, where the coarse gneiss, the presumed equivalent of the Primrose Hill rock, is frequently traversed by faults, we nowhere find, so far as I know, any representative of the Rushton schist.

On the whole, I incline to the opinion that, in this newly discovered mass, we have a fragment of one of the newer gneissic groups. As to its correlation with other systems, we may perhaps say that the rock is of Montalban type, without committing ourselves to the conclusion that it is of Montalban age. Comparative lithology has become of increasing importance in the study of the old rocks, but at present we require the assistance of stratigraphy.

It will be seen from the map (p. 363) that the Rushton schist is represented as occupying an area of rather less than one mile in length by about half a mile in breadth. The rock probably extends further to the south, but I could find no exposures in that direction.

On the west side, the schist can be traced to within about 200 yards of a section of volcanic grit of the Wrekin series, in which no strike could be ascertained, but the strike of the volcanic series a little further to the south, in Charlton Hill, is east and west, which is the normal strike of the Wrekin group. As the volcanic rocks dip at a very high angle to the north, it is highly probable that the junction of the two formations is a fault.

I have been able to find no direct evidence of the superior antiquity of the schist to the Wrekin group. Strange to say, though the Charlton Hill conglomerate occurs within half a mile, and contains many varieties of metamorphic rock, I have failed to detect in it a single fragment which I could safely refer to the Rushton schist.

In conclusion, I may observe that if this schist is merely crushed Malvernian gneiss, we are furnished with an example of a new and very singular kind of metamorphism, in which the rock which has

<sup>1</sup> The "hällefinta" into which the gneiss gradually passes is probably, in Prof. Bonney's recent opinion, merely crushed gneiss.

passed through the greater number of changes appears to be the less altered. If this hypothesis is rejected, we must regard the schist either as a normal part of the Primrose Hill group, or a new formation. If the latter supposition be accepted, the number of Archæan formations in Shropshire is raised to three, viz.:—1. The Primrose Hill gneiss. 2. The Rushton schist. 3. The Wrekin volcanic group.

A geologist with a genius for speculation might conclude that we have in this small area the representatives of three of the great Archæan systems of North America—the Laurentian, the Montalban, and the Keweenawian. I would not contradict him, but I would respectfully hesitate.

#### VIII.—CRITICISMS ON RECENT PAPERS ABOUT FAULTS.

By Prof. J. F. BLAKE, M.A., F.G.S.

IN recent Numbers of the GEOLOGICAL MAGAZINE<sup>1</sup> has appeared a paper by the Rev. O. Fisher, "On Faults, Jointing, and Cleavage," which, it seems to me, should not be left to stand unchallenged. It is one of those in which mathematical symbols are made to do duty for arguments. Some idea is started, a few *W*'s and *P*'s are scattered about, an equation is written down, it leads to nothing, and then the conclusion is triumphantly reached. Sometimes, however, there is no conclusion at all; but statements come in incidentally which will hereafter be quoted with the introduction "I have shown." Surely there must be many geological birds too old to be caught by such chaff; but the "MAGAZINE" is also for the nestlings. Such papers, too, are otherwise harmful, for the wide-awake soon learn that credit may be gained by work unfinished, and speculations that are crude, and they are tempted so to seek it rather than by harder labour. So goes our science down and loses caste.

I trust, therefore, that the author will excuse me if I run full tilt at his production, and if he can return the stroke, and hold his ground, all the better for the spectators.

Part I. deals with "geometrical considerations." In the very first paragraph we are told to confound "vertical" with "perpendicular to the bedding," and are restricted to faults in strata with a uniform dip. This is very like the play of Hamlet without the Prince of Denmark. Then we are told that in direct faulting the beds on the whole are compressed vertically. This is only the case in the part where the fault is a common boundary, but "on the whole" every dislocation requires greater space in all directions—as may easily be seen by drawing a diagram of a dislocated brick.

There is no particular harm in § 1 and § 2, and the results are not again referred to. They are simply a few elementary exercises on the addition and subtraction of throws.

In Part II. we are supposed to have "The Mechanics of Faulting and Jointing." It starts off with the statement that "direct faulting is in many instances the consequence of settlement when the strata contract through solidification." I doubt if it is ever due to this

<sup>1</sup> GEOL. MAG. 1884, May No. pp. 204–213, and June No. pp. 266–276.

cause. The succeeding remarks, however, may be intended to prove that it is so, though it is very obvious they do not. In the first place, faults are essentially differential phenomena, and cannot be brought about by anything which affects the stratum as a whole. This may be seen in his Fig. 7; for if the pieces at the side were equally contracted, the gaps would be filled up and there would be no fault. Nothing is said about unequal contraction, so no reason is

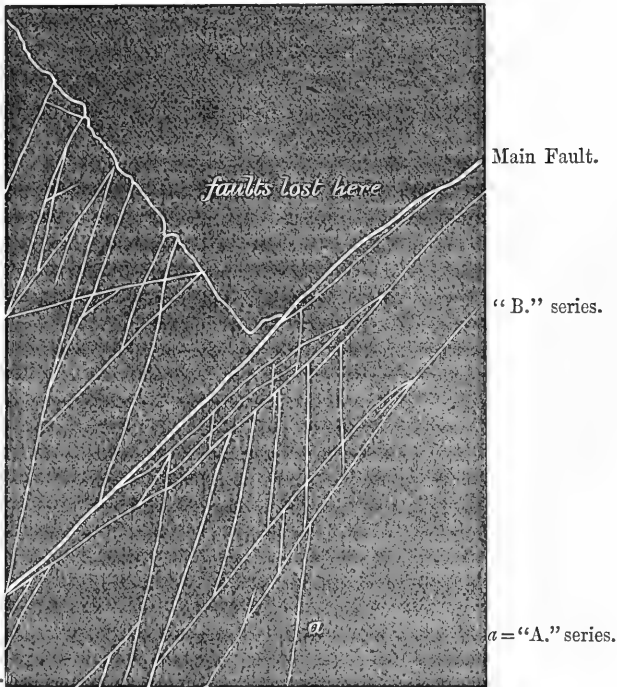


Diagram of Mr. Teall's Faulted Slate (see GEOL. MAG. Jan. No. Pl. I. p. 1, 1884.)

given why one part should contract more than another. This contraction theory is sometimes given for joints, of which it is a possible account in some instances; but the result of attempting to form faults this way may be seen by the remarkable Figures 8 and 9. In the first of these we have two faults crossing without dislocation of either! in spite of the correct relations having been given in Fig. 3. In the second we have a kind of mosaic of such errors, and finally faults dying out against an overlying stratum "which does not contract," and which was therefore supposed to be there when the faulting took place. Does any geologist know such faults? If not, it is of no use wasting time in trying to conceive how the bits in Fig. 9 were arranged before they all contracted. Certainly none such occur on Mr. Teall's slate. Here, however, we come to the end of this theory of faults. Is it proved? What has been done towards

that end? Nothing that I can see, except to confuse the reader to such an extent that he may find the acceptance of the theory whole, the best way to get out of it.

Next we start on quite a different tack to learn the "rationale of the mechanical action." Good bye, contraction! farewell, gaps! We now are to have a surface of shear and two forces at right angles—perhaps we shall get on better with these. Nothing like bringing in a  $\theta$ ! Meanwhile there is a dallying with plasticity. We are told that the assumption that the pressure varies as the area on which it acts introduces the idea of plasticity! Is a steam boiler then plastic? or a table on which a book of uniform thickness rests? However, it does not seem to matter; for we are immediately told what will happen "if it is rigid." Nevertheless, rocks cannot be "rigid" in a mathematical sense if they are to shear—for the definition of rigid is that they will *not* shear. Starting now with our  $WP\theta$  and  $\mu$ , we get an equation, and that is about all we do get. What light it throws upon the subject is not clear, but there is one peculiar feature about it. The  $\mu$  or resistance to shearing stress along a plane is made independent of the pressure perpendicular to that plane. Now is this so? Has it been proved? Friction, which comes into play when the rock splits, depends on the pressure; why not the resistance to shearing? If there are any experiments to prove this, of which I have never heard, it would be more instructive to quote them than Tresca's, which seem to have little to do with faults. But if this is not so, the whole of the mathematics fall to the ground. Without critically examined experiments to prove it, I should never believe that a normal pressure made no difference to shearing. On the next page there is an attempt to unite these supposed forces with the contraction spoken of before, but it leads to "joints" and not to faults, as might be expected, and  $\mu$  to be dropped and  $\kappa$  taken instead; as we know nothing about either, it does not much matter. We are led, however, to the remarkable conclusion that if a rock is cracked, the force which tends to crack it, is greater than that which tends to keep it from cracking! only it is put rather more scientifically (!) "The tension  $P$  . . . increases during contraction. Let  $\kappa$  be the cohesion per unit area of a vertical section. Then, on account of the great energy of molecular forces, we may expect that  $P$  is capable of increasing until it becomes equal to  $\kappa$ ." But it appears this tension  $P$  depends also upon the reaction of the fixed bottom. There is a sort of three-cornered duel, and as  $P$  beats both his adversaries, they must be equal between themselves! It would appear, however, from Fig. 7 that they are not equal, because at the bottom this contraction has been resisted; but at the top it has caused a separation. After the parenthesis, we get back to our equation, and it is made to show that faulting, if allowed, would always be ready to occur at  $45^\circ$ . There are, it appears, two conditions for faulting: one is, there must be room to move, and this is to be brought about by cracks. "Their formation" is "explained" by an equation! which we may suppose produces a suitable crack, though the only one mentioned is a vertical one; our fault, however, is one at  $45^\circ$ .

Does the fault stop at a joint? or what has this joint to do with it? Then we have horizontal joints! does any one know them in stratified rocks? What Prof. Tait would say to  $P$  being called a force and  $=\lambda x$  and then to the "force  $\lambda$ " being spoken of, I cannot think, —probably he would never read so far, nor indeed should I except for criticism, as I cannot see what is to be got out of it all.

Next there is a second condition for faulting, that is, "the hade of the fault must not be less than the angle of repose. (By hade here is meant the inclination to the horizon and not to the vertical, as is usual.) This marvellous proposition with respect to the case in which vertical pressure is alone supposed to act—the horizontal force having been spirited away—requires nine lines of mathematics! Who can doubt that if the upper mass is in "repose," it will not move? or, imagine that a force which is great enough to tear a rock will not move it when torn? How can tearing be shown but by motion? Then we have the following paragraph: [the remarks in brackets are Mr. Blake's.—EDIT.] "If the angle of repose is less than  $45^\circ$  [as it is for all known substances with approximately flat surfaces], the hade of the fault surface will be  $45^\circ$  [which is very rarely the case]; but, if the angle of repose is greater than  $45^\circ$  [which it never is, except the surfaces are hooked], the hade will be the angle of repose, provided it lie within  $l O m$  [hence vertical faults are impossible?]

Here we end the first half of the paper. Can we extract any ideas from it as to the *modus operandi* of faulting? No doubt the attempt will be unsuccessful, but this is what I gather. A mass of rock contracts: vertical contraction makes it sink, horizontal makes it crack; the total result may be an oblique fault, whose inclination to the horizon will be greater as the forces in operation are less. The position of the vertical cracks may be determined as follows. At the bottom, *i.e.* where the cracks end, the contracting force is resisted by the stress exerted by the bottom, which will be proportional to half the distance between the cracks; at the top it will be resisted by the cohesion of the rock; therefore the cohesion must equal the total bottom stress; or half the distance between the cracks equals the ratio between the cohesion per unit area and the coefficient of bottom-stress. The fault will first be started by the increase of the horizontal contracting force, and the easiest to make is one at  $45^\circ$ . There would be no room for the motion, however, and we must start again. The same force will pull across any crack, and will do this easiest when not resisted by the vertical force, hence it will make a vertical crack (!) When these cracks are made, the horizontal force will be exerted in making horizontal cracks [but this horizontal force is not the same as the other horizontal force, that one "might be a pressure or a tension," and "the tension arising from the contraction will amount to" it; but this one is a "contractile force" and "not a compressing force"!] The only force then left to make faults is the vertical one, and this will make one at  $45^\circ$ , terminated by the vertical cracks, which somehow have turned into gaps.

The writer remarks that some former "suggestions" of his "are not generally satisfactory," and he probably says the same of the present by this time; indeed at the end of the paper he has found the beginning unsatisfactory.

We now start with the paper of June, and we read that "we have already seen that a direct fault must have a higher hade (to horizon) than  $45^\circ$ ." What is really stated is quoted above, viz. "the hade of the fault-surface will be  $45^\circ$ ," and faults with higher hades are only possible when the angle of repose is  $> 45^\circ$ . What the erroneous equations show is that it requires the stronger force to make the higher hade, which is manifestly contrary to experience. He now says "any fault with lower hade than  $45^\circ$  must be a reversed fault," which is also contrary to experience.

We next get to a new condition for faulting which, I suppose, should be equally true for direct faults, namely, that the shearing force must be greater than the friction, only in this case both horizontal and vertical components are used. As before, I should say, that this was self-evidently always the case, if by shearing force we mean a force sufficient to produce shearing, but this is not the case here. All that is done is to solve the following elementary problem. Given a crack and the coefficient of friction, what is the ratio between the forces for equilibrium? That this has nothing to do with the greater forces required for shearing if there is no crack, is seen from the results, namely, that less horizontal force will make a reversed fault (as distinguished from distortion) in clay than in solid rock, which is obviously false.

Fortunately the author at the close of this part sees that he is wrong; for he adds, "There can be no doubt that some of the most important faults are not produced by such a disposition of forces as we have contemplated."

Finally we have Part IV. on Cleavage. Here at least we have a definite idea expressed, and the mathematics, if not probative, are at least illustrative. The idea is that cleavage is brought about by the slipping of one slice over another with something like the motion of sand in an hour-glass. This is very like the old explanation of trough faults, only there are to be a great number of them. The author, however, says there can be no faulting, but he means *reversed* faulting, and seems to have forgotten his May paper. It is obvious that, if the middle of the anticlinal sinks fastest, the faulting will be direct, and hence, according to the author, will be more nearly vertical and perfectly possible. This is the only argument, and therefore the whole idea falls through. To start with two oblique lines, and to show that the intervening ones will gradually change over,—to imagine forces and write down the mathematical relations between them and get no further—these are not arguments, and cannot therefore be answered. Daubr e has indeed shown experimentally that cleavage may be produced by pressure which forces the mass *upwards*, unless the strain be relieved by faulting; if this is not strong enough to do it, *  fortiori* sinking down again would not be.



On the whole then, I am no clearer about Faulting, Jointing and Cleavage than I was before, but have had some difficulty in avoiding being puzzled on points which were perfectly clear before. Not so with a paper of M. Hebert, some time ago, which Mr. Teall refers to, but Mr. Fisher ignores. Though short, it had this point clearly brought out—that vertical pressure tends to produce direct, horizontal pressure reverse, faults; by this their relations to the districts in which they occur are clearly seen. I have been led to examine this paper of Mr. Fisher because it was apparently induced by the appearance of Mr. Teall's slate, on which I should like to say a word (see woodcut p. 367). It seems to me that instead of the several series of faults being formed, at different epochs, we have a clear illustration of the complex surroundings of one fault—the main one—when the compactness of the slate prevents its utter degradation into fault rock. I have copied the lines of faults as far as I can make them out, and it will be seen, that though the right-hand vertical fault (*a*) is a little shifted, yet others are not; the faults of the "*B*" set bifurcate on the right, and those of "*A*" on the left, and some appear to belong to neither set. In a word, they are all a series of minor faults, the fragments fitting as best they may, and the whole is very similar to those produced experimentally partly by direct pressure and partly by twisting, as figured in Daubrée's *Géologie Expérimentale*. It is to be noted that the bisection of the angles between the minor faults is pretty nearly perpendicular to the main one. Whatever the interpretation, the beautiful figure was a valuable new-year's gift to geologists, and is worthily placed as Plate I. of the new Decade.

---

## R E V I E W S.

---

MEMOIRS OF THE GEOLOGICAL SURVEY OF INDIA, Vol. XX. Part 2; OR, GEOLOGICAL NOTES ON THE HILLS IN THE NEIGHBOURHOOD OF THE SIND AND PUNJAB FRONTIER BETWEEN QUETTA AND DERA GHÁZI KHAN. By W. T. BLANFORD, F.R.S., etc., Deputy Superintendent, Geological Survey of India. (Calcutta, 1883.)

**T**HIS Memoir has a more than usual interest as being the record of the last field-work undertaken by Mr. Blanford before his final retirement from the Geological Survey of India, after a service of more than twenty-seven years, during which he has not only enriched the publications of the Survey with a large series of valuable memoirs, but has also contributed most largely to our knowledge of the existing mammals, birds, reptiles, and land and freshwater molluscs of India and the adjacent countries.

The country of which the geology is described in this memoir is inhabited by turbulent frontier tribes, through whose territory it is necessary to advance with the protection of an escort, and in which there are some districts where it would be impossible to travel without a considerable military force. Under these circumstances, the movements of the geologist are considerably hampered; and as Mr.

Blanford was frequently in ill-health, and was finally compelled from this cause to leave the field, the amount of work accomplished is well-nigh marvellous. This work is shown on the excellent map accompanying the memoir.

The work is divided into three parts; the first giving a general sketch of the geology of the district, and a notice of previous observers; the second giving details of the geology of the different routes; and the third treating of the economic geology. There is also an appendix describing some fossil freshwater shells.

In the notice of previous observers it is stated that the most important memoirs are by Captain Vicary and Mr. Ball. Mr. Greisbach also traversed a part of the district; and, apparently from an imperfect acquaintance with the Gáj group of Sind, was led into some serious errors in determining the rocks. The discovery by Vicary of vertebrate and molluscan remains in the beds above the Nummulitics of Dera Búgti and the Búgti Hills is noticed on page 21; and Mr. Blanford was fortunate enough to rediscover these fossil localities, and to collect a valuable series of mammalian fossils, which have been lately described in the 10th series of the "Palæontologia Indica."

In the neighbouring district of Sind the geological formations met with are arranged in the following order by Mr. Blanford, viz.

- |                               |                             |
|-------------------------------|-----------------------------|
| 1. Manchhar, or Siwalik ..... | { Upper.....Pliocene.       |
|                               | { Lower.....Upper Miocene.  |
| 2. Gáj .....                  | Miocene.                    |
| 3. Nari .....                 | { Upper.....Lower Miocene ? |
|                               | { Lower.....Oligocene.      |
| 4. Khirtar .....              | Eocene.                     |
| 5. Ránikot .....              | Lower Eocene.               |
| 6. Deccan Trap, etc. ....     | Passage-beds.               |
| 7. Hippurite Limestone .....  | Cretaceous.                 |

In the area under description the Lower Siwalik is wanting near Sibi and Quetta, and the Gáj is entirely absent: the Lower Nari is likewise generally wanting, although present in the Bolán Pass. The change in passing from Sind to the Suleimán range of the Punjab is therefore the disappearance of the two marine subdivisions (Gáj and Lower Nari) of the Upper Tertiaries; and this paves the way for the great development of freshwater (Mari) beds in the more eastern Punjab, below the Siwalik series. Of the older Tertiaries, the Khirtar (Nummulitic) is well represented, but the Ránikot has entirely disappeared.

The beds from which Vicary's fossils were obtained turned out to correspond to the Lower Siwaliks of Sind; although the species of mammals are nearly all different, and indicate a greater affinity with Lower Miocene European forms; and it is therefore not impossible that the fossiliferous Lower Siwaliks of the Búgti Hills may be slightly older than those of Sind. The mammals comprise *Mastodon angustidens* (var.); *M. pandionis*; a large *Hyopotamus*; two species of *Anthracotherium*, one apparently indistinguishable from *A. magnum*; and an *Aceratherium*, which has been named *A. blanfordi*: all being new to India, except *M. pandionis*. Of the Búgti molluscs, Mr. Blanford observes that "of seven freshwater

shells that inhabited the rivers of the north-western Indian frontier in Lower Siwalik times, none are now represented in the surrounding country, five have completely died out, and two have either migrated eastward or have survived to the east and disappeared to the west of India." There is good evidence to show that the mammals are certainly immigrants from the west; and it would therefore seem that there has been an eastward migration, both of mammals and molluscs; species characteristic of older beds in the west occurring in newer beds in the east, and *vice versa*. There is some little doubt as to the exact age of the Lower Siwaliks; Prof. Martin Duncan, from the study of the Echinoderms and Corals of Sind, referring them to the Lower Pliocene. As marine faunas are of more value in fixing the geological age of formations than those of the land, it is not improbable that this view may be correct; and, bearing in mind the above-mentioned migration of the land fauna, it will not be found altogether inharmonious with the evidence afforded by the latter.

In the physiographical section the peculiar sigmoid curvature of the strike of the rocks is noticed; and this has apparently taken place without any fracture. Many of the streams (as in the Himalaya and elsewhere) frequently run at right angles to the strike of the rocks, and flow in narrow clefts directly through tall ridges of hard rock, which are often on an anticlinal axis. As there are no signs of dislocation, the explanation of this peculiarity seems to be that the streams once flowed at a much higher level than at present, and gradually cut deep channels in the subjacent rocks of varying hardness, and that subsequent denudation has removed all these rocks, with the exception of the cores of harder beds, which now form ridges standing far above the level of the rocks of the country.

The part devoted to economic geology is necessarily brief, as the economic products are but small. Coal occurs in the Bolán Pass, and between Quetta and Sibi, and elsewhere; but, as far as is known, the seams appear small and are not likely to be of any practical importance. Petroleum is said to occur in the Mari Hills, but probably in small quantities. Sulphur and gypsum are found locally.

The memoir is illustrated with three excellent plates of Lower Siwalik Mollusca; it also contains a sketch of a natural archway through a ridge of Siwalik conglomerate in the Búgti Hills.

Mr. Blanford and the Geological Survey are to be congratulated on the accomplishment of so much good work in a very difficult country; and now that Mr. Blanford has returned permanently to England, the zoological and geological world will hope to continue to receive a supply of valuable memoirs from his fertile pen.

---

## REPORTS AND PROCEEDINGS.

---

### GEOLOGICAL SOCIETY OF LONDON.

I.—June 11, 1884.—Prof. T. G. Bonney, D.Sc., F.R.S., President, in the Chair. The following communications were read:—

1. "The Range of the Palæozoic Rocks beneath Northampton." By Henry John Eunson, Esq., F.G.S.

The author referred to a shaft sunk at Kingsthorpe, near Northampton, in 1836, and also to a boring at the London and North-Western Railway Station about ten years later. At these spots the beds beneath the Liassic series consisted of sandstones and marls, and were considered to be of Triassic age.

Palæozoic rocks were met with in two borings undertaken by the Northampton Water Company, who attempted to reach the Waterstones by piercing the upper beds of the Trias. The first boring was situated between the sites of the two previous investigations, on the Kettering road, near the town. The Upper, Middle and Lower Lias here attain a thickness of 738 feet, and below them a series of conglomerates, sandstones and marls rested upon an eroded surface of a Carboniferous dolomite which passed into limestone crowded with characteristic fossils. The beds above the dolomite are not true Trias, but may represent local deposits of that age; 46 feet of Carboniferous strata were drilled, and the boring was discontinued at 851 feet.

The second boring was at Gayton, five miles south-west of Northampton. The Middle and Lower Lias were 581 feet in thickness, and were succeeded by the White Lias and Rhætic shales, the latter containing the black shales and bone-bed. The Trias was here discovered, but only 60 feet in thickness, the Waterstones being absent. Then followed 20 feet of littoral beds containing fragments of Carboniferous Limestone (from which more than 20 species of fossils were named by Mr. R. Etheridge, F.R.S.), resting, at 699 feet, upon an eroded surface of Carboniferous Limestone, dipping at an angle of  $45^{\circ}$ , but in what direction was not ascertained. The beds between this point and 889 feet consisted of a series of limestones and dark shales 79 feet, grey sandstones and grits 40 feet, red marls and sandstones 71 feet. The last fossils were observed at 889 feet. The boring was continued to a depth of 944 feet. The last 105 feet was composed of coarse red sandstones and marls with several bands of hard grits. These grits had been examined microscopically by Prof. Bonney, whose notes were given. The above series may represent the Old Red Sandstone, or may be only a local development of the lower beds of the Carboniferous; however, their materials have probably been derived from a mass of granitoid rocks belonging to some of the most ancient in the Archæan series. Saline water was met with in both borings.

A description was also given of an unsuccessful boring for coal at Orton, near Kettering. Beneath the Lias clays, 666 feet in thickness, the White Lias and Rhætic were discovered, followed by a sandstone and breccia resting upon an eroded surface of a quartz-felsite at 715 feet. The boring was discontinued at a depth of 789 feet in this rock. The quartz-felsite had been examined by Prof. Bonney, who expressed an opinion that it was similar to rocks of the volcanic group of Charnwood Forest, 25 miles to the north-east. The old land surface had thus been proved at the three borings, at Gayton dipping rapidly, and probably being the edge of a syncline, in which coal may yet be discovered to the south or south-west, beneath the overlying Mesozoic formations.

2. "On some Zaphrentoid Corals from British Devonian Beds." By A. Champernowne, Esq., M.A., F.G.S.

In this paper several sections of Corals from the Devonian system were described. They were referred to eight species of *Zaphrentis* (two being, perhaps, rather referable to *Amplexus*), one of *Campophyllum* (?), one of *Lophophyllum* (?), one of *Amplexus*, and one of *Cyathophyllum* (?). The *Amplexus* was identified with *A. tortuosus*, Phillips; two species of *Zaphrentis* were provisionally named *Z. calceoloides* and *Z. subgigantea* (the last being possibly a form of *Z. gigantea*, Lesueur); and for the *Cyathophyllum* the name *C. bilaterale* was suggested. For the remaining forms no specific names were proposed.

It was shown that the genus *Zaphrentis* is better represented in British Devonian beds than had hitherto been supposed. At the same time some corals exhibiting bilateral symmetry, and which the author himself had at first taken for Zaphrentidæ, belong to other families. It was shown that the corals of the family in question are distinguished by successive complete floors, well-defined septal characters, notably the discontinuity of the septa as vertical plates where arrested by the floors, the rudimentary condition of the secondary septa, the almost complete absence of vesicular endotheca, and, lastly, the septal fossula and other signs, internal and external, of bilateral or, more rarely, quadripartite symmetry.

3. "On the internal Structure of *Micrabacia coronula*, Gold., sp., and its classificatory Position." By Prof. P. Martin Duncan, M.B.

*Fungia coronula*, Goldf., a characteristic newer Greensand Coral, found at Warminster and near Dunstable in England, and in the beds of Essen and Le Mans, is the type of the genus *Micrabacia* of Milne-Edwards and Haime, and the external characters have been carefully and accurately described by those authors. They placed the genus in the family of Aporose Corals called Fungidæ by Dana, and in the subfamily Funginæ, near the genus *Fungia* (as restricted by Dana).

The author finds that the internal structure of *Micrabacia coronula*, which he has examined carefully, confirms MM. Milne-Edwards and Haime's view of the classificatory relations of this species. After describing the characters of the base, costæ, septa, and synapticulæ in detail, he finds that there is no theca or true wall. He gives the following amended description of the genus *Micrabacia*. Corallum simple, lenticular, convex above, slightly hollowed out below, resting on the edge of the basal disk. Costæ delicate, simply granular, bifurcating at the calicular margin. Intercostal spaces crossed by synapticulæ, and having a regular series of openings leading upwards into the interseptal loculi. Septa continuous with the intercostal spaces, and formed by the junction of a process from the two nearest costæ arched, denticulate, solid, unequal. Synapticulæ well developed in series, continuous or discontinuous, terminating moderately high up on the interrupted loculi, and ending as intercostal bars having canal-like spaces between them. Columella rudimentary.

The genus differs from *Fungia* in having the spaces on the intercostal grooves and the bars of the synapticulæ regular.

Some small corals lately brought from the Korean Sea have the shape, synapticulate arrangement and bifurcating costæ of *Micrabacia*; but the corallum resembles in its bipartite unsymmetrical growth the genus *Dioseris* of the Lophoserinæ.

*Micrabacia Fittoni*, described by the author in 1866, from the Gault, is placed in the same genus as *M. coronula* with much doubt. The type has been mislaid, and the figures exhibit characters some of which resemble those of *M. coronula*; but in the absence of the specimen, it is not quite certain what are the structures represented.

4. "A Correction in the assumed Amount of Energy developed by the secular Cooling of the Earth as stated in two Papers by the late Robert Mallet, M.A., F.R.S., in the 'Philosophical Transactions,' 1874-5." By W. F. Stanley, Esq., F.G.S.

According to Mr. Mallet, the amount of heat lost from the initial temperature of the earth will represent the force of its contraction. To this force he attributes the inclination and crumpling of strata, together with all volcanic phenomena. He states that the calculations of Elie de Beaumont, Forbes, and Sir William Thomson, 0·0065, 0·007, and 0·0085 millim. respectively, represent the thickness of a plate of ice covering the earth, which, melted, would equal the heat lost annually. From these data he calculates that from 575 to 777 cubic miles of ice, melted, would represent the loss of heat. This calculation was shown to be entirely in error. According to the data an amount of energy represented by the melting of from ·7937 to 1·0387 cubic mile of ice only would be dissipated, or about a 700th part of the amount estimated by Mr. Mallet.

II.—June 25, 1884.—Prof. T. G. Bonney, President, in the Chair.

1. "Additional Notes on the Jurassic Rocks which underlie London." By Prof. John W. Judd, F.R.S., Sec. G.S.

Since the reading of the former paper on the subject (February 6, 1884), the well-boring at Richmond has been carried to a depth of more than 1360 feet. The point reached is, reckoning from Ordnance-datum line, 220 feet lower than that attained by any other boring in the London basin.

A temporary cessation of the work has permitted Mr. Collett Homersham to make a more exact determination of the underground temperature at Richmond. At a depth of 1337 feet from the surface, this was found to be  $75\frac{1}{2}^{\circ}$  F., corresponding to a rise of temperature of  $1^{\circ}$  F. for every 52·43 feet of descent.

The boring is still being carried on in the same red sandstones and "marls," exhibiting much false-bedding, which were described in the previous communication.

The Rev. H. H. Winwood, of Bath, has had the good fortune to find the original fossils obtained by the late Mr. C. Moore from the Oolitic Limestone in the boring at Meux's Brewery in 1878. A careful study of these proves that though less numerous and in a far less perfect state of preservation than the fossils from the Richmond well, they in many cases belong to the same species, and demonstrate the Great Oolite age of the strata in which they occurred.

2. "On some Fossil Calcsponges from the Well-boring at Richmond, Surrey." By Dr. G. J. Hinde, F.G.S.

Numerous specimens of diminutive sponges were met with in a band of calcareous shale in the Richmond well-boring, at a depth of 1205 feet beneath the surface. They proved to be all Calcsponges belonging to Zittel's family of Pharetrones. Five species, all new, were described, and referred to the genera *Inobolia*, *Peronella*, *Blastinia*, and *Oculospongia*. The spicular structure of the fibres can be seen in microscopic sections of the different species, and in some examples even the spicules of the dermal layer are preserved. From the general facies of the specimens, and the fact that one species is closely allied to *Blastinia costata*, Goldf., from Lower Jurassic strata at Streitberg, the author thought it probable that the stratum in which the sponges occur is of Lower Jurassic age.

3. "On the Foraminifera and Ostracoda from the Deep Boring at Richmond." By Prof. T. Rupert Jones, F.R.S., F.G.S.

From some strata at three special depths (§ i. 1145' 9" to 1146' 6"; § ii. 1151' to 1151' 6"; and § iii. 1205') in the deep boring at Richmond, several Foraminifera and Ostracoda have been obtained by Prof. Judd, but they do not present any very special characteristics recognizable as belonging to particular horizons. The Foraminifera comprise several common forms or varieties of *Cristellaria*, *C. rotulata* occurring at each of the depths alluded to. Specimens of the Nodosarinæ occur very rarely in the lowest stratum of the three; also *Spirillina*, *Pulvinulina* (of the *elegans* type), several small individuals of *Planorbulina Haidingeri*, and vars., and one small *Miliola*.

Of the Ostracoda there are several forms not previously published; and, for the most part, they differ in the three stages alluded to; but one *Cythere* occurs in § i., § ii., and § iii.; one in § i. and § iii.; and a *Cytherella* in § ii. and § iii.

Excepting a general Upper Mesozoic aspect, these limited groups offer no special characteristic so far as yet examined.

4. "Polyzoa (Bryozoa) found in the Boring at Richmond, Surrey, referred to by Prof. J. W. Judd, F.R.S." By G. R. Vine, Esq. Communicated by Prof. Judd, F.R.S., Sec. G.S.

The Bryozoa from the Richmond well, which are in an admirable state of preservation, include no less than 14 different forms, most of which are characteristic of the Great Oolite of this country, and the Continent. Two or three forms, however, are new, and detailed descriptions were given of them in the present paper. Six of the forms found at Richmond occur also among the fossils collected by the late Mr. C. Moore from the Oolitic rock met with in the boring at Messrs. Meux's brewery.

5. "On a new species of *Conoceras* from the Llanvirn beds, Aberiddy, Pembrokehire." By T. Roberts, B.A., F.G.S.

This new species of *Conoceras* was obtained by the author from a new quarry about half a mile to the north-west of the Llanvirn quarry, Aberiddy.

The fossil consists in great part of a mould of the shell, together

with a much compressed, obliquely cut, longitudinal section of the shell itself, which can be removed from its mould. On the posterior part of the fossil the course of the sutures of the septa can be fairly well seen: after passing upwards for a short distance, the sutures bend forward, and, meeting those from the opposite side, which are similarly bent, form a band of superposed chevrons, situated mesially in this part of the fossil. When the shell is removed from its mould, the chevron band appears to be distorted, and is then continued forward as a narrow, partly disconnected groove, to the anterior margin of the fossil. There is a ridge on the shell itself corresponding to this groove, which the author considers to be the siphuncle.

On the anterior part of the fossil coarse corrugations are present which correspond to the lines of growth of the shell. The body-chamber is not preserved.

Only 5 species of *Conoceras* have as yet been described; the author compared the Llanvirn species with these, and also with a fossil from the Devonian of Nassau, which Kayser referred to *Gomphoceras*, but which possesses several characters in common with *Conoceras*.

The horizon from which this new species was obtained was that of the Llanvirn Beds, some typical Llanvirn fossils having been found with it. The author named the species *Conoceras Llanvirnensis*.

6. "Fossil Cyclostomatous Bryozoa from Australia." By A. W. Waters, Esq., F.G.S.

In the present paper the Cyclostomata from Curdies Creek, Mount Gambier, Bairnsdale, Muddy Creek, etc., Aldinga and River-Murray Cliffs were described, bringing the total number of fossil Bryozoa from Australia, dealt with in this series of papers, up to 195, of which 85 are known living. Of the 32 Cyclostomata now dealt with, 12 at least are known living, and one cannot be distinguished from a Palæozoic form; 9 are apparently identical with European Cretaceous fossils.

Although so many remind us of European Chalk and Miocene species, great stress was laid upon the imperfect data available for such comparisons, the Cyclostomata furnishing but few characters which are available for classification, which, so far, has almost entirely been based upon the mode of growth, which, in the Chilostomata, has been shown to be of secondary value. In consequence of the few available characters the Cyclostomata do not seem likely to be ever as useful palæontologically as the Chilostomata, and as they are less highly differentiated, it is not surprising to find that they are more persistent through various periods.

In order to see how far other characters might be available, the author has examined Cyclostomata, both recent and fossil, from many localities and strata, and pointed out that the size of the zoecia should always be noticed, as also the position of the closure of this tube. The arrangement of the interzoecial pores may frequently give great assistance, and these are considered the equivalents of the rosette-plates; but the most useful character of all is no doubt the ovicell, which varies specifically in position and structure;



but this unfortunately occurs on but few specimens, and has rarely been described fossil, although greater attention to this will no doubt lead to its being frequently found and noticed.

7. "Observations on certain Tertiary Formations at the South Base of the Alps, in North Italy." By Lt.-Col. H. H. Godwin-Austen.

In a visit to some of the moraines on the south side of the Alps, the author's attention was drawn to certain Tertiary beds underlying the glacial deposits at Ivrea, and near the Lago d'Orta at Boca, Maggiore, and especially at Buccione, south of Orta, and close to the southern extremity of the lake. Here there is a small remnant of micaceous sands containing older Pliocene marine fossils. The species have been determined by Dr. Gwyn Jeffreys, and a list was appended to the paper. The patch of Pliocene beds has apparently been protected by the porphyritic mass on which the old tower of Buccione stands; the remainder of the Tertiary strata, which formerly must have extended northward to the Soce Valley, have been swept away by the ice of the Glacial period.

The deposits at Boca and Maggiore were also described in some detail. They are probably Newer Pliocene.

Near Ivrea the most interesting section seen was at Strambinello, on the banks of the Chiusella. Here on both banks of the stream horizontal Pliocene beds, containing marine shells, are exposed resting on diorite. On the south bank the Pliocene is broken up and mixed with diorite fragments. Moraine overlies the Pliocene. The great Dora Baltea glacier swept across the gorge of the Chiusella, and only left a remnant of the marine beds where protected by the ravine.

The Pliocene sea probably extended along the south base of the Alps, extending in long gulfs up the valleys, out of which the marine deposits have been swept by the ice, except in a few protected spots.

The paper concluded with a notice of some fossiliferous gritty marl seen in a ravine close to Dormiletto on Lago Maggiore. Although probably *in situ*, the mass was not sufficiently exposed to show its relations to the surrounding rocks.

8. "On the Geological Position of the Weka-pass Stone." By Capt. F. W. Hutton, F.G.S.

The beds described in this paper are of older Tertiary and newer Secondary age, and occur in the northern part of Ashley county, in the province of Canterbury, between the Hurinui and Waipara rivers. All of the beds are met with at Weka Pass, on the railway and road between Christchurch and Nelson, and the following is the section in descending order:—

1. Mount-Brown beds; pale yellowish sandstone with bands of shells and coral limestone, considered by all New Zealand geologists Upper Eocene or Oligocene.
2. Grey sandy marl.
3. Weka-pass stone, yellowish with arenaceous limestone, usually with small green grains.
4. Amori limestone, white, flaggy, and argillaceous.
5. Green sandstone, with remains of marine Saurians.

The last rests conformably on beds of coal and shale, with leaves of Dicotyledonous Angiosperms, forming the base of the Waipara system. To this system Nos. 4 and 5 of the above section have also been referred by Dr. von Haast and the writer. The upper beds are the Oamara system of the same authors. The question to be decided is the limit between the two. The green sandstone (No. 5) and the coal shales are generally admitted to be Cretaceous.

The geographical distribution of the beds enumerated was briefly described, the grey sandy marl (No. 2), the Amori limestone (No. 4), and the green sandstone having a northerly extension to Cook's Straits, whilst the other beds have been traced to the south only. An examination of the stratigraphical evidence shows that at Weka Pass, and also on the Waipara, the Weka-pass stone rests on a waterworn surface of the Amori limestone, and near the Pass the former overlaps the latter. The grey marl (No. 2) is evidently unconformable to the lower beds of the Waipara system, whilst at Waipara and Weka Pass it passes down conformably into the Weka-pass stone. The grey marl also passes up conformably into the Mount-Brown beds. The author concludes that the break in succession is between the Weka-pass stone and the Amori limestone.

The geological evidence is in accordance with the palæontological data. The fossils hitherto found in the Weka-pass stone (*Voluta elongata*, *Scalardia rotunda*, *Struthiolaria senex*, *Pecten Hochstetteri*, *Meoma Crawfordi*, *Schizaster rotundatus*, and *Flabellum circulare*) are found in other parts of New Zealand in Upper Eocene beds. None of them are known from the Cretaceous Waipara system. The fossils from the grey marl are also in some cases identical with those found in the Mount-Brown beds.

The author concluded by giving reasons for not agreeing with Dr. Hector, who classes all the beds mentioned as belonging to one system of Cretaceous-Tertiary age.

9. "On the Chemical and Microscopical Characters of the Whin Sill." By J. J. H. Teall, Esq., F.G.S.

The Whin Sill is an intrusive sheet of basic igneous rock which occurs in the Lower Carboniferous strata of the north of England. It is remarkably uniform in character, the principal varieties evidently depending merely on the conditions of consolidation. Close to the junctions the rock is compact; the dominant variety, however, is of a grey or bluish-grey colour and medium grain. Irregular masses of a very coarse variety, characterized by long flat prisms of pyroxene measuring an inch or more in length, occur here and there in the dominant medium-grained rock.

The principal constituents of the rock of the Whin Sill are plagioclase felspar, a pyroxene having certain special characters, and a magnetic titaniferous iron-oxide. Apatite is invariably present in very small quantity. Interstitial matter may generally be recognized, also in very small quantity; in the coarser varieties this interstitial matter takes the form of micropegmatite. The accessory constituents are a rhombic pyroxene (bronzite), hornblende, biotite, pyrite, and various green decomposition-products. Olivine has not been

detected by the author, either as a fresh mineral or in the condition of a pseudomorph. The three principal constituents have been isolated by means of the Sonstadt solution and a weak bar-magnet, and separate analyses are given in the paper. The felspar, if of one species, must be allied to andesine; the opaque iron-ore is strongly magnetic, and contains 33 per cent. of titanitic acid. The prevailing pyroxene develops a laminated structure, parallel to the basal plane, by alteration. In composition it deviates in the most marked manner from the rule laid down by Tschermak,  $Mg+Fe$  being greater than  $Ca$ . Bulk-analyses of two specimens of the Whin Sill were given, and one of these was calculated out by means of the data supplied by the separate analyses of the three principal constituents.

The rock presents many points of resemblance to the continental diabases. It comes nearest to certain Swedish diabases described by Törnebohm and to the great masses of trap which occur in the Mesozoic strata of the Atlantic border of North America.

10. "A Critical and Descriptive List of the Oolitic Madreporaria of the Boulonnais." By R. F. Tomes, Esq., F.G.S.

The author commenced with some general remarks upon certain Oolitic genera of Corals, especially *Bathycœnia*, *Cyathophora*, and *Depaphyllum*. He stated that his observations upon the Corals of the Great Oolite of the Boulonnais confirm the conclusions as to the palæontological uniformity of that formation based by Dr. Lycett chiefly on the study of the Mollusca. In the Boulogne district the Great Oolite rests immediately upon Palæozoic rocks, and there are no traces of any Corals of Inferior-Oolite type. Those met with near the bottom of the Great Oolite seem to approach those of the English Cornbrash. After a tabular sketch of the different beds of Oolitic age in the Boulonnais, the author gave a list of the species as follows:

From the Great Oolite:—(Eusmilinæ): *Discocœnia bononiensis*, g. & sp. n.; *Ceratocœnia elongata*, g. & sp. n.; *Scyphocœnia stamini-fera* and *excelsa*, g. & sp. n.; *Bathycœnia hemisphærica*, sp. n.; *Convexastrœa Waltoni*, E. & H.; *Cryptocœnia obeliscus*, Mich.; *C. plana*, sp. n.; *C. Rigauxi*, sp. n.; *C. microphylla*, Tomes; *Stylina*, sp.;—(Astræinæ): *Montivaltia caryophyllata*, Lamx.; *M. Rigauxi*, sp. n.; *Cladophyllia Babeana*, E. & H.; *Septastrœa rigida*, sp. n.; *Confusastrœa Rigauxi*, sp. n.; *C. magnifica*, Tomes; *Confusastrœa*, sp.; *Isastrœa limitata*, Lamx.; *I. explanata*, Goldf.; *I. tuberosa*, sp. n.; *Latimœandra*, sp.; *L. lotharinga*, From.;—(Poritidæ): *Thamnastrœa mammosa*, E. & H.; *Anabacia complanata*, Defr.; *A. Bouchardi*, E. & H.; *Genabacia stellifera*, E. & H.; *Microsolena excelsa*, E. & H. From the Coral Rag:—(Eusmilinæ): *Stylina*, 2 sp.;—(Astræinæ): *Calamophyllia pseudostylina*, Mich.; *Rhabdophyllia Phillipsi*, E. & H.; *Thecosmilia annularis*, E. & H.; *Confusastrœa*, sp.; *Dimorphophyllia jurensis*, Beck.; *Latimœandra sequana*, From.; *Isastrœa explanata*, Goldf.; *I. helianthoides*, Goldf.; *I. portlandica*, From.;—(Fungidæ): *Trochoseris oolitica*, sp. n.;—(Poritidæ): *Thamnastrœa? latimœandroidea*, sp. n.; *T.? concinna*, Goldf.; *T. foliacea*, Quenst.;

*T. gibbosa*, Beck. ; *Microsolena expansa*, E. & H. ; and *Comoseris irradians*, E. & H.

11. "On the Structure and Affinities of the Family Receptaculitidæ, including therein the Genera *Ischadites*, Murch. (= *Tetragonis*, Eichw.), *Sphærospongia*, Pengelly, *Acanthochonia*, g. n., and *Receptaculites*, DeFr." By Dr. G. J. Hinde, F.G.S.

The author's observations have been derived from the study of numerous examples of the family from Silurian and Devonian strata in Devonshire, the West of England, Belgium, Silesia, Bohemia, the isle of Gotland, Canada, and the United States. In an historical sketch the author showed that the members of this group have been at various times referred to pine-cones, Foraminifera, sponges, corals, cystideans, and tunicate Mollusca, and that the latest authorities who have written on them consider their systematic position as altogether doubtful.

The present mineral constitution of these fossils is either of crystalline calcite, silica in a secondary condition, iron peroxide, or iron pyrites, or they occur as empty moulds, and from the similarity to the present mineral condition of undoubted siliceous sponges, the author thinks that the Receptaculitidæ were also originally siliceous. The skeleton of the members of the group consists of modified hexactinellid spicules, in which the summit-ray of the spicule is changed into a rhomboidal or hexagonal plate with the four horizontal rays or arms immediately beneath it, whilst the vertical ray or shaft tapers to a point, and terminates freely in *Ischadites* and *Acanthochonia*; in *Sphærospongia* it is partially absorbed; and in *Receptaculites* it develops a plate at its distal extremity. The spicular rays are traversed by axial canals, as in other hexactinellid spicules, and these unite in the central point of junction of the rays. The spicules are definitely arranged so that their summit-plates form regularly oblique rows crossing each other, and the horizontal rays radiating and transverse rows.

The genus *Ischadites* consists of conical or ovate bodies inclosing a central cloacal cavity with a summit-aperture. The basal nucleus or commencement of growth consists of eight small spicules arranged in a circle; the spicule-plates are rhomboidal; there is no inner plate, as in *Receptaculites*. The genus *Tetragonis*, Eichw., is undoubtedly congeneric with *Ischadites*, and, being of later date, becomes obsolete. *Acanthochonia*, g. n., resembles *Ischadites* in spicular structure, but it is open cup-shaped; it is formed to include a single species, named *A. Barrandei*, from Bubowitz, in Bohemia. The genus *Sphærospongia*, Pengelly (pars Salter), has hexagonal summit-plates, and the vertical spicular rays are only partially developed. The genus *Receptaculites* is cup-shaped; the spicular plates are rhomboidal, and the vertical rays develop at their extremities definite plates, which apparently amalgamate into a continuous perforated layer. The author concluded that the Receptaculitidæ constitute a distinct family of siliceous hexactinellid sponges, whose nearest relationships are to *Protospongia*, *Dictyophyton*, and *Plectoderma*.

The genera *Cyclocrinus*, Eichw. (= *Nidulites*, Salter), *Pasceolus*,

Billings, and *Archæocyathus*, Bill., though ranged with the Receptaculitidæ by some authors, were shown to have no structural relationship to that family.

12. "On the Pliocene Mammalian Fauna of the Val d'Arno." By Dr. C. J. Forsyth-Major. Communicated by W. Boyd Dawkins.

A list of the fossil Mammalia was given, containing the names of thirty-nine species known to the author. This list contains no species common to the older fauna on the limit between Miocene and Pliocene, a fauna characterized by the presence of *Hipparion* and met with at Pikermi, Eppelsheim, and other places. The Montpellier fauna contains an admixture of older and newer types; but it is not clear that this admixture has not taken place after extraction. Some Val d'Arno types extend to the Sewaliks of Northern India, for *Equus Stenonis* and *Sus Strozzi* of the former are probably the same as *E. sivalensis* and *Sus giganteus* of the latter.

It has been asserted that the marine Pliocene of Italy is older than the lacustrine strata of the Arno valley. This, however, is not the case; some of the mammalian species found in the latter occur also in shore-deposits belonging to the first named.

The Pleistocene fauna in Italy appears to be quite distinct specifically from the Pliocene. Portions of both, however (often designated the African division), appear to be closely allied. This is especially the case with certain forms of *Hyæna*, *Felis*, *Rhinoceros*, and *Hippopotamus*. Some of the differences between species of the two last-named genera were discussed.

The relations of the Arno-valley fauna to living Mammalia were next considered, and it was shown that although some genera, as *Hippopotamus*, are only met with living in the Ethiopian region, a much larger number of forms, such as *Tapirus* and several bovine and cervine species, are now represented in south-eastern Asia and the Sunda islands. The occurrence of these animals in tropical countries at the present day does not, however, necessarily imply a tropical climate in Pliocene Italy. Some instances in modern geographical distribution are quoted in illustration of this opinion. It is probable that the Pliocene fauna of Europe extended as far as Celebes, and has been preserved in the Indian archipelago by isolation.

In conclusion it was shown that the preservation of a Miocene form, *Myolagus sardonis*, in the Pleistocene bone-breccias of Corsica and Sardinia, and the occurrence of *Elephas meridionalis* and *Mastodon arvernensis* in beds of different age on opposite sides of the Alps, are instances in support of the view that a single mammalian species or even a few species cannot be sufficient to determine the age of beds.

In a note appended to the paper, Prof. Boyd Dawkins contested the opinion that no species pass from Miocene to Pleistocene beds, especially in the case of *Hippopotamus major* of the former and *H. amphibius* of the latter.

13. "Notes on the Geology and Mineralogy of Madagascar." By Dr. G. W. Parker. Communicated by F. W. Rudler, Esq., F.G.S.

This paper commenced with a sketch of the physical geography of

the island of Madagascar. A central plateau from 4000 to 5000 feet high occupies about half the island, rising above the lowlands that skirt the coasts, and from this plateau rise in turn a number of volcanic cones, the highest, Ankaratra, being 8950 feet above the sea. With the exception of certain legends, there is no record of a period when the volcanoes were active: two such legends were given.

The known volcanic cones were enumerated. They extend from the northern extremity of the island to the 20th parallel of south latitude. Beyond this granite and other primitive rocks occur as far as lat. 22°, south of which the central parts of Madagascar are practically unknown to Europeans.

Some crater-lakes and numerous hot and mineral springs occur.

Earthquakes are occasionally felt in the island, most frequently in the months of September and October. The shocks are generally slight. Only a single trap-dyke is known near Antananarivo. The hills around this city are of varieties of granite (? granitoid gneiss). The general direction of the strata is parallel to the long axis of the island. Marine fossils have been found by Rev. J. Richardson and M. Grandidier in the south-west part of the central plateau. These fossils are referred by the last-named traveller to the Jurassic system. Remains of *Hippopotami*, gigantic Tortoises, and an extinct Ostrich-like bird have also been recorded. North and north-west of the fossiliferous rocks, between them and the volcanic district of Anakaratra, sandstone and slate occur. North of this volcanic district again is a tract of country in which silver-lead (mixed with zinc) and copper are found.

Near the north-western edge of the central plateau are granitic escarpments facing northwards and about 500 feet high. Some details were also given of valleys through the central plateau and of lagoons within the coral reefs on the coasts. To these remarks succeeded some details of the physical features exhibited by the province of Imerina as seen from Antananarivo.

14. "Notes on some Cretaceous Lichenoporidæ." By G. R. Vine, Esq. Communicated by Prof. P. Martin Duncan, F.R.S., F.G.S.

In this paper the author referred to the views of Mr. Hincks on the genera belonging to the family Lichenoporidæ, and especially to his suppression of the genus *Radiopora* of D'Orbigny, the species of which are placed by Mr. Hincks in the genus *Lichenopora*. The author remarked that the type species of the division of the latter genus identified by Mr. Hincks with *Radiopora*, D'Orb., the Lower Greensand *Radiopora pustulosa*, D'Orb., and other fossil species, show structural peculiarities which would seem to distinguish them, although perhaps not generically. He described in some detail the characters of the above-mentioned species under the name of *Lichenopora pustulosa*; and further described what he believed to be a new species from the Greensand of an unknown locality under that of *Lichenopora paucipora*.

THE  
GEOLOGICAL MAGAZINE.

NEW SERIES. DECADE III. VOL. I.

No. IX.—SEPTEMBER, 1884.

ORIGINAL ARTICLES.

I.—NOTES ON THE GEOLOGY OF EGYPT.<sup>1</sup>

By Professor J. W. DAWSON, C.M.G., LL.D., F.R.S., F.G.S., etc.  
Principal of McGill College, Montreal.

II.—*Tertiary Deposits Later than the Eocene.*

THE mass called Jebel Ahmar or the Red Mountain near Cairo, whose slopes consist of an immense accumulation of quarry rubbish, is composed of hard brown, reddish and white sandstone and siliceous conglomerate. In many parts it has the characters of a perfect quartzite, and appears at first sight extremely unlike a member of the Tertiary series, newer than the comparatively soft and unaltered Eocene beds on which it rests, apparently in a conformable manner, though its dip to the N.E. is somewhat irregular, and apparently affected by false bedding. The induration of the beds seems to be local, and to be connected with certain fumarole-like openings which have probably been outlets of geysers or hot siliceous springs, contemporaneous with the deposition of the sand.<sup>2</sup> Zittel I believe first gave this explanation, which suggested itself to me before noticing it in his memoir.

This mass is evidently a remnant of a formation at one time extensively distributed in this part of Egypt. This is shown by the fact that silicified trunks of trees, whose natural bed is in the lower part of this formation, near its junction with the underlying Eocene, are found scattered over the surface, not only in the great and little "petrified forests," but at Helouan, and even on the Lybian desert on the opposite side of the Nile. Only the portions locally indurated by siliceous waters have escaped denudation, and it is the irregular appearance presented by these that has given the vague idea of a volcanic origin of these masses to so many travellers.

There has been much speculation as to the mode of deposition of the silicified wood;<sup>3</sup> but I think the study of it, as it exists in situ at Jebel Ahmar, is sufficient to set them at rest. It occurs in prostrate trunks, sometimes flattened and imperfectly preserved, and sometimes perfectly silicified, and occasionally lying in disintegrated cuboidal fragments, showing that the wood was imbedded in its natural state and in a decayed condition, and afterwards

<sup>1</sup> See also former article, "Geology of the Nile Valley," pp. 289-292.

<sup>2</sup> Zittel, *Lybischen Wüste*.

<sup>3</sup> Schweinfurth, *Proc. German Geol. Soc.* 1883.

silicified. I consider the appearance decisive as to this point.<sup>1</sup> On the other hand, I could see no evidence that the trees are actually in the place of their growth. There seemed to be no "dirt-bed" or fossil soil. It seems probable, therefore, that the sand which was ultimately derived from the crystalline rocks of the interior, and perhaps proximately from the waste of the Nubian sandstone and the sandy Upper Eocene beds, was deposited in the vicinity of a wooded coast, or at the mouth of a river flowing through a wooded country, and that the trees are drift trunks imbedded in it. Their silicification is no doubt due to the presence of the siliceous springs to which the sand itself owes its induration. These springs, and perhaps also to some extent the deposition of the sandstone itself and its contained trees, may have been indirectly connected with the Tertiary volcanic phenomena which Schweinfurth has discovered<sup>2</sup> elsewhere in Lower Egypt. The thickness of these sandstones near Cairo must be about 100 feet.

The fossil wood of Jebel Ahmar and the petrified forests have been examined and partially described by various authors.<sup>3</sup> It includes several species of *Nicolia*, also Conifers and a Palm. Its affinities have been discussed by Botanists, and it may be regarded as an African Flora allied to that of the Soudan, and not improbably of Miocene age.<sup>4</sup>

It may be worthy of remark that while this hard sandstone is now used only for millstones and for macadamizing the roads, it furnished to the ancient Egyptians the material of some of their most enduring sculptures. A curious shrine with a sphinx in the centre cut out of the same block, found in the temple of Tum at the site of the ancient Pithom, near Ismalia, is of this stone. Two large sacrificial tables in the Boulak Museum are of the white variety of the same stone, and are remarkable examples of the working on a large scale of a perfect quartzite. One of the colossi in front of the south propylon of Karnak is a monolith of similar material. Each of six colossi in front of this propylon was made of a different kind of stone, representing quarries in different parts of Egypt, and the one sculptured in this hard and refractory rock shows the bands of flint pebbles cut through and polished, along with the paste which is nearly as hard as themselves.

The convenient name of "*Nicolia* Sandstone" has been bestowed on this formation by Zittel. Its relation to the underlying Eocene beds appears in the Section Fig. 1, which also indicates the supposed outlets of hot springs and the horizon of the silicified wood, which, when laid bare by the denudation of its matrix, constitutes the so-called "petrified forests" of the deserts near Cairo.

Zittel has described extensive areas of Miocene deposits in the Lybian desert west of the Nile, and in the neighbourhood of Jebel

<sup>1</sup> Newbold, Quart. Journ. Geol. Soc. 1848, vol. iv. states the same conclusion, p. 353.

<sup>2</sup> Beyrich, Proceedings Royal Academy of Berlin, 1882.

<sup>3</sup> R. Brown, Quart. Journ. Geol. Soc. iv. Carruthers, GEOL. MAG. Vol. VII. p. 306. Unger and Schenk,—Zittel, Lybischen Wüste.

<sup>4</sup> Schweinfurth, Proc. German Geol. Soc. 1883.



Seneffeh, north of Suez, Fraas has found similar beds, but which do not appear to be very extensive in their distribution. I had no opportunity to study these formations, but their chief point of interest

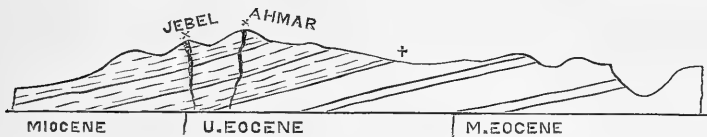


FIG. 1.—Relation of the Miocene Sandstone of Jebel Ahmar to the Eocene of the base of the Mokattam Hill. (x x) Supposed Geyser pipes.  
(+) Here row of fossil trees.

appears to lie in the fact that they occupy low grounds resulting from the partial removal of the Eocene, which seems to have experienced both elevation and marine denudation before they were deposited. These Miocene beds have sometimes been confounded with the raised beaches and terraces holding *Ostrea Forskali*, and with the *Clypeaster* sands near Gizeh, but these, as already stated, are probably considerably newer.

Another deposit, also newer than the Miocene, is that which occupies the highest part of the Isthmus of Suez, immediately north of Ismalia, and which has been described by Fraas and Le Vaillant.<sup>1</sup> Though occupying a narrow space at the Isthmus, these deposits extend to a considerable distance east and west, and as they are overlain at both sides of the Isthmus by more modern beds, may be of greater breadth than appears at the surface.

As they occur near Ismalia, and in the cuttings on the canal between that place and El Gisir, they consist of thin-bedded grey limestones with vermicular holes, in horizontal beds, and resting on marls, sands and clays with gypsum and nodules of chalcedony. The greater part of these beds are destitute of fossils; but in, or associated with, the series, there are layers holding freshwater shells, more especially *Ætheria Caillaudi*, Férussac, a species now confined to the Upper Nile. This species has been found by Le Vaillant as far south as the cutting on the Suez Canal at Shaluf el Terraba, and it also occurs north of Ismalia. This formation would seem to imply the discharge of the Nile or a considerable branch of it to the eastward, and this not into a marine estuary, but into a saline lake, or a lake at some times salt and at others fresh. The greater part of these deposits indeed greatly resemble those occurring in the elevated terraces of the Dead Sea. The deposition of these beds would also seem to have occurred at a time of continental elevation, when the isthmus was represented by a wide extent of land, and during the prevalence of a warm climate.

The date of these deposits must be placed between the Miocene period and the modern Red Sea and Mediterranean marine deposits which flank the isthmus on the south and north. But within these limits, we have two continental periods to decide between—that

<sup>1</sup> Aus dem Orient, Bul. Geol. Soc. of France vol. xxii. 1868.

of the Pliocene and that of the later Pleistocene or Post-Glacial. Between these periods there does not seem at present any certain evidence to decide; but perhaps the modern character of the fauna, so far as it goes, may rather incline the balance to the latter period. In this case we should have a fact pointing to the solution of the difficulties felt by Lartet and Günther respecting the identity of Jordan and Nile fishes. We should at least be in presence of a state of things in which the outlets of the Nile and the Jordan would be much nearer together than at present.

Since these "Isthmian" beds as we may name them for convenience, have been deposited, a submergence has occurred, in which the modern sandstones and clays which flank them were deposited, as those of the Red Sea at least rise to heights nearly as great as that of the Isthmian beds themselves. As seen near Suez, these beds, some of which have been sufficiently consolidated by infiltration to form a serviceable building stone, consist of ordinary and pebbly grey sandstones, holding modern shells, still retaining their colours and animal matter, on which are in places marls and clays holding gypsum and salt. Though some of these beds are as much as forty feet above the sea, others are at the sea-level, and may be still in process of deposition, more especially as certain low areas of the desert are covered with salt water, and receive additional deposits in high tides accompanied with storms, during which, I was informed, large areas of desert south of Suez are overflowed by the sea. Between Suez and Jebel Attaka we rode over extensive tracts of low desert, which we were assured were occasionally overflowed in this way. These desert surfaces were in many places strewn with recent shells, while workmen were quarrying, at and near the sea-level, modern sandstone holding similar shells, and which was being employed in building a pier at Suez.

### III.—*Eocene and Cretaceous Geology.*

Eocene beds occur on both sides of the Nile, from Cairo to El Kab near Edfou, and have been very well described by several geologists, more especially by Fraas and Zittel. They are largely or dominantly calcareous, and rich in *Nummulites* in their middle portion. According to Zittel they attain to the thickness of 760 mètres, of which nearly one-third, or 600 feet in vertical thickness, can be seen in the single section of the Mokattam Hill, near Cairo.<sup>1</sup> In this section the Upper and Middle portions are there exposed. The lower part is to be seen in the vicinity of Thebes. (Fig. 2.)

Though these beds are nearly horizontal, or with only a slight northerly dip, they seem to be traversed by lines of fault, running approximately north and south and east and west, which sometimes change the relative positions of the beds. On the Arabian or Eastern side of the river, the beds have probably been supported by the subterranean extension of the old crystalline rocks of the hills between the Nile and the Red Sea, and are consequently more

<sup>1</sup> See Prof. J. Milne, *GEOL. MAG.* 1874, pp. 353-362; and review of Zittel's recent work, *GEOL. MAG.* 1884, pp. 172-179.

firm and regular. On the Lybian side they are more disturbed, and probably somewhat thrown down and fractured. This is well seen at Cairo and Gizeh on the opposite sides of the river. At the former place the beds seem undisturbed. At the latter they



FIG. 2.—Lower Eocene Limestone and Softer Beds near Thebes.

are much shifted by faults, so that in places the newer members of the series are brought down to the level of the middle portions. To the north, where the crystalline rocks terminate, the east and west fractures become more pronounced. A very important one seems to pass through the Wady Dugla, behind the Mokattam Hill, extending thence eastward toward the Red Sea. The north and south fractures have no doubt exercised an important influence in determining the position of the river valley, and their comparative absence on the eastern side has tended to give greater continuity and elevation to the cliffs on that side as far up as Thebes.

Clays, believed to belong to the lower part of the Eocene, appear beneath the limestones at Thebes, and between El Kab and Silsilis there are clays, marls, limestones and sandstones, which are said to contain Cretaceous fossils, and these rest on the Nubian sandstone to be noticed in the sequel. In the soft beds near Edfou, which

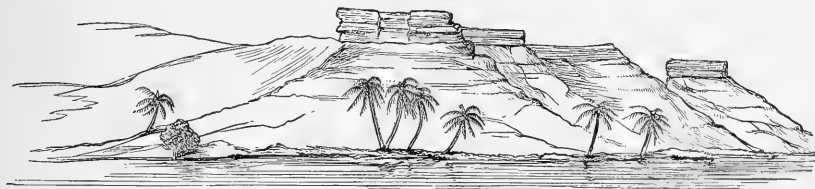


FIG. 3.—Cretaceous Sandstone and Marl above Silsilis.

are probably Cretaceous, and above the Nubian sandstone, borings made for coal have ascertained the existence in clays and sandy

beds of carbonized wood, striated leaves and stems resembling those of reeds. The Cretaceous formation does not, however, attain to so great a development in Egypt as in Syria, and this, I think, is an important point with reference to the attempts which have been made to correlate the rocks of the two regions. We shall best understand their true relations by studying a section geographically intermediate, which we may find on the shores of the Red Sea, sixty miles to the eastward of the great Mokattam section near Cairo.

Tracing the Mokattam range to the eastward, in Jebel Attaka on the Red Sea, it rises to a considerably greater elevation, and while its upper part consists of Eocene Limestone with *Nummulites*<sup>1</sup> and other characteristic fossils, its lower part is Cretaceous, and holds *Hippurites* and *Ostrea larva*. The Cretaceous here consists of hard limestones, not, in so far as I know, found in the Nile valley, but comparable with those seen farther east and north in Judea and the Lebanon, while the Eocene beds appear to be less highly developed and less purely calcareous than in the Nile. The structure of Jebel Attaka, in short, appears to afford a clue to the apparent anomalies of the distribution of the Cretaceous and Eocene in Egypt, Arabia, and Syria. It would seem that while in all these countries the Cretaceous and Eocene are conformable, and closely associated with each other, they have from the first been unequally deposited. The calcareous members of the Cretaceous, slenderly developed in Egypt, increase in volume on the Red Sea, and attain their maximum in Syria, while those of the Eocene show their greatest thickness in Egypt and become depauperated farther to the east. This is at least what appears to me the obvious explanation of the difficulties which have occurred in correlating the Cretaceous and Eocene beds of these countries.

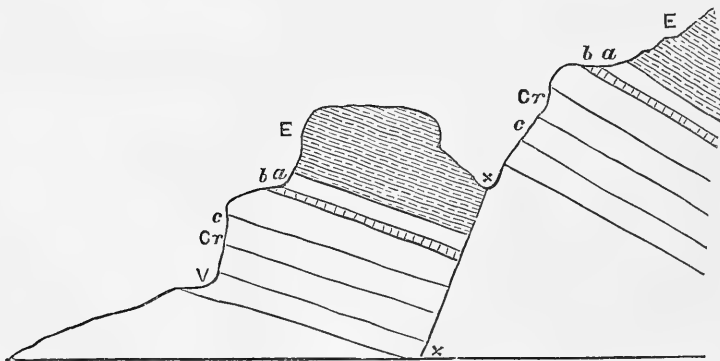


FIG. 4.—Section at Jebel Attaka, partly after Le Vaillant. (E) Eocene; (Cr) Cretaceous, including (a) White Chalky Limestone; (b) Red and Greenish Marl; (c) Hard Limestone and Dolomite with *Hippurites*, *Ostrea*, etc.; (v) Position of Quarry; (x x) Supposed Line of Fault.

<sup>1</sup> It has been stated that *Nummulites* do not occur here; but I was so fortunate as to find specimens of coarse limestone full of them.

M. Le Vaillant<sup>1</sup> has given a detailed section of the beds of Jebel Attaka, of which the following is a summary in descending order:

Eocene	.....	{ Dolomitic Limestone— <i>Potamides</i> and <i>Cerithium</i> (Holds also <i>Nummulites</i> and various Eocene bivalves).....	150 mètres.
		{ White Chalk .....	50 "
		{ Red Marly and Gypseous Band.....	7 "
		{ Alternations of Chalk and Dolomite.....	109 "
Cretaceous		{ White Chalk .....	2 "
		{ Dolomite—2 species of <i>Hippurites</i> , <i>Ostrea larva</i> , <i>Janira sexangularis</i> , <i>Exogyra</i> .....	53 "
		Total.....	371 "

If we compare this with the Egyptian section of Zittel, as given in this MAGAZINE (April, 1884), bearing in mind the fact that the Jebel Attaka section does not reach to the base of the Cretaceous, we shall be able to appreciate the different development of the formations, even within the space of sixty miles.

It would further appear that throughout the Eastern Mediterranean, there is no stratigraphical break between the Cretaceous and Eocene, while two periods of partial elevation and shallow-water conditions are represented by the Lignitiferous Zone of the Cretaceous, which occurs in the Lebanon as well as in Egypt, and by the argillaceous and gypseous beds near the top of the Eocene in Egypt. The periods of greatest limestone deposition would seem to have been in the Middle and Upper Cretaceous in Syria, and in the Middle Eocene in Egypt. These facts serve to illustrate the importance of a detailed study of rocks and fossils in each locality, before instituting comparisons of horizons. The difficulties hitherto experienced in this have also arisen, in part at least, from a too close adherence to European distinctions, which may not be strictly applicable in the East, though the general order of succession of fossils is no doubt similar in both.

The question of the age of the Nubian sandstones is at present somewhat difficult, and has recently been ably discussed by Hudleston.<sup>2</sup> On the Nile it succeeds at Silsilis the Cretaceous beds above referred to, in descending order, and apparently conformably, and forms an east and west ridge through which the river passes in a narrow gorge. In this outcrop are the celebrated quarries from which so much of the stone of the Egyptian temples was derived. The Silsilis exposure is, however, limited in breadth, and south of it beds similar to those on the north recur, leading to the supposition that there is here an east and west fault or roll of the strata, repeating the beds, or else that there are two distinct sandstones. I had not opportunity to work out this point satisfactorily, but believe that there is little reason to doubt the existence of a down-throw fault, repeating the Cretaceous beds, at the south of the

<sup>1</sup> Bulletin Geol. Soc. of France.

<sup>2</sup> As Hudleston has remarked, Bauerman's section of the Zib escarpment exhibits a lower sandstone in connection with which the fossils regarded as Carboniferous occur; while higher in the series there are other sandstones associated with calcareous beds holding undoubted Cretaceous fossils. Geology of Palestine, Proceedings Geol. Assoc. vol. viii.

Silsilis ridge. A little below Kom Ombos the sandstone reappears, and continues all the way to Assouan. At one point in this section two distinct beds are seen, the upper a ferruginous irregular sandstone and the under grey and laminated. They appear, as seen from the river, to be unconformable, but this may be merely false bedding. At another place the sandstone is seen to be shallow, a mass of dark-coloured crystalline rock appearing below it. At Assouan, however, where it reposes on the Laurentian and granitic rocks, it appears in some places to be at least 100 feet in thickness.

The conformable manner in which the Nubian sandstone underlies the Cretaceous has induced Zittel and others to consider it as merely a lower member of that formation. Of this, however, there is no distinct evidence, and the only determinable fossil hitherto obtained in the formation—a species of *Dadoxylon* (*D. Ægyptiacum* of Unger)—has a Palæozoic rather than Mesozoic aspect. Specimens of this wood have been obtained at Assouan and Kom Ombos, and Newbold mentions<sup>1</sup> the discovery of Coniferous wood at Ipsambul, in Nubia, which must also have been in this formation. On the other hand, *Nicolia* is also stated to have been found in it, but this I suspect to be an error. In any case the Nubian sandstone is the oldest formation on the Nile next to the old crystalline rocks, to which it clings all along their margin, and from whose waste it is obviously derived. It may not improbably be a Palæozoic deposit, the upper part of which has been *remainé* and mixed with the early Cretaceous beds. This would, however, imply a remarkably undisturbed condition of the Egyptian area in the later Palæozoic and earlier Mesozoic periods. There is, however, a similar case in the Triassic red sandstones of Prince Edward Island in the Gulf of St. Lawrence, which rest so conformably and continuously on the upper red sandstones of the Permo-Carboniferous from which they are derived, that it is about impossible to separate them.<sup>2</sup>

If we appeal in this case to the so-called Nubian Sandstones of the Sinaitic peninsula, we find that there Bauerman and others have found Brachiopods of Carboniferous species, as well as *Sigillaria* and *Lepidodendron*.<sup>3</sup> Of these I have seen only the specimen *L. Mosaicum* in the collection of the Geological Society, which is in a hard grey sandstone, and has a decidedly Carboniferous aspect. The sandstones of Wady-Nasb, which have afforded these fossils, are connected by a continuous line of outcrop with those of the east side of the Dead Sea, which underlie the Cretaceous of that region, just as the Nubian Sandstone does in Egypt.

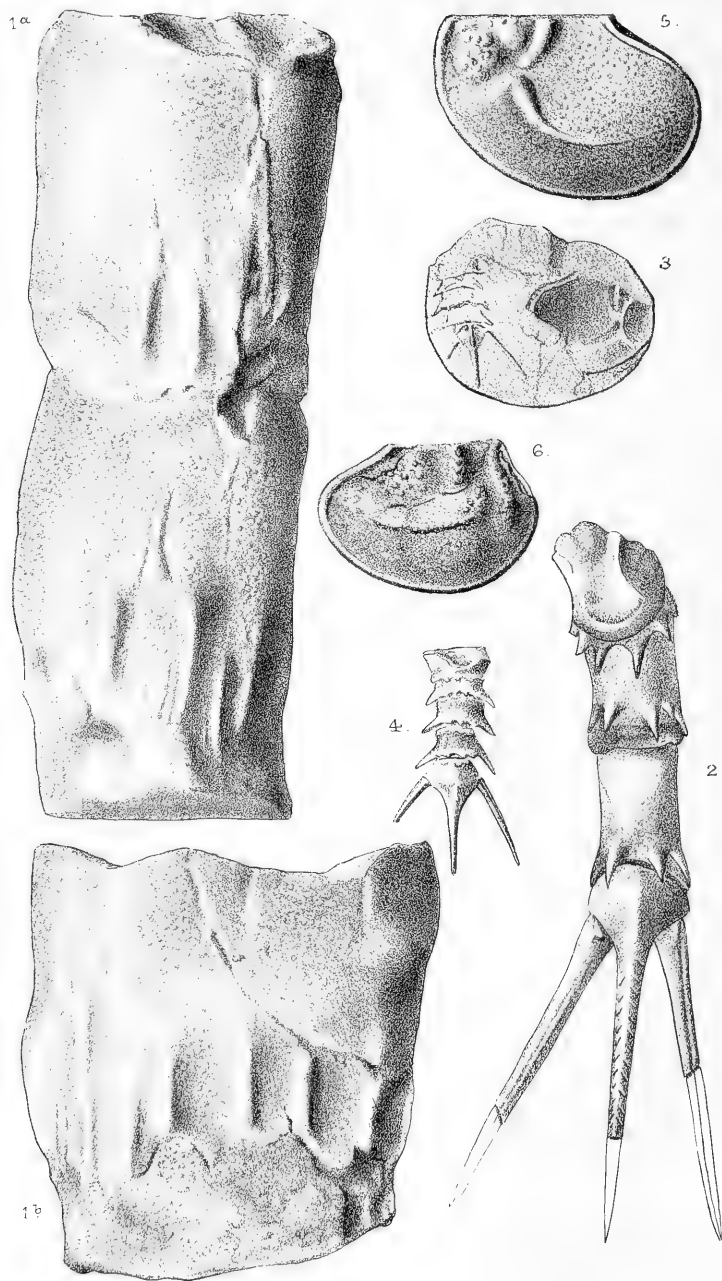
On the other hand, I have examined certain sandstones associated with the lignitiferous zone of the Lebanon, and which have been associated with the Nubian Sandstone; but these are stratigraphically included in the Cretaceous limestones, and contain *Ostrea succinea* and other Cretaceous fossils. They hold also fossil coniferous wood, which I have not yet examined microscopically, but it has a

<sup>1</sup> Quart. Journal Geol. Soc. 1848, vol. iv. pp. 349-357.

<sup>2</sup> Acadian Geology.

<sup>3</sup> Tate, Quart. Journ. Geol. Soc. 1871, vol. 27, p. 404; Hudleston, Address to Geologists' Assoc. vol. viii. 1883, pp. 1-53.





A.B. Woodward lith.

West, Newman & C<sup>o</sup> imp.

Caudal Segments & Valves of Echinocaris.



decidedly Mesozoic aspect. These Lebanon beds I would correlate with the similar beds above referred to near Edfou in Egypt, rather than with the Nubian Sandstone.

On the whole, therefore, it would seem that we may have in Upper Egypt and in Sinai an Upper Palæozoic sandstone, perhaps supporting a not dissimilar sandstone of Lower Cretaceous age; and that the deposits which have been known by that name in the Lebanon are altogether distinct, and belong to the Cretaceous ligniferous zone.

## II.—NOTES ON PHYLLOPODIFORM CRUSTACEANS, REFERABLE TO THE GENUS *ECHINOCARIS*, FROM THE PALÆOZOIC ROCKS.

By Prof. T. RUFERT JONES, F.R.S., and HENRY WOODWARD, LL.D., F.R.S.

(PLATE XIII.)

IN 1863 Professor James Hall described and figured<sup>1</sup> three abdominal segments, with the telson and its appendages, of a Ceratiocaridal Crustacean, characterized by its relatively large size (about 100 mm. long, and from 10 to 15 broad) and by the presence of strong spines on the distal upper edge of each segment [see annexed Plate, Fig. 2]. This form, from the shales of the Hamilton group (Devonian) of Ontario County, N.Y., he referred with doubt to *Ceratiocaris*, and gave it the specific name "*armatus*." At the same time Prof. Hall described and figured<sup>2</sup> some separate caudal spines, from the Genessee Slate, Ontario Co., as *C. ? longicaudus*, of which his figs. 4, 5 and 6 may be the same as those of *C. ? armatus*; whilst fig. 7 seems to be two small body-segements and caudal spines of some other Phyllopod. To these Prof. Hall added, in the same plate, the figure of a relatively large Leperditioiid carapace-valve, doubtfully referred to *Ceratiocaris* as *C. ? punctatus*,<sup>3</sup> from the Hamilton Group, east shore of Cayuga Lake, N.Y.

In 1876, Prof. Hall reproduced the figs. 1, 2, and 8, as figs. 4, 5, and 7 in plate 28 of his "Illustrations of Devonian Fossils," published in advance of the "Geological Survey of the State of New York, Palæontology," vol. v. part 2. Prof. Hall intimates, in the explanation of the plate, that the carapace-valve perhaps belongs to Barrande's genus *Aristozoe*; and he adds this note:—"As this sheet is going to press a specimen has been found, among some old collections, which carries a carapace similar to the one figured, and several joints of the abdomen, the latter similar in every respect to corresponding parts of *Ceratiocaris armatus*."

Hence we see that the two fossils belong to one species; and, as the name *armatus* stands first in the description and in the order of the figures, it takes priority, besides being very appropriate.

Another example of a Ceratiocarid with a spinous abdomen has been published by Mr. R. P. Whitfield in his "Notice of New Forms of Fossil Crustaceans from the Upper Devonian Rocks of Ohio, with

<sup>1</sup> "Sixteenth Report State Cab. New York," etc. Appendix D, p. 72, pl. 1, figs. 1, 2, 3.

<sup>2</sup> *Op. cit.* p. 73, pl. 1, figs. 4—7.

<sup>3</sup> *Op. cit.* p. 74, pl. 1, fig. 8.

Descriptions of New Genera and Species," in the "American Journ. of Science," vol. xix. January, 1880. Mr. Whitfield has obligingly favoured us with an illustrative plate<sup>1</sup> of these fossils. His figures 4, 5, and 6 are reproduced in the annexed Plate, as Figs. 3, 5, and 4 respectively.

These specimens occur "in small calcareous concretions in the Erie Shales (Portage and Chemung), at Leroy, Lake County, Ohio." In one of these nodules, when broken, were exposed the inside of a carapace-valve (imperfect) and a set of abdominal segments with telson (see annexed Pl. XIII. Fig. 3). The valve is similar to the better specimen shown by Fig. 5, obtained from another of the nodules. The collocation of the carapace-valve and caudal portion in one nodule (Fig. 3) is necessarily of great value (and may be accepted as conclusive evidence) in proving that these parts belonged to one individual; especially as Phyllopod of the *Ceratiocaris* type, and others, have a bivalved carapace with analogous abdominal and caudal appendages. The tail-piece in the nodule is enlarged in Fig. 4 (fig. 6 of Mr. Whitfield's plate); and a carapace-valve similar to that associated with it is shown by Fig. 5. Mr. Whitfield has determined them as belonging to a new Phyllopodous genus of the "Ceratiocaridæ," namely *Echinocaris*, remarkable for the spines on its abdominal segments and having a Leperditoid form of valve. This is the *E. sublævis*, Whitf.; and he adds another nearly allied form, from the same Devonian concretions, as *E. pustulosa* (Fig. 6 in our Plate; fig. 7 in Mr. Whitfield's). By the introduction of the figure of an *Aristozoe* (*A. Canadensis*, Whitf., "from the Trenton Limestone (?) near Ottawa") in the same plate (fig. 9), "for comparison," Mr. Whitfield would show a difference rather than a likeness, as he considers M. Barrande's reference of this form to the Ostracodes as correct (p. 33), and does not agree with Prof. Hall in suggesting *Aristozoe* as a possible synonym for his new fossil (see above). It seems to us, however, that *Aristozoe*, *Orozoe*, and *Callizoe*, of Barrande, are close allies of the Ceratiocarid group (as intimated in the Table at p. 462, GEOL. MAG. October, 1883; and "Report Brit. Assoc." for 1883), although as yet no tail-pieces have been recorded as having been found in direct connection with them. Among the Bohemian specimens in the British Museum, there is one style or stylet lying close to an *Aristozoe perlonga*; but there is no clear evidence that the one belonged to the other.

To return to *Echinocaris*:<sup>1</sup>—Mr. Whitfield very properly refers to Prof. Hall's *Ceratiocaris armatus* and *C. punctatus* (above mentioned) as being evidently of the same genus as his own Leperditoid and spiny specimens; and as Prof. Hall unites his two species, on good evidence (see above), we have the three well-determined species:

1. *Echinocaris armata* (Hall).
2. ————— *sublævis*, Whitfield.
3. ————— *pustulosa*, Whitf.

<sup>1</sup> "Devonian Crustaceans," prepared for the "Palæontology of Ohio," vol. iii.

ECHINOCARIS WRIGHTIANA, Dawson, sp. Plate XIII. Figs. 1a, 1b.

*Equisetides Wrightiana*, Dawson, Quart. Journ. Geol. Soc. 1881, vol. xxxvii. p. 301, pl. 12, fig. 10, and pl. 13, fig. 20.

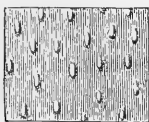
We have lately been favoured by Professor James Hall, of the State Museum of Natural History, Albany, New York, with photographs, drawings, and casts of various Palæozoic Crustaceans which have of late come under his notice. One of these, it appears to us, should be referred to this category of spiny-tailed Ceratiocarida. It is only a fragment, consisting of no more than two abdominal segments, but it represents a part of probably one of the finest Phyllopod Crustaceans hitherto recorded.

Fig. 1a represents the two segments seen in their narrowest (or back) aspect, Fig. 1b being a portion of the lower segment of Fig. 1a seen from the broader aspect (left side). The anterior, or upper joint, overlaps the lower or under one, and at the junction shows an inner crest. The ridges or folds, rise from the general surface, and become stronger as they approach the posterior margin.

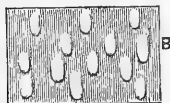
The posterior border of the anterior segment is broken away, showing the crust beneath. The posterior margin of the hinder segment is better preserved, and shows the plications more nearly entire.

That these ridges or folds terminated in pointed spines which overlapped the succeeding segment is clearly shown by the impressions left by two of them upon the anterior (upper) edge, of the lower segment (Fig. 1b).

Lastly, the peculiar pustulated and wrinkled surface of the segments is such as we are accustomed to regard as crustacean, resembling as it does the surface-markings observed by us on many other Palæozoic forms belonging to this class (see woodcut).



A. Surface-markings of internal cast (magnified).



B. External surface-markings (magnified).

(Reproduced from sketches kindly supplied by Prof. James Hall.)

Without increasing therefore the number of genera, and indeed being satisfied of its close relationship to the spiny forms above mentioned, and described by Professor James Hall and Mr. R. P. Whitfield respectively, we look upon the Devonian specimen in Mr. Wright's Collection, "from the Portage Group (Upper Erian) of Italy, New York," as *Echinocaris Wrightiana*, Dawson, sp.<sup>1</sup>

In size *Echinocaris Wrightiana* (Dawson) surpasses any specimen of such Phyllopods that we know of. Its body-segments are not compressed, and each is about 2 inches long, 2 inches high, and

<sup>1</sup> Mr. Whitfield and J. M. Clarke duly recognize this word as *feminine*, just as *Ceratiocaris*, and all the names formed with *χαρις*, ought to be regarded, although often otherwise treated.

1 inch thick. *Ceratiocaris Ludensis*, H. W. (GEOL. MAG. Vol. VIII. 1871, 104, Pl. 3, Fig. 3,  $\frac{1}{3}$ rd of natural size), is the only British form at all approaching the North-American specimen. Of this there are seven body-segments and three long tapering spines (one nearly 9 inches long). The seven segments measure  $8\frac{1}{2}$  inches in length, and nearly 2 inches in breadth (height) as lying flattened sideways in the slab; six of the segments measure individually from  $\frac{1}{2}$  and  $\frac{3}{4}$  inch to 1 inch in length, and the last (telson?) is  $2\frac{3}{4}$  inches long. The published figure gives a very inadequate idea of this fine specimen (its carapace may have been 8 inches long): and on a visit to the Ludlow Museum lately one of us (T. R. Jones) thought that there are remnants of bases of prickles on the last two segments, roughly indicated on the figure referred to. The specimen will soon, we trust, receive all the attention of artist and palæontologist which it deserves.

Some large specimens have been met with in North America also; for example, *C. Deweyi*, Hall, "Palæont. New York," vol. ii. p. 320, pl. 71: the one segment drawn (fig. 1c) appears to have been  $2\frac{1}{2}$  inches long; and one of the caudal spines on the same plate (fig. 1a) is  $6\frac{1}{2}$  inches long.

A tail-spine from Bohemia, in the British Museum, is  $5\frac{1}{4}$  inches long.

Tail-spines of *Ceratiocaris*, 3 inches long, have been not unfrequently found in the Lower Ludlow of Leintwardine, near Ludlow.

#### EXPLANATION OF PLATE XIII.

- FIG. 1. *Echinocaris Wrightiana* (Dawson sp.). Portions of abdomen (natural size).  
 ,, 1a. Two body-segments seen from back or narrow aspect.  
 ,, 1b. Another view of the lower (or posterior) of the two body-segments (seen in Fig. 1a) viewed from the left side.

From the Portage Group (Upper Erian) of Italy, New York. Collected by B. H. Wright, Esq.

- ,, 2. Three body-segments and telson, with one style and two stylets, of *Echinocaris armata* (Hall). Natural size. From Devonian strata of the Hamilton Group, State of New York. (After J. Hall.)  
 ,, 3, 4, 5. *Echinocaris sublevis*, Whitfield, from small calcareous concretions in the Erie Shales (Upper Devonian: Portage and Chemung Groups), at Leroy, Lake County, Ohio. (After Whitfield.)  
 ,, 3. The half of a small nodule, showing some abdominal segments and the inside of a valve. Natural size.  
 ,, 4. The four body-segments and telson with its spines seen in the nodule. Nearly twice the natural size.  
 ,, 5. A left valve. Twice the natural size.  
 ,, 6. *Echinocaris pustulosa*, Whitfield. A right valve; twice the natural size. From the Upper-Devonian nodules of Leroy, as above.

### III.—ON CLEAVAGE AND DISTORTION.

By the Rev. O. FISHER, M.A., F.G.S.

(Continued from p. 276.)

#### PART V.

THE history of opinion upon the subject of cleavage seems to be this. Sedgwick had come to the conclusion that cleavage was a condition, "impressed on certain rocks and in certain regions by

the operation of some very extensive cause, after the stratified rocks had undergone great displacement,"<sup>1</sup> and he suggested that the cause might be some kind of crystallization. But Dr. Sorby discovered that the intimate structure to which cleavage is due is not crystallization, but a mechanical rearrangement of the particles of the rock: and he produced it artificially by squeezing clay containing flaky particles. Dr. Tyndall did the same thing with different substances, without introducing flaky particles. In either case it was by pressure that the result was obtained. Seeing therefore that pressure could succeed in laboratory experiments, and that cleavage in the field was ordinarily nearly at right angles to the direction in which the action of pressure might have folded the strata, it was natural to conclude that both folds and cleavage had been concomitant effects of such a pressure. And this appears to be the theory now generally adopted; and is of course in opposition to both of Sedgwick's conclusions. For my part I believe that Sedgwick was right in thinking that cleavage was produced by some very extensive cause operating *after* the rocks had undergone great displacement; while I agree with Sorby and Tyndall in attributing it to a mechanical action, accompanied with pressure. Nevertheless I do not think that this pressure was the same exhibition of force, that originally folded and elevated the rocks, as explained in Part IV.<sup>2</sup> Thus I am in accord with each of these authors in the domain in which his authority stands highest.

I believe that the first occasion when a doubt occurred to me regarding the usually received view upon cleavage was when I recorded the following entry in my note-book in 1867, being in company at the time with Mr. Pengelly.<sup>3</sup>

Although no author has, so far as I know, used the comparatively

<sup>1</sup> Phillips' Report on Cleavage, 1856, Brit. Assoc. Reports, 1857, p. 373.

<sup>2</sup> GEOLOGICAL MAGAZINE, 1884, p. 271.

<sup>3</sup> Since sending my MS. to the Editor, I have enquired of Mr. Pengelly, "What is the relation of the cleavage to the unconformity?" His reply is as follows:—

"The cleavage in the section at Hope's Nose affects both sets of rocks, and it is not diverted by the unconformity. The following is briefly the reading of the section:—

1st. The formation of the lower series by the deposition of triturated organic exuviae; the process being frequently intermitted, as is proved by the interstratification of volcanic ash.

2nd. By the operation of some approximately lateral force, the beds were contorted, and were fractured at the point of greatest flexure.

3rd. The uppermost beds of this lower series were exposed to the action of the waves, and planed down to an approximately horizontal surface.

4th. After this denudation, the beds of the upper series were deposited unconformably on the lower, and are now nearly horizontal.

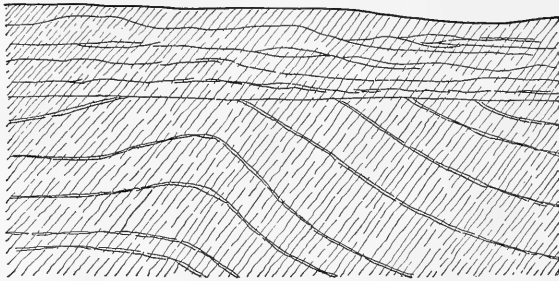
5th. Though these processes must have absorbed a large amount of time, they were all completed within one and the same division of the Devonian period, as is proved by the specific identity of the numerous fossils in the two series.

6th. After the deposition of the upper series, cleavage was set up in the entire mass.

7th. Assuming that cleavage is due to pressure, there are conditions under which pressure can produce contortion without cleavage, and conditions under which it can produce cleavage without contortion."

modern term "shear" in connection with cleavage, still that mode of action is necessarily implied in any mechanical theory. Thus Phillips wrote of "a creeping movement of the particles of the rock along the planes of cleavage, the effect of which was to roll them

FIG. 1.



DIAGRAMMATIC SECTION AT HOPE'S NOSE, NEAR TORQUAY.

Thirty feet thickness seen. The same cleavage runs through the whole series in spite of the unconformity, showing that it was not produced by the pressure which caused the folds.

forward in a direction always uniform over the same tract of country."<sup>1</sup> And Sir John Herschell says that, "Cleavage *does not absolutely require violent force*, but only intermolecular movement in a given fixed direction." This is a shear, and he remarks upon "the tendency of the particles to arrange themselves when in motion all in one direction, according to the laws, *not of pressure BUT of friction*, a distinction which is quite necessary to be borne in mind."<sup>2</sup> But it is not quite clear from this passage, whether he supposed the planes of cleavage and of shear to be the same or not. I assumed in my former paper that this is the case. But a suggestion from Mr. Harker has led me to re-consider this point, and to inquire whether the greater diametral plane of the ellipsoid of distortion may not be the cleavage plane.

The excellent illustrations to Sharpe's paper have enabled me to test this question, and I have little doubt that the above conclusion is correct.

Fig. 2.

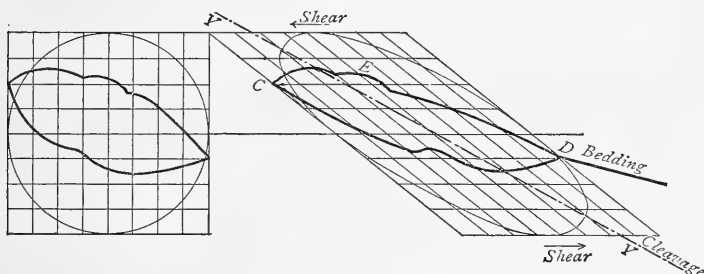


<sup>1</sup> On certain Movements in the Parts of Stratified Rocks, Brit. Assoc. 1843. Quoted by Sharpe, *loc. cit.* p. 76.

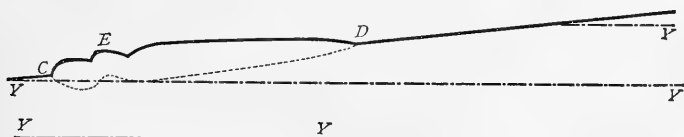
<sup>2</sup> Phil. Mag. vol. xii. p. 198.

One mode of representing the distortion by shearing in a plane perpendicular to the strike (the plane of dip) is as follows. Draw a number of lines parallel to the shear, dividing the circumference of the circle of Fig. 1 into equal small arcs, and produce these lines to cut the ellipse. The points where they cut the ellipse will be the places, in which the corresponding points of the circle will be found after being sheared. (It is easy to conceive an analogous construction if the circle has been compressed as well as sheared.) And points along the radii of the circle will take up their positions along these radii of the ellipse, as defined by their intersections with the parallel lines. We may then, if we please, draw our fossil, or other object, within the circle; and draw a distorted figure within the ellipse, guiding the pencil by corresponding intersections of the parallels with the radii in the circle and in the ellipse respectively. But for practical purposes it is more convenient to use the parallelogram into which a square is distorted, as in the figure below. By dividing up the square into a number of small squares, and the parallelogram into the corresponding small parallelograms, it is then very easy to draw the outline of any object within the square, and to represent its distorted form within the tessellated parallelogram.

FIG. 3.



SECTION OF A *Spirifer* DISTORTED BY SHEARING.



PART OF SHARPE'S DIAGRAM (FIG. 15) SHOWING THE DISTORTION OF A *Spirifer* BY CLEAVAGE AT SOUTH PETHERWIN.<sup>1</sup>

The outline of a *Spirifer* given in the diagram has been taken along a section slightly inclined to the line of the hinge, so as to give a distorted form analogous to that in Sharpe's figure. On comparing the two figures, it can be easily seen that, on a chance assumption of the position of the fossil and of the amount of the shear, the distortion agrees very well with that observed by Sharpe. Some allowance may fairly be claimed for want of closer agreement

<sup>1</sup> Quart. Journ. Geol. Soc. vol. iii. 1846.

with the dotted restoration in his section, which is evidently imaginary, and shows the mesial fold too much to the left. It comes out clearly, on comparing the two diagrams, that the diametral plane of the ellipsoid corresponds with *yy*, the plane of cleavage in Sharpe's figure. The plane of cleavage, therefore, does not lie in the direction of movement among the ultimate particles of the rock, but is inclined to it. It will be shown later on that the inclination may be as great as  $45^\circ$ , and diminishing from that as a maximum, the two directions may become nearly, though never quite, identical as the shear is increased.

An inspection of the ellipse shows that it will have two diameters which are equal to the diameter of the circle. One of these will be in the direction of the shear, and the other similarly situated on the other side of the minor axis. Objects found along these diameters will not be distorted, while those lying nearer to the major axis will be lengthened, and those nearer to the minor shortened.

Our ellipse evidently corresponds with that given by Phillips<sup>1</sup> in illustration of Dr. Sorby's views regarding unequiaxed particles. And if such particles were originally lying at all angles in the circle, they would become packed together most closely about the diametral plane of the ellipsoid, and thus, according to his theory, that ought to be a cleavage plane, as we have seen that it is.

It is important to notice that in our diagram there is not any compression whatever represented, so that it appears that lateral pressure is not required for the geometrical phenomena of distortion by cleavage. Nevertheless, if the reasoning of Part IV. is sound, which I believe to be the case<sup>2</sup> (excepting the assumption that the cleavage and shear coincide), a pressure across the tract is mechanically requisite to avoid faulting. The effect of this will be to condense the rock while it is being converted into slate. We must therefore use the smaller ellipse in Fig. 2, if we wish accurately to delineate the distortion. This, however, will in no way alter the general character of the phenomena.

The bedding of the strata will of course be in general distorted, as well as the fossils. And the very remarkable phenomena of close folds on a small scale accompanied by cleavage planes, such as is represented in Dr. Sorby's diagram,<sup>3</sup> may according to the present theory be explained. We observe that the axes of the folds are nearly parallel to the cleavage. We may therefore regard each semi-fold as approximately a semi-ellipse, which has arisen from the distortion of a semi-fold much less compressed. If, then, this rock was more rigid than the matrix in which it was inclosed, it would not, like it, yield entirely by viscous shearing, but partly by fracture,

<sup>1</sup> *Phil. Mag.* Jan. 1856.

<sup>2</sup> The argument (p. 273) regarding the circumstances which would lead to a viscous shearing as distinguished from faulting supposes that a horizontal stress causes a shearing of the parallelepiped. We now regard the shearing as causing a stress. The relations of the forces will remain unaltered, although the directions of the motions will be reversed.

<sup>3</sup> *Edin. New Phil. Journ.* 1853, vol. iv. p. 138, copied by Professors Tyndall and Phillips.



and it can be seen in Sorby's figure that the directions of the cracks cut up the bent layers into *voussoirs*, just of the forms and in positions which would be requisite to extend a fold already existing, into a narrower one of sharper curvature. This applies to the folds which point upwards as well as those which point downwards. The bending and crowding of the cleavage surfaces, to accommodate themselves between the folds of the less yielding rock, is analogous to what may be seen under the microscope, where the laminae of the matrix of a slate bend round a distorted harder granule.

The principle just enunciated is capable of an application far wider than can be now entered upon. It shows that all folding is distorted by the action which has produced cleavage: and that, when we see a fold in a cleaved region, we can no more assert that it is of its original form, than that a fossil distorted by cleavage is so. This will explain the sharp folds dipping inwards on the flanks of a mountain chain. It will also explain some cases, at least, of crumpling, which may be but distorted ripple marks. And it is interesting to see how closely the distorted section of ripple-marked bedding, if across the cleavage as given by the tessellated parallelogram, agrees with that of a crumpled rock.

Moreover, since this action affects the minute structure of the rock, and leaves its impress upon microscopical sections, the molecular movement, which in a suitable material produces cleavage, may in such rocks as are not liable to take on that peculiar condition, give rise to some analogous structure, which petrologists might identify.

The estimate hitherto made of distortion has been of that in a plane at right angles to the strike. To estimate that in one parallel to it (say on a bedding plane), we observe that every generating circle of the sphere, perpendicular to the plane of the paper, has been changed into its own corresponding ellipse. This ellipse will be of the same breadth as the circle in the direction of the strike, but will be elongated or shortened according to its position in dip. Its area will not be equal to that of the circle, as was the case with the vertical section of the ellipsoid. The result will be that the impressions of fossils on the plane of bedding may be either elongated or shortened in the dip, but will not be altered in the strike. They will therefore in general cover a different area, greater or less, from what they did before distortion; while the apparent alteration of their proportions in the direction of the strike will be only comparative. If we employ a divided square and a correspondingly divided *rectangular* parallelogram, their lengths being taken proportional to the radii of the circle and of the ellipse, parallel respectively to the original and to the sheared bedding, it is easy to delineate the distortion of any fossil; and it will be found to agree with that seen in nature. The comparison is best made in the case of Trilobites. The same thing may also be readily done with proportional compasses. When the bedding nearly coincides with a cleavage plane, the fossils become much elongated, and so enlarged, and thus the great size of the Tintagel fossils is accounted

for. If the plane of bedding lies so that the fossils become shortened, they may be crumpled, and exhibit striæ parallel to the strike.

While speaking of distortion, the greenish oval spots, which occur on some purple slates, must not be passed over. It is perfectly obvious that they are discoloured regions, and that the chemical action has radiated from a foreign body, usually to be seen at or near the centre. The first question is, whether they were formed before or since the cleavage. Either is possible. If before, then they have been distorted into their present form, and, if originally spherical, they will give accurately the form of the ellipsoid of distortion. If formed subsequently to cleavage, they may be accounted for by the chemical influence spreading most readily along the grain of the slate, and with greatest difficulty across its laminae. It is common to see exactly similar oval spots where the colour has been discharged around nail-heads upon deal boards, which have been stained to imitate oak and exposed to damp. The nail is in this case the foreign body, and the spot is elongated in the direction of the grain of the wood. It is difficult to see how the rock can have been affected by local decomposition of the colouring matter, unless subjected to the percolation of aerial water; and this leads me to incline to the idea that these spots are comparatively recent. Discoloured bands of bedding are in the same category.

On studying Dr. Haughton's ingenious paper in the *Phil. Mag.* for January, 1856, I was much perplexed at some of the results which he had obtained. For instance, it seemed a very unaccountable thing that the ellipsoid of distortion should commonly come out a very flattened spheroid. This could only be explained by an inconceivably great condensation of the material, with scarcely any lateral movement. I think that the probable cause of this anomaly is that Dr. Haughton has not taken into consideration the alteration, in the angle between the original bedding and the cleavage, produced by the shear. He calculates the form of the ellipsoid by means of the distortion of a fossil out of its known proportions as measured on the cleavage plane, and the angles ( $\phi$ ,  $\phi'$ ) observed between the constant dip of the cleavage and two different dips of the bedding, assuming that the bedding has not been disturbed by the cleavage; whereas it seems that observation cannot determine the inclination of the original bedding to the cleavage, because the bedding, as well as the fossils, has been displaced. The formula which shows the amount of displacement for a given shear will be given further on.<sup>1</sup>

To assist me in forming an estimate of the amount of condensation which may have been produced by pressure during the formation of a slate, Professor Liveing kindly examined for me a piece of the Devonian argillaceous purple rock, taken at the depth of about 1000 feet, in the boring at Turnford, near Cheshunt; and also a fragment from a slab of purple slate. He found the Devonian rock more like slate, than are ordinary clays, in its chemical composition. It therefore appears to me to be a fair subject for comparison. Its

<sup>1</sup> Equation 3.

specific gravity at 15°·5 C. is 2·644; and the loss on ignition is 5·08 per cent. The slate examined had the same specific gravity as the Devonian, viz. 2·64; and the loss by ignition was 2·44 per cent. If we divide the water in the Devonian, so that one portion combined with the rocky matter will give the composition of slate rock, we shall have,

$$\begin{array}{r}
 \text{Devonian rock} = 2\cdot77 \text{ water} \\
 \qquad \qquad \qquad 2\cdot31 \text{ water} \\
 \qquad \qquad \qquad 94\cdot92 \text{ rocky matter} \quad \left. \vphantom{\begin{array}{l} 2\cdot77 \\ 2\cdot31 \\ 94\cdot92 \end{array}} \right\} = \text{slate rock.} \\
 \hline
 100\cdot00
 \end{array}$$

$$\begin{array}{r}
 \text{That is, Devonian rock} = 2\cdot77 \text{ water} \\
 \qquad \qquad \qquad 97\cdot23 \text{ slate rock} \\
 \hline
 100\cdot00
 \end{array}$$

If then 2·77 per cent of water was to be removed from the Devonian rock, the remainder might be taken to have the composition of a slate. Probably the loss of this amount of water would cause the material to shrink somewhat; but we will neglect that cause of shrinking, and credit the whole of it to compression.

The specific gravity of the remaining mass of the Devonian (its volume being unaltered) will bear to its former specific gravity the same ratio, that its present mass bears to its former mass, so that it will now be  $97\cdot23 \div 100 \times 2\cdot644 = 2\cdot57$ . We must next suppose this substance compressed, until its specific gravity becomes that of slate. The volume after compression will be to that before compression inversely as the specific gravities: and 2·64 being the specific gravity of slate, the volume of the compressed rock will be,  $2\cdot56 \div 2\cdot644$ , or 0·97 of its original volume. Thus we see that a compression of less than three per cent. would suffice to reduce the Devonian rock to slate. But being confined on all sides (as would be the case deep in the earth), the rock could not expand laterally, and the change of dimension could take place only in the direction of the pressure; so that we may say that 100 feet thickness of the Devonian rock of Turnford would not quite be compressed into 97 feet on being converted into slate. This is a compression of only three per cent.

It is probable that, if a substance was homogeneous, a shearing action, accompanied by compression, would not induce cleavage. But the rocks which have been cleaved were not homogeneous. Every particle, therefore, being liable to distortion, would be thinned in the direction of the shortest axis, and elongated in that of the longest axis of the ellipsoid. The breadth only of the particle, measured in the direction of the strike, would remain unaltered. These changes would convert the rock into an assemblage of flattened ovoid particles of unequal strength, and render it liable to cleave, the fracture running among the particles parallel, on the average, to the major diametral plane of the ellipsoid. This agrees with the structure

of a slate as revealed by the microscope. The unequiauxed particles referred to by Dr. Sorby would also be rearranged, as already explained, mostly in the said plane, and would assist in promoting cleavage parallel to that plane. Thus we should conclude that Dr. Sorby and Prof. Tyndall have both asserted *veræ causæ* concerned in the production of this structure.

Dr. Sorby has remarked that, "Many of the finer-grained slates used for roofing contain minute rounded grains of mica, seldom so much as  $\frac{1}{100}$ th of an inch in diameter, and usually much less, which are of nearly the same thickness as width, and not merely flakes. When these are cut through in the thin sections used for microscopical examination, they are seen to be composed of many laminae. When the line [plane] of lamination—that is, of the crystalline cleavage of the mica—coincides with the cleavage of the slate, then these rounded grains retain their form unaltered." In this position, according to our view, the grains would be elongated, but not broken up in any way, because every lamina would be similarly affected in the direction of lamination. Perhaps this may satisfy the above observation, because the original form cannot be known. "If the lamination is perpendicular to the cleavage, the rounded form still remains, but the laminae are generally not straight, being irregularly bent in just such a manner as if they had been compressed in the direction perpendicular to the cleavage of the slate." In fact they are in the case of the minor axis of our ellipse, which had originally the length of the radius of the circle. "Those, however, which lie with their lamination at intermediate angles, as, for instance,  $30^\circ$  or  $40^\circ$  to the cleavage of the slate, do not retain their original form, but are broken up and extended out in the plane of their lamination."<sup>1</sup> These particles I should suppose to have had their planes of lamination nearly in the direction of the shear. Being planes of little friction in the crystal, it has become deformed by minute faulting along them, instead of by viscous shearing. In the instance referred to by Dr. Sorby, it would therefore appear that the plane of shear was inclined to that of cleavage at between  $30^\circ$  and  $40^\circ$ . Dr. Geikie gives an illustration<sup>2</sup> showing one of these faulted grains, and it accords perfectly well with the above explanation.

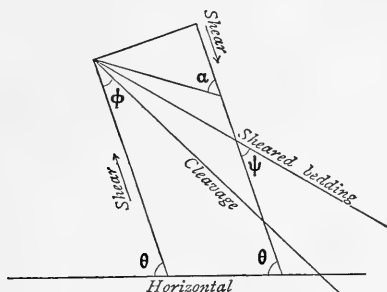
The diagram, representing the traces of the several planes in ordinary positions upon a vertical plane perpendicular to the strike, will render the relation of the various angles more intelligible. If  $a$  be the angle which the side of either rhombus in Fig. 2 makes with its base, then  $\cot a$  will be the measure of the shear.  $\theta$  is the inclination of the shear to the horizon, and is the same angle as  $\theta$  in the former Parts of this treatise.  $\phi$  is the inclination of the cleavage plane to the shear. Then the dip of the cleavage will be  $\theta - \phi$ , which is an angle that can be directly observed.  $\psi$  is the inclination of the sheared bedding to the shear. Hence  $\psi - \phi$  is

<sup>1</sup> "In just such a manner as would occur if the dimensions of the slate had been changed as previously mentioned."—"On the Origin of Slaty Cleavage," Edin. New Phil. Journ. vol. lv. p. 140, 1853.

<sup>2</sup> Text-Book of Geology, p. 310.

Dr. Haughton's  $\phi$ , and may be observed; but he has taken the bedding as retaining its original position.

FIG. 4.



The chief difficulty that will be felt in accepting the theory now proposed, that cleavage is due to an internal movement of the rocks rendered necessary by the disturbed region having been left after elevation in a position too lofty for equilibrium, will probably arise from the great amount of the vertical movement necessary to give a sufficient amount of shear. But it must be recollected that an *equally great amount of movement is implicitly assumed* in the theory which attributes the cleavage to the identical compression which crumpled the rocks. For, whatever be the cause, the observed distortion implies a corresponding shear. In mitigation of this difficulty it may be noticed that the shear is relative, and, if great at one place in one direction, may be compensated (on the average) by one equally great in the opposite direction no very long way off. Such changes would be betrayed by changes in the direction of dip of cleavage, which in fact takes place pretty frequently. Again, the great relative shifts, which are known to take place in certain cases by faulting, may be equally expected to occur by shearing in cases where faulting is not possible. Subsequent disturbances are to be expected, for Jukes says that, "when running sections in North Wales, he was occasionally struck by the fact of a sudden change in the strike and dip of the cleavage occurring immediately after crossing a fault. It seemed to indicate that the cleavage plains had been affected by the faults, and no longer lay in their original positions with respect to the horizon and compass bearings."<sup>1</sup>

To express the ratios of the axes of the ellipsoid of distortion; let them be  $a, b, c$ . Then  $b$  will be the radius of the sphere. Suppose the sphere to be compressed into a spheroid, and that its polar axis becomes  $mb$ . Then  $m$  will not differ much from unity. We have already estimated it at 0.97 in a particular case. It may

<sup>1</sup> Manual of Geology, p. 271, ed. 1862.

be proved by the properties of conjugate diameters that the ratios of the axes of the ellipsoid of distortion will be,

$$\frac{a}{b} = \frac{1}{2} \left( \sqrt{1+m^2 \operatorname{cosec}^2 a + 2m} + \sqrt{1+m^2 \operatorname{cosec}^2 a - 2m} \right) \\ \frac{c}{b} = \frac{1}{2} \left( \sqrt{1+m^2 \operatorname{cosec}^2 a + 2m} - \sqrt{1+m^2 \operatorname{cosec}^2 a - 2m} \right) \quad (1)$$

And by means of the equation to the ellipse, taking for the co-ordinates  $b \cos \phi$  and  $b \sin \phi$ ,

$$\cos^2 \phi = \frac{1}{2} + \frac{1 + m^2 \operatorname{cosec}^2 a - 2m^2}{2 \left( \sqrt{1+m^2 \operatorname{cosec}^2 a} \right)^2 - 4m^2} \quad (2)$$

Since  $m$  cannot be greater than unity, nor  $\operatorname{cosec} a$  less than unity, the second term is always positive. Hence,  $\cos^2 \phi$  is always greater than  $\frac{1}{2}$ , and  $\phi$  less than  $45^\circ$ . The inclination of the cleavage to the shear will commence at this angle, and diminish continually as the shear increases.

To express the alteration in the dip of the bedding, or of any other plane, caused by the shear, supposing its inclination to the direction of the shear to have been  $\Psi$  and to become  $\psi$ , it can be proved that,

$$\cot \psi = \cot \Psi + \cot a.$$

It must be remembered that  $a$  is not independent of  $m$ . But practically  $m$  might be taken as unity, and then, if by means of the observed distortion of an object, we could find either of the ratios of the axes of distortion, we could find  $a$  the angle of shear, from the corresponding equation of (1); and the inclination  $\phi$  of the plane of cleavage to it from (2); and, the dip of the cleavage  $\theta - \phi$  being known from observation, we should then know  $\theta$ , the dip of the shear; or the direction in which the movement took place: ignoring subsequent disturbances.

#### IV.—REMARKS ON SERPENTINE.

By Prof. T. G. BONNEY, D.Sc., F.R.S., Pres. G.S.

THE very full and able review of Dr. Sterry Hunt's paper on "The Geological History of Serpentine,"<sup>1</sup> gives me an opportunity, of which I have been for some time desirous, of commenting on certain parts of it relating to my investigations of the typical rock which bears that name. In commenting adversely upon these, I must not be supposed to express a difference of opinion in regard to every part of the paper, because there are many relating to the Archæan schists with which I am in general agreement.

In a matter of this kind, where so much depends on the meaning of a word, it is necessary to be clear and precise in our definition. No term has been more vaguely used than 'serpentine.' In the first place, it is applied both to a mineral and a rock. Again, in the

<sup>1</sup> See page 276 of the present volume.

former case, it designates a group, rather than a single species, including a number of forms (generally rather minute), which physically, and perhaps chemically, differ considerably, and agree only in having a hydrous silicate of magnesia as a dominant constituent. Starting, then, from a confusion, probably inevitable, the matter is made infinitely worse when we come to the rock. The name has been applied to all kinds of more or less unctuous, rather dark-coloured (especially green) rocks with a rather even compact ground-mass: in fact, it has been applied, to my knowledge, to rocks which have so little chemical or physical resemblance as to have no more claim to be united under one name than compact basalt and black argillite, or mica-trap and mica-schist. Whatever, then, I assert or deny about a serpentine in this paper must be understood as referring to a restricted group of rocks of which the well-known serpentine of the Lizard in Cornwall, of Portsoy in Ayrshire, of Monte Ferrato in Tuscany, to take one or two cases, are excellent examples. This group is as well defined and limited, when in its normal condition, as any basalt or diorite. In the field, in the hand specimen, under the microscope, it has well-marked characteristics. In its behaviour as regards jointing, weathering, etc., in its accessory minerals, in its analyses, it varies no more than an andesite or a phonolite, or any other species of igneous rock. That intermediate forms may be found linking it on to other species of igneous rock is no more than can be asserted as an objection to every definition of a rock species, so far as my knowledge goes. Thus, by the word serpentine, applied to a rock, I mean such a one as that which occurs at the Lizard, for a full description of which, in order to save valuable space, I may refer the reader to my papers on that and other districts.<sup>1</sup>

But before proceeding to discuss Dr. Sterry Hunt's objections to my view that such serpentine is a rock which was of igneous origin, and has been produced by the hydration of a peridotite, I must call attention to some inaccuracies in his references to my work. This is not done merely for the purpose of cavilling, but because, in reading those parts of his paper which refer to myself, I notice a general unprecision of statement, of which these are instances more readily appreciated. This causes me to receive with considerable doubt statements relating to matters beyond my personal knowledge, because I have noticed as a matter of experience that inaccuracy in recording the meaning of authors is not unfrequently associated with inaccuracy in observing the facts of nature. After stating rightly that I divide the metamorphic sedimentary rocks of the Lizard District (in ascending order) into a group of 'greenish micaceous and hornblendic schists, a black hornblendic group, and a group with granitic bands,' to which (for want of a better name) I gave that of the 'granulitic' group, Dr. Sterry Hunt proceeds (p. 178): "It is in the lowest of these three divisions, consisting

<sup>1</sup> Quart. Journ. Geol. Soc. vol. xxxiii. p. 884; vol. xxxix. p. 1. See also vol. xxxiv. p. 770; vol. xxxvii. p. 40. GEOL. MAG. Dec. II. Vol. VI. p. 362; Vol. VII. p. 538.

chiefly of micaceous and hornblendic schists, that the Cornish serpentines appear, accompanied by so-called gabbros and greenstones." I thought my first paper made it clear that the serpentine was always seen in association with the middle and upper groups. Further, in my second paper, I say of a diabase, which near Polpeor is intrusive in the *lowest* group, "it is the only igneous rock which I have detected in this group." Of course, as I believe the serpentine to be an intrusive rock, it must break through the lowest (micaceous) group, and at Porthalla it is not far from the upper part of it, but, curiously enough, it is never seen actually to cut it.

On the same page he also says: "Bonney has extended his observations to the serpentine and associated rocks in Italy, which he includes under the general title of ophiolites." I have never, so far as I can remember, used the word *ophiolite*; and if there is one thing for which I have striven, it is the restriction of the term serpentine to one kind of rock. Again, on p. 179 he says, with reference to the three districts noticed by me in Italy, "In each of these districts [Bonney] . . . supposes an intrusion of serpentine, or rather of olivine rock, among crystalline schists,<sup>1</sup> followed by a later intrusion of gabbro." Near Genoa I speak of the serpentine as probably intrusive to "an indurated shale of schistose aspect;" at Monte Rosso in "a dark-coloured rock, which is now rather schistose-looking, and greatly crumpled and crushed, but appears to have been originally a shale with irregular stony bands or concretions;" and in another place as including a mass of "an indurated argillaceous rock;" at Figline (the third locality), as "clearly intrusive in stratified rock, probably of Tertiary age!"

In the present paper it is my intention to recapitulate very briefly the evidence in favour of the following statements in those regions which I have examined, (1) that serpentine is in many cases distinctly proved to be an intrusive rock; (2) that it has come from the hydration of a peridotite. First, as regards Cornwall, both on the eastern and western coasts of the Lizard peninsula, the serpentine and the hornblende schist may be repeatedly seen in contact, with the following results:—

(1) That in certain cases the evidence as to the nature of the junction, whether it be intrusive or a fault, is indecisive, both rocks being so rotten and stained on either side of the line of parting that it is impossible to decide. These cases of course cannot be quoted by any disputant; they prove no more than does a defaced page of a manuscript in a controversy about the language in which it is written.

(2) That in many cases the serpentine cuts sharply across the broken edges of the strata *in both the hornblendic and the granulitic series*, and thrusts wedges between and tongues into them; that the lines of junction are often perfectly clean, sharp, and distinct, the serpentine sometimes following for a time a line of bedding, then cutting indifferently across layers of different mineral composition, some hornblendic, some mainly a quartz-felspar rock.

(3) That repeatedly, especially on the east shore, masses of the

<sup>1</sup> The italics are mine.



hornblendic and the granulitic series, ranging from a few feet to several yards in length, and of variable breadth and thickness, are completely included in the serpentine, the lines of parting being often perfectly sharp and unmistakeable, and the "schist" often having a "baked" and slightly altered aspect. The serpentine also sometimes assumes near the junction a slightly different aspect. These instances, two of which are figured (the woodcuts are ill executed) in my paper on the Lizard serpentine, may be counted by dozens on the eastern shore.

In short, if there be in Nature *any indications from which we can assert the intrusive character of any igneous rock whatever*, we have these indications in the case of the Lizard serpentine and the associated sedimentary series.

I repeat this statement at some length, because of a passage which Dr. Hunt penned about six years since, and has repeated in effect in the paper which I am noticing. "When it is considered that there is abundant evidence that the North American serpentines are indigenous, though often like deposits of gypsum and iron ores in lenticular masses: and further, that the movements which the ancient strata have suffered, have produced great crushings and displacements, it is not difficult to understand the deceptive appearance of intrusion which these rocks often exhibit, and which are scarcely more remarkable than the accidents presented by coal-seams in some disturbed and contorted areas."

This passage is an excellent example of the length to which an immoderate indulgence in a theory will produce mental intoxication. Dr. Hunt, I have reason to believe, has never set foot in Cornwall, and apparently is too "elevated" even to read my descriptions with any care; or he would see that the only meaning of this passage would be to assert that I have not had that field experience which enables me to offer an opinion on a petrological question. I do not like to speak of myself, still I may say that my experience is probably not less than his own, both in the examination of disturbed and contorted areas and in the study of the behaviour of intrusive igneous rocks; that the one great endeavour of my life has been, not to evolve geological facts from my moral consciousness, but to accept the teaching of Nature, whether it suited my theories or not; and that, having thrice visited Cornwall in this spirit, I simply repeat, that if there are any indications whatever on which we can rely for proving the intrusion of one rock in a plastic condition into another, these are exhibited by the serpentine of Cornwall.

I pass on to the other regions which I have visited.

*Anglesey.*—The evidence here does not, as in Cornwall, *prove* the serpentine to be intrusive, but accords far better with this explanation than with any other.

*Scotland.*—(Ayrshire) I do not think it possible to explain the appearances on any other theory than that of intrusion. (Portsoy) My visit was short; what I saw was favourable to the idea of intrusion, though it did not *prove* it.

*The Alps.*—Of six cases specially examined, in one case either

explanation was admissible, in four the serpentine was probably intrusive, in one certainly so.

*Italy.*—(Near Genoa) the serpentine is probably intrusive, (near Monte Ferrato) probably intrusive, (near Figline) intrusive. As Dr. Hunt has visited this last *massif*, I will repeat my reasons for maintaining the intrusive character in this case. A rough sketch of what I saw will be found in this MAGAZINE on p. 369 of Vol. VI. (Dec. II.). A little crag of bedded argillite overlies a mass of characteristic (though rather rotten) serpentine. The base of the crag is masked by a bank of débris, so that the actual junction could not be seen without excavation, but the sedimentary rock has been indurated and been cracked; it has, in short, that 'baked' look which is so familiar to any one who has worked much at junctions of igneous and argillaceous rocks, such, for instance, as we obtain among the Carboniferous rocks of the Central Valley in Scotland. These beds, however, within three or four feet vertically above the serpentine, contain organisms, among them probably *Polycystina*; though these, as we might expect from the proximity of an intrusive rock, are not very perfectly preserved. About six paces from this craglet, an isolated slab of dull red sedimentary rock still adhered to the serpentine. This I have examined under the microscope; it is an impure, somewhat crystalline limestone; its position and aspect, macroscopic and microscopic, seemed and still seem to me inexplicable on any hypothesis except that of the intrusion of the serpentine.

Dr. Hunt speaks of the existence of an *arenaria ophiolitica* as vouched for in other localities by Italian geologists; but knowing how vaguely this term is used, I must ask for more information before I can take it into consideration. He speaks also of having seen a breccia of serpentine at the base of the sedimentary rock. This certainly does not occur at the above locality, and from what I have elsewhere seen I would imitate his method of geological criticism so far as to ask whether it might not be explained otherwise than by sedimentation. Serpentine is a rock peculiarly liable to brecciation, and I have seen more than one curious breccia of it and the adjacent rock, which I had no doubt was due to subsequent crushing.<sup>1</sup> At any rate, whatever be the case elsewhere, here at Figline, I cannot explain what I saw on any other theory than that of an intrusion of the serpentine into the sedimentary group.

Next, as to the genesis of serpentine. Here I will simply recapitulate the evidence which I have set forth at great detail in various papers.

Olivine-gabbros and troktolites, which are frequently intrusive, illustrate perfectly the passage from olivine to serpentine in the case of that one mineral. Peridotites (like the lherzolite of the Ariège) show the first stages of the same change.

Serpentines like those of Coverack (Lizard), Levanto (Riviera), Sta. Caterina (Elba), Baste (Hartz), etc., often contain half the olivine still unchanged, and starting from these we can trace all stages of the alteration till every particle of the olivine has disappeared. I may add

<sup>1</sup> Serpentine under pressure sometimes assumes a schistose aspect. This has added to the difficulties of distinguishing the rock from simulative forms.

that both in associated minerals and in chemical analyses the serpentines and peridotites are closely related. Dr. Hunt, however, endeavours to show that the bulk of the peridotites are of sedimentary origin. Obviously the point is not settled by proving that olivine may occur in a sedimentary rock. We have mica in mica-traps and in mica-schist; quartz in felstones and in the geodes of sedimentary rocks; augite in dolerite and sahlite in crystalline limestone; hornblende in many rocks both metamorphic and igneous, etc. What, however, are the facts of the case? Dr. Hunt asserts the presence of olivine (but not, as it appears, the variety usually found in peridotites) in certain limestones of Eastern Massachusetts. Olivine is also said to occur in nodules in a talc-schist from the Urals, and in a talc-schist from Mount Ida; of these I have not seen specimens, but after reading the account in *Science* to which Dr. Hunt refers, I do not feel certain that in the latter instance we may not have a case of pseudo-schistose structure due to subsequent pressure, with the production in the more crushed parts of a serpentinous or talcose mineral. I may remark here that Dr. Hunt has forgotten to quote another part of the same authority,<sup>1</sup> where it is stated, "The serpentine in the anterior part of the Troad has been derived from olivine-estatite rock of a truly eruptive character."

Dr. Sterry Hunt's theory requires that serpentines should be all of Archæan age. Whether I am right or not in my view of the Italian serpentines,—and I must say that stratigraphically Dr. Hunt's view appears to me most improbable,—I must ask him to consider the case of the serpentine in Forfarshire, described long since by Sir Charles Lyell. I am assured by one of our best English geologists and petrologists that it indubitably forms a dyke in the Upper Old Red Sandstone, and I can myself answer for the rock being a true serpentine.

He relies also upon some cases of olivine rocks occurring in Norway. In all the accounts of these to which I have been able to obtain access, the evidence of a transition from the admitted schist to the peridotite appears to me defective. An apparently regular interbedding with sedimentary rock does not suffice, or we should have to assign a sedimentary origin to some Scotch basalts and pitchstones. Nor is some indication of a foliated structure conclusive; for that can be produced locally in an igneous rock when it is subjected to a pressure in one direction, while the structure of every olivine rock that I have seen in the field or examined with the microscope (including some of the Norway peridotites) is that of a rock of igneous origin.

This then is really the state of the case. Olivine (one of the most frequent constituents of meteorites) is an abundant mineral in rocks which must be of igneous origin; it is rare in those of sedimentary; many even of the cases alleged being so doubtful that we may perhaps be able to write—extremely rare. The structure of the olivine rocks, in those cases which are certainly intrusive, agrees with that of other cases which are at present uncertain. Many serpentines,

<sup>1</sup> *Science*, 1883, p. 255.

indubitably intrusive, exhibit a structure closely allied to that of peridotites and identical with that of other serpentines, where the evidence is inconclusive. Do we as yet know of any case where a well-marked and definite general structure is common both to a rock of sedimentary and to one of igneous origin? Is it not a legitimate conclusion, that serpentine is of a common origin with peridotite, and that the latter is one of the igneous rocks?

Hence I think I am justified in saying that, notwithstanding the ingenuity of Dr. Hunt's reasoning and his skilful special pleading, no theory regarding the origin of peridotites and serpentines can be held to be complete which does not take account of the fact that some of them are as fully proved to be intrusive rocks as any dolerite or basalt, felstone or trachyte.

---

#### V.—NOTE ON A GRAPHIC TABLE OF DIPS.

By R. D. OLDHAM, A.R.S.M.

THAT there is a wide-felt want, among field-geologists, of some rapid and sufficiently accurate method of solving such problems as arise in the ordinary course of their work is proved, if proof were necessary, by the summary of the literature bearing on this subject, given in the April Number of this Journal by Mr. Harker, who has certainly carried it to its highest point, for methods more simple than those given by him it is impossible to imagine. There is, however, a method, by which most of these problems can be solved by inspection without recourse to construction or calculation, which I would submit to the notice of geologists in general.

The problems arising in the ordinary course of field geology are mainly of four kinds: (1) where the true dip is known and the dip in the direction of a line of section is required; (2) where two apparent dips are known and the true dip is required; (3) problems connected with the outcrop of beds on sloping ground; and (4) those connected with the tilting of beds already inclined. I omit the obtaining of the thickness of a series of beds whose dip and breadth of outcrop are known, as the solution is self-evident to all who can understand what is meant by 'scale'; of these, class (1) is of by far the most frequent occurrence, while cases falling under heading (4) are somewhat rare. I propose describing my method of constructing what may be called a graphic table of dips by which all cases falling under heading (1) can be solved by inspection, and then passing on to an extension of the principle by which cases falling under headings (2) and (3) may be similarly solved.

Draw a square as *OABC* (Fig. 1), of convenient size, and with centre *O* and radius *OA* strike a quadrant inside the square; divide this quadrant into equiangular distances of convenient magnitude, and draw radii at those intervals from *O*, prolonging them till they cut the opposite sides of the square; from the points where the radii cut the side *AB*, perpendiculars are to be drawn to the base *OC*, and with centre *O* and radii equal to the distances so cut off a concentric

series of quadrants are to be drawn. The intervals cut off by this series of perpendiculars along the base  $OC$  form a scale of cotangents of the angles made by their respective radii with the base  $OC$ , or of tangents of the angles made with the side  $OA$ ; for convenience then we may graduate the base  $OC$  as a scale of cotangents, and the side  $OA$  as a scale of tangents, and graduating the radii according to the angles, they make with  $OC$  the graticule is complete.

In describing the use of this device, I shall refer to the point  $O$  as the point of *origin*, to the line  $OC$  as the *axis*, to the lines diverging from  $O$  as *radii*, and to the perpendiculars to  $OC$  as *normals* to the axis. Its use is as follows:—

(1) Given the direction and amount of the true dip, to find the apparent dip in any other given direction.

(a) When the dip does not exceed  $45^\circ$ . Take the point on the radius corresponding to the angular divergence of direction between the given and required dips, which represents the angle of dip according to the scale of tangents (as graduated along  $OA$ ), and follow the normal till it cuts the axis; the point of intersection gives the required angle of dip, using the scale of tangents as before.

*Example.*—A bed dips  $30^\circ$  to N.  $50^\circ$  E.; required its apparent dip to E.  $10^\circ$  S. The angular divergence being  $50^\circ$ , take the point where the  $30^\circ$  quadrant cuts the  $50^\circ$  radius, and follow the normal to the axis which it cuts at the intersection of the  $20^\circ$  quadrant; the dip required is therefore  $20^\circ$ .

(b) When the dip exceeds  $45^\circ$ . Take the point on the axis representing the given dip (using the scale of cotangents along  $OC$ ), and follow the normal till it intersects the radius corresponding to the angular divergence between the direction of the given and required dips; and the point of intersection will give the required angle of dip.

*Example.*—A bed dips  $70^\circ$  to N.  $10^\circ$  W.; required its dip to N.  $40^\circ$  E. The angle of divergence being  $50^\circ$ , take the point representing  $70^\circ$  on the axis and follow the normal till it cuts the radius of  $50^\circ$  at the intersection with the  $60^\circ$  circle;  $60^\circ$  is consequently the required dip.

Should the intersection of the normal and radius not fall within the square, a different procedure must be adopted. In this case the normal from the point where the radius corresponding to the divergence cuts the outer quadrant (that of  $45^\circ$ ) must be followed to the axis, and the distance between the intersections with the axis and the radius corresponding to the true dip if laid off from  $C$  along  $CB$  will give the required angle of dip; or a line may be drawn parallel to the axis through the point of intersection with the radius representing the dip, and the point where it cuts the scale on  $CB$  will give the required dip. For the ready application of this method it would be advisable to have a series of lines parallel to  $OC$ , which, to prevent confusion, I have not inserted in the diagram.

*Example.*—A bed dips  $50^\circ$  to N.E.; required its dip to N.  $10^\circ$  W. The angle of divergence being  $55^\circ$ , take the point where the  $55^\circ$  radius cuts the  $45^\circ$  quadrant, and follow the normal till it cuts the  $50^\circ$  radius, and from that point follow a line parallel to the axis

(dotted in Fig. 1) till it cuts the side *BC* at  $34^\circ$  from *C*;  $34^\circ$  is the required dip.

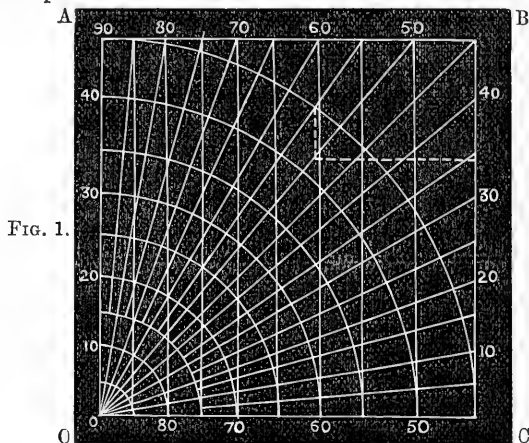


FIG. 1.

This method is in principle rigidly accurate, but the degree of accuracy attainable in practice depends on the scale of the graticule and the degree of care with which it is applied.

For the solution of the other classes of problems, the scale of tangents and co-tangents require to be extended so as to embrace at least  $60^\circ$  of the quadrant and we require the circle round *O* to be completed; in Fig. 2 I have given one-half only, as this will be sufficient for explanatory purposes.

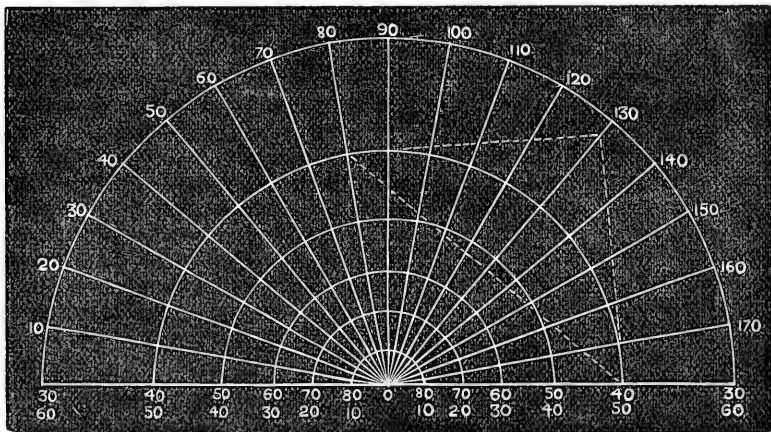


FIG. 2.

(2) Given the apparent dip in two directions; required the direction and amount of the true dip.

(a) When both the dips are greater than the minimum angle on the scale of cotangents; the said scale to be used throughout. On

a piece of tracing paper draw two straight lines crossing each other at right angles; place this on the graticule in a position such that one of the lines shall cut the two radii representing the given directions of dip at points corresponding to their respective angles, and the other lie over the origin, then the point of intersection will give the direction and amount of the true dip. This method is represented by the dotted line in Fig. 2.

(*b*) When both the given dips are less than the maximum angle on the scale of tangents; the said scale to be used throughout. Take two pieces of paper whose edges are truly square, and lay one with its edge along the radius representing the direction of one of the given dips, and its corner at the point corresponding to the dip in that direction, and lay the other in a corresponding position on the radius representing the second direction of given dip, then the intersection of the free edges will give the direction and amount of the true dip. This method is represented by broken lines in Fig. 2.

It will be seen that neither of these methods are applicable in every case, but only when both the dips fall on to a single scale; but as the scale can be extended so as to embrace  $70^\circ$  of the quadrant without becoming cumbrous, one or other method will be applicable in every case likely to occur in practice.

(3) Given the dip of a bed and the slope of the ground, to determine the direction of its outcrop. The methods given under (2) are to be employed, but in the reverse manner, viz. that described under (2*b*), where the scale of cotangents has to be used, and that under (2*a*), where the scale of tangents must be used.

If the direction of outcrop and of the slope of the ground be given, the true dip can be obtained by first determining the respective angles of slope in the given directions of outcrop as described under heading (1), and then combining these by methods (2*a*) or (2*b*) as may be most suitable. Any other modification of these, which are all that ordinarily occur in practice, are too obvious to necessitate a detailed description.

As regards problems falling under heading (4), viz. those connected with the tilting of already inclined beds, Mr. Harker's method can be followed, on the graticule I have described, by means of a piece of tracing paper, but this method is cumbrous, presents no advantage whatever over a direct and purely graphical solution, a matter of the less consequence, as the interest of these problems is rather fanciful than practical, the data required for their solution being seldom or never obtainable.

## VI.—THE RHÆTIC SECTION AT WIGSTON, LEICESTERSHIRE.

By E. WILSON, F.G.S., and H. E. QUILTER.

**A**LTHOUGH Rhætic rocks have already been noticed at one or two points in Leicestershire, viz. at Leicester by Mr. W. J. Harrison and between Barrow and Sileby by Mr. Etheridge,<sup>1</sup> the complete sequence of this series has not hitherto been observed in that county. Very recently our attention has been directed to a

<sup>1</sup> Quart. Journ. Geol. Soc. vol. xxxii. p. 212; GEOL. MAG. 1874, p. 480.

section at Wigston, near Leicester, which exhibits, not only the whole thickness of these beds, but also clearly shows their relationship to the overlying Lias and underlying Triassic rocks, and which for an inland section must therefore be considered as quite unique in this country.

At the large brick and tile works of Messrs. Healey & Co., close to the new London and N. W. Railway Station of Glen Parva (about four miles south of Leicester), the Rhætics are exposed in two contiguous clay pits, both of which are in work at the present time. The more westerly of these pits—the one we purpose specially to refer to, and of which we give a detailed section—shows, Keuper marls 30 ft. succeeded by Rhætic shales 40 ft., and Lias limestone 1 ft., with a capping of Boulder-clay which varies at the expense of the underlying rocks from 8 to 27 feet in thickness.

## SECTION OF RHÆTICS, ETC., AT WIGSTON, NEAR LEICESTER.

		ft.	in.	ft.	in.
BOULDER-CLAY.	{ Red Clay, Sand, and Boulders .....	8	0	to	27
8 0	{ Limestone, thinly laminated, with <i>Am. planorbis</i> , <i>O. Liassica</i> , <i>Gryphæa arcuata</i> , <i>Lima gigantea</i> , etc.....				1 0
LOWER LIAS.	{ Limestone, nodular, yellow, blue-centred.....				1 0
1 0	{ Shales, blue, thickly laminated, earthy .....				5 0
RHÆTIC	{ Shales, ,, ,, sandy and micaceous with scattered pyritic nodules... ..				4 9
	{ Shales, ,, ,, earthy, with sandy partings .....				1 9
UP. RHÆTIC	{ Shales, ,, ,, break up into thin laminæ .....				1 4
SHALES OR	{ Shales, ,, thinly laminated, with lenticular pyritic seams .....				2 4
WHITE LIAS	{ Shales, ,, with thin seams of sandstone, and band of limestone nodules at base.....				0 10
22 5	{ Shales, ,, thinly laminated, with thin seams of sandstones .....				3 0
	{ Limestone, ,, nodular, light-coloured, septariform .....				0 5
	{ Shales, ,, ,, passing down into ... ..				2 0
	{ Shales, black, with thin sandstone seams and sandy shales below, with <i>Axinus cloacinus</i> .....				4 10
	{ Shales, black, thickly laminated: limestone nodules, dark blue, septariform. at wide intervals .....				6 0
LOWER	{ Shales, black, thinly laminated, sandy, with <i>Axinus cloacinus</i> .....				3 8
RHÆTIC, OR	{ Shales, black, thickly laminated, with <i>Cardium Rhæticum</i> .....				1 0
<i>A. contorta</i>	{ Shales, black, thinly laminated, with <i>Cassianella contorta</i> , <i>Axinus cloacinus</i> , <i>Gyrolepis</i> .....				0 7
shales.	{ Shales, black, thickly laminated, with <i>Cardium Rhæticum</i> .....				1 9
17 10	{ Sandy seam, thin, local or sandy pockets, with <i>Aerodus minimus</i> , <i>Hybodus minor</i> , <i>Gyrolepis</i> , <i>Saurichthys</i> , <i>Nemacanthus</i> .....				
KEUPER	{ <i>Tea-green Marls</i> , light grey Marls—breaking up into cuboidal pieces, with three or four harder bands of marlstone, passing down into .....				15 5
15 5	{ <i>Red Marls</i> .—Red and grey marls .....				2 11
	{ Red, grey and mottled marlstones.....				3 4
	{ Red marls with gypsum .....				3 0
14 6	{ Grey marlstone with thin seam of gypsum .....				1 5
	{ Grey marl and gypsum .....				1 0
	{ Red marl and gypsum .....				2 0

A feature that will at first glance strike any one familiar with



the Rhætic rocks of the adjoining counties of Nottingham and Lincoln, or of Warwick and Gloucester, is the great apparent uniformity in mineral character of these beds in this unweathered section, and the absence of any hard beds, either of sandstone or limestone, with the exception of a band of nodular limestone at the top, and two or three seams of limestone nodules in the lower portion of the series. Closer examination, however, enables us to divide this mass of dark laminated shales into two groups: (1) a Lower Series, *A. contorta beds* or *Paper Shales*, consisting of some 18 ft. of black thinly-laminated, more or less fossiliferous shales; and (2) an Upper Series, *Upper Rhætic Shales* or *White Lias*, consisting of about 22 ft. of blue thickly-laminated earthy unfossiliferous shales, with occasional seams or scattered nodules of limestone; and to subdivide each of these members into the several beds indicated in the above section. There is no true "Bone Bed," but at the base of the Paper Shales we notice a thin, evanescent seam of white sand, containing scattered teeth, scales, coprolites, and pebbles, which may represent a Bone Bed occurring at a similar horizon elsewhere. Comparing the lower portion of this section with the incomplete Rhætic section at the north end of the Spinney Hills, Leicester, described by Mr. Harrison about eight years ago, we note a general agreement in lithological character and organic remains, except that at Wigston the Rhætic Shales have apparently a somewhat greater development.<sup>1</sup>

Although, at several horizons in the Paper Shales, we find the dwarfed shells which specially characterize these rocks present in numbers, the variety in species is hardly so great as might have been expected, considering the ample facilities here given for their examination. The "White Lias," as usual, at any rate in this part of the country, is almost entirely destitute of organic remains. The presence of that interesting little starfish *Ophiolepis Damesii*, first found at Leicester by Mr. Harrison, was indicated by the cast of a single ray; but we have not been able to determine its exact horizon. We have found several fishes, chiefly in weathered shales, and badly preserved. They occur at a distinct horizon, viz. from 3' 6" to 3' 9" above the base of the Paper Shales. Their identification has not yet been made out.

The junction of the Paper Shales with the underlying beds, the "Tea-green marls" of Etheridge, is sharply defined, though the line is level, and the two sets of beds are apparently conformable to each other. On the other hand, these "Tea-green marls" imperceptibly graduate down into gypsiferous red, green, and mottled Keuper marls, having similar lithological characters. We have, therefore, no hesitation whatever in adhering to the opinion here-

<sup>1</sup> We cannot, however, accept as correct Mr. Harrison's description of a band of septariform nodules with *Estheria*, in situ, at so little as 10 feet from the base of the Paper Shales. No such bed is now to be seen on the Spinney Hills and no analogous bed, or *Estheria*, occur at this horizon at Wigston. The Rhætics on the Spinney Hills are capped by glacial drift. We consider that the nodules referred to by Mr. Harrison (*loc. cit.*) must have been displaced by glacial action from a higher level.

tofore expressed by one of us on this point<sup>1</sup> and classing these "Tea-green marls" also as Keuper.

In the smaller pit a few more feet of Lias are shown than in the larger one. Resting on the Rhætic Shales, of which some 16 or 17 feet are here exposed, and sharply defined therefrom, come a few thin bands of alternating fine and coarse-grained flaggy limestones and fissile shales, 1' 9" in thickness, containing *Am. planorbis*, *Gryphea arcuata*, *Ostrea Liassica*, *Lima gigantea*, *Pecten* sp., *Serpula* sp., the coarser seams being entirely made up of shell-fragments, joints of *Pentacrinus psilonota*, and the plates and spines of *Cidaris Edwardsii*. Above the limestone there are exposed in this pit about 7 feet of thinly-laminated blue shales.

The dip of the rocks is about 2° in a north-east direction. A small fault with downthrow on the east crosses the larger pit near the foot of the tramway.

The Boulder-clay rests in a cavity worn out of the Lower Lias and Upper Rhætic shales. It consists mainly of recomposed Keuper Marl and contains boulders of quartzite slate and granite, Keuper sandstone, Rhætic and Lias limestone—beautifully smoothed and striated—also ironstone nodules, and an occasional chalk flint. As is usual in this district, the Boulder-clay contains pockets of ferruginous pebbly sand.

At the brick-yard the whole of the different clays are worked up together, viz. Boulder-clay, Upper and Lower Rhætic Shales and Keuper Tea-green and Red Marls, the coarser fragments of the Boulder-clay, and the Rhætic and Lias limestone having been previously picked out. This combination-clay is manufactured into bricks, drain-pipes, tiles and ornamental pottery.

Mr. Healey, to whom we are indebted for every facility for examining the above sections, informs us that it is probable that before very long the smaller pit will be deepened. If so, they will strike into the Paper Shales, and give geologists another fine section of these interesting rocks.

## R E V I E W S.

### THE BERLIN ARCHÆOPTERYX.

(PLATE XIV.)

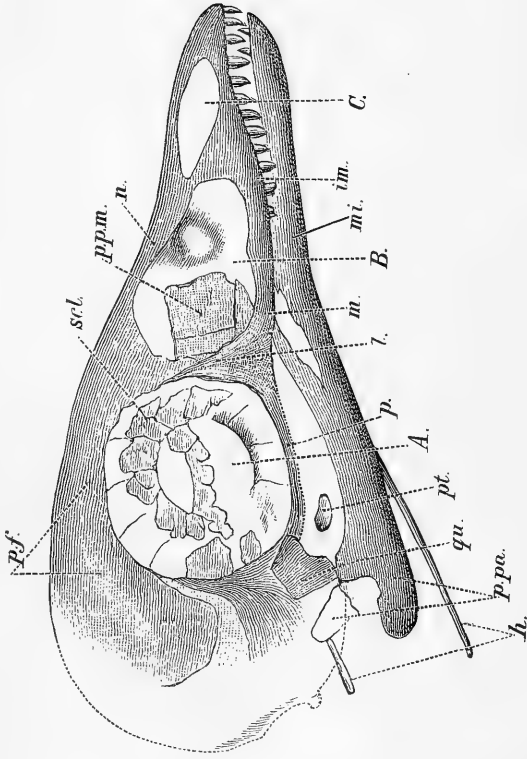
I.—UEBER ARCHÆOPTERYX VON W. DAMES. PALÆONTOLOGISCHE ABHANDLUNGEN, zweiter Band, Heft 3. 4to. pp. 119—196. Mit. 1 Tafel und 5 Holzschnitten. (Berlin, 1884.)

THE announcement in 1862<sup>2</sup> of the discovery of a nearly entire skeleton of a most remarkable long-tailed Bird, clothed with feathers, in the Lithographic Stone of Pappenheim in Bavaria, named by Prof. Owen *Archæopteryx macrura*, produced a most profound sensation amongst biologists generally. A single feather had, it is true, been already discovered in this formation in 1860, and named by

<sup>1</sup> Quart. Journ. Geol. Soc. vol. xxxviii. p. 451.

<sup>2</sup> "On a Feathered Fossil from the Lithographic Limestone of Solenhofen lately acquired for the British Museum," by Henry Woodward, "Intellectual Observer," vol. ii. No. v. December, 1862, pp. 313—319, with a coloured plate. See also H. Woodward, "Intellectual Observer," 1863, pp. 443—451.





A. The Orbit. B. Antorbital foramen. C. Nasal opening  
*Pf.*, parietal and frontal; *n.* nasal; *im.* intermaxillary; *l.* lacrimal; *m.* maxillary; *pp.m.* palatine process of the maxilla;  
*p.* palatine; *pt.* pterygoid; *qu.* quadrate bone; *scl.* sclerotic plates of eye; *mi.* lower jaw; *p.pa.* post-articular process of  
 mandible; *h.* hyoid bones.

HEAD OF THE BERLIN ARCHÆOPTERYX. Enlarged twice nat. size. (After W. DAMES).

Hermann von Meyer<sup>1</sup> as *Archæopteryx lithographica*; but that this single feather had belonged to so remarkable a creature was never imagined by any one.

When a description of the nearly entire animal was sent by M. Witte, of Hanover, and the late Dr. Oppel, to Dr. Andreas Wagner, in 1861, that anatomist at once pronounced it to be a fossil Reptile, and named it *Griphosaurus*!<sup>2</sup> The subsequent discovery of a portion of a maxillary or premaxillary bone bearing several small teeth, imbedded close to the feathered fossil in the same slab,<sup>3</sup> seemed to lend confirmation to this view; birds with teeth being then unknown.

Thanks, however, to the later researches of Prof. O. C. Marsh, which have led to the discovery of no fewer than nine genera and twenty species of toothed birds from the Middle Cretaceous of Kansas, and Colorado, in North America,<sup>4</sup> we now know that these earlier birds were all almost certainly furnished with teeth in both the upper and lower mandibles.

The absence of the complete head and of the neck in the original specimen of *Archæopteryx* described by Professor (now Sir Richard) Owen<sup>5</sup> left of course much to be desired to be known further concerning this singular Jurassic ornitholite.

It created no small degree of excitement when in 1877 it became known that a second example of this curious type of long-tailed Bird had actually been discovered in the same Lithographic Stone at Blumenberg near Eichstätt in Bavaria, and that it was offered for sale for £1000! After some long delay, this rare ornithological fossil has found a resting-place among the other palæontological treasures of the Berlin Museum.

It is a very fortunate circumstance that the parts which are wanting in the original *Archæopteryx* preserved in the British Museum are present in the Berlin specimen, and that in the pelvis, the hindlimbs and the more perfect tail we are enabled to add valuable anatomical details to the Berlin example.

Prof. Carl Vogt was one of the first to give a dissertation upon the Berlin *Archæopteryx*, a summary of which appeared in the GEOLOGICAL MAGAZINE for 1881, p. 300.

Professor H. G. Seeley, F.R.S., contributed a further paper thereon in the same year (*op. cit.* 1881, p. 454), accompanied by a reduced figure of the fossil (Pl. XII.). Prof. O. C. Marsh added some

<sup>1</sup> Palæontographica, vol. x. p. 53.

<sup>2</sup> Sitzungsberichte der Münchner Akad. der Wiss. 1861, p. 146.

<sup>3</sup> "On portions of a Cranium and of a Jaw in the Slab containing the *Archæopteryx*," by John Evans, D.C.L., LL.D., F.R.S., F.G.S., "Natural History Review," July, 1865, p. 415. See also article on "Birds with Teeth," in Popular Science Review, Oct. 1875, vol. xiv. No. 57, p. 337, pl. cxxv, by Dr. H. Woodward, F.R.S., etc.

<sup>4</sup> See "Odontornithes, a Monograph on the Extinct Toothed Birds of North America," by Prof. O. C. Marsh, M.A., F.G.S., 1880. Royal 4to. pp. 202. with 34 plates and 40 woodcuts.

<sup>5</sup> "On the *Archæopteryx* of von Meyer with a Description of the Fossil Remains of a Long-tailed Species from the Lithographic Stone of Solenhofen," by Prof. Owen, F.R.S. Read before the Royal Society of London, 20th November, 1862, published in Phil. Trans. for 1863, pp. 33—48, with four plates.

observations in a paper entitled "Jurassic Birds and their Allies" (see *GEOL. MAG.* 1881, p. 485). Lastly Herr W. Dames communicated a paper to the Berlin Academy in July 1882, "On the Structure of the Head of *Archæopteryx*" (see *GEOL. MAG.* 1882, pp. 566-568).

We have now the satisfaction to announce the issue of Prof. Dames' completed Memoir, accompanied by a large folding chromolithographic plate giving a life-size figure of the fossil and five woodcuts of parts of the structure.

#### THE HEAD (see Plate XIV.).<sup>1</sup>

As the head is of the first importance, we make no apology for giving a detailed account of this structure from Prof. Dames' Memoir.

The author writes: "Since the appearance of my paper in the 'Academie der Wissenschaften' in July, 1882, I have studied the skull of the *Archæopteryx* more carefully and have developed the teeth. The result which I have arrived at is that the entire length of the skull may now be clearly seen from the articulation of the jaw to the point of the beak.

I have now also established certainly what Prof. O. C. Marsh and I had already conjectured, that there are teeth in the *lower jaw* as well as in the upper.

As the back portion of the skull is unfortunately not preserved, it is impossible to give the exact measurement; still it may have been about 45 mm. from the occipital condyle to the point of the beak. But with the exception of the injury to the back of the skull and the fracture of some of the bones, caused by the compression of the skull in the matrix, it is so well preserved as to allow a very fair representation of it to be given. It lies upon its left side, so that the right is exposed. The profile thus seen commences somewhat behind the eye in a flattened curve, which continues till about the middle of the antorbital vacuity. From this point it is straighter, and from the nasal foramen sinks with a sharper curve to the point of the beak. In the side from front to back are three large openings. The most backward is the orbital foramen, sharply defined along its anterior superior and posterior margin, and measuring 14 mm. in diameter;<sup>2</sup> the lower edge is indicated by the impression of the sclerotic plates. Within this opening, near its margin, lies a ring of irregular four-sided sclerotic plates, which overlap one another like scales, so that nearly one-third of each plate is hidden by the next. The single plates are too much broken, the edges being quite gone in many places, to tell their exact number; some fragments adhere to the *counterpart*, those of the lower border are displaced and lie across the opening for the pupil. Their number may have been twelve. The open space for the eye within these plates measures 7 mm. across, the length of the single plates 3-5 mm.

<sup>1</sup> We are indebted to the courtesy of Herr Prof. W. Dames for the use of the illustration of the head of *Archæopteryx* from his Memoir.—*EDIT. GEOL. MAG.*

<sup>2</sup> The complete bony boundary of the orbit is rare in recent birds (the *Psittacidae* e.g., see Owen's *Anat. Verts.* vol. ii. p. 51, fig. 30). In *Archæopteryx* it seems to have been continuous around the orbit.

The eye is surrounded above and behind by bony fragments, in the centre of which lies a suture (not clearly definable). It is present in all adult birds, uniting the frontal and parietal bones which inclose the brain. At the union of these two bones, the skull is broken away, showing that the brain-cavity is filled with calc-spar. Although the bones behind the eye are much injured and displaced, they may still be made out; the temporal fossa is not present, but the brain was incased in a compact bony covering, such as is characteristic of the skulls of living birds. The greater part of the brain lay behind the eye, in which the head of *Archæopteryx* agrees well with living birds. The frontal bone seems to continue forward from above the orbit as far as the middle of the antorbital vacuity; at least no suture is visible. The antorbital vacuity expands upwards posteriorly, narrows in the middle, and expands somewhat towards the front.<sup>1</sup> Its posterior margin forms the front border of the orbit. This I term the lachrymal bone; it unites with the maxillary bone. It is probable that the upper border of this opening is divided from the nasal, but, as with the frontal bone, no suture is observable. The lower border must have been formed by the maxillary, and in part also by the intermaxillary; but as the bone is here much broken, no very accurate border can be given. Its form is that of a right angle triangle, with rounded points. The length is 9 mm., the height 8 mm. Within the antorbital vacuity lies an irregular four-sided piece of bone; in my former notice of the skull I thought this was due to compression; now that it is more fully developed, I am enabled to say more decidedly that this piece of bone is the palatine process of the maxilla. There appear to be two pieces of bone resting upon one another; the lower perhaps is a part of the vomer or one of the median septa. But a more accurate determination is prevented by the state of preservation of the specimen. Immediately in front of the antorbital vacuity lies the third opening, the nasal foramen. It has a lengthened elliptical form somewhat pointed at the ends. It lies lengthwise, nearly parallel to the upper edge of the skull, and is 8 mm. long, its greatest breadth being 4 mm. The nasal foramen is bordered above by scarcely 1 mm. width of bone, the forward continuation of the nasal bones or else the ascending ridge of the intermaxillary. Its border passes under and forward from the intermaxillary. There are still the following parts of the skull to describe. There is a long bone scarcely 1 mm. wide joining the lower end of the bone I call the lachrymal; it extends in a straight line towards the back of the skull, its upper part was covered with matrix; its length and form suggest it to be the quadratojugal; but

<sup>1</sup> The antorbital vacuity in most recent birds is confluent with the anterior nasal foramen (e.g. *Alca*, *Aptornis*, *Dinornis*), not distinctly separated as in *Archæopteryx*. *Didus* shows a bar between the vacuities, but in *Pezophaps* it is wanting. In *Apteryx* the anterior nostril is most remote from the antorbital vacuity. (See Owen's *Extinct Wingless Birds*, pl. i. fig. 1, pl. lxxxiii. fig. 1, pl. lxxv. fig. 1, pl. viii.) *Odontopteryx* (Q. J. G. S. vol. xxix. pl. xvi. fig. 2*n*) shows an extensive tract of bone between the nostril (*n*) and the antorbital vacuity (73, fig. 8), the corresponding dividing plate between the antorbital and nasal openings in *Archæopteryx* is narrow when compared with *Odontopteryx*, the antorbital vacuity being very large in the former.

as it passes under the sclerotic ring, and does not extend so far as the quadrate bone, it must be a part of the palatine-bone. The quadrate bone may be easily known from its size, and also by its articulation with the lower jaw; there also appears to be an inner flattened continuation, but it is not distinct enough to allow of identification. Lastly, there is the little piece of bone which lies in front of the quadrate bone, between the upper edge of the lower jaw and the palatine. Its outline is an elongated oval; it is arched and smooth. From its length it belonged to the pterygoid.

#### THE TEETH.

Even before the removal of the matrix that covered the front part of the head, it was apparent that the *Archæopteryx* was furnished with teeth; one could see with a lens two small shining bodies under the antorbital vacuity, as stated by Carl Vogt and also by Prof. Marsh. In my notice of the head, I stated that a row of ten teeth were seen, and that probably more might be found, which has subsequently proved to be correct. The teeth are seen to be continuous quite to the extremity of the beak, and the matrix which covered them having been carefully removed with fine needle-points, this part of the skull is in the best state of preservation. The edge of the jaw carrying the teeth is 16 mm. long, and extends from the point of the beak to nearly the middle of the antorbital vacuity. There are 12 teeth in the row, originally there were 13; but the last tooth, which, from its position, was clearly visible, is broken off at the edge of the jaw, and cannot now be seen. These 12 teeth are almost of equal size and shape, measuring 1 mm. in length and 0·5 mm. in width; the upper part is cylindrical, and the lower half tapers rather abruptly to a point, the sharp point; bends rather under and inwards.

Their surfaces are polished and smooth, and show no ribs or furrows; but when magnified, some minute vertical lines may be seen on the anterior teeth, but they are not wider than cracks in the enamel. The fifth and sixth teeth from the front are somewhat smaller than the rest, and here the edge of the jaw bends forward, and the upper part of the skull visibly projects, as if a little displaced; so it is not unlikely that here lies the boundary between the maxillary and the intermaxillary bones. If this is the case, then six of the teeth are inserted in the intermaxillary, and seven in the maxillary. Prof. Marsh had expressed his opinion that the teeth stood in a groove, as in *Hesperornis*. This idea I cannot share, but consider it certain that the teeth are implanted in distinct *alveoli*. The *alveoli* have not been actually seen, but it seems impossible that a set of teeth, which stood in separate places in the jaw, could have occupied one and the same groove, as in *Hesperornis*. All the teeth are in their original places standing perpendicular with their roots, fast in the edge of the jaw; all the teeth have clear interspaces between them; they are also in their original places with regard to one another. This seems to me to prove satisfactorily that every tooth stands with its roots in a separate *alveolus*.



THE LOWER JAW retains its articulation with the skull by means of the quadrate bone. It is a long and narrow bone; the lower border is curved very gradually upwards; it is broader behind than in front.

Breadth at the articulation	... ..	4.5 mm.
"    below the lachrymal	.. .. .	3.5 "
"    "    last tooth in upper jaw		2.75 "
"    "    4th "		2.0 "

Behind the articulation with the quadrate bone, there is a post-articular process which is 4 mm. long and 2 mm. high; the entire length from the posterior extremity to the symphysis is 35 mm. That with such decided dentition as that of the maxillary and intermaxillary, the lower jaw could not be toothless, both Marsh and I foresaw. The jaw, however, is attached to the specimen as if the beak was closed, so that little is to be seen of the dentition. To my great joy I have succeeded in finding the point of a tooth directed upwards between the 3rd and 4th intermaxillary teeth; also under the 3rd tooth of the upper jaw, on the edge of the lower jaw, stands the broken remains of a tooth, and lastly a tooth may be perceived under the antorbital vacuity behind the teeth of the upper jaw. So much may be generally stated of the teeth of the lower jaw. That there were teeth in front, and also in the middle of the border of the jaw, may be assumed with great certainty, that in fact the lower jaw had teeth corresponding to those in the upper. It is not easy to say if there was a vacuity in the middle of the lower mandible. In one place in the back part, the matrix is seen; but the edges of this opening are so irregular and broken that one inclines more to the opinion that this opening is simply a hole broken through the surface of the jaw. Unfortunately, the counterpart, which might have proved this, is missing. Lastly, there are two little needle-like bones belonging to the head, which from their form and length can be none other than the hyoid bones. One lies below the posterior border of the under jaw, and projects backwards beyond it where it is broken off, whilst in front it is hidden beneath the lower jaw, so that its full length cannot be ascertained; the piece seen is 14 mm. long. The other bone lies higher up above the lower jaw, and behind the quadrate bone; it is nearly parallel to and like that already noticed; it is 3 mm. long; it is most probably a part of the hyoid bone of the left side. This bone lies in front of a fragment of another bone that I am disposed to call the post-articularis of the left side of the lower jaw.

The foregoing description of the skull and lower jaw of *Archæopteryx* leaves some parts still hypothetical, owing to the state of its preservation. This is particularly the case as regards the back part of the skull, and also the separate elements of which it is composed. Still a more or less exact picture is given, which on the whole bears many analogies with the skulls of living birds.

That it is a true bird's head is apparent, although the presence of teeth seems anomalous. But the researches of Prof. Marsh had already proved the presence of numerous Birds with teeth in the Cretaceous epoch. The *Archæopteryx* seems, however, to be more

closely connected with living birds than with those of the Chalk period which were also armed with teeth.

Prof. Carl Vogt was the first to give a short description of the head which is on the whole correct.

There is no 'occipital crest' to the skull as mentioned by Prof. Seeley (GEOL. MAG. 1881, p. 455).

The errors in description made by Vogt and Marsh arose from the fact that they both saw the Berlin *Archæopteryx* before it was fully developed. Prof. Seeley saw only the photograph."<sup>1</sup>

II. — TEXT-BOOK OF DESCRIPTIVE MINERALOGY. By HILARY BAUERMAN, F.G.S., Associate of the Royal School of Mines. 8vo. pp. 400. (Longmans, Green & Co., London, 1884.)

IN the previous part of this work, the Text-Book of Systematic Mineralogy, it was my unpleasant duty as a reviewer, to point out some very serious faults: to-day my task is the infinitely more agreeable one of stating that the part now issued is a very welcome addition to the literature available for the students of our colleges and schools. Mr. Bauerman's wide acquaintance, not only with minerals as specimens, but with their principal localities and their economic uses, has enabled him to produce a work which is far from being a simple compilation. The classification is a modern one, and is virtually based on the crystallo-chemical system of Gustav Rose, adopted in 1859 for the arrangement of the British Museum collection. As stated in the preface, the figures have been obtained from the wood-blocks employed in Brooke and Miller's edition of Phillips' Mineralogy, and are extremely well done. Misprints are few and far between, especially when one remembers the difficulty of correcting the proofs of such a work. This text-book will meet with deserved success.

L. FLETCHER.

III.—MEMOIRS OF THE GEOLOGICAL SURVEY OF INDIA. PALEONTOLOGIA INDICA. (Series X.). INDIAN TERTIARY AND POST-TERTIARY VERTEBRATA. Imperial 4to. Vols. I. and II. complete; and Vol. III. Parts I. II. and III. issued.<sup>2</sup>

IT is once more our pleasant task to congratulate Mr. Medlicott, the Superintendent of the Geological Survey of India, on the success which has attended the work of the Survey over which he presides during the past ten years, more especially in reference to the magnificent series of publications which are issued under his auspices.

<sup>1</sup> Translated from the German by E. C. Woodward.

<sup>2</sup> The following memoirs of Series X. Indian Tertiary and Post-Tertiary Vertebrata, have appeared:—

VOL. I. pp. xxx. 300, pls. 50 (complete).

„ pt. 1 (1874). *Rhinoceros deccanensis*, by R. B. FOOTE, pp. 18, pls. 3.

„ „ 2 (1877). Molar teeth and other remains of Mammalia, by R. LYDEKKER, pp. 69 (19-37), pls. 7 (iv.-x.).

„ „ 3 (1878). Crania of Ruminants, by R. LYDEKKER, pp. 84 (88-171), pls. 18 (xxix.-xlvi.).

„ „ 4 (1880). Supplement to pt. 3, pp. 10 (172-181), pls. 3 (xxi. a, b, xxiii. a).

Besides the series of Memoirs on Indian Vertebrate Fossils specially referred to here, the Survey has issued memoirs on the Cephalopoda, Gasteropoda, Pelecypoda, the Brachiopoda, Echinodermata and Corals of the Cretaceous formation of Southern India; the Fossil Flora of the Gondwana system, the Jurassic Fauna (Cephalopoda) of Kach, the Tertiary and Upper Cretaceous Fauna of Western India, comprising the Fossil Crabs, by F. Stoliczka, Corals and Alcyonaria, and the fossil Echinoidea, by Messrs. Duncan and Sladen, the Salt-range Fossils by William Waagen.

There have also been published (under series iv.), 3 parts of vol. i. on "Indian Pretertiary Vertebrata," comprising Dicyodont and Labyrinthodont remains from the Panchet rocks, by Prof. T. H. Huxley, F.R.S.; Ganoid Fishes from the Deccan by the late Sir P. Grey-Egerton, and *Ceratodus* teeth from Maledi by L. C. Miall. Lastly, Fossil Reptilia and Batrachia, by R. Lydekker, B.A.<sup>1</sup>

If we except part I of vol. i. on *Rhinoceros deccanensis*, by R. Bruce Foote, F.G.S., the whole of the monographs comprised in series x. has been the result of the labours of Mr. R. Lydekker, B.A., F.G.S., who has devoted the past eight years to the elucidation of the Vertebrate Palæontology of India with the most satisfactory results.

The two volumes, already completed, and the three parts of volume iii. represent together 843 pages of letterpress, illustrated by 110 large plates (many of which are folding plates), besides numerous woodcuts in the text.

The following is a list of the genera and species which have been figured and described in this work by its author. As most of the species are represented by specimens in the fine collection of Siwalik Hill fossils brought together by Sir Proby T. Cautley and Dr. Hugh Falconer and preserved in the Geological Department of the British Museum (Natural History), the work cannot fail to interest English as well as Indian students of palæontology.

- VOL. I. pt. 5 (1880). Siwalik and Narbada Proboscidea, by R. LYDEKKER, pp. 119 (182-300), pls. 19 (xxix.-xlvi. 35 *bis*).
- VOL. II. pp. xvi. 363, pls. 47 (*complete*), by R. LYDEKKER.
- „ pt. 1 (1881). Siwalik Rhinocerotidæ, pp. 62, pls. 11 (1 double—*ii*a.).
- „ „ 2 (1881). Supplement to Siwalik and Narbada Proboscidea, pp. 4 (63-66).
- „ „ 3 (1883). Siwalik and Narbada Equidæ, pp. 32 (67-98), pls. 5 (xi.-xv.).
- „ „ 4 (1883). Siwalik Camelopardalidæ, pp. 43 (99-141), pls. 7 (xvi.-xxii.) (1 double).
- „ „ 5 (1883). Siwalik Selenodont Suina, etc., pp. 35 (142-177), pls. 3 (xxiii.-xxv.).
- „ „ 6 (1884). Siwalik and Narbada Carnivora, pp. 186 (178-363), pls. 21 (xxvi.-xlv. with xxxv*a*.) (1 double).
- VOL. III. pt. 1 (1884). Additional Siwalik Perissodactyla and Proboscidea, by R. LYDEKKER, pp. 34, pls. 5.
- „ „ 2 (1884). Siwalik and Narbada Bunodont Suina, by R. LYDEKKER, pp. 70, pls. 7 (vi.-xii.).
- „ „ 3 (1884). Rodents and New Ruminants from the Siwaliks, and Synopsis of Mammalia, by R. LYDEKKER, pp. 30, pl. 1.

<sup>1</sup> Besides the 15 4to. volumes of the "Palæontologia Indica," there have been published 22 volumes of Memoirs on the Geology of the various regions surveyed, illustrated by maps and sections and 65 numbers of the "Records of the Geological Survey of India" (published quarterly).

## SYNOPSIS OF SIWALIK AND NARBADA MAMMALIA.

## Class MAMMALIA.

## I. Order PRIMATES.

## A. Sub-Order ANTHROPOIDEA.

## a. Family SIMIIDÆ.

1. *Palaopithecus sivalensis*, Lyd. Si-  
[walik.

## b. Family CERCOPITHECIDÆ.

2. *Semnopithecus palæindicus*, Lyd.,,  
3. *Macacus sivalensis*, Lyd. ,,  
4. *Cynocephalus subhimalayanus*, H.  
Meyer, sp. Siwalik.  
5. — sp. ,,

II. Order CARNIVORA (*Carnivora Vera*).

## c. Family FELIDÆ.

6. *Machærodus sivalensis*, Falc. and  
Caut. sp. Siwalik.  
7. — *palæindicus*, Bose ,,  
8. *Felis cristata*, Falc. and Caut. ,,  
9. — *brachygnathus*, Lyd. ,,  
10. — sp. (allied to *F. pardus*) ,,  
11. — sp. (allied to *F. lynx*) ,,  
12. — *subhimalayana*, Bronn. ,,  
13. *Ælurogale sivalensis*, Lyd. ,,  
14. *Æluropsis annectens*, Lyd. ,,

## d. Family HYÆNIDÆ.

15. *Hyæna felina*, Bose. ,,  
16. — *Colvini*, Lyd. ,,  
17. — *sivalensis*, Bose. ,,  
18. — *macrostoma*, Lyd. ,,  
19. — sp. ,,  
20. *Lepthyæna sivalensis*, Lyd. ,,

## e. Family VIVERRIDÆ.

21. *Viverra Bakeri*, Bose. ,,  
22. — *Durandi*, Lyd. ,,

## f. Family URSIDÆ.

## 1. Sub-Fam. CANINÆ.

23. *Canis Cautleyi*, Bose. ,,  
24. — *curvipalatus*, Bose. ,,  
25. *Amphicyon palæindicus*, Lyd. Lr.  
and Up. Siwalik.

## 2. Sub-Fam. URSINÆ.

26. *Hyænarctos palæindicus*, Lyd. Siwa-  
[lik.  
27. — *punjabensis*, Lyd. ,,  
28. — *sivalensis*, Falc. and Caut. sp.  
Siwalik.  
29. *Ursus namadicus*, Falc. and Caut.  
Narbada.  
30. — *Theobaldi*, Lyd. Siwalik.

## g. Family MUSTELIDÆ.

31. *Mustela*, sp. Siwalik.  
32. *Mellivora sivalensis*, Falc. and Caut.  
sp. Siwalik.  
33. — *punjabensis*, Lyd. ,,  
34. *Mellivodon palæindicus*, Lyd. ,,

35. *Lutra palæindica*, Falc. and Caut.  
Siwalik.

36. — *bathygnathus*, Lyd. ,,

37. — *sivalensis*, Falc. and Caut. ,,

## h. Family HYÆNODONTIDÆ.

38. *Hyænodon indicus*, Lyd. ,,

## III. Order RODENTIA.

## Sub-Order A SIMPLICIDENTATA.

## i. Family MURIDÆ.

39. *Mus* (?) sp. Falc. and Caut. Siwalik.

## j. Family SPALACIDÆ.

40. *Rhizomys sivalensis*, Lyd. ,,

## k. Family HYSTRICIDÆ.

41. *Hystrix sivalensis*, Lyd. ,,

## Sub-Order B. DUPLICIDENTATA.

## l. Family LEPORIDÆ.

42. *Lepus*, sp. Siwalik.

## IV. Order UNGULATA.

## Sub-Order A. ARTIODACTYLA.

## (aa) Section RUMINANTIA.

## m. Family BOVIDÆ.

43. *Bos namadicus*, Falc. Narbada.

44. — *acutifrons*, Lyd. Siwalik.

45. — *planifrons*, Lyd. ,,

46. — *platyrhinus*, Lyd. ,,

47. *Bison sivalensis*, Falc. sp. Siwalik

48. *Bubalus palæindicus*, Falc. sp. Nar-  
bada and highest Siwalik

49. — *platyceros*, Lyd. ,,

50. *Hemibos occipitalis*, Falc. sp. ,,

51. — *acuticornis*, Falc. and Caut. sp.  
Siwalik

52. — *antilopinus*, Falc. and Caut. sp.  
Siwalik

53. *Leptobos Falconeri*, Rüt. ,,

54. — *Frazeri*, Rüt. Narbada

55. *Bucapra Daviesi*, Rüt. Siwalik

56. *Capra sivalensis*, Lyd. ,,

57. — *perimensis*, Lyd. ,,

58. — sp. Lyd. ,,

59. *Orcas* (?) *latidens*, Lyd. ,,

60. *Palæoryx* (?) sp. Lyd. ,,

61. *Boselaphus namadicus*, Rüt. sp.  
Narbada

62. — sp. Lyd. Siwalik

63. *Gazella porrecticornis*, Lyd. ,,

64. *Antilope sivalensis*, Lyd. ,,

65. — (?) *patulicornis*, Lyd. ,,

66. *Alcelaphus palæindicus*, Falc. sp.  
Siwalik

## n. Family GIRAFFIDÆ.

67. *Sivatherium giganteum*, Falc. and  
Caut. Siwalik

68. *Bramatherium perimense*, Falc. ,,

69. *Hydaspitherium megacephalum*, Lyd. Siwalik  
 70. — *grande*, Lyd. „  
 71. *Helladotherium Duvernoyi*, Gaud. and Lart. sp. Siwalik and Pikermi beds  
 72. *Vishnutherium Iravadicum*, Lyd. Siwalik  
 73. *Giraffa sivalensis*, Falc. and Caut. sp. Siwalik
- o. Family CERVIDÆ.
74. *Propalæomeryx sivalensis*, Lyd. „  
 75. *Moschus* (?) sp., Lyd. „  
 76. *Cervus triplidens*, Lyd. „  
 77. — *simplicidens*, Lyd. „  
 78. — *sivalensis*, Lyd. „  
 79. — sp. Narbada
- p. Family TRAGULIDÆ.
80. *Dorcattherium majus*, Lyd. Siwalik.  
 81. — *minus*, Lyd. „  
 82. *Tragulus sivalensis*, Lyd. „
- pp. Family CAMELIDÆ.
83. *Camelus sivalensis*, Falc. and Caut., „  
 (bb.) Section SUINA.  
 Sub-Section SELENODONTIA.
- q. Family MERYCOPOTAMIDÆ.
84. *Merycopotamus dissimilis*, Falc. and Caut. Siwalik.  
 85. *Chæromeryx silistrensis*, Pent. „  
 86. *Hemineryx Blanfordi*, Lyd. Lower [Siwalik.]  
 87. *Sivameryx sindiensis*, Lyd. „
- r. Family OREODONTIDÆ.
88. *Agriochærus* (?) sp. Lyd. „
- s. Family ANTHRACOTHERIIDÆ.
89. *Hypotamus palæindicus*, Lyd. „  
 90. — *giganteus*, Lyd. „  
 91. *Anthracotherium hypotamoides*, Lyd. Lower Siwalik.  
 92. — *silistrensis*, Pentl. L. and U. (?) [Siwalik.]
- (cc) Sub-Section BUNODONTIA.
- t. Family ENTELODONTIDÆ.
93. *Tetraconodon magnus*, Falc. Siwalik.
- u. Family SUIDÆ.
94. *Hyootherium sindiense*, Lyd. Lower [Siwalik.]  
 95. — sp. Lyd. Siwalik.  
 96. *Sanitherium Schlagintweiti*, H. von Meyer. Siwalik.  
 97. *Hippohyus sivalensis*, Falc. and Caut. [Siwalik.]  
 98. *Sus giganteus*, Falc. and Caut. „  
 99. — *titan*, Lyd. „  
 100. — *Falconeri*, Lyd. „  
 101. — *hysudricus*, Falc. and Caut. U. and L. Siwalik.
102. *Sus punjabiensis*, Lyd. U. and L. [Siwalik.]  
 Narbada.
103. — sp. Lyd.  
 v. Family HIPPOPOTAMIDÆ.
104. *Hippopotamus palæindicus*, Falc. and Caut. Narbada.  
 105. — *namadicus*, Falc. and Caut. Narbada.  
 106. — *sivalensis*, Falc. and Caut. Siwalik.  
 107. — *iravadicus*, Falc. and Caut. Siwalik.
- w. Family LISTRIODONTIDÆ.
108. *Listriodon pentapotamiæ*, Falc. sp. Siwalik.  
 109. — *Theobaldi*, Lyd. „  
 Sub-Order B. PERISSODACTYLA.
- x. Family EQUIDÆ.
110. *Equus sivalensis*, Falc. and Caut. Siwalik.  
 111. — *namadicus*, Falc. and Caut. [Siwalik and Narbada.]  
 112. *Hipparion antilopinum*, Falc. and Caut. sp. Siwalik.  
 113. — *Theobaldi*, Lyd. „  
 114. — sp. Lyd. „
- y. Family RHINOCEROTIDÆ.
115. *Rhinoceros unicornis*, Linn. Narbada and recent.  
 116. — *sivalensis*, Falc. and Caut. [U. and L. Siwalik.]  
 116.\* — var. *gajensis*, Lyd. L. Siwalik.  
 117. — *palæindicus*, Falc. and Caut. Siwalik.  
 118. — *deccanensis*, Foote. Krishna [Valley.]  
 119. — *platyrhinus*, Falc. and Caut. [Siwalik.]  
 120. — *namadicus*, Falc. and Caut. [Narbada.]  
 121. *Aceratherium perimense*, Falc. and Caut. sp. Siwalik.  
 122. — *Blanfordi*, Lyd. Lower „
- z. Family CHALICOTHERIIDÆ.
123. *Chalicotherium sivalensis*, Falc. and Caut. U. and L. Siwalik.
- Sub-Order C. PROBOSCIDEA.
- zz. Family—ELEPHANTIDÆ.
124. *Elephas namadicus*, Falc. and Caut. [Narbada.]  
 125. — *hysudricus*, Falc. and Caut. [Siwalik.]  
 126. — *planifrons*, Falc. and Caut. „  
 127. — *insignis*, Falc. and Caut. [Siwalik and (?) Narbada.]  
 128. — *ganesa*, Falc. and Caut. [Siwalik and Narbada.]

129. *Elephas bombifrons*, Falc. and Caut. [Siwalik.]  
 130. — *Clifti*, Falc. and Caut. Siwalik.  
 131. *Mastodon sivalensis*, Caut. Siwalik.  
 132. — *perimensis*, Falc. and Caut. [Siwalik.]  
 133. — *latidens*, Clift. U. and L. ,,  
 134. — *pandionis*, Falc. ,, ,,  
 135. — *angustidens*, Cuv. L. Siwalik.  
 136. — *var. palæindicus*. ,, ,,  
 137. — *Falconeri*, Lyd. U. and L. [Siwalik.]
- zzz. Family DINOATHERIIDÆ.  
 138. *Dinotherium indicum*, Falc. U. and [L. Siwalik.]  
 139. — *pentapotamiae*, Lyd. (ex Falc.) [U. and L. Siwalik.]  
 140. — *sindiense*, Lyd. U. (?) and L. [Siwalik.]
- V. Order EDENTATA.  
 Sub-Order SQUAMATA.  
 zzzz. Family MANIDÆ.  
 141. *Manis sudiensis*, Lyd. L. Siwalik.

In the foregoing synopsis, Mr. Lydekker states that he has endeavoured to follow in the main the nomenclature adopted by Professor W. H. Flower, in his Catalogue of the Mammalia in the Museum of the Royal College of Surgeons (London, 1884). Under each genus is given the reference to the work where it was originally named, and under the species, the work in which the name was first applied and also that in which the fullest description of each species may be found.

1. The Primates (Anthropoidea) are present in these deposits and are represented by	2 families,	4 genera	and	5 species.
2. The Carnivora, by	6 ,,	16 ,,		33 ,,
3. Rodentia, by	4 ,,	4 ,,		4 ,,
4. Ungulata, viz.				
A <i>Artiodactyla</i> , by	11 ,,	39 ,,		67 ,,
B <i>Perissodactyla</i> , by	3 ,,	5 ,,		15 ,,
C Proboscidea	2 ,,	3 ,,		16 ,,
5. The Edentata, by	1 family	1 genus	and	1 ,,
Making 5 Orders	29 families,	72 genera	and	141 ,,

It is interesting to observe that the deposit which at present has yielded the richest series of Fossil Vertebrata in India is that of the Siwalik Hills in which the late Sir Proby T. Cautley and Dr. Hugh Falconer laboured with so much success more than thirty years ago, and whose remarkable fossils occupy the fine series of folio plates known as the "Fauna Antiqua Sivalensis," the only descriptions of which are to be found in "Falconer's Palæontological Memoirs," so carefully edited by the late Dr. Charles Murchison.

When we bear in mind the unfavourable nature of the climate, the vast and varied character of the country embraced in our Indian Empire, and the very small number of workers actually engaged on the preparation of these publications, including both those at home and those out in India, many of the latter of whom are out in the field most of the year, we cannot but confess our astonishment at the brilliant results which this small army of geologists and palæontologists have accomplished.

## CORRESPONDENCE.

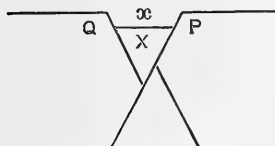
### ON "FAULTS."

SIR,—Prof. Blake has pointed out that Figures 8 and 9 in my paper on Faulting (p. 209) are incorrect. It was careless in me to draw them so; and I send amended copies. The text requires no

alteration. Of course Figure 9 is generalized, and the details might be varied; as, for instance, by some of the faults bifurcating or by step faults.

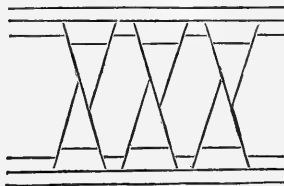
I think it possible that "our science" is more in danger of "losing caste" by the Professor's critique, than by my article. It seems to be the especial misfortune of Geology, that questions relating to it cannot be discussed dispassionately—I had almost written with courtesy. I can only hope that some of your readers have understood my meaning better than Mr. Blake has done. O. FISHER.

FIG. 8.



13 AUG. 1884.

FIG. 9.



## REPLY TO PROF. BLAKE'S CRITICISM ON FAULTS.

SIR,—Having been much interested in the two suggestive papers by my friend Mr. Fisher on the subject of Faulting, Jointing and Cleavage, lately published in this MAGAZINE, I was naturally somewhat surprised at being told last month, on the authority of Prof. Blake, that the papers in question were a "mischievous" compound of mere "chaff." I have, therefore, carefully gone over the original papers again (including the equations which the Professor condemns as erroneous), with Prof. Blake's article as a guide; the result being that the whole of the long and somewhat violent criticism shows itself to be a mixture of errors and misapprehensions so extraordinary as to make one wonder what the Professor can have been about in writing such an article for publication. He certainly points out the obvious error in Figs. 8 and 9; but even in doing this he has allowed himself to fall into the mistake of giving an obviously imaginary reason for this error. The figures are easily corrected; and when this is done, it will be seen that there is no need for any correction in the text, nor any alteration in the argument; so far is it from being true, as the critic asserts, that the error in the figures is "the result of attempting to form faults" either in the way suggested by Mr. Fisher, or in the parody thereof suggested by the critic. Again, on p. 212, l. 26, Mr. Fisher has omitted the letter  $x$  after  $\lambda$  (unless, indeed, he here uses the symbol  $\lambda$  merely to identify the force spoken of, which appears to me the probable explanation). This, which is at worst a mere clerical error, cannot have caused any confusion except perhaps in the critic's mind. But Prof. Blake has seized the opportunity to "run full tilt" at the whole paper in consequence. One other criticism offered by Prof. Blake may appear to some to be of some weight, when he doubts (on p. 368) whether Mr. Fisher is right in assuming that the resis-

tance to shearing stress along a plane is independent of the pressure perpendicular to that plane. With regard to this, however, it must be remembered that the shearing stress spoken of is not employed to overcome friction, but to induce viscous motion; and it is difficult to see how this can be affected by normal pressure, unless perhaps when the matter is compressible.

But when we turn to the rest of the violent attack, made on papers which treat of a difficult subject in a sufficiently simple way, one is puzzled to know what in the world can have induced any one who cares for his reputation to commit such egregious blunders to print, even in the form of a criticism. And I hope Prof. Blake will excuse my giving an example or two which will, I think, be sufficient to show him that, in his anxiety to save your fledgeling readers from danger, he had unconsciously done the very opposite. In his remarks on Mr. Fisher's first paragraph, he supposes that we are told to confound "vertical" with "perpendicular to the bedding," whereas in fact Mr. Fisher (after suggesting that by the ordinary artifice of turning a whole area together with the directions of the forces affecting it back through the angle of dip, his formulæ, which are based on horizontally stratified areas, will, with the necessary modifications, apply generally<sup>1</sup>) merely warned his readers to make these modifications. He makes an extraordinary error also when he gives those two instances to show that Mr. Fisher was wrong in stating that the idea of plasticity would be introduced by the assumption that pressure varies as the area on which it acts. On what part of a steam-boiler does the pressure vary as the area, except on those surfaces on which the plastic steam or the plastic atmosphere acts? And even Prof. Tait, the terror of whose name Prof. Blake invokes in another part of his critique, would be puzzled to determine what is the pressure per unit area exerted by a *rigid* book on a *rigid* table; we used to learn that the pressure so created was indeterminate if exerted at more than 3 points; but as soon as we "introduce the idea of plasticity," it is obvious that the pressure will then vary as the area.

So much for the barren labour of criticizing the criticism. If however, you will allow me a little more space, I should like to add a few words on the original papers. Mr. Fisher starts with the assumption that the lack of horizontal support, which seems necessary to account for direct faulting, is probably in many cases due to contraction on solidification; and then, as it seems to me, follows out logically the consequences of that assumption. Nowhere can the existence of this proposed cause be more easily ascertained than in the "slurries" of the Cambridgeshire coprolite pits; though the small vertical pressure exerted by the shallow deposits in these slurries is not, I suspect, sufficient to give rise to faulting. Now no one with any knowledge of mathematics would expect that the equations of motion of plastic solids submitted to forces thus generated, even if they could be obtained, could be integrated; so

<sup>1</sup> Your readers will forgive my explaining this at such length.



that it is hopeless to look in this direction for any workable results. And this being so, it is necessary to attack this problem, as many other problems have had to be attacked, in a more roundabout way. Mr. Fisher finds, if I am not mistaken, the statical conditions of equilibrium in such solids when the forces exerted on them have increased to such an extent that they are on the point of exhibiting their plastic character. In doing so, however, he only considers the forces acting on the solid vertically and in one horizontal direction. It might perhaps lead to a useful result if he extended his method to the consideration of the problem in three dimensions, as it seems probable that another tension *Q*, corresponding to his tension *P*, but in a direction perpendicular to that of *P*, must arise during contraction. His present results agree in many respects with what we find in nature. Thus he leads us to expect that no direct faults caused by contraction will have less inclination to the horizon<sup>1</sup> than 45°. I do not know of any of less inclination than this, but if any such exist, the fact may most probably be accounted for on the supposition that the whole strata, fault and all, have been subsequently turned through an angle of dip sufficient to change the hade to its present value. He also leads us to expect that series of crossed faults will consist of two more or less parallel systems. A careful examination of series of faults with such a guide to our enquiries as Mr. Fisher's papers will afford, will be of infinitely more value to geology than any amount of random onslaught by careless critics.

A. F. GRIFFITH, M.A.

SANDRIDGE, ST. ALBANS, *August 12th*, 1884.

#### THE PERMANENCE OF OCEAN BASINS.

SIR,—Mr. Mellard Reade has drawn attention to the discovery that South Georgia is not a volcanic island, but is composed of clay-slate:<sup>2</sup> and argues from this fact against the theory of the Permanence of Oceanic and Continental Areas. He very fairly remarks that, if islands like New Zealand are largely composed of sedimentary rocks, they are said not to be oceanic, and that in arguing from the position that all truly oceanic islands are volcanic, the advocates of the theory arbitrarily exclude the non-volcanic from the category of oceanic islands.

There is, however, something to be said on the other side. The non-volcanic islands mentioned by Darwin in his "Coral Islands" are New Caledonia, and the Comoro and Seychelles. New Caledonia seems to be a link in the chain which connects New Zealand with New Guinea, and lies in the course of the great volcanic band which stretches through Java to New Zealand. The Comoro islands are too near Africa to be called oceanic; and the Seychelles appear to be on the axis of Madagascar, and may well be connected with it.

<sup>1</sup> There seems to be much uncertainty among geologists as to the use of the word "hade." Among miners it appears to be measured always from the vertical, and it would perhaps be well for us to assimilate our use of the word to theirs, as we borrowed the term from them.

<sup>2</sup> GEOL. MAG. May, 1884.

If these islands be permitted for the above reasons to be called non-oceanic, then, by a slight stretch, the same courtesy may be extended to S. Georgia (96 miles long and 10 broad),<sup>1</sup> for the chain of the Andes, where it enters Tierra del Fuego, takes a turn to the eastward, and the eastern cape points direct to S. Georgia. The rocks of Tierra del Fuego consist of clay-slate,<sup>2</sup> and so also do those of the Falkland Islands, which lie between it and S. Georgia. This similarity of composition points to a former connection.

Without committing oneself to an opinion upon the profitableness or otherwise of reconstructing the geography of past periods of the world's history, one cannot help seeing that this great question of the permanence of ocean basins is one of fundamental importance. At one time I was quite disposed to reject the theory, as does Mr. Mellard Reade. But the course of study which I went through in writing my *Physics of the Earth's Crust* led me to change my opinions, on grounds rather physical than geological. If there is any weight in the arguments I have there put forward, they give a support to the theory from a fresh point of view.

Extensive changes of level seem to me to be the most difficult to account for of all the phenomena of geology. And the greater the changes, the greater the difficulty. The permanence of the respective areas seems therefore to involve less difficulty than their interchange. I published in "*Nature*,"<sup>3</sup> about two years ago, a suggestion to account for the origination of ocean basins. It is rather remarkable that the first and only allusion to it which I have seen has just now come from New Zealand in Dr. Haast's address at Canterbury College.<sup>4</sup> Accepting Professor Darwin's theory that the moon broke away from the earth more than fifty million years ago, I think the ocean-basins may be the scar that was formed, and that the basement rocks of continents are fragments of the crust which had already solidified, and which were left behind. It has since occurred to me that the Archæan rocks may be veritable remnants of it. I would refer to my published article for the details of the grounds on which I think this theory plausible. Dr. Haast uses rather too strong an expression in saying, that I have attempted to prove it. It is probably incapable of proof, even if true.

O. FISHER.

---

THE INTERNATIONAL GEOLOGICAL CONGRESS POSTPONED.

SIR,—Will you allow me to announce in your columns that the International Geological Congress which was to have been held in Berlin next month is *postponed to September, 1885*, in consequence of the outbreak of cholera in the South of Europe.

WOODWARDIAN MUSEUM,  
CAMBRIDGE, *Aug. 12th, 1884.*

THOS. MCKENNY HUGHES.

---

<sup>1</sup> Darwin's *Naturalist's Voyage*, p. 248.

<sup>2</sup> Scrope's *Volcanos*, 1862, p. 434.

<sup>3</sup> "*Nature*," Jan. 12, 1882.

<sup>4</sup> "*Nature*," Apr. 24, 1884, p. 609.



FIG. 2.



FIG. 1.

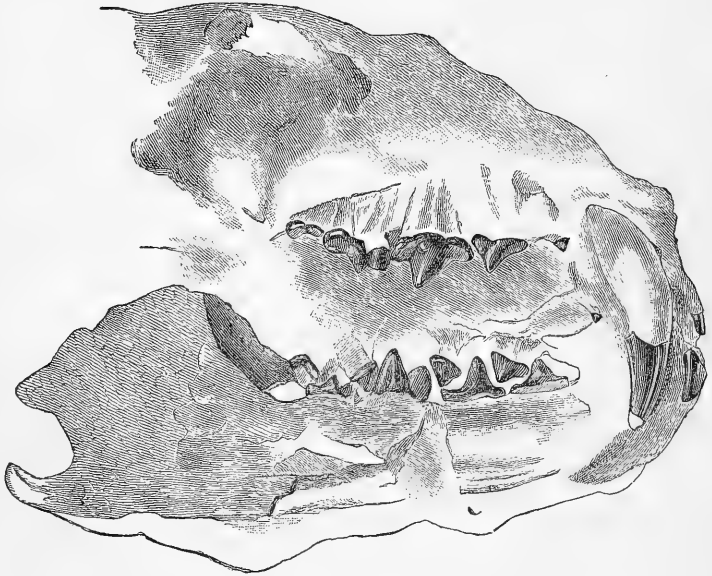


FIG. 4.

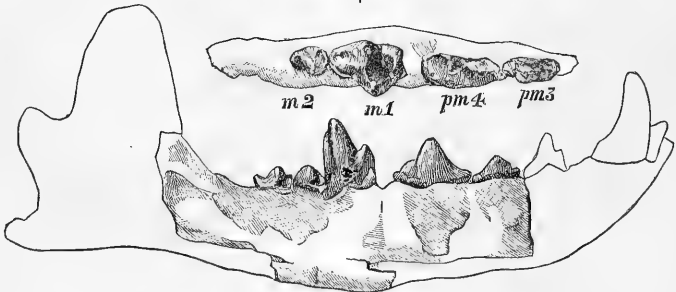


FIG. 3.

*VIVERRA HASTINGSIÆ*, DAVIES, SP. NOV.

From the Eocene Freshwater Beds at Hordwell, Hampshire.

THE  
GEOLOGICAL MAGAZINE.

NEW SERIES. DECADE III. VOL. I.

No. X.—OCTOBER, 1884.

ORIGINAL ARTICLES.

I.—NOTES ON SOME NEW CARNIVORES FROM THE BRITISH EOCENE FORMATIONS.

By WILLIAM DAVIES, F.G.S.; of the British Museum (Natural History).

(PLATE XV.)

THE remains of many genera and species of the Order Carnivora have been discovered in the Lower and Middle Tertiaries of the European Continent, and have been described and figured in numerous valuable palæontological works and memoirs by Continental authors. That these remains are exceedingly rare in the older Tertiaries of England is proved by the fact, that only one Carnivore, the *Hyænodon*,<sup>1</sup> has been placed on record as occurring in them.

There are, however, some imperfect remains of other genera, hitherto unnoticed, preserved in the National Collection (Natural History), Cromwell Road, South Kensington. These remains, although fragmentary, are interesting, as being new, and therefore worthy of record as additions to our scanty list of Eocene Carnivores. The most important is part of the head of a small animal about the size of a Fox (No. 30203), from the Eocene Freshwater Beds at Hordwell—whence the *Hyænodon* remains were also obtained—still partly embedded in the characteristic friable sandy matrix which has yielded remains of many vertebrates. It is obliquely crushed, and little besides the base of the skull, a maxilla, the mandibular rami and the teeth, upper and lower, are preserved. The exact form of the bones of the head is unknown; but the profile is fairly preserved in the matrix, those portions which are present being respectively in their natural positions, in regard to each other, we have almost accurate evidence of size, the length from the exoccipital condyles to the anterior margin of the canine being 4·7 inches.

The exoccipital condyles are entire, and portions of the basi- and pre-sphenoids are preserved, also the tympanic bullæ, but these are too crushed and imperfect to serve as aids to generic identification; a portion of the left maxilla and the rami of the lower jaw are preserved, fortunately having nearly the whole of the side teeth *in situ*. There are also portions of the atlas, axis and the third cervical vertebra, but too imperfect for comparison or measurement.

The mouth being closed when the skull was embedded, with the

<sup>1</sup> Owen, "Palæontology," 2nd edit. 1861, p. 372.



The left ramus of the lower jaw is nearly entire and *in situ*, the teeth being in contact with those of the opposing maxilla, the condyle is just within the glenoid cavity of the squamosal. The length is 3·4.

The detached portion of the right ramus contains the third and fourth premolars, and the first and second true molars. Premolar 3 is smaller relatively to premolar 4 than is the corresponding tooth in *Herpestes*, the base is broad in the direction of the long axis of the jaw, the crown is low, and there is a well-defined posterior tubercle; premolar 4 resembles the same tooth in *Herpestes*. We have, however, in the first molar (the carnassial) another type of tooth, distinct from *Herpestes*, but like the corresponding tooth in *Cynodictis*. The posterior lobe of the blade is acutely conical and high, the anterior lobe being relatively low, barely half the height of the posterior lobe, the inner cusp is also high and stout. In *Herpestes* the two lobes of the blade do not differ greatly in height and the inner cusp is relatively smaller, and less elevated than the anterior lobe of the blade. The talon has a central conical tubercle, and there is a small cingulum on the outer anterior base of the blade. The tooth is short antero-posteriorly, the length not exceeding the vertical height of the posterior blade. The second molar is proportionally small, it has three tubercular points and a short posterior talon, which is not shown in m. 2 in *Herpestes*, but is present in *Cynodictis*. The dimensions of the mandibular teeth are—

Antero-posterior diameter of premolar 3	.....	0·27
Vertical diameter	.....	0·15
Antero-posterior	„ premolar 4	0·35
Vertical	„ „	0·23
Antero-posterior	„ carnassial	0·37
Vertical diameter of anterior blade of ditto	.....	0·21
ditto	posterior „	0·36
Antero-posterior diameter of molar 2	.....	0·21

Comparing the upper molars of our fossil, with the published figures of fossil Viverridæ, I find that in size and general character they most nearly resemble the *Viverra antiqua* of De Blainville,<sup>1</sup> a species founded upon a portion of a maxilla containing four teeth from the Miocene Freshwater deposits, St. Gérard le Puy, Allier. Gervais reproduces De Blainville's figure,<sup>2</sup> and accepts his determination of the genus. Pomel subsequently referred the fossil to the genus *Herpestes*,<sup>3</sup> as he considered that the teeth indicated a transition from the Civets in the direction of the Genets. M. Filhol has more recently described and figured<sup>4</sup> a very perfect skull, also from St. Gérard le Puy, which he refers to *Viverra antiqua*, and although he adopts De Blainville's generic appellation, he admits that in many points of structure it is distinct from any true *Viverra*, and that by its dentary system it is allied to *Genetta*; yet on the other hand he enumerates certain cranial characters that he considers indicate a still nearer relationship with the Civets than with the

<sup>1</sup> "Ostéographie," Genus *Viverra*, p. 71, pl. 13.

<sup>2</sup> "Zool. et Paléont. Franc." 1848-52, Explication, pl. 28, p. 11.

<sup>3</sup> "Catalogue Méthodique," 1853, p. 64.

<sup>4</sup> "Ann. des Sc. Géol." Paris, 1879, tome x. art. 3, p. 152, pl. 19.

Genets; he also quotes, in support of this conclusion, a work by M. Lartet, in which he describes certain differences in the form of the brain of *V. antiqua* and *Genetta*, founded on casts taken respectively from the fossil and recent skulls, that tend in the same direction. M. Filhol also remarks that the locality of St. Gérard le Puy contains numerous specimens of this mammal (*V. antiqua*); he knew of four nearly perfect skulls, but was not certain whether he had obtained the mandible, although he considered (*loc. cit.* p. 166) it highly probable that some mandibles described and figured under the name of *Herpestes* (pl. 24, figs. 5-9) might belong to the same species. This type of mandible is intermediate between *Viverra* and *Herpestes*, and accords therefore with the cranium. He has elsewhere figured and given a detailed description of a perfect ramus of a lower jaw which he refers to *Viverra* (*V. angustidens*, Filh.).<sup>1</sup> Describing the carnassial, he says, its anterior portion is formed of three points, more detached and more elevated than in any other living or fossil species of *Viverridæ*; it is succeeded by an elongated talon, not so large but more erect than in *Cynodictis*. The structure of the lower carnassial of the Hordwell carnivore corresponds in all particulars with the above description and figure of the Quercy tooth.

The conclusions of M. Filhol as to the generic position of the above-named fossils, derived from careful study and comparison of many fossil specimens with existing forms of *Viverridæ*, are important, as are also the reasons he adduces for considering them as representatives of an early and extinct form of the genus *Viverra*, differing in many points of dental structure from any existing species of the genus. They are also valuable as aiding us in determining the genus to which the Hordwell skull should be assigned; a matter of some difficulty, owing to the mixed character of the teeth, and open to objection to make, from so imperfect a specimen, a new genus for its reception.

The specimen has a local interest and importance; interesting as being the first instance recorded of a *Viverrine* carnivore from a British locality, and important as being the first placed on record in which the teeth of the upper and lower jaws have been found in natural association; also as having been found in a deposit, and associated with a fauna, of unquestioned Eocene age; it is therefore the earliest representative of the Family *Viverridæ* hitherto described.

The resemblance of the lower carnassial and tubercular molar to the corresponding teeth in *Cynodictis* indicates the close affinity of these older forms of Civets and Dogs, and also possibly points to a common ancestry. This affinity is more marked in species of *Viverrid* *Cynodictis* described by M. Filhol,<sup>2</sup> in which the third lower molar is entirely suppressed or reduced to little more than a point.

<sup>1</sup> "Recherches sur les Phosphorites du Quercy," 1876, p. 144, figs. 121 and 122.

<sup>2</sup> "Ann. Soc. Sci. Phys. et Nat." Toulouse, 1882, pp. 56-62.



I propose the name of *Viverra Hastingsiæ* for this specimen, it having formed part of the large and valuable series of vertebrate remains from the Hordwell Beds collected by the late Marchioness of Hastings, which have long been preserved in the National Collection.

A second specimen, also from the same bed<sup>1</sup> of the Upper Eocene at Hordwell, is part of a skull of a much larger animal than the preceding, showing the palatal surface of the maxillæ and portions of other bones of the head, but too fragmentary for ready identification. A canine and three premolars in fair preservation, and one premolar and a carnassial with the crowns broken are present in their respective alveoli. (No. 36791.)

The maxillæ have parted at the median palatal suture, and that of the right side has slipped in advance of the left; notwithstanding this displacement, and some fractures, the size and form of as much as remains of the roof of the mouth is preserved. The length from the anterior margin of the canine to the posterior margin of the carnassial is 2·3, and the width of the palate between the third premolars is 1·3. No incisors are preserved, and the possession of a first premolar is indicated only by the preservation of part of an alveolus. The canine has a broad, and relatively to the crown, large fang; its antero-posterior diameter being 0·58, and that of the base of the crown 0·4. The second premolar is conical, with the anterior margin vertically convex, and the posterior margin vertically concave and sharp-edged, and there is a well-defined cingulum on the inner side. The dimensions are antero-posteriorly 0·45, and the posterior transverse diameter 0·2. The summits of all the teeth being worn, vertical measurements have not been taken.

The third premolar has a large posterior lobe with the point abraded by use, and an inner cingulum terminating in a small lobule at the inner posterior base of the crown; the dimensions are antero-posterior diameter 0·5, and transverse diameter 0·25. The carnassial (pm. 4) relatively to premolars 2 and 3 is a small tooth; its antero-posterior diameter being 0·55 and the transverse diameter 0·43. The summit is too much broken for description, but the hinder talon is intact and small. The only evidence of a tubercular molar are the alveoli of the two outer fangs of m. 1, one empty, the other containing the fang *in situ*; there is no indication of a third or inner fang; the second molar if present was small. The incompleteness or absence of these characteristic and important teeth, together with the fragmentary condition of the few bones of the head present, renders it almost impossible to determine accurately the genus to which the fossil should be referred. The parts that remain do not correspond with the same parts in any Eocene carnivore that I have been able to compare it with, either by drawing or actual fossil.

The specimen was collected and presented to the National Collection with other fossils from Hordwell in 1862, by Samuel Laing, Esq., M.P., F.G.S.

<sup>1</sup> Bed No. 15 of Messrs. Tawney and Keeping's section of the Hordwell Cliffs, Quart. Journ. Geol. Soc. vol. xxxix. p. 571.

We have thus evidence that when this freshwater bed at Hordwell was being deposited, there existed three terrestrial carnivores of fairly large size that preyed on the Anoplotheres, Paloplotheres, Dichodons and other herbivores, and the smaller Microchæres and rodents (*Theridomys*) that abounded on the land bordering the old inland lake in which these deposits were laid down.

The third specimen is also a mutilated skull of an animal a little larger than a Fox from the London-clay at Sheppey (No. 35688). Portions only of the parietals, the maxillæ and palatine, and of the pterygoids and presphenoid are present. And like most of the fossils from Sheppey, the specimen is not crushed or distorted, and imperfect as are the parts preserved, as much as remains of each bone retains its natural form and position.

The most perfect bone is the right maxilla; the teeth are all wanting, only the alveoli of the third premolar, the carnassial and the first molar are shown. The carnassial was a short tooth relatively to its breadth; the antero-posterior diameter of the alveoli of the outer fangs being 0·45, whilst the transverse diameter across the alveoli of the posterior and inner fang is 0·4. The anterior margin of the alveolus of the inner fang being in a line with that of the posterior fang in the direction of the transverse diameter of the palate, indicates the triangular form of the tooth. That the first molar was a large and powerful crushing tooth is shown by the size of the alveolus of the fang of the talon. The second molar, if present, must have been very small; there is no indication of its presence, and from the state of preservation of the posterior portion of the maxilla, it is a question if it possessed one. The posterior palatal foramina are shown, and also the infraorbital foramina just above the carnassial alveoli.

In the absence of the teeth, and the imperfection of the bones, there are no definite characters by which to correlate it to any extinct form, nor to indicate the family to which it should be referred. I therefore propose to name it *Argillotherium toliapicum*.

In conclusion, I may observe that during the many years in which I have known and felt an interest in the specimens here described, I have never seen in any private or public collection a fragment of a tooth or bone of a carnivore from Sheppey, except the fragment here noted; and only a few detached teeth, mostly referable to *Hyænodon*, from Hordwell. Specimens may be lying hid in private collections, and if such there be, I trust these imperfect notes may have the result of directing attention to them.

#### EXPLANATION OF PLATE XIV.

*Viverra Hastingsiæ*, Davies, sp. nov. From the Eocene Freshwater Beds of Hordwell, Hampshire.

FIG. 1. Outer side view of anterior portion of the head and teeth; and of the inner side of the left mandibular ramus.

FIG. 2. Crown view of the upper teeth.

FIG. 3. Outer view of the detached portion of right ramus of the lower jaw; the parts wanting are restored in outline.

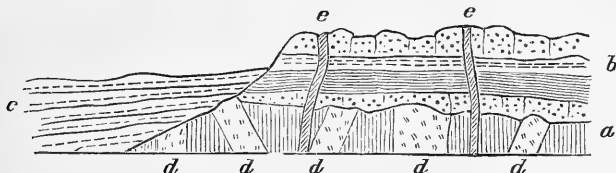
FIG. 4. Crown view of the lower teeth.

II.—NOTES ON THE GEOLOGY OF EGYPT.<sup>1</sup>

By Sir William Dawson, K.C.M.G., LL.D., F.R.S., F.G.S., etc.  
Principal of McGill College, Montreal.

IV.—The Crystalline Rocks of Upper Egypt.

A SUDDEN and great change takes place in the geology of the Nile valley in approaching the First Cataract, where we pass from the unaltered and nearly flat Nubian sandstones to rocks highly crystalline, greatly disturbed, and penetrated with multitudes of igneous veins.



Relations of Crystalline Rocks and Nubian Sandstone at First Cataract.

- (a) Older Crystalline Series (Laurentian).
- (b) Second Crystalline Series (Arvonian).
- (c) Nubian Sandstone.
- (d) Dykes of Granite and Diorite.
- (e) Dykes of Felsite and Basalt.

The gneisses and schists associated with granite and diorite at Assouan and its vicinity, though they have attracted the attention of the most unscientific travellers, have apparently as yet been little studied in detail. They have, however, been described by Lieut. Newbold in the Journal of the Geological Society of London, vol. iii., and in the same journal, vol. xxiii. Mr. Hawkshaw has given a good map of their distribution, and has noticed most of the kinds of rock, though without inquiry as to their precise age or general mode of arrangement.

The town of Assouan is situated at the northern end of a ridge of crystalline rock, which runs about south ten degrees west, along the side of the river towards the Cataract. South of the town a cutting has been made across this ridge for railway purposes, and affords a good opportunity for studying the structure of the formation. The following section is exposed in this cutting, beginning at the western end, the beds being nearly vertical, and with strike E. 10° N. :—

Micaceous and hornblendic schists, with many red granite veins, one of them holding nests of broad-leaved magnesian mica .....	66 paces.
Dyke of coarse-grained hornblendic granite, with reddish orthoclase .....	6 "
Schists, as before, with large granite veins .....	53 "
Gneiss, with granite veins .....	7 "
Schist, with much black mica .....	23 "
Coarse orthoclase gneiss with beds of schist .....	20 "
Micaceous and hornblendic schists .....	7 "
Gneiss and schist .....	3 "
Schists and gneiss .....	7 "
Orthoclase gneiss .....	7 "
Hornblendic and micaceous schist, with veins of coarse granite ....	41 "
The same, with veins of red felspar .....	37 "
Micaceous and hornblendic schists, much weathered at the surface ..	34 "
Total.....	311 paces.

<sup>1</sup> See also former articles, pp. 289-292, 385-393.

Eastward of the cutting, the ground becomes flat, and does not afford a continuous section; but the decayed edges of micaceous and hornblendic schists, and thin-bedded gneisses appear at intervals of about 800 yards, after which they are overlain by the base of the Nubian sandstone, which further east rises into the table-land of the Arabian desert.<sup>1</sup> The base of the sandstone at this place shows a thin bed of conglomerate, and upon this some soft calcareous layers, above which is the ordinary grey sandstone.

The above section represents at least two thousand feet in thickness of crystalline schists and gneiss, with granite veins. To the latter category belongs the huge dyke of granite at the north end of the ridge, in which are the principal Egyptian quarries, though there are other ancient quarries in granite, diorite, and sandstone in several places in this vicinity. One of the diorites has a porphyritic character, caused by crystalline patches of white felspar, and this stone appears as a material of statues and other objects in all parts of Egypt. Two sphinxes from Pithom, now in the square of Ismalia, are of this material. There are also dykes of a black basaltic rock. No crystalline limestones were observed, but from the manner in which the surfaces of the gneiss and schist are disintegrated, it may be inferred that the outcrop of limestones, if present, would be deeply eroded and concealed.

Many of the granite dykes extend in the plane of the stratification, and for this reason it is not always easy, without careful observation, to distinguish them from the beds of gneiss. They are, however, generally coarser, and not laminated, and can be observed to send off branches into the adjoining beds. The mica present in schists seems to be in all cases biotite rather than muscovite.

At the Island of Biggeh, above the Cataract, and near to Philæ, there appears to be a second crystalline formation resting in a horizontal position on the older gneiss and schists, and itself overlaid by the Nubian sandstone. The precise arrangement of these rocks could not be seen so clearly as was desirable, owing to the *débris* which covered the sides of the cliffs; but on the Island of Biggeh their order appeared to be as follows, in descending series:—

1. Coarse dark-coloured porphyritic rock with large crystals of deep red felspar, darker in colour and more opaque than that of the lower series. This rock breaks into cuboidal masses, giving the cliffs composed of it a remarkable castellated appearance.
2. Fine reddish gneissose rock.
3. Black fine-grained coarsely laminated beds.
4. Coarse porphyritic rock, resembling No. 1.

Below this are the schists of the lower series, in a position nearly vertical.

The whole thickness of this upper series appeared to be about a hundred feet. On the mainland east of Biggeh it forms a high ridge stretching to the eastward. Whatever the origin of these rocks, they appear to overlie unconformably the lower series, and they did not appear to be penetrated by the great granite veins. They are, however, traversed by veins of red felsite and of a black igneous rock, having the appearance of basalt.

<sup>1</sup> In approaching the sandstone the strike of the schists changes to about N. 70° E.

Rocks of the character above described might of course admit of different interpretations as to their relations and origin; but as seen on the ground, they undoubtedly have the aspect of an overlying, unconformable stratified formation, and their crystalline character must be due to the conditions of their formation, and not to any subsequent mechanical action. They are, therefore, to be regarded as igneous or aqueo-igneous deposits.

Above the Cataract the river passes through a gap in the rocks above described, between the Island of Biggeh and the eastern shore, and runs over the older series, the granitic dykes of which project in prominent masses above the softer schists, as may be seen in the rocks of Konosso, and the eminence on the west end of Philæ.

In cutting back its channel, the Nile must originally have formed its First Cataract at the ridge of Silsilis, about forty miles below Assouan, and its waters were then dammed up so as to flood much of the river valley between Silsilis and the present site of the First Cataract. At this time the Nile probably flowed along the old channel east of Assouan; but so soon as the channel was cut back through the Silsilis ridges, it would rapidly extend southward through the softer beds to Assouan, and on reaching this place, the river would begin to remove the Nubian sandstone capping the crystalline rocks at the site of the present Cataract. This process would seem to have disclosed an ancient break or soft portion in the underlying formation, enabling the present channel to be cut, and this has been done mainly by removal of the sandstone and of loose fragments of the second crystalline formation above referred to.

In so far as the locality at the First Cataract is concerned, we have no precise measure of age for the crystalline rocks. There is reason to believe that in the range of similar formations extending northwards between the Nile and the Red Sea, beds occur of ages intermediate between those of the rocks of the Cataract and the Nubian sandstone; but the precise ages of these intermediate rocks are as yet uncertain. In these circumstances mineral character becomes our only guide. But this is by no means uncertain in its testimony. The schists and gneisses of the older Assouan series are identical in mineral character with those of the Grenville series of the Canadian Laurentian, and they have already been compared by Drs. Liebis and Hochstetter with the rocks of the same age in Scandinavia.<sup>1</sup> In like manner, the second or overlying series has two points of similarity with the felsitic series found in America to occur at the base of the Huronian, which has been named by Hicks the Arvonian series, and to which the Swedish geologists have given the name Hallefinte. I think, therefore, we may be justified in regarding these old crystalline rocks as African representatives of the Laurentian and one of the succeeding crystalline formations, and of course the same conclusion would apply to the wide extent of similar rocks in this part of Africa, and which recur in the peninsula of Sinai.

<sup>1</sup> Geol. Society of Germany, Jahrbuch, 1877. I have placed a suite of specimens in the hands of Prof. Bonney, F.R.S., who I hope may at some future time report on their precise lithological characters.

In any case, it is very interesting to find the oldest rocks of Africa presenting the same mineral characters with those of Europe and America.

The rocks quarried by the ancient Egyptians at Assouan or Syené, for buildings, obelisks and statues, seem to have been principally the red granite and different varieties of dioritic rocks; and the latter they obtained not so much from regular quarries as from projecting masses, the ruins of dykes exposed by denudation, and which had the double advantage of being free from cones and of consisting of material of proved durability. Illustrations of their working in such exposed masses may be seen in several places near Assouan. The thick granite veins often contain, as is not unusual in such masses, detached fragments of the schists and gneisses which have been caught up in them, and these are not infrequently to be seen in the sculptured Egyptian blocks. The gneissose rocks themselves occur very rarely as the material of sculptures.

Having noticed at the Boulak Museum a statue of Cephren, the builder of the second pyramid, in a stone which seemed to be a gneissose anorthosite, I had expected to find some indication of the Norian formation in Upper Egypt. In this I was disappointed, but was afterwards informed by Brugsch Bey that he had reason to believe that the stone in question was obtained from the Eastern hills between the Nile Valley and Kosseir on the Red Sea. It is not unlikely, therefore, that in these hills some representative will be found of the Norian or Labradorian series to fill up a portion of the gap existing between the two crystalline series at Assouan.

### III.—NOTES ON SOME FOSSIL CARNIVORA AND RODENTIA.

By R. LYDEKKER, B.A., F.G.S., F.Z.S.

HAVING nearly completed the manuscript of a catalogue of some of the Orders of Fossil Mammalia in the Collection of the British Museum, I have thought it advisable to give a brief preliminary notice of some rather interesting points in connection with the structure and distribution of a few forms of Carnivora and Rodentia; in which orders I have now gone through the entire collection of specimens. I also notice one specimen to which I have assigned a new specific name; and another which does not belong to the collection of the British Museum. Several of the more interesting specimens will be illustrated by woodcuts in the forthcoming catalogue.

#### CARNIVORA.

##### HERPESTES MINIMUS (Filhol).

A ramus of the mandible of the small carnivore from the phosphorites of Caylux agrees so closely with the mandible of the existing Indian *Herpestes nipalensis*, both as regards size and structure, that there seems every likelihood of its belonging to the same genus. The specimen agrees with a fragmentary mandible described by Filhol ('Ann. Sci. Géol.' vol. vii. art. 4, p. 150; vol. viii. pl. xx. figs. 334, 336) under the name of *Viverra minima*. This specimen will be figured.

CYNODICTIS LONGIROSTRIS, Filhol.

A cranium from the phosphorites of Bach may very probably be referred to this species; which was previously merely known by the mandible. This specimen will be figured.

LYCAON ANGLICUS, Lyd., sp. nov.

I propose to apply this name to the ramus of the mandible of a large canoid animal from the caves of Spritsail-Tor, Gower, Glamorganshire, figured in Falconer's "Palæontological Memoirs," vol. ii. pl. xxxvi. figs. 1, 2, under the name of Hyænoid Wolf. The fourth premolar agrees so closely with that of the existing *Lycaon pictus*, and differs so widely from that of *Canis*, that it appears advisable to refer the specimen provisionally to *Lycaon*. The carnassial differs considerably from that of *L. pictus*. In view of the presence of races of the existing African *Hyæna* and *Hippopotamus* in the English Pleistocene, the presence of a representative of the existing African genus *Lycaon* is perhaps what might have been expected. The fossil form shows some signs of being intermediate between *Canis lupus* and *Lycaon pictus*, although nearer to the latter.

CANIS VULPES, Linn., from the Red Crag.

Mr. Robert Bell, F.G.S., has submitted to my notice the palate of a species of *Canis*, obtained from the Red Crag at Boyton, Suffolk, one-half of which is figured in the accompanying woodcut (Fig. 1). The specimen was obtained low down in the Crag, a short distance above the phosphatic bed, and Mr. Bell says that it could not have been introduced, but must be regarded as a true Crag fossil. The bone is not in the intensely hard condition characteristic of the fossils from the phosphatic bed; but the diploë is extensively impregnated with dark phosphatic matter, and the teeth are stained a deep black colour. The specimen comprises the greater portion of the palate, and has not been subjected to rolling: it exhibits the alveoli of the first and second incisors; both the third incisors; the right canine, and the alveolus of the left; the alveoli of the first premolar; the second and third premolars of both sides; the right carnassial, and the alveolus of the left; the first true molars of both sides; and part of the alveoli of the second true molars. The much-worn condition of the teeth shows that the specimen belonged to a very old animal.

The specimen agrees precisely in relative proportions with the cranium of *Canis vulpes*; but it is of considerably larger size than any existing or cavern specimens that have come under my notice. The size of the teeth and



FIG. 1. *Canis vulpes*, half of palate. From the Red Crag.

the width of the palate are indeed nearly the same as in some individuals of *Canis aureus*, but the palate is much longer; and the resemblance of the specimen to the cranium of *Canis vulpes* is so close, that, in spite of its superior size, it appears necessary to refer it provisionally to that species.

Apparently the earliest well-authenticated horizon<sup>1</sup> from which *C. vulpes* has been hitherto obtained is the Norfolk Forest-bed;<sup>2</sup> and, if the ascribed origin of the present specimen be really correct, the occurrence of the same, or a closely allied, species in the Red Crag is a matter of considerable interest.

In the following table the dimensions of the fossil are compared with those of a full-sized skull of a recent *Canis vulpes*, viz.:

	Fossil.	Recent.
Interval between 3rd incisor and hinder border of m. 1.....	0·074	0·064
Width at m. 2.....	0·047	0·043
Intermolar space at pm. 4.....	0·025	0·023
Interval between canine and carnassial.....	0·034	0·030
Ant. post. diameter of canine.....	0·009	0·008
Length of pm. 2.....	0·011	0·009
"    "    3.....	0·012	0·010
"    "    4.....	0·017	0·016
"    m. 1.....	0·011	0·010
Width    "    ".....	0·015	0·013

#### HYÆNARCTOS, from China.

A second right lower true molar of a *Hyænarctos*, from the Pleistocene (?) of the South of China, indicates the extension of the range of the genus into that country. The specimen, of which a figure will be given in the catalogue, does not afford sufficient characters for the determination of the species to which it belonged.

#### HYÆNODON, from the Headon beds.

The mandible of a *Hyænodon* from the Headon beds of Hordwell agrees precisely with that of *H. minor*, Gervais, and may be referred to that species.<sup>3</sup>

#### PTERODON, from the Bembridge beds.

Some lower molar teeth of a *Pterodon* from the Bembridge limestone of the Isle of Wight agree so closely with the corresponding teeth of *P. dasyuroides* that there is every probability of their belonging to the same species.

<sup>1</sup> In a paper by Messrs. A. and R. Bell on the Crag, published in the "Proc. Geologists' Assoc.," vol. ii. Nos. 5 and 6, *Canis vulpes* is recorded from the Norwich Crag; but no authority is given for the statement.

<sup>2</sup> Vide Newton, GEOL. MAG. Dec. II. Vol. VII. p. 153 (1880). Mr. Newton has some doubt of the correctness of the specific determination; but it appears to me to be in all probability correct.

<sup>3</sup> The exact position of the bed from which this *Hyænodon* was obtained is given in the Quart. Journ. Geol. Soc. vol. xxxix. p. 571. Prof. Boyd-Dawkins (*Ibid.* vol. xxxvi. p. 383) mentions *H. leptorhynchus* from the Headon beds; the statement probably resting on a wrong identification of the present specimen.



OXYÆNA GALLIÆ, Filhol.<sup>1</sup>

A specimen of the muzzle of the species, of which only a fragment of the mandible has been yet described, shows that there are but two pairs of incisors in the upper jaw, in place of the three which occur in all the American species. This specimen is figured in the accompanying woodcut (Fig. 2). I may add that I have very considerable doubt, whether *Oxyæna* should be separated from *Pterodon*.

RODENTIA.

Theridomys, from the Headon beds.

The *Theridomys* from the Headon beds of Hordwell<sup>2</sup> is indistinguishable from the continental *T. aquatilis*, Aymard; and may probably be referred to that species.

Archæomys, from the French Phosphorites.

Nesokia, from the Siwaliks of India.

A portion of the mandible of a rat from the Siwaliks of India (No. 16529, a), noticed by myself in the "Palæontologia Indica," ser. 10, vol. iii. p. 126 (1884) as *Mus.* (?) sp., turns out to belong to the genus *Nesokia*; and is practically indistinguishable from the mandible of the existing *N. Hardwicki*, Gray. From the difficulty experienced by zoologists in determining the number of existing species, it would be rash to say that the recent and fossil forms are specifically the same, although it is quite possible that this may be the case. Although the Siwalik Mammalia belong as a rule to extinct forms, it is quite probable that some of the Rodents may have persisted to the present day.

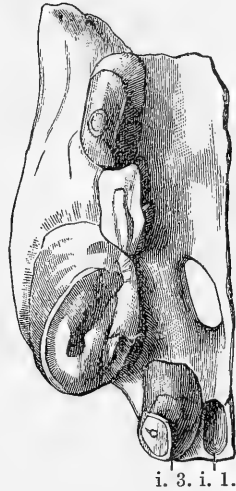


FIG. 2. *Oxyæna galliæ*. Anterior portion of left half of palate. From the Phosphorites of Caylux. †.

IV.—ON A SECTION OF KEUPER MARLS AT GREAT CROSBY.

By T. MELLARD READE, C.E., F.G.S.

A LITTLE more than half a mile in a direct line south-east of the village of Great Crosby, at Moorside, the Silicate Brick and Tile Company are excavating clay and shale for brick-making. The excavation at present is about 60 yards square and 35 feet deep from the original surface of the ground to the lowest point. It discloses a section of much interest.

In descending order we have surface soil and from 8 to 15 feet of Boulder-clay, the remainder being composed of argillaceous shales belonging to the Keuper marls. The Boulder-clay is of the ordinary character which covers most of the surface of the country about, and belongs to the Low-level Boulder-clay and sands, which I have else-

<sup>1</sup> Ann. Soc. Sci. Phys. et Nat. Toulouse, 1882, p. 34.

<sup>2</sup> Vide Quart. Journ. Geol. Soc. vol. xxxvi. p. 383.

where shown to be a glacial marine deposit.<sup>1</sup> It is full of the usual erratics, Silurian grits, grey granites, and greywackes from the South of Scotland, English Lake rocks, and Carboniferous Limestone and sandstones from the Pennine chain. The most peculiar feature in this instance is the large blocks of Lower Keuper sandstone, which rest on, and in some cases appear to be actually compressed or forced into, the marls below. This is the first instance of the kind I have met with in the neighbourhood of Liverpool, where the erratics at the base, if they are not on the rock, rest tranquilly on or partially in the red sand which often covers the Triassic sandstone.

The Boulder-clay for the purposes of brick-making is washed in a large cylinder containing revolving arms, the "slip" being run into settling-pits, the stones remaining behind. Much of the sand which is intimately mixed with the clay separates in these pits and is deposited near the mouths of the wood-shoots conveying the muddy liquid to the pits. Numerous fragments of marine shells can be seen in this washed sand which embedded in the clay are indistinguishable.

The shales below are, however, the feature of most interest in the locality. At first sight they look uncommonly like some of the Coal-measure shales; indeed so much so that one of the workmen from Staffordshire told me he thought coal would be found underneath. There can, however, be little doubt that they belong to the Keuper marls, and probably the lower portion of them. Their thickness has not been tested. They appear to have a general dip south-west, and in one place it was as much as 20°. The shales are however much disturbed, and at the west side of the pit two anticlinals were to be seen, but they are obscured at present from the slipping of the Boulder-clay from above over them. There are several bands of harder shale interbedded in the marls, one being 10 inches thick, of a very fissile character. At the north end of the excavation is a band of sandstone of a very friable nature, composed of loosely agglutinated rounded quartz grains resembling in appearance some of the sandstone in the quarry at Little Crosby. I observed some very large ripple-marks on the surface of this band, but there are no pseudomorphs of crystals of chloride of sodium anywhere that I could discover in the shales. One of the hard bands appeared to be an impure limestone, and effervesced strongly with acid, but the shale generally appears quite free from lime. The general colour of the whole deposit is a bluish grey. The method of treatment for brick-making is this: the argillaceous shales, excluding the hard bands and sandstones, are mixed with a little of the "slip" from the Boulder-clay, then ground in a mill, and forced in a plastic mass through a die and cut into bricks by wires fixed in a movable frame. The bricks it will be seen are free from the pebbles and limestone always contained in the local Boulder-clay bricks.

The extent of this deposit of Keuper marls is quite unknown. At all other exposures in Great and Little Crosby the rock is Lower Keuper sandstone. Nearly the whole district is covered with a

<sup>1</sup> Drift Beds of the North-west of England, Q.J.G.S., May, 1883.

mantle of Boulder-clay, and the existence of Keuper marls in the neighbourhood was before unknown, the Survey map showing the Lower Keuper sandstone for many miles round.

I had the pleasure this month (September, 1884) of showing the section to the members of the Liverpool Geological Society.

V.—REPORT UPON THE NATIONAL GEOLOGICAL SURVEYS OF EUROPE.<sup>1</sup>

By W. TOPLEY, F.G.S.,

Assoc. Inst. C.E., Geological Survey of England and Wales.

INTRODUCTION.

IN the following pages a brief account is given of the organization and publications of the chief Geological Surveys<sup>2</sup> in Europe. The statements are taken from official sources, or from an inspection of the publications.

Information has been kindly supplied by the directors of the following surveys:—Austro-Hungary, Bavaria, Belgium, Italy, Norway, Saxony, Spain, Sweden, Switzerland.

In the preparation of this report my colleague, Mr. W. H. Dalton, has given me much assistance; my thanks are also due to Professor G. A. Lebour and to Mr. F. W. Rudler.

The "Geological Record" gives descriptions of maps published in and since 1874.

The libraries of the Museum of Practical Geology and of the Geological and Geographical Societies contain a large collection of the maps and other publications of the various surveys (see the "Catalogues" of those libraries). The more important publications are noted as they appear in the "Proceedings of the Royal Geographical Society," the "Quarterly Journal of the Geological Society" (November number of each year) and in "Petermann's Mittheilungen" (Gotha).

The official title of the Survey is first given, with the place of the head office, which is also the place of publication unless otherwise stated. The mode of issue varies greatly, and therefore the exact titles of the publications are given as far as possible. It was intended to give information upon the various systems of colouring, the subdivisions mapped, signs used, etc.; but this would greatly have lengthened the Report, and it must stand till next year, if desired.

For information upon Topographical Surveys reference may be made to the "Notes on the Government Surveys of the Principal Countries of the World," prepared at the Intelligence Branch of the War Office, London, and published in 1883 (price 6s.). This gives the scales of all the chief maps; plates, with descriptions, of the various signs employed; full tables of all measures of length and

<sup>1</sup> A Paper read before the Geological Section (C), at the Meeting of the British Association at Montreal, 1884.

<sup>2</sup> The exact equivalent of the term "Geological Survey" is not used on the Continent; it is that of *Committee, Commission, Inquiry, Institute, or Service.*

surface, with their English equivalents. Brief mention is also sometimes made of the Geological Surveys.

In the following pages the natural scale of maps is given, this being the method almost universally adopted on the Continent. The following table gives the equivalents, in English inches, of the scales referred to:—

Natural Scale.	Inches to one Mile.	Countries.
1 : 10,000	6·336	Upper Silesia, Italy (part).
1 : 10,560	6·000	United Kingdom (part).
1 : 20,000	3·168	Belgium, Italy (part).
1 : 25,000	2·534	Prussia, Saxony, Alsace-Lorraine.
1 : 50,000	1·267	Sweden (part), Italy (part).
1 : 63,360	1·000	United Kingdom (part).
1 : 75,000	·845	Austria and Hungary.
1 : 80,000	·792	France.
1 : 100,000	·633	Italy, Norway, Switzerland, Bavaria.
1 : 144,000	·440	Austria and Hungary.
1 : 200,000	·317	Netherlands, Finland, Sweden (part).
1 : 400,000	·159	Spain.

The meridian adopted for the maps varies much. As a rule it is that of the capital of the country. The exceptions to this are the maps of Germany and some of Norway, where the meridian is Ferro, and Switzerland, where it is Paris. Paris has been taken as the meridian for the map of Europe, now being prepared by a committee of the International Geological Congress; scale 1 : 1,500,000. This map, in 49 sheets, will be based upon those of the Geological Surveys hereafter described.

The International Geodetic Congress at Rome, in 1883, recommended the adoption of Greenwich as the universal meridian, longitude to be reckoned from west to east only. The Congress meets at Washington in October of this year (1884), when the provisional resolution passed at Rome will probably be confirmed.

On the Continent a large number of official and semi-official publications have been made by Government mining engineers and others, but these are not here included unless they form part of a systematic survey or give the main results of such survey.

The earliest survey is that of the United Kingdom, 1832. In all its essential characters this is now much the same as when left by its founder, Sir H. de la Beche, and probably no other survey yet rivals it in the variety and completeness of its publications. Many of the more important Continental surveys have been commenced during the last 15 years.

Much difficulty has been felt in deciding what small general maps should be mentioned. The Catalogues already referred to give the titles of many of them. For the most part those only are here mentioned which are official, or which are known to be reductions of official maps.

Some interesting results come out from this investigation as regards the relative amount of work done by private and official geologists. In England the foundations of the survey, and in fact of all detailed field geology, were laid by private workers, and a very large proportion of English geological literature has always

come from them. On the Continent this has rarely been so; nearly all the surveys are directly due to the Governments, and much of the geological literature comes from those connected with the surveys, or from official mining engineers. There, also, many Professors of geology are connected with the surveys; this is not now the case in England, although many of its Professors have at one time served on the staff. In fact at the present time the Geological Survey and Cambridge University almost divide between them the active teaching power of geology in England.

The publications of the English Society are confined to questions relating to its work and progress; but this is not always the case abroad. The staffs of the Austrian and Prussian Surveys have always been active in working at the geology of districts outside their own special areas, which are by no means small, and the results are given in the official publications of those Surveys. The best work of late years relating to the geology of Turkey and Greece has been done by officers of the Austrian Survey.

**ALSACE-LORRAINE.**—*Commission für die Geologische Landes-Untersuchung von Elsass-Lothringen* (Strasburg).

The director is E. Cohen. The maps—'Geologische Spezialkarte von Elsass-Lothringen,' are on the scale of 1: 25,000.

The publications are 'Abhandlungen,' with atlas, dating from 1875; the first volume contains a Bibliography of Alsace-Lorraine, by E. W. Benecke and H. Rosenbusch, pp. 77.

A map of the environs of Strasburg—'Geologische Karte der Umgegend von Strassburg,' by E. Schumacher, 1: 25,000, 1883—gives special agricultural information, like the maps near Berlin.

**AUSTRO-HUNGARY.**—*Kaiserlich-Königliche Geologischen Reichsanstalt* (Vienna).

This Survey was established in 1849, with W. von Haidinger as director; he was succeeded in 1867 by the present director, F. R. von Hauer. Dionys Stur has been vice-director since 1877.

The field work of the survey, which is mostly done on the scale of 1: 25,000, is at present divided into four sections:—(1) under G. Stache, in Tirol; (2) under E. von Mojsisovics, in N. Styria; (3) under C. M. Paul, in the Galician Carpathians; (4) under E. Tietze, in the western and north-western parts. There is a large staff of assistant geologists and others.

There are in all about twenty-three official topographical maps of Austro-Hungary or of parts of it, on scales from 1: 12,500 downwards. These are all being absorbed in the 'Uebersichts-Karte,' scale 1: 75,000, on which the geological information is published. The complete topographical map will be in 715 sheets, of which 270 are published with the geology ('Neue Spezialkarte'), dating from 1870.

The meridian is Ferro, 18° 9' W. of Greenwich. The heights are given in metres; there are contour-lines at intervals of 50 metres. The sheets are not quite rectangular, the right and left edges being always meridian lines, 30' apart.<sup>1</sup>

<sup>1</sup> This most convenient arrangement is also adopted in the maps of Prussia and Saxony.

The maps are denoted by a double system of numbering—Vertical (*Colonne*) (i. to xxxv.) and Horizontal (*Zone*), 1 to 37.

The 270 sheets now published are thus grouped:—

Upper and Lower Austria.....	38
Moravia and Silesia .....	30
Tyrol .....	37
Illyria, Styria, and Salzburg .....	45
Galicia and Bukowina .....	101
Hungary.....	12
Bohemia.....	7
	270

The prices vary from 1 to 8 fl. (2 to 16 sh.).

A smaller map, scale 1 : 144,000, is also published, of which 158 sheets are issued. This map is divided into various provinces. The sheets now published are as follows, the prices varying from 1 to 6 fl. (2 to 12 sh.),—

I. Austria above and below the Enns.....	29
II. Salzburg .....	13
III. Styria and Illyria.....	36
IV. Bohemia .....	38
V. Hungary .....	42
	158

The following general maps are issued:—

I. Hungary .....	18 sheets
II. Lombardy and Venetia .....	4 „
III. Transylvania .....	4 „
IV. Banat .....	4 „
V. Slavonia and the Frontier .....	1 „
VI. Bosnia and Herzegovina.....	7 „
VII. Dalmatia .....	2 „

The publications of the survey, other than maps, are:—

‘*Abhandlungen der k. k. geol. Reich.*,’ of which ten volumes have appeared, dating from 1852, price 23 to 70 fl.; ‘*Jahrbuch*,’ from 1850; ‘*Verhandlungen*,’ from 1867.

A ‘*General Register*’ of the ‘*Jahrbuch*’ is published.

Numerous Memoirs, stratigraphical and palæontological, from the ‘*Abhandlungen*,’ are separately issued.

Several semi-official memoirs, with large maps or special maps, are published by officers of the survey, the most important being:—

V. Mojsisovics, ‘*Dolomitriffe von Südtirol und Venetien*,’ 2 vols. 1879, price 19 fl. Map, in 6 sheets (1 : 75,000) separately issued.

V. Mojsisovics, Tietze, and Bittner, ‘*Grundlinien der Geologie von Bosnien-Herzegovina*,’ 1880, price 12 fl. Map, 1 : 576,000.

V. Hauer, ‘*Geol. Uebersichtskarte der österr.-ungar. Monarchie*,’ 12 sheets, 1 : 576,000; 45 fl.

V. Hauer, smaller map of the same, 1 : 2,016,000, 4th ed. 1884; 6 fl.

BAVARIA. — *Bureau der Geognostischen Untersuchung des Königreichs Bayern* (Munich).

The survey was commenced in 1851, under C. W. von Gümbel, the present director. The publications date from 1861; they have been issued at Gotha, but in future will be published at Cassel.

The field work is done on various scales, from 1 : 5,000 to 1 : 25,000; the publication is usually on the scale of 1 : 100,000, but in special cases 1 : 50,000.

Two meridians are used on the maps—Ferro ( $18^{\circ} 9'$  W. of Greenwich) and Munich ( $11^{\circ} 36'$  E. of Greenwich). The maps are not contoured.

Explanations of separate sheets are not published, but the maps are grouped, for purposes of explanation, as follows:—

1. 'Geognostische Beschreibung des Bayerischen Alpengebirgs und seines Vorlandes' (southern frontier), 5 maps. 96 marks.

2. 'Geog. Besch. des Ostbayerischen Greuzgebirgs' (Bayreuth, Ratisbon, Passau), 5 maps. 108 marks.

3. 'Geog. Besch. des Fichtelgebirgs und Frankenwaldes' (N. of Bayreuth), 2 maps. 70 marks.

There is no official general map; but the director has published the following, without text:—'Geog. Uebersichts-Karte des Königreichs Bayern,' Munich, 1858, 1 : 500,000. Price 17.20 marks.

**BELGIUM.**—*Service de la Carte Géologique de la Belgique* (Brussels).

This survey was established in 1877, as a part of the 'Musée Royal d'Histoire Naturelle de Belgique' (Brussels). The work is executed under the 'Commission de Contrôle de la Carte Géologique de la Belgique,' composed of five members of the Royal Academy of Belgium, with M. Stas as president. The surveying work is done under the direction of Ed. Dupont, with three 'conservateurs' and eleven assistants. A peculiar feature of this survey is that each main division of the geological series is traced out completely by one man, so that an index map of progress is also a geological index map.

The map is on the scale of 1 : 20,000, with contours at 5 metres interval on the left bank of the Meuse, and at 10 metres on the right bank. The map is in 72 main divisions; each containing, when complete, 8 sheets; in all there will be 450 sheets. The meridian is Brussels,  $4^{\circ} 22'$  E. of Greenwich. Each sheet is accompanied by 'Texte explicatif' (see below, 'Annales').

The maps give the nature of the soil, and note by dark shades of colour, the actual areas at which solid rock is exposed.

The memoirs issued by the Survey are in two forms, dating from 1877:—'Annales du Musée R. d'hist. Nat. de Belgique,' in fol., each volume with atlas; and 'Bulletin,' in 8vo. The former is divided into four series—palæontology, lithology, stratigraphy, existing fauna. The stratigraphical series is in explanation of the sheets of the map.

A general map—'Carte Géologique de la Belgique, exécutée par ordre du Gouvernement,' scale 1 : 160,000—was prepared by André Dumont from 1836 to 1854, and was published in 1854. A new issue of this was made in 1877, in two editions—soil and rock, price 40 francs each map. This map was accompanied by Memoirs. Those on the 'Terrain ardennais et rhénan' were published by Dumont in the *Mém. Acad. Roy. Belgique*, 1847 and 1848; those on the 'Terrains crétaçés et tertiaires,' prepared by Dumont and edited by M. Mourlon, are published in four vols. 8vo. 1878–1882.

A reduction of Dumont's map, scale 1 : 380,000, showing the beds below the Hesbayen and Campinien, was published in 1877 by Lelorrain and E. Henry.

FINLAND.—*Finlands Geologiska Undersökning (Suomenmaan Geologillinen Tutkimus)* (Helsingfors).

This survey was commenced in 1865, under the Department of the Administration of Mines, on the scale of 1 : 200,000, the director being K. Ad. Moberg.

The publication commenced in 1879; five sheets, in the neighbourhood of Helsingfors, were issued up to 1882. There are descriptions ('Beskrifning') to the sheets. All the superficial deposits are shown.

The explanations on the maps are given in Finnish and Swedish; the 'Beskrifning' is in Swedish.

The meridian is Helsingfors, 25° 12' E. of Greenwich.

FRANCE.—*Carte Géologique détaillée de la France* (Paris).

The origin of this survey may be traced to the Paris Exhibition of 1855, when, under the direction of Dufrenoy and Elie de Beaumont, twenty maps, scale 1 : 80,000, were coloured geologically in MS. and exhibited.

These maps, with others, amounting in all to sixty-two, all in the N. and N.W. of France, were again presented at the Paris Exhibition of 1867.

The recognition of the value of such maps, and the fact that similar surveys were in progress in neighbouring countries, led to the establishment of the geological survey in 1868, with Elie de Beaumont as director. On his death, in 1875, M. Jacquet became director.

The map employed is the 'Carte Topographique de l'Etat Major,' scale 1 : 80,000. The meridian is Paris, 2° 20' E. of Greenwich. The map of France is in 258 sheets; Corsica in sheets, 259-267. It has hill shading without contours; heights in metres.

Each map is accompanied by an 'Explication' printed on one side only, to be attached to the map if desired; also by plates containing longitudinal and vertical sections and photographs.

A very elaborate system of signs has been employed on the maps, for distinguishing minute varieties of rocks, soils, ores, mineral springs, etc. The number of these signs is 1113. In addition to these a large number of subordinate signs have been devised, further explaining or modifying the others.<sup>1</sup>

As the work progresses, it will be reduced and published on the scale of 1 : 320,000; this will be in 32 sheets; Corsica in sheet 33. Each sheet of this map will include 16 sheets of the larger scale.

The publication of the maps commenced in 1873, with sheet 48, Paris; the explanation of this being 'Cahier I.' About 47 sheets are now issued, chiefly in the north.

In addition to the explanations of sheets there are "Mémoires"; No. 1, 'Pays de Bray,' by De Lapparent, was published in 1873.

The foregoing statements refer only to the existing survey, but

<sup>1</sup> All these signs, etc., are fully explained in pamphlets issued in 1874, 'Généralités' A, B, C, and D.



there were official publications of earlier date.<sup>1</sup> In 1822, incited thereto by the publication of Greenough's 'Geological Map of England and Wales' (1819-20), a survey was commenced by Dufrenoy and Elie de Beaumont, under the direction of Brochant de Villiers. From 1822 to 1825 the surveyors were studying field geology in England. In 1825 the work was commenced in France, De Beaumont taking the east, Dufrenoy the west. There were two assistants, and the survey was completed in 1830.

The Map, "Carte Géologique de la France," is in 6 sheets, scale 1 : 500,000. It was published in 1840-42; the two volumes of 'Explication' in 1841 and 1848.

A reduction of this map ('Tableau d'Assemblage'), scale 1 : 2,000,000, was published in 1841.

There are a large number of maps and memoirs of Departments; some by private geologists, but most by official mining engineers. These maps are on various scales; some, as that of the Pas de Calais (by Du Souich, 1851) on the full scale of 1 : 80,000.

A Geological Map of France in 48 sheets, scale 1 : 500,000, is in preparation by C. Vasseur and L. Carez.

ITALY.—*Reale Comitato Geologico d'Italia* (Rome).

This survey was commenced in 1868, when the capital was Florence. It was directed by a committee of Professors at Universities and Engineers of Mines. In 1873, when the chief office and place of publication were transferred to Rome, the staff was reorganized; the *Comitato* (with Professor Meneghini as President) retained only a consulting power, the real chief of the survey being F. Giordano, the present director. The staff consists of 7 geologists, 3 assistants, and a palæontologist.

The systematic and detailed investigation of the country dates from 1873, and was commenced in Sicily; in 1879 the survey was extended to the Apuan Alps and the Roman Campagna. The scale adopted for the survey is usually 1 : 50,000; areas of special interest, such as those mentioned above and parts of Sardinia, are surveyed on the scale of 1 : 25,000. Recently some surveys have been made on the scale of 1 : 10,000—of Elba, Ischia, and the environs of Rome.

A general map (1 : 1,111,111) was published in 1881; another, on the scale of 1 : 500,000, is now in preparation, Sicily being published (1883).

The systematic publication of the survey map will be on the scale of 1 : 100,000, in 277 sheets, those of Sicily being nearly ready for issue. Districts of special importance will be published on the scale of 1 : 25,000, with contours; Elba, in two sheets, is now ready.

In the topographical maps prepared by the Italian Government (of which there are 18, on various scales), the meridian is reckoned from Rome (Mont Mario), which is 12° 28' E. of Greenwich. There is a topographical map, prepared by the Austrian Government, on the scale of 1 : 75,000, in which the meridian is reckoned from Ferro; but this map is not used by the Geological Survey.

<sup>1</sup> A notice of the various geological maps of France was given, by G. A. Lebour, in the *Geographical Magazine*, vol. iii. p. 47, 1876.

The publications comprise the 'Bolletino' (in 8vo.), dating from 1870, of which fourteen volumes are published; and 'Memorie' (in fol.), dating from 1871, of which the second part of vol. iii. is now appearing. These volumes contain numerous maps, on various scales, and plates of fossils. Many of the authors of papers here published are not connected with the survey; but, as a Geological Society was founded for Italy in 1881 (at Bologna), the survey publications will probably in future be more purely official.

Several semi-official maps are issued. Three are by Prof. Capellini, a member of the *Comitato*. These are—the Bolognese Apennines; Leghorn (each 1 : 100,000); Gulf of Spezia (1 : 50,000).

NETHERLANDS.—*Commissie voor de Geologische Kaart van Nederland* (Haarlem).

An official survey of this country was made by W. C. H. Staring, and published ('*Geologische Kaart van Nederland*') at Haarlem, in 27 small sheets; 1858-67 with explanation. The scale is 1 : 200,000; the meridian Amsterdam, 4° 55' E. of Greenwich. The map shows 13 varieties of alluvium, 8 of diluvium, 16 of Pliocene—Eocene, with other rocks down to Devonian. Another map (? not official) has been published by Kruijder, in six sheets, 1880.

NORWAY.—*Geologiske Undersøgelse* (Christiania).

The geological investigation of this country is in two parts; that of Southern Norway, under the direction of Th. Kjerulf, dating from 1858; that of Northern Norway, under the direction of T. Dahll, dating from 1866. For the former there are two assistants, with extra help during the summer; for the latter there is one assistant.

The surveying work is done on various scales—1 : 20,000, 50/, 100/, and 200,000. For the last the meridian is Ferro; for the others it is Christiania, 10° 43' E. of Greenwich.

The published map of Southern Norway ('*Geologiske Oversigts-karte*') is on the scale of 1 : 100,000, with contours at 100 feet (1 Norwegian foot = 12·35 English inches). Seventeen sheets are published, dating from 1876. These are grouped as follows: Trondhjem and district, 8 sheets; Bergen, 2; Hamar, 2; Christiania and Fredrickstadt, 5. Each sheet is priced kr. 1·60 (1 kr. = 1s. 1¼d.).

A general map of part of Southern Norway (Diocese of Christiania, Hamar, and Christiansand) was published in 1856-65, by Th. Kjerulf and T. Dahll; scale 1 : 400,000; 10 sheets; with explanatory pamphlet in French; in this the meridian is Ferro.

A general description of Southern Norway with atlas and map (1 : 1,000,000) was published by Th. Kjerulf in 1879 (German translation, by Dr. A. Gurlt, in 1880). A map of Northern Norway on the same scale was published in 1879, by T. Dahll.

There is no regular publication of memoirs and papers of the survey; but they appear in various journals, transactions, and the University treatises. The collection made by the survey is at present deposited in the Mineralogical Cabinet of the University of Christiania.

PORTUGAL.—*Comissão Geologica de Portugal* (Lisbon).

Of this survey ('*Secção dos Trabalhos Geologicos de Portugal*') Carlos Ribeiro was chief.

Several memoirs have been published; and also a map—‘*Carta Geologica de Portugal*,’ by C. Ribeiro and J. F. N. Delgado, scale 1 : 500,000; 1876.

PRUSSIA.—*Königliche Geologische Landes-Anstalt und Bergacademie zu Berlin* (Berlin).

The publications of this survey date from 1870; the director is W. Hauchecorne.

The map—‘*Geologische Special-Karte von Preusse und den Thüringischen Staaten*’—is on the scale of 1 : 25,000, with hill shading and contours.

It is divided into 88 ‘*Grad-Abtheilungen*,’ each subdivided into 60 ‘*Blättern*,’ excepting on the frontier and sea-board, where some sheets are absent. Each complete ‘*Grad-Abtheilung*’ contains exactly 1° of long. and 1° of lat.; each ‘*Blatt*’ contains 10’ of long. and 6’ of lat.; the sheets are therefore not quite rectangular. The longitude is reckoned from Ferro, 18° 9’ W. of Greenwich.

The publication takes place in ‘*Lieferungen*,’ each containing from three to nine maps of the same district, though not always in the same ‘*Grad-Abtheilung*.’ The ‘*Lieferungen*’ vary in price according to the number of maps included, averaging 2 marks per map with its ‘*Erläuterung*.’ The maps near Berlin are especially agricultural, minute variations of soil being indicated by signs.

About 26 “*Lieferungen*” are issued, containing 142 sheets; which, for convenience of reference, may be grouped as follows:—

Berlin, Potsdam, etc. ....	27
Wettin, Jena, etc. ....	84
Wiesbaden, Frankfort, etc. ....	13
Saarbruck, etc. ....	18

---

142

A descriptive text (‘*Erläuterung*’) is issued with each map.

There are also ‘*Abhandlungen*’ dealing with special districts, palæontology, etc. These date from 1872. They contain numerous plates and maps, the latter being sometimes separately issued.

The *Jahrbuch*, dating from 1880, contains shorter papers, reports, &c.

A reduction of the above-mentioned map—‘*Geologische Karte der Provinz Preussen*,’ scale 1 : 100,000—is in course of publication.

Numerous general maps of Germany or of parts of it are published, the most important of which is that of H. von Dechen—‘*Geologische Karte der Rheinprovinz und der Provinz Westfalen*,’ in 35 sheets, scale 1 : 80,000. A continuation of this map, on the same scale, being a reduction of the new Prussian survey, is now being prepared. The Wiesbaden sheet (numbered 35) was issued in 1882.

Geological surveys of some German States have been made on the scale of 1 : 50,000, not all directly by the Government, but the great survey above described will probably absorb these and will re-map the districts on the larger scale.

Amongst these local surveys are the following:—

BADEN made by Zittel and Sandberger.

HESSE.—‘*Geologische Spezialkarte des Grossherzogthums Hessen und der angrenzenden Landesgebiete*.’ This survey, under the

direction of R. Ludwig, is in eighteen sheets, with text. It was made by the 'Mittelrheinischer Geologischer Verein' (Darmstadt), and was published from 1855 to 1872.

UPPER SILESIA.—A 'Specialkarte der Oberschlesischen Bergreviere,' scale 1 : 10,000, is published by the 'k. Oberbergamt in Breslau'; in 'Lieferungen,' of ten or more sheets. The price of each sheet is 1½ mark.

SAXONY.—*Königliche Geologische Landesuntersuchung von Sachsen* (Leipzig).

This survey dates from 1872; the publications from 1877. The director has from the commencement been Hermann Credner. There are eight assistant geologists.

The scale for mapping and publication is 1 : 25,000; the meridian is Ferro, 18° 9' W. of Greenwich. The maps—'Geologische Specialkarte des Königreiches Sachsen'—are contoured at intervals of 5 metres on the lowlands and 10 metres on the hills.

The division of the maps, as regards lines of latitude and longitude, is the same as in the Prussian maps. The maps of Saxony have a special numbering of their own, but most of them now published would be contained within Grad-Abth. 58 and 72 of the large Prussian map.

The maps show all the drift-deposits, the soils being sometimes noted and described in detail.

In some cases a separate edition, showing only the solid rock, is issued. There are also special issues for certain mining districts.

Much attention is paid to the petrological variations in the crystalline and eruptive rocks, these being noted by letters and signs.

Thirty-five sheets are published, all in the western part of Saxony, but those in the extreme south-west are not yet issued. The price of each sheet is 2 marks, of the accompanying 'Erläuterung' 1 mark.

A general map has been published by the director, 'Uebersichtskarte des Sächsischen Granulitgebirges und seiner Umgebung,' scale 1 : 100,000, 1884; price, with Erläuterung, 5 marks.

Detailed descriptions of the work and publications of the Survey of Saxony have been published by the director (H. Credner) in 'Mittheil. des Vereins für Erdkunde zu Leipzig,' 1877 and 1880.

SPAIN.—*Comisión del Mapa Geológico de España* (Madrid).

The Commission was formed in 1849, with F. Luxan as director. At one time under the Statistical Department, it was, in 1872, placed with that of the Mining Engineers. The existing organization and systematic publication date from 1873, when the present director, Manuel Fernandez de Castro, was appointed.<sup>1</sup>

The Government topographical map of Spain is on the scale of 1 : 50,000, with contours at 20 metres apart. This was commenced only in 1875, and few sheets are published; it will be completed in

<sup>1</sup> A full account of this survey was published for the Mining Exhibition in Madrid, 1883—*Com. Mapa Geol. Españ., su origen, vicisitudes y circunstancias actuales*, with two index maps (*Boletín*, t. x.). An earlier publication '*Memoria . . . Mapa Geol. Españ.*, 1876, Madrid, pp. 183. This gives a full account of the geological literature of Spain (in provinces) and its foreign possessions.

about 1,080 sheets; this map is not used by the Geological Survey. Other maps are on the scale of 1 : 100,000 and 1 : 200,000. The last is that usually employed in the field work of the geological survey. The longitude in all is reckoned from Madrid,  $3^{\circ} 41'$  W. of Greenwich.

The staff of the survey since 1873 has usually contained six mining engineers and seven or eight assistants.

The maps are issued on the scale of 1 : 400,000, with the reports on each province (see below).

The publications of the survey consist of the 'Boletin,' dating from 1874, and the 'Memorias' dating from 1875.

Each volume of the 'Memorias' is devoted to the 'Descripción física y geológica' of a single province; mining is added in the title of some, and agriculture in others, these latter being those written by Daniel de Cortázar. The volumes, of from 200 to 400 pages, contain plates of fossils, sections, etc., and also the maps (1 : 400,000) already referred to.

The 'Boletin' contains shorter descriptions of special districts, translations of foreign memoirs on Spanish geology, etc. The maps here are on various scales. Altogether, since 1873, twenty-seven provinces have been described; eleven of them with maps of 1 : 400,000.

Descriptions of some provinces, with maps, were published before the reorganization of the survey in 1873; some had maps of 1 : 400,000.

The palæontological work of the survey is scattered throughout the various volumes, but this is now being collected and separately issued.

The largest (and in some respects the best) general map of Spain and Portugal is that of De Verneuil and Collomb (1 : 1,500,000), published in Paris in 1864; and a second edition, with text, in 1868 (now out of print). Another map (1 : 2,000,000) was published by F. de Botella, of the Spanish Survey, in 1881. The price of this is 15 francs; there is no text.

At the conclusion of the work of the survey, now approaching, a complete map of Spain, on the scale of 1 : 400,000, will be published in sixteen sheets; the first sheet will probably be published in 1885.

SWEDEN.—*Sveriges Geologiska Undersökning* (Stockholm).

This survey was commenced in 1858 with Alex. Erdmann as director. In 1869-70 the director was A. E. Törnebohm; he was succeeded in 1871 by the present director, Otto Torell.

The staff consists of twelve geologists, with some additional assistants during the summer months.

The survey is made on two scales; in the more populous districts, 1 : 50,000; in the mountainous districts, 1 : 100,000. In the former case the maps are published on that scale, in the latter the publication is on the scale of 1 : 200,000.

The meridian is Stockholm,  $18^{\circ} 3'$  E. of Greenwich. The maps are not contoured, but numerous heights are given in Swedish and Norwegian feet (= 12·35 English inches).

The publications date from 1862.

Of the sheets on the 1 : 50,000 scale (Ser. A, a) about 83 are published; these are numbered in the order of publication, irrespective of their relative positions. Each sheet is accompanied by a descriptive 'Beskrifningar.' The prices, for map and description, are 2 kroner for the full sheets; 1, or 1½ kroner for the coast sheets (kroner = 1s. 1¼d.).

Of the sheets on the scale of 1 : 200,000 (Ser. A, b) ten are published, each with 'Beskrifningar,' price 1½ kroner.

All the maps give the distribution of the superficial deposits, but a few are published with special reference to these and to agriculture. That of the environs of Skottorp, scale 1 : 4000, shows by signs the nature and composition of the soil in great detail. There are also some special maps referring to mining, etc.; these extra maps are in Ser. B.

A general map of Southern Sweden (south of lat. 59° 45'), on the scale of 1 : 1,000,000, will be published with a description during this year (1884).

In addition to the explanations of the maps, there are memoirs in Ser. C ('Ahandlingar och uppsatsen') in 8vo. or 4to., with or without plates or atlas. Eighty of these are published, dating from 1863, at various prices up to 8 kroner. They refer to palæontology, stratigraphy, petrology, economic and theoretical geology; most are in Swedish, but a few are in French, German, or English.

A map of the iron district of Central Sweden, though not an official publication of the Survey, should be mentioned here. This is prepared, by A. E. Törnebohm, for the Board of Swedish Ironmasters (Jernkontoret). It is in nine sheets (1879–82); each, with description, price 4 kroner. Its title is 'Geologisk Ofversigtskarta öfver Mellersta Sveriges Bergslag'; the scale is 1 : 250,000.

Another similar publication, also by Törnebohm, is 'Geologisk atlas öfver Dannemora grufvor,' in 17 sheets, with description, 1878. All the publications referred to are issued at Stockholm.

SWITZERLAND.—*Beiträge zur Geologischen Karte der Schweiz (Matériaux pour la Carte Géologique de la Suisse)* (Berne).

The present organization dates from 1859, when the Federal Council offered to the Swiss Natural History Society a grant in aid of colouring geologically the topographical map ('Carte Dufour'). A geological commission of five members was then formed, with Bernard Studer as President.

The map is in 25 sheets; three of the corner sheets are for title, index, etc. Eighteen sheets are published, those not yet issued being XIII., XIV., and XVIII., all in Central Switzerland.

The scale is 1 : 100,000; the meridian is Paris, 2° 20' E. of Greenwich.

The text, chiefly in German, but partly in French and Italian according to the locality described, is contained in 'Lieferungen' 1–28, dating from 1862. Some of these describe one or more sheets of the map; others describe special districts, with maps on the scale of 1 : 50,000 or 1 : 25,000.

A general map, 'Carte Géol. de la Suisse,' was published by B.

Studer and A. Escher von der Linth in 1853, scale 1 : 350,000 ; with text—'Geologie der Schweiz,' by B. Studer, 2 vols., 1851–53.

UNITED KINGDOM.—*Geological Survey of the United Kingdom* (London).

The founder of this Survey was H. T. de la Beche, who before 1832 had coloured geologically the Ordnance one-inch maps of the South-West of England. In that year a small grant was made by the Government towards the cost of publishing these maps by the Ordnance Survey, but De la Beche also contributed money for the purpose. Subsequently De la Beche was definitely appointed to make a Geological Survey, under the direction of General Colby, then the head of the Ordnance Survey. The first result of this was the publication of the 'Report on the Geology of Devon, Cornwall, and West Somerset,' 1839, with the one-inch maps of the district.

About 1832 other geologists were surveying various districts upon the one-inch maps of the Ordnance Survey—William Smith in many parts;<sup>1</sup> W. Lonsdale near Bath; H. Maclaughlan and J. R. Wright (both of the Ordnance Survey) the Forest of Dean and near Ludlow respectively; W. Logan in S. Wales. Some of this information, notably Logan's, was incorporated in the official geological maps.

In 1845 the Geological Survey was detached from the Ordnance Survey and was placed under the 'Office of Woods and Works;' in 1854 it became a branch of the 'Department of Science and Art.'

From about the year 1832 some officers of the Ordnance Survey in the N. of Ireland collected geological information, which was completed and published by Captain J. E. Portlock in 1843.

The geological survey of Ireland was commenced in 1845, with Captain H. James as director, the subsequent directors being T. Oldham in 1845; J. B. Jukes, 1850; E. Hull, 1869.

The Survey of Scotland was commenced in 1854, and was made a distinct branch of the Geological Survey in 1867, with Arch. Geikie as Director, succeeded in 1882 by H. H. Howell.

England, the original home of the Survey, was presided over by De la Beche as Director till 1845, when A. C. Ramsay became director; he was succeeded in 1872 by H. W. Bristow, now the senior director.

The dates of appointment of the Directors-General are: H. de la Beche, 1845; Sir R. I. Murchison, 1855; A. C. Ramsay, 1872; Arch. Geikie, 1881.

Until 1845 the Survey was known as that of *Great Britain*; when the survey of *Ireland* was commenced, the original name was confined to that of Great Britain proper, the entire Survey being called that of the *United Kingdom*. In 1877 the title of Great Britain was discontinued entirely, this Survey being divided into those of *England and Wales* and *Scotland*.

The total number of the staff of the Geological Survey is now fifty-seven, distributed as follows: one Director-General, three Directors, three District-Surveyors, fourteen Geologists, twenty-five Assistant Geologists, four Naturalists and Palæontologists, four Fossil Collectors, three General Assistants.

The survey of the greater part of England has been done on the

<sup>1</sup> Smith made a Geological map of Somersetshire upon the one-inch scale in 1799.

1-inch Ordnance maps (1 : 63,360). In the North of England the 6-inch maps (1 : 10,560) have been used and much of the ground has been published on this scale. In the South of Scotland the 6-inch maps have been used; but in the North of Scotland the survey will be mainly on the 1-inch scale. In Ireland the 6-inch maps have always been employed for field work.

In Ireland the drift has always been shown upon the 1-inch maps by 'stippling.' Originally no glacial drift was shown upon the English maps; but in 1871 the publication of *drift maps* was commenced, and two editions of many of the maps are now issued—*solid* and *drift*. In the East of England only the drift maps are issued, very little being here known of the solid geology.

At the end of 1883 the field survey of the original 1-inch map of England and Wales was completed; the survey of the drifts over the areas over which these are not yet mapped has been commenced.

In Ireland and Scotland there is only one system of numbering the maps. In England some maps are in *sheets*, some are divided into *quarter-sheets*. In the new maps of the Ordnance Survey the system of dividing into quarter-sheets will be discontinued. The maps and their divisions in the North of England are the same in the old and the new series, the numbering only being different; but in the South of England there is no relation between the boundaries of the old and the new maps.

In addition to the maps there are 'Horizontal Sections,' on the scale (for heights and distances) of six inches to a mile. These are published at 5s. each; many have 'Explanations,' price 2d. each.

The details of Coal Measures, Cliff Sections, etc., are given on sheets of 'Vertical Sections,' 3s. 6d. each.

An 'Index Map,' scale four miles to the inch (1 : 253,440) has been published of Wales and the adjacent districts, in six sheets, price 3s. 6d. each. An Index Map of the whole of England and Wales, upon the same scale, is now in progress.

In all maps of the United Kingdom the meridian is Greenwich.

The publication of the Maps of England dates from about 1839, those of Ireland from 1855, of Scotland from 1859.<sup>1</sup>

The number of maps and sections published is shown in the following table:—

		England and Wales.	Ireland.	Scotland.	Total.
1-inch map (1 : 63,360) (sheets or quarter-sheets in England and Wales)	Solid .....	183			
	Drift edition of solid map ..	49			
	Drift only ....	12			
		244	180	33	457
6-inch maps (1 : 10,560) .....	216	10	128	354	
Horizontal sections .....	129	30	9	168	
Vertical sections .....	69	1	7	77	
Total .....	658	221	177	1056	

<sup>1</sup> A *Catalogue of the Publications of the Geological Survey of the United Kingdom to 1884* has just been issued, with index maps, pp. 95, price 1s.



The prices of the 1-inch maps are from 1s. 6d. to 8s. 6d. for England (a few detailed drift maps at higher prices); 1s. 6d. to 3s. for Ireland; 4s. to 6s. for Scotland; of the 6-inch maps, 4s. to 6s.

The 'Memoirs' of the Geological Survey date from 1845. Four volumes were consecutively numbered; vol. 1 and vol. 2 (in two parts) contain several papers. The other two volumes and all later 'Memoirs' are each confined to one subject or district. There are twenty-four volumes in all.

Memoirs or Explanations of sheets of the map have been issued since 1859; those published are—for England 49; Ireland, 92; Scotland, 17.

British fossils are described in 'Decades' (thirteen published, from 1849) and 'Monographs' (four published, from 1859).

'Mineral Statistics' have been published annually from 1853 to 1882; but in 1883 the Mining Record Office, in which these were prepared, was removed to the Home Office, and the statistics will in future be issued as parts of the Reports of the Inspectors of Mines.

No official general map has been issued by the Survey, but the following maps, on scales varying from seven to eleven and a half miles to the inch, have been published by the directors of the respective surveys; they are reductions of survey work to date; British Islands, by A. C. Ramsay, 1878; England and Wales, by A. C. Ramsay, 4th ed. 1879; Ireland, by J. B. Jukes, 1867; Ireland, by E. Hull, 1878; Scotland, by A. Geikie, 1876.

---

## REVIEWS.

---

I.—THE STUDENT'S HANDBOOK OF PHYSICAL GEOLOGY. By A. J. JUKES-BROWNE, B.A., F.G.S. pp. 514. (London: George Bell & Sons, 1884.) Price 6s.

THE present volume, dealing with dynamical, structural, and physiographical geology, is intended to occupy an intermediate place between the elementary manuals of geology and the elaborate treatises of Dr. A. Geikie and Prof. A. H. Green. The subjects of palæontological and historical geology are left to form another volume, after the plan adopted by Prof. Green; let us hope, however, that the author will not wait for that perfection which never comes, but complete his work without allowing a very long interval to elapse.

The work before us bears evidence of great care and extensive research, while the definitions are clear and amply illustrated by diagrams and references to phenomena exhibited in various parts of the world. Seeking inspiration, with due acknowledgment, from the works of De la Beche, Lyell, Jukes, Ramsay, and A. Geikie, and making good use of his own experience, the author has produced an excellent introduction to the principles of geology, combined with an account of rocks and rock-structure, and of the methods by which the surface-features of the land have been sculptured.

---

ON A SIRENIAN FROM THE PARIS BASIN. By Prof. A. GAUDRY.

II.—SUR UN SIRÉNIEN D'ESPÈCE NOUVELLE TROUVÉ DANS LE BASSIN DE PARIS. Par ALBERT GAUDRY. Bull. de la Soc. Géol. de France, 3<sup>e</sup> s. t. xii. p. 372, pl. xvii.

IN the cuttings for a new line of railway on the outskirts of Paris, which laid bare the shelly marls forming the base of the Fontainebleau sands, there were discovered in one spot, confusedly intermingled together, 14 ribs of a species of *Halitherium*, which, on account of their larger proportions and greater relative thickness, the author regards as distinct from the ordinary species of the Paris basin, *H. Schinzi*, Kaup.; and he has therefore proposed a new name for it, *Halitherium Chouqueti*. The exterior contour of one of the ribs measures only .52 m., and yet it has an average circumference of .20 m. and a thickness of .059 m. Fragments of ribs, of apparently the same species, from deposits of the same age at Belleville, have been for many years in the Museum at Paris; and similarly massive ribs are also known from the Lower Miocene of Cenon (Gironde). The author further states that the ribs of *Rhytina* and of *Rhytiodus* are much more elongated and proportionally thinner and more delicate than those of *H. Chouqueti*. G. J. H.

NOTES ON THE ERRATIC STONES OF OVERYSSEL. By K. MARTIN, Professor of Mineralogy, etc., at Leiden.

III.—AANTEEKENINGEN OVER ERRATISCHE GESTEENTEN VAN OVER-IJSSEL, door K. MARTIN, Hoogleraar in de Mineralogie, etc., te Leiden. (Zwolle, 1883.)

IN the museum of the small town of Zwolle, on the eastern side of the Zuider Zee, a collection has been formed of the various erratic rock fragments found in the Province of Overijssel, and Dr. Martin, in this paper, briefly calls attention to the unusual variety of the fragments, and the widely separated districts from which they have been transported by ice and mingled together in the drift deposits of this district. The list comprises Granite and Gneiss, probably from Sweden; Limestone with characteristic Silurian fossils from Gotland and the Russian Baltic provinces; Devonian Spirifer Sandstone (very abundant) from the Rhine district near Coblenz; Carboniferous Limestone from Belgium, in the vicinity of Aix-la-Chapelle; a specimen of *Goniatites sphaericus*, probably from the valley of the Ruhr; Trias with *Ceratites nodosus* from North-West Germany; Lias, also probably from North-West Germany; Dogger and Malm from the Rhine districts; Flints with Chalk fossils from North Germany and near Aix-la-Chapelle; Tertiary fossil wood from Upper Cassel, near Bonn; Miocene sharks' teeth from Belgium and the Netherlands; and lastly Agates and pieces of Chalcedony from the Rhine district.

These erratics clearly show that they have been partly derived from the north-east, embracing the districts bordering the Baltic; partly from the south, in the Rhine valley and its tributaries; and partly from native rocks which underlie the present surface of Overijssel and the adjoining provinces. G. J. H.

IV.—FIRST REPORT OF PROGRESS IN THE ANTHRACITE COAL REGION. THE GEOLOGY OF THE PANTHER CREEK BASIN, OR EASTERN END OF THE SOUTHERN FIELD. By CHAS. A. ASHBURNER. With an Atlas of 13 sheets of Maps and Sections, 6 page Plates, and 2 folded Plates. 8vo. pp. 407. (Harrisburg, 1883.)

THE above volume contains the results of the investigations carried out by the officers of the Second Geological Survey of Pennsylvania in a small corner of the Anthracite coal region of that state. The greater portion of the book consists of details of various sections of the strata and coal-seams, the character of the coals in the different beds and the estimated yield, and consequently it is more of local than general interest.

The beautifully elaborate plans and sections accompanying the report clearly show the extreme complexity of the strata in this region. As Dr. Lesley, the State Geologist, remarks, "The most striking feature of the plication of the coal-beds of this basin is its sharpness, the rarity of those soft and gentle curvatures which characterize the bituminous coal-basins, a rigid plainness of the up and down slopes, suggestive of a severe lateral compression in the jaws of a vice, and a humid plasticity of the Coal-measures at the time of compression." These great disturbances make it a very difficult task to identify the seams of coal in adjoining areas, as it is found that even in the same colliery the thickness of the coal beds and the rock intervals between them change considerably within very short distances. Thus in one colliery in the Lehigh district, the thickness of coal in what has been appropriately designated the "Mammoth" bed varies from  $42\frac{1}{2}$  to 106 feet. It is stated that in this area it is not generally considered profitable to work an anthracite coal bed which is under four or five feet thick.

It appears that the total product of the anthracite coal-fields of Pennsylvania up to January, 1883, has been over 509 millions of tons. This coal first began to be used in 1820, when the modest quantity of 365 tons was mined; in 1882 the output amounted to over 31 millions of tons.

The important scientific and economical facts brought forward in this report should be sufficient to insure the continued support of the State Government to enable the survey to be carried out in a similarly detailed manner throughout the rest of these important coal-fields.

G. J. H.

---

THE PLIOCENE AND QUATERNARY RUMINANTS OF THE AUVERGNE.  
By M. CHARLES DESPÉRET.

V.—NOUVELLES ÉTUDES SUR LES RUMINANTS PLIOCÈNES ET QUATERNAIRES D'Auvergne. Par M. CHARLES DESPÉRET. Bull. de la Soc. Géol. de France, 3<sup>e</sup> s. t. xii. p. 247, pl. v. à viii.

IN this paper the author gives detailed descriptions and figures of the fossil remains—consisting chiefly of horns and fragments of jaws—of Ruminants which have been discovered in the valleys of the Allier and Haute-Loire in the district of Auvergne, Central France.

The descriptions are mainly based upon collections made by the late Abbé Croizet and Prof. Bravard, which are now in the Paris Museum. Partial descriptions of these fossils have already been given by previous authors; but as these have in most cases been of a very summary character, and not infrequently unaccompanied by figures, the author has done good service to science in fully treating the subject.

The remains have been discovered in strata referred to three epochs, viz. the Middle Pliocene, Upper Pliocene, and Quaternary. From the oldest deposits, mostly derived from the 'Montagne de Perrier,' the author describes two species of the Antelope family, one, *Gazella borbonica*, a small form allied to the diminutive Antelopes from the Upper Miocene deposits of Pikermi, the other, *Antilope ardea*, a larger animal, recalling by its dentition the *Tragoceras* of Pikermi. The occurrence of a species of Gazelle in these Auvergne deposits is of special interest from the fact that an apparently closely allied species has been lately described by Mr. E. T. Newton<sup>1</sup> from the Norwich Crag, which is regarded by Despéret as synchronous with the beds at Perrier. In addition to the Antelopes, the author enumerates 10 well-defined species of *Cervus* from the Middle Pliocene. This is a great reduction from the 24 species which previous authors had described from the same deposits, many of which are regarded as mere synonyms, based on differences of age. The family of the Bovidæ is represented by the single species *Bos elatus*, Pomel.

In the Upper Pliocene there have been discovered a single species of Antelope and 3 species of *Cervus*, and from the Quaternary, remains of the Reindeer (*C. tarandus*), Red Deer (*C. elaphus*), and the Aurochs (*Bison priscus*).  
G. J. H.

---

VI.—THE CANADIAN RECORD OF NATURAL HISTORY AND GEOLOGY, WITH PROCEEDINGS OF THE NATURAL HISTORY SOCIETY OF MONTREAL. Vol. I. No. 1. (Montreal, 1884.)

THE above is the title of a new quarterly magazine, which, under the editorship of Mr. J. T. Donald, is intended to replace the "Canadian Naturalist," for many years the organ of the small but active Natural History Society of Montreal.

The main article in the present number is by Sir J. W. Dawson, "On Rhizocarps in the Palæozoic Period." The author refers first to the minute fossils described by him some time since under the name of *Sporangites Huronensis* as probably spore-cases of macrospores of some acrogenous plant. They appear under the microscope as yellow flattened disc-like bodies, about .25 mm. in diameter, slightly papillate externally, and showing but little structure except that the walls can be distinguished from the internal cavity. These bodies occur in immense numbers in beds of dark bituminous shale, of Devonian age, at Kettle Point, Lake Huron. They are also present in beds of the same age in New York State, Ohio, and Indiana, and occur at the slightly lower horizon of the Hamilton Shales and

<sup>1</sup> Q. J. G. S. vol. xl. p. 280, pl. xiv.

Corniferous groups in Western New York. The writer has also found a thin bed, nearly entirely composed of these spores, in Shales of the Hamilton Group, at Arkona, Ontario. The only plant-remains associated with the spores are fragments of *Calamites*, *Lepidodendron* and *Ptilophyton Vanuxemi*, but the presence of *Lingula*, *Leiorhynchus*, *Ganoid scales*, etc., shows that the deposits are marine. Hitherto no satisfactory evidence of the affinities of *Sporangites* had been discovered, but Sir W. Dawson believes that a definite clue has been found in certain fossils lately discovered in shales of Devonian age exposed on the banks of the Curua river and other tributaries of the Amazon. These beds contain *Sporophyton* and minute rounded *Sporangites*, which are "inclosed in considerable numbers, in spherical and oval sacs, the walls of which are composed of a tissue of hexagonal cells, and which resemble in every respect the involucre or spore-cases of the little group of modern acrogens, living in shallow water, known as Rhizocarps." The resemblance is so close to the sporocarps of *Salvinia* that the author suggests the name of *Protosalvinia* for the plant producing them, when it shall be discovered. In the meantime these sporocarps are ranged under *Sporangites*, as *S. Braziliensis* and *S. bilobatus*. The similarity of the macrospores inclosed in the sporocarps to *Sporangites Huronensis* is so striking in every respect that the author believes that these latter were originally inclosed in similar sacs, which have since perished.

Sir J. W. Dawson also suspects that the Old Red Sandstone fossils, known under the name of *Parka* and supposed to be the ova of Crustaceans, may prove to be the fructification of Rhizocarps. It is also suggested that such plants as *Psilophyton glabrum* and *Cordaites angustifolia*, of which the fructification is unknown, may have been allied to Rhizocarps.

G. J. H.

## VII.—ON THE CRYSTALS OF OLIVINE IN THE SANDS OF THE ISLE OF BOURBON.

NOTE SUR LES CRISTAUX D'OLIVINE DES SABLES DE PROJECTION DE LA PLAINE DES SABLES (ILE BOURBON.) PAR M. ALF. LACROIX. Bull. d. l. Soc. Min. de France, Mai, 1884, tome vii. p. 172.

THE note contains a description of the crystals of olivine which form a large portion of a bed of sand, more than one metre in thickness, occurring on the Plaine des Sables of the Ile de Bourbon. The crystals are from 2 to 4 mm. in length, and of unusually perfect forms. They are associated with augite crystals, from 1 to 5 mm. in length. The crystallographic forms observed in the olivine were:  $m$  (110),  $h^1$  (010),  $g^1$  (100),  $g^3$  (210),  $a^1$  (011),  $e^2$  (201),  $e^1$  (101). Its composition as determined by M. Velain was  $SiO_2$  39.96,  $Al_2O_3$  2.33,  $FeO$  6.28,  $CaO$  2.05,  $MgO$  49.18—total, 99.80. The observation is one of considerable interest as bearing on the origin of certain serpentines. It shows at any rate the possibility of the occurrence of bedded olivine rocks.

REPORTS AND PROCEEDINGS.

---

ABSTRACTS OF PAPERS READ BEFORE THE GEOLOGICAL SECTION OF  
THE BRITISH ASSOCIATION AT MONTREAL, AUGUST, 1884.

1.—PENNSYLVANIA BEFORE AND AFTER THE ELEVATION OF THE  
APPALACHIAN MOUNTAINS.

By Prof. E. W. CLAYPOLE, B.A., B.Sc., F.G.S. Lond.

THE paper, of which the following notes are an abstract, is intended as an attempt to handle, in a necessarily imperfect manner, and only to first approximations, a difficult but important and interesting geological subject. The method of treatment is, in the writer's opinion, one that has not hitherto been employed for the same purpose.

The object in view is to form some estimate, as near to the truth as possible, of the amount of compression or shortening produced at the surface by the corrugation of the upper layers of the coast into mountain chains, with especial reference to the American Atlantic seaboard.

In order to confine the paper within due limits, certain propositions must be taken as proved. The principal of these are :

1. That central contraction has developed tangential pressure in the crust.
2. That the tangential pressure has produced crumpling of the crust.
3. That to this crumpling are due long ranges of mountains.
4. That the Appalachian Mountains came into being in this manner in the later portion of the Palæozoic era.

These admitted, the conclusion necessarily follows that during the formation of the Appalachian Mountains a considerable contraction of the crumpled area ensued, in a direction at right angles to that of the chain.

The following points constitute the main features of the paper :

1. Short account of the great ranges of Pennsylvania, in plan and section, with diagrams.
2. Situation and account of the line of section adopted.
3. Limitation of the field to a consideration of eleven great ranges—

Blue Mountains	Blue Ridge Mountains
Bower Mountains	Jack's Mountain
Conecocheague Mountains	Standing Stone Mountains
Tuscarora Mountains	Tussey Mountains
W. Shade Mountains	Bald Eagle Mountains
Black Log Mountains	

4. Discussion of the different parts of this section—

- (a) The Mountain Region.
- (b) The Cumberland Valley.

5. Attempt to estimate or measure the curved line of the crumpled Upper Silurian (Medina) sandstone.
6. Inference that the sixty-five miles of the line of section

represents about 100 miles of surface previously to the crumpling of the crust and elevation of the mountains.

7. This result, for several reasons, below rather than above the truth.
8. Geographical effects of this contraction.
9. Development of the fact that such elevation of mountains by tangential pressure involves not only elevation, but considerable horizontal movement.
10. Diminution of motion to north-west.
11. A few words on the failure of attempts yet made to account for this contraction.
12. Suggestions and conclusions.

---

## 2.—A COMPARISON OF THE DISTINCTIVE FEATURES OF NOVA-SCOTIAN COAL-FIELDS.

By EDWIN GILPIN, Jun., A.M., F.G.S., F.R.S.C.;

Government Inspector of Mines, Province of Nova Scotia.

**T**HE Carboniferous rocks of Nova Scotia cover a large part of the northern side of the province, and are exposed in unusually good sections. The presence of workable Coal-seams has led to many surveys, etc., which have resulted in a good knowledge of their structure. The best known and most continuous sections are those of the Joggins in Cumberland county, and of the Cape Breton Coal-fields. There are numerous Coal-fields, the most important being those of Cumberland, Pictou, and Cape Breton.

The presence of east and west synclinal folds is noticeable in each of these districts. In the Sydney Coal-field these foldings are on the prolongation of the ranges of the Pre-Carboniferous rocks, and die out as they recede from them. In all these Coal-fields these flexures are not accompanied by serious faults, except where the older measures have interrupted or complicated them. Thus on the north side of the Cumberland Coal-field the measures are comparatively free from disturbances where no Pre-Carboniferous strata appear, while numerous dislocations are found on the south side, where they rest almost directly on the Silurian slates of the Cobequid mountains.

In the Sydney Coal-field the sections show the ancient centre of the Coal-field where the maximum of coal and the minimum of strata occur, from which it would appear that the distributing currents carried material principally from the north and the south; the source of part of the detritus being the bordering Lower Carboniferous strata. The slight difference of deposition, however, is marked by the presence of beds of bituminous and fossiliferous limestone, which, chiefly developed in the centre, extend almost from end to end of the district.

In the Pictou district a noticeable point is a horizon in the lower part of the section containing 1500 feet of shale, and coal in beds up to 38 feet in thickness. This curious formation is referred to the presence of a contemporaneous barrier-reef of shingle formed from the Millstone Grit, and allowing under its shelter an immense accumulation of argillaceous and carbonaceous sediment. In the

Cumberland Coal-field a long-continued alternation of the shale and sandstone allowed the formation of sixty-seven Coal-beds, only two of which in the "Joggins Section" are of workable size.

It is noticeable that in the Pictou and Cumberland Coal-fields the most productive horizon is at the base of the Coal-measures, and, comparatively speaking, of limited thickness. Thus at Pictou, the lower 1300 feet hold fifteen beds, yielding 119 feet of coal. At Springhill, in the Cumberland district, the lower 1000 feet of the Coal-measures hold twelve beds, containing 51 feet of coal. The overlying measures are more arenaceous, and hold a much smaller proportion of coal in both districts. In Cape Breton Coal-field there are now exposed only 1300 feet of productive measures immediately overlying the Millstone Grit, and holding the workable seams.

The question naturally arises if it might not be considered that at one time the Cape Breton Coal-field may not have had a total thickness of strata equalling that recorded in Pictou and Cumberland, and that possibly the upper section was similar in development.

The coals from these districts present several points of difference. Thus the slightly higher ash contents of the Pictou and Cumberland coals may be connected with the predominance of the including beds of Shale as compared with the more arenaceous measures of Cape Breton, and a low ash percentage in the coals.

Other differences between the districts may be referred to conditions of deposition, foldings, drainage, etc.

As yet the study of the fossils of the three districts does not show any points of difference calling for remark, but this subject has not yet received a share of attention equal to that bestowed on the points of economic interest.

The above and other differences between the districts are perhaps more justly considered due to local differences of the deposition extending over large areas than as marking distinctions between individual and isolated Coal-fields.

---

### 3.—THE VALUE OF DETAILED GEOLOGICAL MAPS IN RELATION TO WATER-SUPPLY AND OTHER PRACTICAL QUESTIONS.

By W. WHITAKER, B.A., F.G.S., of the Geological Survey of England.

**T**HOSE maps of the Geological Survey of England in which various divisions of the Drift have been coloured tell us, as a rule, a very different tale from the corresponding sheets in which the Drift is ignored, and it is only these Drift maps that really give us a true idea of the nature of the surface. Indeed in many districts a geological map that does not show the Drift is comparatively useless for most practical purposes, at all events in a populous country like England. Moreover, it is not enough merely to mass Drift as such, but its constituent members should be fairly distinguished, not merely with regard to their classification or relative age, but also as to their composition, whether of clay, loam, or gravel and sand. To illustrate this there are exhibited copies of the two versions of many of the Geological Survey Maps of the London Basin, with and with-



out Drift, from which the following important points will be at once seen:—

1. Large tracts, shown as Chalk on one version, really consist, at the surface, of the generally impervious Boulder-clay, whilst over others the Chalk is covered by Brickearth and Clay-with-flints; all these beds being such as give an aspect to the country very different from what we find where the Chalk is bare.

2. Parts of the wide-spreading area of the London Clay (of the Driftless maps) are really quite altered and deprived of their clayey character, by the sheets, long strips, and more isolated patches of gravel and sand that occur so often, whether along the river-valleys or over the higher plains.

3. The sandy permeable Craggs are in great part hidden by Drift, which, though often consisting of sand and gravel, is sometimes of Boulder-clay. Indeed, so widespread is the Glacial Drift in the greater part of Norfolk and Suffolk that only a Drift edition of the Geological Survey Maps of the eastern parts of those counties has been issued; a map without Drift would necessarily be a work of fiction.

To illustrate the important bearing which these Drift maps have on a great question, that of water-supply from the Chalk, the author also exhibits some special maps, which he has made to show the areas over which rain-water has access to the Chalk, as distinguished from those over which the surface-water cannot sink down into the Chalk, or can only do so very partially. These maps will be more particularly noticed in Section G.

---

#### 4.—ON THE MORE ANCIENT LAND FLORAS OF THE OLD AND NEW WORLDS.

By Sir WILLIAM DAWSON, K.C.M.G., LL.D., F.R.S.

IN the Laurentian period vegetable life is probably indicated, on both sides of the Atlantic, by the deposits of graphite found in certain horizons. There is good evidence of the existence of land at the time when these graphitic beds were deposited, but no direct evidence as yet of land plants. The carbon of these beds might have been wholly from sub-aquatic vegetation; but there is no certainty that it may not have been in part of terrestrial origin, and there are perhaps some chemical arguments in favour of this. The solution of the question depends on the possible discovery of unaltered Laurentian sediments.

The Silurian land flora, so far as known, is meagre. The fact that *Eopteris* has been found to be merely a film of pyrite deprives us of the ferns. There remain some verticillately-leaved plants allied to *Annularia*, the humble Acrogens of the genus *Psilophyton*, and the somewhat enigmatical plants of the genera *Pachytheca*, *Prototaxites*, and *Berwynia*, with some uncertain Lycopods. We have thus at least forerunners of the families of the *Asterophyllitææ*, the *Lycopodiaceæ*, and the *Coniferææ*.

The comparison of the rich Devonian or Erian flora of the two

sides of the Atlantic is very interesting. On both continents it presents three phases, those of the Lower, Middle, and Upper Erian, and there is a remarkable correspondence of these in countries so wide apart as Scotland, Belgium, Canada, Brazil, and Australia. Examples of this were given in the Rhizocarps, at this period very important, in the Lycopods, the Equisetaceæ, the Ferns, and the Conifers. The number of coniferous trees belonging to *Dadoxylon* and allied genera, and the abundance of ferns, often arborescent, were especial features of the Middle and Later Erian.

The flora of the Erian age culminated and then diminished. In like manner that of the succeeding Carboniferous period had a small commencement quite distinct in its species from the Erian; it culminated in the rich vegetation of the true coal formation, which was remarkably similar over the whole world, presenting, however, some curious local differences and dividing lines which are beginning to become more manifest as discovery proceeds. In the Upper Carboniferous the flora diminishes in richness, and the Permian age is, so far as known, one of decadence rather than of new forms. Great progress has recently been made by Williamson and others in unravelling the affinities of the coal-formation plants, and we are on the eve of great discoveries in this field.

Throughout the Silurian, the conditions do not seem to have been eminently favourable to plants, but the few forms known indicate two types of Acrogens, and one leading to the Gymnosperms, and there is no reason to doubt the existence of insular land richly clothed at least with the few forms of vegetation known to have existed.

In the Erian and Carboniferous there seem to have been two great waves of plant-life, proceeding over the continents from the north, and separated by an interval of comparative sterility. But no very material advance was made in them, so that the flora of the whole Palæozoic period presents a great unity and even monotony of forms, and is very distinct from that of succeeding times. Still the leading families of the *Rhizocarpeæ*, *Equisetaceæ*, *Lycopodiaceæ*, *Filices*, and *Coniferæ*, established in Palæozoic times, still remain; and the changes which have occurred consist mainly in the degradation of the three first-named families, and in the introduction of new types of Gymnosperms and Phænogams. These changes, delayed and scarcely perceptible in the Permian and early Mesozoic, seem to have been greatly accelerated in the later Mesozoic.

##### 5.—THE GEOLOGICAL AGE OF THE ACADIAN FAUNA.

By G. F. MATTHEW, A.M., F.R.C.S.

**I**N this sketch an attempt is made, by comparison with the Cambrian fauna of other countries, and especially of Wales, to fix more exactly than has hitherto been done the position of the assemblage of organisms found near the base of the Saint John group. The Trilobites are taken as a criterion for this purpose. A brief statement of the position and thickness of the beds is given, showing the relation of the fauna to the formation as a whole.

It is shown that the genera and species of the Acadian Trilobites do not agree with those of the Menevian, in the restricted application of that term now in vogue; the great *Paradoxides*, with short eyelobes, and the genera *Anopolenus*, *Agraulos* (= *Arionellus*), *Erinmys*, and *Holocephalina* being, so far as known, absent from it. On the other hand, it shows very close relationships in its genera to the Solva group fauna, especially in the following species:

SOLVA GROUP.	ACADIAN FAUNA.
<i>Conocoryphe solvensis</i> (Hicks).	<i>Ctenocephalus Matthewi</i> (Hartt sp.).
<i>Conocoryphe bufo</i> (Hicks).	<i>Conocoryphe elegans</i> (Hartt sp.).
<i>Paradoxides Harknessi</i> (Hicks).	<i>Paradoxides cteminiacus</i> (Matthew).

As bearing on the question of the age of the Acadian fauna, the development of the eyelobe in *Paradoxides* is referred to, and it is shown that while in the Cambrian rocks of Wales the length of the eyelobe is in direct relation to age of the strata, the *Paradoxides* of the Acadian fauna, having continuous or nearly continuous eyelobes, are more primitive in their facies than those of the Menevian, and agree with the species found in the Solva group.

The family of Conocoryphidæ, restricting the name to such species as those described by Corda under *Conocoryphe* and *Ctenocephalus*, are a marked feature of this early fauna; and *Conocoryphe* has a characteristic suture not observed in the Menevian genera. The Acadian *Ctenocephalus* also differs in this respect from the Bohemian species.

#### 6.—THE PRIMITIVE CONOCORYPHEAN.

By G. F. MATTHEW, A.M., F.R.S.C.

**R**ELATES to the development of the species *Ctenocephalus Matthewi* and other Conocorypheans of the Acadian fauna, and is considered under the three heads, viz. the Development of the Glabella; the Acquisition of Sensory Organs; and the Decoration of the Test.

Under the first head, it is shown that the peculiar glabella of the species above referred to is closely related to the early history of the Trilobite. The glabella, in its earliest stage, is very different from that of the adult, and in outline is not unlike that of *Paradoxides*: it also resembles this species in the position of the ocular fillet. At the next stage the glabella or axial lobe becomes trumpet-shaped, as in *Carauisa*, and in the third the glabella proper is developed by the segmentation of the axial lobe: the glabella and ocular fillets now resemble those of *Ptychoparia*. In the following stages the family characters of the Conocorypheans begin to assert themselves, especially the widening of the base of the glabella, the appearance of the canals connected with the ocular ridges, and the development of spines.

2.—*The Acquirement of Organs of Sense.*—The ocular fillet appears, in the second stage of growth, as a faint, narrow ridge, close to the anterior marginal fold, and extending but a short distance from the glabella. It is not until the fifth stage of growth that the ramifying branches which spread from the ocular ridge to the anterior margin make their appearance. The ocular lobe and sensory apparatus

connected with it are more distinctly visible on the under than on the outer surface of the test, and the canalets connected with the lobe spread over the anterior slopes of the shield and extend to the anterior margin. In the tuberculated species they connect by hollow spines with the outer surface. In one species they cover a wider space than in the others, extending some distance behind the ocular ridges and over the front of the glabella.

3. *Decoration of the Test.*—In all the Acadian species of this group but one, the surface of the test at maturity is covered with tubercles and spines similar to the surface-markings of *Conocoryphe Sulgeri*, etc. In the earliest stages, however, no such tubercles are found, but the surface appears smooth or scabrous. In *Ctenocephalus Matthewi* the surface, in the first three stages of growth, appears smooth; in the fourth, tubercles begin to appear, and about the fifth stage all projecting parts of the test are studded with them. Those on the glabella and frontal lobe are arranged in transverse rows; those on the cheeks in interrupted rows conforming more or less to the periphery of these protuberances. Towards the adult stage these tubercles and spines become more irregular in position and number, conforming in this respect to the law of development in the Ammonites, expounded by Professor Alpheus Hyatt.

#### 7.—ON FLUXION-STRUCTURE IN TILL.

By HUGH MILLER, A.R.S.M., F.G.S., Geological Survey of England and Wales.

IT has long been recognized as one of the characteristics of the Till that its long-shaped boulders are striated lengthwise. They have, as it has been concisely expressed, been “launched forward end-on.” From the minute and magnifiable striæ upon the smaller (*e.g.* almond-sized) boulders it also appears that these at least have been carried forward, involved in the matrix, and were glaciated chiefly by its particles. Under the microscope these particles exhibit most of the varieties of form and glaciation that are found among larger boulders. The structure of the Till in open situations shows that the axes of its stones have been turned by a common force in the direction of glaciation; it exhibits a rough structure comparable to the fluxion-structure of igneous rocks, the smaller boulders dividing around and apparently drifting past the larger, like the tide round an anchored skiff. These structures, which have been found by the author over many hundreds of square miles, chiefly in the North of England, indicate that at least a surface-layer of the Till was dragged along, with a shearing movement of particle upon particle, producing intimate glaciation within its mass. Proofs are adduced that this moving layer was in general a surface-layer only, and that the Till did not, as has often been supposed, move forward *en masse*, licking up its additions from beneath. This is the only intelligible explanation of the order (as well as the structure) of the Boulder-clays of which the author has any practical knowledge. In up-lying situations, where the drift consists of raw material, fluxion-structures are seldom detected. In sheltered spots they are not generally developed. They are characteristic of well-kneaded

Till in open situations, liable, however, to obscuration by contortions within the mass. Of twelve experimental attempts made near the watershed of England in East Cumberland, 600–900 feet above the sea, to determine the ice-movement from this structure alone, eight were correct, three indeterminate, and only one misleading. The pressure and movement capable of producing this widespread fluxion-structure seem to have been that of some mass vast and far-spreading—closely investing, slow-moving, and heavily dragging—such as glacier-ice. It needs only to be assumed that the confluent glaciers communicated something of their own movement and structure to the ground-moraine below.

---

8.—ON THE SOUTHWARD ENDING OF A GREAT SYNCLINAL IN THE TACONIC RANGE.

By JAMES D. DANA, LL.D.

THE Taconic Range, which gave the term “Taconic” to geology, lies in Western New England, between Middlebury, in Vermont, on the north, and Salisbury, in Connecticut, on the south. In former papers, published in the “American Journal of Science,” the author has shown, first, that the rocks constituting the range vary as we go from north to south, from roofing-slate and hydromica (or sericite) schist to true chloritic and garnétiferous mica-schists; secondly, that these schists lie mostly in a synclinal or compound synclinal; thirdly, that the crystalline limestone along the eastern foot is one with that along the western, the limestone passing under the schist as a lower member of the synclinal; and, fourthly, that since the limestone contains in Vermont (according to the discoveries of the Vermont Geological Survey, and also of Mr. A. Wing), and in the State of New York, fossils of the Lower Silurian, ranging from the inferior divisions to the higher, the Taconic schists are probably of the age of the Hudson River group or Llandeilo flags.

The author’s papers further show that while a large part of the Taconic Range has an eastward dip on both the east and west sides, a southern portion about twelve miles long, consisting of Mount Washington in South-western Massachusetts, and its continuation into Salisbury, Connecticut, is a broad tray-shaped synclinal, the dips of the two sides being toward one another, like the sides of an ordinary trough. The width of the broad synclinal between the limestone belt on either side is about five miles.

As the result of investigation during the last two years, the synclinal character of this Mount Washington part of the Taconic Range is illustrated in the paper by new sections, and by facts connected with the dying out of the great synclinal (or compound synclinal) in the town of Salisbury.

The mean height of Mount Washington above the sea-level is about 2000 feet, and above the wide limestone region on either side and to the south, about 1250 feet. The synclinal virtually ends along an east and west line through the village of Lakeville, in the town of Salisbury, where a beautiful lake lies within the limestone

area. The surface of the mountain region descends 1000 feet in the southern, or last, three miles; and in the latitude of Lakeville the width, as the map presented shows, diminishes abruptly from five miles to a narrow neck of six-tenths of a mile. The area south is of limestone, and the neck of schists referred to is hardly 150 feet in height above it.

The limestone may in some places be seen emerging from beneath the schist at a small angle; and at one locality a low oven-shaped anticlinal of limestone has the schist covering all but a narrow portion at the top; the quarrymen had to remove the schist to work at the limestone. Several narrow strips or belts of limestone, S. 15° W. in direction, corresponding with the direction of this part of the range, show out through the sides of the mountain where local anticlinals have had their tops worn off. Further, the dip of the schist over much of the southern slope is southerly, and at a small angle, but with many local anticlinals and synclinals. In addition, there are small areas of schist *in the limestone* region, like straggling portions of the dwindled mountain, which appear in general to be remains of local flexures.

There is the plainest evidence that the limestone formation of southern and south-eastern Salisbury comes out from beneath the dwindled, flattened-out, and worn-off mountain synclinal. And the reason why this limestone is exposed to view over plains miles in width, east and west of the Taconic Mountain, as well as to the south, is simply this, that the once overlying schist has been removed because in badly broken anticlinals and synclinals.

The paper closes with an allusion to the orographic, stratigraphical, and lithological interest of the facts, and to their important bearing on the question of the origin and chronology of certain kinds of crystalline rocks, such as chloritic, garnetiferous, and staurolitic mica-schists, as well as others less coarsely crystalline.

#### 9.—GLEANINGS FROM OUTCROPS OF SILURIAN STRATA IN RED RIVER VALLEY, MANITOBA.

By J. HOYES PANTON, M.A., Principal of the Collegiate Department, Winnipeg.

THE country north of Winnipeg is apparently a very level prairie, but there are several places where Silurian beds crop out—sometimes from beneath the drift on the banks of the Red River and Cook's Creek; sometimes as rocks projecting above the prairie-level. The beds exposed are Limestones, which are worked for ornamental and other purposes.

There are four localities on the river banks, sixteen to twenty-one miles north-east of Winnipeg, which the author groups together as yielding much the same fauna; these are between St. Andrews (North) and East Selkirk. The fossils found here are *Palæophycus*, numerous Corals, and Cephalopods, some Brachiopods and Trilobites.

The localities north and north-west of Winnipeg give a rather different fauna. Stony Mountain rises in a horseshoe shape, about sixty feet above the prairie on the north and north-west sides, sloping

gradually down to the prairie-level on the east. There is here also some drift, beneath which are very distinct glacial striæ running north-north-west. Brachiopoda are very numerous here. At Stonewall the glacial striæ are also very distinct, running in the same direction.

The author gives lists of fossils from the different localities. In many cases only the genera are as yet determined. The species will be numerous. The following table gives the chief characteristics :—

	Selkirk, etc.	Stony Mountain.		Stonewall.
		Lower beds.	Upper beds.	
Condition	Rather soft	Soft	Very hard	Hard and flinty
Action with cold acid	Much effervescence	Effervescence	None or slight	Slight effervescence
Colour	Mottled, dark, and light grey	Reddish grey	Light grey and ochreous	Very white
Fossils	Numerous	Many	Few	Several
Type	Corals and Cephalopods	Brachiopods	Corals	Corals

The relative positions of these, and their equivalents, appear to be as follows, in descending order :—

Stonewall.		Niagara limestone.
Stony Mountain.	{ Upper beds.	?
	{ Lower beds.	Hudson River.
Selkirk, etc.		Trenton.

10.—TENTH REPORT OF THE UNDERGROUND WATERS COMMITTEE,<sup>1</sup>  
DRAWN UP BY C. E. DE RANCE.

THE Chairman and Secretary of your Committee are both unavoidably obliged to be absent at the Montreal meeting, which is a source of regret to themselves; the more so that, this being the case, it has been thought advisable to delay presenting their final Report on the Circulation of Underground Waters in South Britain until next year, when the Committee will have been twelve years in existence. During these years particulars have been collected of the sections passed through by a very large number of wells and borings; a daily record has been obtained of the height at which water stands in many of these wells; investigations have been carried out as to the quantity of water held by a cubic foot of various rocks, by Mr. Wethered; and as to the filtering power of sandstones, and the influence of barometric pressure and lunar changes on the height of underground waters, by Mr. I. Roberts. During the present year the attention of the Committee has been directed to the remarkable influence of the earthquake which visited

<sup>1</sup> Consisting of Professor E. Hull, the Rev. H. W. Crosskey, and Messrs. James Glaisher, H. Marten, E. B. Marten, G. H. Morton, W. Pengelly, James Plant, I. Roberts, Thos. S. Stooke, G. J. Symons, W. Topley, E. Wethered, W. Whitaker, and C. E. De Rance (Secretary and Reporter), appointed for the purpose of investigating the Circulation of Underground Waters in the Permeable Formations of England and Wales, and the Quantity and Character of the Water supplied to various towns and districts from those formations.

the east and east-central counties of England, in March last, in raising the levels of the water in the wells of Colchester and elsewhere.

More detailed information is still required as to the proportion of actual rainfall absorbed by various soils, over extended periods representing typical dry and wet years. Information on these heads and on other points of general interest bearing on the percolation of underground waters, referring to observations made in Canada or the United States, would be gladly welcomed by the Committee, and would be incorporated in their eleventh and final report to be presented next year.

Your Committee seek reappointment, but do not require a grant, as they have forms of inquiry on hand, and did not require to expend the whole of the grant of last year, a portion of which only has been drawn.

#### APPENDIX—COPY OF QUESTIONS.

1. *Position* of well or shafts with which you are acquainted? 1a. State *date* at which the well or shaft was originally sunk. Has it been deepened since by sinking or boring? and when? 2. Approximate *height* of the surface of the ground above Ordnance Datum (mean sea-level)? 3. *Depth* from the surface to bottom of shaft or well, with diameter. *Depth* from surface to bottom of bore-hole, with diameter? 3a. *Depth* from the surface to the horizontal drift-ways, if any? What is their length and number? 4. *Height* below the surface at which water stands *before* and *after* pumping. Number of hours elapsing before ordinary level is restored after pumping? 4a. *Height* below the surface at which the water stood when the well was first sunk, and height at which it stands now when not pumped? 5. *Quantity* capable of being pumped in gallons per day of twenty-four hours? Average quantity daily pumped? 6. Does the *water-level* vary at different seasons of the year, and to what extent? Has it diminished during the last ten years? 7. Is the ordinary *water-level* ever affected by local rains, and, if so, in how short a time? And how does it stand in regard to the level of the water in the neighbouring streams, or sea? 8. *Analysis* of the water, if any. Does the water possess any marked *peculiarity*? 9. *Section*, with nature of the rock passed through, including cover of Drift, if any, with *thickness*? 9a. In which of the above rocks were springs of water intercepted? 10. Does the cover of Drift over the rock contain *surface springs*? 11. If so, are these *land springs* kept entirely out of the well? 12. Are any large *faults* known to exist close to the well? 13. Were any *brine springs* passed through in making the well? 14. Are there any *salt springs* in the neighbourhood? 15. Have any wells or borings been discontinued in your neighbourhood in consequence of the water being more or less *brackish*? If so, please give section in reply to query No. 9. 16. Kindly give any further information you can.

#### 11.—ON THE GEOLOGY OF SOUTH AFRICA.

By T. RUPERT JONES, F.R.S., F.G.S., etc.

THE contour of the south coast is parallel with the outcrop of the strata in the interior, from Oliphant's River ( $31^{\circ} 40'$  S. Lat.) on the west coast, southward to the Cape, and then eastward to about  $33^{\circ} 30'$  S. Lat. Here the edges of the strata, formerly bending round to the north, have been swept away to a great extent; but their outcrop is again seen on the east coast at St. John's River ( $31^{\circ} 40'$  S. Lat.), where they strike northeastwardly through Natal, probably far up the country.

1. Gneissic rock and the *Namaqualand Schists* apparently underlie the others, coming out on the north-west and exposing a narrow strip on the south coast. 2. Mica-schists and slates, interrupted by granites here and there, form a curved maritime band, from about



30 to 70 miles broad, and are known as the *Malmesbury Beds* (Dunn). These and the beds next in succession (the *Bokkeveld Beds*, 3) are overlain unconformably by the *Table-Mountain Sandstone* (4), 4000 (?) feet thick, which forms patches and extensive ridges, and possibly dips over No. 3, to join No. 5, the *Witteberg Beds*. Nos. 3 and 5, together about 2100 feet thick, lie parallel, and form a concentric inner band. The former contains *Devonian* fossils; the latter is probably of *Carboniferous* Age (with *Lepidodendron*, etc.), and forms the *Wittebergen* and *Zwartbergen* in the Cape District, and the *Zuurbergen* in Eastern Province.

The *Ecce Beds* (6) come next; Lower Series, 800 feet; Conglomerate Beds (*Dwyka*), 500 feet; Upper Series, 2700 feet; conformable with No. 5; in the south much folded, and in undulations throughout, until it passes under the next set of beds, No. 7, in some places 50 miles to the north. The *Ecce Beds* have fossil wood and plant remains in abundance here and there, but these have not been clearly determined. This series has not been well defined until lately, and even now its limits are not fully determined. It includes the *Karoo Desert*, and therefore takes in the lowest members of *Bain's* great *Karoo Formation*, Nos. 12 and 14 of his map (1856), or the "Ecce," "Koonap," and part of the "Beaufort" Beds of *Jones* (1867). The series No. 7, horizontal and unconformable on the *Ecce Beds* at the *Camdeboo* and elsewhere, retains the name of *Karoo Sandstones*; and after a width of about 40 miles is conformably surmounted by a set of somewhat similar Beds (8) in the *Stormberg*; and thus No. 7 should be regarded as the *Lower*, and No. 8 the *Upper Karoo Sandstones*. The latter end off northwards in the *Draakensberg*, *Natal*, *Orange-Free-State*, the *Transvaal*, and *Zululand*, with the still horizontal *Cave Sandstone* and associated beds. The *Lower Karoo Sandstones* probably thin away northwards beneath the others. Below the *Karoo Sandstones*, and dying out southwards near the *Camdeboo* (*Prof. Green*), are the *Shales* (7\*) which constitute the country around *Kimberley*, described as the "Olive Shales of the *Karoo Formation*," by *G. W. Stow*. These die out northward against the old rocks of *Griqualand-West* and the *Transvaal*. They contain *Glacial* conglomerates in their lowest (earliest) beds, in *Griqualand-West*, just as the *Ecce* series has its great *Glacial* conglomerate (the *Dwyka Conglomerate* in No. 6) in its lowest portion. As the *Stormberg Beds* (8) lie upon the *Olive* or *Kimberley Shales* (7\*) in the *Orange-Free-State*, the *Lower Karoo Sandstones* (7) must die out northwards. The *Kimberley Shales* contain some *Reptilian* bones and plant remains, and some coal on the *Vaal*; the *Karoo Sandstones* are rich with *Dicynodont* and other *Reptilian* bones, and have some *Fish* remains; and their upper portion (*Stormberg*) contains *Ferns* and *Cycadeous* leaves, and some seams of *Coal*. A fossil mammal also has been found in this series. Throughout its range the *Karoo Series* is traversed with igneous dykes.

*Limestones* and *sandstones* (9) with fossils of nearly pure *Jurassic*, but with some of *Cretaceous* type, occur unconformably in the *Eastern Province*. Their fossil *Flora* is like that of the *Stormberg*

*Beds.* Cretaceous strata (10) are known on the Natal coast; and Tertiary and Post-Tertiary deposits (11) form several patches on the East, South, and West coasts.

THE SOUTH-AFRICAN FORMATIONS.

- 11. Tertiary and Post-Tertiary, 100' ?  
 ~~~~~(Unconformable on several different rocks.)
- 10. Cretaceous.  
 ~~~~~(Unconformable on Carboniferous?)
- 9. Jurassic.
 

|   |                      |                         |   |        |
|---|----------------------|-------------------------|---|--------|
| { | Uitenhage Formation. | Trigonia Beds           | } | 400' ? |
|   |                      | Wood-beds               |   |        |
|   |                      | Saliferous Beds         |   |        |
|   |                      | Zwartkop Sandstone      |   |        |
|   |                      | Enon Conglomerate, 300' |   |        |

  
 ~~~~~(Unconformable on Devonian and other old rocks in Albany.)
- Triassic.
 

|                                                    |             |           |   |     |                              |
|----------------------------------------------------|-------------|-----------|---|-----|------------------------------|
| {                                                  | Karoo Beds. | 8. Upper. | } | 7*. |                              |
|                                                    |             | {         |   |     | Cave Sandstone, 150'         |
|                                                    |             |           |   |     | Red Beds, 600'               |
|                                                    |             |           |   |     | Stornberg Beds, 1000'        |
|                                                    |             | }         |   |     | Sandstones and Shales, 5000' |
| Kimberley or Olive Shales and Conglomerates 2,300' |             |           |   |     |                              |

  
 ~~~~~(Unconformable on Ecce Beds in the south, and on the old Vaal and Kaap series in the north.)
- Carboniferous ?
 

|   |                                     |  |
|---|-------------------------------------|--|
| { | 6. Ecce Beds. {                     | Upper Ecce Beds, 2700'   |
|   |                                     | Dwyka Conglomerate, 500'   |
|   |                                     | Lower Ecce Beds, 800'  |
|   |                                     | 5. Witteberg and Zuurberg Quartzites, 1,000' ?                                     |
| { | 4. Table-Mountain Sandstone, 4,000' | ~~~~~(Unconformable on the Old Cape Schists and Slates and on the Bokkeveld Beds.) |
|   |                                     | 3. Bokkeveld Beds, 1100'   |

  
 ~~~~~(Probably unconformable to the Malmesbury Beds.)
- Devonian.
 

|   |                                                          |                                    |
|---|----------------------------------------------------------|------------------------------------|
| { | 2. Malmesbury Beds, Mica-schists and Slates of the Cape. | ~~~~~(Probable unconformity.)      |
|   |                                                          | 1. Namaqualand Schists and Gneiss. |

12.—THE ACADIAN BASIN IN AMERICAN GEOLOGY.

By L. W. BAILEY, Esq., Geological Survey of Canada.

THE Acadian Basin, embracing the region bordering on and including the Gulf of St. Lawrence, together with the provinces of New Brunswick, Nova Scotia, Newfoundland, and Prince Edward Island, constitutes one of the natural physical divisions of the continent of North America, and exhibits many marked peculiarities of climate and floral and faunal distribution. In its geological structure, and in the history which this reveals, its individuality is not less clearly marked, being often in strong contrast with that of other portions of the continent farther west; and in some periods and features even exhibiting a closer relationship with the geology of Europe. In the present paper, the facts bearing upon this individuality are summarised and discussed; including the consideration of the varying land-surfaces of Acadia in different eras, the time and nature of its physical movements, its climate and its life. A review of recent progress in the investigation of its geological structure is also given.

## CORRESPONDENCE.

## PACKING OF SAND GRAINS.

SIR,—Since the appearance of Mr. Mellard Reade's letter (p. 288), I have made some experiments, the results of which may be worth recording. The process followed was to take a specific gravity bottle of capacity 50 cubic centimètres, fill with sand, place in a balance and carefully counterpoise; then fill with water and from the increase of weight deduce the amount of water taken in. This method is sufficiently exact, and requires only one weighing, and no estimate of specific gravity. The sand was packed by continual shaking, not pressing, and it decreased in bulk very considerably during the process. Coarse brown sand was found to occupy  $\cdot 7165$  of the whole volume of the bottle, while fine sand filled  $\cdot 7362$  of the space: these results are very little short of the calculated figure for "pyramidal order,"  $\cdot 7405$ , and would doubtless be still closer if the sand were packed wet and with the aid of pressure. Against the sides of the vessel there is a necessary departure from the close order which obtains in the interior, and this disturbing element becomes, of course, more marked in proportion as the size of the grains compared with that of the vessel is larger. Thus in the same vessel fine sand packs more closely than coarse, and to obtain a similar approximation to pyramidal order in the case of shot would require a vessel of very considerable dimensions, much larger than Mr. Reade's rain-gauge measurer.

NANTLE, *July 18th*, 1884.

A. HARKER.

PROF. BONNEY, F.R.S., AND MR. J. H. COLLINS, F.G.S., ON THE SERPENTINE OF THE LIZARD DISTRICT.

SIR,—In the Quarterly Journal of the Geological Society of August 1st, Mr. Collins in his paper "On the Serpentine and Associated Rocks of Porthalla Cove," has called in question in a very decided manner the igneous origin and intrusive nature of the serpentine of that district—views held by Prof. Bonney and urged by him in several papers printed in previous issues of the same journal.

Mr. Collins contends "that the hornblende schist, Serpentine, and other rocks described are distinctly interstratified, and that there is a real passage from one to the other," that the whole "consists of stratified rocks altered *in situ* by a kind of selective metamorphism."

As an independent observer, and as one who has had many opportunities of studying the subject in the locality referred to, I feel desirous, in the cause of what is right, of confirming Professor Bonney's views as to the true igneous and intrusive character of the serpentine, of which very fortunately there is quite an abundance of evidence, and not by any means a mere matter of opinion.

From Porthalla Mr. Collins has drawn most of his arguments in favour of his views, but here there are the most convincing proofs of the intrusion of the serpentine among the hornblende slates, even more decided than any other examples I have yet seen in the Lizard district. In several of the sections here exposed the serpentine is

not only strongly intrusive, forcing itself through and among the schists, but one of the sections exhibits in the clearest possible way the former involving great masses of the latter rock. Besides bursting through the hornblende slates, the serpentine actually infuses itself into their composition at and near the junctions, so as to form a kind of transition between the two rocks of opposite origin, which Mr. Collins has very evidently mistaken for serpentine in a less altered form, thus seeming to favour his mistaken conclusion of the serpentine being only an altered hornblende slate.

Not only do I consider the views held by Prof. Bonney on this point as strictly correct and in perfect accordance with those of the late Sir H. T. De La Beche, but I would have thought it almost impossible for any observer to misinterpret the sections in a locality where the evidence is so clear and decisive.

TORQUAY, August 23, 1884.

ALEX. SOMERVAIL.

---

#### THE ISLAND OF SOUTH GEORGIA.

SIR,—Mr. Fisher's reasoning upon this island in connection with the supposed permanence of oceanic areas appears to me to lead to precisely the opposite conclusion to that at which he has arrived. The island of South Georgia, as I have before pointed out, is separated from the continent of South America by 1200 miles of ocean—at least all maps represent it so.

If, as Mr. Fisher infers, it had a former land connection with South America, I think most people would see in that fact a tolerably convincing proof of the *want* of permanence in oceanic areas.

PARK CORNER, BLUNDELLSANDS,  
Sept. 2nd, 1884.

T. MELLARD READE.

---

#### MISCELLANEOUS.

BOROUGH OF NOTTINGHAM. ANNUAL REPORT OF THE MEDICAL OFFICER OF HEALTH FOR 1882. By Dr. E. SEATON. (8vo. Nottingham, 1883).—This Report contains a Geological Map of the Borough, on a scale of  $3\frac{1}{8}$  inches to a mile, which is founded on the Map of the Geological Survey, but "re-surveyed and amended in detail" by Mr. J. Shipman, whose work has been approved by Mr. W. T. Aveline. The construction and publication of such a map is a good practical illustration of the want that is felt of geological maps of larger scale than an inch to the mile, that latter scale being too small for most practical purposes; and it is to be hoped that the officers of the Geological Survey will be instructed to carry out the new work that they may have to do on maps of large scale, and thus make their work in the Southern and Midland Counties of far greater value than now. Certainly such mapping should not be left to private or corporate enterprise. There is one defect in the map now noticed, namely, that Drift is not shown on it, except for the gravel that is included with the alluvium, and for some strips apparently marked by fine dotting and by lettering. For sanitary purposes these irregular cappings of gravel, clay, etc., are amongst the most important matters.

THE  
GEOLOGICAL MAGAZINE.

NEW SERIES. DECADE III. VOL. I.

No. XI.—NOVEMBER, 1884.

ORIGINAL ARTICLES.

I.—NOTES ON THE GEOLOGY OF THE NILE VALLEY.<sup>1</sup>

By Sir J. WILLIAM DAWSON, K.C.M.G., LL.D., F.R.S., F.G.S., etc.,  
Principal of McGill College, Montreal.

V.—*General Remarks and Conclusions.*

WE are now in a position to indicate the succession of geological events in Egypt, and to compare them with those of neighbouring regions.

1. The original foundation of this part of Northern Africa was laid in those movements of the Old Laurentian beds which in so many regions gave the first form and direction to the continental masses. It would also seem that in Egypt, as elsewhere, the folding and crumpling of the Laurentian was accompanied and succeeded by the emission, from the interior of the crust, of masses, veins and beds of igneous and aqueo-igneous material, penetrating and overlapping the upturned Laurentian strata, and accompanied with the deposition of the material of a newer crystalline series. I have described these phenomena as seen at the Island of Biggeh, near Philæ; and it seems probable, from the descriptions of Lartet and others, that some of the porphyritic beds seen on the flanks of Mount Hor, and elsewhere in Arabia, are of the same character with those of Biggeh, and may be regarded as representing the Arvonian or the Huronian of more northern countries. As stated above, the anorthosite gneiss, which is the material of the statue of Cephren in the Boulak Museum, may indicate a representative of the Norian series in the crystalline mountains eastward of the Nile.

2. The argillites and chloritic and other schists used by the Egyptians in the manufacture of many minor sculptures, and said to be associated with the celebrated green breccia of Cosseir,<sup>2</sup> are probably of somewhat later age, since the breccia contains fragments of several of the older rocks. They are certainly, however, older than the Carboniferous, and not improbably pre-Cambrian. They have participated to some extent in the disturbances of the older formations.

3. In the later Palæozoic period the crystalline rocks seem to have constituted insular tracts in a shallow sea, in which sandstone was being deposited. It seems definitely ascertained that the lower sandstones and limestone of Wâdy Nosb and other places in the

<sup>1</sup> See also former articles, pp. 289-292, 385-393, 439-442.

<sup>2</sup> Lartet.

Sinaitic region, which Hull now proposes to call the "Desert Sandstone," are of Carboniferous age.

The *Lepidodendron Mosaicum* of Salter and other plants subsequently found are certainly Carboniferous forms, and the marine fossils, the first of which were found by Bauerman in the associated limestone, are now recognized as of the same age. In Egypt fossils of this age have not yet been found<sup>1</sup> in the Nubian sandstone; but there are indications, as above stated, that this is divisible into two members, the upper of which may be Lower Cretaceous, while the lower may possibly be Palæozoic. In this case, as all these sandstones are products of the decay of the crystalline rocks, and are undisturbed, they may possibly represent a shallow sea continuing throughout the Carboniferous and early Mesozoic ages, and receiving the coarser *débris* washed down from the older formations. As already stated, the sandstones of the lignitiferous zone of the Lebanon are probably somewhat higher in the Cretaceous series than the Upper Nubian sandstone of Egypt and Southern Palestine, and are probably Cenomanian. Possibly the beds with vegetable remains which have been reached by boring near Edfou may be its representatives.

4. The middle and later part of the Cretaceous was in this region a time of submergence. But in the Nile valley, and generally in the vicinity of the older rocks, the amount and duration of the submergence were less than farther to the north and east, so that the Cretaceous limestones of Palestine are of much greater volume than those of Egypt. It is to be observed, however, that if the Lignitiferous sandstone of the Lebanon is correctly referred by Fraas to the upper part of the Cenomanian, then a period of shallow-water and land conditions must have recurred in that region, and interrupted the marine conditions.

5. The Cretaceous depression continued throughout the Eocene period, and the great thickness of the limestones of this age in Egypt, and the moderate depths which they indicate, would seem to testify to a slow and long-continued depression, which does not seem to have prevailed to the same extent in Syria. Hence the Eocene deposits of the latter country are much less important.

6. The first important elevation seems to have occurred at the close of the Eocene, so that the beds of that age furnished the soils on which the *Nicotia*, Pines and Palms of the Gebel Ahmar sandstones flourished; and the areas of marine Miocene are very limited in Egypt, and apparently wanting in Syria, indicating that the region had already assumed a continental character.

7. The Pliocene age was probably still more continental, and it is possible that in this age the Nile emptied into a great inclosed saline basin, of which the deposits now constituting the higher portion of the Isthmus of Suez may be a monument, though it is also possible that they may belong in whole or in part to the second continental period of the Post-Glacial age. However this may be, it seems certain that Egypt shared in the great submergence of the Pleistocene

<sup>1</sup> Unless the *Araucarioxylon Egyptiacum* should be regarded as Palæozoic.

and in the subsequent elevation which immediately preceded the Modern age.

The Historical period has been characterized by the deposition of much fluvatile sediment, especially in the Delta, and probably by a slight depression of the Mediterranean coast, accompanied by a corresponding slight elevation between Cairo and the Gulf of Suez. From the close of the Pleistocene period, however, the central part of the Isthmus of Suez would appear to have been land, since it consists of fluvatile and lacustrine deposits, formed by the Pliocene or Post-Glacial Nile, and is uncovered by the modern beds which lie on either side, and contain respectively the shells of the Red Sea and of the Mediterranean.

9. The remains of Man discovered in the Nile Valley are all superficial and modern, unless we except the supposed implements found by General Pitt Rivers in the old indurated gravels near Thebes, which are probably of Pleistocene age. I have, however, elsewhere shown that there is no certainty as to the human origin of the flakes found in these beds.<sup>1</sup> Of the mode of occurrence and relations of the flint implements found on the surface in various parts of the Valley of the Nile, a very good account is given by Mr. Jukes-Browne, in his papers in the Cambridge Antiquarian Society's communications, and in the Journal of the Anthropological Institute. The same conclusions apply to the flint implements found on the surface in Judea and at Beyrout, though there are remains of greater antiquity in the older cave-breccias of the Lebanon.

10. It thus appears that the position of the Valley of the Nile was primarily determined by that of the ridges of old crystalline rocks which caused the flow of drainage to the North, and prevented direct communication with the depression of the Red Sea. It was also influenced by the fractures and faults above referred to, as occurring in the elevation of the Eocene beds, and which produced lines of weakness along the course of the present valley. Much of the actual cutting of the valley must have been effected by the sea in times of Pleistocene submergence, and it must have been at this time that the extensive removal of the softer parts of the Miocene sandstone, evidenced by the loose trees of old petrified forests, occurred. At this time also, many inland cliffs and wadys must have been cut, and beds of gravel deposited. To this period we may also refer the scattering of boulders from the eastern crystalline mountains over the Lybian desert, as seen for example at Denderah. This transport of boulders would indeed seem to imply the action of floating ice in some part of the Pleistocene period, though it is possible that they may have been pushed by the waves along coast-lines which have since disappeared. Lastly, from the first elevation of the Eocene beds, the river itself has been extensively modifying its bed, both by erosion and deposition. It is difficult in all cases to separate the effects of the river erosion and that of its lateral torrents from those of the previous submergence. It is certain, however, that the river action is capable of undermining and gradually cutting

<sup>1</sup> Transactions Victoria Inst. 1884.

back cliffs, and that the present rainfall, small though it is, is yet delivered in such heavy showers as to produce violent and destructive floods. It is probable also that there may have been a period of greater rainfall at the close of the Pleistocene, of which there seems to be evidence in the deposits surrounding the Dead Sea and in the older alluvia of the Nile itself. The cutting back of the Cataracts of the Nile has been already referred to. A curious memorial of this exists in the diverted channel of the river at Assouan, along which the railway at that place runs. According to the measurements of Mr. Hawkshaw, it is seven miles and a half in length; and 100 feet above the present level of the Lower Nile above the cataract. Thus it belongs to a time when a large amount of cutting remained to be done, before the river attained to its present state. In this channel are old banks of Nile mud, which may be seen behind Assouan and also near Philæ, and have been described by Dr. Leith Adams.

It thus appears that the Nile, like most other great rivers, has been only in part the excavator of its own bed, and that it has been indebted to preparations made for it in very ancient times, though mainly to the changes connected with and consequent on the great elevations at the close of the Eocene Tertiary, and the marine erosions taking place in still later submergence and re-elevation. In connection with this, it is interesting to note the recency of the present alluvial plain, and the probability that in the first or second continental period, or in both, the Nile discharged itself to the eastward into the Arabian desert at the head of the Red Sea.

## ERRATA.

- No. VII. Page 291, line 12 from bottom, for "Alsilis" read Silsilis.  
 " " 292, " 16 from top. for "horizontal" read slightly inclined.  
 " " 292, " 20 from bottom, for "Ahmeen" read Ahmar.  
 " " 292, last line, for "leeward" read seaward.  
 No. IX. " 387, first line, for "Seneffeh" read Geneffeh.  
 " " 387, description of plate, for "here row" read horizon.  
 " " 388, line 9 from bottom, for "there" read those.  
 " " 391, footnote, for "Zib" read Tih.  
 " " 392, line 17 from bottom, for "about" read almost.  
 " " 392, " 3 from bottom, for "*Ostrea succinea*" read *Ostrea succini*.

## II.—SYNOPSIS OF THE GENERA AND SPECIES OF CARBONIFEROUS LIMESTONE TRILOBITES.

By HENRY WOODWARD, LL.D., F.R.S., F.G.S.

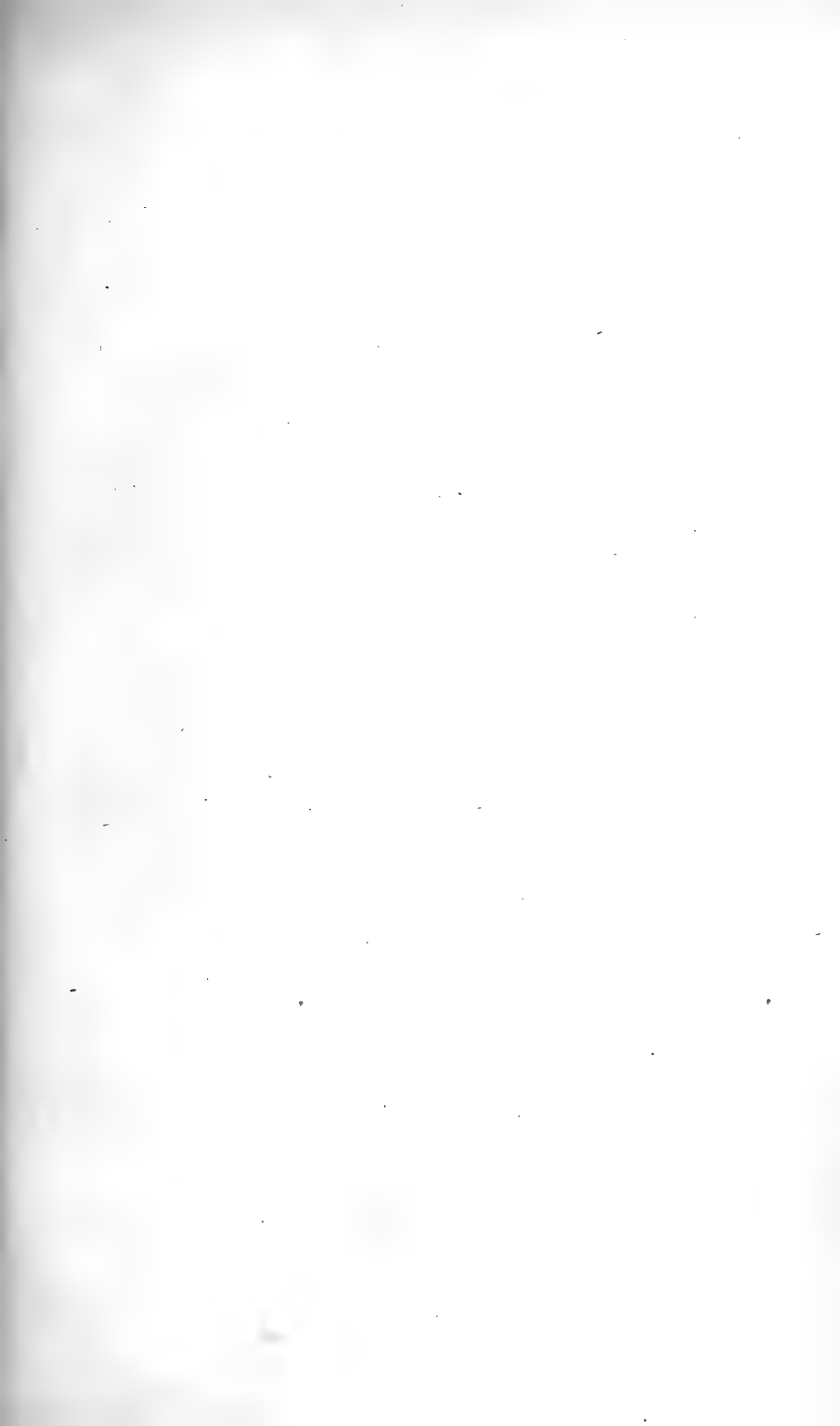
(PLATE XVI.)

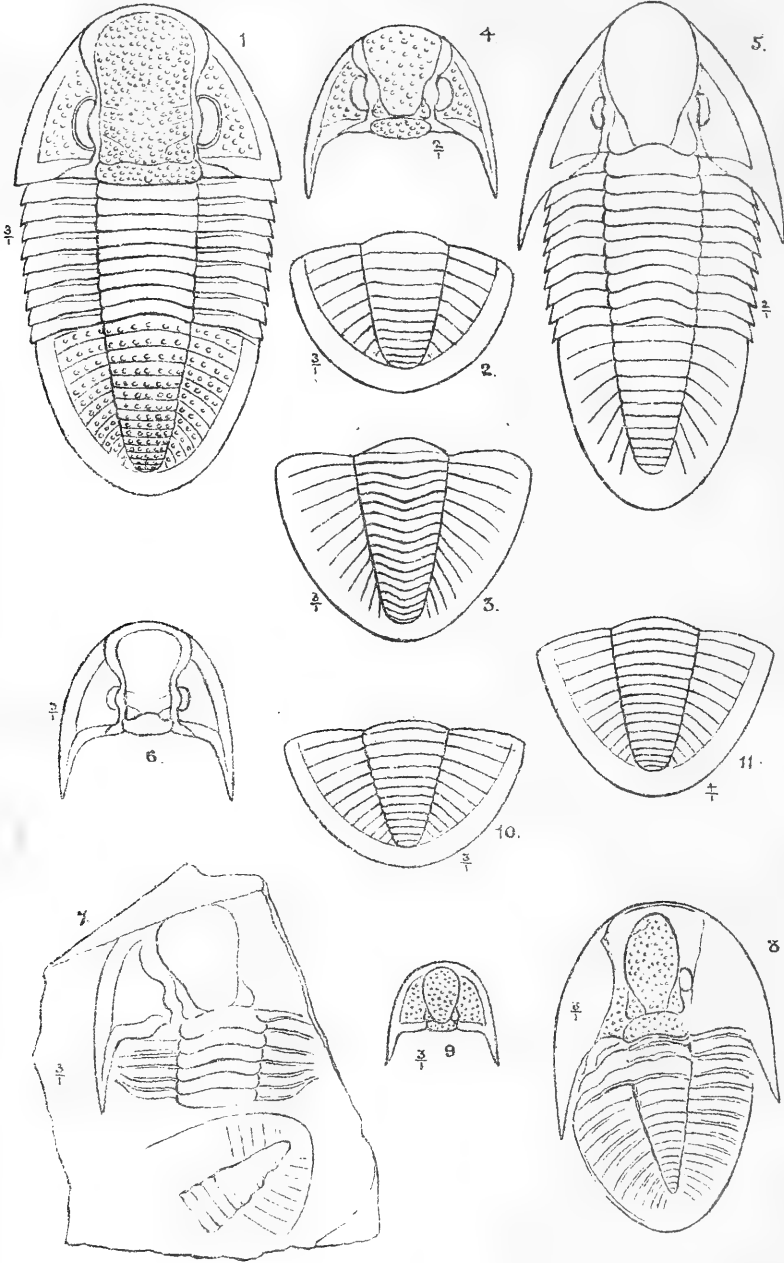
SINCE the appearance of my paper in the GEOLOGICAL MAGAZINE, 1883, Decade II. Vol. X. pp. 534-542, the following species have been added to the list of British Carboniferous Limestone Trilobites, and will form a part of the forthcoming volume of the Palæontographical Society for the present year.

GRIFFITHIDES BREVISPINUS, H. Woodw., 1884. Plate XVI. Fig. 4.  
*Griffithides brevispinus*, H. Woodw., Pal. Soc. Mon. Carb. Trilob. part ii. 1884, p. 39, plate vii. figs. 7, 8.

Among the various specimens received from Mr. Robert Craig, of







GM Woodward del.

Carboniferous Trilobites.

Langside, Beith, Ayrshire, N.B., are two fragments of heads of a small species of Trilobite of the genus *Griffithides*, which, as the discoverer observes, appear to differ from any which have hitherto come under notice from the Carboniferous Limestone. The head is nearly twice as broad as it is long, the free-cheek terminating laterally in a short spine; the eye, which is very smooth, is rounder and more tumid than in other species, and the facets, which are readily discernible with a Browning's platyscopic lens, are very minute, and do not break the smooth hyaline surface of the compound eye.

The glabella is nearly smooth in front, and overhangs the anterior border of the head-shield, the posterior portion of the glabella and the neck-lobe are irregularly tuberculated. The free-cheek is also tuberculated, and has about eight tubercles on each cheek, placed in a semicircle around the compound eyes. The margin of the shield is raised and striated, and has a rather deep and smooth furrow between the raised border and the inner portion of the free-cheek.

In the style of its ornamentation this form agrees most nearly with *G. longispinus*, Portl.,<sup>1</sup> but the head is shorter and broader, and the spines are only one-half the length.

*Formation*.—From the Lower Carboniferous Limestone.

*Locality*.—Langside, Beith, Ayrshire.

From the collection of Mr. Robert Craig, of Langside, Beith, Ayrshire, N.B.

GRIFFITHIDES GLABER, H. Woodw., 1884. Plate XVI. Fig. 5.

*Griffithides glaber*, H. Woodw., Pal. Soc. Mon. Carb. Trilob. part ii. 1884, p. 40, plate ix. figs. 4a and 4b.

The original specimen is preserved in a dark crystalline rock from the Carboniferous Limestone, Castle-Mumbles, Glamorganshire. The extreme length of the more complete specimen is 36 mm., and its greatest breadth 13 mm. Length of glabella, including neck-lobe, 12 mm.; length of pygidium 13 mm. The head is much mutilated, but sufficient of it remains to show that the glabella was smooth, rather tumid, longer than wide, with a basal-lobe on each side near the neck; neck-lobe moderately broad, and marked with one central tubercle; the eyes are not preserved; border of free-cheek terminating in a short lateral spine on each side, and striated below. Free thoracic somites nine in number; extremities of pleuræ smooth and truncated; axis rather wider than lateral portion of somite; coalesced abdominal somites about nine in number; axis nearly smooth, with a slightly serrated posterior edge to each body-ring, margin smooth, rather broad; the pygidium is somewhat narrower and more elongated than in the other Carboniferous species.

Five specimens of pygidia referable to this species are preserved in the Museum of Practical Geology, from the Carboniferous Limestone of Northumberland; there is also a sixth specimen in the same collection, from the Upper Carboniferous Shale of Ashford, Derbyshire.

<sup>1</sup> See GEOL. MAG. 1883, p. 485, Pl. XII. Fig. 5.

This species in general form agrees most nearly with *G. longispinus*, Portl.,<sup>1</sup> but *G. glaber*, as its name implies, is smooth or nearly so, whereas *G. longispinus* is coarsely tuberculated both on the head and body segments, the tail alone being smooth.

In *G. glaber* there is a trace of minute serration seen on a pygidium from Ashford, Derbyshire, not discernible on the other specimens, but I consider that they all belong to one and the same species.

*Formation*.—Carboniferous Limestone.

*Localities*.—Castle-Mumbles, Glamorganshire; Northumberland; and Derbyshire.

All the above specimens are preserved in the Museum of Practical Geology, Jermyn Street.

GRIFFITHIDES? CARRINGTONENSIS (Eth., MS.), H. Woodw., 1884.  
Plate XVI. Fig. 2.

*Griffithides Carringtonensis*, H. Woodward. Pal. Soc. Mon. Carb. Trilob. part ii. 1884, p. 41, pl. ix. figs. 6a and b.

This species, named by Mr. Etheridge, F.R.S., in manuscript, is represented by two pygidia in the collection of the Museum of Practical Geology, Jermyn Street, and one of larger size in the British Museum Collection.

Head-shield and thorax unknown. *Abdomen* or *Pygidium*.—The largest specimen (which is preserved in the British Museum) measures 17 mm. in breadth and 15 mm. in length; the axis is 7 mm. broad at its proximal end, diminishing to 3½ mm. at the distal extremity. It terminates at a distance of 3 mm. from the posterior border, which is smooth, and continues so around the semicircular margin of the pygidium. Twelve coalesced somites are indicated by as many broad and flattened rings in the axis, which have a faint vertical line crossing them on each side of the axis and parallel to the axial furrows. The pleuræ, nine in number, terminate abruptly about 3 mm. from the margin, and are each divided by a median groove.

The other and smaller specimens measure 10 mm. in width by 7 mm. in length, and 11 mm. wide by 8 mm. long.

The pygidium of this species agrees most nearly with *G. obsoletus*, but the latter has no distinct margin to the tail-shield, and has only ten axial rings.

*Formation*.—In white crystalline Carboniferous Limestone.

*Localities*.—Falls Brew, Caldbeck, Cumberland (Mus. Brit.). Longnor and Narrowdale, Derbyshire. (Mus. Pract. Geol.)

#### PHILLIPSIA LATICAUDATA, H. Woodw., 1884.

*Phillipsia laticaudata*, H. Woodw. Pal. Soc. Mon. Carb. Trilob. part ii. 1884, p. 42, pl. vii. fig. 4.

Head imperfect; glabella tumid, rounded in front, with a narrow, smooth, raised marginal rim; general surface smooth, but finely punctated under a lens; basal lobe separated by a deep semicircular furrow from the rest of the glabella, and with two short lateral

<sup>1</sup> GEOL. MAG. 1883, p. 485. Pl. XII. Fig. 5.

furrows on each side. Neck-furrow deep; neck-lobe rounded with one prominent tubercle on the centre. Length of glabella 5 mm., breadth  $3\frac{1}{2}$  mm., cheeks not preserved.

Free thoracic segments unknown. Pygidium much broader than long, very strongly trilobed; axis elevated, consisting of twelve coalesced somites; each ring very strongly ridged, and each ridge ornamented with a line of minute tubercles; side pleuræ nine in number, rather broad for half their length, and minutely ornamented, but becoming fainter for the latter half, and dying away near the margin, which is almost smooth. Length of pygidium 6 mm., of axis 5 mm., breadth of tail 9 mm., breadth of axis 4 mm.

There are four examples of this small species in black Carboniferous Limestone from Bolland, part of the Gilbertson collection preserved in the British Museum (Natural History). Each specimen of a pygidium has also a detached glabella preserved together in the same piece of matrix. There seems no doubt that the heads and tails originally belonged to the same individuals. They are quite unlike the ornamented pygidia of other species of *Phillipsia*, being broader and shorter, and more delicately ornamented, the pleuræ of the tail in particular being very peculiarly marked in their decoration and form, and in the break in their character midway. They appear to be worthy of specific recognition.

*Formation*.—Carboniferous Limestone.

*Locality*.—Bolland, Yorkshire.

PHILLIPSIA SCABRA, H. Woodw. 1884. Plate XVI. Fig. 1.

*Phillipsia scabra*, H. Woodw. Pal. Soc. Mon. Carb. Trilob. part ii. 1884, p. 43, pl. ix. figs. 5a and b.

This species is based upon a head-shield and two pygidia from the Carboniferous Limestone, Vallis Vale, Frome, Somerset,<sup>1</sup> preserved in the Museum of Practical Geology, Jermyn Street.

The head-shield is 12 mm. in breadth by 8 mm. long. The glabella is prominent, rounded in front, but not overhanging the raised anterior border of the cephalon; three oblique furrows mark the sides of the glabella, the front furrow being nearly in a line with the anterior angle of the eye; the basal lobe is large, obtusely triangular in form; neck-lobe 1 mm. deep, divided by a shallow furrow from the glabella; pleuræ of neck-lobe extending for three-fourths the breadth of free-cheeks, and terminating acutely along their posterior margin; lateral border of glabella narrow, but expanding into a moderately broad margin in front of the glabella. Free-cheeks small, with a broad and very distinct margin separated by a deep furrow; the margin is striated longitudinally; the head and cheeks are scabrous, most strongly so on the posterior half of the glabella. The eyes were large, nearly 3 mm. in length; they are unfortunately wanting, being represented by the cavity only.

<sup>1</sup> Mr. R. H. Valpy, F.G.S., Enborne Lodge, Newbury, informs me that he discovered a bed of shale of Carboniferous age with Trilobites in an excavation made for the Rifle-butts on the top of Black Down, on the Mendip Hills, Somersetshire. They were associated with Entomostraca.

*Thoracic segments* unknown; probably nine in number.

*Pygidium*.—The coalesced series of abdominal segments forming the pygidium are about fifteen in number, measuring  $8\frac{1}{2}$  mm. long by 10 mm. in breadth. The axis of the tail is broad at the proximal end, and roundly elevated; it decreases in size somewhat rapidly towards the posterior border which it overlaps. The margin of the pygidium is smooth for the breadth of one millimètre.

*Phillipsia scabra* approaches most nearly to *Ph. gemmulifera* in general appearance, but in the latter species the glabella is smooth, and has only two oblique furrows on its sides, the neck furrow is smooth in *P. gemmulifera*, but finely tuberculated in *P. scabra*. The pygidium in both species shows a smooth margin, which is widest in *P. scabra*.

*Formation*.—In light reddish-brown coloured shale of Carboniferous age. *Locality*.—Vallis Vale, Frome, Somerset.

The only specimens I have seen of this species are in the Museum of Practical Geology.

PHILLIPSIA CARINATA (Salter, MS.), H. Woodw. 1884. Plate XVI.  
Fig. 3.

*Phillipsia carinata*, H. Woodw. Pal. Soc. Mon. Carb. Trilob. part ii. 1884, p. 44, pl. ix. fig. 7.

This species, named in MS. by the late Mr. Salter, is represented by two pygidia in the Collection of the Museum of Practical Geology, Jermyn Street.

It owes its trivial name to the fact that the axis of the tail is acutely ridged, not roundly arched as in most of the other species. At first sight this might be supposed to be the result of crushing, but a closer examination shows that this is not the case, both specimens being similarly ridged.

The pygidium measures 12 mm. broad by  $9\frac{1}{2}$  mm. in length, breadth of axis at the proximal border 5 mm., at the distal extremity 2 mm., length of axis  $8\frac{1}{2}$  mm. There are seventeen coalesced rings in the axis, and ten pleuræ on each side. Most of the surface has been decorticated; but where the shelly crust is preserved, we see that each ring is ornamented by a single row of small tubercles placed rather wide apart.

In Portlock's Geology of Londonderry and Tyrone, on pl. xi. fig. 10, there is a pygidium figured which seems to have been intended for a caudal shield of this very species; but the author makes no allusion to the figure in his text, nor yet in the explanation to the plate.

This species most nearly resembles the pygidium of *Ph. truncatula*, Phil. sp.,<sup>1</sup> but the acutely-ridged character of the axis in *P. carinata* suffices to distinguish it from this and all other species.

*Formation*.—Carboniferous Limestone.

*Locality*.—Derbyshire.

<sup>1</sup> See GEOL. MAG. 1883, p. 451, Pl. XI. Fig. 4.

EXPLANATION OF PLATE XVI.

- FIG. 1. Restored outline figure, *Phillipsia scabra*, H. Woodw. Enlarged three times nat. size (the thoracic segments are ideal).  
 ,, 2. Outline figure of pygidium of *Griffithides Carringtonensis*, Eth. MS. Enlarged three times nat. size.  
 ,, 3. Outline figure of pygidium of *Phillipsia carinata*, Salter, MS. Enlarged three times nat. size.  
 ,, 4. Restored outline figure of head of *Griffithides brevispinus*, H. Woodw. Enlarged twice nat. size.  
 ,, 5. Restored outline figure of *Griffithides glaber*, H. Woodw. Enlarged twice nat. size.  
 ,, 6. *Phillipsia Leei*, H. Woodw. Outline figure of head, enlarged three times nat. size.  
 ,, 7. Another specimen of the same, showing some of the thoracic segments and the pygidium. Enlarged three times nat. size.  
 ,, 8. *Phillipsia minor*, H. Woodw. Outline of an almost complete specimen, enlarged eight times nat. size.  
 ,, 9. *Phillipsia minor*, H. Woodw. Outline figure of restored head-shield, enlarged three times nat. size.  
 ,, 10. *Phillipsia Cliffordi*, H. Woodw. Outline figure of pygidium, enlarged three times nat. size.  
 ,, 11. *Phillipsia articulosa*, H. Woodw. Outline figure of pygidium, enlarged four times nat. size.

Figs. 6 to 11 are from the lower Culm-shales of Waddon-Barton near Chudleigh, Devonshire, and will be noticed in the December Number.

(To be continued in our next Number.)

III.—NOTE ON THE DISTRIBUTION IN TIME AND SPACE OF THE GENERA OF SIWALIK MAMMALS AND BIRDS.

By R. LYDEKKER, B.A., F.G.S., F.Z.S.

HAVING completed the description of the mammals and birds at present known from the Siwaliks of India and Burma (a list of the former being given in the September number of this MAGAZINE, pp. 426-8), I have thought it well to publish a short account of the distribution in time and space of the Siwalik genera of these two classes, as a prelude to a more extended notice, which I hope to give in the "Palæontologia Indica" when I have completed the description of the whole vertebrate fauna of the Siwaliks.

The first part of the following table exhibits the approximate distribution in space at the present day of all the existing Siwalik genera, and also shows the date of the origin in the geological series of Europe of those genera which occur fossil there or elsewhere. Those names which have no letters after them are not found fossil in other regions. The second part gives the distribution of the extinct genera in space; and also in the geological series of Europe.

The equivalents of the abbreviations are as follows, viz. Pl. = Pleistocene; U. P. = Upper Pliocene; L. P. = Lower Pliocene; U. M. = Upper Miocene; M. M. = Middle Miocene; L. M. = Lower Miocene; U. E. = Upper Eocene. The Pikermi and Mont Lebéron beds are classed with the Lower Pliocene, and the Eppelsheim beds with the Upper Miocene. The notes of interrogation indicate that there is a certain amount of doubt in the generic determination.

## I. EXISTING GENERA.

## a. ORIENTAL.

|                                            |                                |
|--------------------------------------------|--------------------------------|
| <i>Sennopithecus</i> <sup>1</sup> (L. P.). | <i>Antilope</i> (? M. M.).     |
| <i>Nesokia</i> .                           | <i>Tragulus</i> .              |
| <i>Rhizomys</i> .                          | <i>Elephas</i> (proper) (Pl.). |
| <i>Boselaphus</i> .                        |                                |

## b. ETHIOPIAN.

|                         |                                   |
|-------------------------|-----------------------------------|
| <i>Cynocephalus</i> .   | <i>Hippopotamus</i> (Pl.).        |
| (?) <i>Oreas</i> .      | <i>Elephas</i> (loxdont) (U. P.). |
| <i>Acelaphus</i> .      | <i>Struthio</i> . <sup>2</sup>    |
| <i>Giraffa</i> (L. P.). |                                   |

## c. ORIENTO-ETHIOPIAN.

|                         |                            |
|-------------------------|----------------------------|
| <i>Hyæna</i> (L. P.).   | <i>Rhinoceros</i> (M. M.). |
| <i>Viverra</i> (U. E.). | <i>Manis</i> .             |
| <i>Mellivora</i> .      | <i>Leptoptilus</i> .       |
| <i>Bubalus</i> (Pl.).   |                            |

## d. COMMON TO A GREATER PART OF THE OLD WORLD.

|                           |                                  |
|---------------------------|----------------------------------|
| <i>Macacus</i> (L. P.).   | <i>Camelus</i> .                 |
| <i>Hystrix</i> (? U. E.). | <i>Sus</i> <sup>3</sup> (M. M.). |
| <i>Capra</i> (Pl.).       | <i>Equus</i> (U. P.).            |

## e. PALÆARCTIC.

(?) *Moschus*.

## f. COSMOPOLITAN.

|                                    |                               |
|------------------------------------|-------------------------------|
| <i>Felis</i> (M. M.).              | <i>Bison</i> (Pl.).           |
| <i>Canis</i> (? U. E.).            | <i>Cervus</i> (U. M.).        |
| <i>Ursus</i> (U. P.).              | <i>Mergus</i> .               |
| <i>Mustela</i> (L. M.).            | <i>Pelecanus</i> (L. M.).     |
| <i>Lutra</i> <sup>4</sup> (L. M.). | <i>Phalacrocorax</i> (L. M.). |
| <i>Lepus</i> (U. P.).              |                               |

## g. AUSTRALIAN.

(?) *Dromæus*.

## II. EXTINCT GENERA.

## a. PECULIAR TO THE SIWALIKS.

|                         |                        |
|-------------------------|------------------------|
| <i>Palæopithecus</i> .  | <i>Propalæomeryx</i> . |
| <i>Æluropsis</i> .      | <i>Bucapra</i> .       |
| <i>Lepthyæna</i> .      | <i>Merycopotamus</i> . |
| <i>Mellivorodon</i> .   | <i>Chæromeryx</i> .    |
| <i>Hemibos</i> .        | <i>Hemimeryx</i> .     |
| <i>Leptobos</i> .       | <i>Sivameryx</i> .     |
| <i>Sivatherium</i> .    | <i>Sanitherium</i> .   |
| <i>Bramatherium</i> .   | <i>Hippohyus</i> .     |
| <i>Vishnutherium</i> .  | <i>Tetraconodon</i> .  |
| <i>Hydaspitherium</i> . |                        |

## b. EUROPEAN.

|                                                    |                                         |
|----------------------------------------------------|-----------------------------------------|
| <i>Ælurogale</i> (U. E.).                          | <i>Anthracotheium</i> (U. E. to M. M.). |
| <i>Hyænaretos</i> (M. M. to L. P.).                | <i>Listriodon</i> (M. M.).              |
| (?) <i>Palæoryx</i> (L. P.).                       | <i>Chalicotherium</i> (M. M. to L. P.). |
| <i>Helladotherium</i> (L. P.).                     | <i>Dinotheium</i> (M. M. to L. P.).     |
| <i>Dorcatherium</i> <sup>5</sup> (M. M. to U. M.). |                                         |

## c. COSMOPOLITAN.

|                                     |                                       |
|-------------------------------------|---------------------------------------|
| <i>Machærodus</i> (U. E. to Pl.).   | <i>Hyotherium</i> (U. E. to M. M.).   |
| <i>Amphicyon</i> (U. E. to M. M.).  | <i>Aceratherium</i> (L. M. to L. P.). |
| <i>Hyænodon</i> (U. E. to L. M.).   | <i>Hipparion</i> (U. M. to U. P.).    |
| <i>Hyopotamus</i> (U. E. to L. M.). | <i>Mastodon</i> (M. M. to U. P.).     |

## d. AMERICAN.

(?) *Agriochærus* (M.).<sup>1</sup> Also Tibetan.<sup>2</sup> Also Syrian.<sup>3</sup> Including *Potamocheirus*.<sup>4</sup> *Lutra* (*Potamotheium*) *Valetoni*.<sup>5</sup> Not improbably identical with *Hyomoschus*.



Among the existing genera, exclusive of the cosmopolitan forms, the most noticeable feature is the large number of those which are confined at the present day either to both, or one or other of the Ethiopian and Oriental regions. Some of these genera are also found in the Tertiaries of Europe; but others have never been recorded beyond the limits of the Ethiopian and Oriental regions; whence it may be concluded that they have very probably always been mainly confined to those regions.

All this is in perfect accord with the now generally received hypothesis that the higher mammals of the Ethiopian region are comparatively recent immigrants from the Euro-Asiatic continent; and it also leads to the conclusion as to the essential unity of the higher mammalian faunas of the Ethiopian and Oriental regions; the present extinction of many Ethiopian forms in the Oriental region being, so to speak, an accident of the present period. Why the members of the first group (*a*) in the table have apparently never extended to the Ethiopian region; and why those of the second (*b*) have totally disappeared from the Oriental region, are questions exceedingly difficult, if not impossible, to answer. In regard to the second group, it is just possible that as a field is after a time more or less incapable of bearing the same kind of crop, so a country may become incapable of supporting the same kind of animal for a very extended period; and thus many forms have disappeared from their old Oriental haunts, but have persisted in the newer field of the Ethiopian region. That the Glacial period, even if it had any appreciable effect in the plains of India, should have led to the extirpation of the Giraffe and the Hippopotamus, while the Elephant and the Rhinoceros survived, seems incredible.

The occurrence of struthioids in the Siwaliks, although not of itself leading to the same conclusion, presents no opposition to the conclusions of Mr. Wallace<sup>1</sup> that these birds were widely distributed at a comparatively early period, and had reached Africa long before the period of the immigration of the larger mammals. The close resemblance of the Siwalik to the existing Ostrich may, however, suggest that this particular genus gained access to Africa at the same time as the larger mammals. *Manis* is probably a member of the primitive fauna of both the Oriental and Ethiopian regions.

Among the extinct genera a considerable number are common to the Tertiaries of Europe, and these, taken with the existing Siwalik genera found in the same region, indicate the general similarity of the earlier mammalian faunas of the Palæarctic and Oriental regions. There are, however, a large number of extinct genera peculiar to the Siwaliks; although several of them are closely allied to European forms. *Palæopithecus* is of especial interest, as confirming the opinion that the Euro-Asiatic continent was the original home of the larger anthropoids.<sup>2</sup> *Hemibos* is doubtless an ancestral form of the living Anoa; and it thus serves to connect the fauna of Celebes with that of the Oriental region.

<sup>1</sup> Vide "Island Life," pp. 408-9 (1880).

<sup>2</sup> I desire to retract all belief in "Lemuria"; to which I had recourse in my description of *Palæopithecus*.

Although many of the older forms among the Siwalik mammals are confined to the lower Siwaliks, yet in the upper Siwaliks there is a remarkable mixture of old and modern genera, which is elsewhere unknown. In explanation of the circumstance that in many parts of the Oriental region the existing species of mammals are older than many important geographical changes, Mr. Wallace<sup>1</sup> observes that, "It seems highly probable that in the equatorial regions species have changed less rapidly than in the north temperate zone, on account of the equality and stability of the equatorial climate." As what is true of a species is probably also true of a genus, we may assume, if Mr. Wallace's hypothesis be correct, that we have here a *vera causa* of this peculiarity of the Siwalik fauna.

It may be added that the existing Siwalik mammalian genera are remarkable for the number of species and types by which they are represented. Thus *Elephas* contains representatives both of the African and Indian sections, as well as a totally extinct section, connecting it with the Mastodons, and apparently peculiar to the Oriental region. *Rhinoceros* likewise contains representatives both of the Ethiopian and Oriental types; and one form is doubtless the direct ancestor of the existing *R. sondaicus*. The Siwalik Hyænas contain representatives of all the known types of the genus; and the genus *Sus* is represented by a large number of forms, one of which shows indications in its cranial characters of affinity with *S. barbatus* of Borneo, while in its molar teeth it presents a remarkable approximation to the existing Ethiopian genus, *Phacochoærus*. We are, however, not at present in a position to say whether most of these genera originated in the Oriental or the Palæartic region.

---

#### IV.—ON THE RELATIVE AGES OF THE AMERICAN AND THE ENGLISH CRETACEOUS AND EOCENE SERIES.

By J. STARKIE GARDNER, F.L.S., F.G.S., etc.

I HAVE been desired by the Council of the British Association to contribute some account of the later Fossil Floras of Europe and America, with a view to determining, more precisely if possible, their relative ages.

It is within the knowledge of every one interested in geology that some fourteen years ago, during the progress of the United States Survey of the Territories, a number of fossil dicotyledonous plants were brought by Dr. Hayden from the neighbourhood, I believe, of Dakota. The exact locality is of no great consequence, for anyhow they belong to the age of the Dakota series, and were intercalated with beds containing marine and brackish water mollusca of a character which cannot reasonably be assigned, according to our present lights, to any later age than the Cretaceous. It was startling to find Floras of such antiquity composed of dicotyledonous plants at all, but especially so, to find them not betraying any marked transition towards gymnosperms or even monocotyledons; but on the

<sup>1</sup> "Island Life," p. 358.

contrary, seeming to be closely allied to well-developed types, which we had been accustomed to consider distinctive of a late stage in the Tertiary. It is now matter of history that Heer, to whom specimens were sent, identified them as of Miocene age, and that two celebrated European geologists, Professors Marcou and Capellini, proceeded to America, and as a result of their examination of the plant-beds of Nebraska, fully endorsed Dr. Hayden's view as to their Cretaceous age.

In order to make my subject intelligible, it is necessary to first notice the salient characteristics of the Cretaceous-Eocene series in America; but as I know nothing concerning them that has not been published, I will do so as briefly as possible. The bibliography is very large, and it would be impossible in a few lines, and with my insufficient study, to attempt any minute accuracy, but I believe a general statement to be sufficient for the purpose, and approximately correct.

The formation is very vast, certainly 15,000 to possibly 20,000 feet in thickness, and extending north and south from New Mexico to far into the British possessions. The sedimentation throughout the entire series, though interrupted locally, seems to have been practically continuous, as reported from the first by Dr. Hayden, and is universally admitted to be of Cretaceous age at the bottom, and of late Tertiary age at the top.

*The "Lower Cretaceous" of America.*—The lowest stage, or one of the lowest, is that called *Dakota*, which appears to be from 500 to 700 feet thick, and consists of alternating coloured clays and sandstones, with seams of impure lignite and silicified wood. The deposits are marine, brackish and freshwater, mostly deposited in very shallow water, or even between tides. The mollusca are chiefly bivalve, but *Ammonites*, *Belemnites*, *Scaphites*, *Baculites*, and *Inoceramus* are met with, together with prints of bird and saurian tracks, ripple-marks, cracks, the impress of rain and hail, and occasionally bones of reptiles. Associated with these are leaves of the higher types of dicotyledons. With the *Dakota* formation are grouped the *Colorado*, *Fort Benton*, *Niobrara*, and other groups, raising the total thickness to over 2000 feet, the entire mass being usually considered in America to represent the period of the *Gault*, *Upper Greensand*, or *Grey Chalk* of Europe.

*The "Upper Cretaceous" of America.*—The next group has been called "*Upper Cretaceous*," and consists of the *Fox Hill*, *Fort Pierre*, and other local subdivisions, whose aggregate thickness seems to be some 1000 to 2000 feet. *Baculites*, *Scaphites*, and *Belemnites* are still present, but are mixed, especially in the *Fox Hill* group, with *Gasteropods*, whose facies is entirely Eocene. The whole series is considered by American and most other geologists to be equivalent to the *Upper White Chalk* and the *Maestricht* beds. All the formations, whether from California, New Mexico, New Jersey, Mississippi, Nebraska, Alabama, or elsewhere, of Cretaceous age, are grouped in either the upper or lower of these formations.

*The "Post-Cretaceous" Series of America.*—This is also known

as the Lignitic or Coal strata, or Laramie group, varying in thickness from 1000 to 5000, and even 10,000 feet. There does not appear to be any physical break between this and the underlying series, though here and there a slight erosion near the junction seems to have been observed. A great change takes place, however, in the character of the flora, the palmate leaves of dicotyledons, such as *Sassafras*, *Liquidambar*, *Platanus*, *Acer*, etc., suddenly giving place to Palms and a series of dicotyledons more characteristic of European Eocenes. The evidence of the mollusca was, formerly at least, *nil* or but trivial; but the discovery of *Mosasaurus* in it has led to a very keen discussion as to whether it should be classed as Cretaceous or Tertiary. Professors Cope and Marsh still, I believe, classify the whole series with the former, and Dr. Lesquereux with the latter. Dr. Hayden formerly considered it to be part Cretaceous, part Eocene,—a true passage bed,—and the term “Post-Cretaceous” was, I think, proposed by Dr. White as a compromise.<sup>1</sup>

*The American “Eocene Series.”*—This is represented by the Wasatch beds, some 2000 feet thick, and the Fort Union group, of purely freshwater origin. It is conformable with the last, and no doubts have hitherto been expressed regarding its age. *The American “Miocene”* is represented by the Green River, Bridger, and other groups, whose aggregate thickness seems to fall not far short of 4000 ft.; and the “*Pliocene*” by the Uinta and Salt Lake, 700 ft., and the Niobrara and Wyoming, 1300 ft. thick.

We thus have a continuous series of littoral and terrestrial deposits in America, commencing somewhere in the Cretaceous age and enduring to the close of the Tertiaries, without any perceptible break in the sedimentation, but with a very considerable break in both the Fauna and Flora. It discloses in fact a sudden transition from a relatively temperate Flora to a sub-tropical one, and from Cretaceous Reptilia to Tertiary Mammalia.

My object is to show, that the data upon which the lowermost beds of the series are correlated with our English Cretaceous series are wholly insufficient; and to set forth grounds which, when more fully investigated, will, I believe, tend to place them very much higher in the series.

We have now to consider at somewhat greater length the Cretaceous and Eocene formations in Europe.

But before attempting to deal with the Cretaceous series, as developed in Europe, we must not forget that the sequence and ages of the rocks composing it were determined originally from a study of a small area only. The classic Cretaceous series is to be met with in England only, I believe, but at all events not beyond Western France and a portion of Germany. The relative ages of all Cretaceous rocks beyond these areas have been inferred from comparisons of their fossils with those of the typical series; and these inferences may be fallacious. When the subdivisions of the Cretaceous system were

<sup>1</sup> An account has been published since this paper of the non-marine mollusca of the series, probably strengthening my views.—J. S. G.

defined in England, geologists had not generally accepted the theory of evolution. The lines then drawn were supposed to be definite, and to mark the almost extinction of one set of organisms and the appearance of entirely fresh forms of life. It is at least desirable that a system of stratigraphy based on such different ideas to those which now obtain, should be reviewed by our present lights, and the old correlations revised by direct comparison with the original standards.

*The Neocomian of England.*—The Cretaceous series commences in Western France and England with the Neocomian or Lower Greensand. The term must be regarded as merely a geological expression to embrace the marine formation between the freshwater deposits of the Wealden of England and Germany and the Gault. It embraces in England two different formations, apparently deposited in different sea-basins and with relatively little in common. The one is represented by the formations of Speeton and Tealby on the Yorkshire, Lincolnshire, and Norfolk coasts, and is traceable through Holland and Germany to Brunswick, and appears in Heligoland. This is not known to exceed 500 feet in thickness, and is composed of clays, grits, sandstones, pisolitic iron, and limestone, all betraying a more or less littoral origin. The southern basin exceeds 800 feet thickness in the Isle of Wight, and is possibly thicker in Kent, and is composed of clays, ferruginous sands, hard "rags," and a variety of beds which are not persistent over any large areas and change their nature frequently. The fossils from various localities differ considerably from each other, especially when those of the two basins are compared, but all seem to betray the not distant shore. The larger bivalves are the characteristic mollusca, and are undoubtedly nearly related to those of the Jurassic, e.g. *Gerillia*, *Trigonia*, *Perna*, *Sphæra*, *Cardium sphæroideum*, *Diceras*, etc. The Gasteropods are more typically Cretaceous, but show no approach to Tertiary forms. Plants are abundant, but consist exclusively of Ferns and Gymnosperms.

*The Gault of England.*—Next in succession to the Neocomian, with which we may include the Aptian, is the Gault—a term originally restricted to a tract of nearly homogeneous blue mud, 100 to 200 feet thick, in the South of England and adjacent parts of France. The fauna is exceedingly rich, and the presence of several deep-water forms, such as *Neæra*, *Cadulus*, *Leda*, etc., indicates that it was deposited in a considerable depth of water. A number of well-preserved plants, amber, wood, etc., seem to attest that it was not wholly removed from the influence of a great river. The term has been extended by European palæontologists to other scarcely synchronous, and probably more littoral deposits from Central Europe. The true Gault contains ample evidence that it was deposited in a steadily increasing depth of water, and it evidently corresponds with the *Blue mud* of the "Challenger" expedition, and like it passes almost insensibly into a true deep-sea deposit, represented by the Chalk Marl. Its mollusca, like those of the Neocomian, are valuable for the purpose of comparison with those of

the Eocenes, as the conditions of deposition do not seem to have been quite wholly dissimilar. The approach towards Tertiary types, however, is as yet very inappreciable, though for almost the first time a few Gasteropods of fusiform type make their appearance. It is also especially noteworthy that though the plants are in considerable variety, they are exclusively gymnospermous. A significant fact in the elucidation of its deposition is that the Gault basement bed includes on the French side of the Channel a fossil, *Ammonites mammillaris*, which is wholly confined to the Aptian in England, only about 30 miles distant.

Succeeding to, and possibly in part contemporaneous with the Gault, is a heterogeneous collection of sands and muds with glauconitic grains called collectively the "Upper Greensand." The varieties of rock included in it are seldom superimposed, and were probably deposited in different ages and under different physical conditions. They, doubtless, correspond to the Green muds and sands of the "Challenger," and form the base of the true Chalk, into which they often imperceptibly merge.

*Chalk.*—The Chalk is a vast formation which has suggested the name for the whole system, estimated to be 1500 feet thick in the Isle of Wight, and exceeding 1100 feet in Norfolk. It is slightly marly and glauconitic at its base, but quickly passes into a pure white limestone composed of the remains of foraminifera, valves of *Cytherina*, excessively minute infusoria, cell prisms of *Inocerami*, sponge spicules and other débris of organic life. The only extraneous substances in it are flint, chalcedony, oxide of manganese in the state of dendritic markings, and oxides and sulphides of iron, all of which have apparently been separated and segregated since its upheaval above the sea-level. It stretches from England, through France, Germany, Poland, and Southern Russia, to Persia and India, much of this enormous tract retaining the characters with which we are so familiar in England. It is difficult to estimate its original extent, for we have evidence in our own country that it has been completely denuded from the Scilly Isles, Wales, and a large part of Scotland, and our Lower Tertiaries are to a large extent composed of its débris.

Its vast extent, homogeneous nature, and freedom from terrestrial impurity, are characters which appear extremely difficult to reconcile with any but an oceanic deposition remote from land. It bears in fact the greatest resemblance to *Globigerina* ooze, while its larger organisms, composed mainly of *Echinodermata* and Sponges, are, with some exceptions, such as are now met with in abyssal depths. Here, if anywhere, we have a truly oceanic deposit, stretching across the heart of a continent, and the advocates of the permanency of continents have therefore exhausted every argument to demonstrate that it is not an equivalent of *Globigerina* ooze. These arguments take no account in comparing analyses of freshly-dredged ooze and chalk, that the latter has been elevated for ages, during which it has acted as a sponge for the collection and percolation of rain-water charged with carbonic acid, which has ceaselessly been re-

moving some of its original constituents. Silica has been dissolved and re-precipitated as flints, oxide of iron has been segregated into crystalline masses, manganese has assumed the form of dendritic markings, siliceous sponge skeletons have been dissolved and replaced by calcite, and calcite shells by silica, while aragonite shells have been entirely dissolved away. The analyses of fragments of chalk without at least adding a proportion of flint and iron are misleading. Mr. Wallace, who has been foremost in endeavouring to explain away the resemblance of chalk to an oceanic deposit, relied greatly on the relatively smaller percentage of carbonate of lime in the existing ooze; but apart from the considerations mentioned above. Mr. Murray has recently stated that the percentage varies from 40 to 95 per cent. of carbonate of lime, so that the supposed great difference in the constituents can no longer be relied upon. The presence of volcanic ash in existing oceanic deposits, on which some stress was laid, and its absence in chalk, merely indicates that the great fissure eruptions which seem to have preceded crater eruptions, were either more intermittent, or, as there is evidence to show, were not accompanied by the ejection of quantities of ash.

Dr. Gwyn Jeffreys, indeed, formed the opinion that the Chalk was a shallow-water deposit from an examination of its mollusca, but the lists submitted to him were largely compiled from the Grey Chalk and Marls at the base of the true Chalk, and a peculiar band from the base of the Chalk in Ireland. He was also biassed to some extent by the absence of such deep-sea forms as *Leda*, *Verticordia*, *Næra*, and the *Bulla* family, though these belong to the group of mollusca with thin aragonite-tests which are unrepresented in true Chalk, and have only left faintly-marked casts in the Chalk-Marl. The widely-spread and representative mollusca in the White Chalk of England belong to the genera *Terebratula*, *Pecten*, *Amussium*, *Lima*, and *Spondylus*, and all but the latter have already been recorded from depths of over 1400 fathoms. When we reflect that for one cast of the dredge in abyssal depths, a thousand have perhaps been made in the littoral zone, we must hesitate to pronounce definitely that any genus is without deep-sea species. Moreover, the Cretaceous temperature was very much warmer than at present, and if, as believed by Prestwich, the Chalk sea did not communicate with the Arctic Ocean, its abyssal depths would have been much warmer, and thus contained a fauna that would have been compelled to seek shallow water in order to obtain anything like a corresponding temperature at the present day. In stating that they are a tropical assemblage, Dr. Gwyn Jeffreys lends strong support to this view. The Gault and Greensands representing the Blue and Green muds of the Atlantic pass gradually into Chalk, as these do into *Globigerina* ooze. As the Chalk overlies and overlaps them, the change in sediment could not have been due to a shallowing of the water, since its area would then have become more restricted, instead of extended. As a change of such a nature is not brought about without cause, we must conclude it to have resulted from increased depth and distance from land. The alternative theory

proposed by Mr. Wallace, that Chalk is decomposed coral mud, could not have been advanced by a geologist, as, while the Chalk contains some well-preserved solitary corals, no remains whatever of reef-building corals have either been found in or surrounding it, or even in any deposit at all contemporaneous with it. I have dwelt at some length on this point, as it is essential to remove such a fundamental misunderstanding before we are able to trace out the relation between the Cretaceous and Eocene series of deposits in Europe.

The whole Cretaceous series, in at least its typical area, is evidently the gigantic result of a gradual encroachment of sea over a former land. The process commenced with the Neocomian, when the East of England was submerged, except the Palæozoic ridge which now passes under London. The incursion was checked until a far more serious and sustained depression of the land and adjacent sea-bed led to the formation of the Gault and Upper Greensands. The downward tendency was steadily maintained until the end of the Chalk age, when some undiscovered cause checked and reversed the movement, and led finally to the reappearance of the deep-sea bed as dry land. The encroaching ocean was probably, in part, the present Atlantic, and the depression seems to have slowly travelled from the English Channel in an easterly direction across Central Europe, forming a gulf of constantly increasing magnitude. As the land subsided and became sea, Blue and Green muds were thrown down, to be succeeded in due time by Chalky ooze. It would be physically impossible for the latter, supposing it to represent Globigerina ooze, to be directly formed on a former land surface, and we thus invariably find true Chalk preceded by some more littoral quality of sediment. The nearer the original centre of depression and focus of the subsidence, the older must be the Upper Greensand or Gault; and the farther we recede from it in any landward direction, the newer it must be. The littoral zone would have been constantly travelling outwards and forwards, occupying the sea-bed, until the ever-increasing depth led to a change in the sediment. Thus, though we have perfectly continuous beds of Greensand, of precisely the same lithological character, and extending over large areas, it would be rash in the extreme to assert that portions of it, separated by one or more degrees of latitude and longitude, are synchronous. So with the numerous zones into which the Chalk has been divided by Dr. Charles Barrois, and which, from their regular sequence of superposition, must indicate variations in the nature of the ooze, resulting from the continued deepening of the water. The Chalk with flints of one locality would be deposited synchronously with the Chalk without of another, and this in turn with the Chloritic marl of another and the Greensand of another. The zone of Greensand would travel forward as long as the sea continued to encroach, and towards its extreme confines would recede again when elevation set in, without any Chalk having been deposited on it, so that a part of the Greensand may be actually newer than almost the whole of the Chalk. It is probable that each minor zone of depth, with its slightly different quality of sea-



bed, was characterized by a fauna in some degree special to it, and which kept up with it as it travelled farther and farther landward. In considering a time so remote as the Cretaceous, when climates partly depended on the internal heat derived from the cooling earth, we may disregard the influence of latitude on distribution, and assume that like conditions of depth would furnish like faunas. The faunas of these ever-travelling zones of depth of the old Cretaceous sea would resemble each other almost to the point of identity, so long as the character of the matrix remains unchanged, and we must therefore be prepared to find the greatest similarity between the fossils obtained from the same zone, at any interval of distance, and not conclude therefrom that they lived synchronously all along the line. They might differ very much from the zones above and below, which were deposited at different depths, and maintain their distinctness over the most extensive areas, as Dr. Barrois has ascertained that they in fact do.

The time required to accumulate a mass of sediment, composed mainly of minute organisms, the relics of which equal 1200 or 1400 feet in vertical thickness, added to the immensely increased time demanded by its travelling progress from Kent to the Crimea, must have been so enormous, that during its lapse the natural law of the evolution of organic forms would have produced changes in animal and vegetable life, a progress in the great chain of causes and effects, which should be appreciable to any competent investigator.

We have noticed that the Neocomians and Gault of England and Western France contain a very varied and considerable flora, represented by foliage and fruits, without, however, affording the slightest trace of the presence of angiospermous dicotyledons. Even the Grey Chalk and Blackdown Greensand have only yielded Conifers and a *Williamsonia* of Jurassic type. We cannot account for their absence by supposing that our area was isolated, since in the immediately preceding Wealden period neither its fauna nor flora differed in any respect from that of the rest of Europe. But when we reach countries as distant as Limburg, Saxony, and Bohemia, we are confronted with a richly dicotyledonous flora, underlying a precisely similar sequence of Cretaceous deposits; comprising Greensands, Chloritic marl, Chalk with and without flints; to that underlaid in England by an almost Jurassic flora. Such a fact remained until now completely unaccountable; but on the present theory it affords no ground for surprise. Satisfactory as this corroboration is, it by no means stands alone. It further indicates, unless we are prepared to deny in the case of dicotyledons the otherwise unvarying law, and definite order, of evolution, how great an interval was required for the Chalk deposit to travel a distance of only 300 to 400 miles—an interval great enough to have permitted enormous progress in the evolution of dicotyledons.

Leaving plants for the present, and turning to the higher Vertebrata, we find that in Europe they afford us hardly any assistance. *Mosasaurus* first appears in the Chalk in England as an exceedingly rare fossil, and its preponderance over other reptilia in the Maestricht limestone, and in other newer deposits, is, I believe, an indication of

age of considerable value. The absence of Ichthyosaurians, which do not seem to have survived the Grey Chalk or Upper Greensand period in England, is evidence of a negative kind, but not, on that account, to be neglected. The replacement of Plesiosaurs by Pliosaurus, and, in short, every fact connected with the distribution of the few vertebrates that occur in our Cretaceous series, has a significance if properly interpreted. The fish teach nothing as yet, nor do the Crustacea. Many of the Echinodermata seem to have remained stationary, while others require a more critical comparison than they have yet received to determine in what direction, and how far in it they have progressed. I fancy, however, that even a cursory examination reveals a distinct progress in the *Micraster*s from the Chalk of Limburg and Denmark, towards the Tertiary types, and I entertain no doubt that an examination of the other Echinoderms by a practised observer, such as Prof. P. M. Duncan, would lead to important results. With this object in view, all the minute organisms which combine to form the Chalk, together with the Hexactinellida, stalked Crinoids and Brachiopods, require special comparison with the species now living under similar conditions. No Globigerina ooze of Tertiary age has yet been discovered. Most of the genera of mollusca of the Chalk itself that were preserved are now extinct, and we do not yet know in what direction they were progressing, or even varying. As there is no reason, however, to suppose that they all became extinct at once, but, on the contrary, much evidence that they gradually dropt out, the percentage of extinct types present in any formation would, to some extent, be an index of its position in the Cretaceous record. As regards bivalve mollusca, there does not seem to me to be any broad rule of progression, and the tendency of individual genera must be traced. The contrary appears the case with the Gasteropoda, if we set aside the archaic helicoid, turbinate and patelloid groups and the tubular *Solenococonchia*. We find a most unmistakable and pronounced tendency to gradually elongate the canal; and the presence in greater or less numbers, or absence, of fusiform shells with lengthened canals would, I believe, be an infallible test of the age of any group of Gasteropods from the Jurassics to the Eocene. The important Cretaceous family of Aporrhaidæ, now confined to two species, reached its zenith in the later Cretaceous rocks, and the presence of relatively gigantic forms is, I feel convinced, a sure sign of a late deposit. Moreover, in exactly the same ratio that the lessening proportion of extinct genera indicates later and later stages, so does the incoming of such distinctly new developments as cones and cowries. Where any considerable group of mollusca is present, there should thus be no great difficulty in determining the relative age of a deposit. No kind of evidence, negative or positive, should be lost sight of however, nor should undue stress be laid upon any one group to the exclusion of others; but chiefly should specialists refrain from attempting to decide complicated geological problems from their own exclusive standpoints.

If we examine the Upper Greensand of Aix-la-Chapelle with these

considerations present to our mind, we immediately recognize that the fauna corroborates in the most striking manner what we had already gathered concerning the juniority of the deposit from its flora. Leaving out the Cephalopoda, about which I am not prepared to express an opinion, we have a certain number of species, though not known by quite the same names, which are identical with those of our Gault. These are:—

|                            |  |                              |
|----------------------------|--|------------------------------|
| <i>Astarte cœlata.</i>     |  | <i>Pleurotomaria.</i>        |
| <i>Gervillia silicula.</i> |  | <i>Cucullæa glabra.</i>      |
| <i>Scalaria Dupiniana.</i> |  | <i>Tritonidea Goepperti.</i> |

and with our Blackdown beds:—

|                               |  |                                                    |
|-------------------------------|--|----------------------------------------------------|
| <i>Cardium tubuliferum.</i>   |  | <i>Aporrhais papilionacea</i> ( <i>A. Mantelli</i> |
| <i>Trigonia alæformis.</i>    |  | of the Grey Chalk.)                                |
| <i>Janeira.</i>               |  | <i>Leda angulata.</i>                              |
| <i>Dimorphosoma anserina.</i> |  |                                                    |

With these is an extraordinary shell, belonging to an altogether new genus of Aporrhaidæ, only represented elsewhere by a very old and unique and therefore doubtful specimen from Blackdown, known as *A. macroptera*, another large form, *A. stenopterus*, Goldfuss, unknown in our Cretaceous, and *A. granulosus*, which is a nearer approach than any other Cretaceous species known to me, to the recent *A. pespelicani*. Among bivalves, *Nucula tenera* approaches, and *Corbula striatula*, *Tellina plana*, *T. strigata*, *Lucina lenticularis*, *L. teneris*, *Pectunculus lens*, species of *Cardium*, *Venus*, *Cytherea* and *Corbula*, seem to be almost identical with Eocene forms. *Clavagella elegans* is an unmistakably Eocene species. Among Gasteropoda, the numerous species of *Voluta*, *Mitra*, *Murex*, *Borsonia*, *Fusus*, *Pyrgula*, *Turbo* and *Bulla* are all Tertiary forms unknown in British Cretaceous rocks—while the *Naticæ*, *Dentalia*, *Cerithia* and *Turritellæ* are neutral. The Cephalopoda, *Inocerami* and Brachiopoda are of course distinctly Cretaceous. A vast number of the characteristic mollusca of our Gault and the Blackdown Greensand (which has a precisely similar matrix to that of the Aix-la-Chapelle beds) are absent, and their places taken by a series of fusiform shells, whose nearest allies are to be found in Tertiary rocks. The Danish Greensand gives similar results. The Chalk with flints of Moën has, as might be expected, a decidedly Chalk fauna, but with many species unknown even in the newest English Chalk.

The Coral band of Faxö possesses no distinctly Cretaceous mollusc except *Pleurotomaria* and a very large *Aporrhais*, associated with two species of *Aturia*, a *Nautilus*, and a most distinctly Eocene group of Gasteropoda, including several *Volutæ*, *Cypreæ*, *Mitra*, *Triton*, *Rostellaria*, *Scalaria*, *Turbinella* and *Modiola*. Finally the Danish limestone called "Upper Chalk" has no purely Cretaceous genus of Mollusca, but the Echinoidea are superficially not dissimilar to those of our Chalk, though they may be Tertiary forms.

A close comparison of the Mollusca has led me to infer that the fauna of Blackdown itself is relatively younger than that of any of the English Greensands to the east of it, and in like manner, that the Chalk of Kilcorrig at the base of the formation in Ireland is

newer than any except the youngest Chalk in England. These conclusions would be fully borne out by physical and stratigraphical evidence, if there were time to examine it here. The Cretaceous series in Bohemia, Gosau, and Poland would, I believe, go far towards connecting the Secondary and Tertiary periods.

Returning, however, to our typical area, England, we are confronted with one of the most considerable gaps in the whole of the geological record. So complete does the break appear that the earlier geologists made it their line of demarcation between the Secondary and the Tertiary periods.

While Chalk or Globigerina ooze was being deposited in ever-widening circles, the central area must have been becoming still more abyssal, and the deposition of matter over it continuous, though perhaps in lessening quantities. It is scarcely possible that this sea-bottom could have been at once uplifted into dry land, and it is more reasonable to suppose that it shallowed as gradually, and the sea retired as slowly, as it had advanced. Thus, if our series were complete, we ought to possess a passage back through greensands to littoral mud or sand. Instead of this, the geological record fails us, and our series terminates abruptly in its central area with deep-sea deposits, the newest of which is old relatively to some called Cretaceous in other countries. The Faxö, and to some extent the Maestricht limestones, mark the retreat of the Cretaceous sea, and a period when the waters had shallowed enough to permit the growth of Coral; but in England the complete change that had taken place in organic life of almost every kind shows that the missing strata might far exceed in importance even the entire Cretaceous and Eocene formations that remain to us. The denudation of the Chalk has been on a stupendous scale, and had doubtless proceeded for ages before the deposition of the Eocene commenced, since even their lowest beds consist of extensive tracts of flint ground into sand and pebbles. It has continued ceaselessly ever since, to how great an extent we learn but imperfectly, by the enormous beds of gravel and sand which compose, to a large extent, the Tertiary gravels and shingle, and that of our present littoral. Our Eocenes are from base to summit the accumulations of a river which drained a continent, in part upheaved from the bed of the Cretaceous ocean, and which must have been deeply covered with Cretaceous sediment. Continuously carried away in solution by rain water and springs; undermined and planed down by the sea to its own level, no matter how towering its cliffs, and with the planing action assisted by every oscillation of level throughout the whole Tertiary period, we need feel no surprise that so mere a fragment of the Chalk formation remains.

If much that I have said appears so simple and obvious that it might well have been treated as a matter of course, its consideration was absolutely necessary to prepare us for that of my actual subject. It was as essential to master these rudimentary facts in the present inquiry, as it would be to take account of the characters of an unknown alphabet, before trying to decipher the meaning of an inscription formed from them.

We are now in a position to revert to the Cretaceo-Eocene series of America, considering first its floras and then its faunas. It is not possible to attempt much direct comparison between the actual constituents of the floras of Europe and America. Such would be unjustifiable with my present knowledge concerning them, and I must merely point out the salient differences between them.

I have already remarked that the oldest of the so-called Cretaceous floras of America is composed of varied and perfectly differentiated Angiosperms, in many cases referable, apparently, to existing genera. The oldest Cretaceous flora in Europe containing Dicotyledons, with which I am personally acquainted, is that of Aix-la-Chapelle, and I should certainly hesitate, and I do not think any one else would be bold enough, to attempt to place its leaves in existing genera. With the exception of a few such as *Credneria* and *Protophyllum*, they are, so far as I can recollect, mostly simple ovate or lanceolate leaves with denticulate or serrate margins. The ferns are, with scarcely an exception, completely different to any found in the Dakota series, and, most significant of all, the Coniferæ possess characters, embarrassing to the systematist, which forbid the greater part of them from being placed in the existing genera. I do not hesitate to pronounce it a far more primitive and archaic flora than any yet described from the United States series. Nothing is definitely known as to the age of the Sézanne flora, and those of America seem to have little in common either with it or with that of Gelinden. When we compare the Dakota flora described by Lesquereux, with the flora of the Reading series, at the base of our Eocene, the points of resemblance are as startling as they are unexpected. I find figured in this single work *Glyptostrobus gracilis*, found by me at Croydon, *Gleichenia Kurriana*, at Bromley, *Sassafras acutilobum*, at Newhaven, *Rhamnus tenax*, *Celastrophyllum ensifolium*, *Platanus diminutiva*, *Sassafras obtusum*, *Menispermities salinensis*, *M. obtusiloba*, *Sassafras cretaceum*, *S. Harkerianum*, *Liquidambar integrifolium*, *Ptenostrobos nebrascensis*, and the most characteristic of the *Carpolithes*, at Reading. I would not assert that these are all specifically identical, but what I do maintain is that it is an utter impossibility for all the chief types of two imperfectly known floras to resemble each other in this manner in an accidental way—when no younger Eocene flora bears the remotest resemblance to the Dakota flora; unless it be that of Mull. I am content for the moment to state the fact without drawing any inference from it.

After the close of the Reading period the Eocene temperature in England rapidly increased, and became almost tropical during the deposition of the London Clay. There is no further similarity between our fossil floras and those hitherto published from America, until the Middle Bagshot horizon is reached, when we find that of Bournemouth bearing a considerable resemblance to those figured by Lesquereux from the lowest, Laramie, and the other stages of the great Lignitic formation. It is certainly a most singular fact that two floras, each so like the other, should follow at like intervals on both continents and yet be of widely different ages.

The most extensive Cretaceous Molluscan fauna of America that I have seen illustrated is that of California. The fossils are from four stages. The lowest or Shasta Group, held to be of the antiquity of the Gault, contains a thoroughly Cretaceous, though meagre, list. The next group above is the Chico, supposed to be equivalent to the Chalk formation of Europe, containing besides 14 typically Cretaceous Cephalopoda, 6 Cretaceous Gasteropods, and 6 bivalves. On the other hand, it contains *Aturia* and 2 very Eocene-looking Gasteropods, *Haydenia* and *Sycodes*. The Martinez Group contains 4 Cephalopoda and 5 Aporrhaidæ of Cretaceous aspect, with 2 or 3 apparently Tertiary forms. The last, or Tejon Group, contains no Cretaceous mollusc whatever, but no less than 34 species which have a definitely Eocene facies.

Professor Marcou wrote that he considered all the supposed Cretaceous rocks of California to be Tertiary, but without going so far as that, there can be no question about the Tejon Group, at least, being of that age.

We have seen that we are not justified in considering a large proportion of the Cretaceous rocks of Europe as synchronous with those of England. Far less are we in a position to identify those of America with any particular stages in England. The question whether they can be properly classed as Cretaceous at all, is even debateable. A Cretaceous fauna must have some elements at least which did not survive into the Tertiaries. Are we in a position to say that *Ammonites* and their allies did not do so in some localities? Mr. J. A. Lebour wrote to remind me some time since, that D'Orbigny many years ago found an *Ammonite* in the Tertiary Coal-bearing rocks on the coast of Chili, together with some other Cretaceous forms; and Darwin also noticed their occurrence. Saporita has also expressed the opinion that *Ammonites*, *Baculites* and *Inocerami* persisted for a longer time in America than in Europe, and instances that in France the chambered Cephalopods left the Cretaceous seas to the south, long before they disappeared from the north. *Belemnites* have more than once been recorded from Tertiary rocks. Such distinctively Cretaceous genera as *Nautilus*, *Pleurotomaria* and *Trigonia* still survive, besides many fish, the sponges, Eocrinites, and many genera of Cretaceous Echinoderms, etc.<sup>1</sup> We justly enough, at the time, assumed that they became extinct at the close of the

<sup>1</sup> "Your letter has of necessity, remained unanswered, for the question of the relations of the Cretaceous and the Tertiary Echinoidean faunas is one I and Sladen are still trying to investigate. Alex. Agassiz's statements regarding the alliances of the deep-sea forms with those of the Cretaceous are diminishing in value in our eyes, and the subject is still in too crude a condition for any satisfactory argument to be developed. Take, for instance, the genus *Salenia*, the Tertiary and the recent species do not belong to the same group of forms which characterize the Cretaceous; and they differ from the Secondary group, more than these differ amongst themselves. The same holds good for the species of *Cidaris*. Certainly no Cretaceous species survives, and I am not sure that any one is common to the Secondary and Tertiary faunas. There are many genera of Corals that are common to the Cretaceous, Tertiary and the recent seas; but not any well-defined species. Unfortunately, the American fossil faunas do not assist in the research. In fact, the break of marine life is vast, and the only connexion is by some Forams and genera of Plantæ.—P. M. DUNCAN."

Cretaceous period because they were absent in our Eocenes, but these, it must not be forgotten, are throughout only the mud of an estuary or small inclosed sea, and were deposited under peculiar conditions. We should have precisely equal grounds for asserting the non-existence of everything not now found within the area of the English Channel. An examination of the fauna of its bed would not convey the slightest indication that numerous survivals of Cretaceous genera are still flourishing in distant seas. Yet such is the case. So with the Reptilia. We have many examples of long isolated lands being tenanted by unwieldy survivals from past ages, and maintaining themselves until brought into contact with newer types of development from elsewhere. There is reason to believe that America was so isolated until some period in the Tertiary, and that such primitive types as *Mosasaurus* should have continued to exist until exterminated by the arrival of mammalia is paralleled in so many instances to-day that no difficulty in admitting the possibility need be felt.

The issue before us is whether we will believe that in America a Cretaceous fauna extended into the Eocene, or that an Eocene flora extended back to the Cretaceous. In other words, is it more difficult to conceive that ancient organisms lived to a later date than we have been accustomed to believe? our own ideas on the subject having been formed from the study of a very limited area; or that a flora, so developed that it might be an existing one, flourished in America for incalculable ages before anything approximating to it in development made its appearance in Europe?

In support of the first proposition, we have the innumerable survivals of old types at the present day, wherever the struggle for existence has been less severe, and the fact that the Cretaceous-looking types are largely mingled with others of a Tertiary facies. The Tertiary facies of the Flora, on the other hand, is not diminished by the presence of any distinctly Cretaceous plants. I think all the evidence I have been able to bring forward is in favour of a newer rather than an older date, and this is decidedly more in harmony with the march of evolution.

The presence at the base of the British Eocenes, and nowhere else in Europe, of a flora so nearly resembling that of the Dakota series of America, seems to prove that England formed part of a continent that stretched across the Atlantic at that date. The Eocenes of England are the muds of an estuary which opened to the east, and all our Eocene seas were on that side, while an enormous river flowed from the west. Later in the Eocene we have a large influx of tropical American plants and land mollusca, and I believe a critical statement of the evidence in support of this land connection would place it beyond all reasonable doubt. An increase of temperature drove the old flora north, and we find it succeeded in both areas by a more tropical-looking flora which, considering the enormous distance separating them, is of strikingly uniform character. The land connection afterwards became disrupted in the west and extended towards the east, so that this tropical flora, arriving from America,

is found in France, Austria, and Greece, while the preceding American floras are not. This kind of speculation, however, is very fascinating, and would carry us far beyond the object in view, namely, to contribute towards the determination of the relative ages of the British and American Cretaceo-Eocene series.

If the considerations I have brought forward were allowed to prevail, the entire Cretaceous series of America would have to be classified as Eocene, or at least placed considerably above the Maestricht limestone. Most of the greatest geologists of America, together with such distinguished Europeans as Lyell, D'Orbigny and Pictet, have concurred to correlate them with ours from the Gault to the White Chalk. The divergence of opinion concerning them, and its discussion, has been almost limited to whether one of the latest stages, the Laramie (which my views would make Middle Eocene) is Cretaceous, post-Cretaceous, or Eocene. The vast geological and biological importance of the question I have now raised is therefore apparent. I am not presumptuous enough to set an individual opinion in opposition to that of the great leaders of science, nor vain to suppose that it would carry any weight; but the chance that has led me to collect our British Eocene plants, has also enabled me to make observations from them that have been shared by few: and my hope in recording these now is, that they may receive such attention as they may deserve, if those we justly look upon as our teachers should think it worth while to reinvestigate the subject.

#### V.—THE EOZOIC ROCKS OF NORTH AMERICA.

By T. STERRY HUNT, LL.D., F.R.S.

THE following is an abstract of Dr. Hunt's paper. According to the author there is found among the pre-Cambrian strata of North America an invariable succession of crystalline stratified rocks, which have been by him divided into several great groups, the constituents of which become progressively less massive and less crystalline until we reach the sediments of Palæozoic time; of which the Cambrian is regarded as the basal member. Since all of these pre-Cambrian rocks, with the exception, perhaps, of the lowest or fundamental gneiss, present evidences, direct or indirect, of the existence of organic life at the time of their deposition, it seems proper to include them under the general title of Eozoic, proposed by Sir J. W. Dawson. That of Archæan, employed by some geologists to designate these pre-Cambrian rocks, appears too indefinite in its signification, and, moreover, is not in accordance with the nomenclature generally adopted for the great divisions succeeding. These Eozoic rocks include both the Primitive and the Transition divisions of Werner.

We distinguish at the base of the Eozoic series a massive and essentially granitoid gneiss. To this fundamental rock, sometimes called the Ottawa gneiss, and of unknown thickness, succeeds what has been named in Canada the Grenville gneissic series, made up in great part of a gneiss somewhat similar to that last mentioned, with



intercalations of hornblendic gneiss, of quartzite, of pyroxenite, of serpentine, of magnetite, and especially of crystalline limestones, the latter often magnesian, occasionally graphitic, and sometimes attaining thicknesses of a thousand feet or more. This Grenville series, the strata of which are generally highly inclined, has an aggregate volume of not less than 15,000 or 20,000 feet, and appears to rest unconformably upon the fundamental or Ottawa gneiss. This gneissic series, with its intercalated limestones, some of which contain *Eozoön Canadense*, was the typical Laurentian of Logan and Hunt, named by them in 1854, with which they included, at that time, however, not only the underlying fundamental gneiss, but an upper granitoid and gneissoid series composed in large part of plagioclase feldspars, chiefly labradorite. These three divisions of the Eozoic system were thus confounded under the common name of Laurentian until in 1862 the last was separated under the provisional name of Upper Laurentian, the two other divisions united, being called Lower Laurentian. The synonym of Labradorian was subsequently, for a time, employed by Logan to designate the upper division, until 1870, when the present writer proposed for it the name of Norian, retaining that of Laurentian for the two lower divisions. It will probably be found desirable to separate the typical Laurentian or Grenville series as studied and mapped by Logan, Hunt, and Dawson, from the less known fundamental or Ottawa gneiss, and to make of this latter a distinct group. The name of Middle Laurentian sometimes given to the typical Laurentian loses its significance with the disappearance of that of Upper Laurentian, now replaced by Norian.

The Norian series is made up in great part of granitoid or gneissoid rocks composed essentially of plagioclase feldspars, without quartz, but with a little pyroxene or hypersthene, often with titanite iron ore, and apparently identical with the norites of Norway. With these rocks are, however, found alternations of gneiss, of quartzite and of crystalline limestone, scarcely different from those of the Laurentian. We therein find also a granitoid rock made up of pink orthoclase and quartz, with bluish labradorite. This Norian series is found in many places covering considerable areas and apparently resting in discordant stratification upon the typical Laurentian. Its thickness has been estimated at over 10,000 feet.

There is found in certain localities a series of stratified rocks, composed essentially of petrosilex or hallefinta, often passing into a quartziferous porphyry. There are found with it strata of vitreous quartzite, and thin layers of soft micaceous schists, besides great beds of hematite, and more rarely layers of crystalline limestone. This group, which has a thickness of many thousand feet, was at first included by the writer in the lower part of the succeeding Huronian series, which, however, apparently overlies it unconformably. Its relations with the preceding groups have not been observed, but as it appears to be identical both in position and in character with what, in 1878, was called Arvonian in Wales, we designate it by that name.

Next in order comes the group to which the writer, in 1855, gave the name of Huronian. It differs from those preceding by the

frequent presence of schistose rocks, and of conglomerates, which contain fragments of the underlying gneisses. These characters, which are common to the Huronian and the two succeeding groups, led the earlier geologists of America to include them among transition rocks. The Huronian contains a considerable proportion of epidote, hornblende and pyroxene, and is marked by varieties of diabasic rocks often called gabbros, which are truly stratified, but are not to be confounded with the norites of the Norian series, to which the name of gabbro is also often given. The Huronian series moreover includes imperfect gneisses, quartzites, dolomites, serpentines and steatite, besides large amounts of chloritic, micaceous and argillaceous schists. Its thickness is estimated at about 18,000 feet, and it is often found resting unconformably upon the gneiss of the Laurentian. The Huronian appears to be identical with much of what has since been called Pebidian in the British Isles, and with the true *pietri verdi* group of the Alps, there found in many parts between the ancient gneisses below and a younger series of gneisses and mica-schists.

There is met with in North America a similar series to these, to which in 1870 the writer gave the name of Montalban, for the reason that it is found largely developed in the White Mountains of New England. This series contains fine-grained white gneisses, sometimes porphyritic, but distinct from the granitoid gneisses of the Laurentian, and passing into granulites on the one hand, and into very quartzose coarse-grained mica-schists on the other. It also includes hornblendic gneisses and black hornblende schists, together with serpentines, chrysolite rocks, dichroite-gneiss, and crystalline limestones. The mica-schists of the series often contain garnets, andalusite, fibrolite, cyanite, and staurolite, while in the granitic veins which traverse the series are found tourmaline, beryl and cassiterite. The total thickness of the Montalban is apparently much greater than that assigned to the Huronian, upon which it sometimes rests unconformably, or, as is often the case in the absence of this, directly upon the Laurentian.

We come in the next place to a series composed essentially of quartzites, limestone, and micaceous and argillaceous schists. The quartzites, occasionally conglomerate, are sometimes vitreous, sometimes granular and often micaceous, passing into mica schists very distinct from those of the Montalban. The mica is often damourite or sericite, and gives rise to unctuous glossy schists passing into argillites which sometimes contain a felspathic admixture. The limestones of this series, often magnesian, are crystalline, and include statuary marbles and cipolinos. We find in the schists, which are intercalated alike among the quartzites and the limestones of this series, masses of serpentine and of opicalcite, and occasionally of chloritic and hornblendic minerals, as well as siderite, magnetite, and hematite, the iron oxides being often mingled with the quartzites. These last are sometimes flexible and elastic, and the whole series much resembles the Itacolunitic group of Brazil. It has a thickness in different parts of North America of from 4,000 to 10,000 feet, and is found lying unconformably alike upon the Laurentian, the

Huronian, and the Montalban. There are found in the quartzites of this series the impressions of *Scolithus*, and in the limestone other undetermined forms. This is the Lower Taconic series of the late Dr. Emmons, which we distinguish by the name of Taconian. Some late writers have by mistake confounded it with the Upper Taconic of the same author, a distinct group, which Emmons declared to be the equivalent of the primordial (Cambrian) of Barrande. The Taconian is widely spread in eastern North America, and appears to be also represented around Lake Superior by what has been called the Animikie series. There is reason to believe that on account of certain lithological resemblances between the Taconian and the Huronian, the two have been in some localities confounded, and that portions which have been called Huronian are really Taconian. The latter the writer has elsewhere compared with a great series of similar schists and quartzites, including serpentine, anhydrite, dolomite, and marbles, greatly developed in northern Italy, where it overlies the younger gneissic and mica-schist series, and has been by various observers successively referred to the Mesozoic, the Palæozoic, and the Eozoic periods.

It now remains to say something upon the relations of these different crystalline Eozoic series to the Cambrian which succeeds them. Forty years since there were two schools among American geologists. One of these schools admitted the existence between the ancient gneissoid rocks (subsequently named Laurentian and Norian) and the fossiliferous limestones of the second fauna (Ordovician) of nothing more than the Cambrian subdivisions known as the Potsdam sandstone and the Calciferous sand rock, which in the vicinity of the Adirondack Mountains separate these ancient crystalline rocks from the Ordovician strata.

The other school of stratigraphists recognized the existence, in this interval, in the region to the east of Lake Champlain, of several series of crystalline rocks, including what we have already described under the names of Arvonian, Huronian, Montalban and Taconian, besides a younger series of uncrystalline sediments of great thickness, designated by Eaton the First as Transition Greywacke. This was by him declared to be separated by the limestones of the second fauna from the Secondary Greywacke, a series closely resembling the Transition Greywacke. The first-mentioned school denied the existence of the Transition Greywacke, and maintained that the group thus designated was identical with the secondary Greywacke. The geologists of this school further supposed that all the different series of crystalline rocks just named were nothing more than the same Secondary Greywacke, with the addition of the underlying fossiliferous limestones, in a state of alteration more or less profound; the series in different areas assuming successively the character of Taconian, Montalban, Huronian, and even, as some imagined, of Laurentian. The recent progress of American stratigraphy has fully justified the views of the second named and older school of Eaton. It has been shown that the First or Transition Greywacke of this author, which was the Upper Taconic of Emmons, and includes the Primordial or Cambrian fauna, rests in unconformable stratification

upon the various crystalline series named, and that all of these great groups belong to Eozoic time. The Quebec group of Logan, as well as what he called the Potsdam group, is this same Cambrian or Transition Greywacke. The Hudson River group also, as first described by Vanuxem and by Mather, and later by Logan up to 1860 (when he changed its name to that of the Quebec group), is nothing else than this same Cambrian Greywacke, with the addition, in certain localities, of a portion of Taconian, and in other of schistose beds containing the second fauna (Utica and Loraine shales). The above explanation becomes necessary for the reason that the Canadian geologists (Logan and the present writer) formerly described, in accordance with the views of the first-named school, certain crystalline schists, chiefly Huronian, as altered rocks of the Hudson River group, and later (from 1860 to 1867) as of the Quebec group.

The cupriferous series of the basin of Lake Superior (the distinctness of which was maintained by the writer in 1873, when he called it the Keweenaw group, a name which he subsequently changed to Keweenian), which has a thickness probably greatly exceeding 20,000 feet, was also by Logan referred to the Quebec group. It has, however, been shown by later observers that the fossiliferous sandstones which rest in horizontal layers upon the inclined strata of the Keweenian, belong to the Cambrian, and hold the fauna of the Potsdam. The conglomerates of the Keweenian cupriferous series contain portions alike of Laurentian, Arvonian, Huronian, and Montalban rocks, and appear, according to the latest observations, to overlie the schists which we have referred to the Taconian. The sandstones and argillites of the Keweenian, which are interstratified with great masses of melaphyre, are uncrystalline. It remains to be determined whether the intermediate Keweenian series has greater affinities with the Taconian than with the Cambrian.

We have thus sought to include the whole vast system of primitive and transition crystalline rocks, from the fundamental granitoid gneiss upward, under the names of Laurentian, Norian, Arvonian, Huronian, Montalban, and Taconian.

The Arvonian or petrosilex group intervenes between the Laurentian and the Huronian, but the peculiar characters of the Norian, and its localization to some few limited areas in Europe and North America, make it difficult for us, as yet, to define its precise relations to the Arvonian. The Norian, however, probably like the Arvonian, occupies a horizon between Laurentian and Huronian. Much time may pass, and many stratigraphical studies must be made, before the precise relations of the Huronian and the succeeding Montalban can be defined. It seems probable, in the present state of our knowledge, that the Montalban series was, in many cases, deposited over areas where the Huronian had never been laid down. Notwithstanding the great geographical extent and the importance of these two series, neither can claim that universality which probably belonged to the primitive granitic substratum, a universality soon interrupted by the appearance of dry land; an event which preceded Huronian time.

---

## R E V I E W S.

GEOLOGY OF WEYMOUTH, PORTLAND, AND COAST OF DORSETSHIRE, FROM SWANAGE TO BRIDPORT-ON-THE-SEA: WITH NATURAL HISTORY AND ARCHÆOLOGICAL NOTES. By ROBERT DAMON, F.G.S. pp. xii. and 250. New Edition. (Weymouth: R. F. Damon. London: Edward Stanford, 1884.)

MR. DAMON'S "Geology of Weymouth" has so long and so deservedly ranked as one of our best local geological guides, that we heartily welcome this new edition, and more especially as nearly a quarter of a century has elapsed since its predecessor was published.

While Geology has made immense strides during this period, yet it is a significant and happy fact that the names of the formations remain the same as those chronicled in 1860; and the student is not perplexed, as he may be in some other districts, by many contradictory opinions on the grouping of the rocks, nor (as a rule) by finding two or three names applied to the same formations by different individuals who have written about them. The chief additions to our knowledge of the geology of the neighbourhood of Weymouth, consist in enlarged lists of the fossils, and many more particulars about the rocks.

The labours of Messrs. Blake and Hudleston on the Corallian Rocks call for special mention, as, although they made seven divisions in this group at Weymouth, which would on first thoughts seem a burden to the science, yet these divisions are locally well marked, and their names are very useful in the district for those who study the beds in detail, and collect fossils from definite horizons. Mr. Damon has introduced a neat photograph showing a block of rock containing 60 or 70 specimens of *Trigonia clavellata* from the "Trigonia-beds" of the Coral Rag at Weymouth, which may well astonish the ordinary observer. The shore in places at Osmington and south of Weymouth is truly paved with Trigonias—but, alas! really good specimens are not readily to be obtained. And it is only by the use of the chisel and much patience that such a number of beautiful specimens could have been developed.

Nevertheless the collector is likely to be well rewarded in whatsoever direction he can wander from Weymouth. The bank of Fuller's Earth almost made up of specimens of *Ostrea acuminata*, discovered by Mr. Damon at Langton Herring, the many quarries in Forest Marble and Cornbrash, the cliffs of Oxford Clay, Coral Rag and Kimmeridge Clay, and again the interesting Isle of Portland, with its stone-quarries and Purbeck Dirt-bed, are all within easy distance of Weymouth. Then, too, steamers will convey the visitor to the romantic cove of Lulworth, with its contorted Purbeck strata, and here the Chalk, Greensand and Wealden Beds may be profitably studied. Further along the coast we pass sections of similar rocks in the picturesque cliffs of Warbarrow, and Mr. Damon conducts us to these, passing thence by Gad Cliff to the dark shales of Kimmeridge,

and round Durlston Head to the famous stone-district of Swanage. Here he aids us by inserting in full the detailed section of the Purbeck strata of Durlston Bay, measured many years ago by Mr. H. W. Bristow. Our guide takes us also to the Punfield Beds, and beyond the great Chalk ridge on which Corfe Castle stands, to the Tertiary tracts, and the pipe-clays and leaf-beds developed to the north of Corfe and near Bournemouth.

Glancing back at some of the new facts presented to our notice, we may especially mention a number of minute mollusca, not previously found in this country, which were obtained by Mr. Damon in the Upper Portland rocks at Portland. The species have been described from similar rocks at Boulogne by MM. de Loriol and Pellat, and they belong to the genera *Cerithium*, *Delphinula*, *Nerita*, *Odostomia*, etc.

Mr. Damon makes some interesting remarks on the great Purbeck Dirt-bed, comparing it with the Tchornozem or "Black Earth" of Central Russia, which by some authorities is supposed to be the decomposed débris of an ancient forest. Having brought from Russia samples of this famous earth, which produces some of the richest soil in Russia, both for corn and grass, Mr. Damon, by experiment, proved that it exceeded in fertility both garden mould, and the old soil of the Purbeck Beds.

The Quaternary deposits are fully described, and passing on to the times that perhaps are scarcely geological, Mr. Damon draws attention to the most interesting discovery of some underground huts or Dene-holes of beehive-form, that were uncovered in Portland in removing the Purbeck strata ("rubble," "hard slate," etc.), from the merchantable Portland Stone that lies below. That these structures were in part used as ancient granaries appears highly probable.

We should mention that Mr. Damon extends his account of the strata westwards as far as Bridport Harbour and Eype, a district famed for its fossils, especially those of the "Dorsetshire Cephalopoda-bed." The exact age of this bed is, by-the-by, a matter of some controversy—perhaps we should say the exact palæontological equivalent, for its stratigraphical position is clear enough. Strictly speaking, the whole of the Inferior Oolite in the district is a Cephalopoda-bed.

Mr. Etheridge has furnished a detailed section of the Inferior Oolite Limestone and Sands near Bridport Harbour, and although he would correlate the beds rather differently than does Professor Buckman, yet probably this divergence of opinion will not affect the enthusiasm of collectors, who may be well content to label their fossils as from the Inferior Oolite, without disturbing their minds about the question of zones and minor subdivisions. To these, the list of the more abundant fossils from the Inferior Oolite of Bridport and Burton Bradstock will doubtless prove most serviceable. There is also a useful list of fossils from the Fuller's Earth of West Cliff, Bridport Harbour.

While woodcuts of many fossils are given in this book, it may be noted that a new edition of the supplement or atlas to the work was

issued in 1880, and that contains eighteen beautiful lithographic plates of fossils from the Oolites, with descriptions of several new species.

The map accompanying this volume has been executed by Mr. Stanford with his unrivalled clearness and excellence of style, though perhaps the faults are marked a little too clearly. The geology is reduced from the Geological Survey Map constructed by Mr. Bristow, and takes in the whole of the country from Swanage to Bridport Harbour.

With this volume and its supplement the student will find himself well able to master the geology of this interesting and picturesque district; for Mr. Damon furnishes many miscellaneous geological notes and also gives references to papers where further details may be found, while his memoranda on the Natural History and the Antiquities of the county will lend much additional charm to its study, and perhaps stimulate enquiry into other branches of science besides geology.

---

## REPORTS AND PROCEEDINGS.

---

### ABSTRACTS OF PAPERS READ BEFORE THE GEOLOGICAL SECTION OF THE BRITISH ASSOCIATION AT MONTREAL, AUGUST, 1884.

(Continued from the October Number, p. 478.)

#### 13.—WHAT IS A MINERAL VEIN OR LODE?

By C. LE NEVE FOSTER, B.A., D.Sc., F.G.S., H.M. Inspector of Mines.

**T**HE author quoted briefly the definitions of a mineral vein given by Werner, Carne, Von Cotta, Grimm, Von Groddeck, Geikie, Sandberger, and Serlo, who, in common with most geologists, have looked upon mineral veins as 'the contents of fissures.' While admitting that a very large number of veins may be so described, the author contended that the exceptions are sufficiently important and numerous to warrant a change in the definition. He is of opinion that many of the principal and most productive tin-lodes in Cornwall are simply tabular masses of altered granite adjacent to fissures; and he brought forward the opinions of other geologists to show that certain veins in the English Lake district, the Tyrol, Nova Scotia, Nevada, Colorado, California, and Australia are not filled-up fissures. In conclusion, he proposed the following definition: 'A mineral vein or lode is a tabular mineral mass formed, more or less entirely, subsequently to the enclosing rocks.'

#### 14.—ON ICE-AGE THEORIES.

By the Rev. E. HILL, M.A., F.G.S., Tutor of St. John's College, Cambridge.

**O**N the Montreal Mountain, in the neighbouring quarries, at the mouth of the Saguenay River, and more or less everywhere over all Canada and all the north and north-west of this continent, are seen phenomena which imply a former vastly extended action of ice. The like are found over Europe and Asia, thus completely encircling the pole. Many theories have been propounded to account for these facts. It is proposed to pass these before you in review.

Any explanation ought to account not only for cold greater than the present, but for accumulations of snow and ice. A kindred phenomenon is the greater size of the Antarctic ice-cap. The supposed interglacial warm periods, and the unquestioned luxuriance of Miocene vegetation in Greenland, ought also to find their causes in any thoroughly satisfactory theory.

The theories which have been propounded fall into three groups, as Cosmical, Terrestrial, and Astronomical (or Periodical).

The Cosmical theories are Poisson's Cold-Space theory—incomprehensible; and the Cold-Sun theory of S. V. Wood and others—lacking any evidence.

The Terrestrial theories are numerous. Lyell's suggestion of Polar-continent and Equatorial-ocean is opposed by evidence that continents and oceans lay on much the same areas as now. The contrary view, Polar-ocean and Equatorial-land, would deserve consideration but for the same opposing evidence. The elevation view (Dana, Wallace), which alleges greater altitude of mountain-chains, disagrees with the strong evidence for land-depression during the period. The submergence view of Dr. Dawson agrees with this evidence, but requires elucidation. Alteration of ocean-currents (Gunn, J. S. Gardner) is a most powerful agency, but would act locally rather than universally, round the pole. Alteration of prevalent winds, hitherto worked out by no one, deserves attentive consideration. Conditions are conceivable which would produce over an area winds from cold quarters almost permanently. However, this seems open to the same objection as the preceding theory.

Last come the Astronomical or Periodical theories. A tilt of the earth's axis was suggested by Belt, but suggested as owing to causes which are wholly insufficient. Tilting from astronomical agencies is slight, though its action would be in the direction required. Herschel suggested the Eccentricity theory, but abandoned it. Adhémar's Precession theory, as explained by himself, involved an absolute fallacy. The celebrated view of Dr. Croll combines the Precession and Eccentricity theories into one. It exactly agrees with the Antarctic greater extension of ice, and provides an explanation of interglacial warm periods. The great difficulty in its way is to see how a mere difference in distribution through the year of an unchanged total heat-receipt can produce consequences so vast. The laws of radiation explain but a very minute part, the laws of evaporation perhaps rather more; but, so far as can at present be seen, both together are inadequate. Another serious objection is that the theory seems to require the climate of the northern hemisphere to be now in a state of change for the better, of which at present there appears no evidence.

Dr. Croll's elaborate explanations of the reaction of one effect upon another—fogs, deflection of currents, and the like—have no special connection with his own theory. They would act in all cases, and support all theories equally. The arguments, if admitted, would only prove that the earth's climates are in a state of highly unstable equilibrium, in which a slight cause may produce an enormous change. Nor are his arguments universally admitted.



In conclusion, Dr. Croll's theory seems inadequate; alteration of currents and winds are the most powerful causes suggested hitherto: further investigations ought to be made as to the nature and extent of the last series of changes in the outlines of the continents of the globe.

---

15.—ON THE STRUCTURE OF ENGLISH AND AMERICAN CARBONIFEROUS COALS.

By EDWARD WETHERED, F.G.S., F.C.S.

THE author had examined several seams of coal from England and America. He pointed out that they were not always made up of one continuous bed of coal, but often comprised several distinct beds. In the case of the well-known Welsh 'four feet' seam there were four distinct strata of coals, separated by clay beds of a few inches thick. In the case of the 'Splint Coal' from Whitehill Colliery, near Edinburgh, the seam presented three clearly defined beds of coal, but these were not separated by partings of any kind.

With a view of testing the 'Spore Theory' of the origin of coal, as propounded by Professor Huxley, the author had obtained a portion of the 'better bed' seam intact for a thickness of 10 inches from the top. He had examined this inch by inch, by preparing thirty-three microscopic sections. At the top was  $3\frac{1}{2}$  inches of dull lustrous coal, termed 'laminated coal.' This the author found to be practically a mass of macrospores and microspores. Below this there was a change in the character of the seam. Spores became less numerous; in places they were scarce, the mass being made up of vegetable tissue and a substance to which the author gives the term 'hydrocarbon.' He could not, therefore, support Professor Huxley in saying that the 'better-bed' coal was 'simply the sporangia and spore cases of plants.' The assertion would, however, apply to the first  $3\frac{1}{2}$  inches of the seam. The 'splint coal' from Whitehill Colliery was a better example of a spore coal than the 'better-bed.' The bottom stratum was 4 inches thick, and presented a dull lustre with thin bright layers traversing at intervals. The dull portion was a mass of spores and spore cases, but these did not enter the bright layers. A vertical section cutting a bright layer, bounded on either side by dull lustrous coal, showed plenty of spores in the dull coal, but in the bright not one was detected. The second bed in this seam was 1 foot thick; it was of a brighter lustre than the 4 inches below, but two layers could be distinctly made out, one more lustrous than the other. In the duller of the two spores were found, which, however, were less numerous than in the bed below, and were, also, of a different variety. In the bright layers the spores were absent. The top bed of the seam was also 1 foot thick, and might be defined as a mass of spores, chiefly microspores, except in the bright layers.

The American coals examined were collected by the author from the Warrior Coalfields of Alabama, and from near Pittsburgh, Pennsylvania. The same structural affinities were noticed as in the English coals, and the author therefore came to the conclusion that the English and American Carboniferous coals had a common origin.

The spores in the coal from both countries were closely allied. Some microspores from Alabama were identical with those which occur in the lower bed of the Welsh 'four feet' seam. A feature in spores obtained from all the coals was the triradiate markings which they exhibited. Whether this was to be regarded as superficial or not, it was very characteristic of them, and was, therefore, to be considered in attempting to ally them with modern vegetation.

The author regarded peat in the light of Post-Tertiary coal; lignite as peat in a transition state to coal; and coal as the remains of Carboniferous bogs.

The author referred to the practical application of a knowledge of the microscopic structure of coal, as enabling an expert to judge of the nature of a coal from an examination of it with a pocket lens.

#### 16.—ON THE MODE OF OCCURRENCE OF PRECIOUS STONES AND METALS IN INDIA.

By V. BALL, M.A., F.R.S.

FOR full 3000 years India has been known as the source of precious stones and metals, but scarcely 200 years have elapsed since other countries yielding precious stones have entered into competition with her; and it is only within the present century that she has ceased to hold a pre-eminent position as a supplier of the markets of the world.

In order to arrive at a full and satisfactory elucidation of this subject, two branches of inquiry must be undertaken, one based upon what has been actually ascertained by careful geological exploration of the country, and the other upon such historical records as are available of the former production of the minerals in question, and of the indications of the sites where they were mined.

By means of our present knowledge of the geology, it has become possible to give definite form to many vague statements by early writers, and to recognize the actual positions of mines which are now, by the people of the localities themselves, forgotten and deserted. In the majority of these cases, had the geologist not got the historical hand to guide him, he would be unwilling to predicate the presence of such minerals from mere superficial examination.

As a collateral result, many of the widespread myths and fables connected with mining have proved to have originated in peculiar local customs. They rest, therefore, on more substantial bases of facts than could have been suspected by any one unacquainted with these customs.

This method of combining the results of geological research with historical records the author has found on previous occasions to have the advantage of bringing the geologist into touch with the rest of humanity, arranging as it does the interest of historians, linguists, and others, who find in the facts so presented to them pabulum applicable to the requirements of their own particular pursuits.

In this paper it will not be necessary or suitable to enter at length into details—the author having done so elsewhere.<sup>1</sup> His object is

<sup>1</sup> 'Economic Geology of India,' and 'A Geologist's Contribution to the History of India,' Proc. Roy. Soc. 1883.

rather to direct attention to the subject generally, and to make known the fact that much has been accomplished of late years, which has not as yet found its way into manuals and encyclopædias. Most of the information to be found in such works is far behind our present knowledge; and, where not actually incorrect, has been superseded by fuller and more accurate observations. The subjects taken for special consideration are the following:—Diamond, ruby, sapphire, spinel, beryl, emerald, lapis-lazuli, gold, silver. The steel of India, or *wootz*, might be included here, since at least 2000 years ago it was one of the most precious productions of India.

17.—POINTS OF DISSIMILARITY AND RESEMBLANCE BETWEEN  
ACADIAN AND SCOTTISH GLACIAL BEDS.

By RALPH RICHARDSON, F.R.S.E., Vice-President G. S. Edinb.

MR. RICHARDSON said that, in his 'Acadian Geology,' Sir J. W. Dawson gave the following as a typical section of the superficial geology of Acadia—that is, Nova Scotia, New Brunswick, and Prince Edward's Island—and as, in some respects, also applicable to Canada and Maine, viz. at the bottom, peaty deposits; then unstratified Boulder-clay; then stratified Leda-clay, indicating deep water; and, lastly, gravel and sand beds, the Saxicava-sand indicating shallow water. Mr. Richardson pointed out wherein such a section differed from and resembled the glacial beds of Scotland. He said the latter showed no such orderly arrangement as the Acadian, and could not, as a rule, be divided into deep and shallow waterbeds. The marine shells in the Scottish beds are all mixed up together, regardless, as a rule, of the province—whether Arctic or British or both—to which they properly belong, regardless of the depths which they usually tenant, and regardless of the deposit (whether clay, gravel, or sand) in which they are now found fossil. They are likewise met with at all heights, from the level of the sea to more than 500 feet above it. No system of dispersion of boulder-erratics from definite centres in Scotland seems as yet ascertained. The peaty deposits occurring in Sir J. W. Dawson's section *below* the Boulder-clay or till, occur in Scotland *above* it. With regard to points of resemblance, the facies of the shells in Acadia and Scotland is similar, being of the Arctic and British-Arctic type. Again, both in Acadia and Scotland, all the fossiliferous glacial beds occur above the unstratified Boulder-clay or till. Mr. Richardson cited various Scottish sections to prove this, and remarked that the belief in earlier and later Boulder-clays is of long standing in Scotland. He concluded by pointing out that, in their cardinal features, the Acadian and Scottish glacial beds seem to coincide. In both Acadia and Scotland that great mass of unstratified clay known as *till* existed; and, doubtless, the geologists of the New World were, like those of the Old, puzzled to account for its origin with certainty and satisfaction. The question was left unsolved by the meeting of the British Association in Edinburgh in 1850; although then discussed by Hugh Miller and Professor John Fleming. The author hoped that during

the present meeting some advance would be made in solving this great problem, as well as in correlating and arranging the glacial beds of Canada, Acadia, and Britain.

18.—ON THE OCCURRENCE OF THE NORWEGIAN 'APATITBRINGER' IN CANADA, WITH A FEW NOTES ON THE MICROSCOPIC CHARACTERS OF SOME LAURENTIAN AMPHIBOLITES.

By FRANK D. ADAMS, M. Ap. Sc., Assistant-Chemist and Lithologist to the Geological Survey of Canada.

THE paper first gives a short account of the investigations which have been made on this amphibole-scapolite rock in Norway, where all the principal deposits of apatite either traverse it, or occur in its immediate vicinity. The deposits of apatite in Canada generally occur associated with some variety of highly pyroxenic rock, often holding orthoclase and quartz.

The 'Apatitbringer' has, however, recently been found in the vicinity of the town of Arnprior on the river Ottawa. It closely resembles the Norwegian rock, both in external appearance and in its microscopic characters, containing hornblende, scapolite, and pyroxene as essential constituents. A number of amphibolites in the museum of the Geological Survey of Canada, which resemble this rock in appearance, have been sliced and examined with the microscope, and one of them found to contain scapolite in large amount. It was collected at Mazinaw Lake, in the township of Abinger, and is from the same belt of hornblendic rocks as that in which Arnprior is situated. The paper closes with a short account of some of these amphibolites.

19.—UPON THE IMPROBABILITY OF THE THEORY THAT FORMER GLACIAL PERIODS IN THE NORTHERN HEMISPHERE WERE DUE TO ECCENTRICITY OF THE EARTH'S ORBIT, AND TO ITS WINTER PERIHELION IN THE NORTH.

By W. F. STANLEY, F.G.S., F.R. Met. Soc.

THE theory of Dr. Croll, accepted by many geologists, is that former glacial periods in the Northern hemisphere were due to greater eccentricity of the earth's orbit, and to this hemisphere being at the time of glaciation in winter perihelion. This theory is supported upon conditions that are stated to rule approximately at the present time in the Southern hemisphere, which is assumed to be the colder. Recent researches by Ferrel and Dr. Hann, with the aid of temperature observations taken by the recent Transit of Venus expeditions, have shown that the mean temperature of the Southern hemisphere is equal to, if not higher than, the Northern, the proportions being 15.4 Southern, 15.3 Northern. The conditions that rule in the South at the present time are a limited frozen area about the South Pole, not exceeding the sixtieth parallel of latitude; whereas in the North frozen ground in certain districts, as in Siberia and North-Western Canada, extends beyond the fiftieth parallel; therefore by comparison the North, as regards the latitude in which Great

Britain is situated, is at present the most glaciated hemisphere. As it is very difficult to conceive that the earth had at any former period a lower initial temperature, or that the sun possessed less heating power, glaciation in the North could never have depended upon the conditions argued in Dr. Croll's theory. The author suggested that glaciation within latitudes between 40° to 60° was probably at all periods a local phenomenon depending upon the direction taken by aerial and oceanic currents; as, for instance, Greenland is at present glaciated, Norway has a mild climate in the same latitude, the one being situated in the predominating Northern Atlantic currents, the other in the Southern. Certain physical changes suggested in the distribution of land would reverse these conditions, and render Greenland the warmer climate, Norway the colder.

20.—ON SOME REMAINS OF FISH FROM THE UPPER SILURIAN ROCKS OF PENNSYLVANIA.

By Professor E. W. CLAYPOLE, B.A., B.Sc. (Lond.), F.G.S.;  
of the Second Geological Survey of Pennsylvania.

THE earliest vertebrate animals yet known from any part of the world are some remains of fish in the Upper Silurian rocks of England.<sup>1</sup> They are for the most part of three types. First, short fish-spines, named by Agassiz *Onchus tenuistriatus*; second, fragments of shagreen, or the skin of a placoid fish (*Thelodus* and *Sphagodus*), belonging probably to the same that carried the spine; and third, ovate, finely-striated plates or shields, supposed to be the defensive armour of some fish, unlike any now living.

No one has doubted the ichthyic nature of the first and second of these three forms. But as regards the third there has been much controversy. Evidently allied to *Cephalaspis*, its right to the name of fish has been called in question, and suspicion has been raised in regard to the whole family of the Cephalaspids.

On the whole, however, it seems best to retain them in the class of fishes, and to this conclusion Professor Huxley evidently inclines in the conclusion of his "Essay on the Classification of the Devonian Fish." One may expect some, or even considerable, divergence of structure from the usual ichthyic types in such early forms.

These English fossils occur in the lowest beds of the Devonian (Cornwall), and in the highest beds of the Silurian (Shropshire and Hereford). The well-known Upper Ludlow "bone bed" has yielded them in considerable quantity, and one specimen is reported by Sir C. Lyell in his "Elements of Geology" (1865) as discovered from the Lower Ludlow, beneath the Aymestry limestone. Below this horizon I have never heard of their occurrence.

The English Ludlow, taken as a whole, has been usually correlated with the Lower Helderberg of North America, and on good grounds,

<sup>1</sup> The oldest known Fossil Fish-remain in Britain was obtained by Mr. J. E. Lee, F.G.S., in 1859, from the Lower Ludlow Beds, of Church Hill, Leintwardine, Shropshire (see Lankester's Mon. Foss. Fish. Pal. Soc. 1867, p. 25). It is referred to the genus *Scaphaspis* (see Annals and Mag. Nat. Hist. 1859, p. 45, and "Geologist," 1860, vol. iii. p. 79).

both containing *Eurypterus* and *Pterygotus*. The English Lower Ludlow and the Water-Lime or basal beds of the North American Lower Helderberg are the lowest strata containing these fossils. On both sides of the Atlantic they range from this level upwards into the Devonian.

The oldest vertebrate fossils yet announced from America are those found in the Corniferous Limestone or Lowest Devonian of Ohio. Possibly the beds at Gaspé on the Gulf of St. Lawrence are somewhat lower, as they have yielded *Cephalaspis*, which is not yet known from Ohio, and *Cocosteus*, of which Ohio has yielded only a single specimen. No authenticated fish-fossil has yet been announced from the Upper Silurian rocks of America.

It is true that reports of the discovery of such remains have been published at various times, but investigation has proved them all erroneous. (See "Palæontology of New York," vol. ii. pp. 319, 320, pl. lxxi.; "American Journal of Science," second series, vol. i. p. 62; "Palæontology of Ohio," vol. ii. p. 262.)

During my recent work on the Palæontology of Perry county, Pennsylvania, I came upon some fossils which at once suggested relationship to the Ludlow group above described. Among them were a few spines recalling *Onchus tenuistriatus*, but with some differences. I have named them *Onchus Pennsylvanicus*. With them I discovered abundance of specimens bearing a strong resemblance to *Pteraspis*, but larger, and differing in some other respects. These I have named *Glyptaspis* (*G. elliptica* and *G. bitruncata*).

Comparing these with *Pteraspis*, we find them much thinner, not exceeding one-tenth of an inch in thickness; whereas specimens of *Pteraspis* in my possession from Cornwall are nearly one-fourth of an inch thick. The striation on both is equally fine, but is rather less regular on the American specimens. These also show no trace of the spine in which the shield of *Pteraspis* terminates, as shown by Murchison in "Siluria."

No traces of the English fossil shagreen—*Thelodus* and *Sphagodus*—have been found in the Pennsylvanian beds, though it abounds in the Ludlow rocks.

The fossils were found in a bed of sandstone about 200 feet below the base of the Water-Lime in Perry county, Pennsylvania; near the top of the great mass of variegated shale composing the Fifth Group of Rogers in the First Survey of Pennsylvania. This shale in New York immediately overlies the Niagara limestone, which is correlated on satisfactory evidence with the Wenlock limestone of England. Ten or twelve species are common to the two beds.

It seems, therefore, that the great mass of coloured shale, near the top of which these fossils were found, and which is a continuation of the Onondaga group of New York, has no representative in the British series, but corresponds to an interval between the Upper Wenlock and the Lower Ludlow. (For details regarding the correlation of these beds in Pennsylvania with those in New York, see a paper by the author in "Proc. Amer. Phil. Soc." for 1884.)

It is consequently a necessary inference that the beds yielding

*Glyptaspis* and *Onchus* in Pennsylvania are somewhat older than those containing *Pteraspis* and *Onchus* in England.

Microscopic examination of the specimens, and a comparison of their structure with that of *Pteraspis* and *Cephalaspis*, are in progress, and the details will be given in the paper. Other fossils in the author's possession indicate the possible existence of fish at a still earlier date, but the material is not yet worked out.

21.—THE OCCURRENCE, LOCALITIES, AND OUTPUT OF THE ECONOMIC MINERALS OF CANADA.

By WILLIAM HAMILTON MERRITT, F.G.S.;  
Associate Royal School of Mines, etc.

IN this paper an endeavour was made to collect from the maps of the Geological Survey the number of localities where the various economic minerals found in Canada are situated, and the geological formation in which the occurrences exist.

From the Trade Navigation Returns, and the Annual Mining Report of Nova Scotia, the mineral output for the past year has been compiled in order to show the present condition of mining industry in Canada.

The lack of encouragement and assistance to the mining industry, from the non-existence of any department in the Central Government for collecting reports and statistics on mining, was very forcibly alluded to.

The paper was accompanied by a list of the principal localities of the economic minerals of Canada and the geological formation in which they occur. This list showed that the indications of valuable ores are very numerous and widespread from Newfoundland on the Atlantic to British Columbia on the Pacific Ocean. The chief yield is shown to be from Coal, Gold, Iron, Gypsum, Apatite and Copper.

It was also pointed out that it was not intended to convey the idea that the different minerals were limited to the localities mentioned. They ought more to be looked upon as a few indications of an exceptionally large mining development which is hopefully looked forward to in the near future.

22.—ON THE ARCHÆAN ROCKS OF GREAT BRITAIN.

By Prof. T. G. BONNEY, D.Sc., LL.D., F.R.S., Pres.G.S.

THE author in this paper (which by order of the General Committee will be printed *in extenso* among the Reports of the Association in the volume for 1884) describes the lithological characters of the various rock groups in Great Britain which have been regarded as Archæan, giving also a brief sketch of the stratigraphical and other arguments which have led geologists to consider them more ancient than the Cambrian strata. The paper contains notices of the following districts:—The Lizard region, Cornwall; South Devon; Malvern Hills; the Wrekin; the Lickey Hills; the Hartshill Ridge; the Charnwood Forest Region; Pembroke-shire, Carnarvonshire and Anglesey; the Scotch Highlands.

The author, through want of personal knowledge and sufficient information, had been obliged to exclude from the paper the Archæan rocks of Ireland. In conclusion, he briefly described the resemblances which he had noticed between the Archæan rocks of Canada and those of Britain, viz. that the Lower Laurentian of the former country closely resembled the Hebridean of N. W. Scotland, and the older gneisses of the Central Highlands: the non-igneous members of the Upper Laurentian, so far as he knew them, had not specially recalled to him any British rocks. The Montalban series of Dr. Sterry Hunt reminded him of some of the Eastern gneisses of Scotland. The typical Huronian of Canada much resembled the Pebidian of Wales, and probably like it, was a series rather older than the Cambrian. Dr. Hunt had even shown to him specimens of red felsites from the 'petrosilex group' of Canada, which very closely resembled those from North Wales called Arvonian by Dr. Hicks, and regarded by the author as belonging to the lower part of the Pebidian.

### 23.—PHASES IN THE EVOLUTION OF THE NORTH AMERICAN CONTINENT.

By Prof. J. S. NEWBERRY;  
of Columbia College, New York.

AS the day had been assigned to papers bearing on the Ice Period, Dr. Newberry limited his remarks to the condition of North America during the Tertiary and the Glacial age. He exhibited a map of North America on which the areas where glacial *debris* or inscriptions had been found were coloured white. This showed more than half of the Continent in the Glacial epoch was covered with perpetual snow or ice. The margin of the drift area passed from Newfoundland by George's Bank to Cape Cod, thence traversed the middle of Long Island, crossed Staten Island near its southern extremity, and New Jersey near Trenton. Thence it was deflected northward through Pennsylvania, forming an angle in the southern part of Western New York, thence passing diagonally across Ohio to Cincinnati, reaching (as recently shown by Prof. G. F. Wright) into Kentucky, thence running north-westerly or westerly through the States of Indiana and Illinois into Missouri, whence it followed nearly the course of the Missouri river to the Canada line.

All the country included in this semicircle has been glaciated, its topography profoundly modified, and the surface of a belt surrounding the Canadian Highlands 2000 miles in length by nearly 500 in breadth, covered with a sheet of *debris*, which, after much erosion, is still from 30 to 50 feet in thickness. On the mountain ranges of the west conspicuous evidence of glacial action is visible as far south as the north line of New Mexico. These phenomena afford conclusive proof of the reality of the Ice Period, and that the present climate and physical conditions of Greenland reached in that age as far south as New York and Cincinnati. The elevation of the Continent was at that time less than at present, since the Champlain clays—the fine material ground up by the glaciers and washed down to the ocean—reached the sea-level about New York. At Croton Point, on the Hudson, they rise to 100 feet; at Albany 200; in



the Champlain Valley 350; at Montreal 500; in Labrador 800; at Davis Strait 1000; and at Polaris Bay, as reported by Dr. Bissell, 1600 feet above the ocean-level.

These clays contain Arctic shells from New York to Greenland, and hence are shown to have been deposited during the Ice Period.

The elevation of the northern portion of the Continent during the Tertiary—when land connection existed between America and Asia, and between America and Europe, while a mild climate prevailed at the north—and the depression of the northern half of the Continent during the Ice Period, make it impossible to accept the Lyellian hypothesis of topographical changes as causes of these differences of climate, and compel us to look to some extraneous influence for the cause of the cold of the Ice Period.

24.—ON THE RECENT DISCOVERY OF NEW AND REMARKABLE FOSSIL FISHES IN THE CARBONIFEROUS AND DEVONIAN ROCKS OF OHIO AND INDIANA.

By Prof. T. S. NEWBERRY, Columbia College, New York.

THE fishes described by Dr. Newberry consisted of:—

1. Two new species of *Dinichthys* from the Huron Shale (Upper Devonian) of Northern Ohio. Of these one is considerably larger than either of the two gigantic fishes described in the Geological Report of Ohio under the names of *Dinichthys Herzeri* and *D. Terrelli*, the cranium having a breadth of 3 feet 8 inches. This is about one-third larger than the largest specimen of *Dinichthys* before known, and two or three times as large as *Asterolepis* of Hugh Miller and *Heterosteus* of Pander, its congeners. Another is a small species of *Dinichthys*, of which the dorso-median plate is only five inches in breadth and six in length. The mandibles are not more than six to eight inches in length, but are much worn by long use, indicating maturity.

2. The pavement teeth of a gigantic ray, *Archæobatis gigas*, Newb., from the Lower Carboniferous of Indiana; the largest tooth is over six inches long by four wide, and one and a half thick. These teeth formed several rows in the mouth above and below; in shape they resembled the teeth of *Psamodus*, but the enamelled surface was strongly ridged, to prevent the slipping of mollusks, crustacea, etc., which formed the food of the fish.

3. *Diplognathus mirabilis*, Newb., a new genus and species, in which the mandibles, set along the anterior portion with conical teeth, diverge at the symphysis, forming a fork which carries another row of strong, acute, recurved teeth. As such a forked jaw would be liable to be split, the rami were united at the symphysis by a strong ligament, deeply inserted in each bone. This apparatus, admirably adapted to catching slender and slippery fishes, is different from anything hitherto known among vertebrates.

4. The teeth of several species of *Mylostoma*, Newb., a new genus of fishes, probably allied to *Dinichthys* on the one hand, and to *Ctenodus* on the other, in which the under jaw was provided with one or more pairs of powerful crushing teeth, somewhat like a shoe-

last in form, which played upon strong, flattened, bony plates that covered the roof of the mouth. These, like *Diplognathus*, are from the Huron Shale of Ohio.

5. *Ctenodus Wagneri*, Newb., of which a remarkably large and finely preserved palate tooth was exhibited, discovered by Mr. Frank Wagner in the Cleveland Shale, near the base of the Carboniferous system at Cleveland, Ohio.

6. Spines of two species of *Edestus*, Leidy, from the Coal Measures of Indiana and Illinois, which show distinctly the structure and mode of growth of these remarkable defensive weapons. They are from 10 to 18 inches in length, very massive and strong, and consist of a series of sheathing segments, finely soldered together, each carrying a triangular, crenulated and enamelled denticle from one to two inches in length.

The spines are symmetrical, and were therefore located on the median line like the spines of *Trygon*, and were probably the defences of large sharks or rays which inhabited the inland waters of the Continent in the Carboniferous age.

---

## CORRESPONDENCE.

---

### THE SECTION AT HOPE'S NOSE.

SIR,—In the last number of the GEOLOGICAL MAGAZINE (p. 398), the Rev. O. Fisher gives a good diagrammatic section at Hope's Nose near Torquay, which he and also Mr. Pengelly interpret as showing an unconformity. I examined this section in 1875, and believe that the apparent unconformity is due to a fault whose hade is inclined inwards from the face of the quarry; this explanation was given in a former Number of the MAGAZINE (Decade II. Vol. IV. p. 453). Besides being a simpler reading of the section than that furnished by Mr. Pengelly, it accords with his statement of "the specific identity of the numerous fossils in the two series" of rocks; and, may I add that, if I remember rightly, Mr. J. E. Lee informed me soon after I had seen the section, that he had arrived at a similar conclusion respecting it. It is perhaps needless to remark that this interpretation in no ways affects the interesting observations on cleavage made by Mr. Fisher.

HORACE B. WOODWARD.

HIGHBURY, 13th Sept. 1884.

---

### REPORT UPON THE NATIONAL GEOLOGICAL SURVEYS OF EUROPE.

SIR,—I should be obliged if you would allow me to state that the "Report" printed in the last Number of the GEOLOGICAL MAGAZINE is from a "proof under correction." Some corrections are needed in this, which will be given, with some additions, in the British Association Report for 1884.

W. TOPLEY.

GEOLOGICAL SURVEY OFFICE, JERMYN STREET, S.W.,  
Oct. 11, 1884.

---

## MR. FISHER'S REJOINDER TO MR. T. MELLARD READE.

SIR,—In my letter, at p. 431, on "The Permanence of Ocean Basins," I said that South Georgia might fairly be excluded from the category of Oceanic Islands, as having been perhaps formerly joined to South America. The bearing of this upon the question seems to me to be that, if it had not been formerly connected with some still existing continent, it might be argued that it had belonged to a submerged one. But if it formed once part of one now existing, that conclusion would not be necessary. Moreover, it stands a witness to the antiquity of South America, because of the length of time which must have been occupied in the destruction of the connecting land.

Those who believe in the doctrine of permanence do not assert that the continents have always had their present size or shapes, but only that, on the whole, they have not changed places with the oceans.

O. FISHER.

HARLTON, CAMBRIDGE, 6th Oct.

## THE CLASSIFICATION OF THE JURASSIC SYSTEM.

SIR,—The GEOLOGICAL MAGAZINE for July contained a short paper by Mr. Blanford on the Classification of Sedimentary Strata, with a Table, which aimed at the simplification of our present stratigraphical nomenclature. None of our geological systems stand more in need of revision and simplification than the Jurassic, and I think many will welcome the suggestion that this system should be divided into three sections or stages, and three only,—an Upper, Middle, and Lower, as Mr. Blanford proposes.

An Oolitic system, as separate from the Lias, is quite unnecessary, and it would be desirable that the term Oolite should be used only as a lithological appellation for a particular kind of rock, though there can be no objection to the retention of such compound names as Inferior Oolite and Great Oolite for groups which are chiefly composed of oolitic limestones. But let the name "Lower Oolites" be banished from our text-books. I can recollect the time when it was a trouble to remember that Inferior Oolite was not the same as Lower Oolite, and I cannot but think that the abolition of this possible source of confusion would be a benefit to young students of geology.

I feel confident that the divisions or stages of Upper, Middle, and Lower Jurassic will be ultimately accepted, but I venture to differ from Mr. Blanford in the manner of grouping the minor subdivisions under these heads.

The Lower Jurassic is of course synonymous with the Lias. The Middle stage should, in my view, comprise the overlying beds up to and no farther than the Cornbrash, and should certainly not include the Oxford Clay. The Cornbrash is a well-marked and nearly continuous horizon in England, and forms the natural summit to a group which is essentially composed of oolitic limestones. With the Oxford Clay, which includes the Kelloway rock near its base, begins a series which is essentially argillaceous or

*pelolithic*, except in its upper portion, if the Portland and Purbeck beds are comprehended in the same stage. The Coral Rag is only an episode in the pelolithic series; it is absent throughout a distance of nearly 120 miles, and over this tract there is a complete passage from the Oxford into the Kimmeridge Clay, and a commingling of their respective faunas. No arrangement therefore will be natural which separates these two clays.

Lastly, if alternative names are required for the three stages of the Jurassic system, such as are suggested by Mr. Blanford for the similar stages of the other systems, I would propose the name *Clavinian* (from Clavinium, the ancient name of Weymouth) for the upper stage, the type of which is found in Dorsetshire and within easy access from Weymouth. For the middle stage or Gloucestershire Oolites, as they have been called, what more appropriate name can be found than one derived from the city which gives its name to the county, namely, *Glevonian*. For the lower stage the term *Liassian* already adopted on the Continent may perhaps suffice.

I append a tabular view of this classification, in which it will be seen that the Upper Jurassic simply combines what are now called the Middle and Upper Oolites. This arrangement has also the advantage of being in complete accord with that adopted by Credner for Germany.

|             |                                 |   |                                                                                     |
|-------------|---------------------------------|---|-------------------------------------------------------------------------------------|
| JURASSIC. { | Upper<br>or <i>Clavinian</i> .  | { | Purbeck group.<br>Portland group.<br>Kimmeridge Clay.<br>Coral Rag.<br>Oxford Clay. |
|             | Middle<br>or <i>Glevonian</i> . | { | Great Oolite and Cornbrash.<br>Inferior Oolite.<br>Midford Sands or Dogger.         |
|             | Lower<br>or <i>Liassian</i> .   | { | Upper Lias.<br>Middle Lias.<br>Lower Lias.                                          |

TRING, Oct. 2, 1884.

A. J. JUKES-BROWNE.

## OBITUARY.

### DR. FERDINAND VON HOCHSTETTER.

For. Corr. Geol. Soc. Lond., Director of the Imperial Mineralogical Museum, Vienna.

BORN 30TH APRIL, 1829: DIED 18TH JULY, 1884.

AT the close of last year we recorded the death of the illustrious geologist Barrande (see *GEOL. MAG.* Dec. 1883, pp. 529-533). In Dr. Ferdinand von Hochstetter, Austria has again suffered a severe loss, and the world of science mourns the death of one of its most distinguished members. The subject of our memoir was born at Esslingen, Wurtemberg, on 30th April, 1829. His father was an Evangelical clergyman and Professor at Brünn, and published several Botanical works and a Handbook of Mineralogy. To his father was doubtless due his first impulses towards the study of Natural Science: for although he commenced his education

in the Evangelical Seminary at Maulbronn, and later on as an "Exhibitioner" at the University of Tübingen, he speedily recognized his true vocation as a Geologist. He always attributed his most valued scientific teaching in early life to Professor F. A. Quenstedt, whose suggestive instruction greatly influenced the direction of all his later work.

After obtaining his Doctor's degree, Hochstetter received a "Travelling Scholarship" which enabled him greatly to extend his scientific knowledge.

In 1852 Prof. von Haidinger invited Hochstetter to visit him in Vienna, and offered him a post on the Imperial Geological Survey of Austria. From this time Vienna became his home and the centre of his scientific labours.

From 1852 to 1856 Hochstetter was at first engaged as Assistant and latterly as Geologist-in-Chief on the Survey of South-west Bohemia, especially in the Böhmerwald, and in the Fichtel and Karlsbad Mountains.

His work in this district is considered amongst the best which the Survey has produced. It was published in the Annual Volumes IV. to VI. and resulted in making Hochstetter's name celebrated among geologists, and in establishing the reputation of the Austrian Survey. He popularized the work by articles "On the Bohmerwalde" (in the *Angsburg News*, 1855) and "On Karlsbad, its Geological Situation and Springs" (in 1856).

The next important period of Hochstetter's life, that from 1857-1859, was occupied by the "Novara Expedition," of which he was chosen as geologist. A voyage round the world with but short stoppages at distant and isolated stations might serve for general scientific investigation, but afforded but little opportunity for the geologist. How admirably Hochstetter turned these stoppages to account is seen by the first chapter of the Geology, forming vol. ii. of his Travels. This volume (with palæontological contributions by Prof. Reuss and Dr. Schwager) was published in 1866. Among the places noticed geologically may be specially mentioned Gibraltar, Rio Janeiro, Cape of Good Hope, the Island of St. Paul, New Amsterdam, Nicobar, Java and Stewart's Atoll in the Pacific.

In January, 1859, Hochstetter, with the consent of his chief, separated himself from the "Novara Expedition" at Auckland, having arranged with the Government of New Zealand to make a rapid survey of this British Colony. He first spent six months in gaining a general geological knowledge of the North Island, and devoted another three months to the investigation of the South Island. From thence Hochstetter returned *viâ* Australia, where he visited the Gold-fields of Victoria, back to Europe.

The scientific results of this undertaking appeared in the first volume of the "Geology of the Novara Expedition" (1864), viz. :— I. The geology of New Zealand by Dr. F. von Hochstetter, and II. The palæontology by F. Unger; K. Zittel; E. Suess; F. Karrer; F. Stoliczka; G. Stache; and G. Jäger: (and in the edition by J. Perthes, of Gotha, is added a topographical Atlas of New Zealand,

by Dr. F. von Hochstetter and Dr. A. Petermann). Hochstetter also published both in German and in English his "Travels in New Zealand" (Stuttgart, 1863). During the Novara Expedition he wrote and sent home reports of his travels which were published in 42 numbers of the "Wiener Zeitung."

Within two months after his return (on the 29th of February, 1860) Hochstetter was appointed Professor of Mineralogy and Geology in the Royal and Imperial Polytechnic Institute in Vienna, a post which he held until 1874. Here he published a Text Book of Mineralogy and Geology, which completed its 5th edition in 1884. In 1869 he was invited to study the geology of the country along the lines of railway then in construction between Constantinople and Belgrade, in company with the engineers and surveyors. The result of his researches, with appropriate maps and sections, appeared in the *Jahrbuch der k.k. geol. Reich.* Vienna (1870, Bd. xx. and 1872, Bd. xxii.), and was very fully noticed in the *GEOL. MAG.* Vol. VIII. 1871, pp. 466-473, and Vol. X. 1873, pp. 274-277.

In 1872 Hochstetter undertook with Prof. Toula a journey through Russia to Boguslow and Turjinsk on the eastern side of the Urals.

He was made president of the k.k. Geological Society of Vienna in 1867, a post which he held until 1882, when he resigned the chair through ill-health.

Hochstetter was selected in 1872 by the Emperor of Austria as tutor in natural history to H.S. Highness the Crown Prince Rudolph.

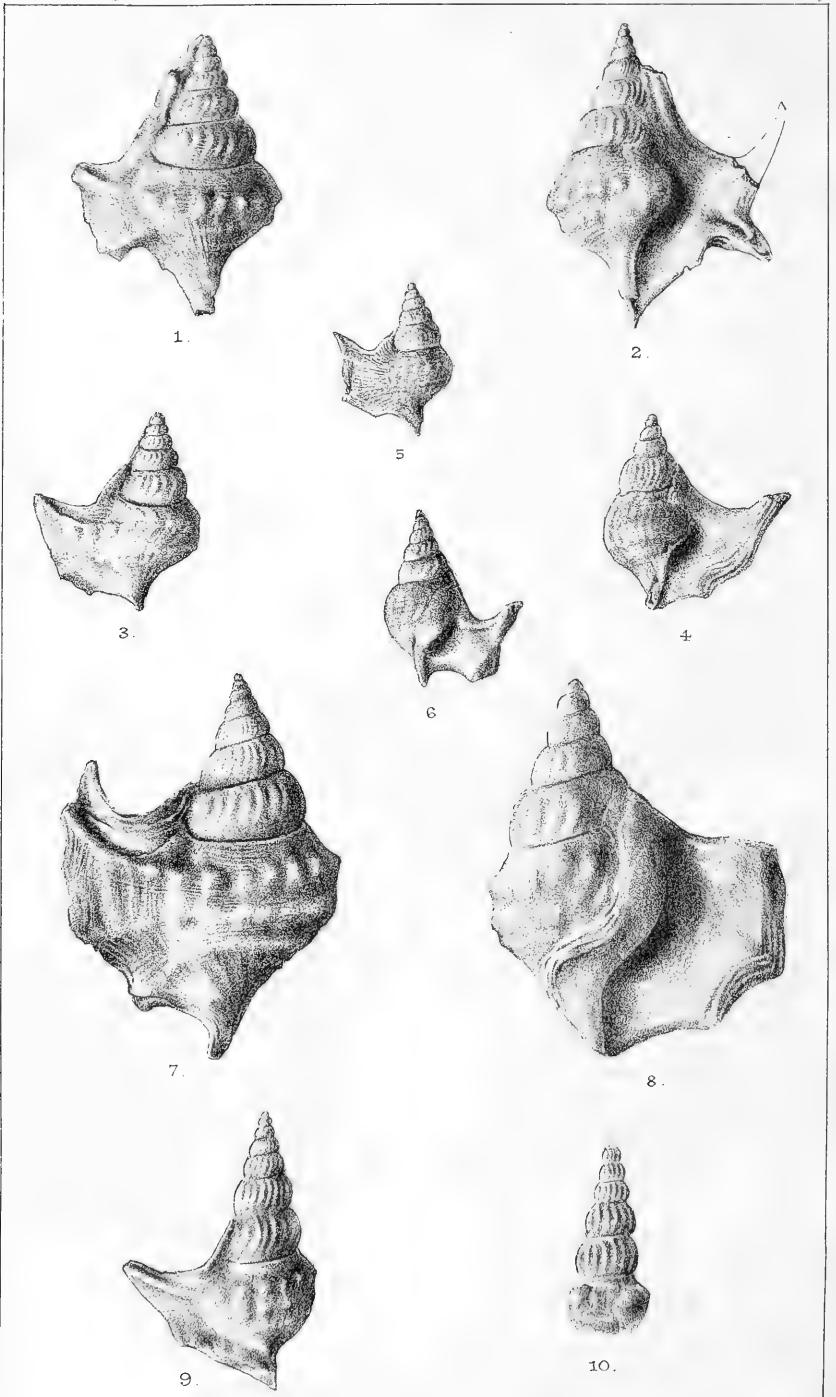
Some idea may be formed of the versatility of Prof. von Hochstetter's genius from the scientific subjects which are embodied in his publications.

Besides those already enumerated may be cited " 'Earth-oil' and 'Earth-wax' in the Sandecer District, Galicia" (1865), "On the alleged Trachyt-find of Ortler" (1865), "Deep-soundings in the lake of Kärnten" (1865), "On the Slate-quarries of Maria-thal in Hungary" (1866), "On the Eozoon of Kruman," "On the Coal and Iron-works of Anina-Steyerdorf" (1867), "Section through the North side of the Bohemian Chalk Formation from Wartenberg to Turnau" (1868), "Reptilian Impressions in the 'Rothliegende' of Rossitz-Aslawan" (1868), "Rhinoceros-remains from Grassengrün in Bohemia" (1871), "Orthoclase crystal of Koppenstein in the Carlsbad Mountains" (1872), "Remains of *Ursus spelæus* in the Igritzer Cave in Bihar, Hungary" (1875), "*Cervus megaceros* of Nussdorf" (1875), "The Earthquake of Peru on Aug. 13th, 1868," and "The Tide-wave in the Pacific Ocean from 13th to 16th August," "Experiments on the internal structure of Volcanos and on the Miniature Volcanos of Schwefeld" (1870).

In 1876 he was made Superintendent of the k.k. State Natural History Museum in Vienna, and was occupied incessantly in its reorganization until the day of his death, July 18th, 1884.

His loss will be keenly felt by a large circle of friends in Austria and elsewhere, by whom Prof. Hochstetter was warmly appreciated and justly admired.







THE  
GEOLOGICAL MAGAZINE.

NEW SERIES. DECADE III. VOL. I.

No. XII.—DECEMBER, 1884.

ORIGINAL ARTICLES.

I.—BRITISH EOCENE APORRHAIÐÆ.

By J. STARKIE GARDNER, F.L.S., F.G.S., etc.

(PLATE XVII.)

NEARLY ten years ago it was my privilege to describe the British Cretaceous forms of this Family in the GEOLOGICAL MAGAZINE. The Family was seen to be capable of subdivision into at least five well-marked genera, and to these a sixth very singular and remarkable one from Aix-la-Chapelle, and also represented at Blackdown, may be added. It was then that the Family reached its zenith, and in the still later Cretaceous rocks of Europe, as a flame burns brightest near its end, so some species suddenly assumed relatively gigantic proportions, and as suddenly became extinct. A few survived in America down to that much later period, the close of the so-called Cretaceous series on that continent. Only two types lived on to the present day and only one of these has ever since Cretaceous times been represented in our area.

Turritid Gasteropods, with wing-like expansion of the shell, first appear in the Middle and Upper Lias in France, but have not been found in England in any rocks older than the Jurassic. Several species were figured from the latter by Mr. W. H. Hudleston, F.R.S.,<sup>1</sup> showing how remarkably little modification some types reappearing in the Cretaceous had undergone, and carrying our knowledge of the British species back a very considerable stage. We thus see that with the exception of the patelliform, heliciform, and trochiform groups, the present is the most venerable for its antiquity. The present paper will go far towards completing our knowledge of the life-history of the Family in British strata, for in post-Eocene rocks only slight modifications of the still existing species are met with.

The Eocene group is composed of forms differing so slightly from each other, that were the assemblage an existing one, we should hardly hesitate to regard them all as coming well within the range of variation of a single species. All belong to an ancestral type of the living *A. pes-pelecani*, and thus to the true genus *Aporrhais*. For all biological purposes this statement might suffice, but in dealing with fossils, other points have to be considered. They must be so described that the general tendency and direction of the successive

<sup>1</sup> See GEOL. MAG. Dec. II. Vol. VII. 1880, Pl. XVII. Fig. 6, p. 532, and *ibid.*, Dec. III. Vol. I. 1884, Pl. VI. pp. 145-154, and Pl. VII. pp. 193-200.

modifications they have undergone with the lapse of time may be as apparent as possible. Each has its place in the long chain of descent of which the whole Eocene period forms so to speak but a few links. Rightly interpreted, each should form a landmark, assisting us to fix with some show of reason, not only the relative ages and mutual relationship of the subdivisions of the Eocene, but even to form a kind of idea of the time that had elapsed between their several periods of deposition. Bearing these considerations in mind, fossil shells, it will be seen, demand far more minute and critical examination than those that are living. This aspect of the case again forces upon us the question, one becoming more and more pressing and urgent, as to whether the binomial system can be made much longer to suffice. Here is a group of forms, separated by characters that are in themselves not entitled to specific rank, and not of the same value as existing species. We attach therefore a false importance to them, in calling them species, while if we call them varieties or sub-species, we depart from the ordinary practice, and at once introduce a triple nomenclature. Personally I should like to see them written with three names, as *Ap. Sowerbii hantonensis*, etc., a method that would save much definition.

In order to avoid tedious repetition, and to condense the descriptions, I propose to describe one type sufficiently minutely, and to point out in what way the others depart from it. In a group of shells so very closely allied to each other it does not seem likely that this can lead to inconvenience.

The first record of their occurrence in the English Eocenes is in Sowerby's Mineral Conchology, vol. iv. p. 69, plate 349, figs. 1-4. They are described as *Rostellaria Parkinsoni*, and stated to occur always above the Chalk. In the sixth vol. 1827, p. 112, pl. 558, fig. 3, another illustration is given under the same name, but in the systematic index, p. 248, published in 1835, the name is changed to *R. Sowerbii*, Mantell having in the interval, 1829, pointed out that the original *R. Parkinsoni*, Geol. Trans. 2nd ser. vol. 3, p. 203, is a wholly different and a Cretaceous fossil. It was named in compliment to the son, J. de C. Sowerby, who continued the Mineral Conchology, and not, as supposed by Nyst, to the father, who was the author of it. Nothing has been done with the Eocene species in England since, except to transfer them to *Aporrhais*.

At least three of the species to be described were figured in Sowerby under the one name, and it is therefore immaterial to which it becomes definitely attached.

APORRHÄIS SOWERBII, Mantell, sp. 1829. LONDON CLAY.  
Plate XVII. Figs. 5 and 6.

The characters are based upon 96 specimens in the Edwards' and other collections in the British Museum.

The maximum dimensions are, length 24 mm., width across wing 20 mm.: the smallest adult shell measured 13 by 11 mm., the wing being thickened in this case to 2 mm. It is never composed of less than 5 or more than 8 whorls, the average being 6. The whorls are

tumid, much wider than high, the proportion being as 6 to  $3\frac{1}{2}$ . The spire is usually ribbed, the ribs extending right across from suture to suture, more pronounced in the centre, slightly bowed away from the wing, and so close together that one occurs within every half millimetre on the last whorl of the spire (next the body-whorl). The ribs are sometimes entirely absent, and occasionally a varix is present. The spire is always regularly striated, the striæ being well defined and at least 3 to the millimetre. The body-whorl becomes slightly angulated as the wing is approached, and the ribs betray a tendency to separate into two rows of elongated nodes, which gradually coalesce into two ridges or keels as they pass on to the wing. The upper keel is produced into a digit directed upward at an angle of about  $40^\circ$  from the spire, the lower one projects very slightly beyond the margin of the wing. Its general contour is something like the wing of a bat; and inclined to be notched, or to have a sinus close to the canal, which is short. The striæ are continued all over the upper surface of the wing, fanning out, but without becoming more numerous. The wing is sometimes attached to the body-whorl only, sometimes it extends over three, but as a rule it is attached to two whorls. This description only applies to the adult shell, the wing not commencing to be developed until the spire is full-grown. After the wing attains to its full spread, it receives repeated deposits of shell and becomes much thickened. The aperture presents no important characters, but the inner lip is callus, though the callosity is not continued far over the body-whorl. The outermost shelly layer of the spire sometimes peels off in the fossil, carrying away the striæ, and leaving the ribs quite smooth and very distinct.

About 8 shells in the Edwards' collection are separated as "variety *elongata*," the spire being more regularly scalariform, with more strongly-marked ribs. The retention of a separate name for so unimportant a variation seems to me useless. This species abounds at Clarendon, Bognor, Alum Bay, Aldboro, and Southampton, in the Hampshire Eocene Basin, but is not found in the London Basin. One specimen from Southampton is of rather larger size and slightly bridges the distinction between that and the London Clay species to be next described.

It is represented in Figs. 5 and 6 of Plate XVII., the originals being from Clarendon.

*APORRHAÏS LABELLATA*, sp. nov. LONDON CLAY.

There are but few specimens of this species in the British Museum, only two or three are perfect.

The average length of the shell is 34 and the breadth 27 millims., though one with a longer canal measures 40 mm. The spire is more regularly tapering, formed of 8 or even 9 whorls, less tumid than in the last species, and with the last but one, as well as the body-whorl, slightly angulated. The ribs are coarser, one rib occupying 2 mm., and rather more bent, and separating into two distinct series of rounded nodes on the body-whorl, the upper of which is by far the

most emphasized. The great distinction, however, lies in the form of the wing, which is like the last, but a little more expanded, with a more pronounced upper digit, and also carried upward along the spire to the fourth whorl, where it is truncated and expanded outwards into a quadrate projection of a flag-like form, at an angle of about  $60^\circ$  to the axis of the spire. This flag is continuous with the wing, projects some 12 or 15 mm., and has no supporting keel.

It has been found at Highgate and other localities round North London and at Sheppey, and seems to replace *A. Sowerbii*, Mant., in the London Basin, the latter having been perhaps more littoral in its habit.

APORRHAÏS MARGERINI, De Koninck, 1837. OLDHAVEN BEDS.

Plate XVII. Figs. 7, 8.

This is by far the largest British species, measuring 50 mm. in length, and 40 in breadth. The spire is blunt and composed of 7 tumid whorls, each about twice as wide as high. The ribs are fine, except on the last whorl, not very prominent, and forming on the body-whorl an upper row of strongly-marked rounded nodes, a middle nodose keel, and a lower less-defined and almost simple keel. The striæ are faintly marked or absent. Each row of nodes or nodose keel on the body-whorl is continued into the wing, the upper forming a curved and not very pronounced digit, and the others ending in slighter projections. The canal is short and curved in the direction of the wing. The wing has, roughly speaking, the outline of a shoulder-of-mutton, and is attached to either one or two whorls above the body-whorl; it is immoderately thickened, up to 7 mm. and slightly sinuous.

All the specimens were obtained close together, between tide marks at Herne Bay, west of Oldhaven Gap. The species as here defined is new to the British Eocenes and seems rare or very local. It is almost indistinguishable from the forms found in the *Argille Rupélien de Bazele*—a bed of Oligocene age.

APORRHAÏS TRIANGULATA, sp. nov. OLDHAVEN BEDS. Plate XVII.

Figs. 3 and 4.

This species differs from the last chiefly in its smaller size, the largest measuring but 16 mm. in length by 15 across the wing. It is a reduced almost facsimile of the last, except that the striæ are more distinct and the third or inferior keel on the body-whorl is less pronounced. It is rather more obtuse and relatively shorter, and the wing more triangular or shoulder-of-mutton-shaped than in *A. Sowerbii*, which it agrees best with in size.

This is very abundant at Herne Bay in the same beds, though not actually associated with the last.

APORRHAÏS BOWERBANKII, Morris, sp. 1852. THANET BEDS.

Plate XVII. Figs. 9 and 10.

The length of this species is 36 mm. and the breadth across the wing 25. The spire is very elongated, regular, composed of 8 or 9 rather tumid whorls, higher than wide in the proportion of 9 to 5.

The ribs are prominent, slightly curved, and occupy a space of about 1 mm. each. The striæ are faint or invisible. The body-whorl is slightly angulated, and the ribs break up suddenly into 3 rows of round tubercles, the upper of which is the more prominent. The wing is relatively small, attached to the body and the penultimate whorls only, and with one digit. The canal is very short.

The species is strictly confined to the Thanet Beds at Herne Bay, and the wing is rarely preserved. Hence Professor Morris was led to regard it as a *Scalaria*, though he noticed that the last whorl was carinated, and the ribs broken upon it.—Quart. Journ. Geol. Soc. 1852, p. 266.

*APORRHÆIS FIRMA*, sp. nov. BROCKENHURST. Plate XVII. Figs. 1 & 2.

This comes next in point of size to the larger Oldhaven species, measuring 40 mm. in length, by at least 32 across the wing. The spire is very blunt, the whorls much wider than high and tumid. The ribs are curved, oblique, strongly marked, fine, but becoming coarser towards the last whorl, and breaking into three rows of nodes on the body-whorl, the upper being far more prominent and rounded than the rest; the striæ are inconspicuous. The body-whorl is more angulated than usual. The wing is short, and is produced into two digits more equal than in the previous species, and is continued to the apex of the spire. The canal is long.

This is a rare shell at Brockenhurst, only a few specimens being preserved in the Edwards' collection in the British Museum.

A small fusiform shell from Hempstead bears the label *Aporrhæis* in the same collection, but it possesses none of the characteristics of even the immature shells of the genus.

The study of this Family, limited to its Eocene range, does not carry us far. It will be noticed, however, that the oldest or Thanet Bed species is more like a Cretaceous form, and less like the living than any other, and that the newest or Oligocene form from Brockenhurst approaches in all its characters the most nearly to the late Tertiary *A. pes-pelecani*, in which the ribbed spire has finally given place to a tuberculated and angular one. The gap in succession is also remarkable, for while the genus abounds in all the marine beds of the Lower Eocene, it is wholly wanting in the Bracklesham, and even the Barton series, and only reappears in the Oligocene of Brockenhurst. A precisely similar gap occurs in Belgium. It seems clear that during the Eocene period it belonged to the northern sea, and was absent in parts at least of the southern.

THE FOLLOWING TABLE SHOWS THE RANGE OF THE EOCENE *Aporrhaidæ* IN GREAT BRITAIN.

|                             | Thanet<br>Beds. | Oldhaven<br>Beds. | London<br>Clay | Bagshot<br>Series. | Headon<br>Series. | Bembridge<br>Series. |
|-----------------------------|-----------------|-------------------|----------------|--------------------|-------------------|----------------------|
| <i>A. Bowerbankii</i> ..... | x               |                   |                |                    |                   |                      |
| <i>A. Margerini</i> .....   |                 | x                 |                |                    |                   |                      |
| <i>A. triangulata</i> ..... |                 | x                 |                |                    |                   |                      |
| <i>A. Sowerbii</i> .....    |                 |                   | x              |                    |                   |                      |
| <i>A. labellata</i> .....   |                 |                   | x              |                    |                   |                      |
| <i>A. firma</i> .....       |                 |                   |                |                    | x                 |                      |

## EXPLANATION OF PLATE XVII.

|                         |                                   |               |   | British Museum     |
|-------------------------|-----------------------------------|---------------|---|--------------------|
|                         |                                   |               |   | (Natural History). |
| Figs. 1 and 2.          | <i>Aporrhais firma</i> , sp. nov. | Brockenhurst. |   |                    |
| „ 3 and 4.              | <i>A. triangulata</i> , sp. nov.  | Herne Bay.    | „ | „                  |
| „ 5 and 6.              | <i>A. Sowerbii</i> , Mantell.     | Clarendon.    | „ | „                  |
| „ 7 and 8.              | <i>A. Margerini</i> , De Koninck. | Herne Bay.    | „ | „                  |
| „ 9 and 10.             | <i>A. Bowerbankii</i> , Morris.   | Reculvers.    | „ | „                  |
| All drawn natural size. |                                   |               |   |                    |

II.—ON THE DISCOVERY OF TRILOBITES IN THE CULM-SHALES OF SOUTH-EAST DEVONSHIRE.<sup>1</sup>

By HENRY WOODWARD, LL.D., F.R.S., F.G.S.

ALTHOUGH the ‘Culm,’ or Carbonaceous series, of Devonshire, has long been known and studied, it has been a matter of considerable doubt as to the exact horizon in the Carboniferous formation with which it may properly be correlated.

The Geological Surveyors have, it is true, spent much time in re-examining certain parts of the County; but, owing to the smallness of the scale of the Ordnance Survey Map (only one inch to the mile) and the inaccuracy of the topography, but little detailed work could be done.

Prof. J. Beete Jukes, F.R.S. (Quart. Journ. Geol. Soc. 1866, pp. 320–371), and subsequently Mr. R. Etheridge, F.R.S. (*op. cit.* 1867, pp. 568–698), described the whole of the northern portion of the county afresh, whilst Messrs. Horace B. Woodward, Clement Reid, and W. A. E. Ussher, as representing the Geological Survey, have been engaged upon certain parts in both the northern and southern areas. Added to this, Dr. Harvey B. Holl, F.G.S., Mr. A. Champernowne, F.G.S., and Mr. John E. Lee, F.G.S., have contributed not a little to the elucidation of difficult parts of the Geology of South-Eastern Devon, whilst Mr. Townshend Hall, F.G.S., has done equally useful work in the Northern area.

In 1839 Sir H. T. de la Beche<sup>2</sup> notices the Culm-formation, and mentions that Prof. Phillips regarded the Shale-fossils as belonging to the Carboniferous Limestone. The list of plants which he gives contains a mixture of species, many being in all probability true Coal-measure plants from Somerset, which do not occur in the Culm.<sup>3</sup>

In studying the Culm-measures near Chudleigh, De la Beche supposed that the Culm-shales dipped beneath the Devonian Limestone, in consequence of which he was led to include this Limestone in the

<sup>1</sup> See Plate XVI. (in November Number), Figures 6 to 11, pp. 484–489.

<sup>2</sup> Report on the Geology of Cornwall, Devon, and West Somerset, 1839, pp. 110, 145, and fig. 8, pl. iv. See also Trans. Geol. Soc. 2nd series, vol. iii. p. 163.

<sup>3</sup> Mr. R. Kidston, F.G.S., in reply to my inquiry, gives me the following species as determined by him from the Culm:—

*Asterocalamites scrobiculatus*, Schlot. sp.

(= *Bornia radiata*, Brong.)

*Calamites Roemeri*, Göpp.

*Sphenopteris*, sp. nov.

*Lepidodendron Rhodceanum* (?)

(To these I may add *Dadoxylon*, Sternb. (*Sternbergia*), in Mr. Vicary’s collection.) All these plants have (says Mr. Kidston) a “Calcareous Sandstone” facies and are equivalent to the “Culm” of Germany.

*Lepidophloios*, sp.

*Halonia* (fruiting branch of

*Lepidophloios*)

*Sigillaria* (?)

*Stigmaria ficoides*, Brong.

Carbonaceous series, and it was originally so engraved and coloured in his sections and in the Geological Survey Map.<sup>1</sup>

The subsequent researches of Mr. John Edward Lee<sup>2</sup> have led to the discovery of *Goniatites intumescens* and *G. multilobatus*, species characteristic of the Upper Devonian of Devon and Cornwall, and of the Rhineland and Westphalia.

In 1840 Prof. Sedgwick and Sir R. I. Murchison, in their memoir "On the Physical Structure of Devonshire, and on the Subdivisions and Geological Relations of the Older Stratified Deposits,"<sup>3</sup> devote pp. 669-684 to a consideration of the "Culmiferous Series, its Relation to the other Formations, Structure, and Fossils." They mention (p. 678) that "in Ugbrook Park, near Chudleigh [in close proximity to Waddon-Barton, where the Trilobites were discovered by Mr. Lee], there is a large development of Culm Sandstone as coarse as Millstone-grit, and passing into a conglomerate form; over it are some beds of thin-bedded grey sandstone, not to be distinguished from a Coal-measure sandstone, and containing very fine vegetable impressions, among which are well-marked *Calamites*. Indeed, through the whole of the upper group we are describing, vegetable impressions, though rarely so perfect as to give anything like specific characters, are extremely abundant. They add, "All the beds are intersected by numerous open joints, which in the coarser contorted beds are very irregular in their directions. But when the beds have a finer flaggy or shaly structure, the joints often become parallel (especially in a direction nearly transverse to the strike) so as to separate the strata into prismatic masses"<sup>4</sup> (p. 679).

"Among the more calcareous bands some are fossiliferous, containing a great abundance of at least two genera of bivalve shells; one a *Posidonia*" (*Posidonomya Becheri*, Bronn), the other of a genus not ascertained, but regarded as a marine shell. "In the same part of the series are *Goniatites* of at least two species, both of which are unquestionably marine, and (according to Professor Phillips) identical with *Goniatites* of the Yorkshire Coal-field."

After quoting Prof. Lindley's determinations of the plants (pp. 681-682), the authors conclude: "On the whole, considering that the Culmiferous rocks of Devon form a distinct group, with a peculiar mineral type (unlike the older groups, but nearly resembling the Culmiferous beds of Pembrokeshire)—that they overlies all the other groups, and are overlaid by no rock newer than the New Red Sandstone—that, notwithstanding the paucity of fossils in the black limestone (in which respect it resembles the 'Calp' of Ireland), there are in it one or two species not separable from known Mountain Limestone fossils, and, finally, that the flora of the Upper Culms, as far as it has been ascertained, agrees specifi-

<sup>1</sup> See Mr. Clement Reid's paper, *GEOL. MAG.* 1877, Dec. II. Vol. IV. p. 454-455. (The *Goniatites* are here spoken of as *Clymenia*.)

<sup>2</sup> See Prof. Ferd. Roemer "On the Upper Devonian *Goniatite* Limestone in Devonshire," *GEOL. MAG.* 1880, Dec. II. Vol. VII. pp. 145-147, Pl. V.

<sup>3</sup> *Trans. Geol. Soc. Lond.* second series, vol. v. 1840 (read June 14th, 1837).

<sup>4</sup> This paragraph gives a very exact description of the lithological characters of the beds at Waddon-Barton by Chudleigh, containing the Culm Trilobites.

cally with the known flora of the Carboniferous period; we think we have strong direct evidence to establish our position, "that the Upper Culm strata of Devon are the geological equivalent of the ordinary British Coal-fields."

1842.—Mr. R. A. C. Austen,<sup>1</sup> whose paper was read December 13th, 1837, describes the Culmiferous deposits of the South-east of Devonshire, and particularly at Ugbrook Park, near Chudleigh, and other adjacent places, and states that Prof. Sedgwick considered them as a portion of the Culmiferous beds of the centre of the county (p. 457).

Mr. Austen quotes a list of the plants, and adds (pp. 461-2), "This Flora, so far as it goes, is that of the Carboniferous period. In the black limestones occur *Goniatites mixolobus*, Phil., and *Goniatites crenistria*, Phil., Mountain Limestone species."

1867.—Sir Roderick I. Murchison, in the 1867 edition of 'Siluria' (p. 273), writes:—"Now, although this overlying series is in mineral aspect as much unlike the Carboniferous strata of most other parts of Britain as the rocks of N. Devon are unlike the ordinary Old Red Sandstone of England and Scotland, we have proofs of fossils, besides the analogy with Pembrokeshire before spoken of, that the black limestones of Swimbridge and Venn, etc., with *Posidonomyæ*, do represent, on a miniature scale, a part of the Mountain or Carboniferous Limestone, that the next series of white grit and sandstone of Coddon Hill, etc., stands in the place of the Millstone-Grit, and that the overlying courses of Culm, with many remains of Plants, are consequently the equivalents of some of the lower Coal-bearing strata of other tracts. In short, no one denies that in the Culm series of Devonshire we have the representatives of the Lower Carboniferous Strata."

1868.—Dr. Harvey B. Holl, in his paper "On the Older Rocks of South Devon and East Cornwall,"<sup>2</sup> describes the Carbonaceous Rocks or Culm-Measures very fully. He mentions the hard slates at Waddon-Barton overlying the limestone, full of *Goniatites* and *Posidonomyæ*, above which are the typical Carbonaceous Sandstones quarried at Ugbrook Park. In conclusion, he refers to the memoir by Sedgwick and Murchison, and adds, "It is to these authors that we are indebted for having first pointed out the true position of these (Culm) rocks in the geological scale, when, by means of the included plant and other fossil remains, they identified them with the Coal-Measures of South Wales."

1875.—Mr. Townshend M. Hall,<sup>3</sup> in his 'Notes on the Anthracite Beds of North Devon,' writes, "In the North Devon district the anthracite (Culm) is found in the Millstone-Grit, a series of beds belonging to the Carboniferous formation, but of an age immediately antecedent to that of the true Coal-Measures." The list of Culm-plants given by Mr. Townshend Hall, however, needs revision.

<sup>1</sup> Trans. Geol. Soc. Lond. 1842, 4to. second series, vol. vi. "On the Geology of South-east Devonshire."

<sup>2</sup> Quart. Journ. Geol. Soc. Lond. 1868, vol. xxiv. p. 401.

<sup>3</sup> Trans. Devonshire Association, 1875.



1876.—Mr. Horace B. Woodward, in his ‘Geology of England and Wales,’ pp. 106—111, gives a concise account of the Devonshire Culm-Measures. “Looked at it in a large way, they consist of a series of shales, grits, chert-beds, with beds of limestone here and there.” “Some authorities have placed them, generally, on the horizon of the Millstone-Grit, but there seems reason to include with them representatives of at least a portion of the true Coal-Measures, and possibly also of the Carboniferous Limestone.”

I.—The NORTH-DEVON series of Carboniferous deposits about Barnstaple and Bampton is thus given by Prof. Phillips (p. 189):<sup>1</sup>

(a) “Upper part anthracitiferous, and containing ironstone, and by these characters agreeing with the Coal-deposits of Pembrokeshire. This is in general a Gritstone series, with plants of the Coal-formation.

(b) “Coddon-Hill cherts, black-grits, jasper-rock, lydian-stones, and shales of considerable, but variable, thickness; 1500 to 2000 feet (according to the Rev. D. Williams).

(c) “Limestone and black shale with *Posidonomya*, *Goniatites*, etc. = *Posidonomya* (*Posidonia*) limestone of Swimbridge and Venn.

(d) “Black shale group.”

II.—The SOUTH-DEVON strata about Trescott and Lew Trenchard have been thus divided (op. cit. p. 194):

(a) “Gritstone group of Central Devon.

(b) “Upper shale group—dark shales, carbonaceous grits and shales (equal to the Coddon-Hill series).

(c) “Calcareous group—limestone of dark colour, and irregular bedding, with shales (*Posidonomya*).

(d) “Lower shale group, with few fossils (no slaty cleavage).”

1879.—In this year the Rev. W. Downes, M.A., F.G.S., communicated a paper “On the Limestones of Westleigh and Holcombe Rogus,” to the Trans. Devonshire Association, vol. ix. pp. 433—441.

1882.—Dr. A. Geikie, F.R.S. (the present Director-General of the Geological Survey of Great Britain), writes in his “Text-Book of Geology” (p. 748) as follows:

“In Moravia, Silesia, Poland, and Russia, the Carboniferous Limestone reappears as the base of the Carboniferous system, but not in the massive calcareous development which it presents in Belgium and England. One of its most characteristic phases is that to which the name ‘Culm’ (applied originally to the inferior slaty coal of Devonshire) has been given, when it becomes a series of shales, sandstones, greywackes, and conglomerates, in which the abundant fauna of the limestone is reduced to a few molluscs (*Productus antiquus*, *P. latissimus*, *P. semireticulatus*, *Posidonomya Becheri*, *Goniatites sphaericus*, *Orthoceras striatulum*,<sup>2</sup> etc.). The *Posidonomya* particularly characterizes certain dark shales known as ‘Posido-

<sup>1</sup> “Figures and Descriptions of the Palæozoic Fossils of Cornwall, Devon, and West Somerset,” by Prof. John Phillips, F.R.S., 1841, 8vo.

<sup>2</sup> *O. striolatum*, Sandb. The above-mentioned shells, which are all marine, occur in the Calcareous Sandstone around Edinburgh and in Fifeshire (see paper by Mr. R. Etheridge, jun., “On the Invertebrate Fauna of the Lower Carboniferous or Calcareous Sandstone of Edinburgh,” etc., Quart. Journ. Geol. Soc. 1878, vol. xxxiv. pp. 1-26, plates i. and ii.

nomya-schists.' About fifty species of plants have been obtained from the Culm, typical species being *Calamites transitionis*, *Lepidodendron veltheimianum*, *Stigmaria ficoides*, *Sphenopteris distans*, *Cyclopteris tenuifolia*. This flora bears a strong resemblance to that of the Calciferous Sandstones of Scotland."

We are indebted to Mr. John Edward Lee, F.S.A., F.G.S., for the discovery of Trilobites in the lower Culm-shales of Waddon-Barton about two years since. The spot where the discovery was made, and which, up to the present time, is the only locality that has yielded these organisms, is the bankside of a steep lane leading at right angles from the ridge-road between Chudleigh and Haldon, and near the village of Waddon-Barton.

These Goniatite-shales, which break up (as so well described by Sedgwick and Murchison) into small cuboidal or prismatic fragments, are full of minute marine organisms. A list of these had been prepared by Mr. Lee, and to this Mr. Robert Etheridge, jun., and I, have contributed some additional species.

The main interest consists in the fact that these Goniatite-bearing shales agree almost exactly with the beds of corresponding age recently most carefully worked out and described by Prof. Dr. A. von Koenen, late of Marburg,<sup>1</sup> and now of the University of Göttingen, in a paper entitled "Die Kulm-Fauna von Herborn."

Prof. Dr. A. von Koenen's paper is accompanied by two plates of Culm fossils, but he does not give figures of the two species of Trilobites which he refers to the genus *Phillipsia*, and adopts the specific determinations of von Meyer and of Sandberger, whose figures are, however, not very satisfactory.

We shall refer to these Culm species again further on.

The following is a list of species obtained by Prof. Dr. A. von Koenen from the Culm of Herborn, near Dillenberg:<sup>2</sup>

- |                                                |                                                   |
|------------------------------------------------|---------------------------------------------------|
| 1. * <i>Phillipsia æqualis</i> , v. Meyer.     | 23. <i>Productus cf. sublaevis</i> , de Kon.      |
| 2. <i>P. latispinosa</i> , Sdbg.               | 24. <i>Chonetes deflexa</i> , v. Koen.            |
| 3. * <i>Cypridina subglobulosa</i> , Sdbg.     | 25. * <i>C. rectispina</i> , v. Koen.             |
| 4. * <i>Goniatites mixolobus</i> , Phill.      | 26. * <i>Pecten densistria</i> , Sdbg.            |
| 5. * <i>G. crenistria</i> , Phill.             | 27. * <i>P. Losseni</i> , v. Koen.                |
| 6. <i>Aptychus carbonarius</i> , v. Koen.      | 28. <i>P. pratensis</i> , v. Koen.                |
| 7. * <i>Orthoceras scalare</i> , Gldf.         | 29. <i>P. perovalis</i> , v. Koen.                |
| 8. * <i>O. striolatum</i> , v. Meyer.          | 30. <i>Aviculopecten cf. papyraceus</i> , Sow.    |
| 9. <i>O. cf. giganteum</i> , Roemer.           | 31. <i>Avicula lepida</i> , Gldf.                 |
| 10. <i>O. cf. inæquale</i> , Roemer.           | 32. <i>A. latesulcata</i> , v. Koen.              |
| 11. <i>O. undatum</i> , Flem.                  | 33. <i>A. Kochi</i> , v. Koen.                    |
| 12. <i>Orthoceras</i> , sp.                    | 34. * <i>Posidonomya Becheri</i> , Gldf.          |
| 13. <i>Bactrites</i> , sp.                     | 35. <i>Myalina mytiloides</i> , v. Koen.          |
| 14. <i>Gyroceras serratum</i> , de Kon.        | 36. <i>Arca Rittershauseni</i> , v. Koen.         |
| 15. <i>Nautilus</i> , sp.                      | 37. <i>A. cf. arguta</i> , Phill.                 |
| 16. <i>Nautilus</i> , sp.                      | 38. <i>A. Decheni</i> , v. Koen.                  |
| 17. <i>Hyolithes Roemeri</i> , v. Koen.        | 39. <i>Poteroocrinus regularis</i> , H. v. Meyer. |
| 18. <i>Terebratula hastata</i> , Sow.          | 40. <i>Lophocrinus speciosus</i> , H. v. Meyer.   |
| 19. <i>Camarophoria papyracea</i> , Roem., sp. | 41. <i>Cyathophyllum</i> , sp.                    |
| 20. <i>C. triplicata</i> , v. Koen.            | 42. <i>Listrakanthus Beyrichi</i> , v. Koen.      |
| 21. <i>Spirifer ? makrogaster</i> , Roemer.    | 43. <i>Cladodus striatus</i> , Ag. ?              |
| 22. <i>Orthis concentrica</i> , v. Koen.       | 44. Fish-jaw ?                                    |

<sup>1</sup> See Leonhard und Geinitz's "Jahrbuch für Mineralogie," etc., 1879, pp. 309-346, pls. 6 and 7.

<sup>2</sup> Those marked in Prof. von Koenen's list with a star (\*) have also been noticed by Herrn E. Kayser in his paper as occurring in the Culm of Aprath and Herborn.

Since these remarks were penned, my friend Prof. von Koenen has kindly directed my attention to a valuable paper by Herrn E. Kayser, "Contribution to our Knowledge of the Upper Devonian and Culm,"<sup>1</sup> in which (pp. 67-91) he notices 29 species of Culm fossils, 10 of which occur in the preceding list, given by Prof. Dr. A. von Koenen, and the remaining 19 are given below:—

*Phillipsia longicornis*, Kayser, n. sp.  
 ———— *cf. Eichwaldi*, Fischer.  
 ————, sp.  
 ———— *marginata*, Sarres.  
*Pleurotomaria*, sp.  
*Pecten cf. grandævus*, Goldf.  
*Rhynchonella ? papyracea*, A. Roem.  
*Streptorhynchus crenistria*, Phill.  
*Strophomena analoga*, Phill.  
*Chonetes Laguessiana*, De Kon.

*Chonetes Buchiana*, De Kon.  
 ———— *polita*, McCoy.  
*Productus levipunctatus*, Sarres.  
 ———— *plicatus*, Sarres.  
 ———— *concentricus*, Sarres.  
*Discina*, sp.  
*Pleurodictyum Dechenianum*, Kayser,  
 sp. nov.  
*Cladochonus Michelini*, Edw. and Haime.  
*Zaphrentis ?* sp.

In addition to careful descriptions of the Trilobites enumerated above, the author gives excellent figures, which will prove of the greatest assistance in the determination of these obscure and highly-altered fossils.

None of the forms figured by us from Waddon-Barton appear to agree specifically with the Trilobites from the Culm of Aprath and Herborn, so far as we have been enabled to compare them with one another or with figures.

The following is a list of the fossils from the Lower Culm-shale of Waddon-Barton, near Chudleigh, Devonshire, obtained by Mr. Lee, revised and augmented by Mr. R. Etheridge, jun., and myself.

1. *Orthoceras striolatum*, Sandb. (chiefly as external casts).
2. ———— sp. (there are probably more than two species of *Orthoceras*).
3. *Goniatites mixolobus*, Phill. (as figured by Roemer).
4. ———— *sphaericus*, Martin, sp. (as figured by Roemer).
5. *Posidonomya Becheri*, Bronn.
6. ———— *corrugata*, Eth. (? or young of *P. Becheri*).
7. *Pecten*, sp. nov. ? (of a Carboniferous facies, but differing from any figured by von Koenen).
8. *Pteronites*, sp. (form related to *P. persulcatus*, M'Coy).
9. ———— sp. (form related to *P. latus*, M'Coy).
10. *Avicula lepida*, Goldf.
11. *Chonetes rectispina*, von Koenen.
12. ———— *deflexa*, von Koenen.
13. *Spirifera Uru*, Fleming.
14. *Fenestella*, sp. (in the condition known as *Hemitrypa Hibernica*, M'Coy).
15. *Phillipsia Leei*, H. Woodw. (pl. x. figs. 1, 2, 3, 4).
16. ———— *minor*, H. Woodw. (pl. x. figs. 5, 6 a, b, 7, and 8 a).
17. ———— *Cliffordi*, H. Woodw. (pl. x. figs. 8 b, 9, 10, 11, 12).
18. ———— *articulosa*, H. Woodw. (pl. x. figs. 6 c, d, and 13).
19. *Primitia Barrandiana ?*, Jones, MS.
20. Casts of small corals (probably *Monticuliporidae*).
21. Casts of small organisms (probably Sponge-spicula).

It is highly probable, when more of the shale shall have been carefully examined, that many more small organisms will be added

<sup>1</sup> Jahrbuch der K. Preussischen Geologischen Landesanstalt und Bergakademie zu Berlin für 1881 (Berlin, 1882), pp. 51-91.

to our list, but the intractable nature of the matrix has precluded our doing more at present.

It may be interesting to record the fact here that in the "Tuedian" group or Lower Carboniferous of Budle, Northumberland, Prof. G. A. Lebour has obtained specimens of *Posidonomya Becheri*, and *Goniatites*, like those of Devonshire.

"The Tuedian group (says H. B. Woodward) and the Lower Limestone shale are homotaxial with the Calciferous Sandstone group of Scotland" ("England and Wales," p. 78).

Whatever may be finally decided to be the exact horizon of the Culm-measures near Bideford, I think it can no longer be denied that the *Posidonomya* and *Goniatite* shales of both North and South Devon are really (as suggested by Dr. A. Geikie, and now shown from their fossil contents by Mr. John E. Lee) at the very base of the Carboniferous series, and are equivalent to the Lower Carboniferous series of the Rhenish Province and the Hartz.

There is little doubt also that the plant-remains which occur in the associated sandstones of the same regions are older than those of the Millstone-Grit series, and must be correlated with the Calciferous Sandstone series around Edinburgh.

The Trilobite remains from the Culm-shales of Waddon-Barton, Devonshire, are met with in the same condition as the *Goniatites* and other fossils with which they are associated. They are all highly compressed, and often considerably affected by cleavage, causing them to be more or less distorted.

Having recently visited Waddon-Barton, Chudleigh, and many of the localities for Culm-shale fossils with Mr. J. E. Lee, I subsequently spent a week in breaking up hundreds of pieces of the shale (two cart-loads of which had been procured by Mr. Lee from Waddon-Barton with the permission of Lord Clifford). Out of this I obtained a large number of these Trilobites and other organisms with my own hands, and to this Mr. Robt. Etheridge has made some additions by splitting up a number of pieces which I had brought away from Devonshire with me for further examination.

Out of a series of nearly fifty specimens thus obtained, I have been able to determine four distinct species. They are all in a very fragmentary condition, the individuals varying from 10 millimètres in length to 23 mm. and upwards.

As is the case in other deposits of Carboniferous age, it is most rare to meet with specimens having the head, thorax, and abdomen united. Only two approaching this state have been discovered as yet; the majority disclose evidence of detached pygidia, whilst head-shields and thoracic rings are but rarely found.

Making allowance for the effects of compression and distortion which the specimens have undergone, they are probably all referable to the genus *Phillipsia*, and strongly resemble in their mode of preservation the specimens of *Phillipsia Colei* from Ballintra and Carrickbreeny, Donegal, and of *Phillipsia truncatula* from Hook Point, Co. Wexford, Ireland.

PHILLIPSIA LEEI, H. Woodw. 1884. Pl. XVI. Figs. 6 and 7.<sup>1</sup>

*Phillipsia Leei*, H. Woodw. Pal. Soc. Mon. Carb. Trilob. part ii. 1884, p. 67, pl. x. fig. 1, 2, 3, and 4.

This is one of the largest of the Culm Trilobites, and is represented by numerous specimens.

The head-shield is semicircular in outline, the glabella occupying about one-third of its breadth at the widest part of the head, the glabella is moderately elevated, and is surrounded by the flattened border of the fixed cheek, which expands in front, forming a flat and somewhat broad semicircular border around the anterior portion of the glabella. Two small basal lobes are seen, one on either side, near the posterior margin of the glabella, and two short oblique furrows mark its sides. The neck-lobe is well defined and somewhat strongly arched, and is widest in the centre; the facial suture separating the free-cheek crosses the neck-lobe obliquely along its pleural portion close to the axial furrow; a deep furrow circumscribes the border and separates the raised inner portion of the free-cheek from the flattened margin of the shield which in its decorticated condition is seen to be ornamented by parallel lines. The angles of the head-shield are produced into strong rather broad spines about two-thirds as long as the head. The eyes are very small, semilunar, and often quite obliterated by compression.

*Thoracic segments.*—The axis of the thorax is somewhat wider than its pleuræ, the separate segments are distinctly marked by deep furrows, each of the pleuræ being marked by a central groove; their extremities are rounded; the thoracic segments were probably nine in number, but the whole number cannot be seen in any one specimen.

The pygidium is one-fifth broader than long, the axis forms one-third of its breadth at the proximal border, but diminishes very rapidly, terminating in a somewhat blunt point near the posterior margin.

There appear to be about fourteen coalesced segments in the axis of the pygidium represented by about nine grooved pleuræ on each side, surrounded by a narrow smooth border.

This species, which we have dedicated to the discoverer, Mr. John Edward Lee, F.S.A., F.G.S., of Villa Syracuse, Torquay, presents affinities with *P. gemmulifera*, *P. truncatula* and *P. Eichwaldi*; in all these species the angles of the head-shields are produced into lateral spines, and the flattened border of the glabella encircles the raised central portion, but the eyes in *P. Leei* are exceedingly small, whereas in the other species of *Phillipsia* they are very large and prominent.

*P. Leei* differs from *P. Colei* in possessing cheek-spines. The pygidium of *P. Leei* is also distinct, being narrower and more pointed in its axis; the tail-shield itself is also more triangular in outline.

We have compared *Ph. Leei* with *Proetus posthumus* of Richter, (Zeitsch. Deutsch. Geolog. Gesells. 1864, bd. xvi. p. 160, taf. iii.

<sup>1</sup> See explanation of Pl. XVI. GEOL. MAG., Nov 1884, p. 489.

fig. 1), to which it approaches, but in Richter's figure the glabella is narrow in front and broader behind, whereas our Culm form is just the reverse. Prof. A. von Koenen, p. 312, *op. cit.*, places Richter's *P. posthumus* with *Phillipsia æqualis*, H. von Meyer, and observes, "As von Meyer expressly says that the glabella is reduced in front, there is no doubt that Burmeister was in error in figuring as this species a form with a club-shaped glabella. Emmrich's restored figure does not give a good representation of the species; the head-shield is too long, the eyes placed too far in front, and the glabella too slightly reduced in front. The form placed by Roemer under *Phillipsia latispinosa*, from the Silesian Culm of Bantsch, appears to me, on account of the very wide glabella, to belong to *P. æqualis*. Near Nehden I have found an example of which the tail is 15 mm. wide and 10 mm. long, and fragments of still larger dimensions occur at Aprath" (*op. cit.* p. 313).

We have had the opportunity to study two Trilobites, much compressed, referred to *Phillipsia æqualis*, H. von Meyer, which were obtained at Aprath by Mr. J. E. Lee, F.G.S., of Torquay. The cheek-spines, if they existed in the original, are wanting in both, although the compound faceted eyes can be discerned with a high power, and there are faint traces on one specimen of the obliquely transverse furrows on the glabella. A reference to *Cylindraspis latispinosa*, of Sandberger (taf. iii. fig. 4 and 4a), shows that the glabella of this species is also more pointed in front than in our British species; the facial suture is close to the glabella, as in other *Phillipsiæ*.

Another specimen also from Mr. Lee's Collection (marked as "from the Culm near Marburg, collected by the Rev. G. F. Whidborne, M.A., F.G.S.," and obtained most probably from Herborn), I have not been able satisfactorily to refer to any of the species described by German authors. The head-shield (like that of the preceding specimen from Aprath), has no cheek-spines, but the pygidium differs in possessing an axis distinctly marked by 12 or 13 coalesced somites, reminding one of the pygidium of *Ph. Cliffordi* (Pl. XVI. Fig. 10), but, judging by the glabella, it probably agrees more nearly with the Aprath specimens, and should be referred with a note of interrogation to *Ph. æqualis?* (Woodcuts of these are given by me in Pal. Soc. Mon. Carb. Trilob. pt. ii. 1884, p. 68.)

I should mention that von Meyer's figure of (*Phillipsia*)? *Calymene æqualis* ("Nova Acta," vol. xv. 2nd ser. 1831, p. 100, taf. 56, fig. 13) has no cheek-spines and no eyes, nor are any sutures shown in the head-shield.

The only recent reliable figures of German Culm Trilobites are those given by Herr E. Kayser, in his memoir, Aus dem Culm von Aprath,<sup>1</sup> where he figures (taf. iii. fig. 7, 8) a small but perfect

<sup>1</sup> Beiträge zur Kenntniss von Obervedon und Culm am Nordrande des rheinischen Schiefergebirges, von Herrn E. Kayser, Arten aus dem Culm von Aprath, pp. 67-91. taf. iii. in Jahrbuch der k. Preussischen geologischen Landesanstalt und Bergakademie zu Berlin für 1881 (Berlin, published 1882). We hope to give Mr. Kayser's paper a fuller notice later on.—H.W.

specimen of *Ph. æqualis* (without cheek-spines to the glabella); and a new species, named by him *Ph. longicornis* (taf. iii. figs. 9, 10), with cheek-spines as long as the head-shield. In both species the glabella is long and narrow, and, in *Ph. æqualis*, it is slightly pointed in front and much wider at the base. He refers a broadly-rounded pygidium with a wide blunt axis to *Ph. Eichwaldi*, Fischer, = *Ph. Brongniarti*, de Kon. (referred by us to *Griffithides obsoletus*, Phillips). Another well-marked pygidium, with a dagger-shaped extremity to the axis, is figured, taf. iii. fig. 11, but not named. He carefully analyses the figures and descriptions of *Culm Trilobites* given by previous writers, and eliminates from the true *Ph. æqualis* Burmeister's *Archægonus æqualis*, Sandberger's *Ph. latispinosa* as quite different species; Emmrich's figure is considered to be a *restoration*, and Sandberger has joined the head of one species to the body and tail of another! The head of Sandberger's specimen probably belongs to *Ph. æqualis*.

*Locality*.—Waddon-Barton, near Chudleigh, Devon. From the collection of Mr. J. E. Lee, F.S.A., F.G.S.

PHILLIPSIA MINOR, H. Woodw., 1884. Plate XVI. Fig. 9.

*Phillipsia minor*, H. Woodw., Pal. Soc. Mon. Carb. Trilob. part ii. 1884, p. 69, plate x. figs. 5, 6a, b, 7, and 8a.

This is the smallest Carboniferous Trilobite which I have studied, being only half the size of the smallest specimen of *P. Colei*, from Donegal, Ireland.

Head-shield rounded in front, one-third broader than long; the glabella occupies one-third of its breadth, and is oval in outline, slightly broader in front, tumid, with distinctly-marked basal lobes; lateral furrow indistinct; surface of glabella and free-cheeks covered with minute puncta; neck-lobe rather deep and prominent, free-cheeks having a furrow around the margin parallel to the border; angle of cheek produced into a short slightly-curved spine.

Thorax consisting probably of nine segments; axis very distinct, forming one-third the entire breadth of body; axial furrows well defined, each pleura strongly grooved down the centre; extremities rounded. The eye is considerably larger in this than in the preceding species, but can only be distinctly seen in one specimen.

Pygidium one-fifth broader than long; the axis forms one-third of the breadth at the proximal border, but diminishes rapidly to a somewhat acute point at rather less than one-fourth of its entire length from the posterior margin. There are fourteen segments in the axis, and ten lateral pleuræ, which bifurcate as they approach the margin of the shield.

Hypostome. There seems but little reason to doubt that a detached free-cheek and a hypostome, lying upon the same slab with the above described nearly entire specimen of *P. minor*, really belong to one and the same specimen.

The hypostome is as broad as it is long, the anterior margin once attached to the underside of the front of the head-shield is rounded in contour, and expands laterally into two small lobes; posteriorly the hypostome is elongated into a pentangular lobe, with a slightly

raised margin, and a rounded central depression, the surface of which is striated.

The head of *P. minor* appears to us to be very distinct from any of the species of Carboniferous Trilobites hitherto figured, but the pygidium may be compared with *P. Eichwaldi*; the axis, however, in *P. minor* tapers more rapidly to a point.

*Formation.*—Lower Culm.

*Locality.*—Waddon-Barton, Devonshire.

Drawn from a specimen preserved in the British Museum (Natural History).

PHILLIPSIA CLIFFORDI, H. Woodw., 1884. Plate XVI. Fig. 10.

*Phillipsia Cliffordi*, H. Woodw. Pal. Soc. Mon. Carb. Trilob. part ii. 1884, p. 70, pl. x. figs. 8 b, 9, 10, 11, 12.

The head of this species resembles that of *P. Leei*, but the cheek-spine is much shorter, and the lateral furrows on the glabella are more marked. The head is much distorted by cleavage, and its accurate description is attended with some difficulty, the head being imperfect. Thoracic segments unknown, probably nine in number.

*Pygidium.*—The tail-shield is nearly twice as broad as it is long, the axis is one-third of its breadth at the proximal border, but rapidly diminishes to one-seventh at its bluntly-rounded extremity; here the shield is bordered by a wide margin covered with fine concentric striæ (being an impression of the underside); the border is one-seventh the length of the pygidium, but diminishes in width laterally. The axis of the tail is composed of thirteen coalesced rings or somites, and has ten lateral pleuræ on each side; these bifurcate near their extremities as they approach the margin. There are no puncta, spines or tubercles observable on this species.

The pygidium of *Ph. Cliffordi* agrees most in general facies with that of *Ph. Colei*, but in the former the pleuræ are bifid at their extremities, not simple as in the latter species. It may also be compared with *Ph. Carringtoniana*,<sup>1</sup> but the Culm form is broader and shorter in proportion.

I have much pleasure in dedicating this species to Lord Clifford, of Ugbrook Park, Devonshire, upon whose estate the Culm is well exposed. These Trilobites were discovered by Mr. Lee on one of his lordship's farms at Waddon-Barton, and it was by his permission that Mr. Lee secured a quantity of the shale to break up, resulting in the discovery of the specimens here figured.

*Formation.*—Lower Culm-shale.

*Locality.*—Waddon-Barton, near Chudleigh, Devonshire.

From Mr. J. E. Lee's cabinet, Villa Syracuse, Torquay.

PHILLIPSIA ARTICULOSA, H. Woodw., 1884. Plate XVI. Fig. 11.

*Phillipsia articulosa*, H. Woodw., Pal. Soc. Mon. Carb. Trilob. part ii. 1884, p. 71, plate x. figs. 6 c, d, and 13.

This species is based upon three pygidia of Trilobites having a larger number of coalesced segments than any of the Culm specimens

<sup>1</sup> Incorrectly spelt *Carringtonensis* (see ante p. 486).



here noticed. We are unable to refer any cephalothorax as belonging to this form of pygidium, and can only therefore note its occurrence.

Pygidium one-fourth broader than long, axis one-third the entire breadth, consisting of seventeen coalesced segments which diminish rapidly in breadth to the extremity, which is bluntly rounded, and less than one-third the breadth of the axis at the proximal end; axal furrows deeply marked. Pleuræ thirteen in number, terminating abruptly within the margin, which is finely striated; neither axis nor pleuræ have any ornamentation upon them.

This pygidium agrees most nearly with the preceding species, from which, however, it differs in possessing a greater number of coalesced somites, a character which seems sufficient to justify its separation.

Formation and locality the same as that of the preceding species.

Specimens of this species are preserved in the British Museum (Natural History).

### III.—NOTE ON A NEW SPECIES OF *MERYCOPOTAMUS*.

By R. LYDEKKER, B.A., F.G.S., F.Z.S.

*MERYCOPOTAMUS NANUS*, n. sp. *nobis* (ex Falc. MS.).

IN plates lxii. lxvii. lxviii. of part 7 of the "Fauna Antiqua Sivalensis" (1847)<sup>1</sup> a large number of remains of *Merycopotamus* (nearly all of which are in the collection of the British Museum) are figured under the name of *M. dissimilis*, although some of them are distinguished as var. *major* and others as var. *minor*; and it thus appears that at that date the authors of the work quoted referred all the remains to one species. It is stated, however, in Falconer's "Palæontological Memoirs," vol. ii. p. 407, note 4, that in 1846 Falconer considered that there were two species, which he proposed to call *M. dissimilis* and *M. nanus*; and some of the smaller specimens figured in the "F. A. S." under the former name, bear upon them the latter name in Falconer's handwriting. In some manuscript notes of Falconer's, written at a much later date,<sup>2</sup> the name *M. nanus* is once again employed (although the tooth to which it was applied does not belong to *Merycopotamus* at all);<sup>3</sup> and it would therefore seem that Falconer had by that time reverted to his original view.

In the "Palæontologia Indica"<sup>4</sup> I, perhaps somewhat incautiously, accepted Falconer's references of all the British Museum specimens to a single species, and observed that the smaller species mentioned by him could not be identified. A recent comparison of all the British Museum specimens has, however, shown pretty conclusively that they belong to two species.

The cranium and mandible represented in the "F. A. S." pl. lxvii. figs. 1 and 4, may be regarded as the type of *M. dissimilis*. The

<sup>1</sup> This is generally quoted as the authority for the genus; the name occurs, however (with a figure and description), in Owen's "Odontography," p. 566 (1840-45).

<sup>2</sup> "Palæontological Memoirs," vol. i. p. 416.

<sup>3</sup> Vide "Palæontologia Indica," ser. 10, vol. i. p. 62.

<sup>4</sup> Ser. 10, vol. ii. p. 164.

large size of the canine shows that the mandible belonged to a male; and the two specimens agree precisely in proportionate size. The symphysis is long and wide, the notch in front of the descending process of the mandible deep, the inner surface of the third lobe of the last lower molar flat, and the crowns of the molars relatively high. The left half of the symphysis of the mandible represented in plate lxviii. fig. 18 belongs to a female of this form.

The two crania represented in figs. 3-5 of plate lxvii. of the same work have considerably shorter jaws and are altogether smaller than the cranium of *M. dissimilis*; fig. 3 belongs to a male and fig. 5 to a female individual, as is shown by the size of their canines. The hinder part of the cranium of the female presents a highly arcuated profile,<sup>1</sup> in place of the straight one of *M. dissimilis*. The upper molars of the smaller crania are very similar to those of the latter, but their cusps are somewhat lower. In figs. 7, 8 of the same plate there are figured two mandibular rami which agree precisely in size with the crania above mentioned; the size of the canine shows that fig. 7 belonged to a female and fig. 8 to a male; and the following dimensions show the difference between these specimens and the male mandible of *M. dissimilis*, viz. :—

|                                                   | <i>M. dissimilis</i> |         | Small form. |         |
|---------------------------------------------------|----------------------|---------|-------------|---------|
|                                                   | male.                | female. | male.       | female. |
| Interval between canine and hinder border of m. 3 | 0.198                | 0.163   |             |         |
| Antero-posterior diameter of canine .. .. .       | 0.029                | 0.0295  | 0.020       |         |

The depth of the three specimens is very nearly the same; and the third lobe of the last lower molar of the small form is distinguished by the concavity of its outer surface. The specimen represented (on a larger scale) in fig. 6 of the same plate seems to belong to the smaller form, and shows that the notch in front of the descending plate is less deep than in *M. dissimilis*. The specimens also show that the symphysis of the smaller form was much narrower and shorter than that of *M. dissimilis*.

The foregoing observations clearly show that the differences in size between the two forms are not due to sex; and this being so, they appear too great to come within the limit of individual variation: this being confirmed by the marked differences in form already mentioned. Under these circumstances there seems no reasonable doubt that there are two species of *Merycopotamus*; and I propose to revive for the small short-jawed form Falconer's MS. name of *M. nanus*.

If the necessary sanction be granted, I shall hope on a future occasion to refigure some of these specimens in the "Palæontologia Indica" on a full-sized scale, as the small figures in the "F.A.S." are quite inadequate to exhibit clearly the distinction between the large and the small species. I am at present unable to say to which species the immature cranium from Burma (now in the Indian Museum, Calcutta), figured in plate xv. of vol. i. of the "Palæonto-

<sup>1</sup> The outline restoration of the profile of the two small crania is entirely incorrect; and was apparently made from the cranium of *M. dissimilis*.

logical Memoirs," belongs. It is also desirable that that specimen also should be refigured on a larger scale.

It may be added that the half of a cranium represented in plate lxvii. fig. 2 of the "F.A.S." under the name of *M. dissimilis*, really belongs to a species of *Sus*.

The canines of *Merycopotamus* are relatively large and pig-like, but the extremity of the upper one is not recurved as in *Sus*.

#### IV.—NOTE ON THE ANTHRACOTHERIIDÆ OF THE ISLE OF WIGHT.

By R. LYDEKKER, B.A., F.G.S., F.Z.S.

**A**N examination of the fine series of the remains of *Anthracotheriidae* from the Hempstead beds of the Isle of Wight contained in the British Museum, and their comparison with specimens and casts of the remains of the allied Continental forms, has led to the following conclusions. Some of the specimens will be figured on a future occasion.

##### HYOPOTAMUS VELAUNUS (Cuvier).<sup>1</sup>

Syn. *Hyopotamus vectianus*, Owen<sup>2</sup> (*in parte*).

The lower jaws of the smaller hypsodont form from Hempstead, which were described by Owen under the name of *H. vectianus*, agree precisely with those of *H. velaunus* from Ronzon; and may, therefore, be referred to that species. The identity of these two forms has been already indicated by Dr. Filhol.<sup>3</sup> The upper molars figured by Sir R. Owen, *op. cit.* pl. vii. figs. 6, 7, as an associated set of *H. vectianus*, belong to different individuals; but it cannot be determined whether they really belong to *H. velaunus* or *H. bovinus*.

##### HYOPOTAMUS BOVINUS, Owen.<sup>4</sup>

Syn. *Bothriodon leptorhynchus*, Aymard.<sup>5</sup> *Ancodus aymardi*, Pomel.<sup>6</sup>

Complete specimens of the upper cheek-dentition, as well as specimens of the mandible and a broken occiput of *Hyopotamus bovinus* from Hempstead, agree so exactly with the corresponding remains of the so-called *H. (B.) leptorhynchus* from Ronzon that there seems no doubt as to the specific identity of these two forms. The names *bovinus* and *leptorhynchus* were apparently published in the same year; but as the memoir in which the former occurs was read in 1847, that name is adopted for the species. Dr. Kowalevsky seems to have considered the large Hempstead and Ronzon *Hyopotamus* as specifically the same, since he figures an upper molar from the latter locality under the name of *H. bovinus*.<sup>7</sup>

##### HYOPOTAMUS PORCINUS, P. Gervais.<sup>8</sup>

Among the Isle of Wight fossils are several specimens of frag-

<sup>1</sup> Ossemens Fossiles, ed. 2, vol. v. pt. 2, p. 506 (1822).

<sup>2</sup> Quart. Journ. Geol. Soc. vol. iv. p. 103 (1848).

<sup>3</sup> Ann. Sci. Géol. vol. xii. art. 3, p. 189 (1881).

<sup>4</sup> Quart. Journ. Geol. Soc. vol. iv. p. 103 (1848).

<sup>5</sup> Ann. Soc. Agric. Sci. le Puy. 1848 (*teste* Filhol).

<sup>6</sup> Catalogue Méthodique, p. 92 (1853).

<sup>7</sup> Palæontographica, vol. xxii. pl. xii. fig. 71.

<sup>8</sup> "Zool. et Pal. Françaises," 1st ed. vol. ii. No. 31 (1848-52).

ments of the maxilla as well as detached upper molars of a smaller form, with a brachydont instead of a hypsodont structure; being in fact intermediate in structure between the teeth of *H. bovinus* and *Anthracotherium*. These teeth agree so closely with those of *H. porcinus*, that they may be pretty safely referred to that species. There also occur brachydont lower molars agreeing so well with the upper teeth that they too may be referred to the same species.

The teeth of this form are so exactly intermediate between the hypsodont species of *Hypotamus* and *Anthracotherium*, that they fully confirm the conclusion I have arrived at elsewhere<sup>1</sup> as to the complete passage in dental characters from one genus to another. It may, however, still be convenient to retain the former genus.

ANTHRACOTHERIUM, sp. (cf. *A. minus*, Cuvier<sup>2</sup>).

Several lower molars and a fragment of a mandible from Hempstead indicate a brachydont anthracotheroid of larger size than the last species, which may probably be referred to the type genus; and not improbably to Cuvier's *A. minus*.

ANTHRACOTHERIUM, sp. (cf. *A. alsaticum*, Cuvier<sup>3</sup>).

A third upper incisor (No. 29907) agrees exactly in form with the corresponding tooth of the typical form of *A. magnum*, but is somewhat smaller. It agrees so closely in size with the corresponding tooth of *A. alsaticum* that it may very probably indicate the existence of that species in the Hempstead beds; and in any case it seems to indicate a fifth member of the present family from that group, since it appears too large to have belonged to the same species as the lower molars last mentioned.

The occurrence in the Hempstead beds of the same species of *Hypotamus* as in the Ronzon beds supports the view of Prof. Gaudry<sup>4</sup> as to the equivalency of these deposits.

#### V.—LONDON CLAY IN THE VICINITY OF SOUTHAMPTON.

By J. W. ELWES, Esq.

THE outcrop of the London Clay to the north of Southampton, near the edge of the Hampshire basin, beyond Bishopstoke, Romsey, etc., was mapped by the officers of the Geological Survey many years ago.

The stratum appears as a narrow belt between the Woolwich and Reading series on the one hand, and the Lower Bagshot on the other, the general dip being a gentle southerly one. The Bracklesham beds are mapped as following to the south, occupying the whole of the area on which Southampton is situated. A large portion of it is covered with drift, now being officially mapped. The London Clay was found in the artesian well on Southampton Common; the section was described by Mr. J. R. Keele (Rep. Brit. Assoc. 1846). The uppermost beds, 74 feet in thickness, exposed in this section were regarded as the Lower Bagshot.

<sup>1</sup> 'Palæontologia Indica,' ser. 10, vol. ii. p. 162.

<sup>2</sup> "Oss. Foss." ed. 2, vol. iv. p. 500 (1822).

<sup>3</sup> *Ibid.* vol. iii. p. 403.

<sup>4</sup> "Les Enchainements, etc., Mam. Tert." p. 5 (1878).

Evidence, not available at the time the Survey was made, has since been obtained which shows that at several points within the area mapped as Bracklesham beds, London Clay crops out. This discovery is mainly due to Mr. T. W. Shore, F.G.S., of the Hartley Institution, Southampton, who has taken care to preserve in the museum of that establishment the fossils on which the evidence chiefly rests.

At Mansbridge, in the Itchen Valley, south of Bishopstoke, works in connection with a pumping station have exposed at a depth of 16ft. septaria containing abundance of *Turritella sulcifera*, with *Rimella*, *Fusus*, *Natica*, etc. A brickyard at Woodmill has yielded septaria and casts of a bivalve. At the railway bridge across the Itchen, on the Netley line, septaria with *Pectunculus brevirostris*? have been found, and unfossiliferous septaria in the river-bed at the new Cobden Bridge, St. Denys.

The above facts considered alone are not sufficient to decide to what series the beds in the valley belong, but at St. Denys, drainage works have exposed strata containing fossils in a high state of preservation, a collection of which is exhibited in the Hartley Museum. The species are as follows:—

*Terebratula* sp., *Ostrea picta*, *Ostrea* (a small ribbed species like *O. flabellula*), *Pectunculus brevirostris*? *Cardita planicosta*, *Panopæa intermedia*, *Pholadomya margaritacea*, *Aporrhais Sowerbyi*, *Turritella sulcifera*, *Natica sub-depressa*, *N. labellata*, *Pleurotoma* 3 species, *P. denticula*, *Pisania* sp., *Fusus tuberosus*, *Murex sub-coronatus*, *Pyrula Smithii*, *Rostellaria lucida*.

The above list of species, if accurately determined, leaves little or no room for doubt that the bed at St. Denys is London Clay, several being characteristic shells of this formation. Some of them are well known as occurring in the Bracklesham beds, but nearly all are included in the list of species obtained from sections in the London Clay formerly exposed at Portsmouth, published by Mr. C. J. A. Meyer (Q. J. G. Soc., vol. xxvii. p. 85). The author notices "the apparent mixture of London Clay fossils with species which are usually considered characteristic of higher or lower formations." Thus it becomes highly probable that a considerable area in the Itchen Valley, including the localities that have been named, is occupied by the London Clay.

Railway works at Nursling, in the Test Valley, south of Romsey, have recently led to a somewhat similar discovery. A well at the station yielded the following section:—

|                                                                                                                                                                                                                               |           |
|-------------------------------------------------------------------------------------------------------------------------------------------------------------------------------------------------------------------------------|-----------|
| Gravel .....                                                                                                                                                                                                                  | 7ft. 3in. |
| Loamy sand of a dark slate colour .....                                                                                                                                                                                       | 9ft. 9in. |
| Sandy bed with hardened blocks containing <i>Pectunculus brevirostris</i> , <i>Rostellaria lucida</i> , <i>Cancellaria leviuscula</i> , <i>Turritella sulcifera</i> . The blocks closely resemble the well-known Bognor rock. |           |

The cutting to the south of the station exposed patches of beds which afforded tolerably clear evidence of the presence of the Lower Bagshot, and a pebble-bed at the base of the Bracklesham series, in succession, dipping south. The whole is covered with drift gravel.

At Bassett, a northern suburb of Southampton, a small tributary

of the Test has exposed in its bed septarian blocks containing pebbles and oysters. The number of species obtained as yet is not sufficient to identify this bed as London Clay, but from a consideration of its position with regard to the beds in the well on the common, and the outcrop of the Lower Bagshot at Bassett, there can be little doubt that the bed is of London Clay age.

The outcrop of these lower beds in the area occupied chiefly by strata higher in the series is perhaps to be explained as follows:—About four miles to the south of the northern outcrop of the Chalk of the Hampshire basin, there runs an anticlinal axis, the existence of which, in part of its course at least, has long been known to geologists. In the eastern part of the basin it appears in the shape of the Portsdown Chalk ridge, but west of Fareham the Chalk disappears beneath the Tertiaries. The axis can be traced on the present map as far west as Botley, but no further indication of it is to be seen till we pass west of the Test valley, the Chalk re-appearing at Dean Hill, which forms a promontory running out in an easterly direction into the Tertiary beds. If a curved line be drawn connecting Portsdown and Dean Hill, a few miles south of the northern outcrop of the Chalk, it will be found to pass north of Southampton, and near the localities of the above-described outcrops of the London Clay. Consequently an upthrow of the beds above the Chalk has been caused, and where denudation has produced sufficiently deep valleys, some of the lower beds of the Eocene series are exposed, though the Chalk has not been reached.

Another possible explanation is the existence of a fault, but I am not aware that any evidence has yet been obtained which would tend to support such a view.

On the subject of this anticlinal Mr. C. Evans (On the Geology of Portsmouth and Ryde, Proc. Geol. Assoc. vol. ii. No. 3, p. 63) remarks that the various chalk-pits opened on the south escarpment of Portsdown show that the dip of the strata is in general to the north-east, but to the west near Fareham they may be seen to dip S.S.W. A plain of Chalk extends to some distance south of the escarpment. "It is therefore probable that Portsdown is the northern side of an anticlinal fold of the Chalk, the southern portion of which has suffered much denudation." East of Portsdown the Chalk outcrop occupies lower ground, and at one spot near Chichester, Woolwich beds cover it; thence it passes seawards. At the western end of the axis, the dip of the beds is well seen in the railway cuttings of the Salisbury and Dorset line. Mr. E. Westlake, F.G.S. (Geology, in Notes on the Town and Neighbourhood of Fordingbridge), states that "from Downton the Chalk rises gradually to the north for about  $2\frac{1}{2}$  miles, till it reaches the line of uplift of Dean Hill and Clearbury—then in the last cutting it dips sharply to the north, and passes again beneath the Eocene."

The existence of this anticlinal in the neighbourhood of Southampton was indicated in the section accompanying a paper on the Southampton well, by Messrs. E. Westlake and T. W. Shore, read at the meeting of the British Association, 1882.

The continuity of the anticlinal with that of Dean Hill remains to be proved. The axis probably runs somewhat obliquely towards the south-eastern corner of Dean Hill. Evidence of its existence may be looked for on the west side of the Test valley and in the neighbourhood of Romsey Common.

Another anticlinal, about eight miles north of this one and parallel to it, passes under Winchester, bringing up the lower beds of the Chalk on which the city stands, in the valley of the Itchen; also the Upper Greensand at East Meon, and some of the lower beds of the Chalk in the Test Valley, near Stockbridge. This may be readily seen on the map of Chalk zones published by Dr. Barrois. In much the same way it appears that the more southerly fold brings up the London Clay in the Itchen and Test Valleys, and the Chalk of Portsdown eastwards.

Apart from the theoretical interest which attaches to this matter, it is of some practical importance that the London Clay formation should be accurately and fully mapped, as it is the chief brickearth stratum of the area. Also that the existence of this anticlinal should be recorded on the map, as it must considerably affect the circulation of water in the Chalk beneath the Tertiaries, and thereby render deep borings in some spots comparatively useless.

Errors in detail have also been detected in the mapping of other parts of the basin, the particulars of which do not come within the scope of this paper.

A movement is on foot in Hampshire, started by Mr. Shore, to induce the Government to resurvey the county geologically on the Ordnance Maps of the six-inch scale. This has been done for several northern and midland counties, and also for part of the eastern border of Hampshire; but, as at present resolved, it is not intended to survey the whole county on this scale, or to revise the present map. The drift beds of the Hampshire basin are now being surveyed, and a re-survey of the whole area, and correction of such errors as have been detected, could be carried on to a great extent *pari passu* with this work, without any considerable additional expense.

The Council of the Hartley Institution and the Town Council of Southampton have taken up the matter, and are now inviting the co-operation of all the Town Councils in Hampshire and the Isle of Wight, and of all persons interested in geological science, to assist in memorializing the Government to carry out this work.

---

## VI.—ON SLICKENSIDES AND THE ORIGIN OF SOME MARL-BANDS IN THE CHALK.

By PERCY F. KENDALL.

THE phenomenon of “Slickensides” is considered to occur only in connexion with faulting, and it has frequently happened that another name has been conferred upon it when not accompanied by signs of fracture; but some recent observations have led me to doubt the propriety of making such a distinction.

In examining specimens of *Sigillaria* from the Coal-shales, it may be seen, in many cases where the trunks have lain prone, that the flutings in the shale exhibit markings exactly resembling "Slickensides" on a small scale, and that the striæ run on each side of the grooves straight down to the centre.

Now in such a case as this, clearly no faulting can have taken place. It is therefore necessary to seek for some agent that will produce a change of position of the thin layer of coal representing the tissues of the plant relatively to the shale.

Two such offer themselves, viz. simple compression, or the removal of some soluble matter. The former is no doubt the one which has been operative in the present instance, as we know that the process of conversion of vegetable tissues into coal is accompanied by an immense reduction in volume (it has been computed that 8·76 feet of vegetable matter would only yield one foot of coal).

Assuming, for simplicity of illustration, that the grooves in a Sigillarian stem are  $\cdot 1$  of an inch in depth, and  $\cdot 2$  in. wide, then the coal contained in each groove will represent a thickness of  $\cdot 438$  in. of vegetable matter which has been pressed down, and the top of the layer of coal will have travelled downward  $\cdot 428$  in., while down the sides of the furrow movement to a less extent will have taken place. This movement would be, I think, amply sufficient to account for the slickensiding observed.

This explanation, which suggested itself to me when studying a series of Carboniferous plants at the Normal School of Science, led to the elucidation of a problem having much in common with the foregoing, though presenting many peculiar features.

In the celebrated "Rose and Crown" Chalk-pit at Riddlesdown, near Croydon, numerous Marl-bands occur in the upper portion of the Middle Chalk which is there exposed, and others may be seen in the railway cuttings to the south of the pit; and while collecting fossils there, I observed many large detached blocks of chalk, upon the upper surface of which a band of marl of a thickness varying from a minute fraction of an inch up to about 5 in. rested.

Being attracted to this marl by the unusual abundance of fossils contained, I was led to examine it carefully *in situ*, and during successive visits the following features were made out:—1. The abundance of fossils (as just mentioned). 2. That while the marl merged very gradually into the chalk above, it terminated quite abruptly below. 3. Fragments of chalk were freely distributed through and completely embedded in the marl. 4. The fossils—even delicate sponges indicated merely by an iron stain—were occasionally found *filled with white chalk*. 5. Thin films of the tea-green marl could be seen covering the vertical joint-planes. 6. The marl-band rested upon an extremely rough irregular surface of chalk, the *prominences of which were slickensided all round*, the striæ being directed from apex to base.

This last fact, when viewed by the light of the theory propounded regarding the Sigillariæ, gave the clue to the solution of the problem;



but in this case the agent which effected the movement necessary to produce “*slickensiding*” was not, I believe, compression, but the action of a solvent, which, by removing some portion of the rock, allowed a subsidence of the remainder, and the dissolution being unequal, caused bosses to be left standing up, which were then “*slickensided*” by the downward movement of the chalk or of the insoluble residuum around them.

This explanation will account for the whole of the peculiarities detailed above. The solvent agent was in all probability water charged with  $\text{CO}_2$ , which, percolating through, attacked the chalk and converted the carbonate of lime ( $\text{CO Cao}$ ) into the dihydric carbonate [ $(\text{CO Ho})_2 \text{Cao}$ ], which, being readily soluble in water, would be carried away, leaving the insoluble constituents to form a layer of marl.

This has taken place at certain definite levels, determined possibly by the occurrence of a bed of chalk having a denser texture or fewer joints (both of which characters appear in the chalk under the marl bed I am describing).

So soon as a layer of marl of sufficient thickness and impermeability had been produced, all further dissolution below would be arrested—hence the relatively sharp definition of the lower boundary of the band—and the dissolving process would then encroach upon the upper part of the chalk, its completeness being in inverse ratio to the distance from the impervious layer.

The solubility of the chalk must necessarily be very unequal, depending as it does upon the character of the preponderating organism at a particular spot, and thus fragments or nodules may escape dissolution through a very slight retardation of the process allowing time for the formation of a protecting film of marl. Joint-fissures would be filled with marl by the flow of water through them acting upon their sides, only, however, to an infinitesimal extent, as will be seen from the sequel, but mainly by actual downwash.

The abundance of fossils will be readily understood when it is considered that all the shells preserved in the Surrey chalk are composed of calcite, and each layer of marl represents a great thickness of chalk.

The question now presents itself:—What amount of chalk is required to yield a layer of marl of a given thickness? This is a question to which, I think, it is impossible to give an answer which is more than a very rough approximation; but the results of two analyses which I have made furnish some data of value in such an estimation.

Taking a specimen of chalk from a point one foot above the marl-band, which I may mention is about forty feet below the lowest layer of flints in the “*Rose and Crown*” pit, I cut a rod of three cubic inches, which, after thoroughly drying at  $100^\circ \text{C}$ ., I weighed, and the same process was gone through with the marl, only  $\frac{5}{8}$  of an inch, however, being available. From each of these a weighed sample was taken and digested with acetic acid for eighteen hours;

the residues were then filtered off, dried, and weighed, with the results given below.

|                                                      |                                 |
|------------------------------------------------------|---------------------------------|
| 3 cubic in. of Chalk = 86.5 gr.                      | ·5 cubic in. of Marl = 19.6 gr. |
| 2.92 gr. chalk yielded an insoluble residue weighing | ·0645 gr.                       |
| 1.6939 gr. marl                                      | „ „ „ „ 503 gr.                 |

The insoluble residue from the Chalk amounts to 2.2 per cent., while that of the marl is almost exactly 30 per cent.; therefore if my estimation be correct, such a band of marl 1 in. thick yields a residue equal to that from 18.277 in. of the Chalk immediately overlying it. Even this is by no means a full estimate of the amount of Chalk in its original purity and of its original composition which a Marl band of that thickness represents; for, apart from the question of what has become of the aragonite shells, which were doubtless once present in their due proportion, the process of dissolution has probably been going on without interruption so long as the Surrey Chalk has been exposed at the surface; moreover, the specimen of chalk which I used was by no means free from marl, one or two excessively fine layers being visible on the clean scraped surface of the rod. This would in a measure account for the very high percentage of insoluble matter present. The marl, too, was an unusually chalky specimen. Taking my figures as they stand, it would appear that this Marl-band where attaining its maximum thickness (5 inches) indicates the dissolution of 7 ft. 7 in. of Chalk—a really surprising result—and one which, if established, may go far to explain some of the discrepancies which are apparent when a comparison is made of the thickness of the zones of the Chalk at points not very remote.

With a view to pursuing this inquiry further, I shall be very glad to receive any information as to the extent, number, and thickness of the Marl-bands in the different zones at all exposures of the Chalk.

A very interesting piece of evidence, which appears to be corroborative of the views expressed in this paper, was furnished me by Mr. James Clark, M.A., to whom I had communicated my ideas upon this subject. This gentleman found in the “Rose and Crown” Pit a slender cylindrical flint, which for about half its length was most beautifully “slickensided” upon all sides, the striæ being longitudinal. Unfortunately Mr. Clark was unable to give me any information as to the original position of the flint, as when he saw it it was embedded in a block of chalk which was just about to be thrown into the lime-kiln; but on a careful examination of chalk I found a very thin seam of marl scarcely exceeding in thickness the paper on which this communication is printed, which traversed the block in a plane at right angles to the axis of the flint, and placing it almost beyond a doubt that, like so many of the flints from this part of the Chalk, the one in question had stood in a vertical position.

Coal-balls I have observed to be “slickensided” in a very similar manner, and containing as they do uncrushed vegetable tissues, it appears to be a legitimate inference that an infiltration of carbonate of lime has taken place very soon after the deposition of the Coal (as peat), and that the incompressible mass has been marked by the movement of compression of the surrounding Coal. The Septaria of

the London-clay are occasionally marked in the same way. The only traces of organisms found in washings from the Marl-band were one or two prisms of *Inoceramus*, not a single Foraminifer being seen.

In conclusion, I would remark, that my suggestion as to the origin of Marl-bands is not intended to apply to all those found in the Chalk, but only to such as exhibit the characters which I have detailed.

---

NOTICES OF MEMOIRS.

---

BRITISH ASSOCIATION FOR THE ADVANCEMENT OF SCIENCE:  
FIFTY-FOURTH MEETING, MONTREAL, 1884.

SECTION C.—GEOLOGY.

*President*: W. T. BLANFORD, F.R.S., Sec. G.S.

*Vice-Presidents*: Professor J. GEIKIE, LL.D., F.R.S.; Professor J. HALL;  
Professor T. RUPERT JONES, F.R.S.; A. R. C. SELWYN, LL.D., F.R.S.

*Secretaries*: F. ADAMS, B.Ap.Sc.; Professor E. W. CLAYPOLE, B.A., B.Sc.;  
W. TOPLEY (*Recorder*); W. WHITAKER, B.A.

Titles of Papers read on August 28th, 1884.

Address by the President (*W. T. Blanford, F.R.S. Sec. G.S.*).

*E. Gilpin, A.M., F.R.S.C., Inspector of Mines, Nova Scotia.*—Results of Past Experience in Gold Mining in Nova Scotia. (See p. 564.)

——— A Comparison of the Distinctive Features of the Nova Scotian Coal-field. (See p. 467.)

*H. A. Budden.*—On the Coals of Canada. (See p. 560.)

*Rev. D. Honeyman, D.C.L., F.R.S.C.*—On the Geology of Halifax Harbour, Nova Scotia.

*J. H. Panton, M.A.*—Gleanings from Outcrops of Silurian Strata in Red River Valley, Manitoba. (See p. 474.)

*G. C. Brown, C.E.*—The Apatite Deposits of the Province of Quebec.

*Frank Adams, M.Ap.Sc.*—On the Occurrence of the Norwegian "Apatitebringer" in Canada; with a few notes on the Microscopic characters of some Laurentian Amphibolites. (See p. 518.)

*L. W. Bailey, M.A., F.R.S.C.*—On the Acadian Basin in American Geology. (See p. 478.)

*Prof. E. W. Claypole, B.A., B.Sc., F.G.S.*—Geological Survey of Pennsylvania. Pennsylvania before and after the Elevation of the Appalachian Mountains. (See p. 466.)

*W. H. Merritt.*—On the Occurrence and Locations of the Economic Minerals of Canada. (See p. 521.)

(August 29, 1884.)

*Prof. J. S. Newberry, M.D.*—Phases of the Evolution of the North American Continent. (See p. 522.)

*Prof. H. Carvill Lewis, M.A.*—Marginal Kames. (See p. 565.)

*Dr. H. W. Crosskey.*—Report of the Committee on the Erratic Blocks of England, Wales, and Ireland.

*Hugh Miller.*—On Fluxion Structure in Till. (See p. 472.)

*A. R. Selwyn, F.R.S., Director of the Geological Survey of Canada.*—On a Theory of Ice-Action in the Formation of Lake Basins, and in the Distribution of Boulders in Northern Latitudes.

- Ralph Richardson, F.R.S.E.*—Points of Dissimilarity and Resemblance between Acadian and Scottish Glacial Beds. (See p. 517.)
- W. F. Stanley.*—Upon the Improbability of the Theory that former Glacial Periods in the Northern Hemisphere were due to the Eccentricity of the Earth's Orbit, and to the Winter Perihelion in the North. (See p. 518.)
- Rev. E. Hill, M.A.*—On Ice-Age Theories. (See p. 513.)
- Prof. J. S. Newberry, M.D.*—Recent Discoveries of New and Remarkable Fossil Fishes in Ohio and Indiana. (See p. 523.)

(September 1, 1884.)

- Professor Hall, LL.D.*—On the Fossil Reticulate Sponges constituting the Family *Dictyospongiæ*. (See p. 557.)
- Professor Hall, LL.D.*—On the Lamellibranchiate Fauna of the Upper Helderberg, Hamilton, Portage, Chemung and Catskill groups (equivalent to the Lower, Middle and Upper Devonian of Europe); with especial reference to the arrangement of the Monomyaria, and the development and distribution of the species of the genus *Leptodesma*. (See p. 559.)
- Professor T. G. Bonney, D.Sc., F.R.S.*—On the Archæan Rocks of Great Britain. (See brief abstract, p. 521.)
- Dr. T. Sterry Hunt, F.R.S.*—The Eozoic Rocks of North America. (Printed in full, see p. 506.)
- Professor J. F. Blake, M.A.*—First impressions of some Pre-Cambrian Rocks of Canada.
- Professor J. D. Dana, LL.D.*—On the Southward Ending of a great Synclinal in the Taconic Range. (See p. 473.)
- H. J. Johnston-Lavis.*—Notice of a Geological Map of Monte Somma and Vesuvius.
- W. Topley.*—Report upon the National Geological Surveys of Europe. (Printed in full, p. 447.)
- W. Whitaker, B.A., F.G.S.*—The Value of Detailed Geological Maps in relation to Water-Supply and other Practical Questions. (See p. 468.)
- Prof. V. Ball, M.A., F.R.S.*—On the Mode of Occurrence of Precious Stones and Metals in India. (See p. 516.)
- Dr. C. Le Neve Foster, H. M. Inspector of Mines.*—What is a Mineral Vein or Lode? (See p. 513.)

(September 2, 1884.)

- G. K. Gilbert.*—Plan for the Subject-Bibliography of North American Geology. (See p. 562.)
- Prof. E. W. Claypole, B.A., B.Sc., F.G.S.*—On some remains of Fish from the Upper Silurian Rocks of Pennsylvania. (See p. 519.)
- Prof. O. C. Marsh.*—American Jurassic Mammals.
- Prof. T. R. Jones, F.R.S.*—On the Geology of South Africa. (See p. 476.)
- Principal Sir W. Dawson, C.M.G., LL.D., F.R.S.*—On the more Ancient Land Floras of the Old and New Worlds. (See p. 469.)

- J. S. Gardner.*—On the Relative Ages of the American and English Cretaceous and Eocene Series. (Printed in extenso, p. 492.)
- E. Wethered.*—On the Structure of English and American Carboniferous Coals. (See p. 515.)
- Prof. T. R. Jones, F.R.S.*—Second Report on the Fossil Phyllopora of the Palæozoic Rocks. (See page 348.)
- A. H. Mackay, D.A., A.Sc.*—A Preliminary Examination of the Siliceous Organic Remains in the Lacustrine Deposits of the Province of Nova Scotia. (See p. 561.)
- C. E. De Rance.*—Tenth Report of the Committee upon the Underground Waters in the Permeable Formations of England and Wales, and the Quantity and Character of the Water supplied to various Towns and Districts from those Formations. (See p. 475.)
- G. R. Vine.*—Fifth Report on Fossil Polyzoa.
- J. W. Davis.*—Report upon the Exploration of Raygill Fissure in Lothersdale, Yorkshire.

(September 3, 1884.)

- G. F. Matthews, A.M., F.R.S.C.*—The Geological Age of Acadian Fauna. (See p. 470.)
- G. F. Matthews, A.M., F.R.S.C.*—The Primitive Conocoryphean. (See p. 471.)
- C. E. De Rance and W. Topley.*—Report of the Committee upon the Rate of Erosion of the Sea Coasts of England and Wales, and the Influence of the Artificial Abstraction of Shingle and other Material in that Action. (See p. 566.)
- Prof. J. Milne.*—Fourth Report on the Earthquake Phenomena of Japan.
- Prof. E. Hull, LL.D., F.R.S.*—The Geology of Palestine.
- P. Hallett, M.A.*—Notes on Niagara Falls. (See p. 563.)
- A Paper of Geological importance was read, on Sept. 1st, in Section B—Chemical Science—by *Sir H. E. Roscoe*, on the Diamondiferous Deposits of South Africa and the Ash of the Diamond.

---

ABSTRACT OF PAPERS READ IN SECTION C, GEOLOGY.

1.—ON THE FOSSIL RETICULATE SPONGES CONSTITUTING THE FAMILY DICTYOSPONGIDÆ.

By Professor JAMES HALL, LL.D.

OUR knowledge of these forms in America dates back to 1842, when Mr. Conrad described a peculiar fossil body under the name *Hyndoceras* (in the belief of its relation to *Orthoceras*). Subsequently in the same year another form by Vanuxem as a marine plant, and in 1862 Dawson as Algæ, and followed by Hall in 1863, who described several of the species under the name *Dictyophyton*; adopting Vanuxem's name *Uphantania* for other forms.

In 1879 Mr. C. D. Walcott described a form referable to this group of fossils, from the Utica State, as *Cyathophycus*. In 1881 Mr. Ii.

P. Whitfield published observations on the structure of *Dictyophyton* and its affinities with certain sponges, accompanied by a note from Dr. J. W. Dawson, on the structure of a specimen of *Uphantænia*, etc. (D. Walcott on the Nature of *Cyathophycus*.)

In the same year R. P. Whitfield (with note by Dr. J. W. Dawson) described two species of *Dictyophyton* and one of *Uphantænia*. (Bulletin of the American Museum of Natural History.)

In 1882, James Hall upon *Dictyophyton*, *Phragmodictya*, and similar forms with *Uphantænia*. (American Association for the Advancement of Science.)

In the European literature, the first notice of which was observed by the writer, of any fossil resembling *Dictyophyton*, is in Murchison's Silurian System (1839), where *Cophinus dubius* is described and figured.

(In Morris' Catalogue this fossil is placed in the category of *incertæ sedes*.)

In 1845, M'Coy, in his 'Synopsis of British Palæozoic Fossils,' describes *Tetragonis Danbyi* (*Receptaculites Danbyi*, Salter in MS.).

In 1874 Mr. Salter, in his Catalogue of the Cambrian and Silurian Fossils in the Cambridge Museum (p. 176), places *Tetragonis Danbyi* under the Spongida. In 1880, Dr. Ferdinand Roemer has described the genera *Dictyophyton* and *Uphantænia* (Lethea geog. Thiel, p. 126 and 128), placing them among the Algæ. At a later date the same author places *Tetragonis Murchisoni*, *T. Danbyi*, and *T. Eifelensis* among the Spongida.

In 1883 the same author ('Zeitschrift der Deutschen Geologischen Gesellschaft,' Bd. xxxv. p. 704) has discussed the relations of *Tetragonis Eifelensis*, with *Dictyophyton*, describing and illustrating *Dictyophyton Gerolsteinensis*.

This group presents a great variety of form in the mode of growth. The structure of the frond which characterizes every member of this family, may be described as a reticulation of tubular spicules forming rectangular meshes. In the simpler forms these meshes alternate in size and strength, owing to the regular alternation in the size of the bundles of spicules which determine the meshes. In the prismatic and nodose forms, certain bundles of spicules become very much developed and produce the characteristic form and ornamentation of the cup. The middle layer is uniformly reticulate; while the inner and superficial layers show an oblique and sometimes a radiate arrangement of spicules. In the highly-ornamented species the outside layer of spicules is often produced into tufts, spines, and intersecting fimbria or laminae of greater or less prominence.

In the foreign literature accessible to the writer there are six species of this family described. In preparing a memoir on the subject he has been able to recognize, from personal examination, thirty-seven American forms, the oldest geologically being from the Utica State, and the latest form from the Keokuk limestone of the Carboniferous system. These thirty-seven species have been described under the following genera, viz.: *Cyathophycus*, Walcott, *Dictyophyton*, *Ectenadictya*, *Lyrodactya*, and *Physospongia*, Hall; and *Uphantænia*, Vanuxem.

- 2.—ON THE LAMELLIBRANCHIATE FAUNA OF THE UPPER HELDERBERG, HAMILTON, PORTAGE, CHEMUNG AND CATSKILL GROUPS (EQUIVALENT TO THE LOWER, MIDDLE AND UPPER DEVONIAN OF EUROPE); WITH ESPECIAL REFERENCE TO THE ARRANGEMENT OF THE MONOMYARIA AND THE DEVELOPMENT AND DISTRIBUTION OF THE SPECIES OF THE GENUS LEPTODESMA.

By PROFESSOR JAMES HALL, LL.D.

THE investigations of the fossil Lamellibranchiate shells has been carried on as a part of the work of the palæontology of the State of New York. Already ninety plates have been lithographed, and these with their explanations giving the names of the fossils have been distributed to the principal scientific societies of Europe and America. The full text of the descriptions of the species of the Monomyaria, 268 pages and plates i.—xxxiii. and lxxxi.—xcii., have been published complete. The remaining portions of the work were well advanced.

The Monomyaria are described under twenty-one genera and 284 species. The remaining portion of the work contains illustrations of about 215 species under thirty-three genera.

The author has found it necessary to make subdivisions among the forms usually referred to *Aviculopecten*, and it has seemed equally important to propose other generic names for forms which have heretofore been indiscriminately referred to *Avicula*, *Pterinea*, *Pteronites*, etc. While the essential internal characters have been regarded as of primary importance, such an arrangement has been made of the species that the student may determine their generic relations from the general form and exterior markings alone. Since, in all forms of the fossil Lamellibranchiata the interior surface usually remains attached to the matrix, a reliable means of identifying the genera by external characters becomes a consideration of primary importance.

Among the new genera proposed, *Leptodesma* presents some features in its development and distribution which may be of more than ordinary interest. The upper part of the Chemung group exhibits such physical features as might be expected from a gradually shallowing sea and the approach of estuarine conditions. Numerous circumscribed areas appear to have existed, and these, while often characterized by an abundant fauna, contain few species, and these forms are extremely limited in their geographical range. The species of the genus *Leptodesma* are often abundant and very characteristic of certain horizons within limited areas, but rarely have a general distribution through the strata, as some species of the Brachiopoda. They seem to have been developed in shallow lagoons, and the characteristic species of one of these areas rarely appear in another. At the same time the physical condition or other causes have operated to develop a remarkable variety in form, and as it does not seem possible to separate these forms generically, it becomes necessary to arrange them in distinct groups or sections.

These sections have been made with reference to the most prominent characteristic of the forms. Of those already known and

described, nineteen species are conspicuously marked by a posterior spiniform extension of the hinge-line, and form the section *Spirifera*. In another group, where the spiniform extension is not conspicuous, the umbo is remarkably prominent, and ten species are arranged under the section *Umbonata*. In other forms, the anterior extremity becomes nasute or rostrate, and seventeen species are placed under the section *Rostrata*. Other forms are nearly flat and spreading, with little or no extension of the hinge beyond the body of the shell, and these forms are placed in the section *Patulata*. Other forms have the hinge-line shorter than the width of the shell, the anterior end rounded or truncate, and having the general form of *Arca*. Of these, six species are placed under the section *Arcoidea*. Still, a few other forms have the aspect of *Mytilus*, and two species are placed under the section *Mytiloidea*. Here we have a group of shells among which we find no means of generic separation; and yet within its limits the species are developed in the direction of several other genera, so far as regards form and other external characters. The studies of this genus have been made from collections of many hundreds of specimens with the result stated. An examination of a more limited number of examples could easily have led to the reference of some forms to the genus *Mytilus*, some to *Arca*, and others to new and distinct genera.

The forms of this genus, as at present limited, certainly exhibit evidences of a most remarkable development in form and external characters; and are well worthy the study of the specialist in this department of Palæontology.

### 3.—ON THE COALS OF CANADA.

By H. A. BUDDEN.

COAL is widely distributed over the Dominion; from the extreme eastern point on the Atlantic, in the Island of Cape Breton, it occurs, and through a portion of Nova Scotia and New Brunswick; from thence a wide blank exists, until about the ninety-seventh parallel is reached; from it to the base of the Rocky Mountains extensive fields are being developed; it is also met with at various points in British Columbia, but Vancouver Island, on the Pacific, contains the most valuable deposits.

Central Canada, although deprived of coal, is contiguous to the immense fields of Pennsylvania, Ohio, &c., and through the medium of the great lakes and the railways, is readily served at moderate cost.

The principal fields are five in number. Those in Nova Scotia are carefully described by Sir William Dawson, in his 'Acadian Geology,' but among others, Sir Charles Lyell, Sir William Logan, Brown, Hartley, Robb and gentlemen in the service of the Geological Survey of Canada, have given much attention to the subject. The North-West fields have been surveyed partially by the Geological Survey, Dr. George Dawson doing the principal work. Vancouver Island and British Columbia are indebted to the late Mr. Richardson and Dr. George Dawson for the results from their surveys; their reports are to be found in the records of the Geological Survey.



*Cape Breton.*—The coal-field is Carboniferous, the measures consist of an accumulation of strata, comprising shale, sandstone and fire-clay, with numerous valuable seams of bituminous coal. The principal field is about thirty-one miles long, bounded on the north by the ocean, on the south by the Millstone Grit, the outcrop of the seams are found on the shores of the deep bay. The measures lie at an easy angle, dipping under the sea.

*Pictou County* has the next important field, and is widely known on account of the immense thickness of the seams, they are more irregular in their dip than those of Cape Breton, with an angle from  $10^{\circ}$  to  $30^{\circ}$ . The total area is about thirty-five square miles, but owing to the extent of faults, a large portion of the coal is cast off, the whole field forms an irregular basin, let down on all sides, among rocks of older age.

*Cumberland County.*—This important field has only recently been developed on a large scale, the productive measures extend from the Joggins, on the shore of the Bay of Fundy, for more than twenty miles easterly, towards the base of the Cobequid Hills. On the shore of the Bay of Fundy, the exposure is of immense thickness, estimated at 14,000 feet, extending from the Marine Limestones of the Lower Carboniferous to the top of the Coal formation. Its extent has not yet been arrived at.

*North-West.*—The ninety-seventh meridian separates pretty exactly the coal-bearing formations of America into two classes. To the east, Carboniferous; in the west, the coal and lignites are found at various horizons in the Secondary and Tertiary rocks; their development has only commenced; but when it is considered that outcrops of valuable seams are found eastward of the Rocky Mountains, from the United States boundary, for hundreds of miles to the north, no anxiety need be felt as to their extent.

*British Columbia.*—Very little exploration has been made in the mainland, the coals of Vancouver Island being easily accessible and of excellent quality. The best-known fields are those of Comox and Nanaimo, on the eastern shore of the Island. The measures dip mostly under the sea; they are variable, however, and require the diamond drill to be used extensively; the coals are bituminous and are considered the best on the American Pacific Coast. Two companies, the Wellington and Vancouver, work extensive mines.

---

#### 4.—A PRELIMINARY EXAMINATION OF THE SILICEOUS ORGANIC REMAINS IN THE LACUSTRINE DEPOSITS OF THE PROVINCE OF NOVA SCOTIA, CANADA.

By ALEXANDER HOWARD MACKAY, B.A., B.Sc.

**M**ANY of the lakes of Nova Scotia contain large deposits abounding in these remains, which consist of the siliceous skeletons of upwards of sixty species of Diatomaceæ, and of the siliceous spicules of at least seven species of fresh-water sponges. The deposits from different lakes are generally marked by a difference in the species present or in their relative proportion. In lakes which

are not agitated by large streams bearing earthy sediments during times of freshets, the deposits generally consist of a light slimy brownish mud sometimes of a depth beyond twenty feet, into which a pole can be easily driven by the hand. This mud, when treated so as to eliminate the carbonaceous vegetable matter, leaves a variable percentage of exquisitely sculptured diatom cells and various forms of sponge spicules. In some places this percentage is very high and the deposit correspondingly whiter and firmer, in some cases consisting nearly of the pure siliceous valves and spicules. The Diatomaceæ grow not only in the waters of these lakes, but in the streams flowing into them, so that these deposits are not all developed *in situ*. The sponges, on the other hand, affect the stiller waters of the lake. They attach themselves to and grow upon portions of submerged wood, stone or even sand, sometimes forming extensive incrustations several inches in thickness, some species extensively lobed and even branching. The sponge-flesh dying away each winter, innumerable microscopic spicula which formed its skeleton are thus scattered in the waters, so that in some localities the sponge spicules form a greater proportion of the deposits than the valves of the Diatomaceæ.

Some of these deposits may prove to be of industrial importance, the material being regarded as capable of use as polishing powder for various purposes, and in the manufacture of dynamite.

The lakes upon which these preliminary observations have been made include Ainslie, in Cape Breton; Lochaber, in Antigonish Co.; Mackay, Blackbrook, Garden of Eden, Grant, M'Lean, Calder, Forbes, Ben, and Toney Lakes in Pictou Co.; Mackintosh, Earltown, and Gully Lakes, in Colchester Co.; the lakes which supply the city of Halifax with water, Grand Lake and Dartmouth Lakes in Halifax Co.; and Kempt Lake, in King's Co.

Lists of the species of Diatomaceæ and Spongiidæ detected in the several deposits were given in the paper, which was accompanied by microscopical slides and specimens. The author has not yet concluded his researches.

#### 5.—PLAN FOR THE SUBJECT BIBLIOGRAPHY OF NORTH AMERICAN GEOLOGY.

By G. K. GILBERT.

THE United States Geological Survey is engaged on a Bibliography of North American Geology. The work when completed will give the title of each paper, with the title-page of the containing book, and the number of plates, the whole being arranged alphabetically by authors.

There is in contemplation also the simultaneous preparation of a number of more restricted bibliographies, each covering a division of geological literature. The plan includes abbreviated titles of papers, with reference to the pages on which the special subjects are treated, the entries in each bibliography being arranged alphabetically by authors.

The selection of topics for treatment in this manner involves the classification of geologic science, and Mr. Gilbert submitted a tentative classification, requesting the criticisms of geologists.

6.—NOTES ON NIAGARA.

By P. HALLETT, M.A.

THESE notes may be expressed in abstract in the following proportion, and are submitted to the Section as questions for its consideration.

1. That, assuming the principle of the gradual formation of the cataract, the condition of existence of the present overhanging precipice is the superimposition of the hard Niagara limestone—corresponding to the Wenlock limestone—upon the friable Niagara shale, the latter being undermined, and the former overhanging; that the condition of existence of the rapids above the precipice is the succession of hard rocks simply, and that these differences of condition probably differentiate overhanging Falls from Rapids generally.

2. Hence, in case of the precipice receding to a point above the shale, the fall would disappear and become a rapid.

3. That the form of the water in the rapid in consequence of its increasing velocity is convergent to mid-channel; and hence the rapids, instead of being a source of danger to Goat Island and the small islands in their current, are actually a protection to them by determining the water from their banks.

4. That the water of the Fall undergoes a continuous disintegration from summit to base, and breaking up into smaller and smaller masses and spreading out as it descends. The “continuous roar” of Niagara is really a succession of impulses.

5. That this disintegration is a consequence of the collision between the falling water and the column of air beneath it; and that the compressed air in its descent is propelled inwards and outwards; inwards to form the well-known rush of winds behind the Fall, and driving the heading of excavation in the shale; outwards sending up the cloud mist that continuously hangs over the Falls.

6. That this collision between the air and falling water is really a conservative influence, distributing the direct force of the fall and partly transmitting it both directly and by reaction along the currents of the gorge.

7. That besides the force of the air propelled against the shale face of the precipice as a cause of its excavation, attention is also to be directed to the continuous drainage as evidenced by springs, etc., from the shale. Even along the gorge where there are no falls this appears to determine an undermining action or recession of the banks below, with overhanging rocks above.

8. That retrocession of the Falls, evident as it is, is not to be regarded as the operation of a mechanical force necessarily continuous, but as a movement to equilibrium. Hardly any retrocession has occurred in parts of the American Fall during the time that the Canadian has gone back some 500 yards. Retrocession would follow from any cause increasing the amount or force of the water, elevation of the land, increased rainfall, etc., and each retrocession would increase the discharging power of the river, thus tending to carry off the increased water supply. The relation

between the increased supply and the discharging power thus tends by retrocession then to equality and to balance.

9. All the features of Niagara being dependent on the force of the waters, every attempt to diminish this force by what is known as the utilization of the Falls would change these features, and if the utilization were carried to the extent sometimes proposed, these features would be destroyed. Abstract the *vis viva* from the water, and we have only a mass of inert matter.

10. And it may be questioned whether even the material argument in favour of utilization, great as it is, is so conclusively in favour of the utilizer as is often supposed. It is admitted that Niagara has played no mean part in the geographical evolution of this part of the continent; and, it may be noticed, does it not now play an equally important part in its preservation? In the Niagara descent is generated the impulse which commands the circulation both of the Upper and Lower Lakes, and hence to some extent the drainage, rainfall, and cultivation of their adjacent areas of country. The Niagara impulse, some four and a half million horse-power, moves the waters down from Erie and drives them through Ontario. If this impulse be wholly or even largely withdrawn in the manner proposed, what may be the effect on the circulation of this continental district? If this is not now a practical question, the propositions now in the air may soon make it one.

## 7. RESULTS OF PAST EXPERIENCE IN GOLD MINING IN NOVA SCOTIA.

By EDWIN GILPIN, Jun., A.M., F.G.S., F.R.S.C.

**T**HE gold-fields of Nova Scotia stretch along the whole Atlantic coast of the province, and occupy an area of about 7000 square miles.

The auriferous measures may be divided into two series, an upper one consisting of black pyritous slates with occasional beds of quartzite and some auriferous veins and a lower one made up of alternating beds of slates and quartzites and compact sandstone, sometimes felspathic. The upper series is estimated to be 3000 feet thick, the lower 9000 feet.

Granite rocks stretch irregularly the whole length of the gold fields. The granite is evidently intrusive, and is older than the Carboniferous period.

The auriferous veins vary in thickness up to six feet; the usual size of those worked is only four to fifteen inches. The quartz is often crystalline and banded. The veins have the same strike as the inclosing rocks, and were at first considered to be *beds*, similar to those known to be auriferous in the Carolinas and elsewhere; but the fact of their containing portions of the inclosing slate, and of occasionally cutting obliquely across the bedding, proves that they are *true veins*.

The distribution of the gold in the veins may be termed capricious. While the veins for a long distance may be auriferous, there is generally one zone or several zones of quartz much richer than that

on each side. These zones or "pay streaks" do not appear to be the effect of any law that has yet been applied to our mines.

Judging from the available fossil evidence, which however is small, the gold-bearing beds appear to be of Cambrian age.

The quartz mills of Nova Scotia are similar to those in general use in Australia and California. The cost of mining varies from eighty cents in the open cast slate belts, carrying auriferous quartz, up to fifteen dollars a ton in small veins, three or four inches wide in very hard rock. The cost per ton of crushing with water power varies from sixty cents to one dollar, with steam power the cost is somewhat higher.

Attention is now being turned to low grade ores, that is to say, beds of auriferous slate with veins of quartz, yielding averages of four to eight pennyweights of gold to the ton.

During the year 1883 the miners averaged two dollars eighty-four cents a day from 25,954 tons of quartz, yielding ten pennyweights and twenty-one grains of gold per ton, and looking at the large extent of country containing proved auriferous strata, the author anticipates a permanent and profitable future for the gold mines of Nova Scotia.

---

#### 8.—MARGINAL KAMES.

By Professor H. CARVILL LEWIS, M.A.

**D**URING his exploration of the extreme southern edge of the ice-sheet in Pennsylvania, the author had an opportunity of studying certain short ridges of stratified drift, which appeared to represent in many cases a *backward drainage* of the melting edge of the glacier, and for which he proposed the name *marginal kames*.

After describing the general characters of kames, eskers, and osars, as studied in different parts of the world, the author reviewed the researches of American geologists upon this subject, and discussed the various theories as to the origin of these curious deposits. He then described in detail a number of marginal kames in Pennsylvania, indicating their relationship to the great terminal moraine (from which they are clearly to be distinguished), and to the lines of the present drainage. He showed that these kames are made of stratified sand and gravel, finest within and often coarse without, that they have a rude anticlinal structure, that boulders and till often lie on the top of them, that they contain no shells or other indications of having been shore-lines of any kind, and that while bearing no relation to the movement of the glacier, their courses coincide with the general drainage of the region in which they lie.

It was argued that marginal kames are due to sub-glacial streams draining the edge of the ice-sheet. When the terminal moraine rested against an upward slope, this sub-glacial drainage was backward or into the ice. A study of the terminal moraine had led the author to the same conclusion, and a number of examples were given to show in certain places the absence of any drainage outwards from the glacier.

Finally, the sub-glacial drainage of the modern glaciers of Green-

land and of Alaska was alluded to, as also the aqueous nature of much of the till in the lowlands, all of which strengthened the conclusion arrived at concerning marginal kames, and concerning an extended sub-glacial drainage of the American ice-sheet.

The paper was illustrated by views of kames and moraines, most of them from photographs taken in the field.

9.—REPORT OF THE COMMITTEE<sup>1</sup> APPOINTED FOR THE PURPOSE OF INQUIRING INTO THE RATE OF EROSION OF THE SEA-COASTS OF ENGLAND AND WALES, AND THE INFLUENCE OF THE ARTIFICIAL ABSTRACTION OF SHINGLE OR OTHER MATERIAL IN THAT ACTION. DRAWN UP BY C. E. DE RANCE AND W. TOPLEY.

THE importance of the subject referred to this Committee for investigation is universally admitted, and the urgent need for inquiry is apparent to all who have any acquaintance with the changes which are in progress around our coasts. The subject is a large one, and can only be successfully attacked by many observers, working with a common purpose and upon some uniform plan.

The Committee has been enlarged by the addition of some members who, by official position or special studies, are well able to assist in the work.

In order fully to appreciate the influence, direct or indirect, of human agency in modifying the coast-line, it is necessary to be well acquainted with the natural conditions which prevail in the places referred to. The main features as regards most of the east and south-east coasts of England are well known; but even here there are probably local peculiarities not recorded in published works. Of the west coasts much less is known. It has therefore been thought desirable to ask for information upon many elementary points which, at first sight, do not appear necessary for the inquiry with which this Committee is entrusted.

A shingle-beach is the natural protection of a coast; the erosion of a sea-cliff which has a bank of shingle in front of it is a very slow process. But if the shingle be removed, the erosion goes on rapidly. This removal may take place in various ways. Changes in the natural distribution of the shingle may take place, the reasons for which are not always at present understood; upon this point we hope to obtain much information. More often, however, the removal is directly due to artificial causes.

As a rule, the shingle travels along the shore in definite directions. If by any means the shingle is arrested at any one spot, the coast-line beyond that is left more or less bare of shingle. In the majority of cases such arresting of shingle is caused by building out "groynes," or by the construction of piers and harbour-mouths which act as large groynes. Ordinary groynes are built for the purpose of

<sup>1</sup> Consisting of Major-General Sir A. Clarke, R.E., C.B., Sir J. N. Douglass, Captain Sir F. J. O. Evans, R.N., K.C.B., F.R.S., Capt. J. Parsons, R.N., Professor J. Prestwich, F.R.S., Capt. W. J. L. Wharton, R.N., Messrs. E. Easton, R. B. Grantham, J. B. Redman, J. S. Valentine, L. F. Vernon-Harcourt, W. Whitaker, and J. W. Woodall, with C. E. De Rance and W. Topley as Secretaries.

stopping the travelling of the shingle at certain places, with the object of preventing the loss of land by coast-erosion at those places. They are often built with a reckless disregard of the consequences which must necessarily follow to the coast thus robbed of its natural supply of shingle. Sometimes, however, the groyne fail in the purpose for which they are intended—by collecting an insufficient amount of shingle, by collecting it in the wrong places, or from other causes. These, again, are points upon which much valuable information may be obtained.

Sometimes the decrease of shingle is due to a quantity being taken away from the beach for ballast, building, road-making, or other purposes.

Solid rocks, or numerous large boulders, occurring between tide-marks, are also important protectors of the coast-line. In some cases these have been removed, and the waves have thus obtained a greater power over the land.

To investigate these various points is the main object of the Committee.

A large amount of information is already in hand, much of which has been supplied by Mr. J. B. Redman, who for many years has devoted special attention to this subject. Mr. R. B. Grantham has also made important contributions respecting parts of the south-eastern coasts.

But this information necessarily consists largely of local details, and it has been thought better to defer the publication of this for another year. Meanwhile the information referring to special districts will be made more complete, and general deductions may be more safely made.

As far as possible the information obtained will be recorded upon the six-inch maps of the Ordnance Survey. These give with great accuracy the condition of the coast, and the position of every groyne, at the time when the survey was made.

Appended is a copy of the questions circulated. The Committee will be glad of assistance, from those whose local knowledge enables them to answer the questions, respecting any part of the coast-line of England and Wales.

Copies of the forms for answering the questions can be had on application to the Secretaries.

#### APPENDIX—COPY OF QUESTIONS.

1. What part of the English or Welsh Coast do you know well? 2. What is the nature of that coast? (a) If cliffy, of what are the cliffs composed? (b) What are the heights of the cliff above H.W.M.? greatest; average; least. 3. What is the direction of the coast-line? 4. What is the prevailing wind? 5. What wind is the most important - (a) In raising high waves? (b) In piling up shingle? (c) In the travelling of shingle? 6. What is the set of the tidal currents? 7. What is the range of tide? Vertical in feet; width in yards between high and low water. At Spring tide, at Neap tide? 8. Does the area covered by the tide consist of bare rock, shingle, sand, or mud? 9. If of shingle, state—(a) Its mean and greatest breadth. (b) Its distribution with respect to tide-mark. (c) The direction in which it travels. (d) The greatest size of the pebbles. (e) Whether the shingle forms one continuous slope, or whether there is a “spring full” and “neap full.” If the latter, state their heights above the respective tide-marks. 10. Is the shingle accumulating or diminishing, and at what rate? 11. If diminishing, is this due partly or entirely to artificial abstraction? (See No. 13.) 12. If groyne are employed to

arrest the travel of the shingle, state—(a) Their direction with respect to the shore-line at that point. (b) Their length. (c) Their distance apart. (d) Their height—(1) When built. (2) To leeward above the shingle. (3) To windward above the shingle.—(e) The material of which they are built. (f) The influence which they exert. 13. If shingle, sand, or rock is being artificially removed, state—(a) From what part of the foreshore (with respect to the tidal range) the material is mainly taken. (b) For what purpose. (c) By whom—Private individuals, local authorities, public companies. (d) Whether half-tide reefs had, before such removal, acted as natural breakwaters. 14. Is the coast being worn back by the sea? If so, state—(a) At what special points or districts. (b) The nature and height of the cliffs at those places. (c) At what rate the erosion now takes place. (d) What data there may be for determining the rate from early maps or other documents. (e) Is such loss confined to areas bare of shingle? 15. Is the bareness of shingle at any of these places due to artificial causes? (a) By abstraction of shingle. (b) By the erection of groynes, and the arresting of shingle elsewhere. 16. Apart from the increase of land by increase of shingle, is any land being gained from the sea? If so, state—(a) From what cause, as embanking salt-marsh or tidal foreshore. (b) The area so regained, and from what date. 17. Are there “dunes” of blown sand in your district? If so, state—(a) The name by which they are locally known. (b) Their mean and greatest height. (c) Their relation to river mouths and to areas of shingle. (d) If they are now increasing. (e) If they blow over the land; or are prevented from so doing by “bent grass” or other vegetation, or by water channels. 18. Mention any reports, papers, maps, or newspaper articles that have appeared upon this question bearing upon your district (copies will be thankfully received by the Secretaries). 19. Remarks bearing on the subject that may not seem covered by the foregoing questions.

N.B.—Answers to the foregoing questions will in most cases be rendered more precise and valuable by sketches illustrating the points referred to.

---

## REVIEWS.

---

MANUAL OF GEOLOGY, THEORETICAL AND PRACTICAL. By JOHN PHILLIPS, LL.D., F.R.S. In Two Parts. Part I. PHYSICAL GEOLOGY AND PALÆONTOLOGY, by H. G. SEELEY, F.R.S. With Tables and Illustrations. 8vo. pp. xiv. and 546. (London: Charles Griffin & Co., 1885.)

THE publishers of the present Manual have evidently acted upon the conviction that the name of the veteran geologist, John Phillips, is as a strong tower, and still retains a charm for geologists.

And such indeed is doubtless the case amongst those scientific men who have a lively personal recollection of his speeches and discourses, but it can hardly weigh much with the generation of younger geologists, for whom the name will only sound as a faint echo from the past, awakening no vivid memories of pleasant days.

There can be no doubt as to the popularity which Prof. Phillips enjoyed, whether in connection with the Yorkshire Philosophical Society, the British Association, or the University of Oxford. His genial kindly manner to all, his happy and ready address, and the ease and fluency with which he spoke in public, all tended to make him a firm favourite among his contemporaries.

In these days of hurry, and eager competition for recognition, when the footprints of the pioneer of yesterday are speedily obliterated by the new man of to-day, there is a noble and kindly sentiment suggested in the retention of Phillips's name on the title of the present Manual. But as the last edition of Phillips's work



appeared in 1855, just 30 years ago, it is manifest that in so young, vigorous, and ever-growing a science as geology, nearly all that had been written previously to that date would need modification in a greater or less degree: in fact, that the clothes which sufficed it then are all too small to cover the strong limbs of the rising young science of 1885.<sup>1</sup>

The name of Professor Seeley, F.R.S., on the title-page, is an excellent guarantee that Part I. has been carefully prepared; whilst Part II. (Stratigraphical Geology), by Mr. Etheridge, F.R.S. (now in the press), will no doubt amply maintain the credit of this section of the work, which in its completed form will probably be more than twice as large as the original by Phillips.

In preparing, as the authors have done, a new edition of Phillips's Geology, in two volumes, the subject-matter has been somewhat differently arranged, and the whole re-cast, but little of the original remaining, as would naturally be expected under the circumstances. Commencing with the definition and origin of the science, Professor Seeley points out the various lines of inquiry which the geologist may follow, and briefly records the names of some of the early fathers of geology and their views, ending with the discoveries made by William Smith<sup>2</sup> (1790—1830) and the birth of palæontology in England. We have next to consider the mineral constituents of the aqueous and igneous rocks, and their characteristic structure, then the mode of formation of each, and all the subsequent changes they have undergone from agents of denudation and by upheaval, faulting, dislocation, etc. This naturally leads us to the consideration of the origin of Earth-sculpture into Islands and Continents, diversified by Mountains, Valleys, Table-lands and Plains, producing local variations in climate and all the modifications in the scenery of this and other lands.

Then follow chapters on Volcanic Energy and its manifestation in active Volcanoes, on the nature and origin of Igneous Rocks, their History and the concomitants and results of volcanic energy. To this succeed chapters on Metamorphism, Mineral veins, and on the chief mineral deposits in Britain.

The final chapters deal with the Biological aspect of Palæontology. Here we find discussed the origin, the extinction, succession, migration, persistence, distribution, relation and variation of species,—with other considerations, such as the identification of strata by Fossils; Homotaxis, Local Faunas, Natural History provinces and the relation of living to extinct forms. The last Chapter is on the Succession of Animal Life; from this we take the following summary:—

“If we endeavour to summarize the conclusions which the succession of life on the earth indicates, the most important generaliza-

<sup>1</sup> The date on the title-page.

<sup>2</sup> Better known as “Strata Smith;” and by the name given him by Professor Sedgwick “the Father of English Geology”—the uncle of Professor Phillips and his teacher in the science and practice of geology (see the Life of Phillips, *GEOL. MAG.* Vol. VII. 1870, pp 301–306).

tion is no doubt the fact that life now existing is substantially the same as life has been in all the past ages of time. The combination of the different groups of organisms is of like character, though the genera and species have varied. There is no trace of a beginning. There is evolution, but it is only the evolution of genera and of ordinal groups, and not of classes.

"It is chiefly by means of extinct families and orders that strata are characterized, and the periods of past time separated from each other; but when we bear in mind what the circumstances are which are causing extinction at the present day, we may doubt whether a classification so made is the best possible. Its method is unphilosophical. At least of equal importance with the occurrence of extinct types is the first appearance as elements in a fauna of genera and orders which still survive; for both are connected with the changed distribution of land and water which time has developed. The first appearance of organisms as a characteristic feature in a fauna would divide the strata differently from the extinct types, and would show how local are all the phenomena of the succession of life. Many groups of organisms which still survive appear plentifully in the Cretaceous rocks, so that a palæontological division might be drawn on the evidence of plants and fishes and many intermediate groups of organisms, which link the Lower Greensand with strata below, and the Gault with strata above. The Trias is sharply cut off from the Lias above and from the Permian rocks below. The Primary period is certainly divided into two, by a gap in succession of species between the uppermost beds of the Silurian and the lower part of the Devonian, which is not less marked than the other great changes in life, such as divide the Secondary and Tertiary rocks, or the Trias and Lias.

"The names Palæozoic, Mesozoic, and Cainozoic, therefore, do not represent completely palæontological facts, and the divisions which they indicate are artificial when studied in the light of the groups of animals composing the several faunas. The Sponges give no indication of the larger divisions of time; the Foraminifera introduce their new types gradually, so that we look to the Carboniferous rocks, the Trias, and the Chalk as furnishing the majority of existing genera. Amongst the corals, the Alcyonarians are scantily developed, yet date back to the older Primary rocks. The Rugosa are chiefly, though not exclusively, of Primary age; the Sclerobasic corals are not known prior to the Tertiary period; and the Perforata, which are common corals of the present day, date from the Cambrian rocks; the Aporosa are more numerous in the newer rocks than in the Primary period. The Sea-urchins would tend to unite Secondary and Tertiary rocks together, while some urchin type shows a remarkable connection between the Cretaceous and Tertiary periods. The Crinoids are an asthenoid<sup>1</sup> group most numerous in the Primary period; but otherwise have little value in stratigraphical classification. The living groups of Crustacea do not suggest any of the

<sup>1</sup> This term seems to have hitherto been applied in medicine only, to define diseases marked by *debility*; literally = weakly, feeble, infirm.

existing divisions of the strata, since the higher forms are chiefly known from the Lias, the Cambridge Greensand and the London Clay. The Lamellibranchiata furnish many surviving types in the Primary rocks, especially the Carboniferous; others become known in the Trias, Lias, Neocomian, Cretaceous, and Lower and Middle Tertiary. The Gasteropoda commence gradually, one or two with a formation, though they are most numerous in the Carboniferous, Lias, and Chalk, until the Lower Tertiary introduces the majority of living forms. Hence there are nine or ten great palæontological divisions of British strata.

“Palæontology has often been regarded merely as the aid which a naturalist contributes to the work of the stratigraphical geologist. But in addition to this work, which it was at first called upon to perform, palæontology has a more important rôle in the future history of science, in demonstrating the steps in the evolution and succession of faunas; and on this basis its evidence must always be important in forming a useful geological classification of strata. It also contributes important evidence of physical changes which took place in adjacent regions. But the physical and palæontological evidences rarely coincide; so that for some time to come stratigraphical classifications should be made independently, first upon the evidences of the Physical History of a Region, and secondly, upon its Succession of Life. The two methods may eventually be united, but it can only be by discovering the physical conditions which limited, determined, and changed the mineral characters of the strata, and changed the distribution of fauna and flora in the area which the strata occupy.”

It is difficult in the limited space at our command to do fitting justice to so large a work. The Palæontological chapters, although not more than one-fifth of the book, are replete with interest. (Some printer's errors need correction on p. 491, but these will doubtless be eliminated in the later copies.) It is satisfactory to know from Prof. Seeley that he has preserved every page of the original work that was in any way valuable. And also that notwithstanding the large additions and revisions, the spirit of the old book has been preserved, and that it has been revived with the spirit of the newer geology which is unfolding.

In these days of good books of all kinds, we are no longer at a loss to find a text-book upon a particular subject, but the serious question is rather which shall one choose? It is most satisfactory to be able to say that Professor H. G. Seeley has maintained in his *Physical Geology and Palæontology* the high reputation he already deservedly bears as a teacher, and that it reflects credit on the name of Phillips with which the work is associated. We shall look anxiously for the appearance of Mr. Etheridge's *New Year's Volume*,—*On Stratigraphical Geology and Palæontology*,—which is to form Part II. of the present work.

---

REPORTS AND PROCEEDINGS.

---

GEOLOGICAL SOCIETY OF LONDON.

November 5, 1884.—Prof. T. G. Bonney, D.Sc. LL.D., F.R.S., President, in the Chair.—The following communications were read:—

1. "On a New Deposit of Pliocene Age at St. Erth, 15 miles east of the Land's End, Cornwall." By S. V. Wood, Esq., F.G.S.

The deposit described in this paper occurs about five miles north-east of Penzance, and consists of a tenacious blue clay with shells, resting on sand, and passing upwards into a yellow unfossiliferous clay, which is overlain unconformably by the earth with angular fragments, under which the ancient beaches of the Bristol Channel (with which beaches, however, the deposit now described has no connexion) are buried. It has been excavated for the underlying sand at intervals during the last fifty years, but has been disused since 1881–82, when it was temporarily worked to supply the yellow part of the clay for the Penzance dock-works.

The author has got together, partly from correspondents in Cornwall and partly from his own researches in clay consigned to him, upwards of 40 species of Mollusca, inclusive of a few of which only fragments have as yet occurred, and of several minute species. Among these, besides some that are apparently altogether new, are some particularly characteristic species of the Red Crag not known living, such as *Cypræa (Trivia) avellana*, Sow.; *Melampus pyramidalis*, Sow.; and *Nassa granulata*, Sow. (or else *N. granifera*, Dujardin), as well as other characteristic Crag species that still live, but not north of the coast of Spain, such as *Turritella triplicata*, Brocchi (*T. incrassata*, Sow.), and *Ringicula buccinea*, Brocchi.

The most interesting feature of the fauna, however, consists in the six species of *Nassa* that the deposit has hitherto yielded, of which all but one, *N. granulata*, Sow. (or *granifera*, Dujardin), are unknown from any formation of Northern Europe, and occur, whether in the living or fossil state, only in the southern half of Europe.<sup>1</sup> One of these is *Nassa mutabilis*, Linné, which now lives throughout the Mediterranean, but outside that sea not north of Cadiz (lat. 36° 30'); and two others are new species of this exclusively southern *mutabilis*-group. Another seems to be a rare Italian Upper-Pliocene species of the *reticulata*-group, *N. reticostata*, Bellardi; while the sixth is the Lower Pliocene and Upper-Miocene species, *N. serrata*, Brocchi. This shell, in the variety of form it presents at St. Erth (where it is one of the most frequent shells), seems to connect the Red-Crag *N. reticosa*, Sow., with the Italian *N. serrata*, while the shorter forms of it are identical with the Italian Lower-Pliocene *N. emiliana*, Mayer. The fauna is altogether southern, no exclusively Arctic shell having as yet occurred in it.

The author regards the bed as clearly Pliocene, and inclines to

<sup>1</sup> *N. conglobata*, a species of a group near to that of *mutabilis*, has occurred in the Red Crag; but, so far as the author is aware, neither that shell, nor any of the group to which it belongs, has occurred in any other formation of Northern Europe.

the opinion that it is rather Newer than Older Pliocene; that is to say, it is coeval with the Red Crag, but its affinities are more with the Pliocene of Italy than with the Pliocene of the North-sea region; and this seems to show that during its deposition there was no communication between the Atlantic and the North Sea, except round the north of Britain, the refrigeration of the water by the nine degrees of latitude, through which Britain extends northwards from St. Erth, preventing the access of the Italian group of *Nassa* to that sea. This view is also strengthened by the absence of any close agreement between the fauna of St. Erth and that of the not far distant Pliocene of Normandy, the faunal affinities of both the older and newer parts of that Pliocene (the Conglomérat à Térébratules and Marnes à *Nassa*, regarded by geologists as of the age of the Coralline and Red Crags respectively) being more with the North-Sea Crag than with the St.-Erth bed.

As regards the geography of the immediate neighbourhood during its accumulation, the bed is the deposit of a strait that joined the sea on the north of Cornwall (St. Ives Bay) to that on the south of the county (Mounts Bay); and which insulated the high ground of the Land's-End district from the rest of Britain. The elevation of the shell-bearing part of the clay, as ascertained for the author by a set of levels run by Mr. Nicholas Whitley of Truro, C.E., who first brought the bed to public notice in the "Transactions of the Royal Geological Society of Cornwall," is 98 feet above mean-tide mark in the Hayle estuary, near to it, the surface of the ground being about 15 feet higher. Angular stones of small dimensions (none yet met with by the author exceeding 3 cubic inches) occur occasionally in the clay along with the shells, in amount of about one pound to a hundredweight of the clay, indicating apparently, the drift of coast-ice over the strait during the deposit; but the author has only noticed one rounded pebble in the clay he has searched through.

2. "The Cretaceous beds at Black Ven, near Lyme Regis, with some supplementary remarks on the Blackdown Beds." By the Rev. W. Downes, B.A., F.G.S.

The author described a new exposure of the Cretaceous deposits at Black Ven, and stated that the Cliff-section measures 300 feet in height, of which the Lias occupies 200 feet, and the Cretaceous beds the remaining 100 feet. Of the latter the lower 25 feet consists of black loamy clay, passing up into yellowish-brown non-calcareous sands 75 feet thick, capped with chert-gravel. From one point in the clay the author obtained a few fossils, the most abundant being *Lima parallela*. The overlying sands, of ordinary Greensand type, furnished no fossils, although traces of their former existence occurred in some abundance. The only species identifiable from the casts in loose sand was *Cyprina cuneata*. At about 50 feet, nearly in a straight line above the point in the Gault-clay where the author had obtained fossils, he discovered a small patch or nest of, mostly fragmentary silicified fossils, with a somewhat ferruginous matrix. The most abundant species were *Cyprina cuneata* and *Gervillia*

*rostrata*; the associated forms were *Cytheræa caperata*, *Trigonia scabricula*, *Cucullæa glabra* and *fibrosa*, *Cardium proboscideum*, *Pecten orbicularis* and *quinquecostatus*, *Turritella granulata*, *Exogyra*, *Phasianella*, *Serpula*, and *Siphonia*. Only one species is doubtfully common to the two horizons from which the fossils were procured, namely, *Turritella granulata*.

The author regards the fauna of the sands, thus revealed, as approaching the Blackdown fauna, and the sands as the equivalent beds. The absence of *Pectunculus umbonatus* and *sublævis* might serve to indicate that the sands at Black Ven were Lower Blackdown; but *Cyprina cuneata*, at Blackdown, characterizes a bed intermediate between those containing the above two *Pectunculi*. The evidence, in the author's opinion, seems to show an alternation of specific horizons, an inosculation due to changing littoral conditions, but with a general thinning-out to the westward, from which he concluded that the conditions of deposition were such that it will be impossible to recognize in the Cretaceous beds of the West of England the subdivisions of Gault and Upper Greensand which are so well marked to the eastward.

In conclusion, the author noticed some additions to his list of Blackdown and Haldon fossils, published in the "Quarterly Journal" for 1882.

3. "On Some Recent Discoveries in the Submerged Forest of Torbay." By D. Pidgeon, Esq., F.G.S.

The submerged forest of Torbay has been described by several geologists, amongst them by De la Beche, Godwin-Austen, and Pengelly. The latter, who has paid particular attention to the deposit, has inferred that a depression of 40 feet has taken place since the forest grew, and that the growth of the forest was at a period when the mammoth existed, a molar of that animal having been dredged at a depth of five or six fathoms, and having been apparently derived from the forest-bed.

The submerged forest rests upon a considerable thickness of clay, evidently the soil in which the trees grew. The clay rests upon Trias, a breccia of Devonian fragments intervening in places. This breccia appears to be of glacial age.

The gales of the winter of 1883-84 caused the exposure of considerable areas of the clay between tide-marks; and in one place, resting upon the breccia, two aggregations of rolled trap pebbles were found. These pebbles were shown to have probably served as smelting-hearths. In their neighbourhood an ingot of copper, a fragment of a second, some tin slag, a piece of glass, flint implements, and other articles were found, together with remains of piles driven into the ground. These traces of human work apparently belong to the Bronze age. In Goodrington Bay pewter vessels, apparently of Roman date, were found by the writer's son in a bed ten feet below high-tide mark, or at a lower level than that of the Bronze age relics.

After referring to the occurrence of some estuarine shells (*Scrobicularia*, *Hydrobia*, *Littorina*, and *Melampus*) in the clay near

Redcliffe Towers, at the level where similar mollusca now exist (an occurrence which may, however, be due to a recent mixing of deposits), the author pointed out that as the coast is known to have undergone no change of level for nearly 2000 years, it is unlikely that it can have been raised forty feet, and again depressed to the same extent, since the beginning of the Bronze period, not more than about fifteen centuries earlier. It is more probable that the clay bed was deposited in a shallow mere or marsh, of land-water kept back by the sea-beach, which was then some hundreds of feet further to seaward, and that the forest, which consisted chiefly of willows, grew on the marsh. The mammoth tooth may have been derived from an older deposit, all other remains of mammalia obtained from the Forest-bed belonging to animals still existing.

---



---

### CORRESPONDENCE.

---

#### NOTES ON THE SO-CALLED BUNTERSCHIEFER.

SIR,—Will you kindly afford me space for the purpose of recording a recent important discovery in connection with the lowermost strata of the German Trias, the so-called Bunterschiefer? In the July Number I drew attention to some important facts relating to the Dyas and Trias of Germany, and referred to the paper which has since appeared in the Quarterly Journal of the Geological Society, in which a further account is to be found of some sections which I made notes of on the spot during last year. I wish to draw particular attention to those which illustrate the succession of the Zechstein and the Bunter near Meerane, in Saxony. Since I gave an account of this, as it is exhibited in the quarries between that town and the village of Hainichen, the sections have been examined by Prof. Geinitz in company with Herr Dittmarsch, the Director of the Saxon Bergschule. In a letter to me, dated Dresden, September 3rd, Prof. Geinitz says:—"It will now interest you to know that in the first quarry between Hainichen and Meerane I have found, in the thin-bedded sandstones of the so-called Bunterschiefer, only a few metres above the Plattendolomit (Upper Zechstein), large casts of footprints of *Cheirosauros Barthi*, many small footprints of Saurians, a few Sponges, and in particular a *Rhizocorallium*, which indicates significantly enough that we have here to do with the lower strata of the Bunter Sandstone (the so-called lower Röth), and not with the strata of the Dyas."

As Prof. Geinitz proposed to give a full account of this at the recent meeting of the German Geological Society at Hanover, those who are interested in the question may look to the "Proceedings" of that Society for further particulars. A. IRVING.

EVENLEY, BRACKLEY.

---

#### THE SECTION AT HOPE'S NOSE

SIR,—I do not feel sure that the section, formerly examined by Mr. Horace B. Woodward, is the same as that, of which I have given a diagram; because he speaks of a quarry, whereas my section

was seen in a *cliff*. Upon looking also at the passage to which he refers in a former number of the *MAGAZINE*, I find a "quarry" mentioned, and it is stated that "the cliffs are for the most part abrupt, and can only be studied by the aid of a boat." There is, however, no difficulty in walking to the spot which I visited, and in viewing the cliff from the rocks at low water. Perhaps the same break in the strata can be seen at two neighbouring localities, and even if it should be, as Mr. Woodward thinks, due merely to a fault, still, as he justly observes, the bearing of the phenomena upon the question of cleavage "is in no way affected."

My diagram was made from a photograph, which shows likewise the "raised beach."

O. FISHER.

HARLTON, CAMBRIDGE, 4th Nov.

ADDITIONAL NOTE TO SIR WILLIAM DAWSON'S PAPER ON THE GEOLOGY OF EGYPT.

SIR,—In Number IV. of these notes, that on the Crystalline Rocks of Upper Egypt, I have mentioned the apparent absence of limestone from the Laurentian series as seen at Assouan. I should have added, however, that some of the crumbling schists seen in the low land east of the railway cutting resembled very closely the calcareous schists associated with the Grenville bed of Limestone on the Ottawa River, and gave the impression that Crystalline Limestone might not improbably occur in that vicinity.

ADDITIONAL ERRATA.

Page 440—line 3rd from top, for "of" read *for*.

Page 441—line 9 from bottom, for "two" read *also*.

Page 442—line 9 from top, for "cones" read *cover*.

J. W. DAWSON.

UNDER WHAT CIRCUMSTANCES IS AN ISLAND TO BE CONSIDERED "OCEANIC" ?

SIR,—If I correctly apprehend Mr. Fisher's reasoning, it is impossible to determine whether an island is "Oceanic" or not until it be known whether at any period in its geological history it has been connected with an existing continent. This is unfortunate; for the advocates of the permanency of oceans and continents insist that "oceanic islands" throw great light upon the problem. It would appear that they have been, as I pointed out in my first communication, arguing in a circle and from "phrases," not ascertained facts.

PARK CORNER, BLUNDELLSANDS,  
Nov. 6th, 1884.

T. MELLARD READE.

WE regret to record the deaths of three well-known geologists—Mr. Robert Alfred C. Godwin-Austen, B.A., F.R.S., F.G.S., of Shalford House, Guildford, on the 25th inst., in his 76th year; Dr. Thomas Wright, F.R.S., F.G.S., on the 17th inst., at St. Margaret's Terrace, Cheltenham, also in his 76th year; and Mr. (late Prof.) James Buckman, F.G.S., F.L.S., of Bradford-Abbas, Sherborne, Dorset, on the 21st inst.



# INDEX.

## ADA

- A**DAMS, F. D., The Norwegian 'Apatitbringer' in Canada, and Notes on Laurentian Amphibolites, 518.
- Æschna Flindersiensis*, H. Woodw. sp. nov., 337.
- Aganacanthus striatulus*, Traquair, gen. et sp. nov., 64.
- Alaria arenosa*, Hudleston, sp. n., 198.
- *pseudo-armata*, Hudles. sp. n., 150.
- *unicarinata*, Hudles., sp. n., 149.
- Allosaurus fragilis*, Marsh, 252.
- American and English Floras, Relative Ages of, by J. S. Gardner, 492.
- America, N., Eozoic Rocks of, by T. Sterry Hunt, 506.
- Anthracite Coal Region, by C. A. Ashburner, 463.
- Anthracotheriidae* of the Isle of Wight, by R. Lydekker, 547.
- Aporrhaïde*, British Eocene, by J. S. Gardner, 529.
- Aporrhaïis firma*, Gardner, sp. n., 533.
- *labellata*, Gard., sp. n., 531.
- *triangulata*, Gard., sp. n., 532.
- Appendages of Trilobites, by H. Woodward, 162.
- Locomotory, of Trilobites, by J. Mickleborough, 80.
- Archæastacus (Eryon) Willemæsii*, Bate, gen. et sp. nov., 307.
- Archæopteryx*, The Berlin, by W. Dames, 418.
- Ashburner, C. A., The Anthracite Coal Region, 463.
- Australia, Geological Survey of South, by H. Y. Lyell Brown, 29.
- S., Mollusca from, by W. H. Hudleston, 339.
- Trilobites from, by H. Woodward, 342.
- Avicula orbicularis*, Hudleston, sp. nov., 341.

- B**AILEY, L. W., The Acadian Basin in American Geology, 478.
- Ball, V., On the Mode of Occurrence of Precious Stones, etc., in India, 516
- Bate, C. Spence, On *Archæastacus (Eryon)* in the Lias, 307.
- Baerman, Hilary, Text Book of Descriptive Mineralogy, 424.

## CAR

- Bell, R. G., Land-shells in the Red Crag, 262.
- Bergen Peninsula, Dr. Reusch's Discovery of Silurian Fossils in the, 86.
- Beyrichia Nova-Scotica*, Jones and Kirkby, sp. nov., 358.
- Bibliography of North American Geology, by G. K. Gilbert, 562.
- Blackdown Beds, On the, by J. Starkie Gardner, 286.
- Blake, Prof. J. F., Criticisms on Recent Papers about Faults, 366.
- On the Volcanic Group of St. Davids, 92.
- Blanford, W. T., Classification of the Sedimentary Strata, 318.
- Geological Notes on the Hills near the Sind and Punjab Frontier, 371.
- Bohemian Chalk-formation, Sponges of the, by P. Počta, 281.
- Bone Caves of Poland, by F. Roemer, 169.
- Bonney, T. G., On the Archæan Rocks of Great Britain, 521.
- Pikrite, 96.
- On Serpentine, 406.
- Borough-Lee, Fish-remains from, by R. H. Traquair, 64.
- Bovey Basin, Discoveries in the, by W. Pengelly, 131.
- British Association at Montreal, 466-478, 513-523, 555-568.
- Brown, H. Y. Lyell, Geological Survey of S. Australia, 29.
- Budden, H. A., Coals of Canada, 560.
- C**ALLAWAY Dr. C., Archæan and Lower Palæozoic Rocks of Anglesey, 333.
- Notes on Progressive Metamorphism, 218.
- On a New Metamorphic area in Shropshire, 362.
- Canadian Record of Natural History and Geology, vol. i. No. 1 (Montreal, 1884), 464.
- Candona ? elongata*, Jones and Kirkby, sp. nov., 358.
- Carboniferous Entomostraca from Nova Scotia, by T. R. Jones and J. W. Kirkby, 356.

## CAR

- Carboniferous Limestone Trilobites, by H. Woodward, 484.
- Carboniferous Trilobite, On a New, by E. W. Claypole, 303.
- 
- by H. Woodward, 22. Synonymy of a,
- Carnivora and Rodentia, Fossil, by R. Lydekker, 442.
- Carnivores from the British Eocene, by W. Davies, 433.
- Ceratopsus nasicornis*, Marsh, 252.
- Cerithium? canineum*, Hudleston, sp. nov., 107.
- 
- (*Kelvertia*) *comptonense*, Hudleston, 62.
- 
- Leckenbyi*, Hudleston, sp. nov., 61.
- 
- turris*, Hudleston, sp. nov., 61.
- Champernowne, A., On some Zaphrentoid Corals from the British Devonian, 375.
- Cheviot Rocks, On some, by J. Petersen, 226.
- China, Palæontology of, by Baron Richthofen, 138.
- Classification of the Sedimentary Strata, by W. T. Blanford, 318.
- Claypole, Prof. E. W., On a new Carboniferous Trilobite, 303.
- 
- Pennsylvania before and after the elevation of the Appalachian Mountains, 434.
- 
- Remains of Fish from the U. Silurian of Pennsylvania, 519.
- Cleavage and Distortion, by O. Fisher, 396.
- Cleavage, Faulting and Jointing, by O. Fisher, 204, 266.
- Climate, Causes of Change of, by J. Gunn, 73, 125.
- Collins, J. H., On the Serpentine of Porthalla Cove, 141.
- Coals of Canada, by H. A. Budden, 560.
- Conocephalites australis*, H. Woodw., sp. nov., 344.
- Conoceras Llanvirnensis*, Roberts, sp. nov., 377.
- Continents, The Origin of, by W. O. Crosby, 46.
- Crag, Red, Land-Shells in the, by R. G. Bell, 262.
- Cretaceous Beds at Black Ven, by Rev. W. Downes, 573.
- Cretaceous Pterodactyls, American, by O. C. Marsh, 345.
- Crosby, Great, Keuper Marls at, by T. Mellard Reade, 445.
- Crosby, W. O., The Origin of Continents, 56.
- Ctenacanthus costellatus*, Traquair, sp. nov., 34.

## DOW

- Culm Fossils, list of, 538.
- Culm-Shales, Trilobites in the, by Dr. H. Woodward, 534.
- Cumberland Association, Transactions of, 179.
- Cytherea Woodwardiana*, Hudleston, sp. nov., 340.
- D**ALMANITES? *Cuyahogæ*, Claypole, 303.
- Dames, W., The Berlin *Archæopteryx*, 418.
- Damon, R., The Geology of Weymouth, 311.
- Dana, Dr. J. D., The Southward Ending of a Great Synclinal in the Taconic Range, 473.
- Davis, J. W., On Fossil Fish from the Yoredale Series at Leyburn, 91.
- Davies, Wm., Emu from the Wellington Caves, 265.
- 
- On some New Carnivores from the British Eocene, 433.
- Dawson, Sir Wm., Geology of the Nile-Valley, 289.
- 
- Notes on the Geology of Egypt, 385, 439, 481, 576.
- 
- The Ancient Land-Floras of the Old and New Worlds, 469.
- 
- Geology from Lake Superior to the Rocky Mountains, 283.
- Deposits, Metalliferous, by C. Ochsennius, 310.
- Deposit of Pliocene Age at St. Erth, by S. V. Wood, 572.
- De Rance, C. E., Tenth Report of the Underground Water Committee, 475.
- De Rance and Topley on Rate of Erosion of Sea coasts, 566.
- Despéret, C., The Pliocene and Quaternary Ruminants of the Auvergne, 463.
- Dinosaur, A New American, by O. C. Marsh, 99, 252.
- Diplodocus longus*, Marsh, sp. nov., 99.
- Dips, Notes on a Graphical Table of, by R. D. Oldham, 412.
- Distortion and Cleavage, by O. Fisher, 396.
- Distribution of Siwalik Mammals and Birds, by R. Lydekker, 489.
- Dolichometopus Tatei*, H. Woodw., sp. nov., 343.
- Domes in Sand, Miniature, by T. Mellard Reade, 20.
- Doughty, C. M., Outline of the Geology of Arabia, 142.
- Downes, Rev. W., on the Cretaceous Beds at Black Ven, 573.
- Duncan, Prof. P. Martin, *Galerites* and *Echinoconus*, 10.

## DUN

Duncan, Prof. P. Martin, On the Internal Structure of *Micrabacia coronula*, 375.

————— Reply to Prof.

Lindström, 239.

Durham, J., On Elevation and Subsidence, 287.

Dust and Soil, by Clement Reid, 165.

**E***CHINOCONUS conicus*, Breynius, by P. Martin Duncan, 10.

*Echinocaris*, Palæozoic Phyllopodiform Crustaceans, by T. R. Jones, and H. Woodward, 393.

Egypt, Notes on the Geology of, by Sir Wm. Dawson, 385, 439, 481, 576.

*Eichwaldia Capewelli*, Shell Structure of, by J. Young, 214.

Elevation and Subsidence, by J. Starkie Gardner, 190.

————— by J. Durham, 287.

*Elonichthys arthrolepis*, Traquair, sp. nov., 8.

Elwes, J. W., The Middle Headon Beds, 94.

————— London Clay at Southampton, 548.

Emu from the Wellington Caves, by Wm. Davies, 265.

English and American Floras, Relative Ages of, by J. S. Gardner, 492.

Entomostraca, Carboniferous, from Nova Scotia, by T. R. Jones and J. W. Kirkby, 356.

Eocene, British, Carnivores from, by Wm. Davies, 433.

Eozoic Rocks of N. America, by T. Sterry Hunt, 536.

Erosion of Sea-coasts, by C. E. De Rance and W. Topley, 566.

*Eryon (Archæastacus)* in the Lias, by C. Spence-Bate, 307.

Eskdale, A New Fossil Shark from, by R. H. Traquair, 3.

————— A New Species of *Elonichthys* from, by R. H. Traquair, 8.

Eunson, H. J., The Range of the Palæozoic Rocks beneath Northampton, 373.

Evolution of Life in Palæozoic Times, by A. Gaudry, 32.

**F**AULTED Slate, A, by G. H. Kinahan, 123.

————— By J. J. Harris Teall, 1.

Faulting, Jointing and Cleavage, by O. Fisher, 204, 266.

Faults, by A. F. Griffith, 429.

Faults, by O. Fisher, 428.

## GER

Faults, Criticisms on Recent Papers about, by J. F. Blake, 366.

Ferns of the Coal-Measures, by D. Stur, 328.

Field-Geology, Graphical Methods in, by A. Harker, 154.

Fisher, Rev. O., Faults, 428.

————— On Cleavage and Distortion, 396.

————— On Faulting, Jointing and Cleavage, 204, 266.

————— Section at Hope's Nose, 575.

————— On S. Georgia, 525.

————— The Permanence of Ocean Basins, 431, 515.

Fish-Remains from Borough Lee, by R. H. Traquair, 64.

Flora, Relative Ages of American and English, by J. S. Gardner, 492.

Foster, C. Le Neve, What is a Mineral Vein or Lode?, 513.

Forsyth-Major, Dr. C. J., On the Pliocene Mammalian Fauna of the Val d'Arno, 383.

**G***ALERITES albogalerus*, Lamk., by P. Martin Duncan, 10.

Gardner, J. Starkie, British Eocene *Aporrhaidæ*, 529.

————— Elevation and Subsidence, 190.

————— On the Blackdown Beds, 286.

————— Relative Ages of American and English Floras, 492.

Gaudry, Prof. A., Evolution of Life in Palæozoic Times, 32.

————— On a Sirenian from the Paris Basin, 462.

*Gazella anglica*, sp. nov., E. T. Newton, 235.

Geological Congress, International, 432.

Geological Society of London, Proceedings of, 41, 43, 91, 92, 141, 143, 181, 186, 187, 234, 236, 283, 285, 332, 333, 373, 376, 572.

Geological Survey Maps, On the, by T. V. Holmes, 240.

Geological Surveys of Europe, Report on, by W. Topley, 447.

Geology, Introduction to, by E. Hébert, 40.

Geology of the Nile Valley, by Sir W. Dawson, 289.

Georgia, S., The Island of, by O. Fisher, 525.

————— by T. Mellard Reade, 225, 480, 576.

*Gervillia angusta*, sp. nov., Hudleston, 341.

## GIL

- Gilpin, E., Distinctive Features of Nova Scotian Coalfields, 467.  
 ——— On Gold-mining, 563.
- Gilbert, G. K., North American Geology, 562.
- Godwin-Austen, Lt.-Col. H. H., A New Railway-cutting at Guildford, 334.  
 ——— Observations on certain Tertiary Formations S. of the Alps, 379.
- Graphical Methods in Field Geology, by A. Harker, 154.
- Griffith, A. F., Faults, 429.
- Griffithides brevispinus*, H. Woodw., sp. nov. 484, 489.  
 ——— *Carringtoniana*, H. Woodw., sp. nov. 486, 489.  
 ——— *glaber*, H. Woodw. sp. nov. 485, 489.
- Gunn, John, Causes of Change of Climate, 73, 125.  
 ——— The Mammoth in the Forest Bed, 47.
- H**ALITHERIUM *Chouqueti*, sp. nov., Gaudry, 462.
- Hall, Prof. J., On the Lamellibranchiate Fauna, 559.  
 ——— Fossil Reticulate Sponges, 557.
- Hallett, P., Notes on Niagara, 563.
- Harker, A., Graphical Methods in Field Geology, 154.  
 ——— Packing of Sand-grains, 479.  
 ——— Space between Grains of Sand, 192.
- Headon, Middle-marine Beds, by H. Keeping, 95.  
 ——— by J. W. Elwes, 94.
- Hébert, Prof. E., Introduction to Geology, 40.
- Hicks, Dr. Henry, On the Cambrian Conglomerates in Anglesey and Caernarvonshire, 43.  
 ——— On the Pre-Cambrian Rocks of St. Davids, 285.  
 ——— Rock Specimens from Anglesey and Caernarvonshire, 43.
- Hill, Rev. E., On Ice-age Theories, 513.  
 ——— The Rocks of Guernsey, 236.
- Hinde, Dr. G. J., Fossil Sponges, 132.  
 ——— On some Fossil Calci-sponges from the Well-boring at Richmond, 377.  
 ——— On the Structure and Affinities of the Family *Receptaculitida*, 382.
- Hinge of *Spirifer*, by John Young, 18.
- Hochstetter, Dr. Ferdinand von, Obituary of, 526.

## KEN

- Holmes, T. V., On the One-inch Geological Survey Map, 240.
- Hope's Nose, Section at, by H. B. Woodward, 524, 575.
- Hudleston, W. H., Contributions to the Palæontology of the Yorkshire Oolites, 49, 107, 146, 193, 241, 293.  
 ——— Mollusca from S. Australia, 339.
- Hughes, T. McKenny, The International Geological Congress, 432.  
 ——— On *Spongia paradoxica*, 185.  
 ——— On Tracks of Terrestrial and Fresh-water Mammals, 42.
- Hutton, Capt. F. W., On the Geological Position of the Weka-pass Stone, 379.
- Hunt, T. Sterry, Eozoic Rocks of N. America, 566.  
 ——— Geological History of the Serpentine, 276.
- I**RVING, Rev. A., On the Permian Trias of Central Europe, 284.  
 ——— The Permian-Trias Question, 45, 192, 321.  
 ——— On the so-called Bunterschiefer, 575.
- J**ONES, Prof. T. R., On Carboniferous Entomostraca from Nova Scotia, 356.  
 ——— On Palæozoic Phyllo-poda, 348.  
 ——— On the genus *Echinocaris*, 393.  
 ——— On the Foraminifera and Ostracoda from the Well-boring at Richmond, 377.  
 ——— On the Geology of Newbury, 122.  
 ——— On the Geology of S. Africa, 476.
- Judd, Prof. J. W., Nature of the Jurassic Deposits under London, 143.  
 ——— Notes on the Jurassic Rocks which underlie London, 376.
- Jukes-Browne, A. J., Classification of Jurassic Strata, 525.  
 ——— Handbook of Physical Geology, 461.  
 ——— Post-Glacial Ravines in the Chalk-wolds of Lincolnshire, 45.
- Jurassic Dinosaur, A New American, by O. C. Marsh, 99, 252.
- Jurassic Strata, Classification of, by A. J. Jukes-Browne, 525.
- K**EEPING, H., The Middle Headon Marine Beds, 95.
- Kendall, P. F., On Slickensides, 551.

## KEU

- Keuper Marls at Great Crosby, by T. Mellard Reade, 445.  
 Kidston, R., On the Fructification of *Zeilleria*, 335.  
 Kinahan, G. H., A Faulted Slate, 123.  
 Kirkby, J. W., On Carboniferous Entomostraca from Nova Scotia, 356.  
 Koto, Dr. B., Studies on some Japanese Rocks, 238.

- LACROIX, A., On Crystals of Olivine in Sands of the Isle of Bourbon, 465.  
 Lamellibranchiate Fauna, On the, by Prof. James Hall, 559.  
 Lamplugh, G. W., Boulder-clay at Bridlington, 185.  
 Land Shells in the Red Crag, By R. G. Bell, 262.  
 Lewis, H. G., On Marginal Kames, 565.  
 Lias, *Archæastacus (Eryon)*, in the, by C. Spence Bate, 307.  
 Libyan Desert, Geology and Palæontology of the, by Prof. Karl Zittel, 172.  
 Lindström, G., *Palæocyclus Fletcheri*, 190.  
 ———— Reply to, by P. Martin Duncan, 239.  
 List of Papers read in Section C (Geology), British Association, 555.  
 Lizard District, Serpentine of, by A. Somervail, 479.  
 London Clay at Southampton, by J. W. Elwes, 548.  
*Lycaon anglicus*, sp. nov., Lydekker, 443.  
 Lydekker, R., Fossil Carnivora and Rodentia, 442.  
 ———— On a new Species of *Merycopotamus*, 545.  
 ———— On the *Anthracotheriida*, 547.  
 ———— On the Distribution of Siwalik Mammals and Birds, 489.  
 ———— Indian Tertiary Mammalia, 424.

- MACKAY, A. H., On Lacustrine Deposits, 561.  
 Mammalia, Indian Tertiary, by R. Lydekker, 424.  
 Mammoth, in the Forest Bed, by J. Gunn, 47.  
 Marcou, Jules, The Permian-Trias Question, 97.  
 Marginal Kames, by H. C. Lewis, 565.  
 Marsh, Prof. O. C., New Jurassic Dinosaurs, 99, 252.  
 ———— On the American Cretaceous Pterodactyls, 345.

## NEW

- Martin, Prof. K., On the Erratic Stones of Overysseel, 462.  
 Matthew, G. F., The Geological Age of the Acadian Fauna, 470.  
 ———— The Primitive Conocoryphean, 471.  
 Mead-End Bed, The Long, by S. V. Wood, 65.  
*Megalichthys laticeps*, sp. nov., Traquair, 121.  
*Megalichthys*, On the Genus, by R. H. Traquair, 115.  
 Mello, Rev. J. Magens, On a Specimen of Iron Amianthus, 332.  
 Merritt, W. H., Economic Minerals of Canada, 521.  
*Merycopotamus nanus*, Lydek., sp. nov., 545.  
 Metalliferous Deposits, by C. Ochsenius, 310.  
 Metamorphic Area in Shropshire, by C. Callaway, 362.  
 Metamorphism, Notes on Progressive, by C. Callaway, 218.  
 Metcalf, A. T., Vertebrata from the Trias of the South Coast of Devon, 94.  
 Miall, Prof. L. C., On *Megalichthys* from the Yorkshire Coal-fields, 237.  
 Mickleborough, J., Locomotory Appendages of Trilobites, 80.  
 Miller, Hugh, On Fluxion-Structure in Till, 472.  
 Mineralogy, Text-Book of Descriptive, by H. Bauerman, 424.  
 Moa-Bones in New Zealand, by C. Smith, 129.  
*Modiola linguloides*, sp. nov., Hudleston, 341.  
 Mollusca, from South Australia, by W. H. Hudleston, 341.  
 Montreal, British Association at, 466, 513, 555.  
 Montreal, Proceedings of Nat. Hist. Soc. of, 464.  
*Myacites Australis*, sp. nov., Hudleston, 340.
- NEUROPTEROUS Wing from Queensland, by H. Woodward, 337.  
 Newberry, J. S., New Fossil Fishes in the Carboniferous and Devonian of Ohio and Indiana, 523.  
 ———— Phases in the Evolution of the North American Continent, 522.  
 Newbury, On the Geology of, by T. R. Jones, 122.  
 Newton, E., Antelope Remains from the British Newer Pliocene Beds, 255.  
 New Zealand, Moa-Bones in, by C. Smith, 129.

## NIL

- Nile Valley, Geology of the, by Sir J. W. Dawson, 289.  
 Notes on Niagara, by P. Hallett, 563.  
 Nottingham, Geological Map of, 480.  
 Nova Scotia, Carboniferous Entomostrea from, by T. R. Jones and J. W. Kirkby, 356.  
 \_\_\_\_\_ Gold Mining in, by E. Gilpin, 564.

**O**BITUARY of Dr. Ferdinand von Hochstetter, 526.

- Ocean-Basins, The Permanence of, by O. Fisher, 431, 525.  
 Ochsenius, Dr. C., On Metalliferous Deposits, 310.  
 Oldham, R. D., On a Graphical Table of Dips, 412.  
 Olivine Crystals in Sands of the Isle of Bourbon, by A. Lacroix, 465.  
 Oolites, the Yorkshire, Contributions to the Palæontology of, by W. H. Hudleston, 49, 107, 146, 193, 241, 293.  
 Origin of Marl Bands in Chalk, by P. F. Kendall, 551.  
 Overysse, Notes on the Erratic Stones of, by P. Martin Duncan, 462.  
 Owen, Sir Richard, Cranial and Vertebral Characters of the Crocodilian Genus *Plesiosuchus*, 42.  
 \_\_\_\_\_ Retirement of, 96.  
 \_\_\_\_\_ *Rhytidosteus campensis*, 234.  
 \_\_\_\_\_ The Skull of a Triassic Mammal, 41.  
 \_\_\_\_\_ On *Tritylodon*, 286.

**PALÆOCYCLUS** *Fletcheri*, by G. Lindström, 120.

- Palæozoic Phyllopoda, by T. R. Jones and H. Woodward, 348.  
 Pantou, J. H., Gleanings from Silurian Outcrops in Red River Valley, Manitoba, 474.  
 Paris Basin, Sirenian from, by A. Gaudry, 462.  
 Parker, Dr. G. W., Notes on the Geology and Mineralogy of Madagascar, 383.  
 Parkinson, C., The Droitwich Brine Springs and Saliferous Marl, 92.  
 Pengelly, W., Discoveries in the Bovey Basin, 131.  
 Penning, W. H., Sketches of South African Geology, 189.  
 Permian-Trias Question, The, by A. Irving, 45, 192, 321.  
 \_\_\_\_\_ by Jules Marcou, 97.  
 Petersen, Dr. J., On Some Cheviot Rocks, 226.

## REA

- Phillips's Manual of Geology, 568.  
*Phillipsia articulosa*, H. Woodw., sp. nov., 489, 544.  
 \_\_\_\_\_ *carinata*, H. Woodw., sp. nov., 488, 489.  
 \_\_\_\_\_ *Cliffordi*, H. Woodw., sp. nov., 489, 544.  
 \_\_\_\_\_ *gemmulifera*, Synonymy of, by H. Woodward, 22.  
 \_\_\_\_\_ *Leei*, H. Woodw. sp. nov., 489, 541.  
 \_\_\_\_\_ *laticaudata*, H. Woodw., sp. nov., 486, 489.  
 \_\_\_\_\_ *minor*, H. Woodw., sp. nov., 489, 543.  
 \_\_\_\_\_ *scabra*, H. Woodw., sp. nov., 487, 489.  
 Phyllopoda, Palæozoic, by T. R. Jones and H. Woodward, 348.  
 Phylloporiform Crustacean, of the Genus *Echinocaris*, Palæozoic, by T. R. Jones and H. Woodward, 393.  
 Physical Geology, Handbook of, by A. J. Jukes-Browne, 461.  
 Pidgeon, D., On the Submerged Forest of Torbay, 574.  
 Pikrite, by T. G. Bonney, 96.  
 Pikrite-boulders in Anglesey, by Capt. J. Plant, 48.  
 Plant, John, The Pikrite-boulders in Anglesey, 48.  
 Pliocene and Quaternary Ruminants of the Auvergne, by C. Despéret, 463.  
 Poëta, Philip, Sponges of the Bohemian Chalk Formation, 281.  
 Progressive Metamorphism, by C. Callaway, 218.  
 Pterodactyls, On the American Cretaceous, by Prof. O. C. Marsh, 345.  
*Pteranodon longiceps*, Marsh, 343.
- QUEENSLAND**, Neuropterous Wing from, by H. Woodward, 337.  
 Quilter, H. E., The Rhaetic Section at Wigston, Leicestershire, 415.
- READE**, T. Mellard, A Section of Keuper Marls at Great Crosby, 445.  
 \_\_\_\_\_ Deltas in Miniature, 143.  
 \_\_\_\_\_ Miniature Domes in Sand, 20.  
 \_\_\_\_\_ Ripple Marks in Drift, 187.  
 \_\_\_\_\_ Rocks from the S. of Scotland imbedded in the Boulder-Clay of Lancashire, 186.  
 \_\_\_\_\_ Space Occupied by Grains of Sand, 288.  
 \_\_\_\_\_ The Island of S. Georgia, 225, 480.

## REA

- Reade, T. Mellard, Under what circumstances is an island to be considered oceanic? 576.
- Reid, Clement, Dust and Soils, 165.
- Reticulate Sponges, on the, by Prof. Hall, 557.
- Reusch's Discovery of Silurian Fossils in the Bergen Peninsula 85.
- Review of Phillips' Geology, part i., 568.
- Rhætic Section at Wigston, Leicestershire, by E. Wilson and H. E. Quilter, 415.
- Rhytidosteus capensis*, sp. n., Owen, 234.
- Richardson, R., The Acadian and Scottish Glacial Beds, 517.
- Richthofen, Baron, China, Palæontology of, 138.
- Roberts, T., On a Species of *Conoceras* from the Llanvirn Beds, Pembroke-shire, 377.
- Roemer, Prof. F., The Bone Caves of Poland, 169.
- Rodentia and Carnivora, Fossil, by R. Lydekker, 442.
- Russia, The Geological Committee of, 84.
- Rutley, F., On Strain in connection with Crystallization and Perlitic Structure, 188.
- SAND Grains, Packing of, by A. Harker, 479.
- Sand, Miniature Domes in, by T. Mellard Reade, 20.
- Sand, Space between Grains of, by A. Harker, 192.
- Sand, Space Occupied by Grains of, by T. Mellard Reade, 288.
- Seaton, Dr. E., Annual Health Report for Nottingham, with Geological Map, 480.
- Sedimentary Strata, Classification of, by W. T. Blanford, 318.
- Serpentines, etc., Geological History of, by T. Sterry Hunt, 276.
- Serpentines, Remarks on, by Prof. T. G. Bonney, 406.
- Shark, A New Fossil, by R. H. Traquair, 3.
- Shropshire, A New Metamorphic Area in, by C. Callaway, 362.
- Siliceous Organic Remains of the Lacustrine Deposits, by A. H. Mackay, 561.
- Sind and Punjab Frontier, Geological Notes on the Hills near the, by W. T. Blanford, 371.
- Sirenian from the Paris Basin, by Prof. A. Gaudry, 462.
- Sivalik Mammals and Birds, Distribution of, by R. Lydekker, 489.
- Slate, A Faulted, by G. H. Kinahan, 23.
- Slate, A Faulted, by J. J. Harris Teall, 1.

## TRI

- Slickensides, by P. F. Kendall, 551.
- Smith, C., Moa Bones in New Zealand, 129.
- Smith, G. Varty, Further Discoveries of Footprints of Vertebrata in the Lower New Red, 336.
- Soils and Dust, by Clement Reid, 165.
- Somervail, A., On the Serpentine of the Lizard District, 479.
- Spearing, H. G., Recent Encroachment of the Sea in W. Devon, 335.
- Spirifer*, On the Hinge of, by J. Young, 18.
- Sponges, Fossil, by G. J. Hinde, 132.
- Sponges of the Bohemian Chalk Formation, by Philip Počta, 281.
- Spongia paradoxica*, by T. McKenny Hughes, 185.
- Stanley, W. F., A Correction in the Amount of Energy formed by the Cooling of the Earth, 376.
- On Glacial Period in Northern Hemisphere not being due to Eccentricity of the Earth's Orbit, 518.
- Structure of the Shell of *Eichwaldia Capewelli*, by J. Young, 214.
- Structure of Trilobites, by H. Woodward, 78.
- Stur, Dr. D., On the Fossil Ferns of the Coal-Measures, 328.
- Submerged Forest at Torbay, by D. Pigeon, 574.
- Surveys of Europe, Geological, by W. Topley, 447, 524.
- TEALL, J. J. Harris, A Faulted Slate, 1.
- On the Chemical and Microscopical Characters of the Whin Sill, 380.
- Petrological Notes on some N. of England Dykes, 92.
- Tomes, R. F., A Critical and Descriptive List of the Oolitic Madreporaria of the Boulonnais, 381.
- The Madreporaria of the White Lias of England, 236.
- Topley, W., Geological Surveys of Europe, 447, 524.
- Erosion of sea-coasts, 566.
- Traquair, R. H., A New Species of Fossil Shark, 3.
- Fish-Remains from Borough Lee, 64.
- On a New Species of *Elonichthys*, 8.
- On the Genus *Megalicthys*, 115.
- Trias-Permian Question, by A. Irving, 192, 321.

## TRI

- Trias-Permian, The, by Jules Marcou, 97.  
*Triglyphus*, by Sir R. Owen, 286.  
 Trilobites, Appendages of, by H. Woodward, 162.  
 Trilobites, Carboniferous Limestone, by H. Woodward, 484.  
 Trilobite, Carboniferous, On a New genus of, by E. W. Claypole, 303.  
 Trilobites in the Culm of Devonshire, by Dr. H. Woodward, 534.  
 Trilobites, from S. Australia, by H. Woodward, 342.  
 Trilobites, Locomotory Appendages of, by J. Mickleborough, 80.  
 Trilobites, On the Structure of, by H. Woodward, 78.  
*Tritylodon*, by Sir R. Owen, 286.  
*Tritylodon longævus*, sp. nov., Owen, 41.

VINE, G. R., Notes on some Cretaceous Lichenoporidae, 384.  
 ———— Polyzoa from the Well-Boring at Richmond, 377.  
*Viverra Hastingsiæ*, sp. nov., Davies, 433.

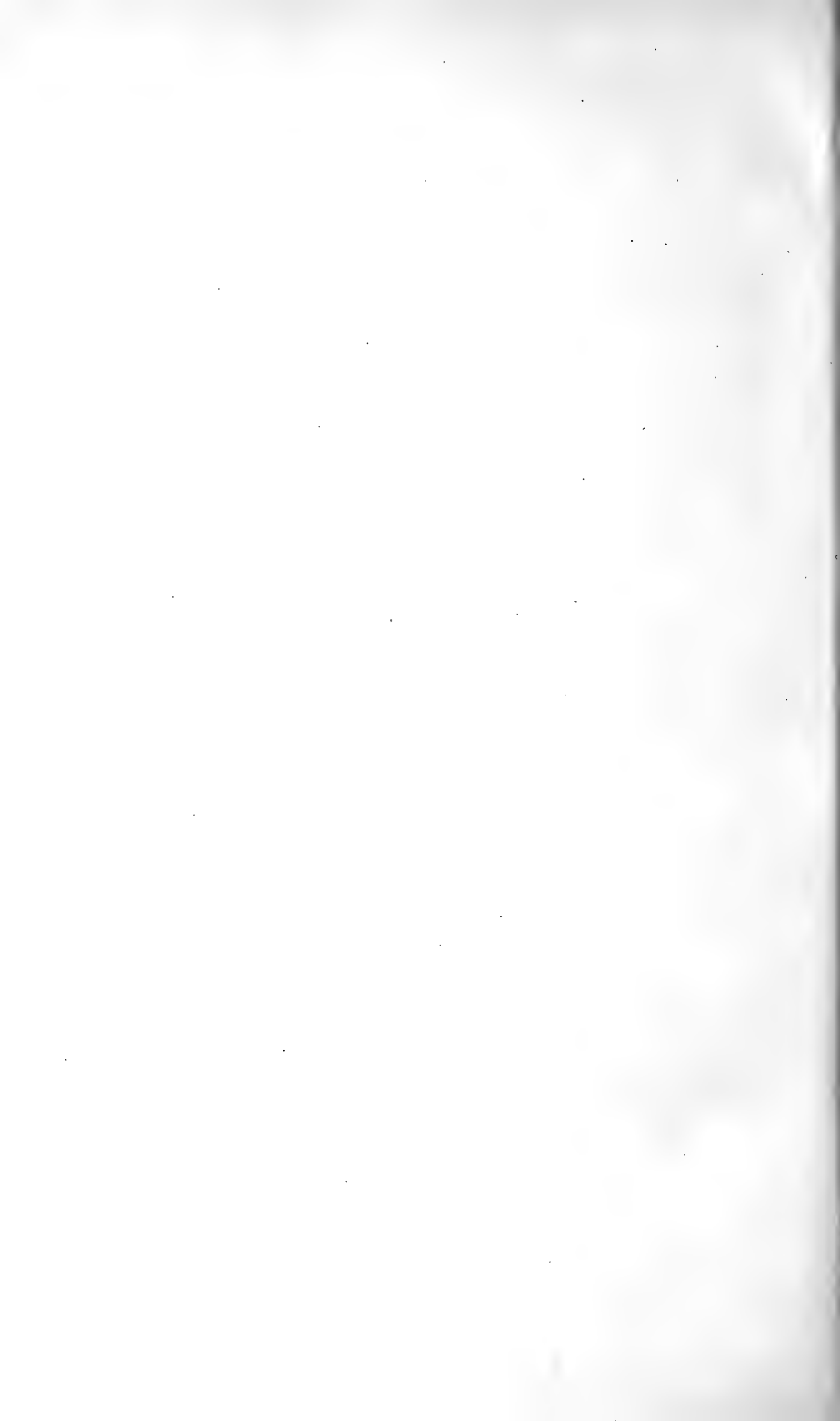
- WATERS, A. W., Fossil Cyclostomatous Bryozoa from Australia, 378.  
 Water-Supply from the Chalk, by W. Whitaker, 23.  
 Wellington Caves, Emu from the, by W. Davies, 265.  
 Wethered, E., On the Structure and Formation of Coal, 187.  
 ———— On the Structure of English and American Carboniferous Coals, 515.  
 Weymouth, Geology of, by R. Damon, 511.  
 Whitaker, W., The Value of a Geological Map in Relation to Water-Supply, 468.

## ZIT

- Whitaker, W., Water-Supply from the Chalk, 23.  
 Wigston, Leicestershire. Rhætic Section at, by E. Wilson and H. E. Quilter, 415.  
 Wilson, E., The Rhætic Section at Wigston, Leicestershire, 415.  
 Wood, S. V., On a New Deposit of Pliocene age at St. Erth, 572.  
 Wood, S. V., The Long Mead-End Bed, 65.  
 Woodward, Dr. H., Appendages of Trilobites, 162.  
 ———— On a Neuropterous Wing from Queensland, 337.  
 ———— On Carboniferous Limestone Trilobites, 484.  
 ———— On Palæozoic Phyllopoda, 348.  
 ———— On Palæozoic Phyllopoda, Genus *Echinocaris*, 393.  
 ———— On the Structure of Trilobites, 78.  
 ———— Synonymy of *Philipsia gemmulifera*, 22.  
 ———— Trilobites in the Culm of Devonshire, Discovery of, 534.  
 ———— Trilobites from S. Australia, 342.  
 Woodward, H. B., The Section at Hope's Nose, 525.  
 Wright, Dr. T., Death of, 576.
- YORKSHIRE Oolites, Contributions to the Palæontology of, by W. H. Hudleston, 49, 107, 146, 193, 241, 293.  
 Young, J., Shell Structure of *Eichwaldia Capewelli*, 214.  
 ———— Spirifer, On the Hinge of, 18.
- ZITTEL, Prof. Karl, Geology and Palæontology of the Libyan Desert, 172.













# CABOT SCIENCE LIBRARY

HARVARD COLLEGE, CAMBRIDGE, MA 02138

(617) 495-5355

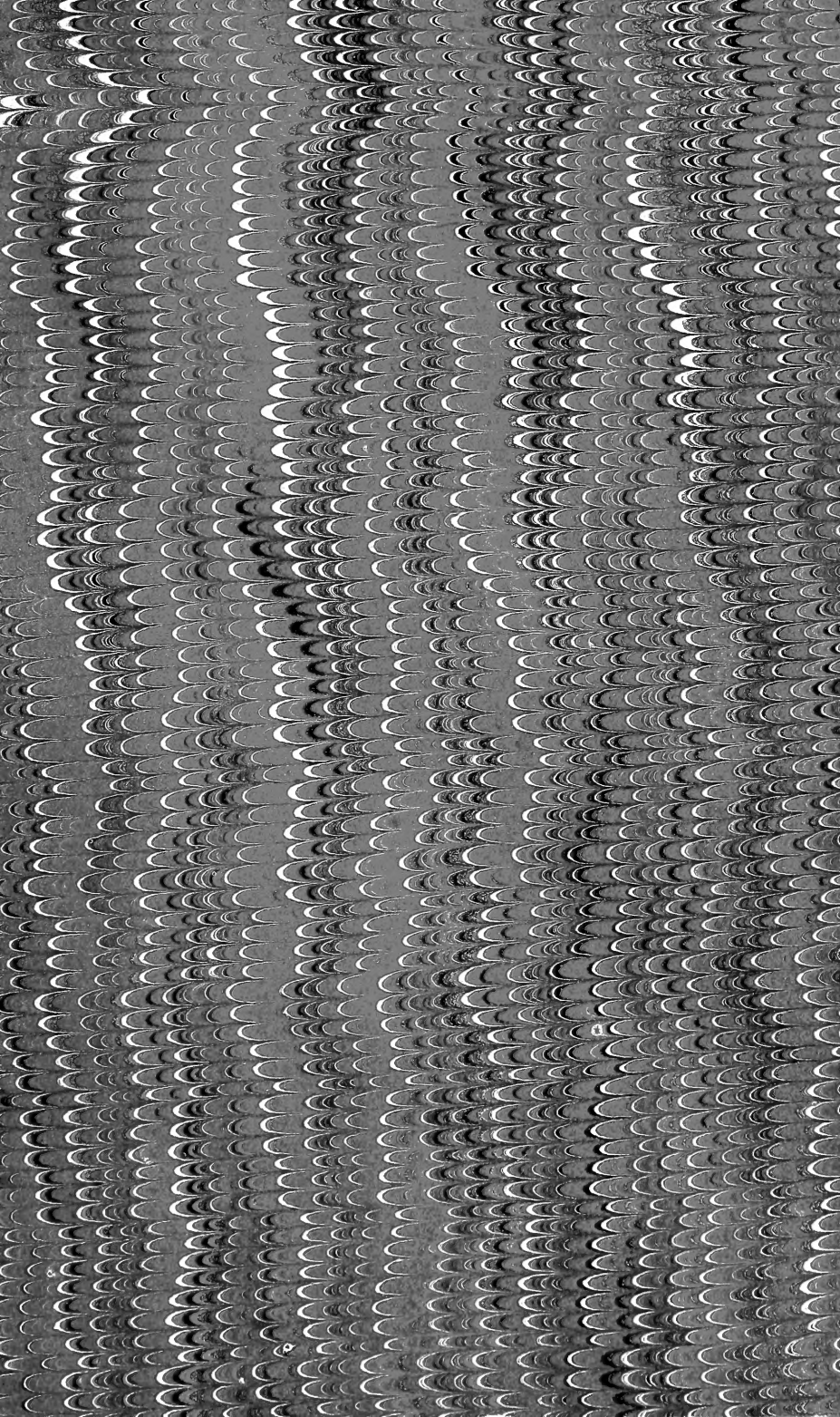
Borrowers are responsible for the proper care and timely return of Library materials. Please return this item directly to Cabot by the date stamped below to avoid fines. A full policy statement is available at the Circulation Desk.

CABOT

SEP 10 2010

BOOK DUE

|  |  |
|--|--|
|  |  |
|  |  |
|  |  |





3 2044 102 911 963

