





BANCROFT  
LIBRARY



THE LIBRARY  
OF  
THE UNIVERSITY  
OF CALIFORNIA

Andrew Lawson

Digitized by the Internet Archive  
in 2007 with funding from  
Microsoft Corporation





HEAD OF IOWA GULCH

DEPARTMENT OF THE INTERIOR

---

MONOGRAPHS

OF THE

UNITED STATES GEOLOGICAL SURVEY

VOLUME XII



WASHINGTON  
GOVERNMENT PRINTING OFFICE  
1886

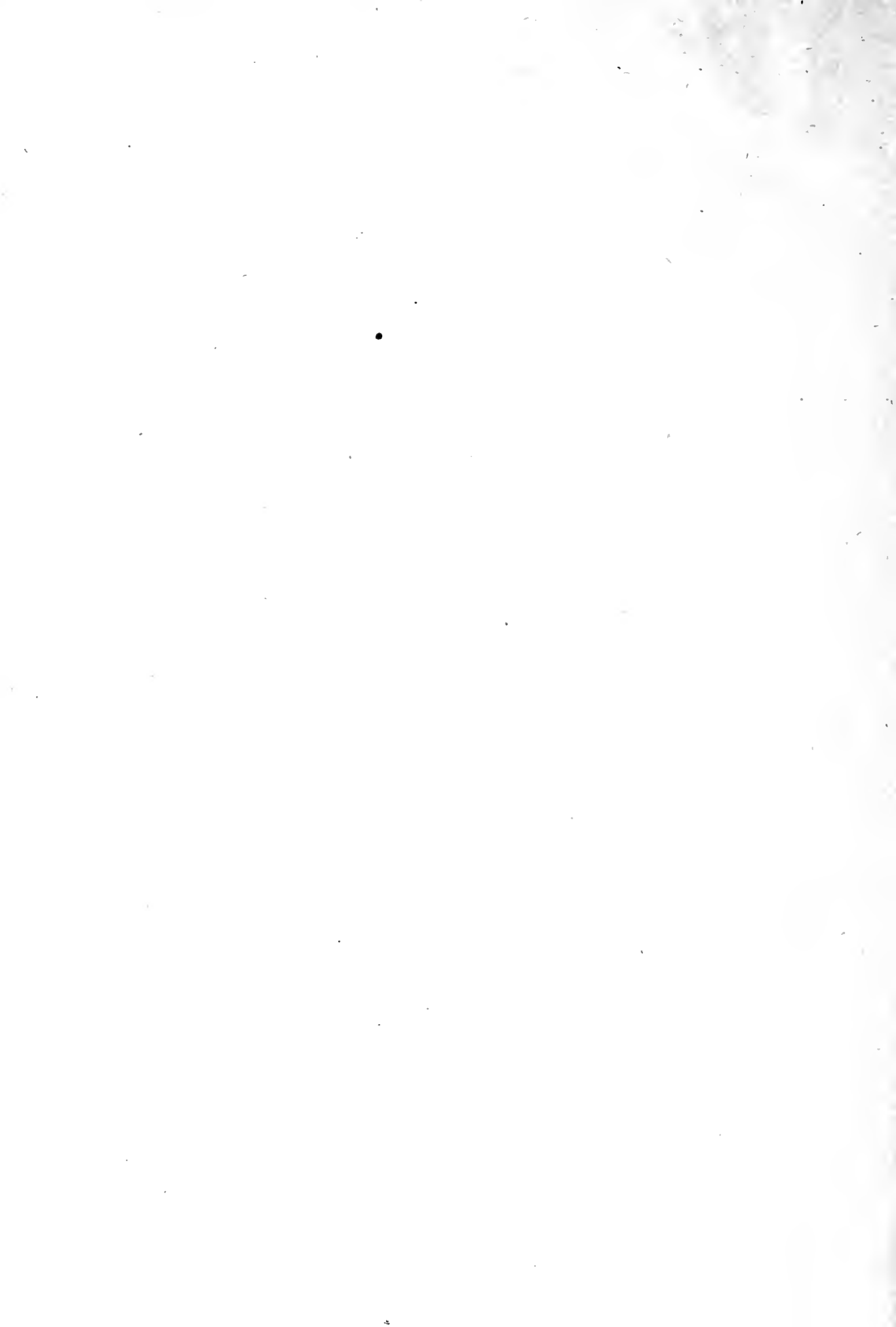



UNITED STATES GEOLOGICAL SURVEY

CLARENCE KING, DIRECTOR

---

GEOLOGY

AND

MINING INDUSTRY

OF

LEADVILLE, COLORADO

WITH ATLAS

BY

SAMUEL FRANKLIN EMMONS



WASHINGTON  
GOVERNMENT PRINTING OFFICE  
1886

F777

.3

E6

## LETTER OF TRANSMITTAL.

UNITED STATES GEOLOGICAL SURVEY,  
DIVISION OF THE ROCKY MOUNTAINS,  
*Washington, D. C., October 1, 1885.*

SIR: I have the honor to transmit herewith the manuscript of a report on the Geology and Mining Industry of Leadville, Colorado.

To yourself, and to the Hon. Clarence King, under whose direction this investigation was commenced, I am greatly indebted for the facilities and kind encouragement that have always been afforded to those engaged in its prosecution.

Very respectfully, your obedient servant,

S. F. EMMONS,  
*Geologist-in-Charge.*

Hon. J. W. POWELL,

*Director United States Geological Survey, Washington, D. C.*



## PREFACE.

---

The present work was undertaken at the instance of the Hon. Clarence King, first Director of the United States Geological Survey, in 1879. It was his intention that it should form part of a series of monographs which would in time include all the important mining districts of the country, and thus furnish an accurate and permanent record of the manner of occurrence and geological relations of the metallic deposits of the United States, as well as of all substantial improvements in the methods of obtaining the metals from their ores.

In preparing such a monograph the general plan adopted was: first, to obtain an accurate knowledge of the geological structure of the region and of the various rocks of which it is made up; next, to study thoroughly the ore deposits in their varied relations to the inclosing rocks; and, finally, to investigate any methods of extraction or of reduction of the ores that presented new or unusual features, without wasting time upon what was already so well known as to require no further comment. Various circumstances rendered such modifications of this plan necessary in the present case that the various stages of the work could not always be carried on in their logical sequence. The great altitude of the region and consequent inclemency of its climate practically prevented surface work being carried on to advantage during eight months of the year. The organization of the Survey was as yet incomplete, and assistants familiar with this class of work could not immediately be obtained; moreover, a year elapsed after the inception of the work before laboratory facilities could be obtained which rendered

## VIII GEOLOGY AND MINING INDUSTRY OF LEADVILLE.

it possible to carry on the chemical investigations that form one of its most important and essential features. The first want was accurate and detailed topographical maps, which are more than usually indispensable in the vicinity of Leadville, where the entire rock surface is covered by débris, and the geological structure had to be reconstructed by gathering into a connected whole the data derived from thousands of isolated shafts and tunnels which had penetrated below the surface accumulations.

This want was supplied by Chief Topographer A. D. Wilson, the unequalled accuracy and rapidity of whose work can only be adequately appreciated by those who have had occasion, as we had, to put it to the test of actual instrumental verification. The field work of the map of Leadville and vicinity was completed by him and his two assistants during the months of August and September, 1879, and that of the map of Mosquito Range during part of July, August, and September, 1880.

In December, 1879, I commenced the study of the ore deposits of Leadville. In this I received most invaluable aid from Mr. Ernest Jacob, graduate of the Royal School of Mines of London, who, working at first as volunteer, rendered most continuous and unwearied service during the whole continuance of the investigation. To his keen insight into the intricacies of geological structure, his untiring energy in exploring every accessible prospect-hole in the region, and his accurate appreciation of the bearing of the data thus gathered, is attributable in great measure the successful unraveling of the complicated problem presented in the region represented on the map of Leadville and vicinity. So complicated a region, I make bold to say, it rarely falls to the lot of a geologist to study in detail.

In July, 1880, it was first practicable to undertake the study of the high mountain region represented on the map of the Mosquito Range. Here geological and topographical field work went hand in hand, and my party worked together with that of Mr. Wilson until heavy snows at the end of September put an end to outside work. In this field work I had the assistance of Mr. Whitman Cross, who had made a special study of microscopical petrography under Professor Zirkel, of Leipzig, and of Prof. Arthur Lakes, of the School of Mines at Golden, Colo., who devoted his summer vacation to this work. To Mr. Cross, who, like Mr. Jacob, first

joined the Survey as volunteer assistant, was intrusted the final petrographical determination of all the crystalline rocks of the region, and the great value of his subsequent investigations in the field of petrography and mineralogy have fully justified the confidence thus placed in his ability.

In the autumn of 1880 the corps was increased by the addition of Mr. W. F. Hillebrand, who had already distinguished himself by his original investigations in inorganic chemistry in the laboratory of Professor Bunsen at Heidelberg; under his direction a laboratory was prepared at Denver in connection with the headquarter offices of this division of the Survey.

During the summer I was fortunate enough to secure the services of Mr. Antony Guyard, a former pupil of the *École des Mines*, and for twelve years chemist at the well known metallurgical works of Johnson & Matthey, London. At my request Mr. Guyard undertook the labor of making a chemical investigation of the processes of lead smelting as conducted at the various Leadville smelters. His sudden death at Paris, which was closely followed by that of his brother Stanislas, the distinguished French Orientalist, prevented the personal revision of his report which I could have desired him to make; and in that which was made by Mr. Hillebrand and myself we have not always felt justified in making modifications which might have been judged advisable could we have discussed the points with the author himself. Beyond the correction of a few clerical errors it is presented substantially in the form in which it was left by him.

In November, 1880, Messrs. Hillebrand and Guyard commenced their respective chemical investigations, the one of the rocks and ores, the other of the furnace products of Leadville, in the laboratory at Denver.

Mr. W. H. Leffingwell, with the assistance of Mr. Jacob, completed the Leadville map during the latter part of 1880 by the accurate location of various shafts and tunnels, to the number of nearly a thousand, found necessary for the determination of the geological outlines, an extremely laborious undertaking, carried on as it was at times with 15 to 20 feet of snow on the ground.

About the same time the topography and underground workings of the maps of Iron, Carbonate, and Fryer Hills were prepared under my direc-

tion by Messrs. H. Huber & Co., F. G. Bulkley & Co., and George H. Robinson & Co., respectively.

From June, 1880, to June, 1881, my time was partially taken up in the supervision and direction of experts employed under the authority of the Superintendent of the Census in making an investigation into the "Statistics and Technology of the Precious Metals" in the Rocky Mountains.

From the close of field work in the summer of 1880 to May, 1881, I was mainly occupied with Mr. Jacob in completing the examination of the mines and deposits of Leadville. In this work we received, with a single exception, the most courteous treatment from mine owners and superintendents, who not only opened their mines freely to our inspection and permitted the use of the maps of their underground workings, but also aided us materially in many cases by the information they furnished from their own every-day experience. To these gentlemen, individually and collectively, I return my most hearty thanks, as well for the services above mentioned as for the confidence thereby displayed in the disinterestedness of our motives and our wish to be of service to the mining public in general without favoring unduly any individual or corporation.

During the summer of 1881 the individual members of the corps, aided by Messrs. Morris Bien and W. B. v. Richthofen, were occupied in collating the results obtained, and in the preparation of the various maps and illustrations for the engraver, and by autumn the work was so far completed that I was enabled to embody the principal results arrived at in an abstract published in the Second Annual Report of the Director of the Survey.

During the time that has elapsed since the publication of that abstract the development of the Leadville mines has proceeded with rapid strides, and already the ores are changing from carbonates and chlorides to sulphides. In other respects also these developments have afforded most gratifying confirmation of the general accuracy of the geological outlines given on the accompanying maps and sections. Even had it been otherwise, it would have been impracticable to have changed what had long since been engraved. In the press of other work it was not possible to attempt another examination of the field, and therefore in the final revision of this



long-delayed material the changes have been mainly confined to condensing and leaving out what has in a measure lost its value by the lapse of time. Where new facts have been obtained, they have been inserted in notes. The report as it now stands is therefore essentially that which was prepared four years ago, and as such it should be criticised by those who have occasion to read it.

S. F. EMMONS.

WASHINGTON, *October 1, 1885.*



# CONTENTS.

---

	Page.
LETTER OF TRANSMITTAL .....	III
PREFACE.....	V
TABLE OF CONTENTS.....	XIII
LIST OF ILLUSTRATIONS.....	XXV
LIST OF ATLAS SHEETS.....	XXVII
BRIEF OUTLINE OF RESULTS.....	XXIX

## PART I.

### GEOLOGY.

#### CHAPTER I.

LEADVILLE—ITS POSITION, DISCOVERY, AND DEVELOPMENT .....	3
Topographical description .....	3
Routes of approach.....	6
Discovery of the precious metals.....	7
Development of mines.....	10
Growth of the city .....	14
Production.....	15

#### CHAPTER II.

GENERAL GEOLOGY OF THE MOSQUITO RANGE.....	19
Rocky Mountains in Colorado .....	19
Eastern uplift.....	20
The Parks.....	22
Western uplift .....	23
Mountain structure .....	24
Mosquito Range—Topography.....	27
Geological history .....	30
Mineral deposition.....	33
Structural results of the dynamic movements .....	34
Displacement—Volcanic rocks.....	39
General erosion—Arkansas Valley erosion.....	40
Glacial erosion .....	41
Stream erosion—Valleys.....	42

# XIV GEOLOGY AND MINING INDUSTRY OF LEADVILLE.

## CHAPTER III.

	Page.
ROCK FORMATIONS .....	45
Sedimentary rocks .....	45
Archean formations .....	45
Granite .....	46
Gneiss .....	48
Amphibolite .....	50
Relative age .....	51
Paleozoic formations .....	53
Cambrian .....	58
Lower Quartzite .....	58
Silurian .....	60
White Limestone .....	60
Parting Quartzite .....	61
Corresponding beds in Colorado Range .....	62
Carboniferous .....	63
Blue or ore-bearing limestone .....	63
Its composition .....	64
Weber Shales .....	67
Weber Grits .....	68
Upper Coal Measures .....	69
Mesozoic formations .....	70
Quaternary formations .....	71
Glacial or Lake beds .....	71
Recent or post-glacial .....	72
Distribution of sedimentary formations .....	72
Eruptive or igneous rocks .....	74
Secondary eruptives .....	74
Mount Zion Porphyry—White Porphyry .....	76
Lincoln Porphyry .....	78
Gray Porphyry .....	80
Sacramento Porphyry .....	81
Pyritiferous Porphyry .....	82
Mosquito Porphyry—Green Porphyry—Silverheels Porphyry .....	83
Diorite .....	84
Porphyrite .....	85
Tertiary eruptives .....	86
Rhyolite .....	87
Trachyte—Andesite .....	88

## CHAPTER IV.

DESCRIPTIVE GEOLOGY OF THE MOSQUITO RANGE .....	90
Introductory .....	90
Surface features .....	91
Glacial formations .....	92
Post-Glacial formations—Archean exposures .....	93
Northeastern division .....	94
Platte amphitheater .....	94
Quandary Peak .....	98
Hoosier pass ridge .....	100
Silverheels Massive .....	104
Lincoln Massive .....	107
Cameron amphitheater .....	111

CONTENTS.

XV

	Page.
Descriptive geology of the Mosquito Range—Continued.	
Northeastern division—Continued.	
Mounts Cameron and Bross .....	115
Red amphitheater .....	119
Eastern foot-hills .....	122
Buckskin amphitheater .....	123
North Mosquito amphitheater .....	125
Middle-eastern division .....	126
Glacial erosion .....	126
Buckskin section .....	128
Loveland Hill .....	130
North Mosquito section .....	131
South Mosquito section .....	133
Pennsylvania Hill .....	135
London fault .....	136
Main crest from Mosquito Peak to Mount Evans .....	139
South Mosquito amphitheater—Sacramento amphitheater .....	140
London Hill .....	141
Pennsylvania Hill west of London fault .....	144
Sacramento arch .....	147
Gemini Peaks .....	149
Little Sacramento gulch .....	151
Spring Valley—Horseshoe gulch .....	152
White Ridge .....	153
North wall of Horseshoe gulch .....	155
Four-Mile amphitheater .....	158
The Horseshoe .....	160
South wall of Horseshoe gulch .....	161
Lamb Mountain .....	163
Sheep Mountain .....	165
Southern division .....	169
Sheep Ridge .....	169
Black Hill .....	170
Twelve-Mile Creek .....	171
Weston's pass .....	173
South Peak Ridge .....	174
Western slopes .....	175
Weston fault—Empire Hill .....	176
Empire gulch .....	181
Main crest north of Ptarmigan Peak .....	182
Lake beds .....	183
Northwestern division .....	184
Prospect Mountain .....	184
Mount Zion Porphyry .....	185
Mount Zion .....	186
Tennessee Park .....	189
East Arkansas Valley .....	190
Buckeye Peak .....	193
Chalk Mountain .....	194
Upper Ten-Mile Valley .....	197
Mosquito fault .....	198
Arkansas amphitheater .....	199
Ten-Mile and Clinton amphitheaters .....	201

XVI GEOLOGY AND MINING INDUSTRY OF LEADVILLE.

CHAPTER V.

	Page.
DESCRIPTIVE GEOLOGY OF LEADVILLE AND VICINITY.....	202
General structure.....	202
Distribution of porphyry bodies .....	206
White Porphyry.....	206
Gray Porphyry.....	207
Pyritiferous Porphyry—Other porphyries.....	208
Area east of Mosquito fault.....	209
Frontispiece.....	210
Mosquito fault—Minor faults .....	211
West Sheridan—Dyer Mountain.....	212
Evans amphitheater.....	214
East Ball Mountain .....	215
Area between Mosquito and Ball Mountain faults.....	215
Ball Mountain fault—Prospect Mountain Ridge.....	215
Little Ellen Hill—Eruptive dikes .....	216
Coal in Weber Shales—Blue Limestone.....	217
South slope of Ball Mountain.....	219
Area between Ball Mountain and Weston faults .....	219
Weston fault.....	220
Iowa fault—Southwest slope of Ball Mountain .....	221
Northwest slope of Ball Mountain .....	223
Colorado Prince fault.....	224
South Evans anticline.....	225
Area between Weston and Mike faults.....	226
Mike fault .....	226
Pilot fault .....	227
Union fault—Long and Derry Ridge.....	228
Long and Derry mines—Dikes—Iowa gulch .....	230
Printer Boy Hill .....	231
Head of California gulch—Pyritiferous Porphyry.....	233
North side of California gulch—Printer Boy Porphyry.....	234
Mike mine—Breece Hill .....	235
Breece fault.....	236
Breece Iron mine.....	237
Area north of Breece fault.....	237
Syncline east of Yankee Hill .....	238
Yankee Hill anticline—North slope of Yankee Hill.....	240
South slope of Yankee hill.....	241
Adelaide fault—Southwest slope of Yankee Hill .....	243
Moraines .....	244
Area between Mike and Iron-Dome faults.....	244
Iron-Dome fault.....	244
Long and Derry Ridge—Josephine Porphyry.....	245
Lake beds—Iowa gulch—Dome Ridge.....	246
South slope of Iron Hill.....	247
North Iron Hill.....	248
Area between Iron-Dome and Carbonate faults.....	248
Carbonate fault.....	248
South of California gulch—Proof of synclinal fold .....	249
Emmet fault—Graham Park .....	250
California gulch.....	252
Carbonate Hill.....	253
Little Stray Horse syncline.....	253
Eastern rim.....	254
Center of basin—Western rim.....	255

CONTENTS.

XVII

	Page.
Descriptive geology of Leadville and vicinity—Continued.	
Fryer Hill.....	255
Prospect Mountain.....	257
Crest of the ridge.....	257
Southern slope.....	258
Little Evans anticline.....	259
Yankee Hill anticline—Little Stray Horse syncline—Big Evans anticline.....	260
Area west of Carbonate and Fryer Hills.....	261
General structure.....	261
Easteru rim of basin.....	262
Western rim.....	263
Explanation of transverse sections.....	263

CHAPTER VI.

DISCUSSION OF GEOLOGICAL PHENOMENA.....	276
Sedimentary rocks.....	276
Archean.....	276
Paleozoic.....	277
Dolomitic sediments.....	278
Serpentine.....	281
Origin of the serpentine.....	282
Structural features.....	284
Folds and faults.....	284
Hade of faults.....	287
The one-sided or S-shaped fold.....	290
Eruptive rocks.....	292
Age.....	293
Manner of occurrence—Intrusive sheets.....	295
Dikes.....	296
Relation of form to composition.....	297
Amount of intrusive force.....	298
Source of intrusive force.....	299
Why intrusive and not surface flows?.....	300
Internal structure.....	302
Orthoclastic and plagioclastic rocks.....	304
Distribution of intrusive rocks in the Rocky Mountains.....	305
Contact metamorphism.....	307
Non-absorption of sedimentary rocks by eruptive masses.....	308

APPENDIX A, BY WHITMAN CROSS.

PETROGRAPHY.

INTRODUCTION.....	319
Discussion of classification in general.....	319
Classification of Mosquito Range eruptives.....	322
OLDER ERUPTIVES.....	323
Quartz-Porphyry.....	323
Mount Zion Porphyry.....	323
White or Leadville Porphyry.....	324
Pyritiferous Porphyry.....	326
Mosquito Porphyry.....	327
Lincoln Porphyry.....	328
Gray Porphyry.....	330

XVIII GEOLOGY AND MINING INDUSTRY OF LEADVILLE.

	Page.
Older eruptives—Continued.	
Diorite.....	333
Quartz-mica-diorite — Hornblende-diorite.....	333
Augite-bearing diorite.....	334
Porphyrite.....	334
Principal group.....	335
Sacramento Porphyrite.....	341
Silverheels Porphyrite.....	342
Miscellaneous porphyrites.....	343
YOUNGER ERUPTIVES.....	345
Rhyolite.....	345
Chalk Mountain Nevadite.....	345
Black Hill Rhyolite.....	349
McNulty gulch Rhyolite.....	350
Empire gulch Rhyolite.....	351
Other rhyolites.....	352
Rhyolitic tufa—Dike in Ten-Mile amphitheater—Breccia.....	352
Quartziferous trachyte.....	352
Andesite.....	353
Pyroxene-bearing hornblende-andesite.....	353
Hypersthene-andesite — Tufaceous andesites.....	354
RÉSUMÉ.....	354
Rock structures observed — Individual rock types.....	355
Mutual relations of rock types — Rock constituents — Their decomposition.....	356
Negative observations — Chemical composition.....	357
NOTES UPON THE HENRY MOUNTAIN ROCKS.....	359
Hornblende rocks.....	359
Augitic rocks.....	361
Résumé.....	362

PART II.

MINING INDUSTRY.

CHAPTER I.

ORE DEPOSITS.....	367
Classification of ore deposits in general.....	367
Leadville deposits.....	375
Manner of occurrence.....	375
Composition.....	376
Distribution.....	377
Secondary alteration—Mode of formation.....	378
Age of deposits—Origin of the metallic contents.....	379

CHAPTER II.

IRON HILL GROUP OF MINES.....	380
Iron Hill.....	380
General description.....	380
Geological structure.....	381
Later intrusive sheets.....	382
White Porphyry.....	383
Blue Limestone—Silurian—Cambrian—Iron fault.....	384
California fault.....	385
Dome fault — Emmet fault — Dome Hill.....	386
Ore deposits.....	388



CONTENTS.

XIX

	Page.
Iron Hill group of mines—Continued.	
Iron Hill—Continued.	
Mine workings .....	389
Rock and Dome .....	389
La Plata, Stone, and A. Y. ....	390
Lime and Smuggler .....	391
South Bull's Eye and Silver Cord Combination .....	392
Iron mine proper .....	394
Relation of Iron fault to ore bodies .....	399
North Iron Hill .....	401
General geological structure .....	401
Iron fault—Adelaide fault—Rock formations .....	402
Ore deposits .....	404
Mine workings .....	405
Argentine—Argentine tunnel.....	405
Adelaide .....	406
Double Decker .....	408

CHAPTER III.

CARBONATE HILL GROUP OF MINES.....	409
General structure.....	409
Rock formations.....	409
Carbonate fault .....	410
Pendery fault—Morning Star fault—Ore deposits .....	411
Southwest slope of Carbonate Hill .....	412
Southern group of mines .....	414
Carbonate workings.....	416
Carbonate incline .....	418
Little Giant .....	424
Yankee Doodle .....	425
Area on top of hill—Area west of Carbonate fault.....	427
Northern group of mines .....	429
Crescent mine.....	430
Catalpa mine.....	431
Evening Star mine .....	433
Morning Star mine .....	436
Area west of Carbonate fault .....	439
Lower Henriett and Waterloo.....	440
Morning Star and Forsaken .....	441
Niles-Augusta and Wild Cat.....	443
Lower Crescent .....	444

CHAPTER IV.

FRYER HILL GROUP OF MINES.....	445
General description.....	445
Rock formations.....	447
Gray Porphyry .....	447
White Porphyry.....	448
Weber quartzite—Blue Limestone.....	449
Gangue—Ore deposits .....	451
Parting Quartzite—White Limestone—Lower Quartzite.....	453
Explanation of Fryer Hill map .....	454
Mine workings .....	455
Chrysolite mine .....	455

	Page.
Fryer Hill group of mines — Continued.	
Mine workings — Continued.	
New Discovery mine.....	462
Little Chief mine.....	465
Gray Porphyry dike.....	466
Little Pittsburgh mine.....	468
Amie mine.....	471
Climax mine.....	475
Virginus mine.....	477
Dunkin mine.....	478
Matchless mine.....	480
Hibernia and Big Pittsburgh.....	482
Robert E. Lee mine.....	483
Little Sliver — Southeast corner of region mapped.....	485
Little Stray Horse gulch.....	488
Résumé.....	489

## CHAPTER V.

OTHER GROUPS OF MINES.....	493
Mines and prospects in the Leadville region.....	493
Little Stray Horse syncline.....	495
Southern rim.....	495
Southeastern rim—Western rim.....	496
Eastern rim.....	497
Yankee Hill anticline.....	498
Breece Iron mine.....	499
Syncline east of Yankee Hill.....	500
South Evans anticline.....	501
Highland Chief mine.....	501
Colorado Prince group.....	503
Little Ellen Hill.....	506
Breece Hill.....	506
Green Mountain.....	507
Long and Derry Hill — Ready Cash mine — Long and Derry mines.....	508
Printer Boy Hill.....	510
Iowa gulch.....	511
Head of California gulch.....	512
Gold deposits.....	513
Placer deposits.....	515
Ore prospects in unexplored areas.....	518
Mines and prospects outside the Leadville district.....	519
Northeastern region — Monte Cristo mine.....	520
Mount Lincoln — Russia mine.....	521
Mount Bross.....	522
Moose mine.....	522
Dolly Varden mine.....	523
Bucks skin cañon.....	524
Phillips mine.....	524
Criterion mine.....	525
Excelsior mine — Colorado Springs mine.....	526
Dominion mine — Sweet Home mine.....	527
Loveland Hill — Fauny Barrett mine.....	528
Between Mosquito and Horseshoe gulches.....	529
Sacramento mine.....	530

CONTENTS.

XXI

	Page.
Other groups of mines—Continued.	
Mines and prospects outside the Leadville district—Continued.	
Crest of the Mosquito range .....	531
London mine.....	532
Peerless mine.....	533
Western slopes of Mosquito range—El Capitan mine .....	534
Ten-Mile district .....	537
Deposits in the Archean .....	538

CHAPTER VI.

GENESIS OF LEADVILLE DEPOSITS .....	539
Manner of occurrence—Why in Blue Limestone rather than in any other formation .....	540
Composition of ores .....	543
Carbonate ores .....	543
Chloride ores.....	548
Basic ferric sulphates.....	549
Processes of alteration.....	550
Agents of alteration.....	552
Relative richness of galena and cerussite.....	553
Outcrop deposits richer than those in depth .....	554
Composition of vein materials .....	556
Vein materials in general .....	557
Kaolin and Chinese talc .....	560
Lime and magnesia salts—Barite .....	561
Manganese .....	562
Ores deposited as sulphides.....	562
Mode of formation.....	565
Indirect evidence .....	566
Negative evidence.....	567
Origin or source of the metallic minerals.....	569
Ascension or lateral secretion .....	569
Source of metals.....	571
Metallic contents of country rocks.....	574
Baryta determinations—Lead determinations.....	577
Silver and gold determinations.....	579
Possible contents of porphyry bodies.....	582

APPENDIX B, BY W. F. HILLEBRAND.

CHEMISTRY.

TABLES OF ANALYSES AND NOTES ON METHODS EMPLOYED .....	589
Eruptive rocks.....	589
Table I. Complete analyses .....	589
Table II. Silica and alkali determinations .....	590
Table III. Lead, zinc, cobalt, and barium determinations .....	591
Remarks on preceding tables.....	591
Table IV. Gold and silver determinations.....	594
Limestones.....	596
Table V. Complete analyses of dolomitic limestones .....	596
Table VI. Lime, magnesia, and chlorine determinations .....	598
Table VII. Serpentine and amphibole from dolomitic limestones.....	598
Ores and vein materials .....	599
Table VIII. Sand carbonates.....	599
Table IX. Chloro-bromo-iodides of silver.....	600

XXII GEOLOGY AND MINING INDUSTRY OF LEADVILLE.

Tables of analyses and notes on methods employed—Continued.	Page.
Ores and vein materials—Continued.	
Table X. Various ores, vein materials, and country rocks.....	602
Table XI. Alteration products of porphyry (kaolin and Chinese tale) .....	603
Table XII. Alteration products of galena and pyrite (basic sulphates).....	606
Table XIII. Miscellaneous alteration products .....	607
Table XIV. Assays of ores, vein materials, and country rocks.....	608

APPENDIX C, BY ANTONY GUYARD.

METALLURGY.

INTRODUCTION .....	613
SECTION I.	
PRELIMINARY CONDITIONS OF SMELTING.....	614
Leadville—Its situation .....	614
Location and output of its mines, Table I .....	615
Ores—Description of chief ores—Analyses of carbonate, chloride, and average ores—Assays of ores from principal mines, Table II.....	616
Smelting works—Their location, cost of plant, Table III, and general arrangement.....	625
Ore buying—Its method.....	627
Sampling and sampling works.....	628
Crushing and crushers used.....	629
Assaying—Apparatus and methods.....	632
SECTION II.	
MATERIALS USED IN SMELTING .....	636
General considerations.....	636
Statistics of Leadville smelters, Table IV.....	637
Construction materials.....	641
Fuels and fluxes.....	641
Coke—Analyses VII and IX.....	641
Charcoal .....	642
Dolomites—Analyses X to XIX.....	643
Limestone—Analysis XX .....	646
Hematite—Analysis XXI.....	646
Ore beds—Their composition, Table V .....	648
Smelting charges at individual smelters.....	649
Résumé and general discussion of smelting charges.....	659
SECTION III.	
PLANT AND SMELTING OPERATIONS .....	659
Smelting plant in general—Furnaces and blast apparatus, Table VI .....	659
Smelting operations in general—Drying, blowing-in, charging, barring-down, smelting of dusts, tapping of clay, matte and speiss, ladling-out of bullion, watching and blowing-out.....	664
Cost and profits of smelting.....	668
Plant and operations of individual smelters.....	669
SECTION IV.	
PRODUCTS OF SMELTING.....	692
Bullion—Its sale—Shipment, Table VII—Analyses and assays—Skimmings—Losses—Bullion capacity of smelters, Table VIII—Bullion production, Table IX .....	692

CONTENTS.

XXIII

	Page.
Products of smelting — Continued.	
Slag—Daily assays, Table X—Specific gravity determinations—Properties—Complete analyses XXX to XXXII .....	698
Chamber-dust—Assays, Table XII; Analyses XXXIII and XXXIV—Roasted dust, Analysis XXXV—Fumes from Bartlett filter, Analysis XXXVI .....	711
Speiss—Analyses XXXVII and XXXVIII—Assays, Table XIII .....	719
Iron sows or salamanders—Analysis XXXIX .....	722
Mattes—Analyses XL and XLI—Assays, Table XIV .....	723
Accretions—Hearth accretions, Table XV—Shaft accretions, Analysis XLII—Peculiar accretions, Analyses XLIII and XLIV .....	725
SECTION V.	
THEORETICAL DISCUSSION .....	731
Reactions in the blast-furnaces .....	731
Reactions of lead compounds .....	732
Reactions of silver compounds .....	735
Reactions of iron compounds .....	736
Chemical discussion of the Leadville furnaces .....	737
Raw materials entering into charges .....	738
Weight of blast .....	740
Loss of weight of charges in different zones .....	741
Chemical reactions of the different zones .....	744
Conclusions .....	745
METALLURGICAL PLATES .....	749
GENERAL INDEX .....	753



## LIST OF ILLUSTRATIONS.

### PART I.

PLATE		Page.
	I. Head of Iowa gulch—Iowa amphitheater and Mount Sherman in the background. (Frontispiece.)	
	II. Leadville and the Mosquito Range.....	6
	III. South Park and eastern slopes of Mosquito Range, from Mount Silverheels.....	28
	IV. Archean phenomena .....	52
	FIG. 1. Face of cliff, Arkansas amphitheater.	
	2. Boulder, Buckskin amphitheater.	
	3. Boulder, Mosquito gulch.	
	V. Red-cast beds (Cambrian). Contorted limestone (Upper Coal Measure).....	60
	VI. Blue limestones (specimens showing ribbed structure).....	64
	VII. Hornblende-porphyrite specimens.....	84
	FIG. 1. From Arkansas dike.	
	2. From south wall of Buckskin gulch.	
	VIII. Nevadite from Chalk Mountain .....	85
	FIG. 1. Micro-section of White Porphyry.	
	2. Micro-section of Nevadite.	
	3. Specimen of Nevadite.	
	IX. Mount Lincoln Massive from Mount Silverheels.....	94
	X. Mosquito Range and Blue River Valley, looking north from Mount Lincoln.....	98
	XI. Summit of Mount Lincoln and north wall of Cameron amphitheater (upper end)..	112
	XII. North wall of Cameron amphitheater (lower end).....	114
	XIII. South side of Buckskin gulch.....	128
	XIV. Cliffs on north side of Mosquito gulch (showing fault and intrusive masses of porphyry).....	132
	XV. Sacramento arch (looking across Big Sacramento gulch from Pennsylvania Hill) .	148
	XVI. North side of Horseshoe gulch (showing White Ridge and laccolite) .....	154
	XVII. Head of Four-Mile Creek (showing the "Horseshoe").....	158
	XVIII. Sheep Mountain fold and London fault (south side of Horseshoe gulch) .....	164
	XIX. Rhyolite and porphyry, Chalk Mountain .....	196
	FIG. 1. Plan of eastern edge of mountain, showing quartzite and porphyry dike inclosed in rhyolite.	
	2. North side of railroad cut, at south end of Chalk Mountain, showing porphyry cutting through sandstone.	
	3. South side of same cut.	
	XX. Micro-sections of porphyry. Appendix A .....	336
	FIG. 1. Biotite-porphyrite (Type VI) from North Mosquito amphitheater.	
	2. Hornblende-porphyrite (Type VII).	
	3. Hornblende-porphyrite (Type V) from Buckskin gulch, showing large hornblende.	
	4. Hornblende-porphyrite (Type V) showing small needles of hornblende.	

XXVI GEOLOGY AND MINING INDUSTRY OF LEADVILLE.

	Page.
PLATE XXI. Micro-sections of andesite. Appendix A .....	354
Figs. 1, 2, and 4. Andesite from Buffalo Peaks.	
3. Zircon crystals in quartz grain of a Lincoln Porphyry.	
PART II.	
XXII. Vein phenomena, showing replacement action.....	420
Fig. 1. Evening Star Incline.	
2. Glass-Pendery mine.	
3. Carbonate Incline.	
4. Forsaken Incline.	
XXIII. Circular furnace, smelter A.....	749
XXIV. Reverberatory furnace and dust chamber, smelter A.....	749
XXV. Flue arrangement, smelter A .....	749
XXVI. Rectangular furnace, smelter B .....	749
XXVII. Circular furnace, smelter B .....	749
XXVIII. Bartlett smoke filter — McAllister charcoal kiln .....	749
XXIX. Rectangular furnace, smelter C .....	749
XXX. Dust chamber, smelter C .....	749
XXXI. Blast arrangement and elevation of works, smelter C.....	749
XXXII. Furnace and dust chamber, smelter D .....	749
XXXIII. Furnace and dust chambers, smelters F and M.....	749
XXXIV. Dust chamber, smelter F .....	749
XXXV. Square furnaces, smelter G.....	749
XXXVI. Zones of temperature — Elevation of smelter G.....	749
XXXVII. Circular furnace, smelter H.....	749
XXXVIII. Dust chamber, smelter H — Jolly's spring-balance .....	749
XXXIX. Assay furnace, smelter H .....	749
XL. Dust chamber, smelter J.....	749
XLI. Blake crushers .....	749
XLII. Blowers — Baker's and Root's.....	749
XLIII. Assay implements .....	749
XLIV. Smelter's implements .....	749
XLV. Alden crusher — Furnace and dust chamber, smelter I .....	749
FIG. 1. Sanidine from Nevadite.....	348
2. Highland Chief mine.....	501
3. Colorado Prince and Miner Boy mines.....	504
4. Florence mine, Printer Boy Hill .....	510
5. Taylor Hill .....	511
6. El Capitan mine .....	536



## LIST OF ATLAS SHEETS.

	Sheets.
Title .....	I
List of Atlas sheets .....	II
Legend .....	III
Central Colorado .....	IV
Mosquito Range :	
Topography .....	V
Geology. North half .....	VI
Geology. South half .....	VII
Geological sections. I .....	VIII
Geological sections. II .....	IX
Geological sections. III .....	X
Leadville and vicinity :	
Topography. East half .....	XI
Topography. West half .....	XII
Geology. East half .....	XIII
Geology. West half .....	XIV
Geological sections. I, west half .....	XV
Geological sections. I, east half .....	XVI
Geological sections. II, west half .....	XVII
Geological sections. II, east half .....	XVIII
Geological sections. III, west half .....	XIX
Geological sections. III, east half .....	XX
Geological sections. IV .....	XXI
Geological sections. V .....	XXII
Iron Hill :	
Geology and mine workings .....	XXIII
Geological sections. I .....	XXIV
Geological sections. II .....	XXV
North Iron Hill :	
Geology and mine workings .....	XXVI
Geological sections .....	XXVII
Carbonate Hill :	
Geology and mine workings .....	XXVIII
Geological sections. I .....	XXIX
Geological sections. II .....	XXX
Fryer Hill :	
Geology and mine workings .....	XXXI
Geological sections. I .....	XXXII
Geological sections. II .....	XXXIII
Geological sections. III .....	XXXIV
Index to shafts on Leadville map .....	XXXV

XXVIII GEOLOGY AND MINING INDUSTRY OF LEADVILLE.

ERRATA IN ATLAS SHEETS.

- SHEET VI. Blue section line BB should run through the summit of Mount Lincoln and thence to summit of Mount Cameron, instead of direct to latter from point on east spur.
- VII. The line of the Mike fault should not be continued south of Empire gulch.
- XII and XIV. The blue line, showing the course of the Starr ditch north of California gulch, has been omitted; the names give an approximate idea of its position.
- XIII. Color on small block of Blue Limestone at Comstock tunnel (L-38) has been left out.
- XV. "Ditch" just west of Sequa shaft should be "Little Evans gulch."
- XXI. Section JJ, "Iowa gulch fault," should be "Iowa fault."
- XXIII. Parallel linings to denote "inclines" have been omitted on Silver Wave claim.
- XXV. Section FF, "California fault," should be "Dome fault."
- XXX. Section GG, "White Porphyry" color under drift east from upper shaft of Yankee Doodle mine, should have been that of "vein material."
- XXXI. Shaft "Carboniferous No. 7" should be "Carboniferous No. 1."
- Shaft "Little Chief No. 3" (southernmost) should be "Little Chief No. 5."
- Shaft "Little Pittsburgh No. 3" (near E, boundary line, and just north of dike), "No. 3" left out.
- Shaft Climax No. 2 (near E, boundary line, and line of section), "No. 2" left out.
- XXXV. F-10 "Leavenworth" should be "Lawrence."
- M-5 "Beecher" should be "Belcher."

## BRIEF OUTLINE OF RESULTS.

### GEOLOGY.

The Mosquito Range, the study of whose geological structure formed a necessary basis for that of the ore deposits of the Leadville region, is the western boundary of the South Park, and has thus been considered from a topographical standpoint to form part of the Park Range. Geology shows, however, that in Paleozoic times the boundaries of the depressions now known as the Parks were formed by the Archean land masses of the Colorado Range on the east and of the Sawatch and its continuation to the north, the Park Range on the west, and that the uplift of the Mosquito Range did not occur until the close of the Cretaceous.

Prior to this uplift the various porphyry bodies, which now form a prominent feature among the rock formations of the region, were intruded into the sedimentary beds deposited during Paleozoic and Mesozoic times, spreading out between the beds and sometimes crossing them, but being most uniformly distributed at the top of the Lower Carboniferous or Blue Limestone. It was in this limestone that the greater part of the ores were deposited, and the original deposition must have taken place after the intrusion of the porphyry and before the uplift of the range.

In the uplift of the range both eruptive sheets and sedimentary beds, with the included ore deposits, were plicated and faulted, and by subsequent erosion an immense thickness of rocks has been carried away, laying bare the very lowest rocks in the conformable series; the outcrops are, however, frequently buried beneath what is locally called "wash," a detrital formation of glacial origin. In the Leadville region, owing to the reduplication caused by faulting, a series of outcrops of easterly dipping beds of the Blue Limestone are exposed beneath the wash, of which all are metalliferous and a considerable proportion carry pay ore.

### ORE DEPOSITS.

The principal ore deposits of Leadville occur, as above indicated, in the Blue Limestone and at or near its contact with the overlying bodies of porphyry. The ores consist mainly of carbonate of lead, chloride of silver, and argentiferous galena, in a gangue of silica and clay, with oxides of iron and manganese and some barite. These materials are mainly of secondary origin, and result from the alteration by surface waters of metallic sulphides.

The study of these deposits has shown: 1, that they were originally deposited as sulphides, and probably as a mixture, in varying proportions, of galena, pyrite, and blende; 2, that they were deposited from aqueous solutions; 3, that the process of deposition was a metasomatic interchange between the materials brought in by the solutions and those forming the country rocks, consequently that they do not fill pre-existing cavities; 4, that the ore currents from which they were deposited did not come directly from below, but were more probably descending currents; and 5, that these currents probably derived the material of which the ore deposits are formed mainly from the porphyry bodies which occur at horizons above the Blue Limestone.

### PRACTICAL CONSIDERATIONS.

Inasmuch as the ore currents did not come directly from below, it is not advisable to search for ore below the Blue Limestone horizon. This horizon, however, should be thoroughly prospected, and the maps and sections show its probable position in the as yet unexplored areas; the explorations, moreover, should not be confined to the upper surface of this limestone, but carried into its mass wherever there are indications of ore, and especially along the contact of transverse bodies of Gray Porphyry. The probabilities are that very considerable bodies of ore remain as yet undiscovered, and the most promising areas for prospecting are indicated. It is also probable that as the distance from the surface increases the ores will be found less altered, and that they will therefore be less easily reduced by the smelting processes now employed.

The petrography of the district is treated by Mr. Whitman Cross in Appendix A. The results of chemical investigation and the methods of research are given in Appendix B by Mr. W. F. Hillebrand, and in Appendix C Mr. Guyard has given a memoir on lead smelting as conducted at Leadville, showing the character of the plant, the composition of ores, fluxes, and furnace products, and discussing the reactions which take place in the blast furnaces.



---

GEOLOGY AND MINING INDUSTRY OF LEADVILLE.

PART I.

GEOLOGY.

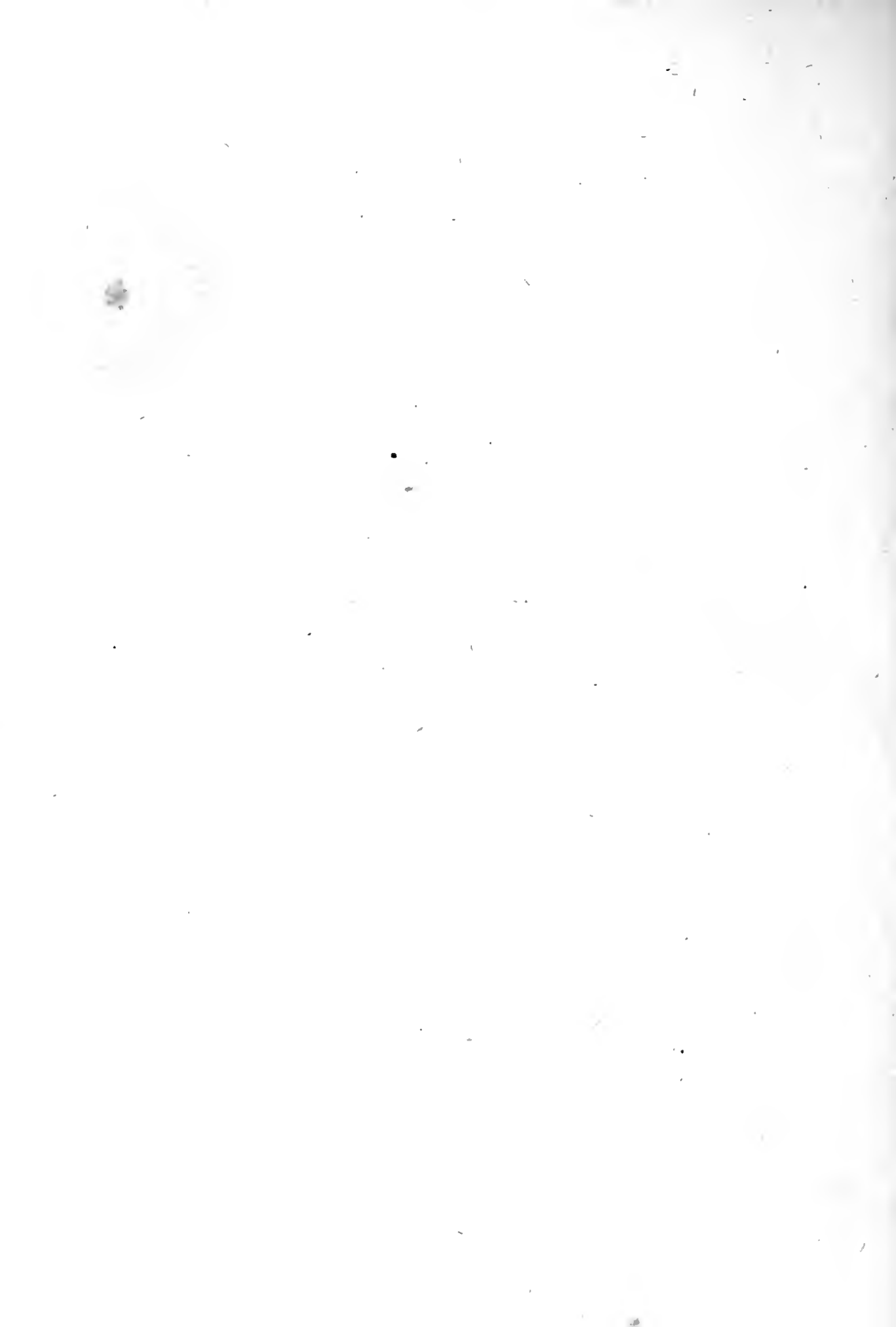

## CHAPTER I.

# LEADVILLE—ITS POSITION, DISCOVERY, AND DEVELOPMENT.

**Topographical description.**—The city of Leadville is situated in the county of Lake, State of Colorado, on the western flank of the Mosquito Range, at the head of the Arkansas Valley. Its exact position is in longitude  $106^{\circ} 17'$  west from Greenwich and  $39^{\circ} 15'$  north latitude. Its mean elevation above sea-level is 10,150 feet, taken at the court-house, in the center of the city.<sup>1</sup>

The most striking feature in the topographical structure of the Rocky Mountains in Colorado is, as is well known to those familiar with western geography, the fact that it consists of two approximately parallel ridges, separated by a series of broad mountain valleys or parks.

The easternmost of these uplifts, the Colorado or Front Range, rises abruptly from the Great Plains, which form its base at 5,000 to 6,000 feet above the sea-level, to a crest of 13,000 to 14,000 feet. It is deeply scored by narrow, tortuous gorges, worn by mountain streams, whose clear waters debouch upon the plains and become absorbed in the sluggish, turbid currents of the Platte and Arkansas Rivers. The trend of the range is due north and south, its highest portions being mostly included within the

---

<sup>1</sup>The datum point from which the levels of the map of Leadville were reckoned is the threshold of the First National Bank, a stone building at the southeast corner of Harrison avenue and Chestnut street. The altitude of this point, as determined by connection by levels with the bench-marks of the Denver and Rio Grande Railroad, is 10,135.55 feet; by levels with the bench-marks of the Colorado Central Railroad, 10,113 feet; by depression angles from the top of Mount Lincoln, 10,112 feet. As a mean, the contour passing through it is assumed to be 10,125 feet, greater weight being given to the first figure, since the leveling by which it was arrived at was probably more carefully done than in the case of the other two. A level-line had been run from Fairplay to the top of Mount Lincoln by the members of the Hayden Survey in 1872.

boundaries of the State, beyond which at either end it becomes gradually lower, and disappears as a topographical feature beneath the plains. To the west of this range lie the mountain valleys of the North, Middle, South, and San Luis Parks, in Colorado, and the Laramie Plains, in Wyoming, each of which possesses the same general feature of being nearly completely encircled by mountain ridges. On the other hand, each has distinct topographical features of its own, which need not be entered upon here.

Beyond the parks on the west, and separating them from the great basin of the Colorado River, is a second mountain uplift, to which the general name of Park Range has been given. It has by no means the regular structure of the Colorado Range, but is made up of a series of short ranges en échelon, from which offshoots connect with the latter, forming the ridges which separate the different park basins. In the latitude of Leadville this western uplift consists of two distinct ranges, the Mosquito or Park Range—the latter being the name given in the Hayden atlas of 1877, probably because it forms the boundary of the South Park—and the Sawatch Range, which forms the water-shed between the Atlantic and Pacific waters.

The Mosquito Range is a narrow, straight ridge, about eighty miles in length, trending a little west of north, and is characterized by long, regular slopes scored deeply by glacial gorges on the east toward South Park and by an abrupt irregular inclination on the west towards the Arkansas Valley.

The Sawatch Range, on the other hand, is a broader, oval-shaped mountain mass, divided by the deep gorges of its draining streams into a series of massives and wanting the continuous ridge structure of the Mosquito Range. In this respect, as in its geological composition, which is the determining cause of the difference of its topographical forms, it resembles the Colorado Range. The culminating points of each range have a remarkably uniform elevation of about fourteen thousand feet above sea-level.

Between the two ranges lies the valley of the Upper Arkansas, a meridional depression 60 miles in length and about sixteen miles in width, measured from the crest of its bounding ridges. Its direction is parallel to that of the Mosquito Range, being a little east of south in its mean course, though more nearly north and south towards its head. From its southern end the Arkansas River, after receiving the waters of the South Arkansas, bends



sharply to the east and cuts through the southern continuation of the Mosquito and Colorado Ranges in deep cañon valleys, the last well known to tourists as the Royal Gorge. About midway in the Upper Arkansas Valley the present bed of the stream is confined within a narrow rocky cañon, called from the prevailing rock of the surrounding hills Granite Cañon. Both above and below this cañon the foot-hills of the bordering ranges recede again, leaving a valley bottom from six to ten miles in width. But little of this area is occupied by actual alluvial soil, its surface consisting mostly of gently sloping, gravel-covered terraces. In the area above the cañon, which is about twenty miles long, the eye is at once arrested by its basin form. In the center is a relatively wide stretch of meadow land immediately adjoining the river, on either side of which mesa-like benches slope gently up to the foot-hills of the mountains, three or four miles distant, which rise abruptly from these terraces in broken, irregular outlines. The suggestion thus offered by its basin shape and terrace-like spurs that this portion of the valley was once filled by a mountain lake is confirmed, as will be seen later, by the geological facts developed during the present investigation.

On the upper edge of one of these terraces, on the east side of the valley, is situated the city of Leadville. From the north bank of California gulch it extends along the foot of Carbonate hill to the valley of the east fork of the Arkansas, covering, with its rectangular system of streets and contiguous smelting works, an area of nearly 500 acres, while on the hill slopes immediately above are situated the mines which constitute its wealth. On Plate II is given the reproduction of a photograph of the city, taken from a point in its western outskirts on Capitol Hill ridge, near the junction of the two branches of the Denver and Rio Grande Railroad and about west of the Harrison smelter. Although the plate leaves much to be desired in point of distinctness and the shape of the mountain spurs back of the town are necessarily obscured by foreshortening, it serves to give a general idea of the city and its surroundings. The square building with cupola, on the extreme left, is the court-house, back of which the wooded ridge in the middle distance is Yankee Hill; a similar building to the right toward California gulch is the high school. The chimney in the middle is

that of the Harrison Reduction Works, to the right of which is the Tabor mill. The slopes immediately back of the town are those of Carbonate hill, beyond which is seen the round summit of Ball Mountain, with Breece hill, as a wooded spur, extending northward from it. Still farther back the ridge slopes up in apparent continuity to Dyer Mountain, the highest point on the sky-line. To the left of Dyer Mountain is Mount Evans,  $6\frac{1}{4}$  miles distant in a straight line, and on its right is Mount Sherman, forming the eastern walls of Evans and Iowa amphitheatres respectively. On a clear day the outlines of rock formations on these walls may be very distinctly seen.

**Routes of approach.**—The approach to Leadville, as may be seen from the above brief sketch of its topographical situation, was extremely difficult before the development of its wealth had led to the building of railroads. Three routes of travel were available. The middle one, or that most used by travelers in coming from Denver, crossed the Colorado Range near the South Platte Cañon, at an elevation of 10,000 feet, and skirting the northern rim of South Park, through the mining town of Fairplay, crossed the Mosquito Range at Mosquito pass opposite Leadville at an altitude of 13,600 feet, or, making a detour of ten or twelve miles to the southward, at Weston's pass, whose summit is only 12,000 feet above the level of the sea. This general route the Denver and South Park Railway follows, winding up the narrow and tortuous gorge of the South Platte and passing over Kenosha pass at the head of its north fork into South Park; to cross the Mosquito Range, however, it is obliged to make a longer detour to the southward and pass down the valley of Trout Creek, a tributary of the Arkansas, which, heading on the east side of the Mosquito Range, debouches into the Arkansas Valley at Buena Vista, 40 miles south of Leadville.

The southern route, before the time of railroads, generally crossed the Colorado Range at the Ute pass above Colorado Springs, and, traversing the lower end of South Park, passed into the Arkansas Valley either at Trout Creek or at Weston's pass. The Denver and Rio Grande Railway, however, has located its line—a triumph of engineering skill—directly up the valley of the Arkansas, which it follows through cañons and gorges that before were practically impassable.





*Iowa Amphitheatre.*

*Mt. Sheridan.*



Mosquito Range.



The northern route starts from Golden, near Denver, and, following up the cañon of Clear Creek, crosses the Colorado Range at an altitude of 12,000 feet, either by the Argentine or by Loveland's pass. It then crosses the southern edge of Middle Park along the valley of Snake River and bends southward up the valley of Ten-Mile Creek, having thus gone around the northern end of the Mosquito Range. After crossing the relatively low divide of Frémont's pass (11,300 feet), it reaches Leadville by descending the east fork of the Arkansas. At either end of this route railroads are already built, namely, up the valley of Clear Creek to Georgetown, and from Leadville across Frémont's pass down Ten-Mile Valley to its junction with the Blue. But the advisability of completing the connecting link at such an altitude, in practical competition with the two already existing lines, seems under present conditions of development to be somewhat doubtful.

*Discovery of the precious metals.*—The discovery of the Leadville deposits presents so striking a picture of the life of the pioneer miner in the West, and of the large element of chance connected with it, that it seems proper to give its history with all the fullness of detail which the somewhat imperfect data obtainable will allow.

The earliest known exploration of the valley of the Upper Arkansas was that made by the expedition of Frémont in 1845. In his second expedition, in 1842, he had aimed at tracing the Arkansas River to its source, but, unwittingly leaving the main stream, had followed up the Fontaine qui bouille, now called Fountain Creek, probably passing near the present site of Denver, and struck into the mountains at some point nearly opposite that place. In 1845, however, as indicated by General Warren, he probably entered the mountains near where Cañon City now stands, and crossed the southern end of South Park, reaching the Upper Arkansas Valley through the valley of Trout Creek. Thence, following the Arkansas to its head, he crossed what was then called Utah pass and descended Eagle or Piney River to its confluence with the Grand or Blue. It seems probable, therefore, that the name of Frémont's pass, which is given to that of Ten-Mile Creek, would have been more appropriately applied to the Tennessee pass, which divides the Eagle River from the head of the Arkansas.

There is little doubt that this striking valley was afterward visited by trappers and individual explorers, but of such visits no record is left so far as is known to the writer. This region, like that of the parks, formed part of the debatable ground between the tribes of Arapahoes and Utes, who were constantly at war with each other and who made excursions to these mountain valleys simply for the purpose of hunting and without any permanent occupancy.

During the summer of 1859, at the time of the great Pike's Peak excitement, a continuous stream of emigrant wagons stretched across the plains, following up the Arkansas River to the base of Pike's Peak. As is generally the case in such mining rushes, the golden dreams of a large portion of those attracted by the marvelous stories of the wealth that existed in the streams issuing from the mountains were never realized. Many of the wagons that had crossed the plains in the early summer, carrying the triumphant device "Pike's Peak or bust," returned later over the same route with this device significantly altered to "Busted." The more adventurous and hardy of these pioneers, although disappointed in their first anticipations, pushed resolutely up through the rocky gorges towards the sources of the streams. Some of these found gold in Russell gulch, in the valley of Clear Creek, where the first mining developments were made within the State and where now stand the flourishing mining towns of Central City and Black Hawk. Others wandered across the Colorado Range into South Park, and found gold-bearing gravel deposits on its northern border, in Tarryall Creek and on the Platte in the neighborhood of Fairplay. This is, as far as can be learned, the extent of the explorations made in 1859.

In the early spring of 1860 several small parties crossed the second range into the Arkansas Valley. Among the number were Samuel B. Kellogg, now justice of the peace at Granite, and H. A. W. Tabor, later millionaire and lieutenant governor of the State of Colorado. Mr. Kellogg had already had an experience of ten years in placer mining in California when he came to Colorado in 1859. In February, 1860, he started with Tabor and his family, their wagon being the first that ever went as far as the mouth of the Arkansas. They pushed up the valley and about April 1 settled down at the site of the present town of Granite, about eighteen miles below Lead-



ville. Here, having discovered gold in Cash Creek, whose placer deposits are worked even at the present day, they whipsawed lumber to make sluices for washing its gravels. A few days after their arrival news was brought to them of the discovery of gold in California gulch. Two parties of prospectors had, it seems, already preceded them, though their route is unknown. Foremost among their names are those of Slater, Currier, Ike Rafferty, George Stevens, Tom Williams, and Dick Wilson, from the last of whom many of the following facts were obtained: The first hole dug in California gulch was about two hundred feet above the site of the present Jordan tunnel, the second just below the present town of Oro. Owing to the richness of the ground and the number of the persons present, gold was discovered at an unusual number of points, and 14 discovery claims of 100 feet each were located. Kellogg and Tabor met the prospectors at the mouth of Iowa gulch, as they returned from locating the discovery claims, and agreed to prospect that gulch. They returned to Cash Creek for provisions, and went finally to California gulch on the 26th of April, 1860, as Iowa gulch had yielded little fruit to their labors — the geological reasons for which will be explained later.

In spite of the difficulties of communication in this wild region, the news of the rich discovery of gold spread with amazing rapidity. The day after their arrival 70 persons came into the gulch from the Arkansas Valley; by July it was estimated that there were 10,000 persons in the camp. It is said that \$2,000,000 worth of gold was taken out during the first summer. Probably considerable deductions may be made from this estimate for the exaggeration that fills men's minds in moments of such excitement. The record of claims located, however, shows enormous activity in mining during this summer. In California gulch alone, 339 claims, 100 feet in width, were located. Single individuals are said to have carried away from \$80,000 to \$100,000 each as the result of their first summer's labor. Tabor and Kellogg worked their own claims and made about \$75,000 in sixty days. The total production of the placer claims is generally stated at from \$5,000,000 to \$10,000,000, but a more conservative estimate places it at from \$2,500,000 to \$3,000,000. The climax was soon reached, and after the first year the population of this new district, whose post-office was then known as Oro

City, rapidly decreased, until within three or four years the thousands had dwindled into hundreds. Kellogg, with the restless spirit of the western prospector, wandered away in the early part of the summer into the San Juan region and did not return. Tabor started the solitary store in the place, his wife being at the time the only person of her sex in the camp. When the product of the placers had gradually decreased and the prosperity of the camp was at its lowest ebb, he moved across the range to Buckskin Joe, which was then enjoying a fitful prosperity from the rich developments of the Phillips mine; but returned later, when the discovery of vein gold in the Printer Boy mine revived for a time the waning prosperity of the gulch.

**Development of mines.**—In 1861 a ditch was built from Evans gulch across the head of California gulch, by means of which sluice mining was carried on, but owing to the great cost of supplies, which had to be brought in on the backs of animals, only the very richest gravels could be worked with profit, and at that time little attention was paid to vein deposits. Among the early miners it is probable that few if any suspected the existence of the real mineral wealth that the region contained, although they were much annoyed in their working by worn, iron-stained fragments of heavy rock, which they had to throw out by hand from their sluices, the water not having sufficient force to carry them down.

Report says that in August, 1861, C. M. Rouse and C. H. Cameron, of Madison, Wis., "struck carbonates," of which a small quantity was shipped to George T. Clarke, of Denver; and that samples which he sent to Chicago yielded by assay 164 ounces of silver to the ton. The Washoe Mining Company is said to have been formed on the strength of these discoveries, but no work was done upon the claims, whose location, if they really existed, is now unknown.

In June, 1868, the first gold vein, called the Printer Boy, was discovered by Charles J. Mullen and Cooper Smith, who were prospecting for J. Marshall Paul, of Philadelphia; and in August the Boston and Philadelphia Gold and Silver Mining Company of Colorado was organized, and a stamp mill was built at Oro, in California gulch, to treat the ore from this vein. A very considerable amount of gold is said to have been obtained from it,

though it is difficult to obtain actual data as to its production. Estimates place its total yield at \$600,000 to \$800,000. The "5-20" vein was also opened at this time on the opposite side of the gulch, and also an extension of the Printer Boy, called the Lower Printer Boy. The working of these mines, which was carried on more or less continuously until 1877, imparted at times a fitful prosperity to the region. Meanwhile the location of the town of Oro had been frequently changed. It was first scattered along California gulch, then concentrated at the mouth of the gulch, near the present city of Leadville, and later moved up to the vicinity of the stamp mill, which still stands among the few cabins to which the name of Oro City is yet applied.

During this time the Homestake mine in the Sawatch Range, near Homestake Peak, opposite the head of the Arkansas, had been opened and was yielding rich silver ore. In 1875 a smelter was built at Malta, west of Oro, to treat the ore from this mine and from others which it was expected would be developed in that region. This smelter, like so many others built before any permanent production could be counted on for its supply, has never been successful.

To Mr. A. B. Wood and his associate, Mr. W. H. Stevens, both experienced and scientific miners, is due the credit of being the first to recognize the value of the now famous carbonate deposits of Leadville. Mr. Wood came to California gulch first in April, 1874, to work the Star placer claim. While examining the gravel in the gulch he was struck by the appearance of what the miners call "heavy rock," some of which he assayed. His specimens were not rich, yielding only 27 per cent. lead and 15 ounces silver to the ton; but the matter seemed to him worthy of investigation. He put prospectors at work to find the croppings of the ore deposits, and in June, 1874, the first "carbonate-in-place" was found at the mouth of the present Rock tunnel, on Dome hill. About the same time ore was discovered in a shaft sunk by Mr. Bradshaw near the bed of the gulch on the present Oro La Plata claim; but it is maintained by some that this ore was not in place, but simply "wash," accumulated from the abrasion of the adjoining croppings. Prospecting was quietly continued by Mr. Wood, but no claims were taken up, as the old placer claims — which,

though abandoned, would still be in force for another year — covered all the ground adjoining the gulch. Meanwhile he studied the occurrence of the mineral and the outcrops of the limestone on either side of California gulch. In the spring of 1875 he took Mr. Stevens and Professor H. Beeger, the latter then in charge of the Boston and Colorado Smelting works at Alma, to Iron and Dome hills, and showed them in the forest that then covered the slopes the outcrops, respectively, of the Lime, Rock, and Dome claims. During this and the following summer the principal claims which constitute the valuable property of the Iron Silver Mining Company were located by Messrs. Wood and Stevens in the interest of Detroit parties. The first ore was extracted from the Rock mine, where a large mass of hard carbonate formed a cliff outcrop on the side of California gulch. This ore was rich in lead, but ran very low in silver. During the summer of 1876 ore was first taken from the croppings of Iron and Bull's Eye claims, and some rich assays, as high as 600 to 800 ounces to the ton, were obtained from it.

The first working tests of Leadville ore were made by Mr. A. R. Meyer, a graduate of European mining schools, who first came to California gulch in 1876 from Alma, acting as agent for the St. Louis Smelting and Refining Company. In the fall of that year he shipped 200 to 300 tons of ore, principally taken from the Rock mine, by wagon to Colorado Springs, and thence by rail to St. Louis. The freight to Colorado Springs cost \$25 per ton and the ore averaged only seven ounces in silver to the ton; it contained, however, 60 per cent. lead, and in spite of the high cost of freight yielded a profit, owing to the high price of lead (seven cents a pound) then ruling. It having thus been proved that Leadville ore could be worked at a profit, prospecting was vigorously carried on, the next discovery being that of the Gallagher Brothers on the Camp Bird claim, supposed at that time to be the northern continuation of the Iron-Lime outcrop. This discovery was made late in the fall of 1876, and the claim now forms part of the property of the Argentine Mining Company. During this winter the Long and Derry mine was discovered by two prospectors of these names, who still own the mine and have become wealthy from its product. During the spring and summer of 1876 discoveries were made along what was then known as the

second contact, on Carbonate hill, the Carbonate and Shamrock mines being the first to yield considerable quantities of pay ore.

In the following years the famous ore bodies on Fryer hill were discovered by a singular accident. At this point there is no outcrop, the whole surface of the hill being covered to an average depth of 100 feet by detrital material. Tradition has it that two prospectors were "grub-staked," or fitted out with a supply of provisions, by Tabor, half of all they discovered to belong to him. Among the provisions was a jug of whisky, which proved so strong a temptation to the prospectors that they stopped to discuss its contents before they had gone a mile from town. When the whisky had disappeared, though its influence might probably have been still felt, they concluded that the spot on which they had thus prematurely camped was as good a one to sink a prospecting hole on as any other. At a depth of 25 or 30 feet their shaft struck the famous ore body of the Little Pittsburg mine, the only point on the whole area of the hill where rock in place comes so near the surface. Discoveries rapidly multiplied in this region; immense amounts of ore were taken out, and the claims changed hands at prices which advanced with marvelous rapidity into the millions. A half interest in one claim which was sold one morning for \$50,000, after being transferred through several hands, is said to have been repurchased by one of the original holders for \$225,000 on the following morning.

The foundation of Mr. Tabor's wealth was laid in the first discovery on Fryer hill, but its amount was materially increased in a singular way. When the fame of the rich discovery of Fryer hill had already become known at Denver, the wholesale house from which he was in the habit of buying his provisions commissioned him to buy for them a promising claim. On his return to Leadville, in accordance with this agreement, he purchased on their account, for the sum of \$40,000, the claim of a somewhat notorious prospector known as Chicken Bill, on what is now Chrysolite ground. Chicken Bill, in his haste to realize, had not waited till his shaft reached rock in place, but had distributed at its bottom ore taken from a neighboring mine, or, in the language of the miners, he had "salted" his claim. After the bargain with Tabor had been concluded he could not resist the temptation of relating to a few of his friends the part he had

played in the transaction. The report of what he had done thus reached the ears of Mr. Tabor's Denver correspondents before he himself arrived to deliver the property, when they not unnaturally declined to receive it, and Mr. Tabor was obliged to keep it himself. He, with his associates, under the title of Tabor, Borden & Co., afterward bought some adjoining claims and developed their ground, from which they are said to have taken out in the neighborhood of \$1,500,000, and afterward to have sold their property to the Chrysolite Company for a like sum.

In the spring of 1877, under Mr. Meyer's direction, the first smelting furnace was erected at Leadville by the St. Louis Smelting and Refining Company, now known as the Harrison Reduction Works, and others followed in rapid succession.

**Growth of the city.**—The nucleus of the present city of Leadville consisted of a few log houses scattered along the borders of the California gulch below the Harrison Reduction Works. In the spring of 1877 a petition for a post-office was drawn up by Messrs. Henderson, Meyer, and Wood, which necessitated the adoption of a name for the new town. Mr. Meyer proposed the names of Cerussite and Agassiz, both of which were rejected as being too scientific. Mr. Wood proposed the name of Lead City, to which Henderson objected that it might be confounded with a town of the same name in the Black Hills, and the name of Leadville was finally adopted as a compromise. The rapidity of the growth of this city borders on the marvelous. In the fall of 1877 the population of Leadville was estimated at about two hundred persons. The business houses of the town were a 10 by 12 grocery and two saloons. In the spring of 1878 a corporation was formed, which was continued for six weeks, when the town's growth justified its transformation into a city of the second class, Mr. W. H. James being the first mayor and John W. Zollars city treasurer. Within two years Leadville grew to be the second city in the State, with 15,000 inhabitants and assessable property of from \$8,000,000 to \$30,000,000. In 1880 it had 28 miles of streets, which were in part lighted by gas at an expense of \$5,000 per annum. It had water-works, to supply all the business portion of the city, having over five miles of pipe laid. It had 13 schools, presided over by 16 teachers, and an average attendance of 1,100

pupils; a high school, costing \$50,000; five churches, costing from \$3,000 to \$40,000; and three hospitals, in one of which 3,000 patients were treated during the year. In 1880 \$1,400,000 were expended in new buildings and improvements. It had 14 smelters, with an aggregate of 37 shaft-furnaces, of which 24 were in active operation during the census year, and its producing mines may be roughly estimated at 30.

*Production.*—The amount that is annually added to the metallic wealth of the world by the Leadville district, the productive area of whose deposits as at present opened may be estimated at about a square mile, is truly remarkable. Its annual silver product alone is greater than that given by official estimates for any of the silver-producing nations of the world outside of the United States except Mexico. Its lead product, on the other hand, though frequently neglected in estimating the total value of its output, is nearly equal to that of all England, and, of other nations outside of the United States, it is only exceeded by that of Spain and Germany.

In the magnitude of its product Leadville has been only surpassed in the United States by the famous Comstock lode in the Washoe district of Nevada, and the surprising rapidity of its development in the few years of its existence has been even more remarkable than that of the latter, which produced forty-eight millions of gold and silver during the five years succeeding its discovery. The third district of comparable importance in the magnitude of its product from a comparatively restricted area is the Eureka district of Nevada, which, according to Mr. Curtis, has, in the first fourteen years of its existence, produced sixty millions of gold and silver and 225,000 tons of lead.<sup>1</sup>

Owing to the want of any general law compelling producers to furnish an exact and sworn statement of the amount of their annual product, it is impossible to obtain anything more than an approximate estimate of the metallic production of a mining district like Leadville. Such an estimate varies necessarily in the closeness of its approximation, with the care with which it is made, with the accuracy with which the records of individual mines and smelters have been kept, and with the readiness shown

---

<sup>1</sup> J. S. Curtis, *Silver-lead Deposits of Eureka*. Washington, 1884.

under varying circumstances to furnish these records to those who may be gathering statistics.

The most trustworthy estimates of production are those that were obtained for the year ending May 31, 1880, by those engaged in collecting statistics of the production of the precious metals for the Tenth Census. This is due to the fact that not only was the force of experts sufficient to visit personally all the important mines and smelting works, but the law gave them the authority to demand, if necessary, an accurate transcript of their records, and the data thus gathered were subjected to a critical analysis during compilation by those technically familiar with the various branches of mining industry. Moreover, it was a most favorable epoch in the development of the district for obtaining an accurate record, since the larger mines were being systematically worked, the record of their product was kept with relative accuracy, and as yet but little ore was shipped out of the district for reduction and thus rendered difficult to trace.

The Census figures of production for this period are as follows:

*Leadville products during census year, 1879-'80.*

	Gross weight.		Contents.					
			Gold.		Silver.		Lead.	
	<i>Tons.</i>	<i>Kilos.</i>	<i>Ounces.</i>	<i>Kilos.</i>	<i>Ounces.</i>	<i>Kilos.</i>	<i>Ounces.</i>	<i>Kilos.</i>
I. Ore extracted .....	152,241	138,110,707	1,716	53.36	10,603,331	329,763.5	(1)	.....
II. Ore smelted .....	140,623	127,571,118	3,913.7	121.81	9,717,819	302,224	(1)	.....
III. Bullion produced by Leadville smelters.	28,283	25,657,921	3,830.2	119.11	8,053,946	250,478	28,226	25,606,212

In the above table, I gives the amount of ore extracted from the various mines during the year and the contents of the same in silver and gold, as determined by assay at the mines.

II gives the amount of ore smelted during the year and its assay value in silver and gold, including that sent out of the district for reduction, as determined by the returns from smelters and sampling works.

III gives the bullion produced during the census year by the smelters situated at Leadville and its contents in lead, silver, and gold.



It thus appears that the Leadville ores contained during the year an average of  $69\frac{1}{2}$  ounces of silver per ton, and that the bullion produced therefrom contained an average of 285 ounces of silver per ton. The apparent discrepancy in the amount of gold given under the various heads may arise in part from the fact that it is generally present in such minute quantities in the ore that the assayers at the mines do not always make an estimate of it, and in part from small lots of gold-bearing ore either from Leadville itself or from adjoining districts that have escaped notice in making up the returns from mines, or in segregating outside ore in returns from sampling works and smelters. It was not possible to obtain an accurate estimate of the average percentage of lead contained in all the ores extracted. It appears, however, from data obtained from the eight principal smelters running at that time that the average yield per ton of ores treated by them during the year was 398.8 pounds or 19.94 per cent. of lead bullion, containing 65.64 ounces or 0.225 per cent. of silver.

The various newspapers of Leadville have published monthly statements of the bullion product of the district, upon which the annual official statements made by the Director of the Mint and other estimates of the product of the district have been based. These figures often bear internal evidence of incompleteness or inaccuracy, and from want of any evidence of the relative care with which they have been made, it is difficult to know, in cases of discrepancy between them, which is the most trustworthy. Nevertheless, in the absence of any other complete data, these must be assumed as the nearest approximation available.

The following table of the product of the district, since the discovery of silver-lead deposits, has been compiled from these sources, using mainly the figures of the Leadville Herald, which have been the most continuously collected and published. In the case of shipments of ore to be reduced outside the district, of which only the price received is in many instances given, the weight of the metals contained in these shipments has been assumed arbitrarily to average the same as those in which the relative weights are known, which evidently cannot give the exact amount in every case, but which would be probably as nearly correct as an arbitrary assumption of probable averages for each year. The value of the total

product is calculated according to the mint valuation (\$1.2929 per ounce of silver), which, as is well known, is in the case of silver considerably higher than the fluctuating market value, and increases the value given for the total product by about seven million dollars above that which would be obtained by using the market value, if it were possible to obtain it in each case. The price of lead is assumed at 4½ cents a pound as an average for the whole period involved:

*Production of Leadville mines from 1877 to 1884, inclusive.*

	Gold.		Silver.		Lead.		Value.
	<i>Ounces.</i>	<i>Kilograms.</i>	<i>Ounces.</i>	<i>Kilograms.</i>	<i>Tons.</i>	<i>Kilograms.</i>	<i>Dollars.</i>
Reduced at Leadville.....	77, 107	2, 401	42, 080, 722	1, 308, 990	203, 831	184, 912, 426	74, 358, 395
Shipped out of the district...	25, 825	803	9, 012, 644	280, 293	102, 867	93, 310, 399	21, 506, 343
Total.....	103, 022	3, 204	51, 102, 366	1, 589, 283	306, 698	278, 231, 825	95, 864, 738

In the time that has elapsed since the census year, although, owing partly to decline in value of the metals and partly to a lower average tenor of the ore, the total value of the annual product has decreased, the amount of ore extracted from the mines of the district has very considerably increased, this having been in the census year (1879-1880) 152,241 tons, and in the year 1884, according to the report of the Director of the Mint, 232,000 tons.

## CHAPTER II.

### GENERAL GEOLOGY OF THE MOSQUITO RANGE.

#### ROCKY MOUNTAINS IN COLORADO.

The simplest expression of the geological structure of the Rocky Mountains in Colorado is that of two approximately parallel uplifts or series of ridges of Archean rocks, upon whose flanks rest at varying angles a conformable series of sedimentary formations extending in age from the earliest Cambrian to the latest Cretaceous epochs, the latter being locally overlaid by unconformable Tertiary beds.

The eastern uplift is generally known as the Colorado or Front Range and the western as the Park Range, the series of depressions or mountain valleys between them having received the name of parks.

The most prominent fact thus far recognized in the geological history of this region is that a great physical break or non-conformity in the strata is found between the Cretaceous and Tertiary formations; in other words, that at this period occurred the great dynamic movement which uplifted the Rocky Mountain region essentially into its present position. As the beds of the Paleozoic and Mesozoic systems have been thus far found to be practically conformable throughout the region, it may be assumed that no important dynamic movement took place during these eras, and that deposition went on continuously, except when continental elevations of the whole region may have caused a temporary recession of the waters of the ocean for a limited period, and thus produced a gap or gaps in the geological series without causing any variation in angle of deposition in the at present successive beds.

**Eastern uplift.**—The Colorado or Front Range is the more extensive and more important of the two Archean uplifts, and along its eastern flanks is exposed, by the denudation of the overlying Tertiary formations, an almost continuous fringe of upturned Paleozoic and Mesozoic beds.

The most significant geological fact to be observed in connection with these exposures of upturned beds is that the formation which is immediately adjacent to the Archean varies from place to place. At one point Triassic beds, sloping away at varying angles from the flanks of the mountain, rest directly upon the Archean beds; at another point the lower beds of the Cretaceous; at still another, and this more rarely, the Carboniferous limestones are exposed resting against the Archean, while above them, always conformable, are found the Triassic, Jurassic, and Cretaceous formations as one follows the section in an ascending geological sense. At one or two points only along the eastern flanks Silurian beds are exposed beneath the Carboniferous.

It has been customary with many of the early geological explorers to consider the uplift of these mountain ranges to be that of a simple anticlinal fold in the sedimentary strata, which once arched over the underlying nucleus of crystalline rocks; this was once considered the typical structure of a mountain range. In practical field geology, however, it is found that the symmetrical form resulting from this typical structure of mountain range is one of the rarest occurrences, at least in the Rocky Mountain region. The one great instance of such a perfect anticlinal range is that of the Uinta Mountains, which presents exceptional features distinguishing it from the majority of mountain ridges of the Rocky Mountain system; this has a peculiarly normal anticlinal structure in the first place, and in the second place its trend is east and west, whereas all the other great mountain ridges of the Cordilleran system have a direction varying between north and south and northwest and southeast.

The facts just noticed with regard to the sedimentary beds which rest against the eastern flanks of the Rocky Mountains, it will be readily seen, exclude the possibility of the typical anticlinal structure above mentioned. If we suppose a conformable series of sedimentary beds to have been folded into a long anticlinal fold and the crest of this fold subsequently planed

off by erosion, so that the core of the fold is exposed, the projection or horizontal section made thus by the planing off of its crest would necessarily show a continuous line of outcrops along either side of the axis of the fold, in which the lowest bed of the conformable series would invariably be seen at the contact of the underlying rocks which, when these beds were deposited, formed the floor of the then existing ocean. In other words, if the Rocky Mountain uplift were a typical anticlinal uplift, the sandstones of the Cambrian period, which are the lowest beds of the conformable series exposed, would be found continuously along the eastern flanks of the Rocky Mountains wherever erosion had swept away the obscuring Tertiaries so that the edges of the folded rocks could be seen.

Since it is evident, then, that the entire series of these beds could not at any time have arched over the present Archean exposures, the alternative presents itself that these exposures represent an ancient continent or island along whose shores they were deposited, a hypothesis which is borne out by the lithological character of the beds themselves, which bear abundant internal evidence, in ripple-marks, in prevailing coarseness of sediment, and in the abundance of Archean pebbles in the coarser beds, that they are a shore-line deposit. The varying completeness in the series of sedimentary beds exposed at different points would in this case be explained by unequal local erosion or elevation, by which the contact, now of a lower, now of a higher horizon, with the original Archean cliff would be laid bare.

Inasmuch as the same evidence of shore-line conditions is found wherever the sedimentary beds adjoining the larger masses of Archean have been carefully studied, and as, moreover, in no part of the higher regions of these Archean ridges have relics of sedimentary beds been found, not even of the later Tertiary formations, as would be expected had they originally arched over these ridges, it is evident that these Archean islands have never been entirely submerged since they first appeared above the ocean level.

The Colorado Range formed the most extensive of these ancient landmasses, and its outlines probably did not vary essentially from those of the present Archean areas. Extending from Pike's Peak northward to the boundary of the State, its dimensions were approximately one hundred and fifty miles in length by about thirty-five to forty miles in width. To the eastward

it presented a continuous and regular shore line, broken only by a single narrow bay, separating the Pike's Peak mass from the mainland, and now known as Manitou Park. On the west, toward the parks, its original outlines are as yet less certainly known, but though less regular they probably had a general parallelism with the eastern shore line. North and south this line of elevation was continued by a series of islands and submerged reefs to the Black Hills of Dakota on the one hand and into the present Territory of New Mexico on the other.

*The Parks.*—That the present valleys, known respectively as the North, Middle, and South Parks, have been more or less submerged in Paleozoic and Mesozoic and again in Tertiary times, and that at one time they formed a connected series of bays or arms of the sea, is proved by the sediments of those eras that are still found in them. Although the geology of the park region has not been studied in sufficient detail to afford complete data in regard to its past history, enough is known to furnish its general outlines.

In some respects the present conditions of these depressions are those that prevailed in the earliest Paleozoic times; in others they have experienced more or less change. Then as now the outlet or opening of the North Park was toward the north, of the Middle Park toward the west, and of the South Park toward the south. On the other hand, up to the close of the Cretaceous the North and Middle Parks were connected and formed a single depression; the present mountain barrier between the Middle and South Parks did not extend as far as their western boundaries, and a water connection existed between them, whose outlines cannot now be given exactly, owing to faulting and subsequent denudation; again, the waters of the South Park extended westward to the flanks of the land mass now forming the Sawatch Range. It seems probable that in earlier Paleozoic times only the North and South Parks were sufficiently submerged to receive the sediments that were washed down from the neighboring land masses, but that, as time went on, the waters became deeper or the sea bottom subsided, so that in Cretaceous times sediments were deposited continuously through the three valleys. In Tertiary times again, after they had been raised above the ocean-level, fresh-water lakes occupied the parks, and in their basins

sedimentary beds were deposited, which have since been so extensively eroded off that the age or extent of these lakes cannot readily be determined.

**Western uplift.**—The western boundary of the park area consisted of two or more distinct ridges or islands, forming, however, a general line of elevation nearly parallel with that of the Colorado Range. These are the Park Range proper, on the west side of the North Park, and the Sawatch Range, now separated from the South Park by the Mosquito Range. Between these was the Archean mass of the Gore Mountains, which formed, with the southern extremity of the Park Range, the western wall of the Middle Park, of whose geological relations but little is definitely known.

The present topographical boundary of the South Park on the west is the Mosquito Range, which has for this reason been also called the Park Range. Geologically, however, this name is less appropriate than topographically, since prior to Cretaceous times no Mosquito Range existed, but the rocks which now form its crest still rested at the bottom of the sea. The Sawatch range forms the normal southern continuation of the Park Range as an original Archean land-mass; hence it seems advisable to avoid the use of the name Park Range in this latitude.

The Archean land-mass of the Sawatch in Paleozoic times, judging from the almost continuous fringe of Cambrian beds encircling it, as shown on the Hayden maps, which may be assumed to represent a tolerable approximation to its original outlines, was an elliptical-shaped area, trending a little west of north, with a length of about seventy-five miles and an extreme breadth of about twenty miles. Through the eastern portion of this area, and parallel with its longer axis, runs the valley of the Upper Arkansas River, now an important feature in the topography, but which during Paleozoic and Mesozoic times did not exist.

The relative height of these mountain masses above the adjoining valleys must have been far greater than now, since the sedimentary beds which surround them must have been formed out of the comminuted material abraded from their slopes. It is probable, however, that they were not the only land masses at that time, and future geological studies in this region will doubtless decipher many yet unopened pages in its past history. The great area of volcanic rocks to the southwest, whose

culminating points are the San Juan Mountains, may very likely conceal the remains of a former land mass of equal, if not greater, dimensions than this. The present Archean areas to the south, in the Wet Mountain and Sangre de Cristo Ranges, may also, in part at least, have been land masses at those times. Moreover, the not infrequent occurrence of Cretaceous beds lying directly upon the Archean at points far away from any well-defined ancient shore line, suggest elevations and subsidences of which the geological studies thus far made in Colorado furnish no record. The areas already mentioned were, however, the most important elevations, since they are the only ones of which it may now be said with tolerable certainty that they have been permanent land surfaces through the long cycles that have elapsed since the commencement of the Paleozoic era. Their consideration, therefore, is all that is necessary for the purposes of the present study.

**Mountain structure.**—It is no longer assumed, as it was in the early days of geology, that the elevation of mountains is the result of a vertically acting force or a direct upthrust from below. On the contrary, the generally received contraction theory, which is the one that best accords with all observed facts of geological structure, supposes that it is horizontally acting forces that have uplifted them. According to this theory, during the secular cooling of the earth from a molten mass, a solid crust was first formed on its exterior. As cooling and consequent contraction of the whole mass went on, this first-formed crust, in order to adapt itself to the reduced volume of its nucleus, also contracted; but, as it was more or less rigid, this contraction resulted in the formation of wrinkles or ridges on its surface, which there is considerable evidence to show occupied essentially the same lines that the present mountain systems of the world do. Whatever the determining cause that originally fixed these lines, the earth's crust along them would have been compressed, plicated, and probably fractured, and, in subsequent dynamic movements resulting from continued contraction, they would have constituted lines of weakness along which the effects of these movements would have found most ready expression.

Whether the consolidation of the entire earth-mass is already completed, or whether there still remains a molten nucleus towards its centre, is a purely speculative question, upon which geologists are not yet in entire



accord, and whose discussion would not be appropriate in a memoir like the present, which has to do with observed facts and with theories only so far as they are necessary for a proper comprehension of these facts. It is an observed fact that in the great mountain systems are found the most intense expression of the compression of the crust, in plications and in great faults. It is also an observed fact that along these lines of elevation and of consequent fracturing of the crust, have occurred the most extensive extrusions and intrusions of molten or eruptive rock, whatever may have been their source—whether from a fluid center or from a fluid envelope between a solid center and a solidified crust, or from subterranean lakes of molten rock at different and varying points beneath the crust. It may likewise be considered a fact of observation that the tangential or horizontal thrust which the contraction theory requires most readily accounts for the plication and faulting of the sedimentary beds which geological study discloses. This thrust may be best conceived as the expression of two forces of compression: a major force acting at right angles to the longitudinal axis of the mountain system, or east and west, and a minor force acting in a direction parallel with that axis, or north and south.

The geological structure of the Rocky Mountains forms as marked a contrast to that of the regions adjoining it on either side as do its topographical features. On the Great Plains, which stretch in an almost unbroken slope from their eastern base to the Mississippi River, or, it might be said, to the western foot of the Appalachians, the strata which form the surface lie in broad undulations, whose angles of dip are so gentle as to be scarcely perceptible to the eye, and which are apparently broken by no important displacements.

In the Colorado Plateau region, which extends from their western edge to the base of the parallel line of uplift of the Wasatch, the beds seem as horizontal as when they were originally deposited, but along certain lines abrupt changes of level are brought about by sharp monoclinical folds, accompanied by or passing into faults, and having great longitudinal extent.

In the intervening mountain region the strata are compressed against the original land masses and flexed until the limit of tension is reached, when by great displacements, often measured by thousands of feet, their

edges are pushed past and over each other, the movement of both folds and faults showing that the force which produced them was acting from either side toward the center of the original land masses.

As contrasted with the Basin region west of the Wasatch uplift, the folds of the Rocky Mountains show a greater plasticity in the sedimentary strata by their relative sharpness, the anticlines and synclines in the former having more gentle and equal slopes, while in the latter they often have the form of an **S**, with one member almost bent under the other into an isocline.

Compared with the remarkably compressed folds of the Appalachians, on the other hand, where the isocline may be considered the type structure, the flexures of the Rocky Mountains show that the sedimentary rocks are far from possessing the great plasticity and compressibility that they have in the former. The contrast between the eastern and western mountain systems, in respect to the relative plasticity of their strata, is so marked that it would seem that the reason therefor must be readily apparent. It is not that the beds in the former are thinner; on the contrary, the corresponding Paleozoic formations are many times thicker in the Appalachians than in the Rocky Mountains. It is to be remarked, however, that in the former eruptive rocks are comparatively rare, especially those of Mesozoic and Tertiary age, while in the Rocky Mountains they are most abundant and in the western part of the Basin region they form the greater part of the surface; to this fact may probably be ascribed, as will be shown later, the less plastic condition of the earth's crust in the latter regions.

In the character of these eruptive rocks, again, there is a marked contrast between the Rocky Mountains and the Basin region of Nevada. In the latter they almost exclusively belong to the Tertiary volcanics, approaching in character the lavas of modern volcanoes, the older and more crystalline varieties, corresponding to the Mesozoic porphyries of Europe, having been rarely observed on the surface. In the Rocky Mountain region, on the other hand, while the Tertiary eruptive rocks are often developed on a very large scale, the earlier and more crystalline varieties seem to have an equal and even greater importance, if not in the actual amount of surface

they occupy, certainly in the influence which they have had upon the concentration of mineral formation.

In that portion of the Rocky Mountain region under consideration there is a noticeable connection between the structural lines and those along which eruptive action has been most active. The latter correspond with the lines of weakness, of greatest folding and faulting. Leaving out of consideration the dikes which traverse the Archean rocks, which, though numerous, are of relatively small mass, the eastern uplift gives evidence of little eruptive activity, it being shown only by a few isolated outflows of Tertiary lavas. Along the line of the parks, on the other hand, both earlier and later eruptions are so frequent that their outcrops form an almost continuous line from north to south parallel with the western uplift, while along the west base of the latter the Elk Mountains, the head of White River, and the Elk Head Mountains in Wyoming have apparently been the scenes of most violent and repeated eruptions during both Mesozoic and Tertiary times.

#### MOSQUITO RANGE.

**Topography.**—That portion of the Mosquito Range the study of whose geological structure was considered necessary for a proper comprehension of the ore deposits of Leadville is shown in relief on Atlas Sheet V. It comprises a length of 19 miles along the crest of the range, and in width includes its foot-hills, bordering the Arkansas Valley on the west and South Park on the east, a slope in the one case of seven and one-half miles and in the other of about nine miles in a direct line. This is essentially an alpine region, scarcely a point within the area of the map being less than 10,000 feet above sea level.

In this area the range has a sharp single crest trending almost due north and south, the échelon structure being, however, developed on the northern and southern limits of the map respectively. To the west this crest presents abrupt escarpments, descending precipitously into the great glacial amphitheatres which exist at the head of almost all the larger streams flowing from the range. The spurs have extremely irregular, jagged outlines, resulting from the numerous minor hills which rise above the average slope. Within a few miles of the valley bottom, however, their form sud-

denly changes, and from sharp serrated ridges they become broad, gently sloping mesas or table-lands. On the eastern side, though the descent into the glacial amphitheatres is almost as precipitous, the average slope is much less steep, and the spurs as a rule descend in long sweeping curves, widening out gradually as they approach the valley.

The spurs on either side of the range are thickly covered with a forest growth of alpine character, reaching from the valleys of the streams up to an average altitude of 11,700 feet, the upper limit varying somewhat with the more or less favorable conditions of the surface, and extending apparently somewhat higher on the western than on the eastern slopes.

In the northern portion of this area, between the heads of the Arkansas and Platte Rivers, the main crest of the range, which has hitherto followed an almost straight line, takes a bend en échelon, and is continued on a line removed about two miles to the eastward, resuming, however, its original line just beyond the limits of the map. The massive formed by the three peaks, Mounts Cameron, Bross, and Lincoln, the last the highest point within the area mapped, lies still to the eastward of this crest and is topographically an almost independent uplift. Sheep Mountain and the ridge which extends southeastward from it also form an apparently abnormal feature in the topography of the eastern slope.

The sketch given in Plate III shows the general outlines of the eastern slopes of the Mosquito Range and the basin of the South Park, as seen from a western spur of Mount Silverheels. The sky-line of the western half is the crest of that portion of the range included in the map which lies south of Mosquito Peak, the low gap is that of Weston's pass, beyond which is the Buffalo Peaks group. The various gulches south of the Mount Lincoln massive are indicated by name, and the lines of outcrop on their walls are somewhat strengthened to show the geological structure, which will be explained in detail in Chapter IV. Buffalo Peaks are 25 miles distant from the point of view, and the volcanic hill in the extreme left-hand corner of the sketch, seen across the South Park plain, is over 40 miles distant. The little hill on the edge of the plain, and on a line with the eastern spur of Buffalo Peaks, which forms the continuation of the Sheep Mountain ridge, is Black Hill, which lies just beyond the extreme

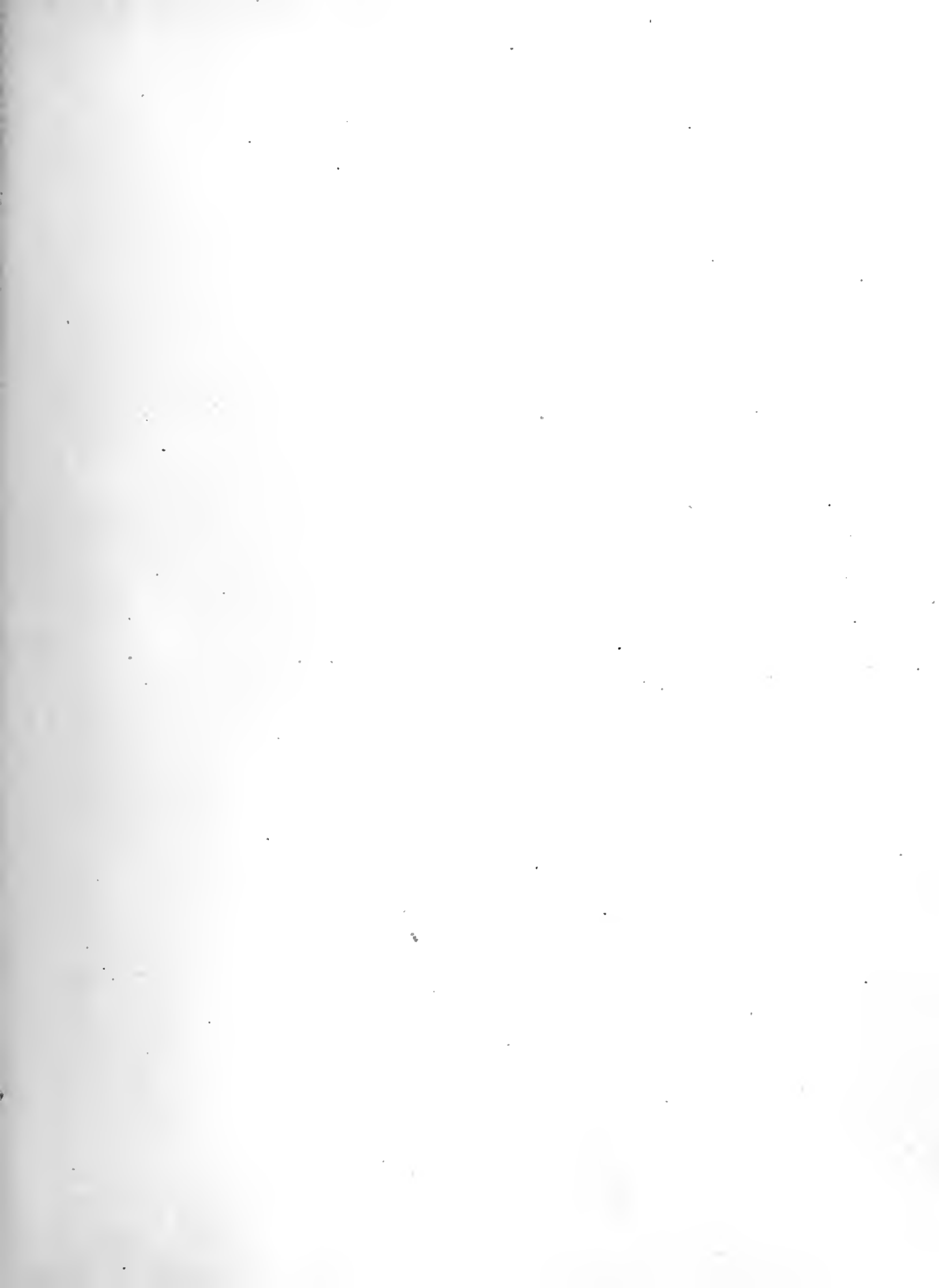

South Park

Buffalo Peaks



Sheep Mt.

White Ridge.

Gemini Peaks

Dyer Mt.



Platte Valley

S.F. Emmons, Geologist in Charge





southeast corner of the Mosquito map. The base of this hill is 10,000 feet above the level of the sea.

It were scarcely possible to select an alpine region more admirably adapted to illustrate the interdependence of topographical and geological structure than that chosen for this study. The gentle slopes of the eastern spurs follow the inclination of the easterly dipping beds of Paleozoic rocks which form their surface, and which remain in broad sheets, like the covering of a roof, to protect the underlying Archean schists from erosion. Where they have been cut through, first by the erosive action of glaciers and later by the corrasive action of mountain streams, to their stratified structure is due the formation of the almost perpendicular cliffs which form the cañon walls of their streams. The generally abrupt slope immediately west of the crest is due to a great fault extending along its foot, in virtue of whose movement the western continuation of the sedimentary beds, which slope up the eastern spurs and cap the crest itself, are found at a very much lower elevation on the western spurs; while the jagged outline of the western spurs is due to a series of minor faults and folds, crossing them nearly at right angles. The secondary uplift of the Sheep Mountain ridge on the eastern slopes is the expression of a second great line of fault and flexure, whose direction, like that of the ridge itself, forms an acute angle with that of the main crest. The elevation of the Mount Lincoln massive is the result of a combination of the forces which have uplifted the Mosquito Range and of those which have built up the transverse ridge which separates the South from the Middle Park.

In the later topography of the range the results of the action of a system of enormous glaciers are seen in the immense amphitheatres which form the heads of its main streams, and in the characteristic V-shaped transverse outlines of the valleys descending from them. Finally, the mesa-like character of the lower end of the western spurs toward the Arkansas Valley is due to the existence beneath their surface of comparatively undisturbed beds deposited at the bottom of a lake formed at the head of that valley by the melting of the ice at the close of the first portion of the Glacial period.

The evidence furnished by the deposits of this lake affords an interesting confirmation of the deduction already made by geologists from the study of the glacial drift in Europe and in the Eastern States, and by Messrs. King and Gilbert from their study of the lake deposits of the Basin regions of Utah and Nevada; namely, that the Glacial period presented two maxima of cold, with an intervening warmer period during which the ice was partially melted and vegetation flourished. The general character of the stratified deposits of the Arkansas Lake shows that they must have been carried down during a time of great floods and that they are formed largely of rearranged moraine material. The thickness of these deposits proves the existence during a long period of a lake which during part of the year was not frozen; their position shows that the shores of the lake extended several miles to the eastward of the Arkansas Valley. Finally, the facts that these beds are deeply buried beneath surface accumulation of detrital material and that the moraines of now extinct glaciers extend out beyond the original shore-line of the lake and rest above its beds, prove that subsequent to the draining of the lake another set of glaciers, formed during a later period of cold, covered the slopes of these mountains and carved out to a greater depth the present valleys.

**Geological history.**—Although now so prominent a feature in the topography of the Rocky Mountains, the Mosquito Range, from the sources of the Arkansas River to the southern end of the main Arkansas Valley, is geologically a part of the Sawatch uplift. It was from the abrasion of the land surfaces exposed in the Archean island which occupied the present position of the Sawatch range that the sediments which constitute its stratified beds were doubtless in a great measure formed. In the seas that surrounded this island during Paleozoic and Mesozoic times was deposited a conformable and, as far as present evidence shows, an almost continuous series of coarse sandstones and conglomerates, alternating with dolomitic limestones and calcareous and argillaceous shales. The geology of the Rocky Mountains has not yet been studied in detail over a sufficiently extended area to afford data for tracing the history of the elevations and subsidences to which the region as a whole may have been subjected, or of the alternate recessions and advances of ocean waters during this long lapse of time. The examination

of these beds made during the present investigation furnishes some evidence of a shallowing of these seas, and perhaps even of the existence of some land surfaces subjected to erosion during part of this time. Still, the absence of non-conformity in the successive strata deposited and their great uniformity throughout the area studied show that no violent dynamic movement took place before the great disturbance at the close of the Cretaceous, which extended throughout the whole of the Rocky Mountain system and was doubtless the main factor in producing its present elevation.

During this long period of conformable deposition there was an accumulation in this area of 10,000 to 12,000 feet of sedimentary beds. Toward the latter part of this period, possibly very near its close, there was an exhibition of intense eruptive activity, during which enormous masses of molten rock were intruded through the underlying Archean floor into the overlying sedimentary deposits, crossing the beds to greater or less elevations and then spreading out in immense sheets along the planes of division between the different strata. It is not possible at present to define all the points at which these eruptive masses forced their way up, although they were doubtless very numerous and widely spread throughout the region; but the negative evidence obtained proves that the intrusive force must have been almost inconceivably great, since comparatively thin sheets of molten rock were forced continuously for distances of many miles between the sedimentary beds. That the eruptions were intermittent and continued during a considerable lapse of time is proved by the great variety of eruptive rocks now found and by the fact that a given rock in one place precedes and in another follows a second. It might naturally be thought that this eruptive activity must have been coincident with or immediately subsequent to a great dynamic movement; but that it preceded the movement at the close of the Cretaceous, which caused the uplift of the Mosquito Range as well as of the other Rocky Mountain Ranges, is proved by the fact that these interbedded sheets of eruptive rocks, porphyries and porphyrites, are found practically conformable with their bounding strata, and, like them, folded into sharp folds and cut off by faults. The intrusion between the strata of such vast masses of rock—which in some cases reached a thickness of from 1,000 feet to 2,000 feet, and of which in other cases suc-

cessive beds varying from 50 feet to 200 feet in thickness are now found intercalated between alternate strata to the number of 15 or 20 in a single section—must necessarily have produced great irregularities in the once level surface of the then existing crust; but these irregularities were largely obliterated by the dynamic movements which followed, and the only traces still remaining are variations in the strike of the inclosing beds, which show a tendency to curve around any concentration of eruptive masses.

At some time during the long period which intervened between the final deposition of the latest sediments of the Cretaceous epoch and the succeeding deposition of Tertiary strata, and during which the waters of the ocean gradually receded from the Rocky Mountain region, the pent-up energy of the force of contraction of the earth's crust, which had accumulated during ages of comparative geological tranquillity, found expression in intense and prolonged dynamic movements of the rocky strata forming the immediate crust of the earth in this region. These dynamic movements in their simplest form may be conceived as a pushing together from the east and from the west of the more recent stratified rocks against the relatively rigid mass of the already existing Archean land masses, and a consequent folding or crumpling of the beds in the vicinity of the shore-lines, where, owing to the break in the continuity of the strata and the more irregular character of the floor upon which they rested, the conditions were more favorable to the crumpling movement than they would be, for instance, in the open plains, where a great thickness of level and hitherto undisturbed beds offers no lines of weakness to favor a commencement of folding. It is here a question only of the movement of the distinctly stratified beds, because it is in these alone that the resulting flexures can be accurately studied and mapped out; but it is evident that the crystalline and already violently contorted beds which formed the Archean land masses must have also partaken in the resulting movements, and their axial regions have been lifted up to a great elevation, of which the present height of the culminating peaks of the Rocky Mountains, formed as they are in the majority of cases exclusively of Archean rocks, is only a very much modified expression. Contemporaneously with the east and west movements (the expression of the major force of contraction in this region), there acted also a minor force

of contraction in a north and south direction, whose effects can now be seen along the eastern foot-hills in gentle lateral folds, their axes approximately at right angles to the trend of the range, and whose presence is indicated by a sudden bend or curve in the line of sedimentary outcrop, where at one point, owing to a local synclinal, the beds have been more or less preserved from erosion, and again where, owing to the crossing or coincidence of crests of the folds, like those of waves crossing each other, is found an otherwise unexplainable steepening in the dip of the strata.

It must be borne in mind that, while this great dynamic movement is defined as occupying a certain lapse of geological time and its principal effects were brought about within that time, it is not to be regarded as a sudden convulsion, like that of an earthquake, though such disturbances may have occasionally occurred. On the contrary, it must be conceived to have been rather a slow and gradual movement, extending over a period of time of which human experience can form no adequate conception. Moreover, as will be shown in the detailed study of the region, it can be proved that in a modified degree this movement has been continued into so recent a period as that following the Glacial epoch, and may very probably be going on at the present day, although, owing to the great area involved, it has been impossible to obtain any demonstrable proof of its actual existence.

**Mineral deposition.**—It was during the period which intervened between the intrusion of the eruptive rocks and the dynamic movements which uplifted the Mosquito Range that the original deposition of metallic minerals in the Leadville region took place. These original deposits were probably in the form of metallic sulphides, though as now found they are largely oxidized compounds, and therefore the result of a secondary chemical action; although during this secondary action they may have been to a slight degree removed from their original position, their relation as a whole to the inclosing rocks must remain essentially the same. Their manner of occurrence and the probability that they were derived, in great part at least, from the eruptive rocks themselves prove that they must be of later formation than the latter, while the fact that they have been folded and faulted together with the inclosing rocks, both eruptive and sedimentary, shows that they must have

been formed prior to the dynamic movements, and that they are therefore older than the Mosquito Range itself. These deposits were formed by the action of percolating waters, which, having taken up certain ore materials in their passage through neighboring rocks, deposited them in a more concentrated form in their present position. This process may have taken place while the sedimentary beds were still covered by the waters of the ocean, and the waters therefore have been derived from it; whether this was actually the case or not cannot be known until the age of the eruptive rocks is more exactly determined. However, as it is already known by the estuarine character of its fauna that the latest Cretaceous formation must have been deposited in an already shallowing ocean, it seems probable that the area occupied by the Mosquito Range may have already emerged from the ocean at this time.

**Structural results of the dynamic movements.**—Before proceeding to a detailed geological description of the region included in the Mosquito map (Atlas Sheets VI and VII), which represents the results of the dynamic movements and of subsequent erosion, it may be well to give a brief summary thereof, thus reversing the natural order, for the benefit of those readers who may not have time or inclination to follow all the details of Chapter IV.

The average or major strike of the sedimentary beds and of the axes of the principal folds is northwest magnetic, or N. 30° W., but in some cases a strike due north and south is observed. In these two directions are seen the influence of the shore lines of the Sawatch island, against which the sedimentary strata were compressed; for, while this area lies mainly along the eastern shore line which has a north and south direction, in the northern part the beds had already commenced to sweep round to the westward along the northern shore line of the island. To the south of this area the crest of the Mosquito Range itself marks the eastern limit of Paleozoic beds, while from South Peak, near Weston's pass, northward this limit bends to the northwest toward the mouth of the east fork of the Arkansas. Beyond this line to the west everything is Archean; to the east of it Archean exposures are found only where denudation has removed their previous covering of Paleozoic and later beds; it may be assumed, therefore, to represent approximately the original shore line of the Paleozoic ocean.

The uplift of the Mosquito Range was not the simple pushing up of the beds into a monoclinical fold, as might appear at first glance from the seemingly regular dip of the beds from the crest down its eastern slopes, but a somewhat irregular plication of them into anticlinal and synclinal folds, and their fracturing by faults, which have the same general direction as the axes of the folds without coinciding exactly with them, and which often pass into folds at their extremities. The anticlinal folds have as a rule a very steep inclination, sometimes nearly vertical, on the west side of the axis and a more gentle slope to the east, thus approaching the form of the isocline. It is along this steeper slope that the fracturing has generally taken place, and the fault may thus follow the axis of a syncline or of an anticline, according as it runs to the one side or the other of this steep slope.

The north and south direction of the main crest of the range is evidently determined by the great Mosquito fault, which, starting at some as yet unknown distance beyond the northern boundary of the map, follows the foot of the steep slope west of the crest to the region of the Leadville map, where for a short distance it bends somewhat further to the westward and is thence continued southward in the Weston fault, which passes into a synclinal fold south of Weston's pass.

From the Mosquito fault just north of Mosquito Peak branches off the next most important fracture plane, the London fault, which runs in a southeasterly direction across the eastern spurs of the range. The line of this fault passes just east of the axis of a most pronounced anticlinal fold across London Mountain and Pennsylvania hill to Sheep Mountain, on the sides of which the folding can be most distinctly traced along the cañon walls. To the south of Sheep Mountain it apparently coincides with the axis of the anticlinal fold which forms Sheep ridge, and with it gradually dies out and passes under the level plain of the South Park.

The geological structure of the Mosquito Range is simplest toward the south and becomes more complicated as one goes north, reaching the extreme of complexity opposite Leadville. Near Buffalo Peaks, a few miles beyond the southern limits of the map, it seems to be a simple monoclinical fold, the western slopes being entirely of Archean granite, and the crest

formed by Cambrian quartzites dipping gently eastward and resting unconformably on the Archean.

At the southern edge of the map an anticlinal and synclinal fold comes in to the east of the monocline. Here the range has a double crest en échelon, divided by the longitudinal valley of Weston's pass, which runs northwest magnetic following the direction of the strike. The ridge of South Peak to the west of the pass is formed by a monocline of easterly-dipping Cambrian and Silurian beds. The valley of the pass itself is formed by a compressed synclinal fold in Carboniferous strata, along the eastern side of which runs the Weston fault, bringing up the Archean and Cambrian on its east side. The ridge bounding the valley on the east, which is the southern end of the main crest of the Mosquito Range, is an eroded anticlinal fold, from whose crest the overlying Paleozoic strata have been almost entirely removed, leaving the core of Archean exposed. On the very summit of Weston's Peak a small patch of Cambrian quartzites is left, a remnant of the crest of this fold, and at its western base the same beds are found in a vertical position adjoining the fault, while on the more gentle slopes of the eastern spur are found the regular succession of easterly-dipping Paleozoic beds belonging to the eastern member of the anticline. The ridge sinks to the southward, and over its southern end the arch of Paleozoic beds is still left entire, but the anticlinal fold also sinks to the southward and entirely disappears beyond the limits of the map.

The same general structure continues northward as far as Empire Hill, but a short distance from the southern edge of the map a second anticlinal fold, that of Sheep Ridge, comes in at the extremity of the eastern slope of the range, while from its steep western slope erosion has removed all trace of the synclinal fold seen on Weston's pass, leaving only the easterly-dipping Paleozoic beds belonging to the monocline on the west of the fault, and the Archean on its east side; the crest of the range is formed of easterly-dipping Paleozoic beds, or, where these have been eroded away, by Archean schists and granite. This double anticlinal structure is best shown in Section G (Atlas Sheet IX), which is drawn at right angles to the strike, and in which the supposed form of the eroded synclinal is shown by dotted lines. The line of this section also crosses two secondary anticlinals or



minor waves in the strata, which are the almost invariable accompaniments of the larger folds.

In this southern area the older eruptive rocks are but little developed, their only representative being a thin but persistent sheet of White Porphyry above the Blue limestone. This increases in thickness from about fifty feet at Weston's pass to over a thousand feet at its supposed source in White Ridge, on the north side of Horseshoe gulch.

In the middle region of the area mapped, through an east and west zone which includes the principal mines of Leadville and vicinity, the development of bodies of earlier eruptive rocks is so great that the structure of the sedimentary beds is obscured and not always easy to trace. On the eastern slopes the double anticlinal structure continues as far north as Mosquito Peak, at the head of Mosquito gulch. The great Sheep Mountain fold, with the London fault cutting through its steeper western side, gradually converges toward the crest of the range. Views of the sections of this fault-fold afforded by the cañons of Horseshoe and Big Sacramento gulches are seen in Plates XV, XVI, and XVIII. East of this fold the strata slope gently eastward, with a slight secondary fold traceable along the extreme foot-hills. Between the Sheep Mountain fold and the crest of the range the strata of the gradually narrowing syncline are cut across by the two great eruptive bodies of White Porphyry and of Sacramento Porphyry, in White Ridge and Gemini Peaks, respectively, which are accompanied by a slight displacement. The nearly horizontal Paleozoic beds forming the crest and eastern member of the main anticline extend somewhat to the west of the topographical summit of the range, but the western member of the anticline and the succeeding syncline (if it extended so far north) are either removed by erosion or buried beneath sheets of porphyry.

On the western slopes in this zone the sedimentary strata, now greatly augmented in thickness by interstratified sheets of porphyry and extending nearly to the valley of the Arkansas, are flexed into a number of minor folds and broken by many shorter faults, most of which pass at either end into anticlinal or synclinal folds. This is the area which is included in the detail map of Leadville and vicinity and which is described at length in Chapter V. It is traversed by seventeen larger and smaller faults and has

many anticlinals and synclinals, in which the prevailing dip of the beds is to the eastward and the throw of the faults is mainly an uplift to the east.

The area west of the Mosquito fault and north of the Leadville region is mainly occupied by beds of the middle member of the Carboniferous and by porphyry sheets, flexed into gentle folds of varying directions, but apparently not broken by faults. This region is already at some distance from the ancient shore line, which is marked by the outcrops of Cambrian and Silurian beds. These bend to the westward around the head of Tennessee Park, and reach well up on the north slopes of the Sawatch in the Eagle River region; but, while the sedimentary beds bend thus in general strike to the westward, the Mosquito fault and the crest of the range which has been uplifted by its movement continue on unchanged in their trend.

North of Mosquito Peak is a large area in the higher part of the range, including the splendid amphitheatres in which the Platte and Arkansas Rivers rise, where the overlying Paleozoic beds have been entirely removed and only Archean exposures, traversed by dikes of earlier eruptive rocks, now remain.

East of this area the flanks of Loveland hill and the massive of Mounts Bross and Lincoln are occupied by easterly dipping Paleozoic beds, which evidently are the eastern member of a broad anticlinal fold; but of the actual structure of the beds which once arched over the Archean area there is nothing left to tell. It is probable that there were folds here similar and more or less parallel to the Sheep Mountain fold, as has been indicated in a general way by the dotted lines in the sections which cross this region. A partial proof of this is afforded by a deep synclinal adjoining Mosquito fault on the west, somewhat similar to that on Weston's pass, which is found at the base of Bartlett Mountain, at the northern edge of the map; its axis has more westerly direction than the plane of the fault. In this northern area there is also a great development of earlier eruptive rocks as contrasted with the southern half of the region, though they have less relative importance than in the middle zone, which includes the immediate vicinity of Leadville. The greater proportion of these bodies are in the form of intrusive sheets, interstratified with Paleozoic beds; but the dike form is also found, more especially in the Archean exposures in the amphi-

theaters along either side of the crest of the range. These dikes are sometimes observed cutting up through the Archean into the overlying sedimentary beds and then spreading out in sheets between the strata.

**Displacement.**—The movement of displacement of the faults throughout this area has been, with a few unimportant exceptions, an upthrow to the east. The maximum movement of any one fault is that of the Mosquito fault, at the northern edge of the map, which is about five thousand feet. In general the movement of the individual faults decreases to the southward until they gradually pass into folds and it becomes nil. The aggregate amount of displacement, however, summed up along east and west sections, increases toward the middle of the region, where the development of sheets of eruptive rocks is greatest, and decreases as these become less important; thus, as above mentioned, the displacement at the northern edge of the map is about five thousand feet. In the middle region, where the faults are numerous, the aggregate displacement is 8,000 to 10,000 feet, and across Sheep Mountain and Weston Peak it has decreased to 3,500 feet, becoming nothing at all just beyond the southern limits of the map.

**Volcanic rocks.**—Thus far only the earlier eruptive rocks have been mentioned, for the reason that they alone were involved in the folding and faulting. Later eruptions of Tertiary volcanic rocks have taken place since the folding, and probably after erosion had done the greater part of its work in the removal of Paleozoic sediments. These eruptions within the area of the map consisted of rhyolitic lavas, of which the two most prominent outpourings were at the extremities of this area, the one forming the mass of Chalk Mountain north of the east fork of the Arkansas and some smaller bodies to the east of Frémont's pass, the other that of Black Hill, on the extreme southeastern edge of the area in South Park. Besides these there are small bodies in the granite and in the Cambrian quartzite at the west foot of Empire Hill. A few miles south of the southern limit of the map is an important volcanic eruption of andesitic lava, cutting across both the Archean and the Paleozoic beds, which forms the high mass of Buffalo Peaks. These later eruptions, however, so far as can be determined, had no influence upon the ore deposits of the region.

**General erosion.**—It is now impossible to determine how much of the erosion that has removed the crests of these folds and denuded such large masses of Archean rocks was accomplished earlier than the Glacial period, but it is evident that the carving and shaping out of the valleys which score the flanks of the range has been mainly accomplished since that time. It is, moreover, not absolutely certain that this area was entirely covered by later beds than the Triassic, since the only proofs that Jurassic and Cretaceous strata also extended over it conformably are founded on the fact that no unconformability between Jura and Trias has yet been observed here. On the other hand, no opportunity was offered for a detailed study of the relations of these two formations. That the beds of the Trias formed part of the conformable series and were deposited along the shores of the Sawatch island is definitely proved, although they are no longer found within the area of the map, by the fact that just beyond its limits to the north and east, in the Ten-Mile and Mount Silverheels districts, respectively, they form a continuous and conformable series with the Carboniferous beds, are folded and faulted with them, and carry the same intrusive sheets of eruptive rocks.

**Arkansas Valley erosion.**—The manner and date of formation of the main Arkansas Valley is a matter of interesting speculation. It is evident, as has already been said, that it did not exist before the dynamic movements which uplifted the Mosquito Range, and yet it must have already been a deep valley at the commencement of the Glacial period, since a large lake was formed in it during the first melting of the ice of that period, in whose bottom at least three hundred feet of sediments were deposited. Although no beds of undoubted Tertiary age have yet been recognized in it which would afford a definite date to reckon from, it is probable from structural evidence that a line of depression was formed by the elevation of the Mosquito Range and the accompanying faulting, which corresponded approximately with the present general direction of the valley. A new drainage system having thus been formed, the erosive agencies which have carried away so many thousand feet of rocks from the range itself gradually deepened and enlarged this new depression, until it has now assumed those majestic proportions that make it a topographical feature of scarcely

inferior importance to the great parks themselves, which date back to pre-Cambrian time.

**Glacial erosion.**—The detrital materials brought down from the adjoining mountains and deposited along the Arkansas Valley during the Glacial period show that the general form of the latter had already been determined before that time. These deposits, though of similar origin and lithological character, belong to two distinctly marked epochs. Those of the former constitute the so-called Lake beds, formed of detrital and mainly morainal material, brought down from the mountains by the freshets which occurred during the melting of the ice at the close of the first cold epoch of the Glacial period, and which formed stratified deposits at the bottom of the great lake at the head of the Arkansas Valley, which will be called the Arkansas Lake. These beds, which reached a thickness of at least three hundred feet, are now found on either side of the alluvial bottom of the present stream, forming the base of the mesa-like terminations of the mountain slopes and in some cases extending to an elevation of 1,000 feet above the present valley bottom, a height to which the angle of the deposition of the beds could hardly have carried them and which gives evidence that the elevation of the range has continued in a modified degree since Glacial times. After the draining of this lake, in some manner not now to be traced, a second epoch of glacier formation set in, during which the new glaciers occupied the same positions as the older ones and continued the work of grinding and valley carving. They extended out over the Lake beds deposited during the warmer period, as proved by the present position of the lateral moraines of Iowa and Evans gulches. An immense amount of detrital material must have been accumulated on the slopes of the range by this second system of glaciers, and during the floods and freshets that must have accompanied their melting and recession this material was partially rearranged and spread out over the lower part of the Leadville region, both above the already existing Lake beds and in some cases over rock surfaces not previously covered by these deposits. This rearranged moraine material has received the local name of "Wash." From the present regular and even surface of the lower spurs, where the Wash lies conformably over the Lake beds, it is evident that the former, like the latter, must have been

deposited in quiet waters, like those of a lake rather than of a mountain torrent, for which reason it seems probable that a second Lake Arkansas was formed at the very close of the Glacial period, perhaps by the damming up of the valley by a terminal moraine, which in its turn finally broke its barriers and was drained of its waters, leaving a basin-shaped valley in whose original bottom, as represented by the mesa-like spurs, the lower part of the present stream beds have been cut out.

**Stream erosion.**—The valleys of the minor streams which head in the amphitheatres at the summit of the range were shaped out and took their general direction during the Glacial period. It is evident that their upper portions, at the heads of these amphitheatres, have been but little changed by later erosion, since glacial striæ are still found in some cases on their present bottoms.

The amount of erosion produced by rain and running water increases in direct ratio with the distance from the crest of the range. In the valleys of some of the larger streams running down from its summit this erosion has cut to a depth of 500 feet below the valley bottom left when the glaciers receded, and many minor valleys, like California gulch, which do not head at the actual summit, have been entirely carved out by these agencies since the close of the Glacial period.

**Valleys.**—The valleys of the minor streams, or gulches as they are generally called, may be divided in the vicinity of Leadville into three classes, according to age and manner of formation. They may be distinguished as (1) glacial valleys, (2) valleys of erosion, and (3) surface valleys.

The first and oldest, which owe their main outline to the carving of glaciers, have in cross section a **U**-shape and head in glacial amphitheatres, from which they pursue a relatively straight course down the mountain slope. Their original form is more or less modified by subsequent erosion. To this class belong the larger valleys, often forming cañons on the east side of the range, and the east fork of the Arkansas and Evans, Iowa, and Empire gulches on the west side.

The valleys of the second class, which have been cut out of solid rock exclusively by the action of running water, have a **V**-shaped outline in cross section and a winding course, their direction being dependent on the

unequal resistance offered by the peculiar position or texture of the rocks out of which they are carved. They also want the amphitheater-shaped head which characterizes the first class. They are more recent than the glacial valleys and have sometimes been cut out of their bottoms. The most striking example of this kind of valley is California gulch.

The third class, which are of the most recent formation, are likewise valleys of erosion; but they have been cut, not out of solid rock, but out of recent surface accumulations like the Lake beds, which have not yet become solid rock. They are relatively broad and shallow and are often dry for a great part of the year. They are like the shallow ravines and river valleys of the Great Plains and of the Nevada valleys, and like them probably mainly carved by sudden freshets. Little Evans, Georgia, and Thompson's gulches are valleys of this class. On the map of Leadville and vicinity it will be seen that the geological outlines cross these valleys without the re-entering angle which they have on the lines of the other valleys.

Little Evans Valley drains the amphitheater on the south face of Prospect Mountain, being separated from Big Evans Valley only by a moraine ridge formed by the glacier of the second epoch. It is thus proved that the amphitheaters were carved out by the earlier set of glaciers, since the glacier from the Prospect Mountain amphitheater was originally a branch of the main glacier from the Evans amphitheater, and it was the moraine of the second Evans glacier which, being placed across the mouth of the Prospect Mountain amphitheater, necessitated its seeking a new outlet for its waters. That at one time ice must have filled the amphitheaters to their brim, and been in places over 2,000 feet thick, is proved by their configuration and by the position of erratic blocks.

In the region shown on the accompanying maps, the two main glaciers of the second epoch were the Evans and the Iowa. The latter had three heads, but its lower portion, as shown by the lateral moraines which remain on the sides of the present gulch, was straight and narrow. The later Evans glacier, however, spread out as it descended, having left a prominent moraine ridge along the north bank of the present stream at the foot of Prospect Mountain, while on the south side a somewhat disconnected moraine ridge follows approximately the course of Stray Horse gulch, the moraine

material remaining being 250 feet or more thick in the Rothschild and Denver City shafts. The steep north face of Breece Hill below the present grade formed its southern wall, and below this it probably covered more or less completely all the region north of Stray Horse gulch, so that to its action is probably due the exposure of the valuable ore deposits of Fryer Hill, and also the removal of a great portion of them.



### CHAPTER III.

## ROCK FORMATIONS.

### SEDIMENTARY.

#### ARCHEAN.

The Archean rocks as developed in this district belong apparently to the very oldest of the crystalline sedimentary rocks, and on this ground may be considered as corresponding with the eastern Laurentian. As yet no systematic study of the Archean formations in the Rocky Mountain region has been made in accordance with which the different developments of Archean rocks may be classified as regards their age and correspondence with the different divisions made by eastern geologists. In the reports of the Survey of the Fortieth Parallel recognition was taken of the fact that at least two distinct developments of crystalline sedimentary rocks are found in the Rocky Mountain region.

Of these, the one, consisting essentially of granites, mica and hornblende gneisses, and amphibolites, being evidently the older, was considered to correspond with the Laurentian series; certain accessory occurrences of norite and beds of ilmenite and magnetic iron further allied it to this formation.

The second class, which was supposed to correspond to the Huronian, was found in rather limited development at Red Creek, near the Uinta Mountains, and along the Wasatch Range, and consisted of mica schists and quartzites, the former passing into paragonite schists similar to those of the St Gothard, with chloritic and hornblendic rocks, in general of a less perfectly crystalline structure than the former. The Archean rocks of the Black Hills, which consist of a great variety of slates, phyllites, quartzites,

and amphibolitic schists of singular composition, are also closely allied by their mineralogical character to this latter group.

To the former of these classes belong the mass of the Archean rocks so largely developed throughout the whole Colorado Range of the Rocky Mountains, of which excellent sections are afforded by all the streams which flow out upon the Great Plains. Here in a very general way they seem to consist principally of gneisses resting on a central core of red, friable, coarse-grained granite.

Although no opportunity has been had of making a study of the other Archean bodies of the Rocky Mountains, it would seem, from what has been seen in traveling across them, that the Archean of the Mosquito Range is distinguished from that of the Colorado Range by a greater prevalence of granite over schists, and in a very general way that the more schistoid rocks of the Mosquito Range are resting upon the almost entirely granitic mass of the Sawatch, which should therefore be considered the older.

As shown in the section afforded by the cañons of the Mosquito Range, and hence in comparative nearness to the overlying sedimentary rocks, the Archean formation consists essentially of granite, gneiss, and amphibolite. The granites are in many cases undoubtedly metamorphic and form bedded masses. In other cases there seems little doubt that they are eruptive, but probably of Archean age, since they have not been found to intrude, into or contain fragments of the Paleozoic rocks. In the majority of cases the structural evidence was not decisive either way, but the texture of the granite was decidedly that which is found characteristic of the metamorphic types.

#### GRANITE.

The granites are prevailingly very coarse-grained, especially those in which evidences of bedding are found. If the classification given by Rosenbusch<sup>1</sup> be here adopted the greater part will belong to his class of granite in the narrower sense of the word, or granite proper, consisting, namely, of quartz, two feldspars, biotite, and muscovite. These granites always contain muscovite and variable biotite, but rarely if ever hornblende; where

---

<sup>1</sup> Mik. Physiog. der mass. Gesteine. H. Rosenbusch. Stuttgart, 1877, p. 18.

biotite is absent it is due to a later alteration of the rock. In color they are gray or very frequently of a reddish tinge. The red color is sometimes very marked, and certain varieties are fully as fine in color as the famous Aberdeen granites. As an exceptional color is also found a reddish-yellow, due apparently to hydrated oxides of iron.

Those which it has been thought might be of eruptive origin are generally fine-grained, of gray color, and contain an abundance of biotite, whereas those which are distinctly metamorphic are generally coarse-grained, often red in color, and have a porphyritic structure owing to the prevalence of large twin crystals of orthoclase. Surfaces of the latter type often show such parallelism and rectangularity in the disposition of the long narrow prisms of orthoclase as to present a superficial resemblance to the so-called graphic granites. These coarse-grained metamorphic granites, especially when found in the immediate vicinity of the overlying sedimentaries, have sometimes a foliated structure approaching that of gneiss, but the direct passage of granite beds into gneisses was not observed. As typical granites of the former or eruptive class, may be mentioned that found in the Platte Valley, north of Mount Lincoln; in Democrat Mountain, at the head of Buckskin gulch; and along the western slope of the main crest, opposite the head of Mosquito gulch.

Of the second class typical forms are found at Bartlett Mountain and along the Arkansas Valley, which are distinguished from the former by the development of orthoclase in tabular twins, following the Carlsbad law, porphyritically distributed throughout the rock. That found at Leadville, generally in large erratic boulders, and which has been considerably used as foundation stone, is a remarkably beautiful rock, the orthoclase having a delicate flesh-red tinge, while the groundmass, if such it may be termed, is a bright, clear-gray mass, rich in dark mica.

The finer-grained granites of a deep blood-red color were observed on the ridge between Empire and Weston gulches, and also in the valley of Eagle River, opposite Tennessee pass. Yellow granite was found also in the last-mentioned locality and on the summit of Weston's pass.

In addition to the above are masses of secondary origin, which occur in the form of huge white veins of extremely irregular outline, to which, in

accordance with the custom now prevalent among German geologists, the term pegmatite has been given. These pegmatites consist of large intergrown crystals of white orthoclase, microcline, and quartz, with irregular masses of muscovite, and are evidently of later formation, probably the filling in, by secretion from the surrounding rocks, of fissures and irregular openings formed in the mass by contraction or dynamic movement.

**Microscopic constitution.**—Besides the normal components, which are easily detected macroscopically—viz, quartz, orthoclase and plagioclase feldspars, potash and magnesia micas—the only constituent of importance revealed by the microscope is microcline, which occurs in all rocks examined except those of the type from Democrat Mountain. This is often quite abundant, and seems to have been the last feldspar formed, which may be the reason for its superior freshness and freedom from particles of limonite and hematite, the abundance of which in the other feldspars causes their reddish color. The quartz grains are often full of fluid inclusions and hair-like needles. A few of the fluid inclusions were observed to be double, the inner substance being probably carbonic acid.

#### GNEISS.

The gneisses, which are next in importance to the granites, are more generally micaceous than those of the Archean along the Fortieth Parallel, among which the distinctly hornblende gneisses were the more prevalent. They are much contorted and seldom exhibit very distinct bedding over large areas. In structure they present a great variety of forms, prevailingly the typical gneiss structure with fine, even grain and constant composition in the different layers, aside from the flat lenses of quartz or feldspar which are inserted between them. At other times a banded appearance is produced by the alternation of layers in which biotite or hornblende prevail over quartz and feldspar. A porphyroidal structure is very marked in a variety from the South Platte amphitheater, caused by the development of large white orthoclase crystals, usually Carlsbad twins, reaching two to three inches in length, in a matrix of ordinary gneiss. The tendency to a granitic structure is locally noticeable, especially in the Twelve-Mile amphitheater. In composition the gneisses are prevailingly micaceous, hornblende being

seldom present in large quantity, except in those rocks which are classed distinctly as amphibolites. Biotite is in some cases the sole mica, but frequently muscovite is associated with it in subordinate quantity. A careful search with the lens is often necessary to determine the presence of plagioclase. The feldspars are generally white, but in the Mosquito, Horseshoe, and Twelve-Mile amphitheatres a pink or reddish color predominates. In these cases the pegmatite which forms veins in the schists is also pinkish.

**Microscopic constitution.**—A microscopical examination reveals the presence of microcline in small quantities, while ordinary plagioclase is very abundant, as is also muscovite frequently intergrown with the feldspars. Apatite and ilmenite are the most common accessory minerals, the latter giving rise to titanite in the form originally called titanomorphite by von Lasaulx.<sup>1</sup> Isolated rounded grains, which are nearly or quite colorless and but very faintly dichroic, are doubtless referable in part to titanite and in part to pyroxene of a variety near sahlite. The dark portion of a banded gneiss from the Arkansas amphitheater consists principally of quartz, three feldspars, biotite, and hornblende. The last two minerals are often intergrown in a peculiar manner, the biotite leaves being parallel to the orthopinacoid of the hornblende. Ilmenite is abundant and passes by alteration into "leucoxene," which appears dull white by reflected light. This again passes into a granular mineral resembling titanite, although not very strongly dichroic. Blood-red films of hematite are discovered in the leaves of biotite.

In the porphyritic gneiss of the Platte amphitheater microcline is an important element. One large grain of it contains inclusions of quartz and mica in considerable quantity. Muscovite, which is not prominent macroscopically, is abundant in delicate plates intergrown with the feldspars, either parallel to the common crystal faces or without regularity. This muscovite seems to be original and not a decomposition product. An intergrowth of biotite and muscovite, whereby a crystal of the former is surrounded by a zone of the latter having the same orientation, was also observed. Quartz grains contain biotite crystals, needles of rutile (?), and double fluid inclusions with carbonic acid. The pink feldspar in gneiss

---

<sup>1</sup>A. von Lasaulx, *Neues Jahrbuch für Min., etc.*, 1879, p. 568.

from the Twelve-Mile amphitheater presents a confused intergrowth of different feldspars, a part being undoubtedly microcline.

#### AMPHIBOLITE.

The amphibolites are the next in importance to the gneisses among the crystalline schists, and occur interstratified with them in layers of varying thickness, and sometimes in large lenticular bodies. Under the name amphibolite are here understood rocks of comparatively coarse grain, with less marked schistose structure than is common in hornblende schists proper, and also differing from these in that other minerals, particularly feldspar and quartz, occupy prominent positions beside the hornblende. They are of frequent occurrence throughout the Archean formation of this district and have a comparatively uniform structure, although sometimes showing a mottled appearance, from the concentration of hornblende in patches. Biotite and magnetite are often quite prominent in them. Pyrite is frequently visible macroscopically.

**Microscopic constitution.**—The microscope shows that orthoclase and plagioclase are present in about equal quantities, but that microcline, which was found in many gneisses, does not appear in the associated amphibolites. Hornblende occurs in stout, irregular individuals, and often contains inclusions of a clear, colorless mineral in minute rounded particles, which are probably quartz, although too small for certain determination. Amphibolite from Weston's pass contains hornblende which is so full of black ore-grains as to be opaque in certain cases. A fine striation parallel to the plane  $P_{\infty}$ <sup>1</sup> was observed on the same hornblende. Apatite in its usual form is common to all. Titanite, as formed through the alteration of a titanium mineral, probably nigrine or rutile containing titanite iron,<sup>2</sup> is present in two cases in most typical form. The rutile has a dull-reddish hue by reflected light and is surrounded by titanite in clear oval grains. Two occurrences, viz, from Buckskin gulch and from Twelve-Mile amphitheater, show the mode of formation of titanite with exceptional clearness.

<sup>1</sup>C. W. Cross, Studien über bretonische Gesteine; Min. und petro. Mitth. von G. Tschermak. Neue Folge, III., p. 386.

<sup>2</sup>Rammelsberg, Mineralchemie, Iler Theil, 2te Auflage, p. 169.

These two rocks, gneiss and amphibolite, constitute the main mass of the Archean schists, mica schists, phyllite, and other thinly bedded rocks not occurring in any well defined bodies. Peculiar schistose forms do appear in the gneissic series, but are subordinate in every respect, with only local extension, and of abnormal constitution. In the contorted state of the strata, the tracing out of the relations of these bodies to the gneiss, while extremely interesting, would have taken much more time than could have been devoted to this subject. A few examples will show the interesting nature of these masses.

On the north face of Mount Lincoln occurs a contorted schist of dark color, in which the naked eye can determine biotite and small flakes of glistening muscovite. The microscope shows that the two micas form nearly the whole rock, the compact appearance being due to extremely minute flakes of biotite, often so small as to require a power of 800 diameters to distinguish them clearly. Between these two elements, in varying quantity, is a mass appearing between crossed nicols like the decomposition product of orthoclase in many of the older rocks, where muscovite in tiny flakes has been the chief mineral formed; this substance is here very uniform in composition, giving the brilliant polarization colors of such an aggregate, and, as no feldspathic substances can be detected, it remains uncertain whether this muscovite comes from orthoclase or is original, corresponding to the minute leaflets of biotite. No hornblende is visible. Tourmaline in bundles and brushes is the next most abundant element, being brown in ordinary light, with a tinge of red or blue; a few small grains of quartz, and specks of ilmenite altering into "leucoxene," are the only remaining minerals.

#### RELATIVE AGE.

The Archean rocks just described are all without question older than any of the Paleozoic series, which rest unconformably upon them; but of the relative age of these different components of the ancient crystalline series it is in the nature of things difficult to form any very decided judgment. Even had time permitted a careful and detailed study of any of the remarkable exposures in the great glacial amphitheatres which have been carved out of them, it is doubtful whether their original relations

could have been clearly made out, since they have been subjected not only to the dynamic movements which brought about the present elevation of the range, but, no doubt, to many previous movements of which no record now remains. As a consequence they are found to be contorted, fissured and reconsolidated, and fissured again, and this action seems to have been more intense the further one goes from the original surface, or rather from that which was the surface at the commencement of Paleozoic deposition. In general, it may be said that the pegmatites are the latest formations in the Archean proper, leaving out of consideration, of course, the later eruptives (porphyries, porphyrites, and diorites) and that gneiss must certainly have formed part of the original undisturbed mass, while of the granites proper some were earlier and some later, but all previous to the pegmatite.

On the accompanying plate (Plate IV) are reproduced a few hasty field-sketches of occurrences in which the different varieties of rock are found so intimately interlaced as to afford some idea of their relations and of the difficulty of tracing a sequence in their formation.

In Fig. 1, it is seen (1) that across the original gneiss a small feldspar vein has been formed, probably the filling of a small fissure or crack resulting from dynamic movement; (2) that the fine-grained and probably eruptive granite has been intruded in tongue-like masses into the gneiss after the formation of this first vein; (3) that after consolidation the mass has again been shattered, a great fissure formed and filled by a coarser-grained granite, which surrounded fragments of gneiss and earlier granite alike; this fissuring was accompanied by a certain amount of faulting; (4) a second opening on the wall of this fissure has been made and filled with pegmatite.

In Fig. 3, again, fragments of gneiss are found in a mass of fine-grained granite, in such position as to show that the latter must undoubtedly have been a more or less fluid mass, which traversed the gneiss and caught up included fragments of it in its passage.

In Fig. 2, on the other hand, this granite is seen to have been subjected to at least two movements; as a result of the first, narrow feldspar veins have been formed across its mass, and again, by the second, these, together with the inclosing granite, have been successively opened along the same fissure to admit the formation in fissures thus made of pegmatite



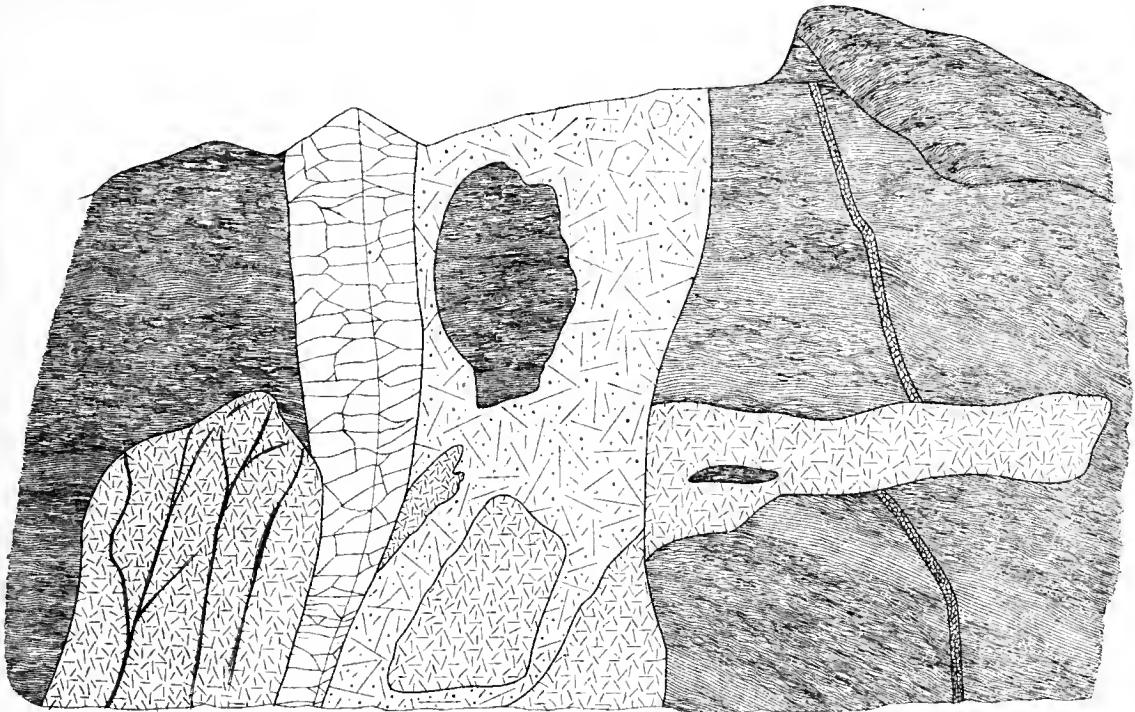

FIG. I. FACE OF CLIFF, ARKANSAS AMPHITHEATRE.

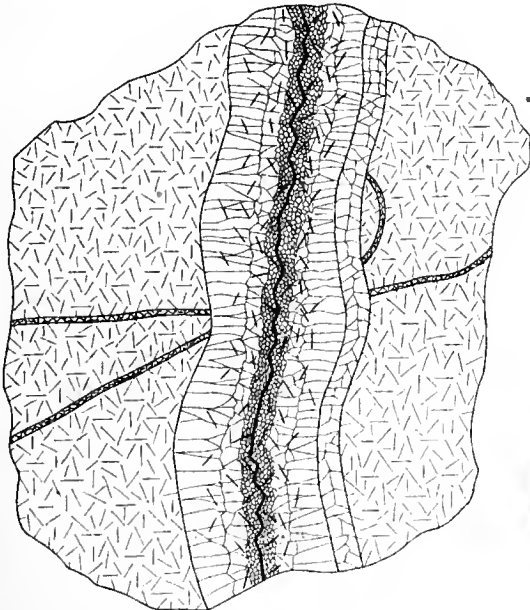
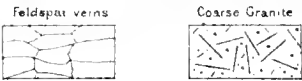

FIG. II. BOULDER-BUCKSKIN AMPHITHEATRE.

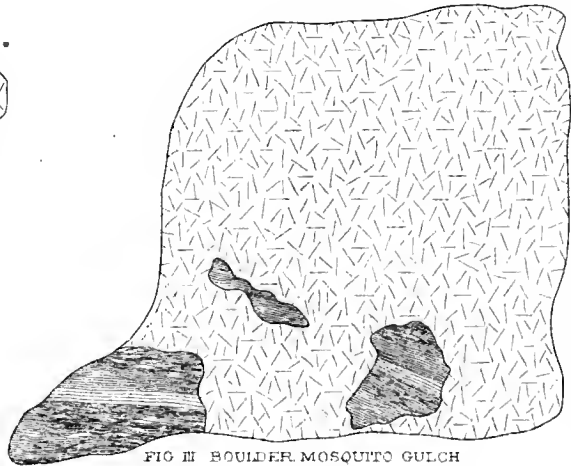
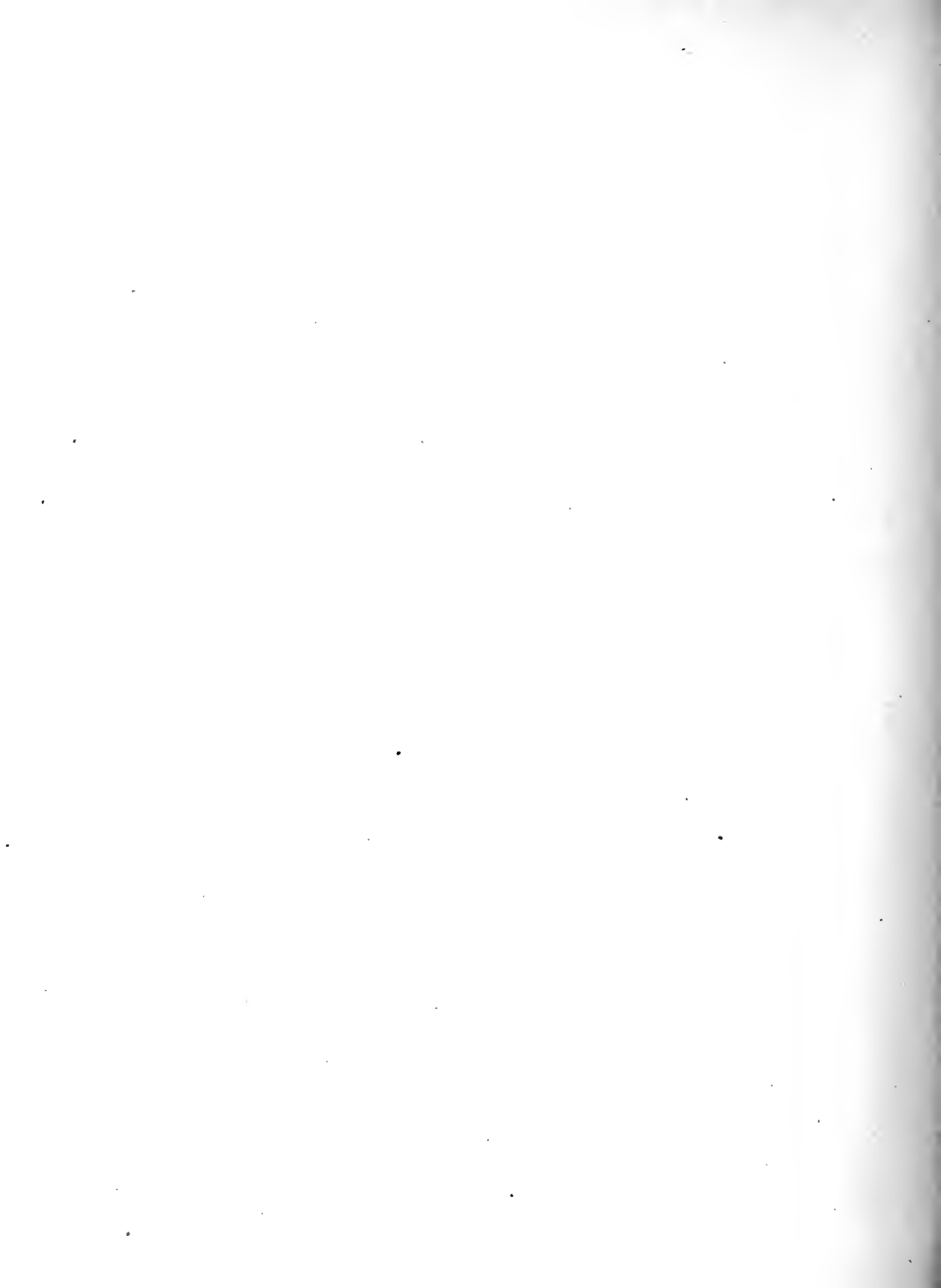

FIG. III. BOULDER, MOSQUITO GULCH





veins. The curving form of the smaller feldspar veins would also suggest an intermediate compression, during which the granite became sufficiently viscous to admit of some movement within its mass without producing fracture, for it is fair to assume that these veins are the filling of a crack along a fracture-plane, and therefore originally more or less straight.

## PALEOZOIC.

The sedimentary deposits later than the Archean which are found in this region belong, with the exception of certain very recent beds, to the Paleozoic system. In the multitudinous sections afforded by the exposures along the cliffs of amphitheatres and the walls of cañons remarkable uniformity in the physical characteristics of these beds is observed. Practically the same bed, a fine-grained conglomerate, is, with a single exception, found in contact with the underlying Archean wherever the contact is exposed and no non-conformity of stratification or other evidence of a physical break exists.

In determining the geological age of the different strata included in these series two difficulties are met at the outset: first, the rarity of fossil remains in the beds, due probably to their relatively metamorphosed and altered condition; second, the absence of any systematic description of the Paleozoic horizons of the Rocky Mountain region, to be found in the published works of other geologists. The voluminous reports of the Hayden Survey contain, it is true, many local sections of sedimentary rocks and frequent surmises as to their age, but as yet, unfortunately, a systematic summary which shall correlate the material thus gathered by many different individuals into a harmonious whole, and sift out that which is to be considered fact from that which is only surmise, is wanting.

It has long been the opinion of the writer, and one which is confirmed by later geological investigations, that it is impracticable to determine by similarity of molluscan fauna alone the correspondence of beds and formations in regions so widely separated as are the Rocky Mountains, where as yet meager data have been gathered, and the Eastern States, where paleontological horizons are firmly established. In Paleozoic times these regions were practically two distinct continents, and the conditions of life must have varied considerably. Until, therefore, the sequence of development and of

extinction of molluscan life in the former region shall have been thoroughly investigated by detailed paleontological determinations, founded upon accurate and systematic stratigraphical studies, the assignment of geological horizons must be somewhat provisory and considerable importance must be given to the conditions of deposition which prevailed during the Paleozoic era.

Geologists have observed, both in the East and in the Rocky Mountain region, a certain general sequence in the character of the sediments deposited in the oceans of former geological periods. This sequence has received from Dr. J. S. Newberry the name of "circles of deposition," and in a memoir on this subject he has endeavored to prove that in the Appalachian system each great geological period consisted of two extremes, during which the oceanic conditions were such that calcareous sediments were deposited, separated by an intermediate period, during which silicious sediment prevailed. The former, in a general way, are supposed to have occurred in deep seas and under conditions of comparative quiet, while coarser silicious sediments were formed either in shallow waters or during periods when this coarse material would be carried further out towards the middle of the ocean.

As regards the assumption that limestone may be considered an evidence of deep-sea deposition, it seems that this evidence can be considered only as relative. The limestone depositions in the region under consideration, for instance, were formed in an inclosed arm of the sea, not more than 40 miles in width, and which can therefore have had no very great depth. Mr. John Murray, geologist of the Challenger expedition, informed the writer that the result of their investigations had been to prove that no limestone could be formed in the greatest depths of the ocean, and that the area of sedimentation is confined to a comparatively shallow and limited belt along the shores of the present continents. While it is probable, therefore, that none of the deposits of the Rocky Mountain region were formed in seas at all comparable in depth to what are classed as deep seas by ocean explorers, the alternations of prevailing silicious and calcareous material in the sediments doubtless represent significant changes in the oceanic or climatic conditions which prevailed to a greater or less extent over the whole region. It is, therefore, instructive to observe the parallelism of these conditions in

the Paleozoic section of the Wasatch Range, as determined by the geologists of the Fortieth Parallel and which was considered by them as the key-section of the Rocky Mountain region, and that of the Mosquito Range.

In the former the Paleozoic series has a thickness of about thirty thousand feet and is characterized by two great silicious series, the Cambrian at its base and the Weber Quartzites in the middle of the Carboniferous. The former had a thickness of about twelve thousand feet and was followed by 1,000 feet of Silurian limestone, which was again succeeded by quartzites and sandstones of equal thickness; this was followed by a great limestone formation of a maximum thickness of 7,000 feet, in the lower portion of which were found Devonian and Waverly forms, the main body of the limestone being, however, characterized by fossils of Carboniferous age. The coarse sandstones of the Weber series, which were deposited over this limestone, had a thickness in the Wasatch of about six thousand feet, and were succeeded at the close of the Carboniferous by alternating silicious, calcareous, and argillaceous beds. Followed eastward along the forty-first parallel, the whole Paleozoic series thins out rapidly, and in the Laramie hills, on the meridian of the Colorado or Front Range, seems to be represented by a thickness of only 1,500 feet of rocks, though the exposures are not sufficiently good to render it certain that the entire series is here exposed.

In the Mosquito Range the Paleozoic series has a maximum thickness of less than five thousand feet. The Cambrian is represented by quartzites, passing gradually upwards into calcareous shales, with limestones of probable Silurian age above, the aggregate thickness of the two being about four hundred feet. Above these limestones, and separated from them by a thin bed of quartzite, is the Blue, or ore-bearing, limestone, about two hundred feet in thickness, in which only Carboniferous forms have yet been found. This is succeeded by a relatively large development of silicious material, consisting mainly of coarse sandstones and conglomerates, corresponding lithologically to the Weber series, which passes upward into beds containing a greater or less development of limestone, with sandstones and shales, and which has been provisionally designated the Upper Coal Measures.

Of the existence of the Devonian, which is recognized in the Wasatch section, and which was also found by Mr. Walcott in the Kanab, in the Colorado Plateau country, no direct evidence was found in the Mosquito region. On the one hand there is a gap of two hundred feet or more of beds from which no fossils were obtained, between the horizons in which Carboniferous and Silurian forms, respectively, were recognized. On the other hand, at one point evidence of non-conformity by erosion was observed between the Blue Limestone or base of the Carboniferous and the Parting Quartzite or top of the Silurian. Had this evidence of erosion been generally observed throughout the region, it would have afforded sufficiently conclusive proof that, owing to a perhaps local elevation, no sediments had been deposited here during the Devonian period. As it is, the question must remain for the present undecided, though the probabilities are in favor of the latter solution.

As to the existence or non-existence of the Devonian on the eastern slopes of the Rocky Mountains in general, the evidence is equally unsatisfactory. Waverly forms, which are associated with it in the Wasatch, have been found in the limestones of Lake Valley, in New Mexico. It is indicated on the Hayden maps as occurring on the south slopes of the San Juan Mountains, and Dr. Endlich's description of the formations in the neighborhood of the Animas River would seem to indicate the existence of a considerable thickness of beds below the Carboniferous which are not like the Silurian or Cambrian formations of Colorado in general. Unfortunately the fossil (*Rhynconella Endlichi*<sup>1</sup>) upon which he mainly founded his determination of the existence of Devonian beds in the region, has, upon recent, more careful study by Prof. R. P. Whitfield, been decided to be a Carboniferous and not a Devonian type.

---

<sup>1</sup> Geological and Geographical Survey of the Territories, 1874, p. 213.

In the following tables are given the average Paleozoic section in the Mosquito Range, in the Kanab from Mr. C. D. Walcott,<sup>1</sup> and in the Wasatch from the Fortieth Parallel Reports:

Mosquito section; 4,600 feet; possible unconformity by erosion.

Carboniferous .. 3,700 feet to 4,200 feet.	Upper Coal Measures.....	1,000 to 1,500	Blue and drab limestones and dolomites, with red sandstones and shales. Mud shales at top.
	Weber Grits.....	} 2,500	Coarse white sandstones, passing into conglomerates, and silicious and highly micaceous shales, with occasional beds of black argillite and blue dolomitic limestone.
	Weber Shales.....		
	Blue Limestone.....	200	Calcareous and carbonaceous shales, with quartzite.
Silurian ..... 200 feet.	Parting Quartzite.....	40	Compact, heavy-bedded, dark-blue dolomitic limestone. Silicious concretions at top, in form of black chert.
	White Limestone.....	160	White quartzite.
Cambrian..... 200 feet.	Lower Quartzite.....	150	Light-gray silicious dolomitic limestone, with white chert concretions.
		to 200	

Kanab (Colorado River) section; 5,000 feet; unconformities by erosion.

Permian ..... 855 feet.	Upper Permian.....	710	Gypsiferous and arenaceous shales and marls, with impure shaly limestone at base.
	Lower Permian.....	145	Same as above, with more massive limestone.
Carboniferous .. 3,260 feet.	Upper Aubrey.....	835	Massy cherty limestone, with gypsiferous arenaceous bed, passing down into calciferous sandrock.
	Lower Aubrey.....	1,455	Friable, reddish sandstone, passing down into more massive and compact sandstone below. A few filets of impure limestone intercalated.
	Red Wall Limestone..	970	Arenaceous and cherty limestone 235 feet, with massive limestone beneath. Cherty layers coincident with bedding near base.
Devonian ..... 100 feet.	Devonian.....	100	Sandstone and impure limestone.
Cambrian..... 785 feet.	Tonto Group.....	235	Massive mottled limestone, with 50 feet sandstone at base.
		550+	

NOTE.—Planes of unconformity by erosion denoted by double dividing lines.

<sup>1</sup> American Journal of Science, September, 1880, p. 222.

Wasatch section; 30,000 feet; conformable.

Permian .....	Permian .....	650	Clays, marls, and limestones, shallow.
650 feet.	Upper Coal Measure limestone.	2,350	Blue and drab limestones, passing into sandstones.
Carboniferous ..	Weber Quartzite .....	0,000	Compact sandstone and quartzite, often reddish; intercalations of limestone, argillites, and conglomerate.
	Wasatch Limestone	7,000	Heavy-bedded blue and gray limestone, with silicious admixture, especially near the top
Waverly.....			
Devonian .....	Ogden Quartzite.....	1,000	Pure quartzite, with conglomerate.
2,000 feet.	Uto Limestones.....	1,000	Compact or shaly silicious limestone.
Silurian .....	Cambrian .....	12,000	Silicious schists and quartzite.
1,000 feet.			
Cambrian.....			
12,000 feet.			

## CAMBRIAN.

**Lower Quartzite.**—The beds assigned provisorily to this horizon, which are indicated on the map in a dark-purple color (*b*), are prevailingly of quartzite. To them, therefore, the local name of Lower Quartzite has been given. Their average thickness is about one hundred and fifty feet to two hundred feet, of which the lower one hundred feet are composed of finely and rather thinly bedded white saccharoidal quartzites, while the upper fifty feet are shaly in character and more or less argillaceous and calcareous, passing by almost imperceptible transition into the silicious limestone of the Silurian formation above.

At the very base of the series, at the contact with the underlying Archean, wherever this could be observed, is found a persistent bed of fine-grained conglomerate, from a few inches to a foot in thickness, made up of rounded and finely polished grains of bluish translucent quartz, generally not larger than a pea in size. Above this is a white quartzite of remarkably uniform and persistent character, always very readily distinguishable as a white band in the numerous sections offered by the cañon walls of the range. Its thickness, when measured on the west side of the range, or near the Sawatch island, is, as mentioned above, 100 feet of purely silicious beds. On the east side of the range the thickness seems somewhat to diminish, and in places was found to be only 40 feet.

In Buckskin cañon a thin bed of silicious limestone was found included in the quartzite. The rock of this bed is remarkable as containing rela-



tively a smaller proportion of carbonate of magnesia than any other limestone of the range, the specimen analyzed having—

Carbonate of lime .....	25.43
Carbonate of magnesia .....	4.03

The whole series may often be observed to be divided into two equal parts, the lower half consisting of very pure white quartzite, while the upper half weathers brown and is more or less stained by iron oxide and other impurities.

While the lower series is very persistent in its character, the upper portion or transition series, which has a maximum thickness of 100 feet, is extremely variable, and, though readily recognized in all cliff sections, often seems to be wanting in those afforded by the numerous drill-holes in the neighborhood of Leadville.

Owing to their similar lithological character and to the general absence of fossil evidence, it is difficult to establish a hard and fast line between this and the succeeding formation above. In practice the line has been drawn at the top of the shaly beds and the commencement of the beds of more massive limestone. The transition beds consist essentially of alternating bands of calcareous quartzite and shales. The name Sandy Limestones is often applied to them for the reason that on weathered surfaces of the cliff faces they appear like sandstones, the carbonate of lime having been entirely washed out and only the fine quartz grains left on the thin surface crust.

One especially persistent bed of sandy limestone, generally about a foot in thickness, is often very useful in determining the horizon, on account of the striking appearance of its weathered surface. It is a silicious dolomite, generally of whitish color on fresh fracture, containing spots of dark brick-red resembling casts of fossils; for which reason the name Red-cast beds has been given to it. Fig. 1, Plate V, the reproduction of a photograph of a weathered specimen, shows its characteristic appearance.

Certain of the shaly beds are found to contain a considerable development of pyroxene and amphibole, which often give a decided green color to the rock. The microscope shows besides an admixture of fine ore particles, and in some cases there is so large a concentration of pyrites as to constitute veritable ore bodies.

One of the most interesting features of this series is the local development of serpentine, resulting evidently from the metamorphism of pyroxene and amphibole. It has been found in small quantities at various points, but is developed on a very considerable scale in the Red Amphitheater in Buckskin gulch, where it forms a remarkably beautiful verd-antique and a peculiar massive yellow rock, resembling bees-wax not only in color but also in texture.

**Fossils.**—The only fossil remains found in this series occur in a bed of greenish chloritic shales on the east flank of Quandary Peak, about a mile above the Monte Cristo mine. They belong to the genus *Dicellosephalus*, and resemble closely *Dicellosephalus Minnesotensis* of the Potsdam formation.

Owing to the thick covering of forest immediately east of the point where these fossils were found, it was impossible to fix with absolute certainty the exact horizon of the bed in which they occur. They are immediately above a heavy white quartzite, and beneath a bed of white marbled limestone, which is in turn overlaid by the quartzite which carries the Monte Cristo ore deposit. From analogy with other sections, however, it seems safe to assume that it occurs above the main body of quartzite and near the base of the transition series.

#### SILURIAN.

The beds assigned to this horizon consist of light-colored, more or less silicious, dolomitic limestone, capped by beds of quartzite of varying thickness which mark the dividing line between it and the overlying formation. On the general map of the Mosquito Range the entire series is included in one color-block (*e*). On the more detailed maps two divisions are made, to which the local terms White Limestone (*c*) and Parting Quartzite (*d*) have been given.

**White Limestone.**—The beds to which this local name has been given, from their prevailing light color as distinguished from the dark blue-gray or even black limestone above, consist in the main of light drab dolomites, and contain, besides the normal proportions of carbonates of lime and magnesia, from 10 per cent. upwards of silica. They are generally rather thinly bedded, of compact rather than crystalline structure, and frequently have a conchoidal fracture, approaching a lithographic stone in texture.



Red Cast Beds.(Cambrian)



Contorted Limestone.(Upper Coal Measure)



But rarely do the beds have the whiteness of marble, and in such cases it is evidently due to local metamorphism.

The characteristic feature of this limestone is the occurrence at certain horizons of concretions of white, semi-transparent chalcedony or chert. This occurrence is often useful in the mines of Leadville for distinguishing beds of this horizon from locally bleached limestones of the Carboniferous. Chert also occurs in the latter beds, but is always of dark, nearly black color, and the microscope shows in them a very finely granular structure, while those of the Silurian have frequently a radiate structure in the nature of spherulites. In neither was it possible to detect any trace of the minute organisms found in similar concretions in many other limestones.

The average thickness of the White Limestone is from 120 to 160 feet. A small percentage of chlorine can be detected in these, as in all the other limestones from this region which were chemically examined.

**Parting Quartzite.**—Above the White Limestone occurs a bed of remarkable persistence, but of rather variable thickness, to which the above local name has been given, and which, on somewhat negative evidence, is regarded as constituting the upper limit of the Silurian formation in this region. In the cliff sections it has an average thickness of 40 feet, in one case attaining a maximum of 70 feet. It does not differ lithologically from the numerous white quartzites found at other horizons, but it is of geological importance as determining the dividing line between the Silurian and Carboniferous groups. In the cliff sections a brecciated structure is often observed in the limestone immediately overlying it, and in one case, on the east fork of the Arkansas, evidence of non-conformity by erosion was observed, which renders it possible that the Upper Silurian and Devonian formations may be entirely wanting in this region.

**Fossils.**—Paleontological evidence as to the age of the above formation is extremely meager. No form was actually found in place. Casts of a *Rhynconella*, between *R. neglecta* and *R. Indianensis* of the Niagara epoch, were found in a prospect shaft in California gulch, not far from the White Limestone quarry, in such a position that they must have been derived from the beds of this horizon at least fifty feet above the base of the formation. Besides this, other specimens were brought in, obtained from talus slopes at

the foot of the cliffs in Dyer Amphitheater and on West Sheridan, whose matrix of light drab-colored limestone renders it reasonably certain that they were derived from some of the beds of this horizon. The following forms are recognized: *Leptena melita* and an *Orthisina* like *O. Pepinensis*, which correspond to forms found in the Calciferous; and the syphon of an *Endoceras*, which belongs to the Trenton epoch.

Corresponding beds in Colorado Range.—In order to obtain, for purposes of comparison, a section of the Paleozoic beds lying directly on the Archean along the Colorado Range uplift, a visit was made by Mr. Whitman Cross to the exposures in Williams cañon, near Manitou, and in Manitou Park. Although only fifty to seventy-five miles distant from the Mosquito Range exposures, the beds were found to vary so much in lithological composition that it was impossible to obtain an exact correspondence of horizons. The purely silicious beds at the base are much thinner than in the Mosquito Range, the greatest thickness found being 50 feet. They are succeeded by calcareous sandstones and shales of variegated colors, red prevailing, which pass up into white or drab limestones, sometimes containing chert secretions and alternating with shaly beds, with an aggregate thickness of about two hundred feet. These beds may be considered as the equivalents of the Lower Quartzite and White Limestone of the Mosquito Range. Owing to extensive denudation it was impossible in the time allotted to trace a continuous series into well-defined Carboniferous horizons.

From the east bank of Trout Creek (Bergens Creek on the Hayden map), in Manitou Park, two miles below the hotel, Mr. Cross obtained fossils which have been identified by Mr. C. D. Walcott as follows:

From reddish-brown sandstone 45 feet above the Archean.

*Lingulepis*, sp. ? An elongate form allied to *L. pinnaformis* of the Potsdam sandstone of Wisconsin.

From red calcareous sandstones, alternating with white limestone, one hundred and five to one hundred and twenty-two feet above the Archean.

*Glytocistites* (?). Single plates.

*Lingula*, sp. n. det.; probably new.

*Orthis desmopleura*, Meek.

*Metoptoma*, new sp.

*Cyrtolites*.

*Orthoceras*, sp. n. det.; probably new.

*Bathyurus simillimus*, Walcott (?).

This fauna is essentially the same as that of the upper third of the Pogonip Limestone of Nevada.

The paleontological information, therefore, is so far a confirmation of the suggestion offered above from lithological composition, viz, that the Cambrian beds are here not more than fifty to a hundred feet thick (a notable decrease from the estimated 12,000 feet in the Wasatch, or from the more definitely-determined thickness given by Mr. A. Hague for Eureka, Nevada, of 7,700 feet), and that the limestone beds above are Silurian.

## CARBONIFEROUS.

The beds of this period are, as in other parts of the Rocky Mountain region, more fully developed and more abundant in fossil remains than those of the other Paleozoic horizons. The Carboniferous period here, as in the Wasatch, consisted of two limestone-making epochs, separated by a long period of silicious deposits, with the difference that in the shallow seas, in which the Carboniferous of the Mosquito Range was formed, detrital and silicious deposits predominated over calcareous deposits. The series, therefore, lends itself to a triple subdivision into lower, middle, and upper Carboniferous, which are here assigned to it mainly on lithological grounds, since our knowledge of the Carboniferous fauna of the Rocky Mountain region is not yet sufficiently complete to enable us to establish satisfactory paleontological subdivisions, and many forms considered characteristic of the Coal Measures of the East range from the bottom to the very top of the series.

**Blue or ore-bearing Limestone.**—The beds included under this local name, which are designated on the map by a deep-blue color (*e*), and which, from the fact that they form the ore-bearing rocks par excellence of the region, it is most important to be able to trace accurately, are fortunately marked by persistent and characteristic features. They have an average thickness of about 200 feet. In color they are of a deep grayish-blue, often nearly black in the upper portion of the series, while some of the lower beds are lighter in color, approaching a drab, and, where locally bleached, difficult to distinguish lithologically from the underlying White Limestone. The upper bed is well marked by characteristic concretions of black chert, frequently hollow in the center and often containing within their mass distinct casts of fossils. Owing to their superior resistance to atmospheric agencies, they are often weathered out and left in nodular masses of irreg-

ular shape upon the surface. The forms which they assume are sometimes so fantastic as to suggest to the untechnical that they are the fossil remains of some gigantic animal. Their forms, however, are always rounded, and are more commonly that of a sphere or some solid of revolution. In many cases, that they are the filling in of a pre-existing cavity in the limestone is evident from the fact that they are hollow in the center and contain crystals of pyrite or other minerals lining the cavity.

The series is generally heavily bedded, and the rock is almost always granular, and in the upper part often coarsely crystalline. A characteristic feature, especially of the upper portion of the formation, is a ribbed structure produced by irregular lines and spots of white crystalline material. In some cases the ribbing is so fine and regular as to produce an appearance resembling that of the *Eozoön*.

This typical appearance of the rock is shown in Plate VI, on which are represented two specimens from the Blue Limestone of Iron hill, taken a short distance below the ore body on the Silver Wave claim, which were also subjected to microscopical examination. The upper figure in the plate is a photograph of a specimen polished on one side to show the fine ribbing which is peculiar to this limestone. The lower figure shows a specimen roughly shaped by the hammer, in which the ribbings or veins of white crystalline spar are coarser and more irregular. These white crystalline veins may be supposed to be produced by the dissolving out of a portion of the limestone and its redeposition in a crystallized form. As bearing on the question of the relative solubility in natural waters of carbonates of lime and magnesia, a partial analysis of the white spar was made, and it was found to have the same proportions of the two salts as the dark granular rock.

**Composition.**—The composition of the rock, which is remarkably uniform, is that of a normal dolomite, the average of six lime and magnesia determinations from different localities giving—

Carbonate of lime.....	54.695
Carbonate of magnesia .....	43.197

the proportion in normal dolomite being—

Carbonate of lime .....	54.30
Carbonate of magnesia .....	45.70



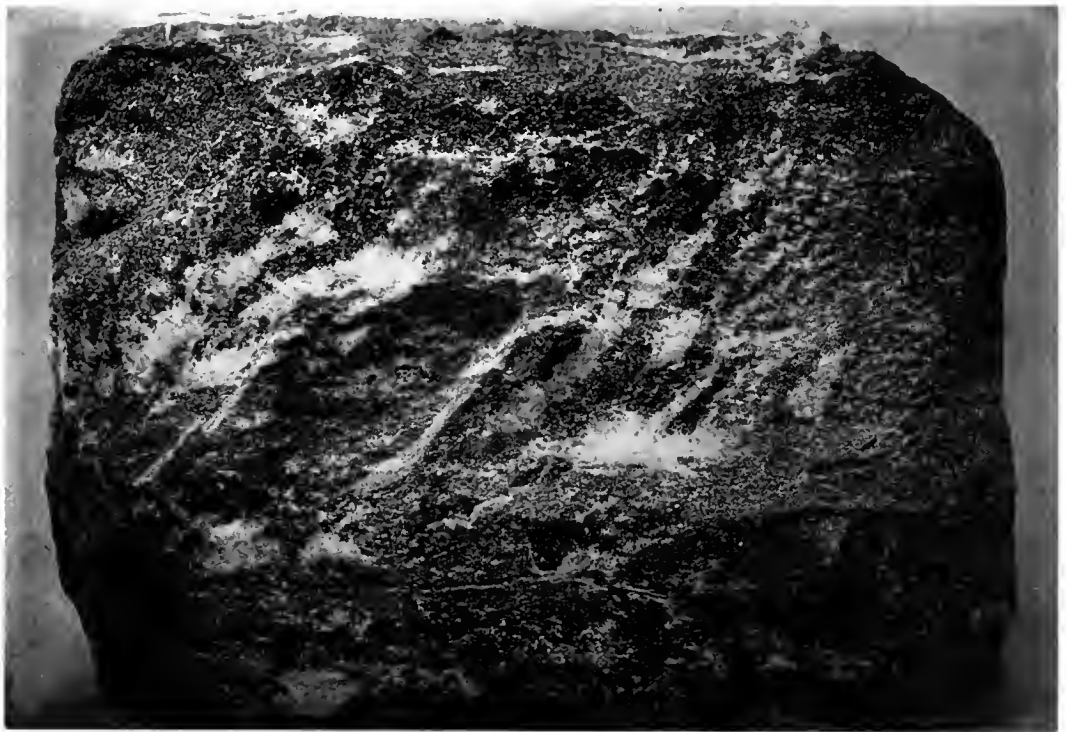

Blue Limestones



The following complete analyses of typical specimens, taken from localities at considerable distances from each other in the vicinity of Leadville, are further proofs of the uniformity of composition. I, II, and III are from the upper of the Blue Limestone, IV from near its base, and V from the upper part of the White Limestone.

	I.	II.	III.	IV.	V.
Locality.....	Silver Wave mine.	Dugan quarry.	Glass-Pendery mine.	Montgomery quarry.	Carbonate hill quarry.
Chemist.....	(Hillebrand.)	(Guyard.)	(Guyard.)	(Guyard.)	(Hillebrand.)
Lime .....	30.79	30.43	29.97	27.26	26.60
Magnesia .....	21.14	20.78	21.52	20.05	17.41
Carbonic acid .....	46.84	46.93	47.39	43.79	40.01
Protoxide of iron.....	0.24	0.38	0.13	0.57	0.83
Peroxide of iron.....	0.21	0.11	0.22	0.10	1.51
Protoxide of manganese.....	Trace	0.05	0.20	0.06	.....
Alumina .....	0.27	0.17	0.04	0.11	1.66
Silica .....	0.21	0.70	0.27	7.76	11.84
Chlorine .....	0.10	0.143	0.041	0.062	0.05
Potash .....	0.03	0.046	0.013	0.017	0.017
Soda .....	0.062	0.094	0.016	0.037	0.029
Sulphuric acid .....	Trace	.....	.....	Trace	.....
Phosphoric acid.....	Trace	0.12	0.03	0.07	Trace
Sulphide of iron.....	Trace	Trace	.....	Trace	.....
Organic matter.....	0.03	0.025	0.015	0.07	.....
Water.....	0.22	0.04	0.07	0.05	0.48
Total.....	100.142	100.018	99.925	100.066	100.436

The coloring matter is in part evidently organic, but in part, as suggested by Mr. Guyard, may be due to the presence of salts of iron. He says that he finds an appreciable amount of sulphide of this metal which will produce a black color. A remarkable feature in this analysis, as well as in that of the White Limestone, is the presence of appreciable quantities of alkaline chlorides. Microscopical examination under very high power (1,136 diameters) shows that the dusty appearance is due to minute specks in the grains composing the rock, which are fluid inclusions, in some of which the rapid movement of a bubble is visible. As will be shown later, it seems fair to assume that the included liquid consists of alkaline chloride. The microscope also shows that the rock is very finely granular, the size of the grains varying from .05 to .10 of a millimeter in diameter. No twin crystals of calcite are observed, and very little quartz or ore particles could be detected.

The characteristics which may serve in the field to distinguish the rock of the Blue from that of the White Limestone are as follows :

1. Color, which is darker.
2. Composition, the former being almost free from silica, the latter containing 10 per cent. and upwards.
3. Texture, the former being generally crystalline, while the latter is more compact.
4. Chert secretions, which in the former are always black and in the latter nearly white.
5. Structure, the Blue Limestone being generally more heavily bedded than the White.

Fossils.—The only fossils obtained from this horizon were found in the extreme upper part of the formation, either in the limestone itself or in chert nodules, which are found scattered over its weathered surface. The following forms were obtained from five different localities :

*Euomphalus*, closely resembling *E. Spergenensis*, Hall, from Warsaw limestones of Spergen hill.

*Spiriferina*, which is probably new, though somewhat resembling *S. Kentuckensis*.

*Athyris subtilita*.

*Pleurophorus oblongus*.

*Productus costatus*.

*Spirifera (Martinia) lineata*.

*Spirifera Rockymoutana*.

*Streptorhynchus crassus (crenistria)*.

*Cyathophylloid* corals, resembling *Zaphrentis*, or *Cyathaxonia cynodon*.

While most of these forms are common to the Coal Measures of the East, the first-mentioned is there found in the Lower Carboniferous. For this reason and because this form and the *Spiriferina* do not occur in any of the higher beds, it seems justifiable to assume that this horizon represents the Lower Carboniferous of this district.

The upper limit of this formation has been fixed at the top of the massive Blue Limestone, which is generally marked by the frequency of chert concretions, and in the mining districts has been followed by preference by the ore-bearing solutions. Locally, however, limestone formation seems to have continued somewhat intermittingly for some distance above this horizon.

**Weber Shales.**—On the general map of the Mosquito Range, owing to its small scale, it was considered advisable to make no subdivisions of the Weber Grits formation, and the whole is therefore included under one color (*g*). On the more detailed maps, however, a subdivision of the Weber Grits, designated the Weber Shales, has been distinguished by a distinct color (*f*). The beds included under this name are extremely variable in lithological character and in thickness. They constitute a transition series between the massive limestones below and the characteristic coarse sandstones of the Weber Grits above. They consist of argillaceous and calcareous shales alternating with quartzitic sandstones. The former are generally carbonaceous, and in their extreme type pass into an impure anthracite. The calcareous shales, on the other hand, are locally developed into a considerable thickness of impure limestone, which is very rich in fossil remains. Owing to its variable character and to the fact that the dividing plane between this and the preceding is frequently occupied by beds of porphyry, it is difficult to assign a definite thickness to the formation. It may, however, be assumed as varying from 150 to 300 feet.

In Leadville itself a thin bed of quartzite is often found immediately above the Blue Limestone, and on Iron hill is a greenish argillaceous shale, called the *Lingula* shale, from the abundant casts of this fossil which it contains. The coal development attains a thickness in one case of seven feet, but is extremely impure and gives little promise of any economical value.

**Fossils.**—The most common form is *Lingula mytiloides*, Meek, which is supposed to correspond to *L. ovalis*, Sowerby. Besides these were obtained from several different localities the following:

*Phillipsia*, sp.? (*P. major*?)

*Productus cora*.

*Productus semireticulatus*.

*Productus pertenuis*.

*Productus muricatus*.

*Productus Nebrascensis*.

*Spirifera cameratus*.

*Aviculopecten rectilaterarius*.

*Orthis carbonarius*.

*Streptorhynchus crassus (crenistria)*.

*Chonetes granulifera*.

*Discina nitida*.

*Macrocheilus ventricosus*.

*Archaeocidaris*.

*Eocidaris Halliana*.

*Fenestella perelegans*.

*Rhombopora lepidodendroides*.

*Myalina perattenuata*.

*Polyphemopsis*, (like *P. chrysalis*).

*Pinna*, sp.?

*Polypora*, sp. undet.

*Palæschara*, sp. undet.

**Weber Grits.**—This formation, which, as its name implies, consists mainly of coarse sandstones passing into conglomerates, has an estimated aggregate thickness of 2,500 feet, although neither its upper nor its lower limits can in the nature of things be very sharply defined.

The typical rock, which often forms massive beds of considerable thickness and constitutes a prominent feature in the sections afforded by cañons, is a coarse white sandstone passing into a conglomerate, made up of well-rounded grains and pebbles, mainly of white and sometimes of pinkish quartz. In the coarser conglomerates feldspar can often be distinguished in fragments, and this mineral is often disseminated in fine grains throughout the sandstone, but fragments of recognizable Archean schists are not often seen. It would seem, therefore, that these beds are mainly formed by the abrasion of the coarser granites of the Archean. The sandstones often contain a considerable admixture of brilliant white mica, and in some cases, besides the mica, so large a quantity of carbonaceous material as to become quite black. This carbonaceous material, which is insoluble in ether, alcohol, or sulphide of carbon, is probably either graphite or anthracite.

Next to the sandstones and conglomerates, the most important constituents of the formation are quartzose shales and mica schists, generally coarse-grained and of a greenish hue. Their lamination is very regular and often parallel to the bedding-planes, so that they often weather out in slabs or flags of considerable size. The mica, which, as in the sandstones, is mostly potash mica or muscovite, seems to form but a subordinate part of the rock mass, but is generally very prominent in large brilliant flakes on the surfaces of the laminae. Microscopical examination shows that in the sandstones and schists feldspar is always present with the quartz, and in some cases the three varieties, orthoclase, plagioclase, and microcline, can be distinguished. It also shows that the muscovite is, in part at least, derived from the decomposition of the feldspars; at the same time the uniform occurrence of large brilliant flakes along the bedding-planes of the shaly material suggests the possibility that these may have been directly derived from debris of the Archean and have been deposited in this position by the action of water.

At irregular intervals throughout the formation are found beds of fine

black mud-shales or carbonaceous argillites, generally very thin and sometimes calcareous, passing into impure limestones.

About the middle of the formation is a tolerably persistent development of limestone of the usual blue-gray color and dolomitic in composition. Its thickness, however, varies very much according to locality. It was best observed in Big Sacramento gulch, a short distance above the London fault, where are two beds of limestone with associated shales, about fifty feet apart and each about ten feet in thickness.

Fossils.—From the limestones in Big Sacramento gulch were obtained the following forms:

*Spiriferina Kentuckensis.*  
*Athyris subtilita.*  
*Productus costatus.*

*Productus muricatus.*  
*Aviculopecten interlineatus.*  
*Meekella striacostata.*

From micaceous schists in the upper part of the formation between Lamb and Sheep Mountains were obtained abundant casts of *Equisetaceæ*.

Upper Coal Measures (h).—Less favorable opportunities were offered for studying this group than for either of the preceding, since its beds were found only at the extreme limits of the map and in regions where continuous outcrops are rare. It consists of alternating calcareous and silicious beds, the latter not being distinguishable from those of the Weber Grits at the base, but passing upward into reddish sandstones, which in their turn are sometimes difficult to distinguish from the overlying red sandstones of the Trias. Its lower limit is drawn at the base of the first important limestone bed above the Weber Grits. This limestone, locally called the Robinson Limestone from the fact that it forms the ore-bearing horizon of an important mine of that name in the Ten-Mile district, is remarkable for being the first true limestone observed among the calcareous beds of the region. All below this horizon are practically dolomites of varying purity. As developed in this mine, it is of drab color, conchoidal fracture, and of peculiarly compact texture, resembling a lithographic stone. Its purity and textural characteristics are apparently not persistent outside of the Ten-Mile district. In the upper horizons of this district are found mud-shales, resembling in lithological character the Permo-Carboniferous of the Wasatch. Their fossil remains are found, however, to be distinctly Coal Measure forms.

The upper sandstones of this group are distinguished from the overlying Triassic rocks by a deeper color, approaching a Venetian red, whereas in the latter the color is rather of a light brick red.

Plate V (p. 60) shows a remarkably contorted specimen of impure limestone of this horizon from the outcrops on Empire hill, where abundant fossils were found.

**Fossils.**—Fossil remains were found in various beds of this formation in the Ten-Mile district; in a peculiar black limestone of the Hoosier ridge, to the northeast of Mount Silverheels; and on Empire hill, on the west side of the range, adjoining Weston fault.

From ten different localities in these regions the following forms were obtained:

<i>Productus costatus.</i>	<i>Pleurotomaria</i> (like <i>P. Greyvillensis</i> ).
<i>Productus Nebrascensis.</i>	<i>Naticopsis</i> (like <i>N. Altonensis</i> ).
<i>Productus Prattenana.</i>	<i>Macrochilus</i> ( <i>primigenius</i> ?).
<i>Productus cora.</i>	<i>Nucula</i> ( <i>ventricosa</i> ?).
<i>Spirifera Rockymontana.</i>	<i>Nucula</i> (like <i>N. Beyriche</i> ).
<i>Spirifera (Martinia) lineata.</i>	<i>Microdoma</i> (nearly <i>M. conica</i> ).
<i>Spirifera camerata.</i>	<i>Euomphalus</i> (sp. ?).
<i>Athyris subtilita.</i>	<i>Archaeoocidaris</i> (sp. ?).
<i>Streptorhynchus crassus.</i>	<i>Astartella</i> (sp. ?).
<i>Chonetes Glabra.</i>	<i>Loxomena</i> (sp. ?).
<i>Bellerophon crassus.</i>	<i>Fenestella</i> (sp. ?).
<i>Bellerophon percarinatus.</i>	<i>Murchisonia</i> (sp. ?).
<i>Bellerophon</i> (sp. ?).	<i>Synocladia</i> (sp. ?).
<i>Microdon tenuistriatum</i> (very small).	<i>Nautilus</i> (sp. ?).
<i>Microdon obsoletum.</i>	<i>Entolium</i> (sp. ?).
<i>Pleurophorus occidentalis.</i>	<i>Amplexus</i> (sp. ?).

#### MESOZOIC.

As Mesozoic beds do not occur within the area of the map, no attempt was made to study them systematically or to obtain a measurement of their thickness, which would have taken a great deal of time and probably been impracticable without a more detailed map than could be had. Their aggregate thickness has therefore been assumed to be not less than 6,000 feet, a safe estimate judging from the thicknesses given by the geologists of the Hayden Survey for various parts of Colorado.



The red sandstones of Mount Silverheels, above the beds assumed to be Upper Coal Measures in this report, are noticeable for their coarse grain and for the abundant pebbles of Archean rocks which they contain. In some intercalated shaly beds just east of Fairplay, Professor Lakes found plant remains and fossil insects. The former were determined by Professor Lesquereux to be undoubtedly Permian and the latter by Mr. A. Hyatt to be as certainly of Triassic age. In such conflict of evidence it seems safer to trust to that of animal life, since it is already well established that in America plants came into existence in Cretaceous time which in Europe have always been considered to have made their first appearance during the Tertiary.

#### QUATERNARY.

The Quaternary formations which have been designated by special colors on the maps and sections are the Glacial or Lake beds, and the Post-Glacial or recent detrital formations. As already shown, there is evidence of the existence, during the intermediate flood period of the Glacial epoch, of a large fresh-water lake at the head of the Arkansas Valley, in whose bed was deposited a considerable thickness of coarse and rudely-stratified beds of detrital material from the adjoining mountains.

**Glacial or Lake beds (g).**—Owing to the limited opportunities afforded for observing these beds in place, it was impossible to obtain a complete section of them or an accurate estimate of their aggregate thickness. The maximum thickness observed is about 300 feet; their material is generally coarse, and, as might be expected, very much coarser along what is known to have been the shore line of the lake. The finest of the beds consist of a calcareous marl, whose development seems to have been extremely local. The prevailing beds are a loose friable sandstone, resembling granite decomposed in place, consisting largely of grains of quartz and feldspar, and often somewhat iron-stained. These beds frequently alternate with those of coarser material, which form a rude conglomerate. The coarser beds contain both angular fragments and boulders of the rocks which make up the range, and lithologically can hardly be distinguished from the Wash of the succeeding formation; but, where any considerable thickness of the

beds is cut through, the stratification lines are easily recognizable and serve to distinguish this formation from the latter.

Along the immediate shore-line—as, for instance, under the Wash of Fryer and Carbonate hills—the upper portion of the Lake beds consists frequently of large angular fragments, a number of which are derived from the actual outcrops of ore bodies.

**Recent or Post-Glacial (r).**—Theoretically this rubric includes all the beds of the Post-Glacial Quaternary formations, of which there have been recognized in the region under survey several subdivisions, namely: the glacial moraines, a sort of boulder clay or rearranged moraine material which is prevalent in the immediate vicinity of Leadville, where it received the local name of “Wash;” a sort of terrace formation found in the larger valleys; and the actual alluvial stream bottoms.

The time allotted to the work did not admit of a sufficiently complete study of these different subdivisions to justify their distinction by separate colors on the map. In practice, therefore, on the surface maps only the alluvial bottoms and the broader accumulations of the terrace gravel in the larger valleys and plains, which are sufficient to completely obscure the subjacent geology, have been indicated. In the cross-sections of the special map of Leadville, however, where the explorations of shafts have given unusually complete data, the Wash is also included under this rubric. On the surface maps of Leadville and of the various groups of mines both these formations have been left out, as they would have hidden an important part of the geological outlines of the actual rock surface; they have, however, been indicated to scale in the cross-sections.

#### DISTRIBUTION OF SEDIMENTARY FORMATIONS.

The superficial distribution of the various sedimentary formations, or the relative area covered by their outcrops, being a function of or dependent upon erosion, is intimately connected with the existing topographical structure of the region. Were erosion the only factor to be considered, the Archean rocks would be found exposed continuously on the west side of a line approximately representing the old shore-line and in the deeper drainage valleys and anticlinal axes of the eastern side. The displacements of

the numerous faults which run through the region have, however, considerably modified this normal distribution. In point of fact, the central portion in the latitude of Leadville is mainly covered by the outcrops of Paleozoic sedimentary beds and of intruded masses of porphyry, the Archean exposures being confined to deep glacial amphitheatres near the crest of the range, and to minor masses which represent the eroded crests of anticlinal folds.

In the northern portion of the area Archean rocks are exposed along the main crest of the range and in the deep cañon valleys and glacial amphitheatres of the streams which flow into the Platte, Paleozoic beds being found only on the eastward sloping flanks of the included spurs. On the western side of the range, owing to the displacement of the great Mosquito fault, the area adjoining the valley of the east fork of the Arkansas is covered by beds of the Weber Grits formation, while a bordering fringe of outcrops of Lower Quartzite and White and Blue Limestone beds is found on the northern and eastern rim of Tennessee Park.

In the southern half of the map the western limit of Paleozoic beds is a line running southeasterly from the forks of the Arkansas to the crest of the range at Weston's pass, and southward beyond the limits of the map along the crest, approximately in a north and south line. West of this line are found only the granites and schists of the Archean, and irregular dikes and intrusive masses of porphyry. In the area included between this line and the crest of the range are triangular zones of easterly dipping sedimentary beds, in some cases forming a continuous series from the Cambrian to the Upper Coal Measures, cut off abruptly by fault-lines and succeeded again on the east by Archean exposures. On the east of the crest the Paleozoic beds slope regularly back beneath the floor of the South Park, the Archean rocks being found only in the deeper hollows at the heads of the streams. Beyond the limits of the map the outcrops of the more resisting beds of Mesozoic age form parallel ridges, running across South Park from north to south. The Quaternary Lake beds are found only along the lower ends of the spurs extending out into the Arkansas Valley from Leadville south to the limits of the map.

## ERUPTIVE OR IGNEOUS.

The eruptive rocks of this region, besides the granites, which were erupted during Archean time, are of Mesozoic or Secondary and of Tertiary age. The most important of these, both in magnitude of development and in their relations to the ore deposits of the region, are the Secondary eruptives; the time of their eruption cannot, as explained in the preceding chapter, be exactly fixed, but was probably toward the close of the Mesozoic. The Tertiary eruptives, on the other hand, are of comparatively limited development and have had no appreciable influence on the deposition of ore; their age is determined as such, not by any direct crossing of Tertiary beds, of which no instances were found in the region, but from their lithological character, their analogy to eruptive rocks of known Tertiary age outside of this area, and from the fact that they are later than the Secondary eruptives.

## SECONDARY ERUPTIVES.

The earlier eruptive rocks occur mainly in the form of intrusive sheets, often of great magnitude, which, having been forced up from below through some more or less vertical vent or channel, have spread themselves out between the strata, generally following a definite horizon, but at times crossing the stratification. They also occur in the form of dikes, this form being most common in the underlying Archean rocks. There is no evidence that any of them were poured out upon the surface like the lavas of the present day, but they must have cooled and consolidated under a great weight of superincumbent strata, to which is doubtless in great measure due their unusually crystalline character.

They are with unimportant exceptions porphyritic in structure; that is, they contain larger crystalline elements in a groundmass or matrix of finer grain, as distinguished on the one hand from the granitic structure, in which all the elements are crystalline and of comparatively uniform size, and from Tertiary eruptives on the other, in which, while the structure may be porphyritic, the larger crystals have a somewhat different development and the groundmass is made up in great part of non-crystalline material.

These distinctions are those that were in force before the introduction of the use of the microscope in lithological study. The more intimate knowledge of rock structure obtained by the microscopical study of rocks has brought about many changes in preconceived ideas, which are increasing every year, so that it seems merely a question of time as to when a new system of classification may be required. Already the distinctions noted above are true only of the most typical varieties of each, while between these are transition members which often must be placed in the one category or the other by some other distinguishing characteristic, such as time of eruption, internal structure, etc. In the present work it has been judged best to preserve the prevailing usage of designating the Secondary porphyritic rocks in which the prevailing feldspar is orthoclastic as *porphyries*, and those in which plagioclastic feldspars decidedly predominate as *porphyrites*. When the porphyrite is entirely granitic or evenly granular it becomes a diorite.

On the general map of the Mosquito Range only two colors are given to the porphyries, founded on two general divisions which have a geographical as well as a structural value. In the first of these is included the White Porphyry and its closely allied form, the Mount Zion Porphyry, which are the older and more nearly granular rocks, and which occur, with unimportant exceptions, only south of the north line of the Leadville map; the second includes all other varieties of the Secondary porphyritic rocks of the region, which are generally younger and less uniformly crystalline, and which do not occur south of the south line of the Leadville map.

On the detailed map of Leadville and vicinity the principal varieties of porphyry are each designated by a special color, the division "Other porphyries" including those which could not, with absolute accuracy, be brought into either of the other divisions.

---

<sup>1</sup>In the time that has elapsed since field work was completed and the maps colored, opportunity has been had for studying more comprehensively the various Secondary eruptives in the course of work carried on in neighboring districts, and it has been found that some of the varieties designated on the following pages as porphyry, viz, the Sacramento, Silverheels, and Green porphyries, should probably be classed as porphyrites. The reasons for this, as well as the detailed description of all the rocks from a microscopical point of view, deduced from their study under the microscope by Mr. Cross, will be found in Appendix A.

## MOUNT ZION PORPHYRY.

This porphyry, when fresh and unaltered, is a gray rock resembling fine-grained granite, and is made up mainly of quartz, feldspar, and mica; orthoclase being the predominant feldspar and biotite the original mica; plagioclase feldspar is decidedly subordinate, and biotite but sparingly developed. It is rarely found in an unaltered condition, however, and in the various stages of alteration it passes through a rock in which the partly decomposed biotite produces a slightly spotted appearance into a white rock glistening with fine lustrous particles of muscovite which can hardly be distinguished from the White Porphyry. The muscovite results mainly from the decomposition of the feldspar and also from that of the biotite. Larger individuals of quartz and feldspar, as porphyritic ingredients, can frequently be distinguished by the naked eye. Beside the above minerals the microscope also detects zircon, magnetite, and apatite as accessory constituents of the rock; it shows, too, that the texture of the rock is quite granular throughout, with no amorphous material.

*Occurrence.*—This rock is of comparatively limited development, being found thus far only on Mount Zion and on Prospect Mountain. It is generally in a less altered and therefore more typical condition on Mount Zion, for which reason it has received that name; but the most entirely unaltered specimens were obtained from some deep shafts on Prospect Mountain. On the south slopes of Prospect Mountain it is generally very much decomposed and apparently grades off into White Porphyry, so that it is difficult to draw a sharp dividing line between the two rocks. No rock that could be definitely classed with this variety has been found south of Evans gulch, and the body in the bed of the gulch above the mouth of South Evans has been assigned to it somewhat doubtfully.

## WHITE PORPHYRY.

The White or Leadville Porphyry is a generally white or granular, compact, homogeneous-looking rock, composed of quartz, feldspar, and muscovite. The quartz and feldspar are so intimately mixed together that they can only occasionally be distinguished by the naked eye, the former in small, double-pointed, hexagonal pyramids, the latter in small, white, rect-

angular crystals. The muscovite as an original constituent occurs in sparingly distributed, dark, hexagonal plates, which were at first supposed to be biotite; their true character was learned only when a specimen was found containing enough of the crystals to be subjected to optical and chemical tests. (See Appendix B, Table I, Analysis II.) A characteristic appearance of the rock is the frequent occurrence of pearly-white leaflets of muscovite, often in star-like aggregations, resulting from the decomposition of the feldspars. Orthoclase is the predominant feldspar. No biotite has ever been detected in the White Porphyry; but, as the rock is always in a more or less advanced stage of decomposition and as biotite occurs in the Mount Zion Porphyry, which seems to pass into it, it may have been an original constituent, though it is rather remarkable that no traces of it exist even in the small dikes where the rock still retains a distinct porphyritic structure and has a fresh conchoidal fracture. By means of the microscope are found zircon as a common and magnetite and apatite as rarer constituents of this rock. No glassy matter is found, either in groundmass or in inclusions. Chemical analysis shows an appreciable amount of BaO and PbO, substances common in the ores, in its composition.

Among the miners it is known also as "block porphyry," on account of its tendency to split up into angular blocks, which are often stained interiorly in concentric rings by iron oxide; and also as "forest rock," from the frequent deposition of dendritic markings of oxide of manganese on the cleavage surfaces.

**Occurrence.**—The principal development of the White Porphyry is confined to a zone about the width of the Leadville map, and running from the western boundary of that map south of east, instead of due east as the map itself does. In other words, its lines have the prevailing northwest and southeast trend of other larger features of the region. Within this zone it is developed on an enormous scale, and occurs mainly as an intrusive sheet directly overlying the Blue Limestone and in contact with the principal ore deposits. It is not, however, entirely confined to this horizon, but is also found at both lower and higher horizons and can sometimes be observed crossing a stratum, generally at a low angle, from one horizon to another, thus splitting the sedimentary bed into two wedge-shaped portions. This

occurrence is most noticeable in the area of the Leadville map along an imaginary northwest and southeast line, on one side of which it is found both above and below the Blue Limestone, while on the other it occurs only above it.

The main sheet has an average thickness of several hundred feet and varies in its extreme dimensions from 20 feet along the northeast edge of the zone to 1,500 feet at White Ridge, on the east side of the range, the point of its maximum development and supposed to be the locality of its principal vent.

Although all these masses must have been originally forced up from below through the Archean, it is remarkable that no section has yet been found which would show the actual passage from the Archean dike to the interbedded sheet. The nearest approach to this has been at the head of Iowa gulch, on Empire hill, and in a Lore-hole in South Evans gulch, where White Porphyry has been found in the Archean in probable dike form, and on White Ridge and Lamb Mountain, in Horse Shoe gulch, where it is seen cutting up nearly vertically across Carboniferous strata.

South of the zone above mentioned, White Porphyry is found as a remarkably persistent sheet at the Blue Limestone horizon gradually thinning out and extending to the southward as far as Weston's pass. North of the zone it is found only in small sheets at Little Zion, Mosquito Peak, and London hill, and in several small dikes in the Mount Lincoln massive, its place being occupied by other varieties of porphyry.

#### LINCOLN PORPHYRY.

The other forms of porphyry found (and which on the Mosquito map have been designated by one general color), though presenting a number of varieties in the field, have essentially the same general composition, both mineralogical and chemical. They consist mainly of quartz, two feldspars, and biotite, hornblende occurring as an essential ingredient only in one variety. The crystalline ingredients are easily distinguishable by the eye, and there is therefore no danger of confounding them in the field with White Porphyry, except in the conditions of extreme decomposition in which they may be found near the ore bodies. This crystalline structure,



on the other hand, is often so far developed that they are not readily distinguished by the untechnical eye from granites; as such, indeed, they are frequently classed by the miners. A careful examination, however, readily reveals their structural difference, which is that in them the larger crystals are inclosed in a finer-grained groundmass, whereas between the crystals of granite there is no such intervening and apparently structureless material.

The principal subdivision of this group has been called Lincoln Porphyry, from the fact that it is typically developed in the mountain mass around Mount Lincoln. Its most striking characteristic is the frequent occurrence of large crystals of pinkish orthoclase, from one inch upwards in size, with a peculiar luster like that of sanidine. Plagioclase is generally in small, white, opaque crystals. Quartz occurs in double-pointed hexagonal pyramids, which have a rounded outline on fracture surfaces and often a slightly roseate tint. Mica is found in small hexagonal plates, generally decomposed and of greenish color. The microscope discloses, in addition to the above minerals, allanite, zircon, magnetite, titanite, and apatite. No microfelsitic or glassy matter is found in any rock of this type and no glass inclusions occur in the Mount Lincoln rock. Orthoclase feldspar predominates in the groundmass and in the rock as a whole, while among the porphyritic crystals of rocks, in which the characteristic large orthoclase are wanting, plagioclase is in relatively larger proportion. Owing to the size of the crystals, large masses of the rock have at a little distance a decidedly granitic appearance. On weathered surfaces, especially in the dry region of the mountain peaks, it is of light-gray color, somewhat bleached, and often slightly stained by hydrous oxide of iron. In mine workings, on the other hand, when freshly broken it has a decidedly greenish tint, from the change of biotite into chlorite.

**Occurrence.**—The main development of the typical Lincoln Porphyry is in the neighborhood of Mount Lincoln, where it occupies the same position with regard to the ore deposits of that region that the White Porphyry does about Leadville. It forms the immediate summit of Mount Lincoln, where it is apparently the remains of a laccolitic body or head of a channel of eruption. It occurs as an interbedded sheet in the Cambrian and forms several large bodies, apparently interbedded sheets, in the Weber Grits

which form the wooded ridges on either side of the Platte Valley in that region. It also occurs in the form of narrow dikes, cutting through the Archean. On the west side of the range it forms many large bodies in the Weber Grits, the most important of which is the laccolite body of Buckeye Peak. These bodies in the northwestern part of the region pass into the closely allied variety called Eagle River Porphyry, with which they doubtless connect, and which will be described in detail in a forthcoming report on the Ten-Mile district.

#### GRAY PORPHYRY.

This rock, which occurs only in the immediate vicinity of Leadville, is in its typical form apparently a decomposed Lincoln or Eagle River Porphyry. It has the same mineral composition and frequently the large orthoclase crystals that the former has, and can be traced as a continuous sheet through transition forms into the typical variety of the latter. It is almost invariably decomposed, and on or near the surface is generally a greenish-gray rock, showing numerous crystals in a prominent earthy-looking ground-mass; in the mines it is usually found bleached and often reduced to a white pasty mass in which the outlines of former crystalline constituents are but faintly traceable. It is of importance in connection with the ore deposits, as where it has crossed the Blue Limestone it has often played the same rôle with regard to them as the White Porphyry.

As distinguished from the Lincoln Porphyry the microscope detects traces of former hornblende in the rock and finds glass inclusions in the quartz and numerous fluid inclusions in the feldspar.

**Occurrence.**—The main sheet of Gray Porphyry, the only body which is distinguished by a distinct color on the Leadville map, occurs above the main sheet of White Porphyry in the northern half of the area shown on that map, and extends beyond it to Mount Zion. Other bodies which belong without question to this variety, as well as those which are more doubtful, have, for reasons to be given below, been included under the color of "Other porphyries" on this map. The most important of these is a sheet occurring in the Blue Limestone, cutting transversely upwards from its base to the overlying White Porphyry. Among those which are doubtful are

the Printer Boy and Josephine Porphyries, which occur the one on Printer Boy, the other on Long and Derry hill. Among rocks so thoroughly decomposed as are those in the immediate vicinity of the ore bodies it is often impossible to assign an occurrence with absolute certainty to a distinct type; the miner can, however, in most cases distinguish these porphyries from the White Porphyry by the outlines of former crystals which the slight stain of iron oxide caused by their decomposition leaves.

## SACRAMENTO PORPHYRY.

This rock in the hand specimen has the same general appearance as the variety of Lincoln Porphyry which has no large crystals. It is a dark-gray, granular, rather even-grained rock, in which the groundmass is decidedly subordinate, and contains quartz, two feldspars, biotite, and hornblende. It is distinguished from the former rock by carrying a much larger proportion of plagioclase feldspar, and hornblende as well as biotite. The microscope discloses the usual accessory minerals, with allanite and pyrite, and shows that the groundmass is holocrystalline and contains no glassy material. In the large masses of the higher mountain region it is usually a fresh-looking rock, but in mine workings and under a covering of soil and gravel capable of holding water it is usually much decomposed and bleached to a light-green, almost homogeneous-looking rock, with much epidote. The processes of decomposition in this rock, which are exceptionally interesting, are explained at length in Appendix A.

**Occurrence.**—The main laccolitic body of Sacramento Porphyry is found under Gemini Peaks, between the heads of Big and Little Sacramento gulches. A fine cliff section of the body is also found on the face of Mount Evans towards Evans Amphitheater. It reaches a thickness of over a thousand feet in this region. Its main sheet occurs above the White Porphyry, or, when this is wanting, with an interposition of Weber Shales between it and the Blue Limestone. East of the London fault it rests directly on the Blue Limestone, and in the neighborhood of the Sacramento mine it plays the same rôle with regard to the ore deposits that the White and Lincoln porphyries do at other points. It also forms sheets higher up in the Weber Grits and less frequently in the lower Paleozoic strata. In

a broad, general way it may be said that on the eastern slope of the range Lincoln Porphyry extends from the northern edge of the map to Mosquito gulch, Sacramento Porphyry from Mosquito gulch to the ridge south of Little Sacramento gulch, and White Porphyry from there south to the limits of the map. The only point observed which showed evidence of a feeding channel from below was at the head of Little Sacramento gulch.

#### PYRITIFEROUS PORPHYRY.

This rock, though an extremely important element in the geology of the immediate vicinity of Leadville, does not occur outside that region and, like most of the eruptive rocks in the vicinity of the great ore concentrations, is in such a universally decomposed condition that its original constituents cannot be definitely determined. It is generally of a white color, with grayish-green or pinkish tints, comparatively fine grained, and with no traces of large crystals. In it can be distinguished small grains of white feldspar, quartz, biotite which is generally altered to a chloritic substance, and pyrite. The last ingredient, from which it derives its name, is found abundantly scattered through the rock in crystals, often so fine as to be undistinguishable by the naked eye. They occur at times within the crystals of quartz and biotite, and are hence supposed to be an original constituent of the rock. They are frequently concentrated along cleavage planes, sometimes associated with finely disseminated crystals of galena. Pyritiferous Porphyry is readily distinguished from the White Porphyry by its crystalline constituents. It differs from the Sacramento and Gray Porphyries by a relatively small amount of plagioclase feldspar and from the former by the absence of hornblende. Its most strikingly distinctive feature is the amount of pyrites which it contains, which is estimated to constitute, on the average, 4 per cent. of its mass. The only further constituents disclosed by the microscope are minute crystals of zircon. Fluid but no glass inclusions are found.

**Occurrence.**—The Pyritiferous Porphyry, as stated above, is confined to the area of the Leadville map, and is at present principally developed on Breece hill and the slopes of Ball Mountain. Its original extent previous to erosion was probably much greater than at present. It is a stratigraphic

ical replacer of the Gray Porphyry on the north and of the Sacramento Porphyry on the east, occurring mainly above the Blue Limestone, but with either White Porphyry or Weber Shales interposed between it and that horizon. In California gulch it is also found at lower horizons, but apparently cutting across them upwards.

## MOSQUITO PORPHYRY.

This porphyry, a light-gray, fine-grained rock occurring exclusively in the form of dikes, is formed of quartz, two feldspars, and biotite. The quartz is very prominent, in clear, irregular grains; orthoclase feldspar is predominant over plagioclase; biotite occurs in small leaves and is not abundant. The occurrence of macroscopical apatite in glistening hexagonal prisms is a noticeable feature of the rock. The microscope discloses a remarkable association of small ore grains (ilmenite, pyrite, specular hematite, and magnetite), together with zircon.

*Occurrence.*—The type rock was only observed in dikes in the Archean, viz, in the North Mosquito Amphitheater, on the north face of Mount Lincoln, and in Cameron Amphitheater where it extends from the Archean up into the Paleozoic.

## GREEN PORPHYRY.

This is a fine-grained, almost compact rock, of light-green color, resulting from the chloritic decomposition of its original constituents, which renders their identification difficult. Quartz, two feldspars, biotite, and hornblende have been identified; but the relative proportions of orthoclase and plagioclase are not readily apparent. Muscovite and calcite are decomposition products of the feldspars. The groundmass is often so subordinate that the rock seems macrocrystalline.

*Occurrence.*—It is found as interstratified sheets on lower Loveland hill near the Fanny Barrett claim and in Cambrian quartzite on the north side of Mosquito gulch; also, as a dike running north across the Paleozoic beds from the lower edge of Bross Amphitheater.

## SILVERHEELS PORPHYRY.

This rock forms important intrusive sheets on the mountain mass of Silverheels outside of the limits of the Mosquito map; it has not been so

carefully studied as the other varieties. It is an extremely fine-grained, greenish-gray rock, which in the hand specimen is characterized by fine needles of what is apparently decomposed hornblende. It carries quartz in small amount, two feldspars whose relative proportions are not readily apparent, with hornblende and biotite. These constituents are so very small as not to be readily distinguished. The microscope discloses the usual accessory minerals, including allanite and pyrite. The groundmass is holocrystalline and contains no glass. A porphyritic rock found on a southern spur of Mount Silverheels, at the forks of Crooked Creek, although of much coarser grain and more distinctly porphyritic habit, has essentially the same elements as the Silverheels Porphyry.

#### DIORITE.

Only three occurrences of granular plagioclastic rocks were found in the region, each of which was in the form of a dike cutting through the Archean in Buckskin gulch. The rock of each of these occurrences represents a distinct variety of the type.

**Hornblende diorite.**—The normal diorite, which forms a broad dike crossing the head of the gulch, is a fine-grained, gray rock, in which the prominent constituents are plagioclase feldspar and hornblende, while a little quartz, brown biotite, yellow titanite, and dark ore grains can be detected by the naked eye. The microscope discloses also zircon and apatite, with chlorite and epidote as alteration products of the hornblende and biotite, and muscovite formed from orthoclase. A similar rock is found in French gulch, on the west side of the range.

**Quartz-mica diorite.**—This rock occurs on the south side of Buckskin gulch, opposite the Red Amphitheater. It is a dark, even-grained rock, in which quartz and feldspar are more prominent than the small irregular leaves of biotite; hornblende is wanting. The microscope shows zircon, magnetite, apatite, biotite, plagioclase, orthoclase, and quartz as original constituents.

**Augitic diorite.**—This rock, which is darker and finer grained than either of the preceding, occurs in the Red Amphitheater, cutting up through the Archean into the base of the Cambrian. In the hand specimen only hornblende, biotite, plagioclase, and a little quartz can be distinguished, but the

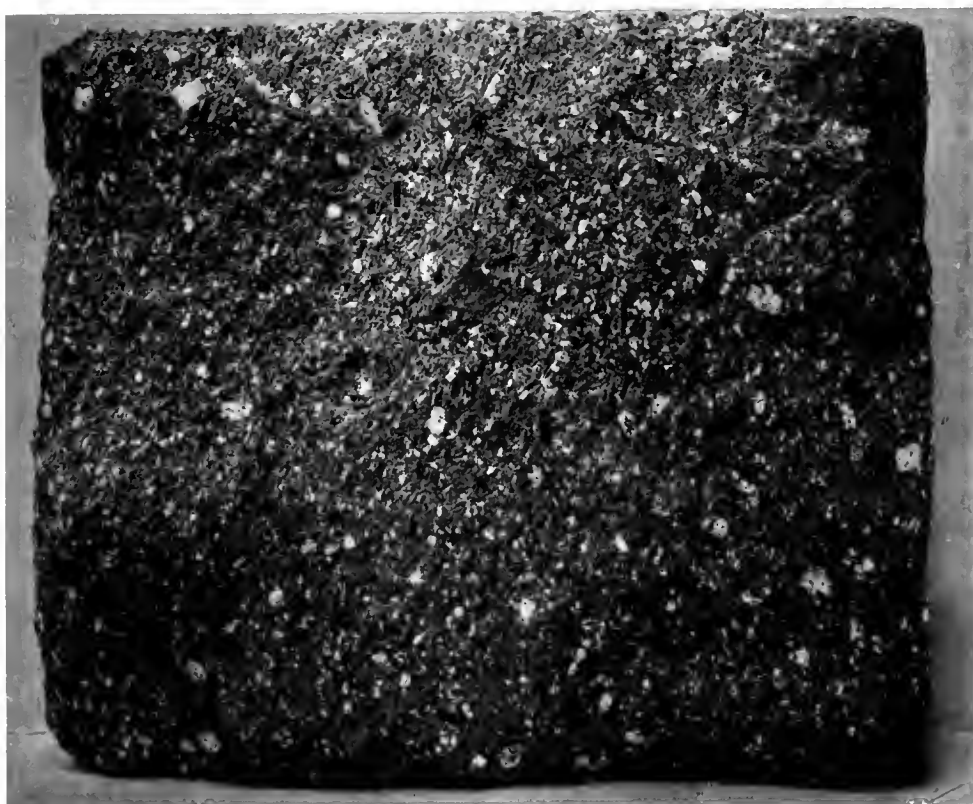

Hornblende Porphyrites





microscope detects also augite, orthoclase, zircon, titanite, magnetite, hematite, and apatite.

## PORPHYRITE.

As compared with the quartz-porphyrines, the type rocks of this class are distinguished at first glance by a great predominance of basic silicates (hornblende or biotite), by a comparative rareness of quartz, and by their rather younger field habit, as shown by the marked conchoidal fracture and generally fresher appearance. For the latter reason it was at first thought in the field that they might possibly be of Tertiary age, but the fact that they are folded and faulted with the inclosing Paleozoic rocks, as well as their internal structure, proves them to be, like the quartz porphyries, of Secondary age. In their manner of occurrence they are also distinct from the latter rocks, in that they do not form large bodies, neither dikes nor intrusive sheets being as a rule over twenty feet in thickness. The former often occur in the form of interrupted dikes; the latter, on the other hand, while occasionally crossing from bed to bed, have a most remarkable extent in **one** general horizon as compared with the thickness of the sheet. Although subordinate in amount to the quartz porphyries, these rocks occur with so many variations of internal structure and composition that they afford a complete series, including almost all the possible varieties of the type, and a complete description and classification made by Mr. Cross from a lithological point of view will be found in Appendix A. Only the general features of the rocks will therefore be given here.

The typical rock, both in composition and manner of occurrence, may be taken as that which occurs interbedded in the Paleozoic beds along the cliff sections on either side of Mosquito gulch. A photograph of a hand specimen of this rock is reproduced in Plate VII, Fig. 2, which gives some idea of its general appearance; it is a rather dark greenish-gray rock, with dark weathered surface and clean conchoidal fracture. The most prominent macroscopical constituents are well defined prisms of dark hornblende and small, white, opaque crystals of plagioclase. The microscope detects some biotite both among the porphyritic constituents and in the groundmass, and both orthoclase and quartz in the groundmass. No glass and but few fluid inclusions are found.

**Occurrence.**—The manner of occurrence of this rock in the region above mentioned is quite remarkable. It has been traced in practical continuity over an area of some four square miles, and probably has a much wider extent. It is regularly interbedded and rarely over twenty feet in thickness. It is easily traceable from a distance on the cliff walls, as a dark band between the lighter-colored sedimentary strata, and, while it apparently follows rigorously the same horizon, it is found, on close examination, to cross from bed to bed at different points, so that its range in this area is actually from the upper part of the Cambrian to the top of the Silurian. The manner in which it crosses the beds is shown in Plates XIII and XIV. It also occurs at various other points in narrow dikes in the Archean.

This rock forms Type V of Division B of Mr. Cross's classification, this division being that in which the hornblende and biotite are found both in the groundmass and as porphyritic constituents. His Division A includes rocks in which these basic minerals are entirely wanting in the groundmass, and which, in consequence, are of much lighter color than either of the other divisions. The rocks of his Division C, on the other hand, in which the hornblende and biotite are found only in the groundmass, are generally of darker color, and the arrangement of these minerals around the larger porphyritic crystals often shows a fluidal structure.

Included fragments of pebbles of Archean rocks are more frequent in these than in any other eruptive rocks of the region, and in Plate VII, Fig. 1, is shown a specimen of a rock of Division A, from a remarkable dike in the Arkansas Amphitheater, in which the included fragments are large rounded crystals of orthoclase, whose presence in such form it has not yet been possible to account for.

#### TERTIARY ERUPTIVES.

The Tertiary eruptives found in this region consist of rhyolites and one occurrence of quartziferous trachyte within the limits of the Mosquito map, and of an interesting occurrence of andesite just south of those limits. The quartziferous trachyte being a small body, and of no great importance as bearing on the subject-matter of this report, has not been designated by a special color, but is included on the map under the rhyolite color. The

eruption of these rocks had apparently no influence on the ore deposition of the region, since that, as well as can be determined, was pre-Tertiary, and no ore bodies have been found in connection with these rocks. Their interest is therefore chiefly lithological.

## RHYOLITE.

The most important body, both in mass and in lithological interest, is that of Chalk Mountain, on the northern edge of the map, which, as the name of the mountain indicates, is prominent on account of its dazzling white color. It is a very crystalline rock, in which the groundmass is so subordinate as to appear in the hand specimen entirely wanting; it corresponds, therefore, to the generally accepted definition of Nevadite. Its prominent constituents are sanidine, generally in large crystals and having a peculiar satiny luster, and smoky quartz. The microscope also detects some plagioclase, a little biotite, with magnetite, apatite, and zircon in relatively small proportion as compared with the quartz porphyries. The quartzes contain fluid inclusions. A careful study of this rock by Mr. Cross has developed the fact that the peculiar luster of these feldspars is due to an actual parting, analogous to cleavage, which has already been determined as that which gives the blue color observed in the feldspar of many rocks, notably labradorite and some rhyolites. He also found crystals of topaz in some of the druses of this rock, the first instance, so far as known, in which this mineral has been found in Tertiary rocks. On Plate VIII is the reproduction of a photograph of a hand specimen of this rock, in which the smoky quartz grains appear black; above this are two microsections which show the similar granular structure of this rock and of White Porphyry.<sup>1</sup>

The next important body of rhyolite is that at the west base of Bartlett Mountain, at the head of McNulty gulch, a tributary of the Ten-Mile Creek; it here cuts across porphyrite and quartz porphyry. This rock, though generally light colored, is not as white as the Chalk Mountain rock, nor is it so decidedly of the Nevadite type, the groundmass being often quite prominent. It contains glassy feldspars, quartz, and biotite. In darker

<sup>1</sup>In some of the plates, by an error in proof-reading, the title White Porphyry, which belongs to the left-hand section, has been placed below the right-hand section and vice versa. The reader will bear in mind that the section containing the large crystal is Nevadite.

portions of the rock biotite is quite abundant and some hornblende appears. The microscope shows glass, but no fluid, inclusions in both quartz and feldspar. The groundmass is cryptocrystalline. In general habit it is more like the recent volcanics than the Chalk Mountain rock, and yet, in some parts, it is with difficulty distinguished from a quartz porphyry.

A third important body of rhyolite is that which forms Black hill, at the southeast extremity of the map. This is a light, often rather pinkish colored rock, of fresh habit and conchoidal fracture. It carries macroscopically two feldspars, smoky quartz, and some biotite. The microscope shows the groundmass to be granular, and that fluid inclusions occur in both quartz and feldspar and glass inclusions in the quartz. From the hand specimen alone the rock would be difficult to distinguish from an earlier quartz porphyry, but the manner of its occurrence and its relations to the surrounding rocks leave little doubt that it must be of Tertiary age.

On the west slope of Empire hill a fine-grained, nearly white rock occurs below the White Limestone, which is distinctly orthoclastic and contains quartz and biotite. The fact that the quartz contains glass and no fluid inclusions points to a Tertiary age, but the occurrence has not been very carefully studied. A similar rock with larger crystals was found in a brecciated material from the Eureka shaft, in Stray-Horse gulch, which it has not yet been possible to account for.

*Trachyte.*—At the head of Union gulch are small irregular bodies, in granite and White Limestone, of fine-grained, dark-gray rock, full of brown biotite, with small glassy feldspars and some rounded yellowish quartz grains. The microscope shows hornblende and about equal portions of orthoclase and plagioclase. The groundmass is microfelsitic and has a fluidal structure. The quartz grains seem rounded and worn, and are confined to macroscopic individuals, for which reason they are regarded as accidental rather than normal constituents, and as the rock contains only 61.22 per cent. silica it is considered a trachyte rather than a rhyolite.

#### ANDESITE.

The Buffalo Peaks form a double-pointed mountain mass, rising about a thousand feet above the main crest of the Mosquito Range, some ten miles



Nevadite



White Porphyry



Nevadite,  
from Chalk Mt



south of Weston's Pass. They consist of a normal hornblende-andesite, which is the cap rock, with a black vitreous rock which was at first considered an augite-andesite, and a great development of tuffaceous and breccia beds. A careful study of the darker rocks led Mr. Cross to the conclusion that their characteristic mineral was hypersthene, and to the establishment of hypersthene-andesite as a normal pyroxenic variety of this class. These rocks are described briefly in Appendix A, and more fully in No. 1 of the Bulletins of the United States Geological Survey.

## CHAPTER IV.

### DESCRIPTIVE GEOLOGY OF THE MOSQUITO RANGE.

*Introductory.*—The following pages present a detailed description of the area included in the Mosquito map, summarized from field notes made during the summer of 1880. They contain the facts upon which have been founded the general conclusions drawn elsewhere with regard to the geology of this region, and therefore include many details that may not interest the general reader, but which will be of use to those who wish to use the maps on the ground or who desire to investigate critically the correctness of the generalizations. In preparing them it has been the aim of the writer to condense the description as far as could be done without omitting any essential observations. Circumstances made the time of field work extremely limited, and the detail in which it was possible to examine different parts of the region was necessarily unequal. The prime object of the work was to gather all information which might have bearing upon the origin and manner of formation of the ore deposits of the Leadville region. In the prosecution of this object much information of interest in other directions has been collected, and many lines of investigation have suggested themselves which it would have been a pleasure to pursue further had time permitted. That such material be found incomplete is to be attributed, therefore, to a want of opportunity rather than of scientific zeal.

In the following description the region has been treated in the general topographical order in which it was examined; that is, following the eastern slopes of the range from the northern edge of the map southward to Weston's pass, and then along the west side in the inverse direction. Both geological and topographical structures lend themselves to this method of



treatment, and permit four general divisions of the area: 1. The *northeastern*, including the Mount Lincoln massive, which, as shown in Plate IX, stands out quite by itself. 2. The *middle-eastern* region, or from Buckskin to Horseshoe gulch, inclusive. 3. The *southern*, including both sides of the range south of the line of Horseshoe and Empire gulches. 4. The *northwestern* division, including the area on the west side of the range north of the line of the Leadville map; the middle area, which comes within the limits of this map, being described in a separate chapter. Each of these four divisions presents a general type of geological structure peculiar to itself.

The numbers after rock descriptions are the catalogue numbers of the specimens in the Leadville collection of the United States Geological Survey.

**Surface features.**— The whole region treated of in this report may be divided as regards its general superficial characteristics into three belts or zones: (1) The bare summits and high ridges above timber-line; (2) the belt of forest growth covering the mountain slopes below timber-line; (3) the open grass-grown and treeless valleys.

The elevation of timber-line can only be given in a most general way as the average height at which tree-growth stops on the spurs where surface conditions are favorable. The bare glacial amphitheatres in the interior of the range and the almost perpendicular walls of the cañons present conditions unfavorable to tree-growth even at points below the timber-line, in spite of which the line is often well marked. Below an average elevation of 11,700 feet the flanks of the mountains are covered with coniferous trees of the more hardy Alpine varieties, such as the Douglas fir and Engelmann spruce, which in favorable situations often form a dense forest by no means easy to traverse, owing to the abundance of dead and fallen trunks, relics of former forest fires. The lower limit of tree growth is even more sharply defined; not, however, by its elevation above sea-level, but by the change of surface slope to the low angle which characterizes the valleys. Whether it be the bottom of a little mountain stream, a hundred feet wide, or the broad expanse of the South Park, almost as many miles in extent, the downward spread of forest growth is arrested with equal suddenness, provided

only there be a sufficient thickness of loose detrital material, whether gravel or alluvial soil, accumulated over the hard rock surface. Along the alluvial bottoms of the streams, it is true, there is often a fringe of willow, alder, or cottonwood; but the sturdy pine, although delighting to face the mountain blasts on bare inaccessible precipices, seems afraid to trust himself where he cannot thrust his roots down to a base of firm rock, or around boulders large enough to act as a counterpoise to the shaft he exposes to the force of the wind.

The high mountain region, the forest region, and the valley region represent fairly three degrees of comparative difficulty in reading the geological story. In the former, except where covered by talus slopes at the foot of great cliffs, the rock surfaces are all laid bare and the geological structure is an open book, only needing an understanding and careful observer to be read correctly. In the forest region there is more or less accumulation of soil and decaying vegetable matter, and rock outcrops are often rare and widely spaced. The record has many gaps which time and care are not always sufficient to fill without resorting to hypothesis or analogy. In the larger valleys, however, whose surfaces are covered to unknown depths by gravel and soil, no outcrops are visible, and induction or analogy are the geologist's only resources for determining the structure of the underlying rock formations.

**Glacial formations.**—In the Arkansas Valley, as already noted, there is distinct evidence of the existence of a glacial lake, and the Arkansas Lake beds, composed of stratified sands, marls, and conglomerates, have been actually exposed in a thickness of several hundred feet. In the South Park, on the other hand, no such stratified deposits have been observed, nor is the topography such as to suggest the possibility of a local lake of any great extent having been formed there during the Glacial period. While the existence of such a lake in the South Park is therefore considered improbable, the fact that the exigencies of this work admitted the examination of only a small portion of its surface, immediately adjoining the Mosquito Range, does not justify a positive statement to this effect.

**Post-Glacial formations.**—The Post-Glacial deposits of unstratified gravels are equally prominent, however, on both sides of the range. They result in great part from the redistribution of glacial moraines by the floods which accompanied the melting of the ice at the close of the Glacial period. In the Arkansas Valley they were spread out over the already existing Lake beds, and reach a relatively high level on the mountain spurs. In the western portion of the South Park they form the flood-plain of the larger valleys, which they filled up to a very considerable depth, as has been shown by excavations made at Alma and Fairplay in washing them for gold. Depths of 60 to 100 feet have here been proved of coarse gravel conglomerate, entirely without stratification. These points are comparatively high up and near the source of supply, and it may be assumed that finer material of the same origin extends to equal if not to greater depths well out on the bottom lands of the park. Within these flood-plains the streams run in alluvial bottoms which widen as one descends and often open out into broad meadows, partially drained lake basins, where some natural obstacle has caused a partial damming up of the earlier streams. Of actual moraines no inconsiderable remnants still remain. They can be most clearly seen along the steep sides of the cañon gorges through which the mountain streams debouch into the more open valleys, where they often form gravel ridges several hundred feet in height; and on the lower spurs beyond these cañons their existence under the forest growth may often be surmised by their characteristic topography of irregular ridges inclosing rounded hollows without exterior drainage, as well as proved by shafts and tunnels made by the misapplied energies of prospectors.

**Archean exposures.**—To the lithologist no more favorable opportunity could be had for an exhaustive study of the older crystalline rocks which form the backbone of the Rocky Mountain system than that afforded by the exposures in the deep gorges and glacial amphitheatres of the interior of this range. The scope of this work did not admit, however, of any such exhaustive study, which would have required much more time than could have been devoted to the whole region. The utmost that could be done was to grasp the more salient characteristics of the series and to outline on the map such of the more important eruptive masses which intersect them

as fell under observation, without pretending to present them in any determined degree of completeness. The special study of the Archean rocks in the field was assigned to Assistant Whitman Cross, to whom also was allotted the duty of examining them microscopically, and the greater part of the observations here recorded are derived from his notes. Granites and gneisses with accessory occurrences of amphibolite constitute, as already stated in Chapter III, the main components of the Archean in Mosquito Range. As seen from one of the commanding peaks of the range the most striking features of the rocks are the great irregular vein-like masses of white pegmatite, which form an infinitely intricate network on a background of darker gneiss. When examined more closely, however, the definite outline of these pegmatite bodies is no longer so apparent, and they are found to be intergrown in the surrounding rocks in a most intricate manner. It is only in the smaller veins, such as are shown in Plate IV, that their outlines can be definitely traced. Structure lines, as defined by relics of former stratification, are so seldom to be distinctly traced that no attempt has been made to co-ordinate the few facts observed into any general structural system.

Of eruptive rocks in the form of dikes and intrusive masses of irregular shape an almost infinite variety, both in form and composition, is found. The dikes are generally narrow, being rarely over 50 feet in width, and of limited continuous length. Those shown on the map are only the more prominent of those actually observed, and it must be borne in mind that a great portion probably did not come under observation at all.

#### NORTHEASTERN DIVISION.

*Platte amphitheater.*—Like the Arkansas River, whose amphitheater adjoins this on the west, separated only by a single narrow, knife-like ridge, the Platte at its source flows first north and then bends round upon itself to take its main course in a diametrically opposite direction. A reason for this by no means uncommon occurrence in the glaciated regions of the Rocky Mountains may be found in the fact that on the northern sides of the higher peaks are the greatest and most permanent accumulations of névé ice, to whose erosive action, not yet thoroughly studied, are doubtless

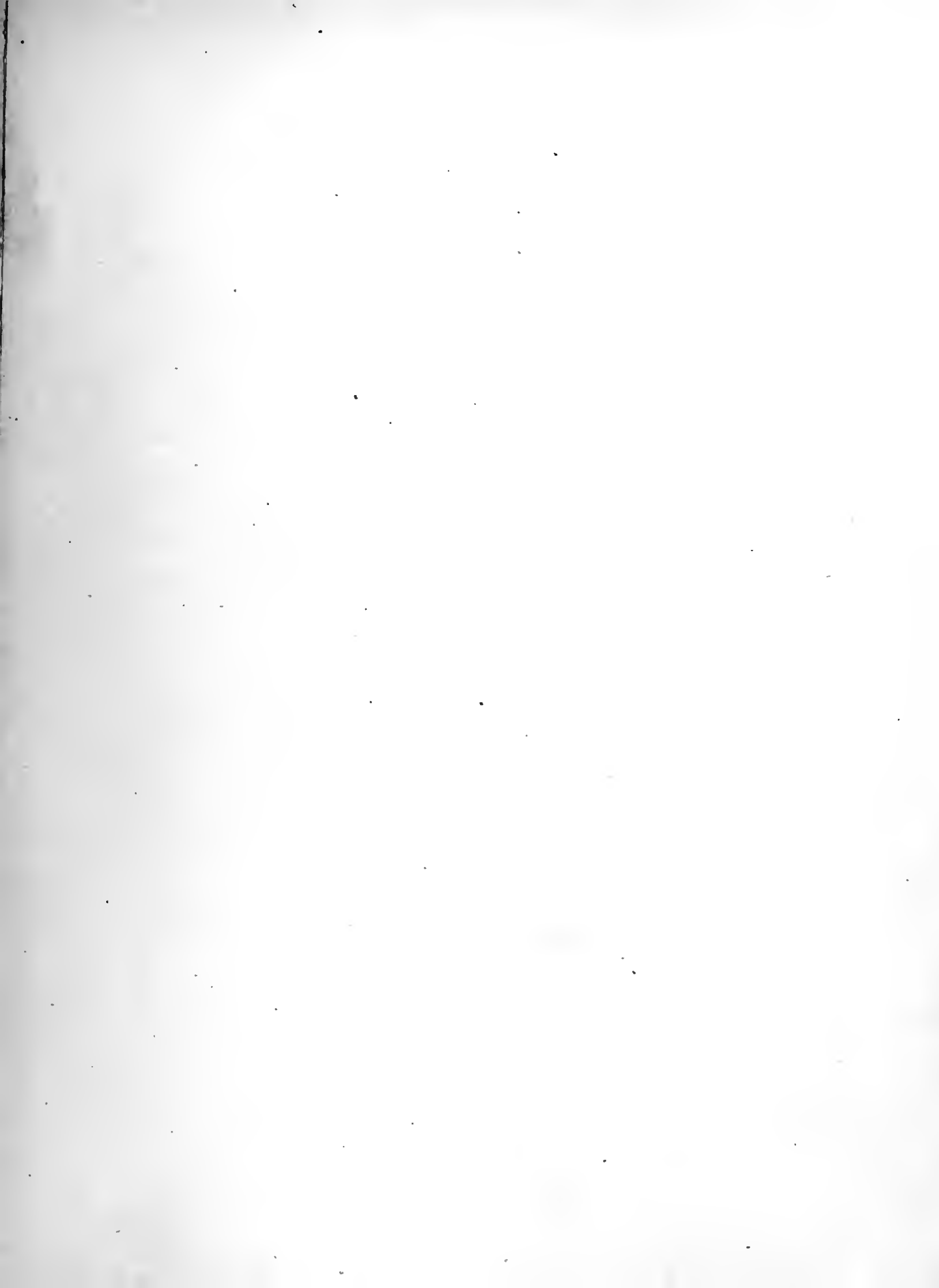

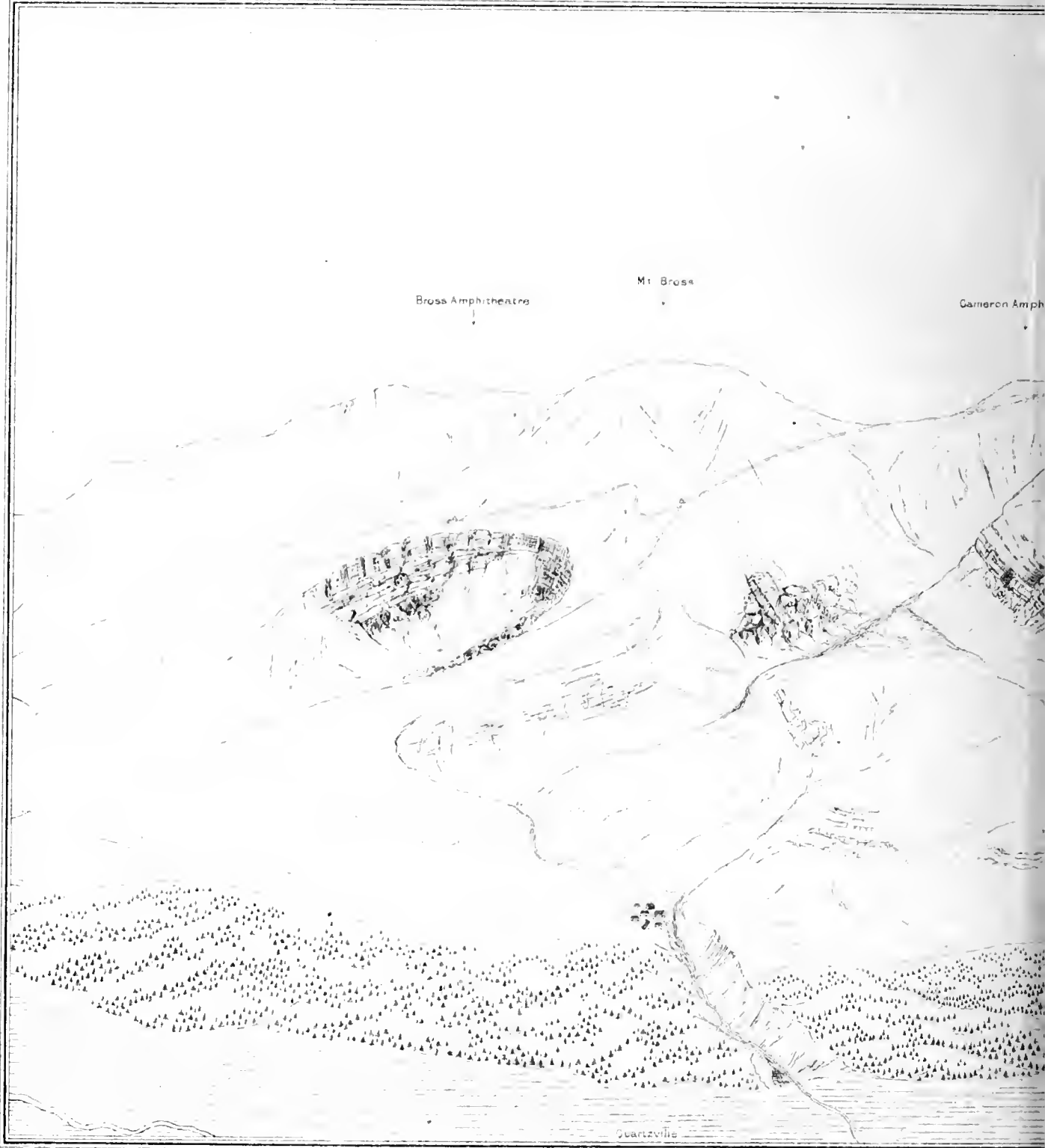

Bross Amphitheatre

Mt. Bross

Carrion Amph

Quartzville

Mt. Lincoln.

Lincoln Amphitheatre.

Platte Amphitheatre.

North Peak.



Montgomery

S. F. Emmons, Geologist-in-Charge





due the semicircular form and remarkable verticality of the upper walls of glacial amphitheaters or cirques.

The main area of the Platte amphitheater lies directly west of Mount Lincoln, but a smaller northwest branch extends back of North Peak, holding on its basin-shaped floor, which is about six hundred feet higher than the other, several pretty glacial lakes with characteristically emerald-tinted waters. The glacier formed by the confluence of the two immense névé masses that once filled these amphitheaters, which must have been about two thousand feet thick, flowed directly east, carving out a straight U-shaped valley in the crystalline rocks, whose general form remains essentially unchanged to the present day.

On the upturned sedimentary beds which rest upon the Archean, however, later erosion has acted more rapidly and irregularly, and at the little town of Montgomery the valley suddenly widens out into a broad, grassy bottom-land, with forest-covered hills sloping away more gently on either side. Immediately above Montgomery, as shown in Plate IX,<sup>1</sup> the present stream bends a little southward around a boss of Archean, composed chiefly of gneiss and amphibolite, penetrated by a fine-grained white granite, in which reticulated veins of white pegmatite stand out prominently. In the bottom of the valley, above this boss for a mile or more, extend glacier-worn hillocks (*roches moutonnées*), of typical form, evenly rounded and scored by very distinctly-marked grooves and striæ on the upper side, but breaking off unevenly on the lower side toward the stream. On either side of the gorge, above the talus slopes of broken rock masses at their foot, steep walls of Archean rocks rise about two thousand feet, with a thin capping of nearly horizontal Paleozoic strata at the very summit. The structure planes of the Archean, which are unusually distinct in the Platte gorge, stand nearly vertical, with a strike south-southeast.

The eastern portion of the Archean mass seems mainly composed of gneiss and crystalline schists, granite occurring only in subordinate masses. The granite near Montgomery is of the gray, fine-grained type, suggestive

---

<sup>1</sup>In this and the succeeding diagrammatic sketches, which are intended mainly to illustrate the geology of the various exposures shown, the letters on the outcrops are the same that are used on the geological maps to designate the different rock formations, i. e., *a* = Archean, *b* = Cambrian, *c* = Silurian, etc.

rather of an eruptive origin, and contains relatively more mica and quartz than that found in Buckskin gulch. The gneiss is of the normal gray type, generally rich in quartz and biotite. Its feldspar occurs often in large Carlsbad twins. The microscope detects plagioclase, microcline, and muscovite; also, abundant fluid inclusions in the quartz, sometimes double and with salt cubes and moving bubbles. A schist found locally on the northern face of Mount Lincoln is of dark-green color and contains only biotite, muscovite, and tourmaline, with a little feldspar, which is scarcely visible, even under the microscope, and then appears in a stage of alteration into muscovite. The white pegmatite masses are specially prominent, as already mentioned, on the faces of the spurs on either side of the gorge at Montgomery. Their color is due to the large proportion of white orthoclase feldspar, which in the mass gives its tone to the quartz also, while the mica, generally muscovite, occurs in bunches of subordinate importance, growing between the crystals of the other constituents.

The more prominent eruptive masses observed and which are indicated on the map are:

1. Half a mile above Montgomery a dike of porphyry crosses the valley at right angles and can be traced for a considerable distance up either wall. It is a light-colored, felsitic-looking rock, in which only very small quartz grains and biotite leaves can be detected by the naked eye. It most nearly approaches the Mount Zion, or fresh variety of White Porphyry, and has a holocrystalline structure as seen under the microscope.

2. A mile above Montgomery is a wider dike of light-gray quartz-porphyry, whose distinguishing peculiarity lies in brilliant-green grains of epidote, which are scattered uniformly through the rock and which are, in part certainly, the result of the decomposition of biotite. Its ground-mass is also microcrystalline.

3. A third dike is particularly noticeable for its peculiar form, changing half way up the cliff from a vertical to a horizontal sheet. This change of form is not unusual in dikes which extend up into the Paleozoic or regularly bedded rocks; but this is the only instance in which it has been observed in the Archean. The rock belongs to the Mosquito Porphyry type, and is identical with that found (type No. 2) on the south face of Mount Lin-

coln and at the head of the Cameron amphitheater. It is a light-gray, fine-grained rock, consisting of quartz, feldspar, and biotite crystals in a very scanty groundmass. The groundmass is a fine-grained mosaic of quartz, with some feldspar and muscovite, the latter resulting from decomposition of feldspar and probably in part also from fine biotite leaves, since this alteration is visible in the larger individuals.

4. Just west of this is a very irregular body of quartz-porphry, not shown on the map. It occurs at the base of the cliffs and is very variable in form and thickness, branching out irregularly and continually changing its direction. It is a dull-green rock and belongs to the Green Porphyry type. It is rich in feldspar, with a few grains of quartz, and what is probably a decomposition product of hornblende which gives the color to the rock. On the cleavage-planes are coatings of epidote.

5. Still further up the valley, directly under the summit of Mount Lincoln, is a dike of White Porphyry extending high up on the face of the cliff. It resembles closely the typical White or Leadville Porphyry, but is less decomposed. A few small crystals of quartz and feldspar are visible, also frequent light-green specks of partly decomposed biotite. It is almost identical with the similarly situated dike (dike No. 1) in Cameron amphitheater, on the south face of Mount Lincoln, and with fragments found at the head of Buckskin amphitheater, for which this description will also apply. Its outer weathered surface is very white and homogeneous-looking; immediately under this is a dark zone, less than an inch in thickness, which apparently owes its color to the oxidation of some heavy metal originally contained in ore particles or in the biotite. It was impossible to obtain sufficient biotite for a chemical test to prove this assumption, which is founded on indications observed by the microscope. In the Cameron rock small crystals of pyrite could be detected, and in that from Buckskin a little galena also, whose decomposition would more directly account for the dirty-brown color alluded to.

On the raised floor of the northwestern arm of the Platte amphitheater granite predominates among the Archean rocks. It is of the same variety as that found directly west in Bartlett Mountain and Clinton amphitheater, and has large and prominent crystals of feldspar disposed in regular order

throughout the mass. The associated gneiss also contains large orthoclase crystals, often two inches in length and usually Carlsbad twins. On the surface of this floor was observed an interrupted dike of hornblende-porphyrite, which is figured on the map; also, small outcrops of other eruptive rocks, notably one of White Porphyry, whose outlines were not determined with sufficient accuracy to be there indicated. On the west wall of this amphitheater appears a dark line, which may probably be part of the same dike of porphyrite as is shown on the map to extend almost continuously along the west wall of the Arkansas amphitheater. Owing to their darker color and peculiar fracture in large masses, which is like that of a basalt or andesite, the porphyrite bodies can readily be distinguished at a considerable distance.

The North Peak ridge, which forms the northern wall of the Platte gorge, being lower than the corresponding spurs to the north and south, respectively, is composed almost entirely of Archean rocks, a proportionately smaller capping of Paleozoic strata being left on its crest. The actual outline of the remnant of Cambrian quartzite remaining on the ridge could only be determined with exactness by the expenditure of more time than it was possible to devote to this point, and the line given on the map is that determined by observation of the apparent stratification lines from Mount Lincoln.

**Quandary Peak.**—On the Quandary Peak ridge, which lies just north of the limits of the map, it is easily seen from a distance that a remnant of Lower Quartzite is left at the very summit of the peak, as shown in the sketch given in Plate X, which is taken from the summit of Mount Lincoln. The angle of inclination of these beds, which is  $15^{\circ}$ , is less than that of a portion of the ridge, in consequence of which they have been eroded off the saddle immediately east of the peak, and are found again lower down on the spur. At the timber-line, which reaches only the eastern end of this spur, the dip steepens to  $25^{\circ}$ . This line of steepened dip can be traced on all the principal eastern spurs of the range and corresponds very nearly with the mouth of the cañon gorges which have been cut in the Archean. It is often accompanied by some apparent dislocation of the strata, the amount of which, owing to discordant dip angles, it was not easy to determine. For pros-



Julius Henz & Co. lith.

MOSQUITO RANGE AND BLUE RIVER VALLEY  
NORTH FROM MT LINCOLN

S. F. Emmons, Geologist in Charge

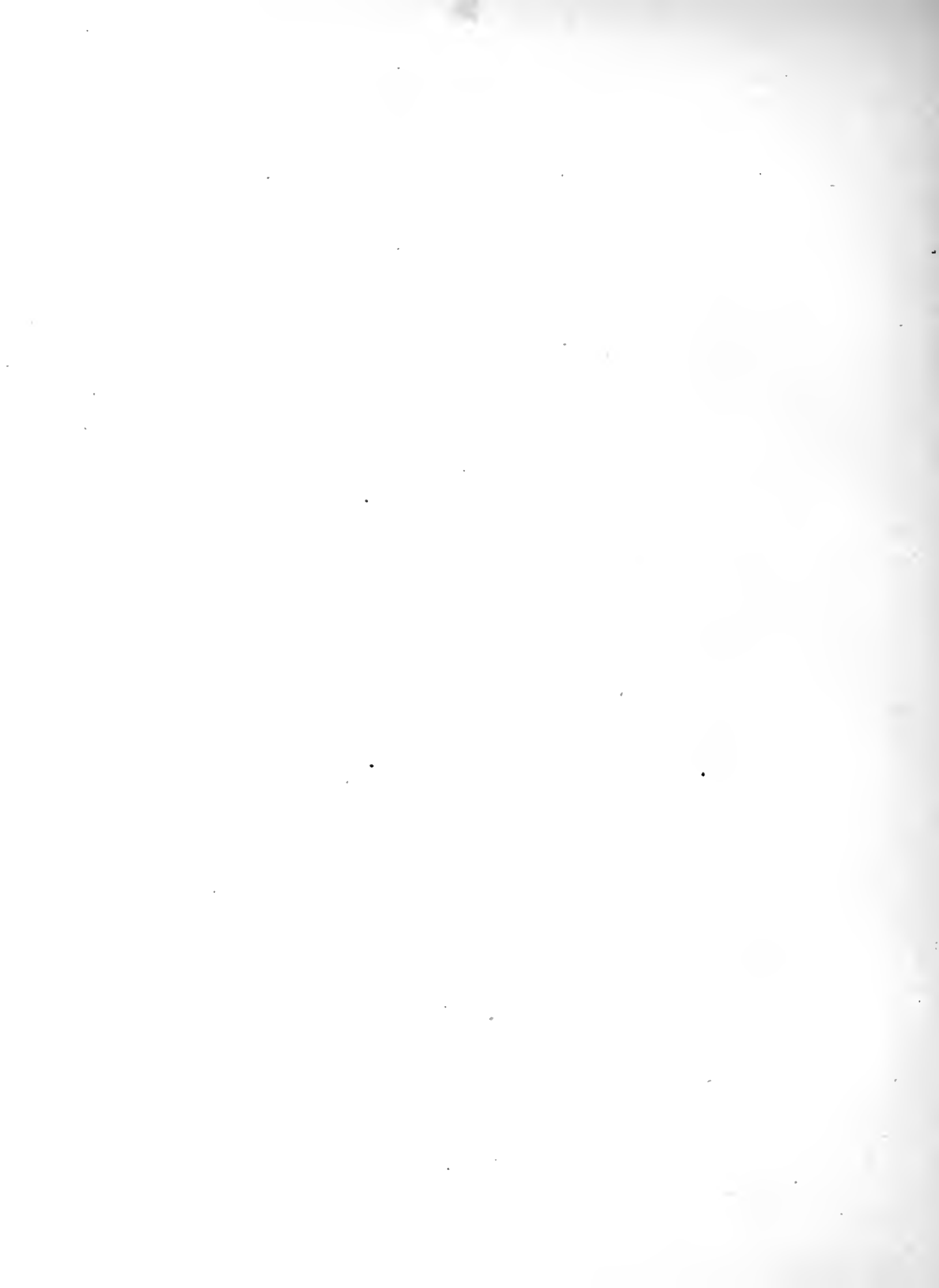

pectors this line seems to have had especial attraction, and not without reason, since along it are the best exposures of the lower Paleozoic rocks, in which on this side of the range there has been a considerable concentration of ore.

The sketch given in Plate X is a view of the region adjoining the upper Blue River Valley, as seen from Mount Lincoln. To the left or west of this valley the hills are almost entirely Archean, with a few later sedimentary beds resting against their eastern spurs. On Quandary Peak alone do they still extend up to the very summit. On the east of the valley are the hills surrounding the town of Breckinridge, made up of Mesozoic beds and numerous porphyry sheets, in which valuable ore deposits have been discovered and from the débris of which rich gold placers have been accumulated in the valleys.

The Quandary Peak ridge is here described, although it does not come within the limits of the map, since it was the only point at which the search for fossils in the Cambrian quartzite was successful. On its eastern end, a short distance above timber-line and perhaps half a mile above the Monte Cristo mine, about fifteen feet of greenish argillaceous slates, belonging to the upper part of this formation, are exposed by a prospector's tunnel which was run in on the north face of the spur. From these shales, after a diligent search, good impressions of the Potsdam species *Dicelloccephalus* were obtained. Unfortunately the ground is too much covered by soil and forest to afford a continuous section; but, unless a fault intervenes, this shale bed should be below the quartzite and limestone in which the Monte Cristo deposit occurs, and not many feet from it. Lithologically it resembles the greenish shale beds observed in very many points throughout the region below the calcareous shales and sandy limestones of the upper portion of the Lower Quartzite series, but nowhere were any further traces of these fossils found.

The exposures of the Cambrian or Lower Quartzite formation are nevertheless those of the Paleozoic series which can be most clearly and continuously traced, as they slope up in a U-shaped curve on either side of the valleys below the cañon gorges of this portion of the range. In general the outcrops in the valley bottoms and along the lower slopes are concealed

by surface accumulations, either talus slopes or alluvial soil. In the relatively wider valley of the Platte, however, about half a mile below the town of Montgomery, a moraine ridge which crosses the valley once dammed up a shallow lake basin, now a bit of meadow-land; the present stream, which drains this basin, exposes as it cuts through this ridge the quartzites and shales of the Lower Quartzite formation and a considerable portion of the overlying White Limestone, striking N. 15° E. and dipping 20° to the east.

*Hoosier pass ridge.*—On the slopes of the Hoosier pass ridge, just above Montgomery, about one hundred feet of the Lower Quartzite are again exposed in section, with two parallel intrusive sheets of porphyrite, the one 10, the other 40 feet thick; the whole dipping 25° to 30° east, with a strike to the west of north. This rock is the mica variety, having for its chief constituents a white plagioclase feldspar, with a much altered biotite and a few scattering quartz grains, in a dull-green groundmass.

The general line of contact of the Cambrian is traceable along the slope towards the crest of the North Peak ridge, but distinct outcrops are first found again at the saddle between Montgomery and the Blue River, over which a horse-trail leads. This saddle marks the outcrops of the Blue Limestone, which consist of a dark iron-stained dolomite, weathering black and carrying thin seams of barite. On the east of the saddle its limits are somewhat loosely defined by outcrops of blue shales, carrying casts of *Zaphrentis* and corals, which form a little knoll on the ridge, and may be assumed to belong to the shale member of the Weber series. On the west of the saddle, outcrops of the Blue and White Limestones extend to the steeper slopes of the North Peak ridge, where their limits are defined by a bed of green, fine-grained, silicious shale, impregnated with cubes of pyrite which at times forms beds a foot in thickness. Only the Lower Quartzite beds extend west of this on to the higher portion of the ridge. The workings of the now abandoned North Star mine on the first shoulder of the ridge have, as shown by the dump, passed through this quartzite into the schists of the Archean.

On the northeast face of the ridge, overlooking the valley of the west fork of Blue River, is a small amphitheater with a little lake in its basin, which the topography of the map shows but imperfectly. It is entirely in



the Archean, with the exception of a thin rim of Cambrian quartzite around its upper walls, and was probably carved out by a tributary of the main Blue River glacier, which descended the gorge from the back of Quandary Peak.

A section was made from this saddle eastward across Hoosier pass to Hoosier Ridge, which connects the Silverheels massive with the group of hills to the north that constitute the eastern boundary of the Blue River Valley. This ridge also forms the divide between the waters of the Blue and Upper Platte Rivers and those of Tarryall Creek.

No satisfactory measurements could be obtained of the thickness of the members of the Carboniferous group above the Blue Limestone, as was hoped: first, because the line followed did not cross the strata at right angles, but at times almost followed the strike; secondly, because of the great number of beds of porphyry included in the section, whose thickness could not be determined; and, thirdly, because of the evidence of a syncline on Hoosier pass itself. Nevertheless, the data obtained are given here somewhat in detail, as it was one of the few opportunities offered during the investigation to follow continuously the ascending series of beds from the Blue Limestone up to the assumed top of the Carboniferous formation.

From the saddle eastward to the grass-covered summit of the pass the outcrops may be assumed to indicate a thickness of about two thousand feet of beds. In this are included those of two prominent sheets of porphyry, which are apparently interbedded. On the first hill east of the saddle is an outcrop of shales, containing indistinct casts of fossils, apparently *Zaphrentis* and corals, which probably form part of the Weber Shales. The other outcrops are of the characteristic gritty rocks of this series (either micaceous, quartzose schists or coarse white sandstone, rich in muscovite and often passing into conglomerate) and one bed of black argillaceous shale, which all show a conformable dip to the east and north. The grass-grown glades which form the summit of the pass leave a gap about half a mile without outcrops. Towards the eastern side, and overlooking the head of Blue River, a prospect shaft on the Ready-Pay claim has cut a body of light-gray limestone, which is probably one of the thin beds of limestone found in the middle of the Weber Grits series. This limestone, as well as an

outcrop of coarse white sandstone a little east of the shaft, has a dip of  $30^{\circ}$  to the westward, with a strike of about N.  $25^{\circ}$  W. On the slope of the pass towards the Platte Valley the Dead-Broke tunnel discloses what is probably the same bed of limestone, with sandstones dipping in the same direction. A body of light-colored mica-porphyrite is also cut in the end of the tunnel.

The existence of a synclinal fold, as proved by these western dips, is in complete accord with the evidence, obtained farther south along the flanks of the ridge, of a secondary roll or minor fold in the strata parallel to the great fold of the center of the range, and explains the great thickness of exposures of Weber Grits beds. That the fold may have been accompanied by faulting is possible, but, as already stated, no direct evidence of a fault was found. Perhaps, had time permitted, a careful exploration of the ravine at the head of the Blue River and on the west face of Hoosier ridge might have afforded more definite proof. As it is, the geological outlines given on the map are generalized from observations made on the spur connecting it with Hoosier pass. The results of these observations are graphically shown in section A A, Atlas Sheet VIII, for the eastern end of which, beyond the Platte Valley, they furnished the data. The largest body of porphyry there shown, which forms the shoulder of the spur above Hoosier pass to the east, consists of typical Lincoln Porphyry (54). It contains the usual large pinkish crystals of feldspar, which in this rock, however, seem exceptionally susceptible to alteration and, instead of being fresh and rather glassy in appearance, are opaque and often quite kaolinized. The microscope shows rather more plagioclase than in the type rock, which may be accidental. The quartz occurs in small, double-pointed, hexagonal pyramids showing also the development of the prism; and on the crest of the spur, where, owing to the gentle slope and accumulation of soil, decomposition seems to have gone on most freely, the rock surface is covered with a coarse sand made up almost entirely of such quartz crystals, often with well defined angles and facets.

The steep north slope of the spur, facing the basin-shaped head of an eastern tributary of the Platte, shows a cliff wall of this rock with characteristic cross-jointings and vertical cleavage, almost amounting to a

columnar structure. The thickness of the body can be hardly less than five hundred feet, as roughly determined from the width of the outcrop on the spur. That it forms so regular a sheet as shown in the section is an assumption based only on analogy from other sheets of porphyry observed in the Silverheels massive. It apparently has its greatest thickness at this point, and thins out to the south and east, and in this respect has something of the laacolite form; but there is no evidence of any sudden steepening in the dip of the adjoining strata. On the contrary, the sandstone beds immediately overlying it, as shown in the outcrops on the crest of the ridge, have a regular dip eastward of about  $10^{\circ}$ . Only a few hundred feet of sandstones and sandy shales separate this from the next succeeding sheet of porphyry, which forms the cap of the first prominent shoulder about twelve hundred feet above the pass. This is a blue-gray rock, weathering yellow, of quite distinct habit, having a conchoidal fracture and a tendency to weather into sherry fragments. It approaches the normal Silverheels Porphyry, although coarser grained, showing few distinct crystalline ingredients when freshly fractured. On its weathered surface, however, fine needles of hornblende are easily distinguishable.

Beyond another body of sandstone and shales, and a similar though not identical body of porphyry which caps a second shoulder, a body of argillaceous shales of green, red, and purple colors marks what is assumed as the base of the upper division of the Carboniferous group. From these to the main crest of Hoosier ridge are several outcrops of porphyry sheets and intervening gaps of shaly rocks; among which a bed of dark-blue limestone, about a hundred feet in thickness, stands out prominently on account of its black weathered surface, opposite the head of the north fork of Beaver Creek. From this were obtained the following Coal Measure fossils:

*Athyris subtilita.*

*Productus cora.*

*Pleurotomaria, (P. Valvatiformis ?).*

*Loxomena, (sp. ?).*

*Bellerophon, (sp. ?).*

*Fenestella, (sp. ?).*

And spines of an *Archæocidaris.*

On the crest of Hoosier ridge are the reddish sandstones which form the passage from the Upper Carboniferous formation into the overlying

Trias, dipping  $15^{\circ}$  to  $20^{\circ}$  east and north. Two other beds of limestone at least are found in this formation, on the same line of strike southward along the western face of Silverheels and in the valley of Beaver Creek, and they may occur here in some of the numerous covered gaps in the section.

*Silverheels Massive.*—In order to complete the somewhat meager data obtained upon the upper member of the Carboniferous group on this side of the range, the observations made in the region west of the Platte Valley will be next recorded, comprising in this the eastern portion of Mount Silverheels and Beaver Ridge, with the included valley of Beaver Creek.

In a general way the eastern half of Mount Silverheels may be said to be Mesozoic, in great part probably Triassic, while its western face belongs to the Upper Coal Measures, and Beaver ridge to the Weber Grits. The included porphyry sheets in the former rocks have a more recent and trachytic appearance, like that found at the forks of Crooked Creek; those in the second group being rather of the Silverheels type, and those in the Weber Grits either identical with or similar to the Lincoln Porphyry. The number of these porphyry sheets is probably very much greater than is shown on the map, which represents a generalized outline of the more important bodies, deduced from observation made along three transverse lines only in the area represented east of the Platte; while in that portion of the mountain which lies east of the boundary of the map the porphyry bodies are, if anything, still more numerous. The swelling out of the strata, produced by the intrusion of such considerable masses of eruptive rock, is readily shown by the variations in the strike and dip. The steep north wall of Silverheels, as seen from the summit of Hoosier pass for instance, shows a fan-like arrangement of the easterly-dipping strata, which open out as it were to the west. In other words, the section shows strata on the west foot of the mountain, towards Beaver Creek Valley, dipping only  $10^{\circ}$  east; at the summit of the peak the dip has increased to  $17^{\circ}$ , while at the eastern extremity it is  $22^{\circ}$ ,  $25^{\circ}$ , and even  $35^{\circ}$ . The divergence in strike produced by the bowing-out of the strata is less evident on the map, owing to the fact that at the point of greatest divergence the great elevation of Silverheels above the surrounding valleys brings the outcrops, as projected on a

map, so much farther west. A rough calculation of the difference in thickness of given east and west sections, taking the one on a line passing through Fairplay, the other through the summit of Silverheels, would give an increase in thickness in the latter case of 3,000 feet, which may be assumed as the aggregate mass of the intruded porphyry bodies at the latter point, since on the line through Fairplay they have very largely disappeared by thinning out.

On a line eastward from Platte Valley to the summit of Silverheels the succession of rocks is as follows: Beaver Ridge, immediately adjoining the Platte Valley, whose steep slopes are covered with a thick forest growth which impedes observation, consists of the coarse grits of the Weber formation, with two principal and probably some minor bodies of Lincoln Porphyry. The valley of Beaver Creek, a straight depression in the line of strike, is apparently cut out of the softer shaly members at the top of this formation. From its bottom up the steep face of Silverheels are many porphyry bodies, whose débris often so obscures the outcrops that no continuous section can be obtained. In this extent five sheets of porphyry and one bed of gray limestone were observed; these alternate with shales and micaceous sandstones, which pass at the summit of the peak into conglomerates. A considerable number of these conglomerates outcrop on the ridge running eastward from the summit, alternating with purple and green shales and with sheets of porphyry, of which no less than eight were counted. The conglomerates contain an unusual number of rounded and sub-angular fragments of the more resisting Archean rocks, together with the rounded pebbles of pinkish milky quartz which are common in all the sandstones of a coarser nature. Beyond them the brick-red sandstones of the Trias become the prevailing rock, their dip steepening on the east slope to  $25^{\circ}$  and  $35^{\circ}$ . Along the west face of Silverheels the porphyry beds, which resist better the action of abrasion, can be traced in curving contours along the slopes, capping the more prominent shoulders of the spurs and disappearing from sight in the forests which clothe the lower spurs to the south.

The type of the Silverheels porphyry (89), which is found at the summit, is a fine-grained rock of slightly greenish-gray color, having a con-

choidal fracture, a sherry habit, and a clear ring under the hammer. It is composed of feldspar, hornblende, and biotite, with a little quartz, and contains from 60 to 63 per cent. of silica. To the naked eye no groundmass is visible, although the crystalline ingredients are so minute (being generally less than 1<sup>mm</sup> in size) that they cannot readily be recognized. A common variety (90) among the lower beds on the west and north is of coarser grain and more decidedly green color, due doubtless to the presence of chlorite.

The most southern of the three transverse lines above mentioned runs eastward from a little south of Alma, crosses several low forest-covered ridges separated by small valleys, and shows only detached outcrops separated by frequent covered gaps. In this section only one body of porphyry and three distinct horizons of dolomitic limestone were found. The beds, moreover, have a strike somewhat east of north and a dip of 25° or more to the eastward, instead of a strike to the west of north and dips of 10° to 15°, which prevail opposite the summit of Silverheels. The low ridge bordering the Platte Valley is covered on the west side nearly to its summit by the lateral moraine of the Platte glacier, which must therefore at one time have filled the valley to a level about 400 feet above its present bottom. Lincoln Porphyry, a continuation of one of the bodies seen in Beaver Ridge to the north, is disclosed by prospect holes. Various deep-red sandstones are crossed, alternating with limestone and shales, but the characteristic brick red of the Trias is first found at Crooked Creek, to the east of Fairplay, in the forks of which is another important sheet of porphyry, probably the porphyritic trachyte of the Hayden map. This is interesting as being different in appearance from any of the other porphyries observed in the region and resembling that found in a railroad cut through a Cretaceous ridge near Como. Nevertheless it does not possess the characteristics of a Tertiary rock, unless a slightly rough feel may be considered such. It is of light-gray color and contains abundant porphyritically disseminated crystals, mostly of white opaque feldspar, in a subordinated groundmass. Two feldspars, hornblende, altered biotite, and quartz in large but infrequent grains form its macroscopical constituents. Microscopically the groundmass is seen to be evenly granular and the rock to be simply a

porphyritic or coarser-grained modification of the Silverheels type, with no glass inclusions or other characteristics of Tertiary volcanics

**Lincoln Massive.**—The Mount Lincoln massive, as is shown on the map and as may be seen in the sketch given in Plate IX (page 95), is divided by a deep glacial gorge, heading at the base of Mount Cameron, into two mountain masses: that of Mount Lincoln on the north and that of Mount Bross on the south. On the east face of either of these mountains are two smaller glacial amphitheatres, to which the names of their respective peaks have been given. The beds of each of these three gorges stand at a much higher level than the adjoining beds of the Platte and Buckskin gulches; and, if the glaciers which once filled them were ever directly connected with the main Platte glacier, later erosion has removed evidences of this fact. At all events, it is apparent that after the Glacial epoch, when the ice was gradually receding, these were separate glaciers or névé fields. This fact is more particularly manifest in the Lincoln amphitheater, in the middle of which stands a moraine ridge, outlined in the sketch above mentioned, which ends abruptly at the lower end of the amphitheater, about 700 feet above the level of Platte Valley. These amphitheatres have more significance geologically than their topographical importance would indicate, inasmuch as erosion, having once cut through the overlying and more resisting mantle of sedimentary beds, has carved deeply into the underlying Archean, leaving characteristic semicircular walls at their heads which afford most useful sections for studying the interior structure of the mountain mass.

Mount Lincoln itself has three spurs stretching out to the eastward: a northeastern, an eastern, and a southeastern. Lincoln amphitheater is included between the two first. The surface of these spurs is covered by beds of the Paleozoic system, dipping eastward at an angle of  $10^{\circ}$  to  $15^{\circ}$ . This is the average inclination of the beds over the main portion of the mountain mass; but, as already mentioned in the case of Quandary Peak, the dip becomes steeper on the extreme eastern flanks. In general, however, the slope of the spurs themselves steepens for a short distance more rapidly than the dip, in consequence of which there is a belt of lower beds exposed along the foot of the steeper slopes.

The eastern spur of Lincoln, a narrow straight ridge, being relatively much lower than the northeastern or southeastern spurs, is covered only by beds of the Cambrian formation, the White and Blue Limestones which still cap the other spurs having been removed by erosion. Section B B, Atlas Sheet VIII,<sup>1</sup> passes through this spur and shows its profile and geological structure as well as can be expressed on so small a scale. In addition to the normal eastern dip, the beds have also a decided inclination to the south, so that the spur presents a perpendicular wall on the north towards Lincoln amphitheater, with a shallow ravine on the south separating it from the southeastern spur, the slope of the spur in that direction corresponding nearly with the dip of the beds. This southern dip is the relic of a lateral fold or slight corrugation produced by the forces of contraction acting in a northerly and southerly direction at right angles to the major force. The Lincoln amphitheater is thus shown to have been cut out of the axis of an anticlinal fold, and in the sedimentary beds still remaining on the northeast spur a slight inclination to the northward can still be detected, showing that they formed the northern member of this subordinate fold.

The Cambrian quartzites which form the mass of the spur are of the characteristic white saccharoidal variety, thinly and evenly bedded, and contain a slight development of white limestone, which has been occasionally observed elsewhere in this formation. At the eastern end of the spur is a cliff of quartzite, just above timber-line, below which the beds assume a steeper dip, so that the lower slopes are occupied by outcrops of successively higher horizons. At the foot of this cliff are several prospect holes, following deposits of copper and iron pyrite near or in contact with a body of decomposed quartz-porphry. A sheet of Lincoln Porphyry, which may be part of the same body, caps the spur above the cliff and is cut through by what seems to be a dike of porphyrite. The porphyrite contains both biotite and hornblende (the latter being, however, largely predominant) and is more decomposed than porphyrite rocks generally, both these minerals

---

<sup>1</sup> By an error in proof-reading, the line of this section, as given on the map in blue (Atlas Sheet VI), is partially wrong. It should pass from the summit of Mount Cameron to that of Mount Lincoln, and from there down the eastern spur, whereas on the map it passes directly from Mount Cameron to the spur.



being mostly altered to chlorite. Its groundmass is crystalline and contains a considerable development of calcite. Magnetite is also plentiful and has been frequently changed into hydrated oxide of iron. Muscovite is frequently present as an alteration product of plagioclase. The rock as usual contains many fragments of Archean, in this case of muscovite-gneiss. The Lincoln Porphyry is like the normal type, but contains few large feldspar crystals. Besides these is a more compact rock, apparently a contact product, which in general differs from either rock; however, some specimens show its probable connection with the Lincoln Porphyry. Its biotite and hornblende are completely changed into chlorite and epidote. The groundmass is very fine and not resolvable into its elements.

In ascending the regular slope of the ridge westward, as the dip of the formation is slightly steeper than this slope, successively lower beds of quartzite are crossed, and towards its upper end several interbedded sheets of porphyrite. These can be traced along the steep cliff wall overlooking Lincoln amphitheater, and are seen to follow the stratification lines for a considerable distance to the eastward and suddenly bend down into the underlying Archean, thus affording one of the few opportunities of observing the change from a vertical dike into an interbedded mass. Owing to the contrast of the dark color of the porphyrite with the white including quartzite, these bodies can be distinguished from a great distance, and are distinctly visible from the opposite side of the Platte Valley, on the road which leads from Montgomery to the Hoosier pass.

At its upper or western end, opposite the head of Lincoln amphitheater, this eastern spur merges into a basin-shaped valley with débris-covered slopes. On the east face of the northeastern spur, at the head of Lincoln amphitheater, a bare cliff wall affords a section of the lower sedimentary beds and included intrusive sheets, the whole mass much shattered and dislocated. Although time did not admit of the study of these cliff-sections in detail, as was done in the case of others which will be noticed later, the dark color of the intrusive masses and fragments obtained from the débris show that they are largely of porphyrite, and therefore are probably parts of the sheet already noticed on the east spur.

The upper surface of the northeastern and southeastern spurs of Lincoln, respectively, is mainly formed of beds of Blue Limestone, which have been opened by innumerable prospect-holes and several considerable mines on either spur. On the steep cliff faces towards the Platte cañon and the Cameron amphitheater, respectively, the limits of this formation and those which underlie it can be distinctly traced. On the more rounded interior slopes débris of Lincoln Porphyry obscure very largely the actual rock surface. For this reason and also owing to the small scale of the map, the outlines of the formations there indicated are somewhat generalized.

The sharp summit of Lincoln itself is made up of a mass of typical Lincoln Porphyry, projecting boldly above the sedimentary beds and noticeable for its vertical cleavage planes, producing a columnar structure which is best seen on its steep south face. Lincoln Porphyry is also found for a considerable distance down the east spur, and with it are associated shales and grits belonging to the Weber Shale formation. The short, sharp ridge directly west of the summit of Lincoln, and between it and the saddle that separates Mount Lincoln from Mount Cameron, is also composed of a series of beds which evidently belong to this horizon. They dip somewhat sharply to the east and consist of greenish, yellowish, and reddish shales and of micaceous quartzites, with a bed of black shale near the top, comprising in all a thickness of about two hundred and forty feet. Below this is a bed of Lincoln Porphyry, evidently interstratified, while on the saddle itself are outcroppings of Blue Limestone. A deserted mine on this saddle, known as the Present Help, the highest mine probably in the United States, is apparently at or near the contact of the Blue Limestone with the overlying porphyry; its workings had been abandoned and were inaccessible. The intense metamorphism shown in all the sedimentary beds near the summit of Lincoln and the columnar structure of its porphyry render it probable that the mass which forms the peak is directly above the channel through which this rock was erupted. There is evidence also that from this channel a sheet of the same rock was spread out over the surface of the Blue Limestone, which was probably the determining cause of the great concentration of mineral at this horizon.

The typical Lincoln Porphyry, as found on the summit of Mount Lincoln itself, is characterized by large orthoclase crystals, which sometimes reach two inches in length, of pinkish color, generally Carlsbad twins, and often so fresh and glassy in appearance as to remind one of the sanidine crystals of more recent rocks. There are five or six large crystals as a rule in an ordinary hand specimen. The smaller feldspars are white, and a large number show distinct striæ. Quartz is very abundant and relatively large, in round grains, often of pinkish hue, and showing more or less plainly the faces of dihexahedral crystals. Biotite in darker or lighter green leaves, according to its condition of decomposition, is quite conspicuous in the rock. A few specks of specular iron are sparingly scattered through the rock. The groundmass is light green or pinkish and is quantitatively quite subordinate to the crystalline element. Under the microscope it is seen to be fully crystalline.

Such is the typical Lincoln Porphyry, which projects in lofty columns from the summit of the mountain in a sharp apex which overtops all the surrounding peaks. Owing to its exposed situation it attracts the storm clouds from all the regions around, and even in midsummer scarcely a day passes without a slight fall of snow or hail on the summit. The very topmost rocks show traces of discharges of the electric fluid in the formation of fulgurite, which encircles the little holes it has bored into the rocks. Around the base of this summit mass of porphyry its contact with the sedimentary rocks is obscured by débris, the few outcrops that are seen being composed of rocks so much altered that their original character cannot be determined.

**Cameron amphitheater.**—On the steep south face of Lincoln, a sketch of which is shown in Plate XI, a careful study was made of the various eruptive masses. The Lincoln Porphyry of the eastern edge of the summit is of a much darker color than the normal rock and contains few or none of the larger feldspar crystals. It is so much decomposed that only in the center of large blocks is the original grayish color preserved; but the round quartz grains are distinct throughout. The Blue Limestone, which here seems to have a brecciated structure, can be traced as a horizontal line across the face of the cliff, from the Present Help mine on the west to the

Russia mine on the east, immediately below a bed of Lincoln Porphyry. Along the edge of the steep ravine which descends directly from the summit of Lincoln an irregular dike of porphyry crops out here and there, colored brilliant red and yellow on its surface, but so much decomposed that its original structure can no longer be determined. As shown in the sketch, it is only the Silurian (*c*) and Cambrian (*b*) strata which form continuous outcrops across the cliff face, and these are somewhat broken by transverse dikes of eruptive rock. Within the Cambrian quartzite is an intrusive sheet of Lincoln Porphyry, whose darker color contrasts strongly with the bleached weathered surfaces of the summit rock. The base line of the Cambrian, where it rests on the Archean, appears more irregular in the sketch than it is in nature, but it is evident that the Cambrian sea bottom was not so smooth here as it is shown to be in other cliff sections.

In the ravine next east from that already mentioned is a dike of White Porphyry, which can be traced, as shown in the sketch, from the gneiss of the Archean across the Cambrian quartzites into the White Limestone. This is dike No. 1, whose rock has already been described under that which occurs on the north face of Lincoln. Its outline is extremely irregular, and its contact surfaces with sedimentary rocks, which are distinctly visible, show none of the contact phenomena supposed to result from the heat of a fused mass. In its upper portion it is rounded, and curves over one of the heavier beds of White Limestone in an oval mass. On its east side, near its summit, the thinner beds of limestone are bent upwards, as if displaced at the time of its intrusion, and the lower shale beds of the White Limestone belt are more or less serpentinized. It also sends out offshoots a few inches wide through the natural joints of the sedimentary beds. About fifteen to twenty feet above the base of the Lower Quartzite it crosses an interbedded mass of porphyry of a dark-green color, which is here some thirty feet in thickness. This interbedded porphyry is thoroughly decomposed, the only crystals visible being rounded quartz grains, which resemble those of the Lincoln Porphyry. All its cleavage planes are covered by a dark-green coating of chloritic nature, and it is crossed by thin perpendicular fissures, from one to two inches in thickness, containing pyrites and having a bright-yellow weathered surface. A comparatively fresh specimen was obtained

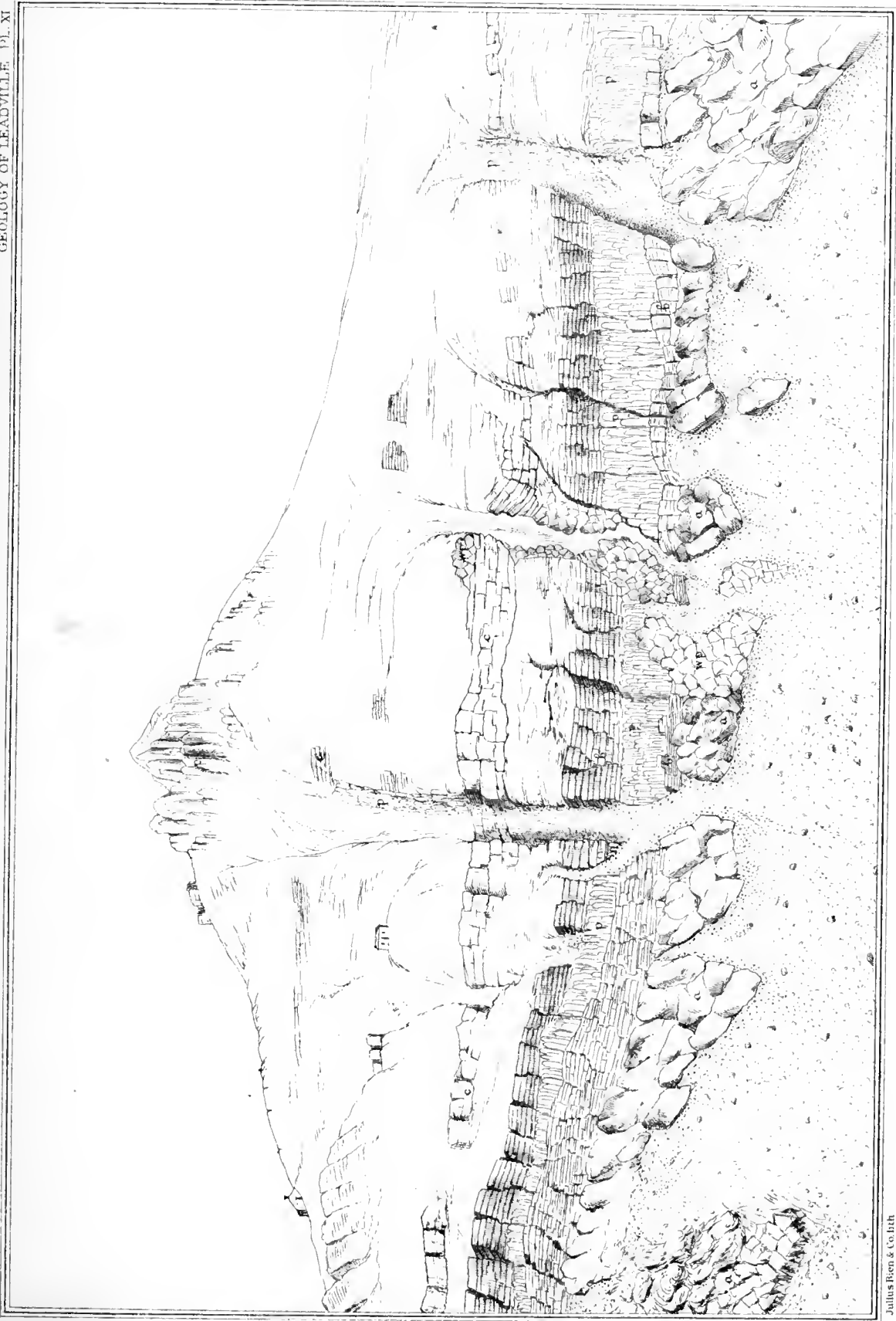

Julius Bien & Co. lith

SUMMIT OF MT LINCOLN  
AND NORTH WALL OF CAMERON AMPHITHEATRE [UPPER END]

S. F. Emmons, Geologist-in-Charge



with some difficulty, which shows the characteristic large, pink, orthoclase feldspars of the Lincoln Porphyry. In this the green color is seen to be due to the alteration of biotite into a chloritic substance, which has been deposited on the surface of the smaller feldspars, so that they are scarcely distinguishable by the naked eye. Biotite is also no longer visible except under the microscope. Pyrite can be distinguished throughout the rock by the naked eye.

The Archean rocks (*a*) at the base of this section consist almost entirely of dark-gray gneiss. In this the White Porphyry dike can be traced but a short distance, as it is soon lost under the steep talus slopes at the foot of the cliff.

A few hundred feet east of this dike (to the right in the sketch) a second dike (No 2) can be traced, though less distinctly, from the gneiss entirely across the Cambrian and Silurian formations, apparently terminating at the base of the Blue Limestone. It is much narrower and straighter than dike No. 1, and like that seems to have a northeast and southwest direction. Its rock is a light-colored, fine-grained, highly-crystalline porphyry, belonging to the type designated as Mosquito Porphyry, which has already been described. There is an outcrop of the same rock in the Archean, on the west wall of the Cameron amphitheater directly under Mount Cameron, which may possibly be part of the same body, although the intermediate region is too much obscured by débris to trace any direct connection.

Eastward of this cliff face the northern wall of the Cameron amphitheater is much covered by débris for the distance of nearly a mile, in which extent, although the general dip of the sedimentary beds can be traced, no opportunity was presented for an examination of the intrusive bodies. Near the eastern end of the wall, however, is a second cliff section, which shows in a very instructive manner the position of the intrusive masses and dikes. It is graphically represented in Plate XII, which, like the preceding plate, is copied from sketches made on the spot by Prof. A. Lakes. The section was studied by Mr. Cross, from whose notes the following description is largely taken.

Here, as in the section just described, is an intrusive interbedded mass of porphyry in the Lower Quartzite (*b*), only a few feet above its base,

which is also crossed by a nearly vertical dike. This vertical dike, as may be seen on the left half of the sketch, can be traced from the Archean up to the base of the Blue Limestone. It is from fifteen to twenty feet wide at the bottom and branches at the top into five small arms, but does not spread out between the strata. Its rock is a White Porphyry, which differs from any of those observed elsewhere in carrying large orthoclase feldspars, sometimes an inch in length. They are Carlsbad twins, and have a pinkish tinge like those in the Lincoln Porphyry. Small rounded grains of quartz are also abundant, but no trace of hornblende or biotite could be seen, either by the naked eye or with the microscope. Under the microscope the feldspar is seen to be partly plagioclase, and in the quartz are many small fluid inclusions. The interbedded porphyry mass, like that on the south face of Lincoln, is prominent by its dark color; but on examination it is seen to consist of two distinct rocks, one of which seems to have pushed its way through the other after it had been already spread out between the beds. The later rock is a Lincoln Porphyry, whose outlines can be distinguished from a little distance by its peculiarity of weathering, its fragments showing larger surfaces than that of the earlier rock. The earlier rock is of a light-green color, and shows, to the naked eye, scarcely any distinguishable crystals, feldspars being decomposed to a substance very like groundmass. Altered hornblende, a few biotite leaves, and an occasional quartz grain can be distinguished by the lens; also, a few small specks of some metallic combination. Under the microscope the groundmass resolves itself into a fully crystalline admixture of quartz, mica, and feldspar. Calcite is present in filmy particles and occasionally in grains. The larger quartz crystals contain fluid inclusions. The contact specimens of these two porphyries show a blending of the characters of the two in the tendency to the formation of large quartz and pink feldspar crystals in a base more like the older porphyry. As shown in the sketch, the Lincoln Porphyry throughout the greater extent of the section is entirely included within the older mass. Towards the eastern end, however, it forms a distinct bed above the other, and each sends off a branch upward in a northeast direction across the strata, forming nearly parallel dikes which meet at the surface of the ridge. These



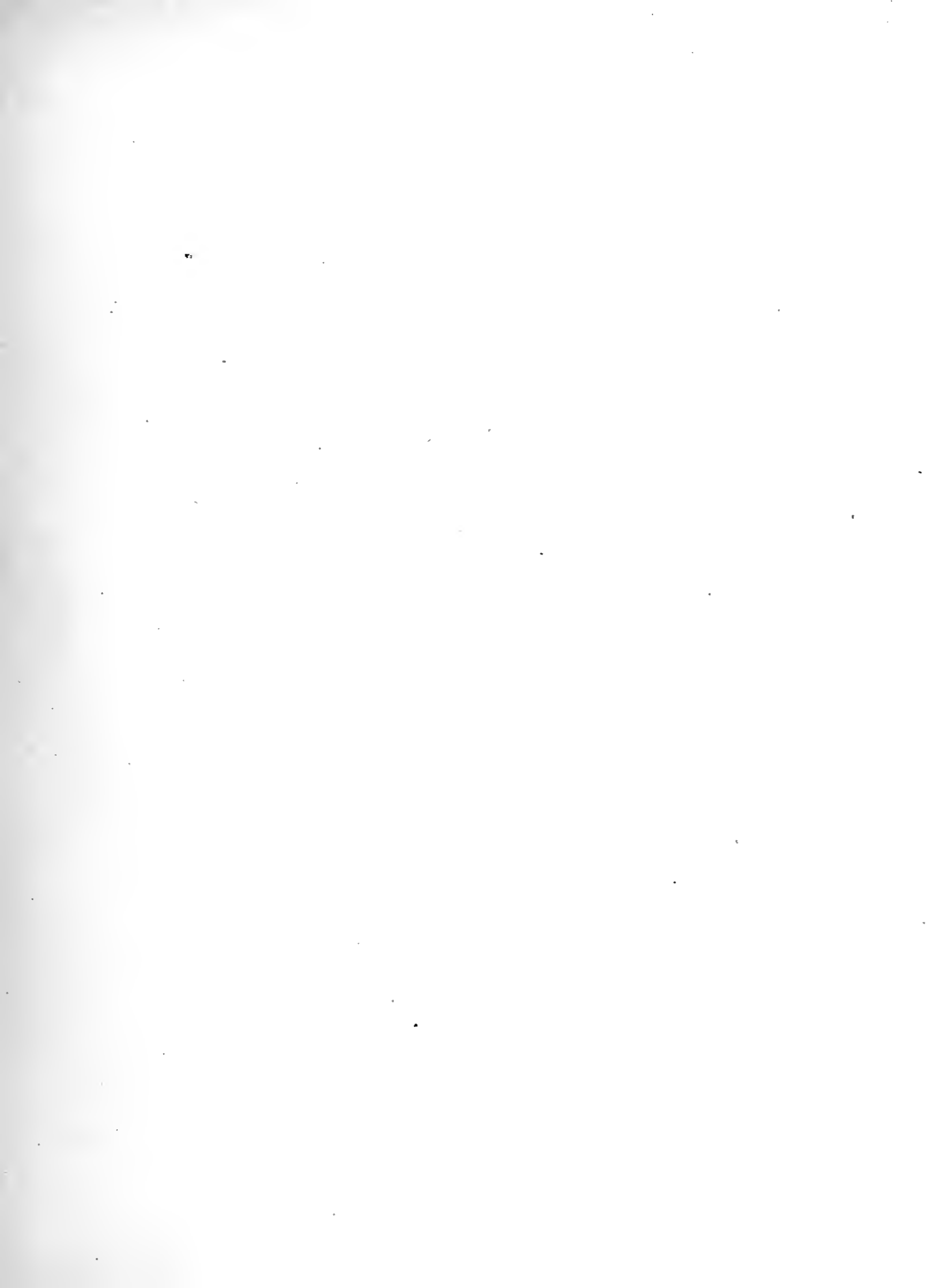



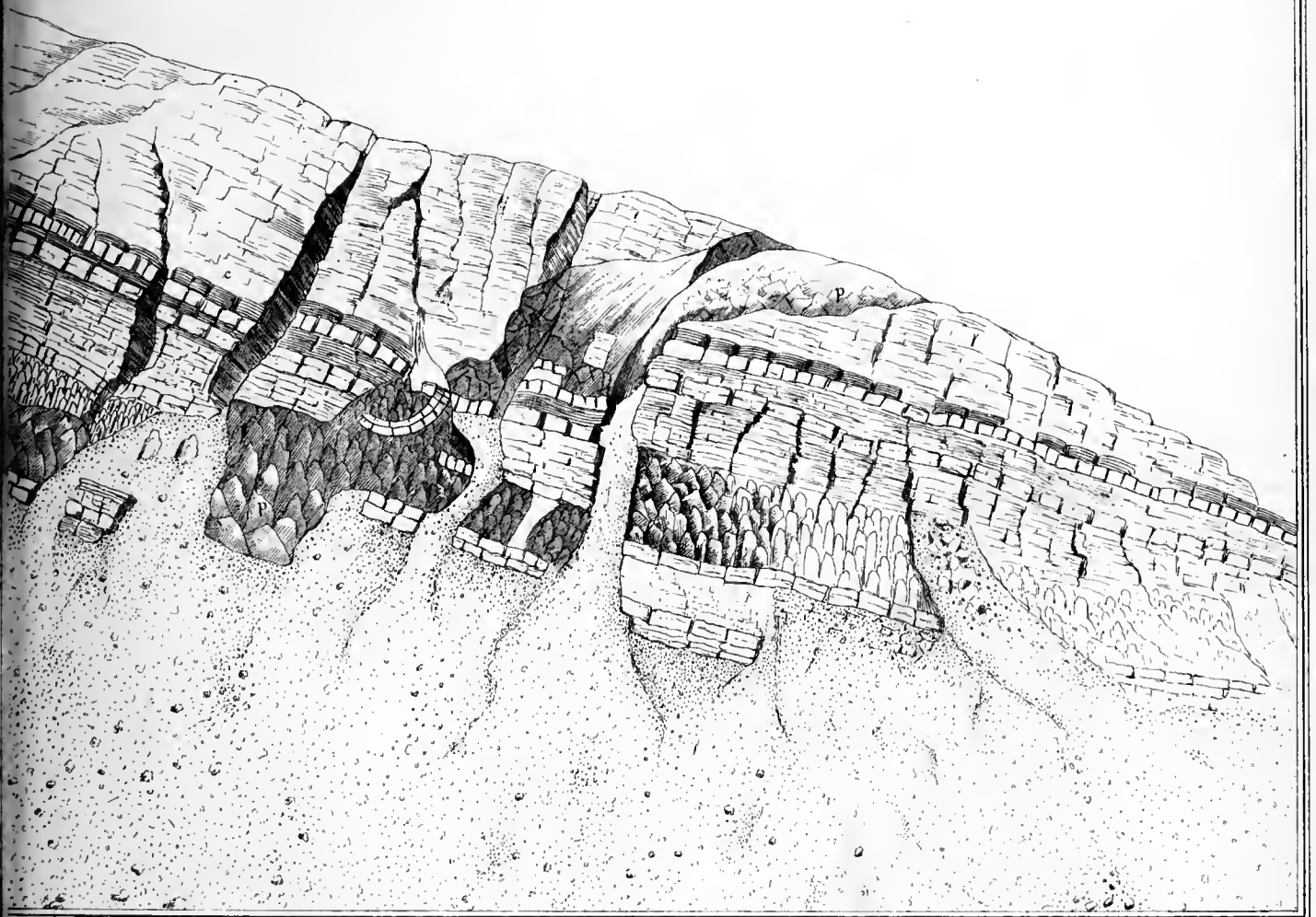

IRON AMPHITHEATRE  
END

S. F. Emmons, Geologist-in-Charge.



dikes are about fifteen feet in thickness each, while the combined beds have a thickness of from fifty to sixty feet.

This intrusive sheet of Lincoln Porphyry at the Cambrian horizon, which seems continuous along the north wall of the Cameron amphitheater, was traced out to the end of the southeast spur of Lincoln; and what is apparently the same bed was also observed lower down the slopes, in the more steeply-dipping members of the same formation. Outcrops of similarly situated bodies, as shown on the map, are also found on the south wall of the Cameron amphitheater and on either wall of the Bross amphitheater. Time did not permit of tracing any connection between these different outcrops; and it seems doubtful whether any exists, inasmuch as for some unknown reason there seems to have been much less tendency to spread out in extensive sheets at this horizon than at that above the Blue Limestone. Although this latter porphyry bed is only found to a limited extent above the Blue Limestone on Mount Lincoln, there is no doubt that it once covered that bed, forming a sheet comparable in extent to that of the White Porphyry in the Leadville district.

**Cameron and Bross.**—The summit slopes of Mounts Cameron and Bross, except those on the cliff faces which are too steep to permit the lodgment of débris, are mainly covered by fragments of Lincoln Porphyry. Eruptive rocks under the action of atmospheric degradation split up into fragments whose shape and relatively small weight, as compared with their superficial area, render them more susceptible to being moved by melting snow, so that on mountain sides they generally cover a surface disproportionately large as compared with their actual outcrops. This is eminently the case on Mount Bross, where angular fragments of porphyry often cover the surface to a depth of ten feet or more and the character of the underlying rock can often only be determined by actual excavation.

The porphyry of the summit of Mount Cameron is remarkable for the unusual development of large orthoclase crystals, often more than two inches in length, which weather out from its surface. Associated with the much-weathered fragments of porphyry are various brown quartzitic sandstones, which may represent a bed of the Weber Grits formation not yet

eroded off the summit. No sufficient evidence was found, however, to justify its indication on the map.

On Mount Bross the Lincoln Porphyry shows a still lighter color than that on Mount Lincoln, which seems due to the fact that the decomposed mica, instead of remaining as chlorite, has been entirely removed. Fragments of shales and quartzitic sandstones of the Weber Grits formation are mingled with the porphyry débris of the upper slopes of Bross, and outcrops of these rocks are found on the ridge connecting it with Cameron, as well as to the south of its summit on the ridge overlooking Buckskin gulch. In the latter instance they stand at a much steeper angle than the lower series of Paleozoic beds, and give evidence of some local movement. In Section L, Atlas Sheet X, is shown the probable form of the Lincoln porphyry body on the summit of Mount Bross, as deduced from observed outcrops. It is very possible that, like that of Mount Lincoln, it stands over a channel of eruption, but the evidence of this was not considered strong enough to justify its being indicated on the plane of the section.

On the north face of Mount Bross, towards Cameron amphitheater, the base line of the Paleozoic formations can be traced with tolerable distinctness. Of dikes crossing the formation, like those on the face of Mount Lincoln opposite, there are doubtless many, but only one was actually traced, which is cut by the western workings of the Moose Mine. In the Archean below this mine is a prominent mass of light-gray granite. The workings are in the Blue Limestone, which is exposed on the east spur of the mountain between the Cameron and Bross amphitheaters, forming the surface of the spur, until cut off by its steeper slope, whose angle is greater than that of the dip of the beds. This bed is completely honeycombed by abandoned mine workings, but the underlying White Limestone here, as in the Leadville district, seems to have yielded little or no ore. At the foot of the spur, erosion has exposed the quartzite beds of the Cambrian, in which is a prominent dike of porphyry running from the edge of Bross amphitheater a little north of east, in the direction of the summit of Mount Silverheels. It was traced as far as the secondary ridge bordering the Platte Valley into the White Limestone, where it was lost in the forest.

The rock (88) of which it is composed differs from any yet described. Its weathered surface is so white that at first glance it might be taken for the White or Leadville Porphyry. On a fresh fracture it has a light-green color and shows few macroscopical crystals. It has certain resemblances to porphyrite and also to the Silverheels Porphyry, but the microscope shows it to be identical with the quartz porphyry found on Loveland Hill and on the north wall of Mosquito Gulch, which has been described under the name of Green Porphyry.

Bross amphitheater, like those of the other two peaks, lies nearly due east of the summit, but, owing to the steeper inclination of the Paleozoic beds which cap its walls, it has not been carved to so great a depth into the underlying Archean schists, whose outcrops are therefore of much less superficial extent. As in the others, the highest beds exposed in the cliff sections on its walls are those of the Blue Limestone. Shales, probably belonging to the Weber Shale formation, are disclosed in prospect holes along the road which curves round its head, and very possibly a considerable portion of the area which has been given the color of porphyry on the map may prove by actual excavation to be underlaid by beds of this formation. The road which leads by the Dolly Varden and Moose mines; along the north face of Mount Bross and the west face of Mount Cameron; to the Present Help mine, on the south face of Mount Lincoln, is indicated on the sketch in Plate IX by a light double line, the location of the respective mines being shown by the house outlines. The Dolly Varden mine, on the spur south of the amphitheater, finds its ore in the Blue Limestone adjoining a dike of White Porphyry 40 feet in thickness, which crosses it at an angle of  $60^{\circ}$  with the horizon. Below the Dolly Varden mine the spur slopes more steeply than the beds, and at its base the Parting Quartzite of the Silurian is exposed. In the basin-shaped valley called Mineral Park, south of this spur, erosion must have exposed still lower beds than on the spur, and it is possible that the quartzite beds said to be exposed there may belong to the Cambrian.

The ridge running south from Mount Bross, between Mineral Park and Buckskin gulch, is mainly covered by easterly-dipping beds of the Blue

Limestone horizon. There are several bodies of Lincoln Porphyry, besides the main sheet near the summit, which are not shown on the map, as time did not admit a sufficiently detailed study to determine their outlines or whether they were remnants of this sheet or distinct bodies. The upper part of the Blue Limestone on this spur seems to have been particularly rich in black chert concretions, which now lie scattered over the surface of the ground, and from which Prof. Lakes obtained the following fossils:

*Spiriferina* (sp. like *S. Spergenensis*).  
*Spirifera Rockymontana*.  
*Productus costatus*.  
*Euomphalus* (sp. ?).

*Athyris subtilita*.  
*Streptorynchus crassus*.  
*Pleurophorus oblongus*.

These were mainly collected in a slight depression of the ridge, where the overlying porphyry had been eroded off, and therefore must have come from the upper part of the horizon.

The lower Paleozoic beds are exposed in section at various points along the steep western wall of this spur, which faces Buckskin gulch. They were examined at two points. At the extreme southern end of the spur, just above the town of Buckskin Joe, where the steeper eastern dip of the formation comes in, several ore bodies have been discovered, and the now abandoned mines (the Excelsior, in White Limestone, and the Criterion, in Lower Quartzite) were once worked. At the Criterion mine a thickness of 150 feet of quartzites was measured between the Archean and the first bed of White Limestone. The ore bodies are accumulated here along vertical planes, running northeast and southwest, which seems to be the direction of a dike of dark-green decomposed porphyry, whose outcrops are found in the ravine below the mine, near the contact with the Archean. There is evidence also of a slight displacement along a plane running northeast and southwest, whose upthrow is to the west. At the Excelsior mine, which is about a quarter of a mile farther west, near the point of the cliff in the angle of the gulch, the ore bodies follow similar and nearly parallel planes. A section measured on the cliff near the mine gave the following thicknesses, in descending series:



	Feet.	
	Blue Limestone, covering surface of spur . . . . . ?	
Silurian . . . . .	{	Parting Quartzite (exposed in prospect holes) . . . . . ?
		White Limestone, partly covered by débris, estimated . . . . . 200
		—
Cambrian . . . . .	{	Shales and sandy limestones . . . . . 35
		Gray quartzite, impregnated with metallic mineral . . . . . 20
		Massive white quartzite . . . . . 6
		Greenish quartzite, with calcareous layers . . . . . 8
		White saccharoidal quartzite . . . . . 10
		Greenish-white, compact, thin-bedded limestone . . . . . 3
		White saccharoidal quartzite . . . . . 55
	— 137	
Archean . . . . .	?	

The limestone bed in this section is of interest as being the only one examined from this region which was not a dolomite. It contained 25.48 per cent. carbonate of lime, 4.03 carbonate of magnesia, with traces of chlorine, the residue being mainly silica. It has already been noted that the Cambrian beds in their upper part are often more or less calcareous, but generally resemble a sandstone on the surface, whereas this bed has the compact, even texture and clean fracture of a limestone. The strata at this point dip  $15^{\circ}$  to the east, with a strike a little east of north.

**Red amphitheater.**—Nearly under the summit of Mount Bross and high up on the east wall of Buckskin gulch is the Red amphitheater, a semi-circular recess in the cliff-wall nearly a thousand feet above the bed of the valley. The scale of the map does not permit an adequate expression of the form of this remarkable basin, which is rendered still more prominent by the brilliant red and yellow coloring of its walls. This color comes from a thin coating of ochereous clay, which covers the rock fragments of débris piles, and which contains, besides oxide of iron, traces of arsenic, antimony, and sulphur. The rock fragments thus coated are so much decomposed that it is seldom possible to determine their original character, and it would have taken much more time than was available to thoroughly decipher the geological history of this remarkable locality, which has evidently been the scene of long-continued metamorphic action, probably a sequence of the eruption of the igneous rocks now forming dikes and intru-

sive sheets in the Archean and overlying Paleozoic beds. The results of the metamorphic action are shown, not only in the decomposition and coloring of the rocks above mentioned, but in the marbleizing of the limestones and the large development of serpentine within these limestones.

The eruptive bodies developed here consist, besides the large body of Lincoln Porphyry near the summit of Mount Bross, first, of a considerable body of augite-bearing diorite (96), which cuts through the Archean from the valley below up into the bed of the amphitheater, and either spreads out along the base of, or extends into, the Cambrian beds under the talus slopes of débris; secondly, of a dike of White Porphyry, crossing Silurian and Carboniferous limestones in a vertical direction; thirdly, of several thin intrusive beds of green and much-altered quartz-porphyry, parallel with the stratification. It is only on the south side of the amphitheater that a continuous cliff-section of the Paleozoic beds is exposed, and here the top of the Blue Limestone and the base of the Cambrian are each covered by surface accumulations. One principal and several smaller faults can be distinguished on the cliffs, in each of which the upthrow is to the west, but the amount of displacement is only slight. The Colorado Springs mine is opened on this cliff, near the base of the Blue Limestone, from which rich ore in small quantities has been obtained. The following section was made, by means of a pocket level, on the cliff just south of the mine and near the dike of White Porphyry above mentioned:

	Feet.
Lower Carboniferous	Black cherty limestone..... 50
	Blue-gray limestone ..... 50
	Light-blue limestone..... } 60
	White marbled limestone..... }
	Light drab limestone with serpentine..... }
	— 160
Silurian	White and greenish quartzite ..... 40
	White limestone..... 10
	Light-bluish limestone ..... 40
	Green porphyry, 20 feet.
	White limestone..... 10
	Blue-gray crystalline limestone ... 40
	Light-colored limestone with serpentine ..... 30
	— 170

	{	Dark-green serpentine .....	10	
		White limpid quartz .....	15	
		Yellowish-green serpentine .....	1½	
		Green porphyry, 4 feet.		
		White quartzite .....	10	
Cambrian.....	}	Green porphyry, 20 feet.		
		White quartzite .....	10	
		Green porphyry, 5 feet.		
		White quartzite .....	40	
			86½	
	{	Intrusive mass, disturbing strata and disappearing under débris .....		(?)

Neither the top of the Blue Limestone nor the base of the Cambrian is reached in this section, and to the aggregate thickness given an unknown amount, probably in the neighborhood of 200 feet, should be added. At the head of the amphitheater above the Blue Limestone is a very thick body of Lincoln Porphyry, above which, on the summit of the ridge and separated by a low saddle from the main summit of Mount Bross, are intensely altered shales, frequently chloritic, belonging to the Weber Shale formation.

The development of serpentine, which elsewhere seems confined to the "sandy limestones" of the upper part of the Cambrian, here extends, though on a minor scale of development, a short distance into the silicious beds below and up as far as the base of the Blue Limestone. The serpentines obtained from here are remarkably beautiful rocks, grading in color from a homogeneous yellow to a dark green, mixed with gray and having the general effect of a veined verd-antique, although more critical examination shows that the green and gray or yellow are a simple shading off and intergrowth. In some cases thin, vein-like sheets seem to cross the strata, though in general the development of serpentinous material is parallel to the stratification. Under the microscope they are seen to contain a very considerable amount of calcite, an appearance which is confirmed by chemical analysis. The development of serpentine is apparent, in looking at the cliffs from a little distance, as a lenticular-shaped body, giving at first the impression that it causes an actual thickening of the beds; but the measurements given by the above section show that this is not the case, and the chemical examination, which is discussed in Chapter VI, shows that this

mineral is the result of a change within the rocks themselves, and, probably in great part, of the alteration of pyroxene and amphibole in the limestones.

**Eastern foot-hills.**—The higher part of the Lincoln massive thus far described may be considered structurally to form part of the crest of an original great anticlinal fold, inasmuch as the average inclination of the beds is comparatively small. The wooded ridges between the foot of the steeper slope and the Platte Valley, which form a low shoulder to the Lincoln massive, and where steeper dips prevail, would form the actual eastern member of the fold. On the ridge between Quartzville and Montgomery, for instance, the beds dip as steeply as  $45^{\circ}$ . South of this a wider region is included between the outcrops of Blue Limestone and the Platte Valley, and, were the steep dips continued without interruption, an immense thickness of beds would be represented. There are reversed dips found, however, notably in the ravine below Quartzville and in Buckskin gorge above Alma, which give evidence of the existence of a secondary flexure parallel to the main fold, a sort of minor ripple following at the heels of the great breaker or wave which caused the main uplift of the range, such as is almost invariably found along lines of great plication. Another noticeable feature in the structure is a decided change of strike, which commences opposite the east spur of Mount Bross, or between the Bross and Cameron amphitheatres. North of this line the average strike of the beds is north or a little east of north; south of it the strike bends more and more to the east of north; and on the southeast slopes of Bross the strata have a dip with the slope to the southeast.

The outer wooded ridge above mentioned is composed of coarse sandstones of the Weber Grits formation and of various intrusive bodies of porphyry. Porphyry bodies similarly situated were observed on four distinct section lines followed across this ridge, but the assumption that they form part of a continuous body, as indicated on the map, is here, as in the case of those on the east side of the Platte Valley, not founded on the tracing of a continuous line of outcrops, as in the cañon sections. They generally belong to the Lincoln Porphyry class. That found in the ravine above Dudley in considerable thickness has the round pink quartz grains, but wants

the striking large orthoclase crystals of the Lincoln Porphyry. The actual line of contact of Blue Limestone and Weber Grits, occurring generally in the covered gap of the depression between the ridge and the steeper mountain slope, was seldom observed. It was therefore impossible to determine whether the sheet of Lincoln Porphyry, which occurs above it on the higher part of the mountain mass, extended eastward as far as the foot-hills or not. Some outcrops of porphyry were observed which might have belonged to a continuation of this sheet, but no facts of sufficiently definite significance were obtained to justify its indication on the map.

A good section of these outlying ridges is obtained in the narrow winding gorge of lower Buckskin Creek for about a mile above Alma. The beds of the Weber Grits formation exposed along the walls of the valley, which lie within the forest-covered belt, show much more decomposition and disintegration than is found in the same beds above timber line. They consist of coarse micaceous sandstones, with a considerable development of argillaceous shales, also micaceous, and one or two thin beds of gray limestone. Among the shales is conspicuous a black carbonaceous bed, and the limestone is supposed to be that which occurs at about the middle of the formation and which outcrops again in the wooded hills east of the Platte Valley. The sandstone which immediately underlies the town of Alma itself, and which is made up of grains of quartz about the size of duck-shot, with considerable muscovite, might be mistaken at a little distance for a decomposed granite. It shows but few bedding planes, and, though in excavations for buildings it stands as a straight wall, when broken down it crumbles at once into coarse sand.

**Buckskin amphitheater.**—This immense basin at the head of Buckskin gulch bears the same relation to Mount Bross that the Platte amphitheater does to Mount Lincoln, the two separating the Lincoln massive from the main crest of the range, with which it is connected by the dividing ridge running from Mount Cameron to Democrat Mountain.

An excellent exposure of the Archean formation is afforded in its steep walls, which rise 1,500 to 2,000 feet from the bottom of the basin and are capped on the eastern side by a thin covering of Paleozoic beds. The rocks are mainly gneisses and amphibolites, with local developments of

granite, through which run irregular vein-like masses of white pegmatite. The latter are particularly prominent on the northeastern walls of Buckskin cañon, a short distance above the town of Buckskin Joe. In the bottom of the upper part of the basin is a small lake, above which a dike of hornblende diorite forty to fifty feet wide runs across the basin in an easterly direction from the base of Democrat Mountain and disappears under the débris slopes on the other side.

At the south base of Democrat Mountain are three small lakes or tarns, on a raised shoulder or knoll of granite, back of which is a small raised basin extending to the base of the mountain. This granite is of the fine, even-grained type without large porphyritic crystals, almost white in color, and contains both biotite and muscovite. It is traversed by many small veins of pegmatite, consisting of orthoclase and quartz and often having a regular banded structure, like that shown in Fig. 2, Plate IV, which is from a sketch of a boulder standing near the lake.

In this raised basin many eruptive dikes, mainly of porphyrite, were observed, only a few of which it has been possible to delineate on the map. These porphyrites belong to the types carrying either mica or hornblende and mica. They occur frequently in the form of interrupted dikes. That found near the uppermost of the lakes contains both hornblende and mica, with considerable quartz, and is remarkable for the numerous fragments of Archean rocks included in it. One of these fragments was several feet square and penetrated in all directions by veins of porphyrite, in which a distinctly fluidal structure of the elements of the porphyrite about it could be observed.

Near the middle lake is a dike of White Porphyry, a fresh and compact variety of the Leadville rock; fragments of the same rock are abundant in the débris pile at the head of the gulch.

One of the porphyrite dikes, which dips  $30^{\circ}$  to  $40^{\circ}$  north, can be traced to the south shoulder of Democrat Mountain, which forms the divide between this and the Platte amphitheater, and apparently connects with the long dike, which can be traced as a thin black line high up along the eastern wall of the latter. A double dike of similar appearance occurs further south on the same divide, near the north base of Mount Buckskin.

On the south wall of this raised basin under Mount Buckskin the white granite disappears and is replaced by gneiss and hornblende schists, which show a remarkably contorted structure. Running nearly parallel to this wall, and forming its face in certain parts, is a dike, thirty to forty feet wide, of mica-diorite. It projects out into the valley in the direction of the Red amphitheater, but could not be traced on the east side.

*North Mosquito amphitheater.*—The Archean exposures at the head of the north branch of Mosquito gulch may properly be mentioned here. They consist of the same general character of rocks—gneiss, schist, and granite. On its north wall the irregular shading of the dark mass produced by the white pegmatite veins is particularly prominent. The coarse-grained red porphyritic granites are more common lower down the cañon, while towards the crest of the range the fine-grained, eruptive-looking granite is found, and apparently extends through to the west side at the head of Bird's Eye gulch.

In the neighborhood of the little lake in this basin many dikes, often of the interrupted form, were observed, the more important of which have been indicated on the map. East of the lake, in the center of the amphitheater, is a dike of Mosquito porphyry, similar to the dike No. 2 on the south face of Mount Lincoln, though of somewhat lighter color, owing to a difference in the mica, and containing more ore in small specks. The oxidation of this ore gives a brown color to the weathered feldspars, which when fresh have a faint pink color. Under the microscope the groundmass is seen to be fully microcrystalline. The apatites are dusty. The only mica seems to be muscovite, which, judging from the associated yellowish grains and rarer needles, has come from biotite. Part of the ore seems to be magnetite, and part is entirely decomposed. The quartz grains contain fluid inclusions. This porphyry is cut in one place by a mica-porphyrityte, which is a light-colored rock, containing numerous feldspars in a dark-gray groundmass, with some hexagonal plates of dark-brown biotite. Quartz, in quite large grains, can be distinguished by close examination. Single grains of pyrite are scattered through the rock. Striations are distinctly visible on many feldspars. Under the microscope plagioclase is seen to largely predominate and the biotite to be quite fresh. The groundmass, which is fully crys-

talline, is composed of very uniform minute grains of quartz and feldspar, with mica in opaque dots, and intrudes in bays into the quartz grains, which are quite free from inclusions.

To the northeast of the lake a considerable body of quartz-mica porphyrite was observed; but its exact form, whether a large dike or an isolated mass, could not be determined. It closely resembles the rock already described from the knoll south of Democrat Mountain. It is extremely fine-grained, but of very dark color, owing to the large amount of biotite, and contains no hornblende. Many other eruptive dikes were observed on the face of the cliffs, which time did not admit of studying carefully. Prominent among these is a dike or sheet of dark porphyrite, cutting the ridge which divides the upper part of the amphitheater into halves.

#### MIDDLE-EASTERN DIVISION.

This division includes the eastern slopes up to the crest of the range, from the line of lower Buckskin Valley south to that of Horseshoe or Four-Mile Creek. The region is crossed diagonally by the line of the London fault, which divides it into two parts in such a manner that there is a repetition of the same series of sedimentary beds exposed in the cañon sections on given transverse lines.

**Glacial erosion.**—Evidences of glacial erosion are abundant in the valleys of all the streams flowing from the crest of the range, but the data afforded by Buckskin and Mosquito gulches is so definite as to seem worthy of special mention. As the map shows, the two valleys are nearly parallel and similar in general form, in that their main course in the Archean rocks is southeast, the glaciers which originally filled them having been fed by a very broad névé-field, filling two or more less distinct basins at their head, and that in their lower course, where they reach the upturned edges of the Paleozoic strata at the line of their steepening dip, they bend sharply to the east and cross these strata approximately at right angles to their strike. Just above the bend a raised bench or shoulder is found on the south side of either cañon, several hundred feet above its present bottom, which is evidently a portion of a former valley bottom, and marks approximately the level to which the valley was cut out by the glacier which once filled it.



In Buckskin Cañon this bench, which has been cut across by several minor ravines, is not sufficiently regular to be defined by the contours of the map, although it is readily apparent to the eye. That in Mosquito gulch, however, which forms a practically continuous terrace nearly a mile and a half in length on the north face of Pennsylvania Hill, is shown by the topography of the map, and is about seven hundred feet above the bed of the present stream. It has about the same slope in an easterly direction as the present valley, and this slope carried upward corresponds with the present bottom of the South Mosquito amphitheater above the London fault, which is formed by gently-dipping quartzites and schists of the Weber Grits formation whose angle over a considerable area is about the same as that of the bottom of the basin. On the rock surfaces of the flat portion of this basin glacial grooves and striæ are still distinctly to be seen, showing that but little erosion has taken place since the Glacial epoch. On the other hand, in the neighborhood of the fault and in the Archean rocks below it, the present stream-bed deepens very rapidly and the valley becomes a narrow, winding, V-shaped gorge. In the north Mosquito amphitheater, which is entirely in Archean rocks, the upper part of the basin (which, owing to its great elevation and the consequent low temperature that prevails in it, suffers but little abrasion by running water) remains at essentially the same level as the South Mosquito amphitheater, but the V-shaped cutting by present streams extends back much farther than in the latter. The conclusion to be drawn from these facts is that the eroding force of glacier ice is a power so great as to be comparatively independent of the materials on which it acts, while that of running water varies very greatly with the different forms and characters of these materials. Thus the original glacial cutting of lower Mosquito gulch formed a comparatively straight and regular valley, but the present stream-bed near the mouth of the cañon makes a bend to the south, around a boss of more resisting granite on the north side of the valley, and then is deflected to the north by the upturned edges of the Paleozoic strata which cross its course diagonally.

The Mosquito glacier, as might be expected from its course, left its moraine material mainly on the south side of the valley, where it forms several wooded ridges opposite Park City. It was of greater extent than

the Buckskin glacier, and probably once reached down to the Platte, the actual bottom of the present cañon being from one hundred to two hundred feet lower than corresponding portions of Buckskin gulch. Both Mosquito and Buckskin gulches open out into alluvial bottoms below the cañon mouth, but the stream in the latter soon runs into a narrow, winding gorge, which extends for a mile above Alma. The connection of the Buckskin glacier with the Platte glacier, if it ever existed, must, therefore, have been above the low ridge through which this gorge is cut.

**Buckskin section.** — The most complete and instructive sections of the lower Paleozoic beds and their included sheets of eruptive rock are obtained on the walls of the cañons near their mouths, just before the beds dip down more steeply to the east and disappear beneath the softer slopes of the lower rounded hills or are covered by the alluvial deposits of the streams. That on the south side of Buckskin gulch, just about the deserted town of Buckskin Joe, is represented by the diagrammatic sketch given in Plate XIII. The total height of the cliff above the valley bottom is here about one thousand feet.

The Archean exposures (*a*), occupying the lower portion, are largely concealed by huge talus slopes of débris, which in some places extend up so high as to cover the base of the Cambrian, while the Blue Limestone at the top of the cliff is covered by soil. The portion represented in the sketch shows, therefore, only the Cambrian and Silurian beds and the manner of distribution of the intrusive sheets of porphyry and porphyrite. These are here very irregular as compared with sections elsewhere, which is doubtless due to the fact that they are near the northern limit of the bodies, and hence that the intrusive power which forced them between the beds was already diminishing in energy. The upper bed is about fifteen to twenty feet in thickness and consists of dark-green hornblende-porphyrity, of the typical variety already described from Mosquito gulch. As shown in the plate, it varies in thickness and often wedges out, its continuation occurring farther on at a slightly higher or lower horizon. At its contact with the bounding sedimentary rocks it becomes more compact, but the sedimentary beds show no caustic phenomena, though they are sometimes slightly contorted. About thirty feet below this is a second intrusive sheet, also

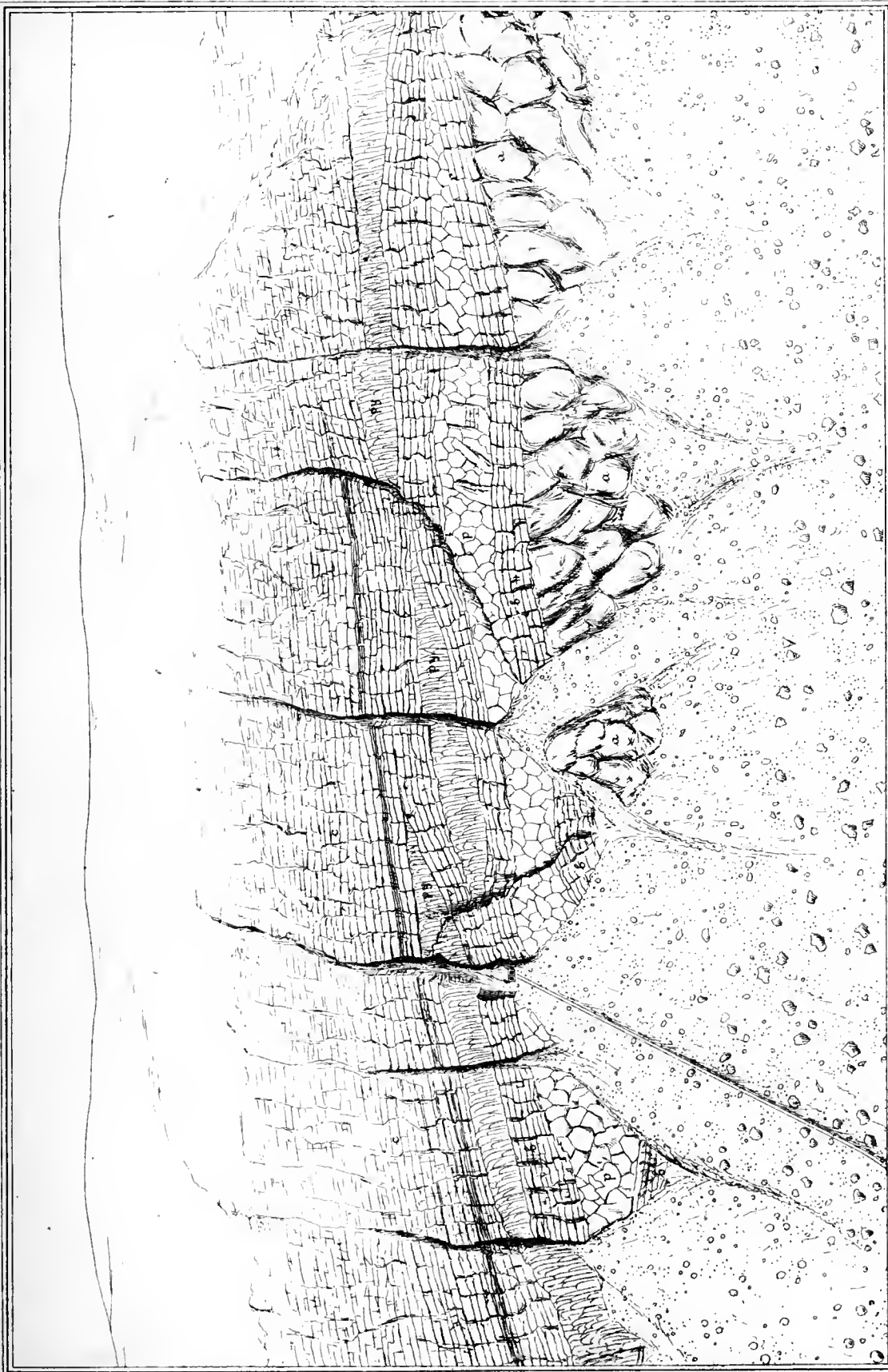

Julius Bien & Co. lith.

S. F. Emmons, Geologist-in-Charge

SOUTH SIDE OF BUCKSKIN GULCH

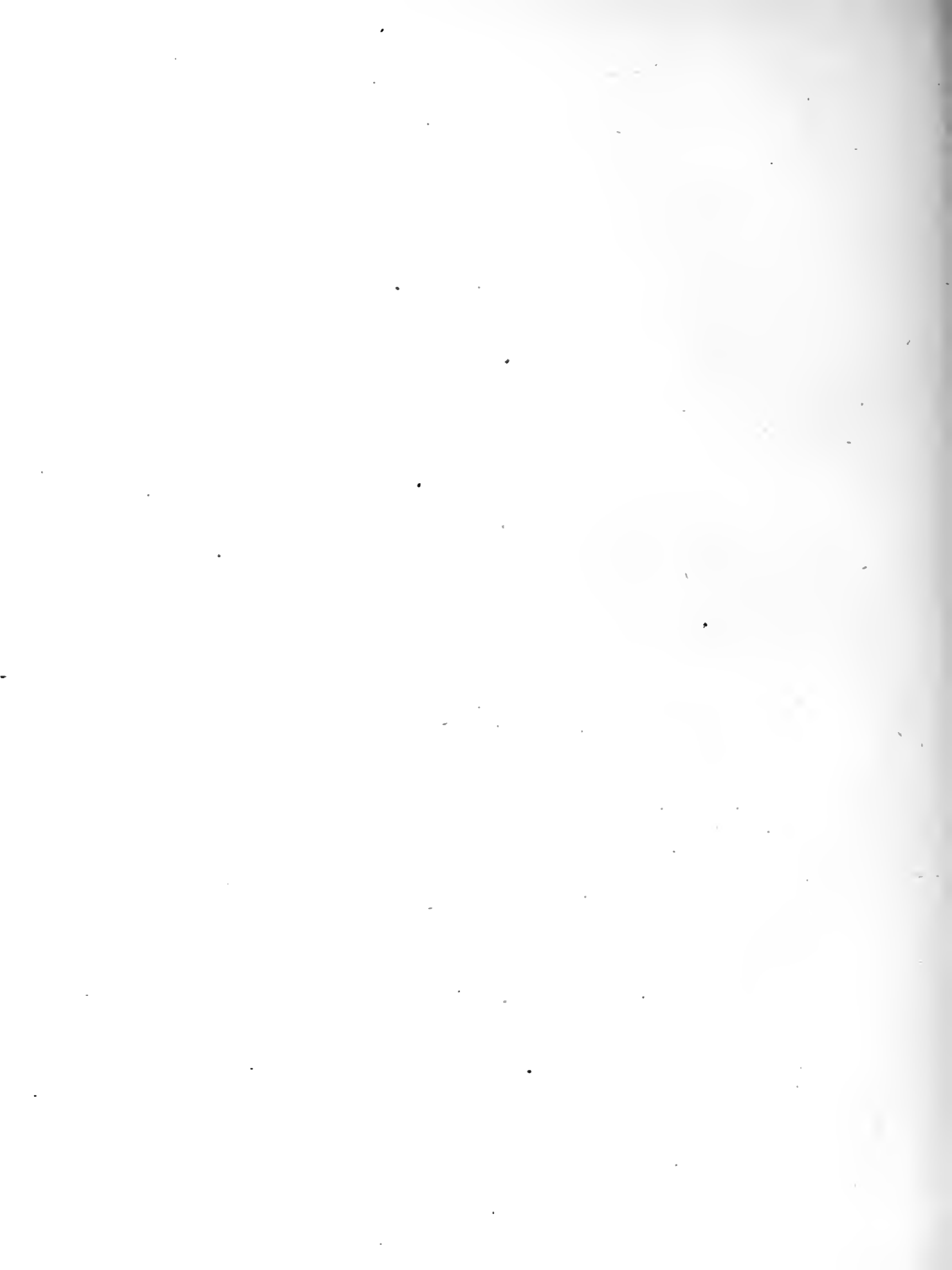

very variable in thickness, of gray quartz-porphry, like the Lincoln, but without its large feldspars and with its basic silicates generally much altered. Between this and the Archean are forty to fifty feet of white saccharoidal quartzite, with a thin bed of fine-grained conglomerate at the base, wherever the base can be distinguished. The Archean here consists of a dark mica-gneiss, approaching a mica-schist in structure.

The dark, more or less perpendicular lines on the sketch represent shallow ravines on the face of the cliff, which are generally fracture planes across the beds, accompanied by a certain amount of dislocation. The principal ravine is that to which the double line over the débris pile (which represents a raised tramway for carrying down ore) leads, and in which are the now deserted workings of the Northern Light mine. This fault had a movement of about fifteen or twenty feet, and the ore seems to have been found in the crevice of the fault. These small faults were probably produced by the general dynamic movement in which the rocks were folded, and it will be noticed in the sketch that the intrusive sheets are faulted in the same degree as the inclosing sedimentary beds. About half a mile west of the point represented on the sketch is a prominent fault on the cliff, with an upthrow to the west of about one hundred feet. The direction of this fault, as of the minor fracture planes in the sketch, is between north and northeast, which corresponds with those observed near the Criterion mine, on the opposite wall of the gulch.

East of the Northern Light mine the beds slope rapidly down in a graceful curve to the bed of the gulch, in which only the outcrops of the harder and more silicious beds project above the gravel. The former mining town of Buckskin Joe, the oldest settlement in this region (now, like its companions, Quartzville and Montgomery, consisting mainly of deserted cabins and mill foundations), is situated on the outcrops of the base of the White Limestone. On the south side of the creek, a little above the town, is the once famous Phillips mine, an open trench, some twenty feet wide and in places as many deep, cut in an immense concentration of iron pyrites along a bedding plane of the Cambrian quartzite. In one place a decomposed quartz-porphry is found on the hanging wall, which apparently cuts across the formation, as it is also found in the creek bed near the bridge at a some-

what higher horizon than the ore body. This porphyry resembles the rock of the lower intrusive sheet shown in the sketch, and may form part of it, though it was not possible to trace the connection between the two.

**Loveland Hill.**—Loveland Hill affords an excellent illustration of the often-observed fact that the deeper transverse valleys often follow the line of a minor or lateral anticlinal fold, while the intermediate hills or more elevated region, which has been relatively less eroded, is the locus of a minor synclinal fold.

On the broad, flat back of this hill or spur, whose slope corresponds very nearly with the easterly dip of the sedimentary beds, is a shallow ravine draining into Mosquito gulch, towards which there is a very perceptible dip of the beds from either side; in other words, the strata dip eastward, and at the same time dip north and south towards the bottom of this valley. The larger part of the surface of the hill is covered by beds of Blue Limestone. The White Limestone comes to the surface at its upper end, and on the sharp ridge which separates the north Mosquito amphitheater from Buckskin gulch are the remains of the lowest quartzite beds of the Cambrian. The Blue Limestone has been extensively prospected for ore, and a number of irregular deposits have been discovered, generally occupying gash veins, or cross joints and fault planes in the limestone. Numerous irregular bodies of porphyry are also found. Time did not admit, however, of a complete study of these beds nor of the ore deposits. The principal facts ascertained will be found in the description of mines in Part II, Chapter V.

The synclinal ravine already mentioned divides the hill somewhat unequally into a northern and a southern portion. The former forms a continuous ridge, which extends down to the junction of Mosquito Creek with the Platte River below Alma. East of the mouths of the cañons this ridge is comparatively low and covered with forests and soil. It is made up of beds of the Weber Grits formation, in which there is evidence of a secondary roll, as shown in Section C, Atlas Sheet VIII. Along the steeper slopes of the spur between Buckskin Joe and Park City are outcrops of a body of quartz-porphry of the Lincoln type, which apparently forms a sheet above the Blue Limestone. These outcrops are not very continuous,

but it seems probable that they are the remains of a sheet that once covered Loveland Hill in an analogous manner to the porphyry sheets on Mounts Bross and Lincoln.

By the erosion of the synclinal ravine above Park City the White Limestone is exposed in its bed with some irregular bodies of porphyry, and the southern half of Loveland Hill, south of this ravine, ends to the eastward in a cliff, at the base of which are exposed quartzites, apparently of the Cambrian formation, in which several ore bodies have been found. From the base of this cliff the formations sweep in a curve across Mosquito gulch and up the north face of Pennsylvania Hill. The Cambrian and Silurian outcrops can be traced in the bed of the gulch, dipping eastward at angles of  $20^{\circ}$  to  $25^{\circ}$ , but the Blue Limestone outcrops are concealed by gravel and alluvial deposits in the widening valley below.

North Mosquito section.—The cliffs on the south face of Loveland Hill afford a section of the lower Paleozoic, with their included intrusive sheets, similar to but even more perfect than that on its northern face toward Buckskin gulch. Thin sheets of interbedded porphyry and porphyrite can be traced along them for nearly two miles in practical continuity. The fault which was observed on either side of Buckskin gulch is not found on this cliff wall, but near the mouth of the cañon is a more remarkable fault, whose direction is at right angles to the one above mentioned. Seen from the other side of the cañon, the strata seem to slope rapidly eastward until they abut against the western side of a little knoll of granite, which projects out into the valley at this point and deflects the stream to the southward. When one actually climbs the cliff, however, it is found that there is a reduplication of the lower part of the beds; that a faulting has sheared or split off a portion of the strata on a southeast line, nearly parallel with the face of the cliff; and that the piece thus separated has apparently fallen down at its eastern end to the base of the cliffs, while at its western end it still maintains its connection with the regular line of outcrops. In Plate XIV is given a diagrammatic sketch of a portion of this cliff toward the eastern end, where the steeper dips come in. In the foreground may be seen the faulted-down beds referred to above, which form a low ridge or shoulder, standing out a little distance from the face of the cliff. Above and back of this ridge the main cliff rises nearly perpendicularly, showing the regular series of Cambrian

and Silurian beds above the Archean, the softer covered slopes on the top of the ridge being underlaid by the Blue Limestone. The section from the commencement of actual cliff slope downwards is as follows:

		Feet.	
Silurian .....	{	White Limestone, not measured.	
		Porphyrite, 25 feet.	
	{	Quartzite and shales .....	50
		Porphyry, 20 feet.	
Cambrian .....	{	Quartzite .....	50
		Quartz porphyry, 10 feet.	
	{	Quartzite ..	25
		Altered quartz-porphyry, 15 feet.	
	}	Quartzite with fine conglomerate at base .....	15
Archean .....		Gneiss .....	140

The upper intrusive bed is the normal hornblende-porphyrite, found also on the opposite side of Mosquito gulch, and already described in the Buckskin section. This bed, as will be observed in the sketch, is at the base of the White Limestone on the right, and above this horizon in the White Limestone on the left. It does not, however, break the continuity of the sedimentary beds in the plane of this section as it passes from one horizon to another, but it wedges out at one horizon and comes in again a little further on, also in a wedge-shaped body, at a slightly higher horizon. The rock of the second intrusive bed has also the external characters of a porphyrite, and has been indicated as such in the sketch; but microscopical examination shows it to belong to the Green Porphyry type. The third bed is a true quartz-porphyry, resembling the Lincoln Porphyry, but without its large feldspars, and corresponds to the sheet in the Cambrian on the Buckskin section. The lowest sheet is also a quartz-porphyry, but so much altered that not much can be said as to its probable type.

On the faulted-down ridge at the foot of the cliff the Green Porphyry forms the top rock, and the main bed of quartz-porphyry below can be readily traced; but the lower one is less distinct.

The chimney-like ravines which furrow the face of the cliff probably follow, as on the Buckskin section, fracture or fault planes. In the one which was examined, the left hand of the three from which the débris piles descend in the sketch, there is a discrepancy of about six feet in the beds on either side.





James Brown & Co. lith.

CLIFFS ON NORTH SIDE OF MUSQUITO GULCH  
SHOWING A FAULT AND INTRUSIVE MASSES OF PORPHYRY

S. F. Emmons, Geologist-in-Charge

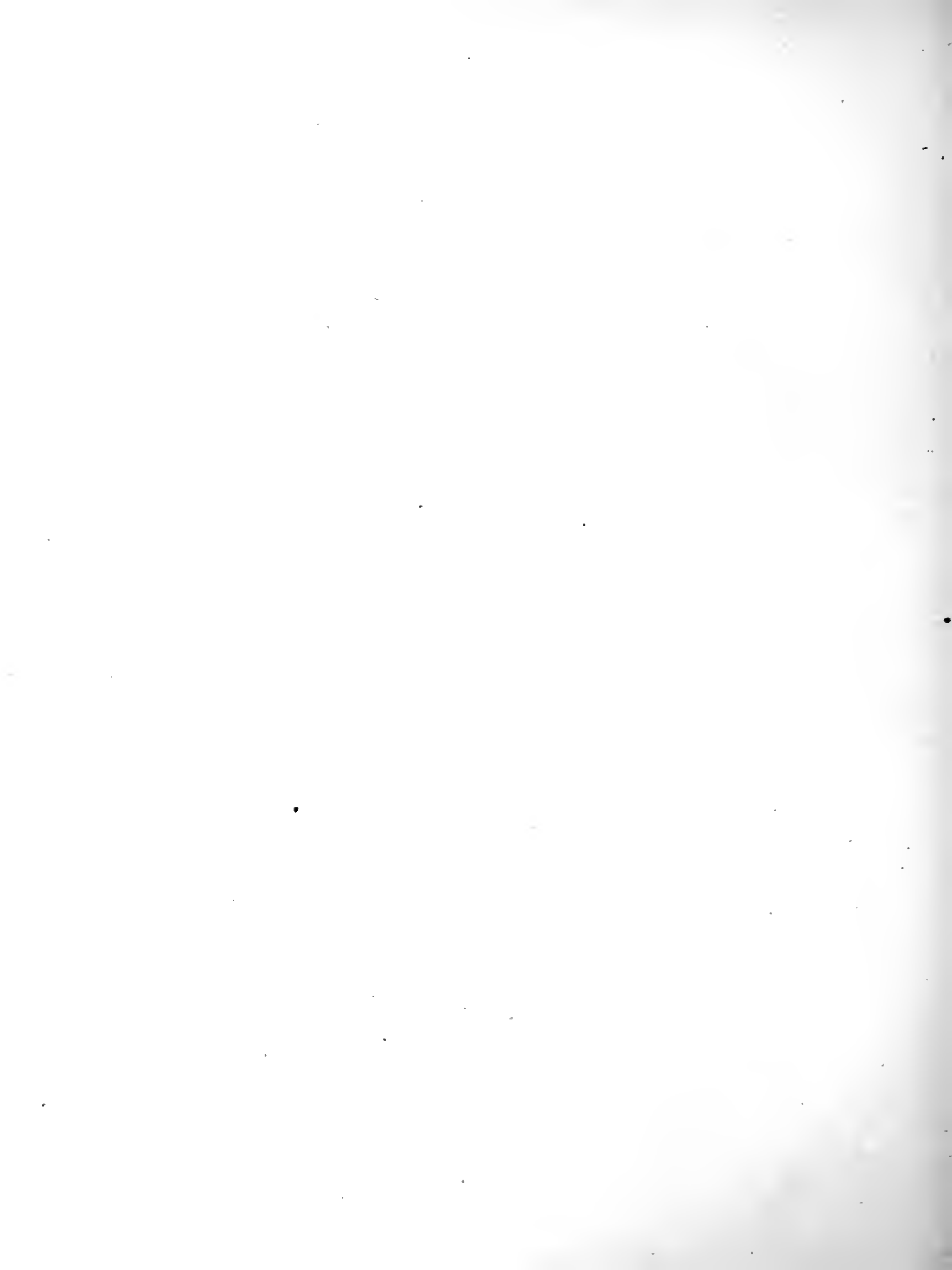

It is to be remarked that, as the scale of the map and sections was too small to show all the intrusive sheets mentioned above, they have there been generalized into two bodies, one of porphyry and one of porphyrite.

South Mosquito section.—On the south wall of Mosquito gulch, opposite the cliff described above, a similar and equally instructive cliff section is found, in which however there is no great fault; only the slight dislocations marked by shallow ravines, common to all the cliff sections. The beds on this cliff were examined in some detail and careful measurements were taken, as it was considered to be a type section. The series from the top of the cliff downwards is:

		Feet.		
Lower Carboniferous	{ Coarse granular gray limestone } with black chert { Blue lighter-colored limestone. } seams ..... { Light-bluish limestone, weathering yellow ..... { Blue limestone, generally thin-bedded.....	60		
		30		
		40		
		— 130		
Silurian	{ White Parting Quartzite, heavy-bedded, coarse at top..... { Porphyrite, 2 feet, thickening to 20 feet farther west. { Limestones, light blue at top, gray semi-crystalline below; more silicious and shaly towards base ... { Very thin blue clay-shales, with shaly quartzite... { White quartzite, more or less calcareous.....	40		
		100		
		10		
		30		
		— 180		
Cambrian	{ Shales, argillaceous and silicious, containing red- east beds ..... { Thin-bedded quartzite, with shale beds few inches thick ..... { White saccharoidal quartzite ..... { Porphyrite, 6 feet (thickens to the eastward). { White saccharoidal quartzite, in beds from 4 inches to 4 feet ..... { Quartz porphyry, 30 feet. { White saccharoidal quartzite, massive above. thin- bedded toward base; often discolored red and brown on surface ..... { Quartz-porphry, altered, 7 feet. { Quartzite, iron-stained ..... { Quartz-porphry, altered, 8 feet. { White quartzite, conglomerate at base.....	12		
		14		
		18		
		30		
		35		
		1		
		40		
		— 150		
		Archean	{ Gneiss, rich in mica..... { Granite, with red tabular feldspars ..	

In the above section the top of the Blue Limestone was possibly not reached, as it forms the surface of the hill, and may have been partially removed by erosion. The thickness given of 130 feet is much less than is found in the vicinity of Leadville. It is readily seen from the varying character of the beds at the base of the Silurian and at the top of the Cambrian that, in the absence of paleontological evidence, it is difficult to draw a definite line between the formations. These beds were deposited at a time when the general character of the sediments was changing from silicious to calcareous, and the rapidity with which the change progressed naturally varied much within comparatively short distances. The Red-cast bed, of which a specimen from this section is figured in Plate V, is the only one whose character is found to be persistent over the whole area, and this has, therefore, been adopted provisorily as the top of the Cambrian. The average strike of the beds is north and south, and the dip varies from a very low angle to  $25^{\circ}$  east.

The rock of each of the porphyrite beds is of the typical hornblende variety figured on Plate VII, Fig. 2. As in other sections, while the porphyrite is continuous on a large scale throughout certain horizons, in detail it is found to be very variable in form, now ending on one bedding plane in a tongue, around which broken masses of the sedimentary beds are distributed like material pushed before the end of a lava flow, and then continued a few feet farther on another bedding plane. Again it appears in small transverse dikes, probably offshoots from the interbedded sheets. Of these the most prominent is at the horizon of the Red-cast beds, standing vertically, with an east and west strike, and 10 feet thick. There are two main sheets of porphyrite. The upper one is only two feet thick in the line of section, and occurs between the Parting Quartzite and White Limestone. As it rises with the slope of the beds to the westward it gradually thickens, becoming 17 to 20 feet thick at the point where it reaches the top of the cliff, and here occurring between the Blue Limestone and Parting Quartzite. The second sheet occurs in the upper part of the Cambrian, being only six feet on the line of section, but thickening to the eastward.

The rock of the porphyry sheets is so much decomposed that it cannot be definitely decided whether it is more closely allied to the Lincoln or to

the Sacramento type, occurring as it does in geographically debatable ground, or about at the limits of the extent of either variety. They occur in the lower part of the Cambrian, the upper sheet being 30 feet thick on the line of the section, above which is a long dike about three feet thick, probably an offshoot from it. The lower sheet, which on this line has a thin bed of quartzite included in its mass, is 15 feet thick, and is found a little farther west without any included quartzite. This lower porphyry sheet extends westward along the north face of Pennsylvania Hill as far as the London fault.

**Pennsylvania Hill.**—This name has been given to the broad, flat-backed spur included between Mosquito and Big Sacramento gulches. Like its neighbor, Loveland Hill, it is the locus of a slight synclinal fold, which forms a shallow ravine on its back drained by Pennsylvania Creek. Excepting along the cliff walls of the adjoining cañons, it affords but few good rock exposures, since its surface and that of the spurs which run down from it to the valley of the Platte are densely covered with forest growth and soil. The varying direction of dips observed in the sandstones of the Weber Grits which form the lower spurs gives evidence of one or more secondary rolls or folds in the outlying strata, as indicated in somewhat generalized form on Sections D and E, Atlas Sheets VIII and IX. The most definite evidence is found on the hill south of Park City, known to the miners as Baldhead. The northeast slopes of the hill and many of the lower hills extending eastward from it are made up of moraine material from the ancient Mosquito glacier. The various porphyry bodies found in this wooded region, of which only the more prominent are indicated on the map, are generally very much decomposed. When their character could be still recognized they were found to belong to the Sacramento type. They have generally a greenish color, due to the peculiar alteration of the basic constituents of the rock. Above timber-line the slope of the hill corresponds so closely with that of the stratification planes that good outcrops are only to be found, as a rule, on the cliff faces to the north, west, and south. The shallow ravine on its back divides it into two portions, on the northern of which the beds have the prevailing strike already observed, viz, about north and south. On the southern portion, on the other hand, the strike is about 20° west of north,

and to this change of strike the synclinal structure observed may be in part due.

Along the northern wall, west of the Mosquito section just described, the Cambrian and Silurian strata form a thin capping to the Archean cliffs. At the western point of the hill decomposed porphyry is still traceable in the Cambrian, but at the very highest point, near the line of the London fault, only White Limestone is found at the surface. This can be seen to bend over in an anticlinal fold before it is cut off by the fault, and a prominent quartzite crag, which will be described later, is assumed to be a portion of the Parting Quartzite which has escaped erosion, standing in a vertical position on the west side of this anticline and adjoining the fault plane.

On the south face of the cliff overlooking Big Sacramento gulch an eminence of the ridge just east of the fault line is capped by a body of Sacramento Porphyry about one hundred feet in thickness. Over this, on the eastern flank of the ridge, whose slope is but little steeper than that of the strata, are further beds of white quartzite, succeeded lower down by the overlying White Limestone. This white quartzite therefore represents the Cambrian formation, and the Sacramento Porphyry an interbedded sheet, here locally developed in unusual thickness. At the foot of the steeper eastern slope of the ridge is found the Blue Limestone, over which is a bed of decomposed Sacramento Porphyry, almost identical with that which is characteristically developed in the Sacramento mine on the same horizon. Zones of decomposition are characteristically marked on this rock by concentric lines, stained red by oxide of iron, the very kernel of the larger blocks sometimes, though rarely, showing the original bluish color of the unaltered porphyry.

London fault.—The region thus far described has been one comparatively free from faults, the movements of displacement being, as it were, within the beds, and generally not more than one hundred feet in amount; movements which have exerted no perceptible influence on the character of the topography and have made comparatively little change in the geological outlines.

South of Mosquito gulch the eastern slopes of the range are divided by one great fault line running diagonally across them, and finally dying out

at the southeastern corner of the map. This is the London fault, so called from the hill dividing the two heads of the Mosquito gulch, through which it passes. Its effects can be readily traced by the traveler who approaches Leadville over the Mosquito pass. The Mosquito pass road, following up the valley bottom of the north fork of Mosquito gulch, winds up the steep west wall of the gulch and, passing through the narrow notch between London Hill and the main crest of the range, ascends gradually in a southwest direction to the Mosquito pass. Up to the point where it reaches the northwest wall of London Hill the rocks around are of gneiss and granite; from there to the summit of the pass is a confused mass of huge loose blocks of coarse quartzitic sandstone and fine-grained porphyry, in which it requires a trained eye to distinguish any definite structure lines, although the change in the character of the rocks is evident to all. Looking south from the road across the broad basin of the South Mosquito amphitheater, the eye is at once attracted by the peculiar appearance of the ridge which forms its south wall. This is the summit of Pennsylvania Hill. As seen from this distance, parallel with the regular and comparatively gentle slope of its surface eastward there can be distinguished along its upper wall a few horizontal lines marking the bedding planes of the Paleozoic strata, below which the steep face of the hill shows no definite structure lines on its rocky surface, save those which mark the talus slopes of broken rock accumulated towards its base. The smooth, regular slope is broken at its crest by a dark knob, around which the rocks are greatly discolored, and the débris from which presents brilliant hues of yellow and red. West of the knob the outline of the hill presents terrace-like escarpments, descending nearly to the level of the amphitheater. The face of this portion of the hill shows regular stratification lines, dipping eastward at an angle of  $20^{\circ}$ , which can be seen with great distinctness to its very base, where they are concealed by the talus slopes. All end abruptly to the east before reaching the discolored knob. This break in the continuity of the stratification lines, or of the beds which they outline, is evident at the first glance, as marking the line of a great fault plane. The evidence of the existence of this fault can be seen with equal distinctness on the walls of the cañon gulches to the south of Mosquito gulch, although in either case the conditions vary, both in the hori-

zon of the juxtaposed beds on either side of the fault and in other structural outlines. Although its existence is so evident, yet its actual position cannot be determined with absolute accuracy, the possible error of location varying under different conditions from ten to one hundred or even two hundred feet. The reason for this uncertainty is found in the fact that the surface rocks in the immediate neighborhood of the fault are generally so much altered and decomposed that their structure planes cannot be traced, and that the fault plane has not been cut by any underground explorations. The direction of the fault, as determined from points where it crosses ridges or gulches, varies from N.  $15^{\circ}$  W. to N.  $45^{\circ}$  W., its average direction being N.  $30^{\circ}$  W. or NW. magnetic. The great S-shaped anticlinal fold which is everywhere found in close proximity to the fault has the same general direction; nevertheless the two directions do not seem to be coincident for any long distance, but diverge a little from each other, so that the fault cuts the fold, now in one part, now in another, but generally west of the anticlinal axis. Thus from Pennsylvania Hill to Sheep Mountain it corresponds closely with the axis of the syncline to the west of the great anticline; south of Sheep Mountain it gradually approaches the anticline, until at the extremity of the ridge both fault and fold die out. North of Pennsylvania Hill the line of the fault has a more easterly direction than that of the fold, and on London Hill it cuts the fold east of the synclinal axis, and a little beyond it may very nearly coincide with the anticlinal axis; but, as the sedimentary beds have been entirely eroded away from above the Archean, it is no longer possible to determine the position of this axis. The amount of displacement occasioned by this fault can only be determined approximately, since the fact of its near coincidence with the anticlinal fold introduces an unknown factor, viz, the amount of apparent displacement that may be due to actual plication. The reason of this can best be understood by reference to Sections C, D, E, F, G, and H, on Atlas Sheets VIII and IX, which are drawn to scale and have been constructed with great care from observed outcrops, dips, and thicknesses of formations. The movement of displacement, as shown in these sections, which is probably a minimum, averages a little over two thousand feet.



The description of the geological character of the region west of the fault will now be resumed in topographical order as it has been carried on hitherto, taking up alternately the cañon sections and intermediate ridges in regular succession as one goes south.

**Main crest from Mosquito Peak to Mount Evans.**—On the main crest of the range, at the head of the south half of the North Mosquito Amphitheater, the fault line is well marked by a sudden change from limestone to a coarse red granite, in the saddle or notch between Mosquito Peak and the peak next north of it. The upper tunnel of the Little Corinne mine, on the north face of Mosquito Peak, is run near the top of the Blue Limestone; above this are 12 feet of White Porphyry, while the lower tunnel of the same mine is in White Limestone. The shales and quartzites of the Weber Grits formation form the summit of the peak, included in which is a thin bed of Sacramento Porphyry.

From Mosquito Peak southward to Mount Evans the main crest of the range is a nearly straight ridge, steeply escarped on the west. At the base of this escarpment runs the Mosquito fault, by whose displacement the Archean schists have been thrust up into juxtaposition with the beds of Weber Grits formation on the west. The beds of the lower Paleozoic series can be traced along the summit of this wall, descending gradually to the southward, until under Mount Evans, in the Evans amphitheater, they are found at the base of the slope. In this extent there is a slight break in their continuity, occasioned by a transverse fault in a little ravine just south of the zigzags of the Mosquito grade. The thin sheet of White Porphyry lying above the Blue Limestone, which is observed at Mosquito Peak, disappears before reaching Mosquito pass; but the sheet of Sacramento Porphyry 10 feet thick, which occurs in the lower portion of the Weber Grits, apparently at the summit of the shale division of this formation, gradually thickens to the southward, and on the eastern wall of the Evans amphitheater it suddenly widens out into a body five hundred to seven hundred feet in thickness. Owing to the sharp contrast of the angular and almost Gothic forms, into which this mass weathers, with the horizontal lines of the bounding sedimentary beds, its outlines can be readily distinguished even from so great a distance as Leadville itself, and would be seen

in the heliotype view on page 6 had the photographic picture been equally distinct with that which is formed on the eye of the observer. At the point where the Mosquito grade descends this steep western wall the Lower Quartzite comes in contact with Weber Grits on the west of the fault, but to the north and south of this point Archean exposures intervene between the base of the Paleozoic and the line of the Mosquito fault

On the crest of the ridge are two irregular-shaped bodies of Sacramento Porphyry at a higher horizon than the sheet already mentioned, which are supposed to be the relics of a second intrusive sheet. The first of these forms the summit of the peak next south of the Mosquito Peak, and can be traced down its eastern slope across the Mosquito grade. The second forms the crest of the ridge for some little distance south of Mosquito pass. In the saddle west of London Hill the road crosses another exposure of porphyry, which is supposed to be the outcrop of the lower sheet of Sacramento Porphyry exposed along the western face of the crest; while in the sharp, prow-like point of London Hill is another interbedded sheet of Sacramento Porphyry, which, as indicated in Section C, is presumed to be a continuation of the upper body, which is found on the crest of the range.

**South Mosquito amphitheater.**—The bed of this basin is formed by coarse sandstones and grits of the Weber formation, dipping  $20^{\circ}$  to the east with its slope. On the exposed faces of these beds glacial grooves and striæ are often very distinct. In the sandstones are various beds of porphyry, and among the débris piles of huge rock fragments split off by ice and frost, which form the steep slopes of the eastern and southern walls, porphyry forms an important element. Time did not admit of tracing out the outlines and relations of all these porphyry bodies, and the structure given on the map and sections, which assumes that the lower sheet which outcrops along the west side of the crest of the range once extended over the whole basin, may be only partially correct.

**Sacramento amphitheater.**—Big Sacramento gulch, like those to the north of it, was once occupied by a glacier, and the amphitheater at its head, like that of the South Mosquito, has been probably but little deepened since Glacial time. The deeper cutting of the present stream extends some little distance above the fault; below the fault line the bottom opens out into

springy meadows and then closes together, as it bends to the southward, between gravelly ridges which are evidently the remains of former moraines and which extend below the junction with Little Sacramento. Owing to the dense growth of forest on these ridges, however, the actual lower limits of the glacier are not easily determined. About a mile above the line of the fault the narrow bottom of the present stream ends in shelf-like terraces of white sandstone, above which the valley opens out into the broad basin of the Sacramento amphitheater. On the face of this terraced wall, and about opposite the western point of Pennsylvania Hill, are two dolomitic limestone strata: the lower one, a dark-gray semicrystalline rock, with clayey seams, is about ten feet in thickness; the second, sixty feet above this, is only six to eight feet in thickness, of similar color and also associated with clay shales, the intervening beds being of coarse Weber sandstones. Among the fossils found here were identified

*Productus costatus* and *Athyris subtilita*.

Ascending the stream farther, successive beds of white sandstone are crossed until the great body of Sacramento Porphyry is reached, which in a probable thickness of twelve hundred feet forms either wall of the amphitheater. The upper extremity of the amphitheater was not explored, but from information and specimens furnished by Mr. J. T. Long sufficient evidence was obtained to justify the indication of an outcrop of Blue Limestone below the Sacramento Porphyry at its deepest part. The fossils obtained by him from here, besides the uncharacteristic *Athyris subtilita*, included the new *Spirifera*, like *Spirifera Kentuckensis*, which has not yet been found at a higher horizon than the Blue Limestone. Among minerals small yellow crystals of pyromorphite were found with the specimens of ore obtained from this horizon.

**London Hill.**—The line of the London fault crosses London Hill diagonally about seven hundred feet west of the summit, in such a manner that the greater part of the steep northern slopes is occupied by Archean rocks, with only the extreme eastern end made up of easterly dipping quartzites of the Weber Grits formation, whereas on the south side the latter extend over two-thirds of the lower slopes. From the saddle north of Mosquito Peak the London fault runs southeast to a point in the raised basin north of the

London mine, then bends more to the southward across London Hill. Under Mosquito Peak the beds lie in a shallow synclinal, with the Blue Limestone rising up gently to the eastward against the line of the fault. On the southeast slope of this peak the limestone forms a cliff wall, rising abruptly above the granite on the other side of the fault, thus affording another illustration of the fact that flat beds resist erosion more from the fact of their horizontality than from any greater resisting power of the materials which compose them. Half way between Mosquito Peak and London Hill, near the New York mine, a thin bed of White Porphyry is found at the base of the cliff under the limestone; the outcrops of the formations cannot be traced continuously to London Hill, as its lower-slopes are covered by a great thickness of débris.

The London mine at the time of visit was opened by two tunnels, one above the other, a short distance west of the line of the fault. The lower tunnel, at the base of the hill, after passing through a great thickness of débris, consisting of large rock fragments frozen into so solid a mass as to require blasting, follows the stratification planes of nearly vertical beds of light-colored limestone, whose strike is a little more to the west of north than the direction of the fault plane. The dip of the strata is a little west of the vertical. Between the beds of limestone is a compact White Porphyry, which can in the mine hardly be distinguished from the limestone, especially as it effervesces with acid; it contains, however, occasional dark flakes of mica, and chemical tests placed its character beyond a doubt, though it contains a percentage of soluble matter, mainly carbonate of lime with a little magnesia (10 per cent. in the specimen tested), which is too high to have come from the decomposition of feldspar alone, and must, therefore, be supposed to be an infiltration from the inclosing limestones. The limestones adjoining the porphyry to the east are very light colored and contain over 10 per cent. of silica, which is about the normal percentage of the upper part of the White Limestone. As the ore deposits follow the stratification planes, not much exploration has been done across the strata, and owing to the metamorphosed condition of the rocks exact determinations of horizon were not practicable. It may be assumed, however, that the ore deposits of the London mine occur in the upper part, if not at the

very top, of the White Limestone. On the hill above, it can be seen that the fault line crosses the ends of the upturned strata at a very acute angle.

The point where the easterly-dipping Weber Grits beds change their inclination to a sharp western dip, as they must to allow of the coming up of the underlying Blue and White Limestones, as shown in Section C, is not very sharply defined. Some beds of Blue Limestone can be distinguished between them and the fault line, but, while there was not time for exact measurements, and these could hardly have been made without a map, which was entirely wanting at the time of field work, it seems most probable that these upturned beds have been actually compressed against the fault plane to a smaller thickness than they have in a more horizontal position.

The southwest slopes of London Hill contained no mine openings, and were too much covered by soil and débris to show clearly defined structure lines, though the sandstone beds of the Weber Grits formation were seen to change their dip from  $20^{\circ}$  to  $50^{\circ}$ . At the point where the old wagon road descends into the deeper valley of the south fork of the Mosquito gulch the actual fault line can be distinguished, a tunnel having been run in the decomposed and highly metamorphosed slates and quartzites, which here directly adjoin the granite beyond the fault. This point of contact bears only  $10^{\circ}$  W. of N. from the dark crag on Pennsylvania Hill, which is nearly on the line of the fault. It is evident, therefore, that there is a sharp bend in the direction of the fault at this point, even more marked, perhaps, than that which is indicated on the map, though, as the position of the tunnel has not been determined instrumentally, nor the old road located on the map, it is not possible to fix absolutely the position of this bend. Here for some distance to the west of the fault line the strata stand not only vertically, but have an inclination of  $50^{\circ}$  to the west; the strike, however, is approximately the same as elsewhere, viz, about N.  $20^{\circ}$  W. Thicknesses of about two hundred feet of vertical strata are exposed, so much altered that their lithological character can with difficulty be distinguished. They include shales and some silicious beds, with one bed of limestone. A short distance to the west of the fault the characteristic sandstones of the Weber Grits are met, with the regular dip of  $20^{\circ}$  to the northeast. It seems evident that the structure here is the same as that just described at the London

mine, viz, that these much metamorphosed and vertical beds are the lower Paleozoic strata coming up from under a sharp syncline, compressed and altered beyond recognition by the dynamic movement at the time of and subsequently to the faulting. This would seem at first glance to be an explanation inconsistent with that which is offered for the conditions which obtain on Pennsylvania Hill, on the opposite side of the gulch; but the fact that the fault line comes in the one case east of the synclinal axis and in the other nearly coincides with it, and the supposition that compression subsequent to the faulting has not only produced sufficient heat to alter the original character of the beds, but has steepened the dips of the already inclined beds and actually made them thinner, sufficiently explain the apparent incongruity.

**Pennsylvania Hill west of London fault.**—The western end of Pennsylvania Hill, through which the London fault runs, is deserving of detailed description. Its structure is shown in section D, with the ideal position of the beds in depth. The observed facts are these: Ascending the wedge-shaped western point of the ridge from the saddle which divides South Mosquito from Sacramento amphitheater, one crosses a regular series of sedimentary beds, dipping  $20^{\circ}$  to the eastward, with two interbedded sheets of porphyry apparently conformable with the sedimentary beds. The ridge has almost perpendicular walls both to the north and south, on which the structure lines can be distinctly seen. The horizon of the beds which cap the dividing saddle at the base of the ridge is estimated to be 150 or 200 feet higher than the limestone beds which occur about the middle of the Weber Grits formation. About half way up the steep western slope, which is mainly composed of coarse sandstone with some few intercalated beds of shale, is a body of interbedded Sacramento Porphyry, of a thickness of 15 to 20 feet. Near the top of this steeper slope is a bed of black sandstone, composed of white quartz sand and fine grains of carbonaceous material in the nature of anthracite or graphite, which is very characteristic of this formation. The very summit of the steeper ridge is formed by a second body of porphyry, a fine-grained gray rock with conchoidal fracture, resembling the Silverheels Porphyry, whose thickness is 25 to 30 feet. Above the steeper slope of the ridge the surface is nearly flat and widens out so that the succeeding

beds can only be observed along the cliff faces. Above the porphyry is a body of purple silicious shales, succeeded by white sandstone, with an occasional band of black sandstone similar to that already described. Prominent among these sandstones is a very coarse conglomerate, with large pebbles of quartz and fragments of Archean schists and granite. As one proceeds east the dip of the beds steepens slightly, perhaps to about  $25^{\circ}$ , till, on approaching within two hundred yards of the fault, it changes—apparently with great suddenness—to a practically vertical angle. At the same time the beds are found to be greatly decomposed and stained a reddish-yellow color. These beds being much more readily disintegrated, the structure lines, when seen close to, become indistinct, being masked by débris. They consist, as well as can be determined, of shales and sandstones, with one belt of blue limestone, immediately adjoining the dark knob on the west, which has a thickness of about eight feet, adjoining which is a bed of White Porphyry. The dark knob, which forms so prominent a feature on the north wall of the hill, is white quartzite, 50 feet or more in thickness, which on its eastern side is singularly altered. It has here become a light frothy mass of cavernous quartz. Careful examination shows that this quartzite, though the main mass stands vertical, probably arched over to the eastward, and therefore forms a part of the anticlinal fold which adjoins the fault on this side. The flat summit of the hill east of this point is made up of beds of White Limestone, included in which is a reddish decomposed porphyry. The actual curving of the White Limestone can scarcely be distinguished, inasmuch as decomposition has proceeded so far in the crest of the fold that a shallow ravine scores off the face of the hill adjoining the quartzite knob, in which all structural lines are obliterated by the sand resulting from that disintegration. Steep as are the north slopes here, it is useless to search for the actual fault line or the structure lines on either side of it. East of the fault there is no difficulty, and the Cambrian and Silurian beds overlying the Archean can be traced continuously along the wall of Mosquito gulch. Aside from the fact that the curve in the beds of this mass of white quartzite can be distinguished, its position adjoining the White Limestone would be sufficient to determine it as the Parting Quartzite, which forms the summit of the Silurian formation; but in the

several hundred feet of vertical beds which adjoin this on the west it would have been difficult, had no other opportunity for studying these faults offered, to determine satisfactorily whether they belong to the series on the eastern or those on the western side of the fault. Blue limestone and White Porphyry are here—the former, it is true, represented only by a comparatively thin bed; and the other metamorphosed rocks might as well belong lithologically to the bottom as to the top of the Weber Grits formation

The actual succession of vertical beds adjoining the quartzite crag on the west is, as well as could be determined, the following :

	Feet.
Gap showing some black shale, about .....	40
White Porphyry .....	20
Blue limestone .....	8
Quartzitic sandstones .....	100
Blue limestone .....	8
Quartzitic sandstones and decomposed greenish argilla- ceous beds, also silicious .....	200

In the description given of faults it is generally stated that the flexing, occasioned by the movement of the faults, is reversed in the beds on either side. For instance, if the strata on the side of the fault that is lifted up are curved down by the dragging or friction of the movement, for the same reason those on the other side, which moves relatively downwards, would be curved upwards; or if, on the other hand, on the upthrow side of the fault the strata are curved upwards—as might be accounted for on the supposition of a force pushing from behind against the fault plane—then the beds on the downthrow side of the fault are curved downwards. This is the generally accepted theoretical explanation of curving of beds adjoining a fault. In this case, however, we have the alternative of assuming that the beds curve downwards on both sides, or, what under the circumstances is even more improbable, that a bed of limestone, which everywhere else in the region examined has a thickness of 150 to 200 feet, has in this single locality been reduced to eight feet. It was assumed therefore, as shown on section D, that these vertical beds, as far as the quartzite crag, belong to the series west of the fault and geologically succeed the Weber Grits in regular order; that is, belong to the Upper Coal Measure horizon.



The correctness of this assumption, so far as the horizon of the beds goes, has been proved by analogy in other localities, as will be described later, notably in the case of Weston fault on Empire Hill, where similar structural conditions exist, but with less intense alteration of the beds adjoining the fault, and where, moreover, the strata of the Upper Coal Measure formation were recognized definitely not only by their lithological characteristics but by abundant fossil remains found in them. The dividing line between the great silicious series of Weber Grits and the Upper Coal Measure formation having been arbitrarily assumed at the first development of calcareous beds, this line has been drawn on the map at the base of the lower bed of limestone mentioned in the above section. A thickness of something over one hundred and fifty feet of Upper Coal Measure beds is thus assumed to have escaped erosion on the western side of the fault.

On the south wall of Pennsylvania Hill, facing Big Sacramento gulch, the beds which outcrop are practically identical with those on the north wall. They preserve the same strike of N. 20° W., with a dip of 20° to the east. The steepening of the dip as they approach the fault line is, however, not so apparent on the north wall of the hill, the surface being to a still greater extent obscured by débris. Near the line of the fault the wall, as on the north side, is scored by a shallow ravine, on whose steep slopes fragments of White Porphyry are mingled with those of almost equally white quartzite. The former belongs evidently to the same body mentioned already as occurring on the north wall to the west of the assumed line of fault. Owing to the uncertainty which exists with regard to the structural relations of this body of White Porphyry, it has not been indicated either on the map or section.

**Sacramento arch.**—The south wall of Sacramento gulch, a sketch of which is given on Plate XV, presents an even more interesting study of the great London fault-fold than that of Pennsylvania Hill. The cliff section, as the sketch shows, presents a broad and rather flat arch, which has but little resemblance to the sharp S-fold already indicated on London Hill or to that which can be distinguished in the background of the sketch on the north face of Sheep Mountain. At first glance the curve on either side of the arch seems to be nearly equal in degree; but a more searching examination discloses on

the right or west a few steep lines, indicating the nearly vertical dip of the beds adjoining the fault which is found at other points. A comparison of the direction of the valley with that of the axis of the fold affords a ready explanation of this deceptive appearance. The plane of the cliff section stands at an angle of  $60^{\circ}$  instead of at  $90^{\circ}$ , or at right angles with the axis of the fold. So that nature has afforded a graphic illustration of the simple problem in descriptive geometry, the diagonal intersection of a cylindrical body by a plane.

The interior of the arch is made up of Archean rocks, mostly gneiss with white vein-like bodies of pegmatite running through it. Over these stretch the entire lower Paleozoic series, with some interbedded porphyries, the principal of which is the Sacramento Porphyry in the Lower Quartzite, corresponding apparently in horizon with that on the north side of the gulch. Blue Limestone, more or less eroded, forms the crest of the hill. On the east side the beds slope away with the angle of the hill at about  $20^{\circ}$ . On the west of the crest, towards the fault, the dip rapidly steepens and becomes vertical before reaching the fault plane. The structure can naturally be best seen on the cliff face. Here as elsewhere the stratified series seems much thinner in a vertical than when in a horizontal position. On the north face the Blue Limestone comes into contact with the fault instead of the Parting Quartzite, as on Pennsylvania Hill. The rock is much shattered and there is considerable development of black chert. Apparently some slight ore deposition has also taken place; but there is no evidence that this is the result of the faulting action. On the crest of the ridge, still east of the fault, are some shales and beds of impure anthracite, characteristic of the lower part of the Weber Grits formation.

West of the Sacramento arch the ridge is level for a short distance, and then rises in a regular slope to the Gemini Peaks, two little projections crowning the ridge opposite the head of Sacramento amphitheater, on the north, and of Iowa amphitheater, on the west. The regularity of the structure lines on the eastern flank or back of this ridge is extremely remarkable and is partially shown in the sketch. The dip of the beds, which to the west of the fault are entirely of the Weber Grits formation, is here steeper than in the adjoining amphitheater, averaging from  $25^{\circ}$  to  $35^{\circ}$ ,

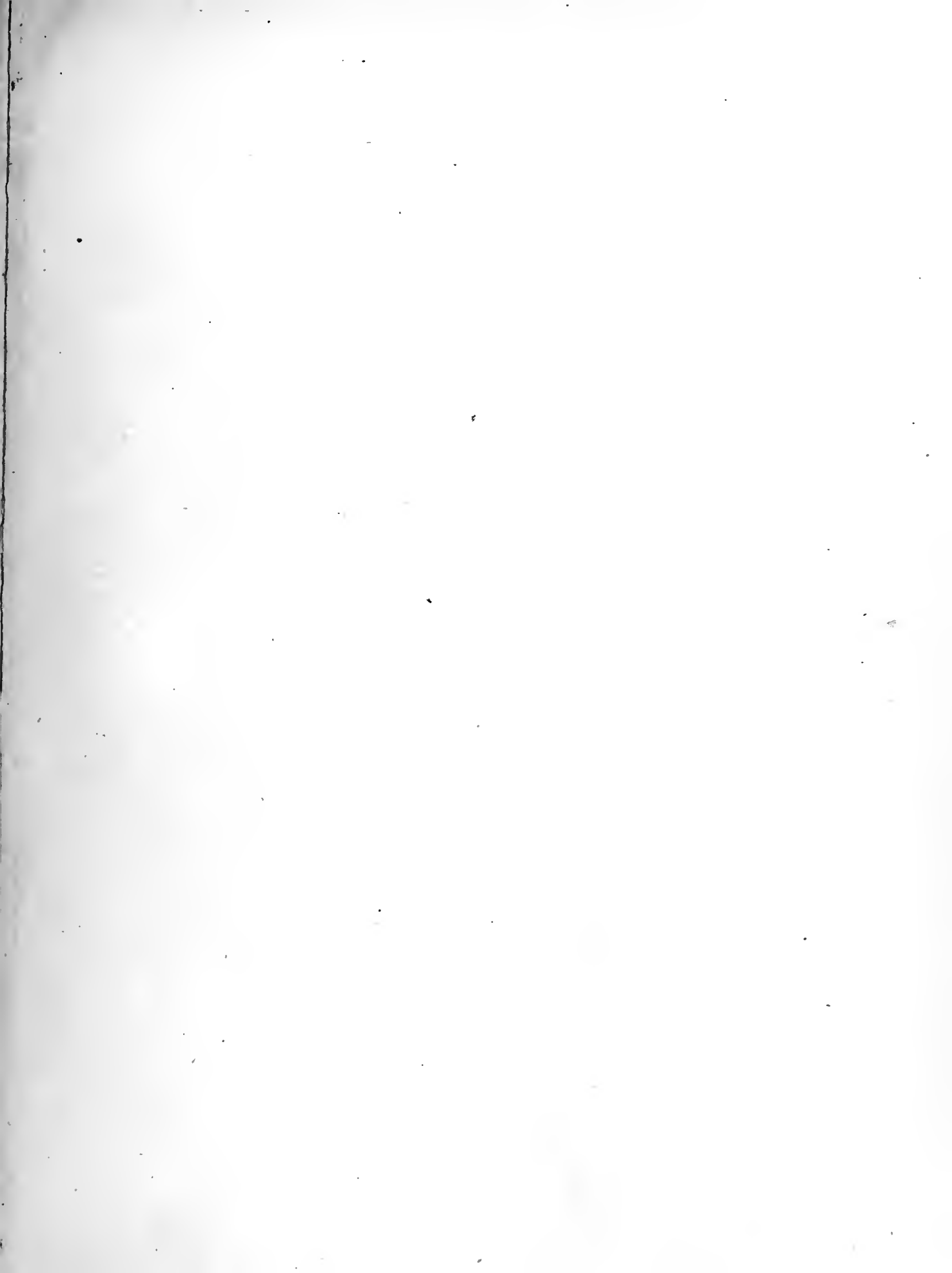

Sheep Mt.

Lamb Mt.

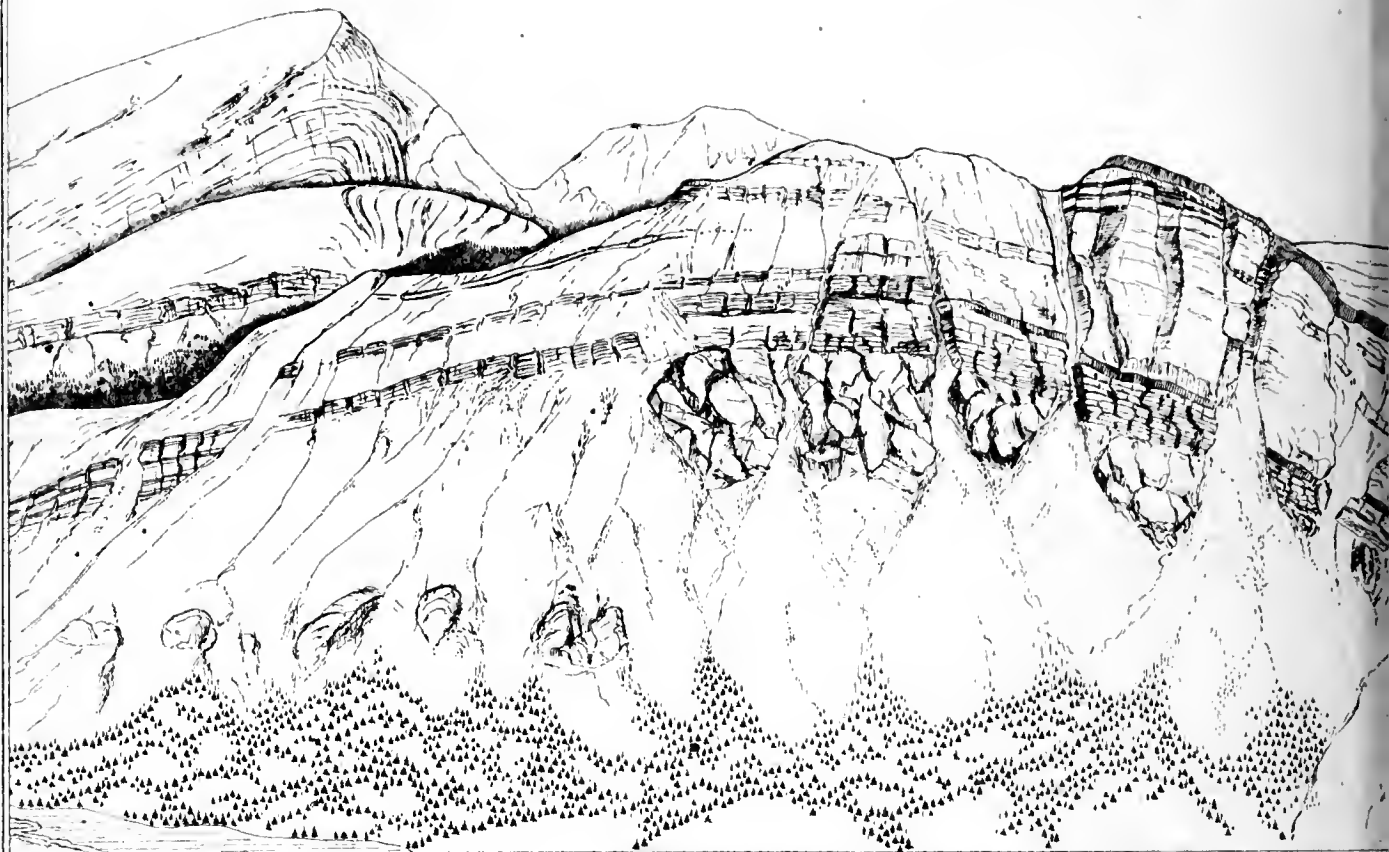

Julius Bien & Co lith

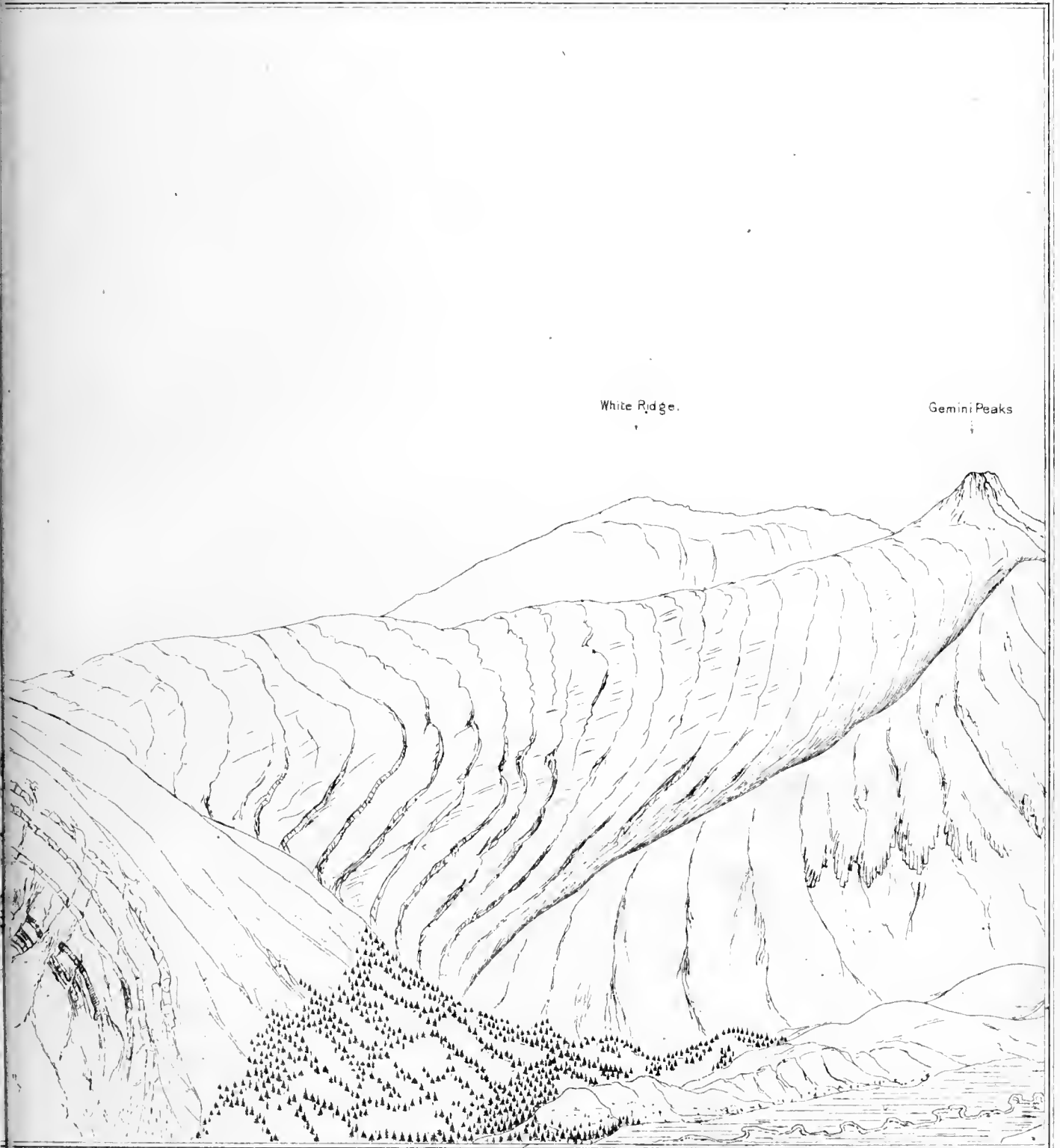

White Ridge.

Gemini Peaks

ARCH

S. F. Emmons, Geologist-in-Charge

CH FROM PENNSYLVANIA HILL



and the lines of outcrop can be traced with the greatest distinctness. In the distant view of the whole range from Mount Silverheels, as shown in Plate III, these structure lines, as well as the curves of Sacramento arch and of Sheep Mountain fold, can be readily recognized. Immediately west of the fault the beds are perpendicular, and even bend over so that they have a slight inclination to the westward. The change from this steep dip to the average inclination of the whole hill seems to be less sudden than on Pennsylvania Hill; but, as there, it is somewhat obscured.

On the south side of the ridge facing Little Sacramento Valley is a slight synclinal fold, no evidence of which is found on the north face of the ridge. An explanation of this occurrence may be found in the fact that the line of fault from the Sacramento arch southward apparently diverges to the eastward, as compared with the strike of the beds, so that more space is left between the fault plane on the east and the unyielding masses of porphyry which form the crest of the ridge to the west.

*Gemini Peaks.*—In the long series of outcrops on the eastern slopes of the Gemini Peaks, which comprise almost the entire thickness of the Weber Grits formation, are some minor sheets of porphyry which have not been indicated on the map. The two peaks themselves form the crest of an immense body of Sacramento Porphyry which is exposed under the Weber Grits, both on the north and south walls, in apparent conformity with the overlying sandstones. The thickness shown, as derived from the angle of the slope, must be about 1,200 feet. The north branch of Little Sacramento Creek has cut to a great depth into this immense body of porphyry, leaving on either side walls nearly 1,000 feet in height, in which the same columnar structure in large masses or prevalence of vertical cleavage planes is found that has been already noticed in the porphyry mass on the summit of Mount Lincoln. It evidently represents what was originally a huge laccolite, and it is probable that it stands above the original vent from which the main flows of Sacramento Porphyry spread out into the adjoining rocks. Immediately to the south and west of this is the main body of White Porphyry, which forms the mass of White Ridge and of Mount Sherman. The junction of these two great bodies is extremely interesting, and was expected to afford definite evidence of the relative age of the two rocks. The

actual contact is, however, obscured by broken masses which almost invariably cover the surface in these high regions. On the east side of the eastern of the Gemini Peaks, however, were found a few beds of Weber Grits, within which was a small body of White Porphyry, while at either side of the Weber Grits was found Sacramento Porphyry. It seems, therefore, that this fragment of Weber Grits, with the included White Porphyry, was caught up within the later outflow of Sacramento Porphyry. Such caught-up masses of sedimentary rocks entirely included in porphyry masses are by no means uncommon.

On the southwest face of the western of the Gemini Peaks are beds of Weber Shales, about fifty feet in thickness, consisting of gray limestone, quartzite, and green micaceous shales. About half a mile south of this, and in a shallow depression between the summit of Mount Sherman and the outlying shoulder to the east, is a similar succession of beds, dipping however to the west, which are entirely included in the surrounding mass of White Porphyry. On the east of this shoulder again, at the contact of Sacramento Porphyry and White Porphyry, are found thin beds of white quartzite, belonging undoubtedly to the same general horizon.

The most characteristic exposures of this great mass of Sacramento Porphyry can be seen at the heads of Little and Big Sacramento gulches and on the main ridge between Sacramento and Evans amphitheaters. On the eastern wall of the latter it covers the greater part of its steep surface, widening and rising to the southward, and sweeping up to the summit of Dyer Mountain, where a thickness of some four hundred feet still remains. Below this, and separating it from the Blue Limestone, is a remnant of the lower beds of the Weber Grits formation, a relic of which forms the summit of West Dyer Mountain. From the saddle between Dyer Mountain and Gemini Peaks both Weber Grits and Sacramento Porphyry have been removed, leaving the crest of the ridge composed of White Porphyry. The limits of the two bodies of White Porphyry and Sacramento Porphyry are well defined by a line running nearly northwest and southeast between Gemini Peaks and Dyer Mountain. To the northeast of this line the White Porphyry rapidly thins out and disappears. The occurrences of this rock, hitherto noted in the regions farther north, were generally in the form of dikes



of inconsiderable magnitude, or of quite small intrusive masses which doubtless are the upper portion of similar dikes whose base is concealed. It is probable that these minor eruptions of porphyry are of later date than the main intrusive masses which prevail to the southwest of this imaginary line. Although the Sacramento Porphyry is not found upon the surface to the west of the main crest of the range, it is probable that it did not originally end abruptly there, but gradually thinned out in some such form as is indicated in Section D, west of the Mosquito fault, or as is shown more in detail in the sections accompanying the Leadville map. Lithologically it forms a definite type, whose general character has already been given in the chapter on Rock formations. Its distinguishing characteristics, as compared with the other porphyries, are its relatively large proportion of plagioclase feldspar and its carrying hornblende. These ally it in some degree to the porphyrites.

**Little Sacramento gulch.**—The observations made in Little Sacramento gulch, which time did not admit of repeating, were unfortunately not sufficiently detailed to afford data for an accurate outlining of all the bodies of porphyry found there. The principal uncertainties resulting herefrom are: first, as to the eastern limit in the gulch of the main body of the Sacramento Porphyry: whether it confines itself to the horizon which it follows with apparent regularity farther north or whether it cuts across the overlying beds; and, secondly, whether a body of the same porphyry observed on the north face of the ridge separating Little Sacramento from Spring Valley is connected with the main body as a transverse body, or whether it is a portion of an interbedded sheet, like those on the western face of London Hill, with which it might be possibly connected by the bodies observed, but not outlined, on the eastern flanks of the Gemini Peaks ridge.

East of the fault, it is evident that in the region included between Horseshoe and Big Sacramento gulches there is a lateral syncline similar to that observed on Pennsylvania and Loveland Hills, but broader and deeper. The surface of the region is too much covered to admit of this fact being determined by the observed dip of the beds, but it is evident by the fact that the erosion of Little Sacramento gulch, where it traverses the arch of the Sheep Mountain fold, has cut down either to a very little depth or not

at all into the Archean keystone of the arch; whereas the erosion of the adjoining cañons, Big Sacramento on the north and Horseshoe on the south, has cut into this body to the depth in one case of about five hundred and in the other of nearly one thousand feet. The sandstone of the Weber Grits formation overlying the Blue Limestone sweeps up on the ridges between Little and Big Sacramento gulches for a considerable distance above their junction, as is shown by numerous prospect holes. The continuity of the intervening belt of Sacramento Porphyry cannot be definitely proved, owing to considerable spaces where the outcrops are masked by surface accumulations, but is reasonably probable.

*Spring Valley.*—The region between Little Sacramento and Horseshoe gulches is split by a little longitudinal valley, called Spring Valley, into two low ridges, either of which is capped by Blue Limestone. Their general form can be seen in outline on the Sacramento arch sketch, Plate XV.

On the eastern slope of the northern of these two ridges is the Sacramento mine, which has obtained rich silver ores from the Blue Limestone. At the mine itself the overlying porphyry has been eroded off; but extensive outcrops, covering a very considerable superficial area, are found to the east, and are well shown in the steep rocky ravine which carries the drainage of Spring Valley into the main Sacramento gulch. The same body of porphyry is found on the southern ridge, where it rapidly thins out, overlapping a similar tongue of White Porphyry; a portion of the Weber Grits formation is included between the two. It is evident that this body of porphyry was once a continuation of the main body of Sacramento Porphyry, although it occupies a lower horizon and necessitates the supposition that in separating out at a certain horizon a portion of the main laccolite body has cut down to a lower horizon. Improbable as this may seem, it can be practically proved to have occurred on the south of the Twelve-Mile amphitheater, as shown in Section H, Atlas Sheet IX. Moreover, the thickest portion of this body is opposite the thickest portion of the main body.

*Horseshoe gulch.*—Perhaps the most complete and instructive series of sections, and certainly those which have the most direct bearing on the geology of the immediate vicinity of Leadville, are afforded by the erosion

of Four-Mile or Horseshoe Creek. In regard to its nomenclature, local usage is somewhat perplexing. The stream itself, when it debouches on the South Park, is called Four-Mile Creek. Its main cañon is generally known as Horseshoe gulch. At its head it divides into two branches; to the northern of these has been given the name of Four-Mile amphitheater; the southern branch heads in two adjoining cirques or amphitheaters, the northern of which has received, from its strikingly regular and complete curve, the name of the Horseshoe. (See Plate XVII.)

This gulch, like those to the north, is glacier carved; but the walls are less steep, as the upturned edges of the stratified rocks have been more susceptible to subsequent abrasion, so that the talus slopes, covered with shrubs and trees, reach a considerable height. The wide gulch above the fault still has traces of lateral moraines along its sides. Where below the fault it is carved out of the Archean rocks, however, these have been carried away by later erosion, the gulch being here considerably narrower. When the valley opens out again near East Leadville and bends to the southward, although there is moraine material on the lower slopes, the form of the ridges is not sufficiently distinct to show whether they are the original moraines or consist of rearranged material. On account of the importance of the district, the sections exposed will be described at considerable length. The appearance of the surface is shown in the accompanying sketches. That given on Plate XVI shows the more prominent outcrops on the ridge forming the north wall of Horseshoe gulch, from White Ridge, on the west, to the crest of the anticlinal fold, east of the London fault.

*White Ridge.*—The southwest face of White Ridge, as shown in the section, is a mass of White Porphyry. On its back and north and east slopes lie strata of Weber Grits formation, whose lines of outcrop can be traced as distinctly and regularly as those on the back of the Gemini Peaks Ridge. Their dip, however, is proportionately steeper, since the distance between the porphyry body and the line of fault is shorter. This dip, as shown in the sketch, varies from  $30^{\circ}$  to  $45^{\circ}$ , the latter being the angle immediately above the White Porphyry, which to the eastward decreases gradually to  $30^{\circ}$ , and then, in close proximity to the fault line, rapidly steepens to the perpendicular. East of the fault the curves formed by the beds of the

anticlinal fold over the Archean are very distinct, the partially eroded Blue Limestone forming the present crest of the ridge.

On the south end of White Ridge, in the angle at the junction of Four-Mile amphitheater with the main gulch, is a prominent outcrop of dark-blue limestone, standing at an angle of  $45^{\circ}$ , directly above the porphyry. A short distance to the west of this outcrop, at the foot of the steep slope and at intervals along the southwest side of White Ridge, on a line rising gradually as it approaches the head of Four-Mile amphitheater, prospectors with their keen natural instinct have traced the same bed under the heavy talus slopes of débris which cover it.

In the very bottom of the Four-Mile amphitheater, as shown on the map, the Blue Limestone again outcrops in the bed of the gulch, and has been developed in the important Badger Boy mine and by numerous prospect holes. On the ridges around, White Porphyry forms the surface, which is in its normal position above the Blue Limestone. The line of the Blue Limestone, traced along the face of White Ridge, is however at a considerable distance above the actual level of the Badger Boy limestone, and at a still greater distance geologically, inasmuch as the normal dip is to the east. It is therefore evident that the limestone under White Ridge has been lifted up by a fault, as shown in Section F, Atlas Sheet IX. The White Porphyry forming the mass of White Ridge is there in its normal position above the Blue Limestone, except at the south end just mentioned, where occur the prominent outcrops of dark limestone shown in the foreground of the sketch. The thickness of stratified beds exposed at this point is between 150 and 200 feet, the upper members of which have the characteristics of Blue Limestone, while toward the base are light-colored silicious beds, largely of white quartzite. Although the lithological character of the beds does not correspond in every respect with similar sections elsewhere, there is no doubt that it represents the main body of the Blue Limestone, and very probably the Parting Quartzite with a portion of the White Limestone beneath it. This heavy belt of dark limestone does not extend very far up the ridge, but gradually thins out and disappears, the sedimentary beds adjoining the porphyry at the summit of White Ridge being quartzites and micaceous shales of the Weber Grits series. It is evident, therefore, that the White Porphyry mass here cuts diagonally up across the beds, and that



White Ridge

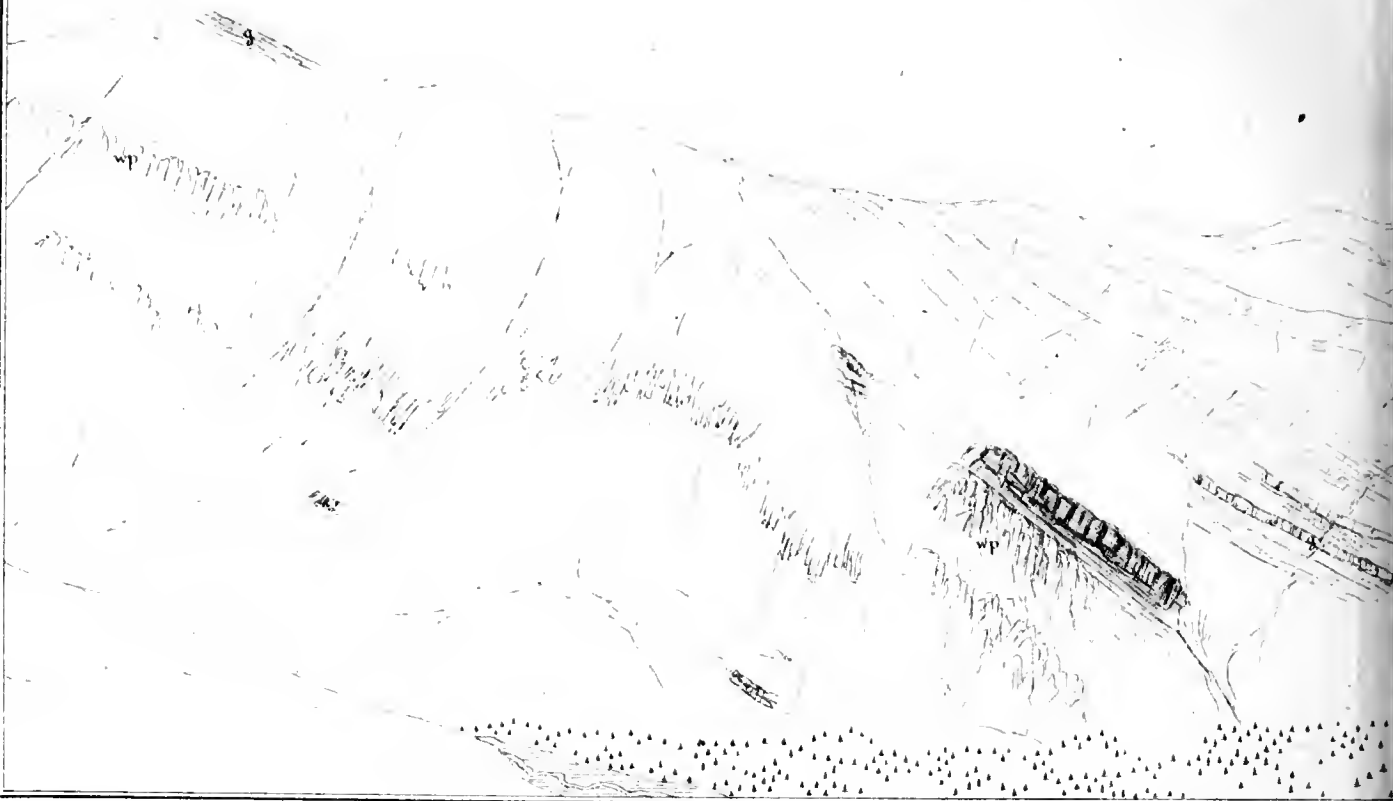

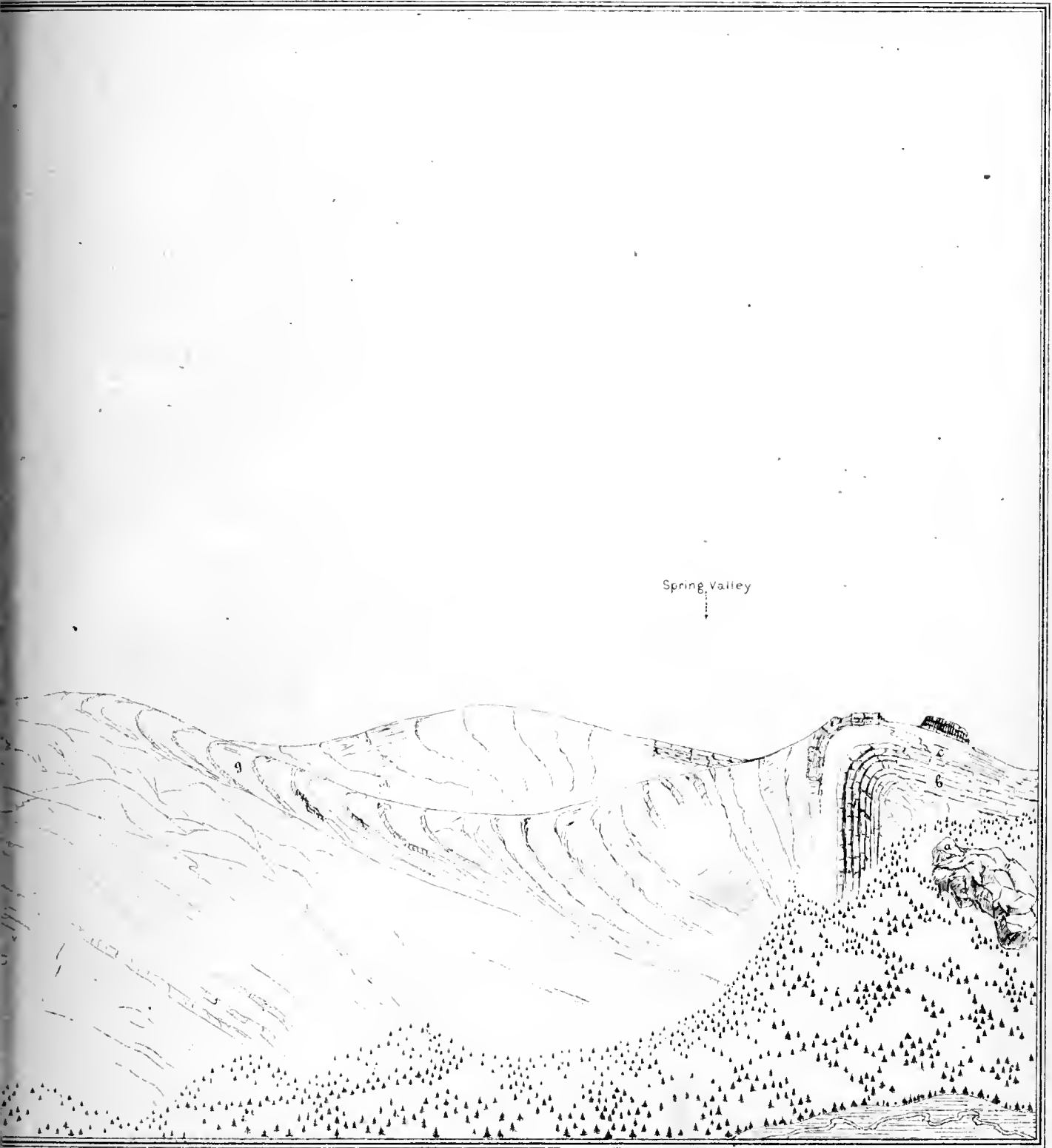

S. F. Emmons, Geologist-in-Charge

HORSESHOE GULCH .

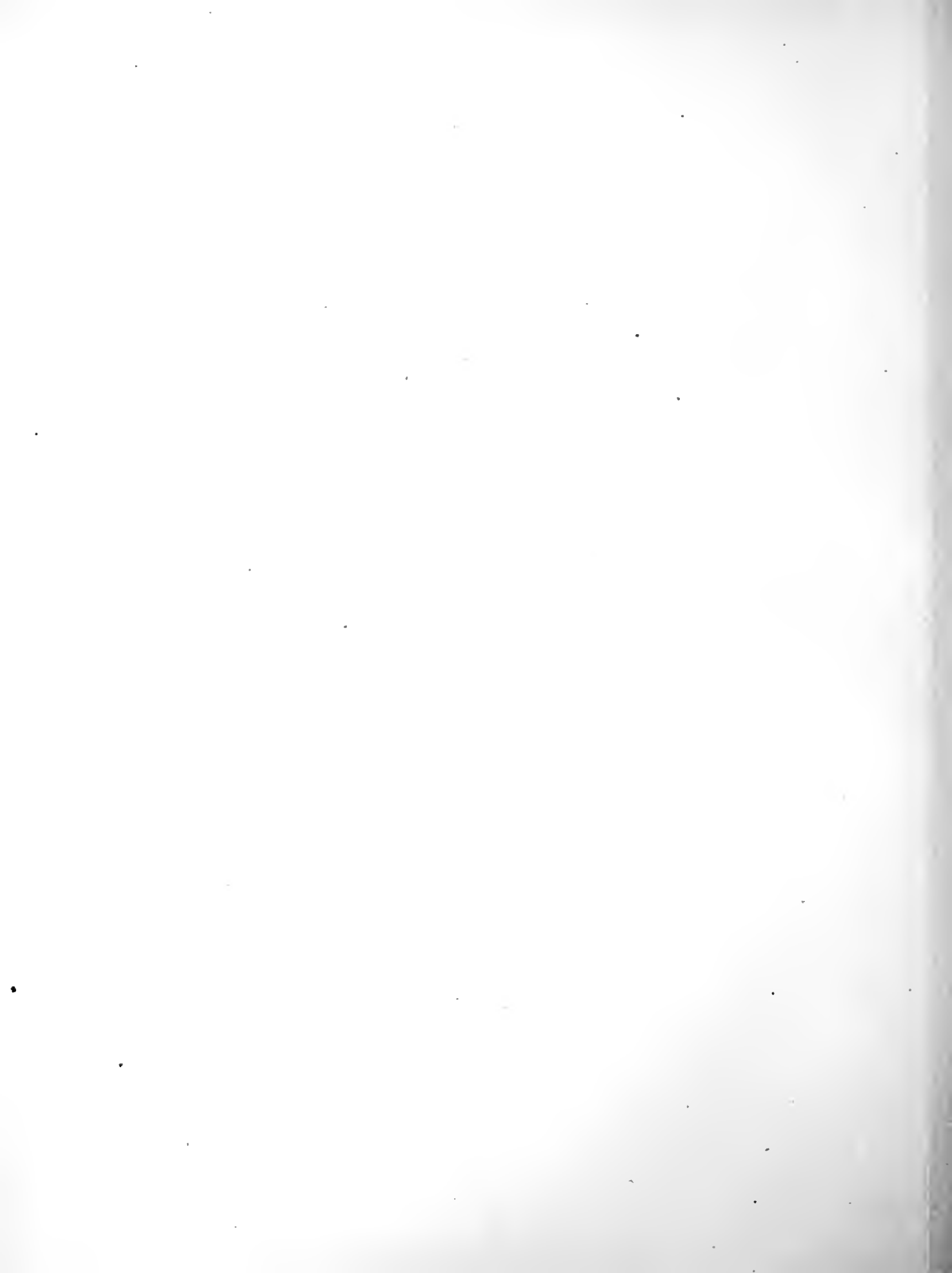



the dark outcrop is simply a portion of the Blue Limestone left above it at this point, the main mass being represented by the line of Blue Limestone along the southwest base of the ridge. The thickness of the porphyry body, as represented by the distance between these outcrops, may be roughly estimated at about six hundred feet at the south end and 1,000 to 1,500 under the summit of the ridge. It seems evident, therefore, that we have here in actual outcrop a portion of the main laccolitic mass as it ascended from below across the lower Paleozoic beds and spread out above the horizon of the Blue Limestone, as is shown theoretically in Section F.

In the shales and quartzites on the northern and eastern slopes of White Ridge are numerous bodies of White Porphyry, which in the neighborhood of the summit sometimes seem to ramify and intersect the beds, but in general show a tendency to spread out between them. As it was impossible to delineate all the varying outlines of these bodies, the prevailing form alone has been shown on the map, viz, that of intrusive sheets spreading out from the main laccolitic body along the stratification planes and gradually thinning as they depart from it.

**North wall of Horseshoe gulch.**—The section taken along the south face of the ridge eastward from the outcrop of Blue Limestone is approximately as follows: A covered gap of about three hundred feet, containing, as is shown higher up, a bed of 50 feet of White Porphyry directly above the Blue Limestone; then about one hundred feet of shales, both calcareous and silicious, but mainly quartzite and sandstone; then a second bed of White Porphyry 50 feet in thickness, 5 feet of quartzite, and 5 feet more of White Porphyry; then varying quartzites, micaceous sandstones, and shales, above which are fine black shales, carrying pyrites and some fossils, from which were obtained the following forms:

*Productus semireticulatus.*

*Productus muricatus* = *P. longispinus* Meek.

*Productus cora.*

*Productus costatus.*

*Productus pertenuis.*

*Griffithides*, sp. undet.

*Spirifer cameratus.*

*Spirifer*, sp. ?

*Aviculopecten carboniferus.*

*Fenestella*, sp. undet.

*Rhombopora*, sp. ?

Fragments of *crinoids* and *bryozoans*.

The above succession of beds, which is taken from notes by Professor Lakes, represents approximately what has been assumed as the Weber Shale

division of the Weber Grits formation, viz, the fossiliferous and more calcareous and argillaceous beds at its base. The thickness represented is somewhat greater than that observed in other sections; but the upper limits of the division are in themselves somewhat ill-defined, and the measurements obtained here are uncertain, owing to the fact that they were not observed in a continuous series of outcrops and certain beds may have been reduplicated.

From here eastward to the fault the outcrops are those of the ordinary Weber Grits, coarse white sandstone predominating, with development of micaceous sandstones passing into shales, occasional thin seams of carbonaceous shales, and a limited development of limestone beds. Variation in the strike is noticed from N. 28° W., about midway in the series, to N. 5° W., near the fault. The latter direction corresponds more nearly with the average strike of the beds near the fault, and the former may be considered to be a bowing out of the strata, caused by the intrusion of the large masses of porphyry at White Ridge and Gemini Peaks.

The actual fault plane is apparently exposed by a prospect hole on the low saddle overlooking the gulch, where the contact of a dense quartzite, in vertical position, with White Porphyry on the east, shows very marked slickensides surfaces and a clay seam. A little to the west of this point is a second contact of quartzite and White Porphyry, dipping 50° east. This White Porphyry may very likely be an intrusion in the beds of the Upper Coal Measure formation, as has already been assumed to be the case with a corresponding body on Pennsylvania Hill. This assumption and the fact that the thickness deduced from the angle of the dip and the transverse distance between this point and the base of the series necessitates the existence of a portion of the Upper Coal Measure beds, have been the reasons for their indication on the map and sections, since time did not admit of a sufficiently detailed examination to determine their existence on lithological and paleontological grounds. White Porphyry is found on the opposite side of the gulch, near the top of the Weber Grits formation, as will be shown later.

Directly east of the fault, which occupies a saddle in the ridge, is a con-

siderable outcrop of White Porphyry, whose thickness may be estimated at 200 feet. Within the White Porphyry is a dark porphyry, very much altered, but similar in appearance to the Sacramento Porphyry, and which may once have been connected with the body of this rock already described above the Sacramento mine. These are succeeded by the Blue Limestone, whose beds, as shown in the section and sketch, curve up and cover, somewhat irregularly, the double-pointed ridge over the arch of the fold. From this limestone well-preserved specimens of *Spirifera Rockymontana* were obtained. In the Blue Limestone on the crest of the arch are, according to Professor Lakes, numerous vertical cracks, which may be cross fractures resulting from folding. The lithological character of the Blue Limestone varies greatly in different portions. Black chert concretions, which are as elsewhere most frequent at its summit, are also found well down in the formation. Many of the beds, especially near the base, are comparatively light-colored. No satisfactory continuous section was obtained of the lower Paleozoic beds, though the estimate of their aggregate thickness does not vary from that obtained elsewhere. At various points an included bed of White Porphyry, near the top of the Lower Quartzite, and averaging about thirty feet in thickness, was observed. The Archean is composed of gneiss and of red porphyritic granite with large orthoclase crystals.

On the eastern slope of the anticline, outcrops of beds above the Blue Limestone are exposed in the forest-covered region near the road leading from East Leadville to Spring Valley, where they are much obscured by surface accumulations, and, on the steeper slopes, by the relics of a lateral moraine. Above the Blue Limestone the White Porphyry can first be distinguished; next is an interval of coarse sandstone; then a body of Sacramento Porphyry, which apparently thins out rapidly to the southward. The White Porphyry, on the other hand, rapidly thickens in that direction, as shown by its section on the eastern slope of Sheep Mountain.

An attempt was made by Professor Lakes to obtain a continuous section from here eastward, through Fairplay, across the upper members of the Carboniferous and the overlying Triassic, Jurassic, and Cretaceous beds. The result was not very satisfactory, inasmuch as a great portion of the

line of section is occupied by covered gaps, which could not be accurately filled by offsets. The thickness of the sedimentary series from the Cambrian up to the top of the Cretaceous along this line has therefore been assumed, in the ideal reconstruction of the surface, as that given by the section of the Hayden Atlas, viz, 10,000 feet. The data obtained by Professor Lakes afford no sufficient reasons for differing from this general conclusion.

**Four-Mile amphitheater.**—The description now turns to the exposures at the head of the gulch and along the main crest of the range from Mount Sherman to the head of Twelve-Mile Creek. The most striking of these are shown in the sketch on Plate XVII, which represents the Horseshoe and a portion of the Four-Mile amphitheater as seen from the junction of the two branches of the creek. The shapes of these two amphitheaters differ characteristically, in accordance with the differing characters of the rock out of which they have been carved. The erosion of the Four-Mile amphitheater, which has been practically parallel with the strike of the beds, has acted almost exclusively on the great mass of White Porphyry. Its slopes are generally more rounded and largely composed of talus slopes of angular fragments of this geologically brittle rock. In the bed of the stream erosion has denuded a narrow strip of the Blue Limestone, dipping  $16^{\circ}$  to the N. E. and striking N.  $15^{\circ}$  to  $20^{\circ}$  W. East of this outcrop a bed of Blue Limestone, as already mentioned, has been developed by a line of prospect holes along the face of White Ridge, whose elevation to its present relatively higher position must necessarily have been the result of faulting. Data are wanting, however, to locate definitely the line of this fault. That given on the map as the Sherman fault is determined principally from the theoretical considerations furnished by Section F, according to which it is assumed that a certain arbitrary thickness of White Porphyry exists under the Blue Limestone. The fault line would therefore have White Porphyry on either side of it, which necessarily renders its position difficult to recognize. That such a body does exist under the Blue Limestone is rendered almost certain by the fact that it is found at this horizon farther westward, along the western base of Mount Sheridan and throughout the Leadville region to the north-east of a line roughly drawn from Mount Sheridan to Fryer Hill.



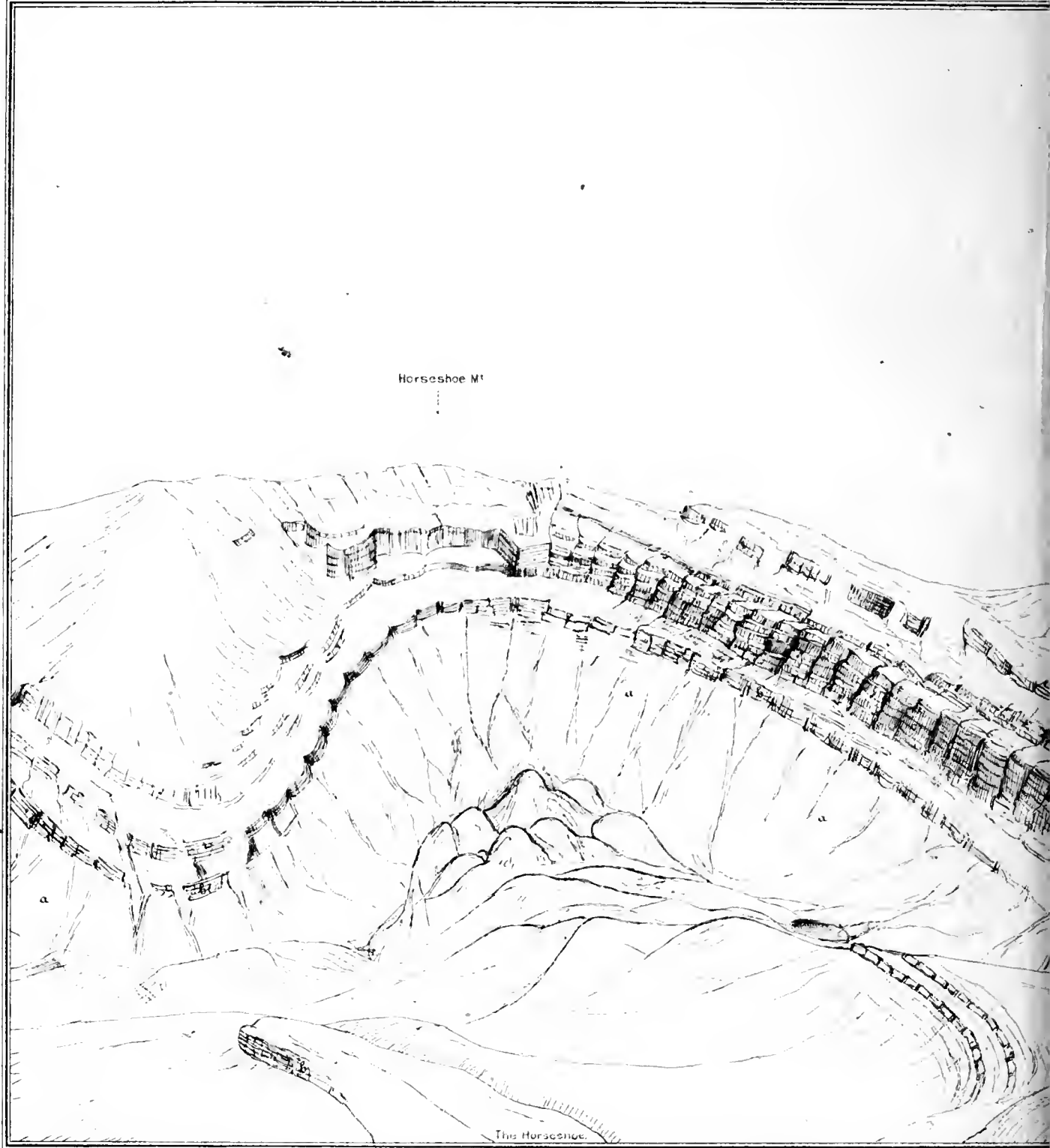

Julius Bien & Co. lith

Peerless Mt.

Mt. Sheridan.



S. F. Emmons, Geologist in Charge

MILE CREEK.

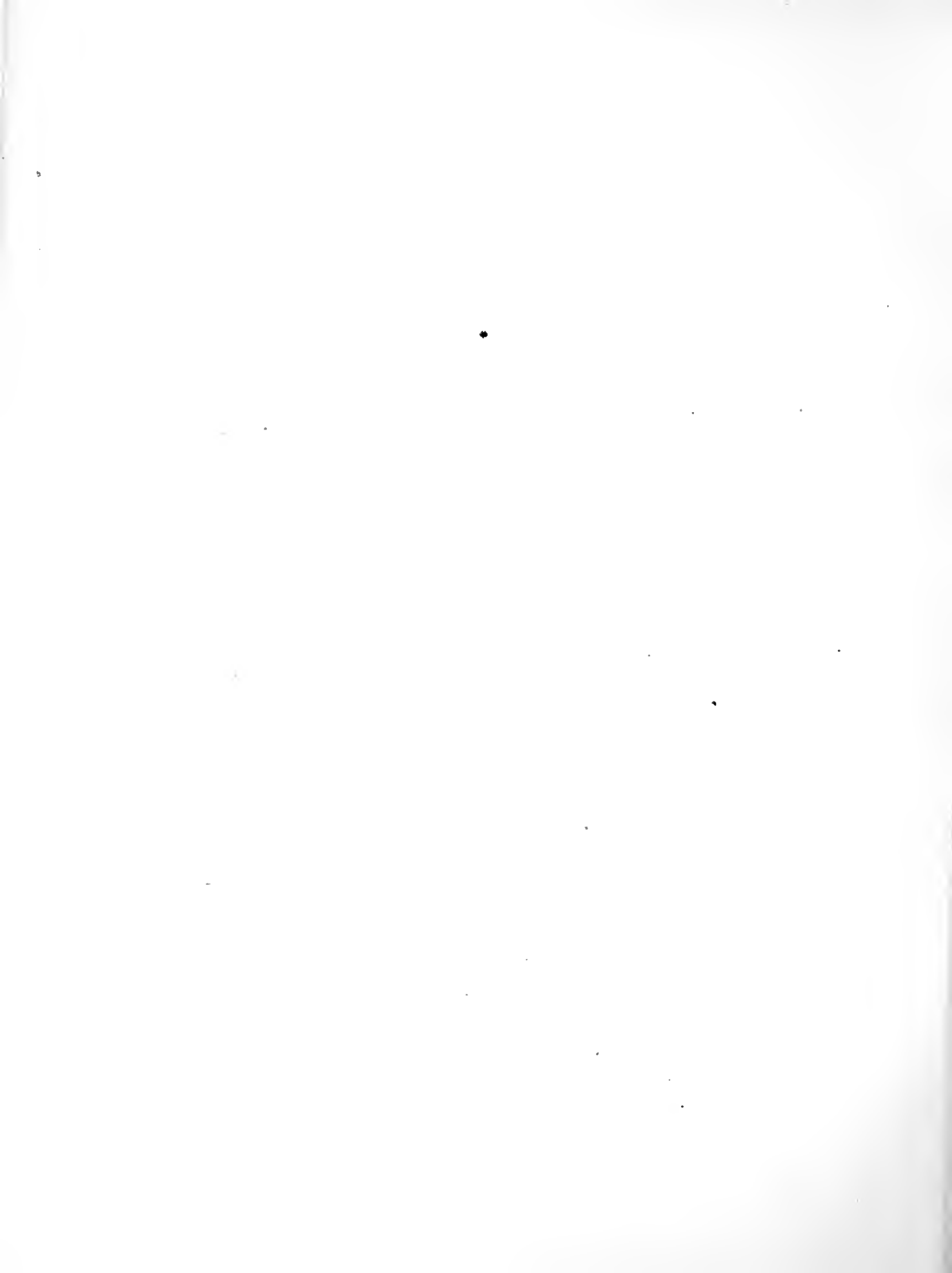



Besides these two outcrops of limestone the only sedimentary beds observed are a lenticular body of Weber Grits at the head of the amphitheater on the south face of Mount Sherman. This body, which is several hundred feet in length and thirty or forty feet in thickness, consists of shales and sandstones, the former apparently somewhat baked and the latter changed to quartzite. It extends to within a few feet of the top of the dividing ridge between Four-Mile and Iowa amphitheaters, but does not outcrop on the wall of the latter.

The western slope of Mount Sherman, which forms the eastern wall of the Iowa amphitheater and is shown in the background of the frontispiece of this volume, consists, from the crest two-thirds way down, of a mass of White Porphyry from 1,200 to 1,500 feet thick. Separating this from the Archean in the bottom of the gulch are the lower Paleozoic series, whose beds rise to the southward as one follows the wall and curve round the west face of Mount Sheridan across the low saddle which separates it from West Sheridan. The sharp crest of Mount Sheridan and its eastern slope are covered with White Porphyry, as is also the little eminence south of it on the main ridge, called Peerless Mountain. On the saddle between the two the White Porphyry has been eroded off for a considerable distance down the east slope, and certain rather silicious beds resembling quartzite, which here form the upper portion of the Blue Limestone, have been exposed. South of Peerless Mountain the Blue Limestone is again exposed on the surface of the crest, as far as the top of Horseshoe Mountain, and also in a strip bordering the Horseshoe on the northeast. In this vicinity, especially along the western face of Peerless Mountain, the upper portion of the Blue Limestone shows evidence of considerable metamorphic action. Its outcrops are quite dark, and its upper part, as already mentioned, is very silicious and resembles quartzite. It has also a slightly brecciated structure, and in certain places is very much stained with oxides of iron and manganese. It is probable that this alteration is due to mineral waters, and is a commencement of decomposition such as has gone on in Leadville itself, though the amount of lead and silver ore as yet developed is comparatively inconsiderable. The darker color is due doubtless to oxide of manganese, and the silicification of the beds to percolating waters depositing granular

silica, a form of vein material which, as will be seen later, is common in the Leadville mines and easily to be mistaken for genuine quartzite. The brecciation is doubtless due to the action of the porphyry at the time of its intrusion.

**The Horseshoe.**—Horseshoe Mountain, as is shown both on the map and on the sketch, is covered by a thin shell of easterly-dipping beds of the lower Paleozoic series, whose angle on the crest is about  $10^{\circ}$  and steepens to an average of  $20^{\circ}$  on the eastern slopes. The irregularity of the outcrops of the successive formations shown on the map represents the results of erosion on this thin shell.

The character of the outcrops in the Horseshoe itself is sufficiently shown in the sketch. Its peculiar form is a result of glacial erosion, which alone could have carved vertically across the inclined surfaces of hard sedimentary strata. The main body of the encircling cliffs is composed of the White Limestone and of the upper beds of the Lower Quartzite, which, owing to their peculiar weathering, received in the field the convenient name of "sandy limestones." On their weathered surface they resemble in all respects a sandstone, but a fracture of the mass shows the interior to have the compact semi-crystalline structure of limestone. The beds of Blue Limestone above these are more or less eroded off, while the pure quartzites at the base of the series are in places concealed under the talus slope of débris. In the very bottom of the amphitheater are two or three little shallow lakes or ponds of glacial origin, carved out of granite or the Lower Quartzite. Passing down the stream from the glacial amphitheater, one crosses successively an ascending series of outcrops which sweep round in graceful curves up the bounding ridge to join the beds on the crest of the range.

Intersecting these outcrops in a northeasterly direction, and in part following the line of contact between the Blue and White Limestones, is a small body of porphyrite; this and a similar outcrop in the Four-Mile Amphitheater constitute the only instances observed of the occurrence of this rock within the White Porphyry region. The rock is a grayish-brown, homogeneous-looking, fine-grained mass, showing small glistening black biotites and minute white feldspar crystals with round quartz grains. Under

the microscope there seems to be no fresh feldspar substance left in the rock, although outlines of former crystals can often be plainly distinguished, the interior being replaced by a mixture of calcite and a cryptocrystalline substance, colorless in ordinary light, showing the alternations of light and dark points characteristic of a homogeneous aggregation of minute particles, probably quartz. The biotite leaves, both large and small, seem perfectly fresh and in remarkable contrast to the condition of the feldspar. From the great quantity of calcite present and the absence of muscovite or kaolin, it seems evident that the feldspar was a plagioclase rich in lime, and the rock a quartz-biotite-porphyrite, although in external appearance it is quite unlike any porphyrite observed elsewhere in the region.

The larger amphitheater at the head of the south fork of Horseshoe Creek has a less striking and regular form than the Horseshoe itself, but presents the same geological structure. From the crest of the range at its head, however, the Blue Limestone has been eroded off, and Silurian beds form the surface. These are succeeded, as one goes south along the crest to the head of Twelve-Mile amphitheater, by the Cambrian and Archean successively.

South wall of Horseshoe gulch. — On the ridge running from the crest of the range to Sheep Mountain, along the south side of Horseshoe gulch, an excellent continuous series of beds from the Archean up to near the top of the Weber Grits are shown. The north side of this ridge is most admirably delineated by a line sketch from the skillful hand of Mr. W. H. Holmes in the Hayden report for 1873.<sup>1</sup>

The same series of beds are here represented as were shown on the ridge north of the gulch, but they occupy nearly double the space in lineal extent along the side of the gulch; their angle of dip is consequently shallower, and midway in the series is a small synclinal fold which enables the same beds to cover a greater surface. The direct connection between the two sides is obscured by the detrital material in the gulch. It is evident, however, that the existence of a cross-fault is necessary to explain this discrepancy, since there is no evidence that the beds of the south ridge curve round to the east to join those on the north, their strike being the normal

<sup>1</sup> Page 230, Geological and Geographical Survey of the Territories. Washington, 1874.

strike of the formations, N. 10° to 20° W. This fault has been assumed, therefore, to follow the bed of the gulch, and probably connects the Sherman with the London fault; its line is not given on the map, as it would be concealed by the Quaternary beds indicated in the bed of the gulch. The course of the gulch in this extent, which is unusually straight, has probably been determined by this fault.

The structure of this Sheep Mountain ridge, as deduced from careful observations made along its surface, is shown in Section G, Atlas Sheet IX. Of the White Limestone and Lower Quartzite, which are only exposed in the amphitheater south of the Horseshoe, measurements were not made, since those obtained from the exposures in the Horseshoe itself correspond with the thickness obtained elsewhere. The body of White Porphyry, which sweeps up at an angle of 20° opposite the opening of the amphitheater, has here a thickness of nearly two hundred feet, and shows a certain tendency to columnar structure at right angles to the bedding. The beds immediately above the White Porphyry contain a large proportion of shales, which, being easily disintegrated, show but few outcrops, the space occupied by them forming a saddle in the ridge. The thickness from the White Porphyry up to the more persistent sandstones and grits of the Weber series, which would correspond to the Weber Shale division, is here estimated at from two hundred to three hundred feet. The beds observed are as follows: Directly above the White Porphyry is a bed of black carbonaceous shales; from one hundred to one hundred and fifty feet above it is an outcrop of dark, impure limestone, from which were obtained a large number of fossils, among which the following were recognized:

<i>Chonetes granulifera.</i>	Fragment of <i>Pinna</i> , sp.
<i>Productus cora.</i>	Fragment of <i>Ariculopecten</i> .
<i>Productus nodosus</i> (variety of <i>Productus cora</i> ).	<i>Phillipsia</i> , sp.
<i>Productus semireticulatus.</i>	<i>Phillipsia major</i> .
<i>Myalina pcrattenuata.</i>	Fragment of <i>Lingula</i> , sp.

About fifty feet above this there is a bed of black shales, from which were obtained impressions of *Lingula mytiloides*, the same form which is so abundant directly above the Blue Limestone near Leadville. For about three-fourths of a mile eastward along the crest of the ridge the

beds dip regularly eastward at an angle of  $20^{\circ}$ . They consist mainly of coarse white or gray sandstones, passing into conglomerates composed largely of pebbles of white milky quartz, having a slightly pinkish tinge, and which, when weathered out, cover the surface for a great distance. Alternating with these are thinner beds of micaceous quartzite, passing into a mica-schist, the mica being always of the muscovite or potash type. Less frequent are thin seams of black carbonaceous shales. Near the upper part of this portion of the section is a single bed two feet thick of dark iron-stained limestone, seamed with carbonaceous shales. Between this and a little knob rising above the general level of the ridge is a synclinal fold in the beds, which rise on its western side at angles of from  $50^{\circ}$  to  $70^{\circ}$ . The beds included in the synclinal trough above the iron-stained bed are, first, a white quartzite conglomerate, then a brownish sandstone, then a white massive sandstone, then a second brownish sandstone with thin seams of clay and shale, and finally a green clay slate at the axis of the syncline. East of this axis the same succession of beds is passed over, which appear thinner, however, owing to their standing at a steeper angle. On the east side of the knob the iron-stained limestone reappears dipping  $70^{\circ}$  to the west, and a short distance farther can be traced somewhat indistinctly, dipping at the same angle to the eastward. Following the ridge eastward the beds assume the normal dip of  $20^{\circ}$  and have the same general character as that already described. For half a mile or more dark thin beds of quartzite and shaly beds are more frequent, but gradually pass up into massive, heavily-bedded, coarse white sandstones, whose dip shallows to about  $10^{\circ}$  or  $15^{\circ}$ . This little anticlinal and synclinal fold has the normal character of the folds in this region, viz, a steep west side to the anticline or east side to the syncline. It may also, as is often the case, be accompanied by a slight movement of displacement, but this could not be definitely proved. The synclinal structure can be traced on the broad ridge directly south of this point in the somewhat indistinct lines on its grassy surface which mark the outcrops of the beds. The fold here becomes broader and shallower, and probably soon dies out to the south.

**Lamb Mountain.** — Near the west end of the little prominence on the ridge called Lamb Mountain, an eruptive rock comes in above the sandstone,

which weathers in large shaly blocks, with a remarkably beautiful conchoidal fracture and the peculiar sherry habit which is common among volcanic rocks. The rock is white, slightly tinged with reddish yellow, due to minutely disseminated particles of hydrated oxide of iron. In the fresh fracture it shows a white granular homogeneous mass, with occasional grains of feldspar. It was first thought to be a later eruptive rock, probably a rhyolite, but careful microscopical study shows it to be a true White Porphyry, differing in no essential from the normal type. On Lamb Mountain, as shown in the sketch, Plate XVIII, this body has a maximum thickness of about four hundred feet at the summit of the hill, its lower limit corresponding in general with the bedding plane of the underlying sandstone. This correspondence, however, on close examination, is not absolute, inasmuch as it occupies a slightly lower horizon to the eastward, and on the north face of the ridge just west of the ravine between Lamb and Sheep Mountains it can be seen to cross the beds nearly at right angles, in the form of a dike. On the steep east side of Lamb Mountain toward the saddle are beds of slate and micaceous sandstone, curving up at an angle of  $50^{\circ}$  against the eruptive mass. In these slates were found abundant impressions of *Equisetæ*, or Horsetails, a plant characteristic of the Coal Measures. Sandstone outcrops can be traced on this saddle and across it to the base of the steep western slope of Sheep Mountain, where they soon disappear beneath the plentiful débris of White Porphyry. The White Porphyry from which they come is, as will be shown later, the body which belongs above the Blue Limestone; therefore the fault line must run very nearly at the foot of this steep western slope. That the Lamb Mountain body is itself a small laccolite, with a separate vent or channel, is evident from the fact that it ends abruptly on the east and that, while the steeply-dipping beds rest against it on the saddle east of the peak, lower down the slope of the hill the dike-like channel, which extends downward from the main mass of porphyry, is found to cross the shallow-dipping sandstone strata without perceptibly changing their angle. The steepness of the beds on the saddle might be explained by the expansion of the intrusive body of porphyry, which would push them up, but this explanation is rendered unnecessary, since, as we have already seen, the beds immediately adjoining the

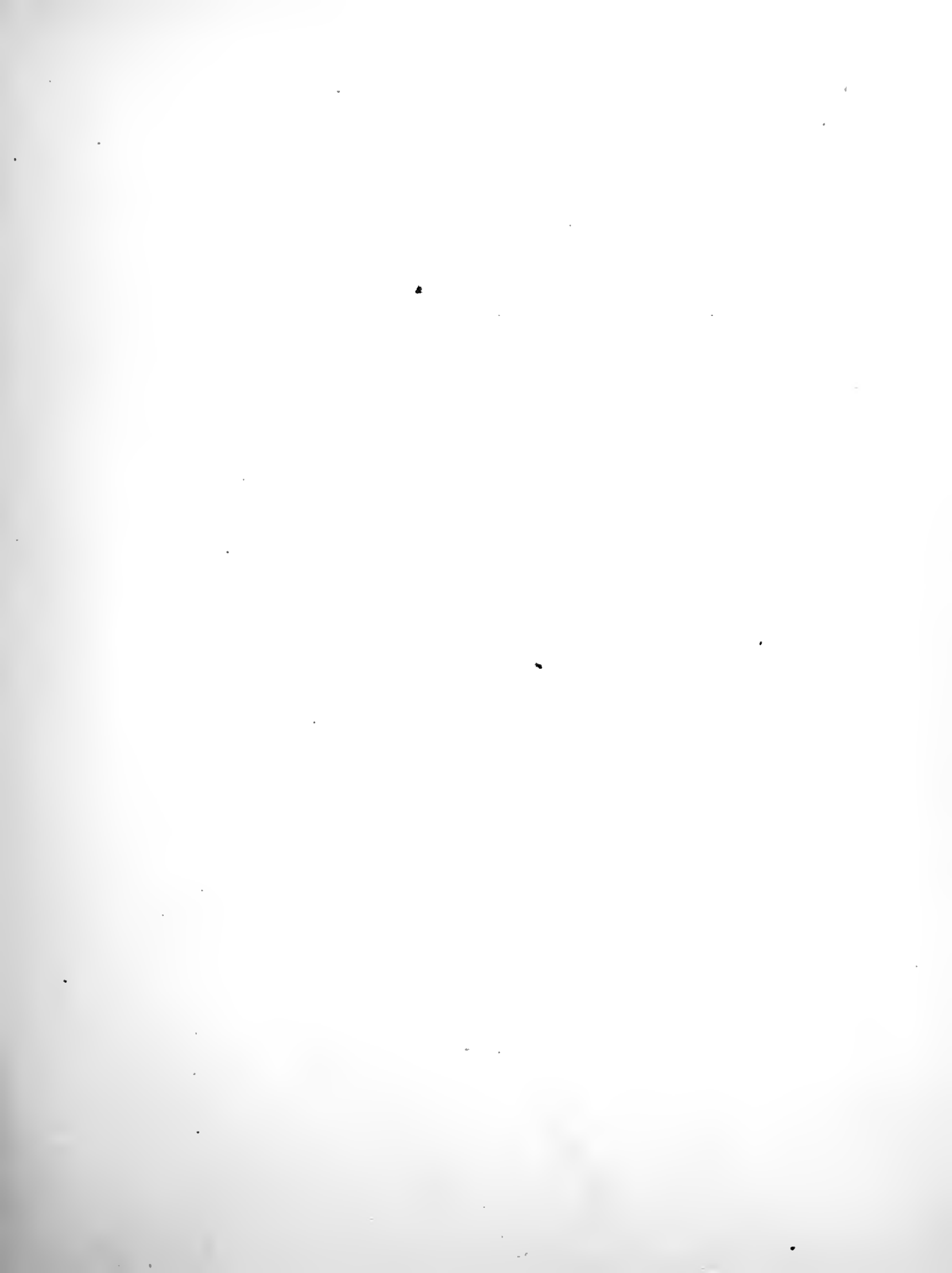



Julius Bien & Co. lith.

SHEEP MT FOLD  
SOUTH SIDE OF



London Fault

Lamb Mt

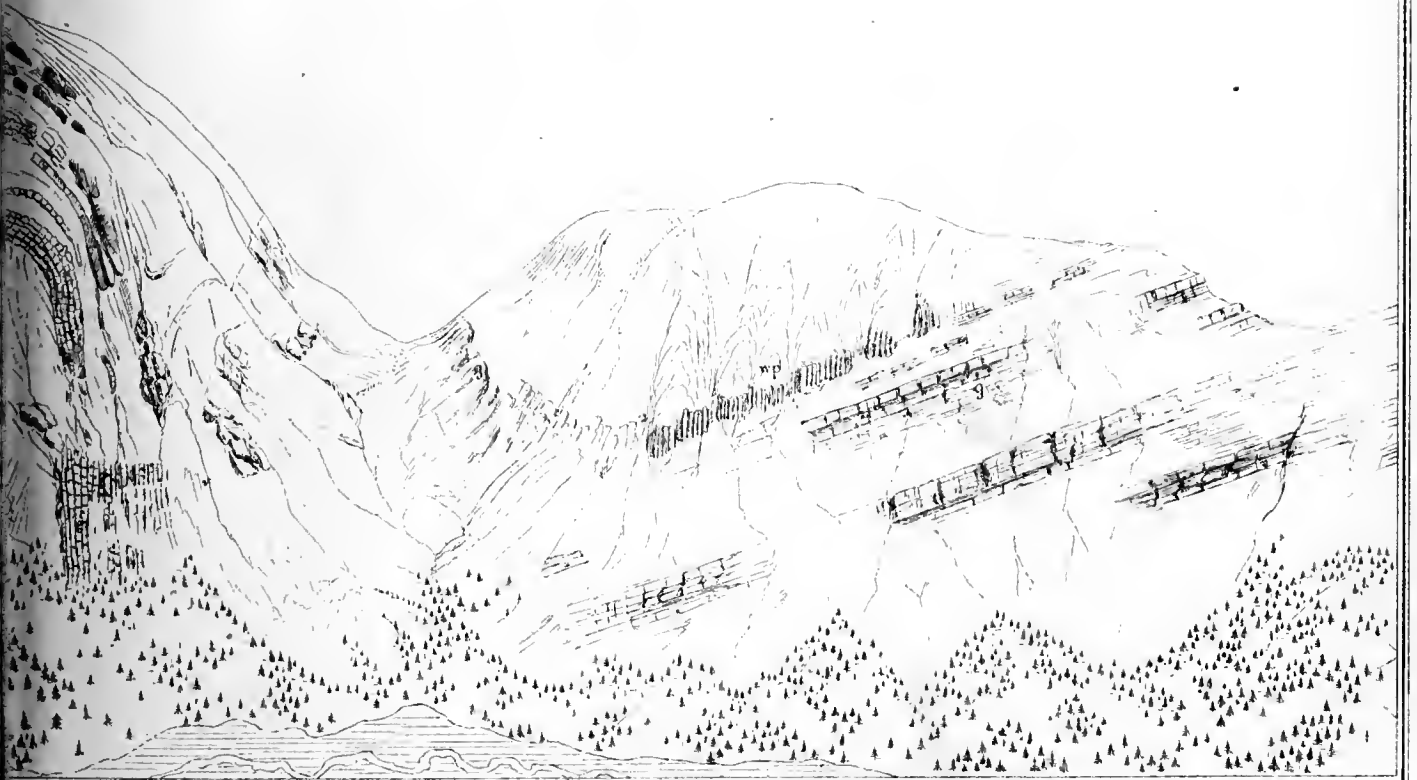

S. F. Emmons, Geologist-in-Charge

LONDON FAULT.

SHOE GULCH



fault on the west are always found to stand at a nearly vertical angle. The Lamb Mountain laccolite, it must be borne in mind, is at a higher horizon than the main sheet of White Porphyry. It may be an irregular offshoot from the White Ridge laccolite, or, as shown in Section G, simply an extrusion from the main sheet.

*Sheep Mountain.*— Sheep Mountain itself is an important peak, having an elevation of over two thousand feet above the bed of the gulch and forming the northern culmination of a ridge running in a nearly northwest and southeast direction, whose form is closely connected with its geological structure, since the line of fault south of Sheep Mountain follows approximately its crest. The internal structure of the peak is best exposed on the north face, a view of which is shown in Plate XVIII. The eastern slope of Sheep Mountain is a little less steep than the dip of the beds, for which reason the White Porphyry which crowns its summit is denuded over a considerable portion of the slope, and comes in again at the foot, where the slope becomes more gentle. The western side of the fold, as shown in the sketch, is very nearly vertical. In point of fact, however, the angle is a little over the vertical, or, in other words, the beds dip slightly east, as shown in section G. This is not apparent, however, on the cliff, from the fact that its plane is not exactly at right angles with the axis of the fold. Here, again, as in the Sacramento arch, the series of beds when vertical appear thinner than when standing nearly horizontal; in other words, they seem to be compressed between the arch of the fold and the plane of the fault, which is not at all impossible or even improbable. Unfortunately, it could not be determined by actual measurement, as there was no continuous outcrop of the vertical beds.

A section was carefully made across the beds from the crest of the fold to the summit of the peak by Mr. Cross, from whose notes most of the following data are taken. The Archean exposures are mainly of gneiss and their bedding is comparatively distinct. As well as could be ascertained, the beds stand nearly vertical and have an east and west strike, or at right angles to the axis of the fold. Adjoining the vertical Cambrian beds was noticed a little irregular dike of White Porphyry about four feet in thickness, which comes out of the gneiss nearly parallel to the strike of the

quartzite and then cuts obliquely into the latter for a short distance; it then follows the bedding-plane for a few yards, and, again cutting across the strata, disappears under the débris. The measurements were made with a pocket level, checked by observations with an aneroid barometer, taken at the base and again at the summit of the cliff; the discrepancy between the two measurements amounting to only a few feet.

Section from top of Sheep Mountain downward:

	Fect.
	White Porphyry, 300 to 400 feet.
Lower Carboniferous..	Blue Limestone, brecciated at top, with abundant secretions of black chert..... 180
	Lighter-colored limestone ..... 20
	200
Silurian .....	Parting Quartzite, fine grained, white ..... 70
	White Limestone, silicious at base, with white chert secretions ..... 160
	230
Cambrian .....	Red cast beds ..... 8
	Shales, interbedded with "sandy limestones" ..... 30
	Reddish, fine-grained sandstones, with indistinct im- pressions ..... 40
	Gap .. ..... 10
	Quartzite ..... 22
	White Porphyry, 12 feet. White contact quartzite ..... 65
	175
Archean ..	605
.....Gneiss.....	

The total thickness here obtained of the lower Paleozoic series, which is 605 feet, is a little greater than that obtained at other points, which may possibly be due to the swelling of the beds that would naturally succeed a compression, if such exists, on the side of the fold next the fault. The contact of the White Porphyry and underlying Blue Limestone, which was here visible over a considerable distance, was carefully studied, especially on the side of the fold next the fault. The upper part of the Blue Limestone is particularly dark and full of black chert. The actual line of contact is marked by a breccia, whose character varies much. Now it is composed mainly of White Porphyry fragments, then of chert, and again of a mixture of both with black shale or limestone. Sometimes arms of the White

Porphyry penetrate the mass of limestone. On the steep southwestern slope of Sheep Mountain, overlooking Sheep Park, the brecciated surface of the Blue Limestone projects through the White Porphyry. A curious feature of this breccia is the character of its cement, which is crystallized gypsum and quite abundant here, though not noticed elsewhere. The existence of so much breccia at this point would strike the observer on first view as probably due to the action of folding and the friction occasioned by that and the displacement of the fault. Inasmuch as the same phenomena are observed, although on a lesser scale, at the contact in Leadville, where the folding action has been comparatively slight, it is probable that it was induced by a fracture of the more brittle portion of the surface of the limestone in contact with the molten intrusive mass at the time of its eruption. The fragments of porphyry in the breccia do not necessarily militate against the supposition, since the shell in immediate contact with the bounding beds might cool and harden and then be broken up by a fresh body of molten porphyry pushing over it. The gypsum cement is an evidence of the passage of sulphurous waters, which would form sulphate of lime by their contact with the underlying limestone, depositing it again in the crevices of the fragments on the surface. That it still remains here seems to be an evidence that the dissolving action of later waters has not been continued so long as in Leadville, where almost every trace of gypsum has been carried away.

On the southeast slope of Sheep Mountain, near the timber-line, are several rounded foot-hills, between which the White Porphyry and the Blue Limestone are exposed in the ravines, while the Weber sandstones form the surfaces of the intervening ridges. A number of prospect tunnels have been run in these sandstones, disclosing irregular shale formations in the beds and a local development of White Porphyry above the regular body. In one of the tunnels the end of this intrusive body is well seen, showing the beds curving around it, as in the intrusive mass of porphyrite on South Mosquito section. The average strike of the beds here is from N. to N.  $10^{\circ}$  W., and the dip from  $27^{\circ}$  to  $30^{\circ}$  eastward.

As this locality presents the most typical development of White Porphyry outside of the immediate vicinity of Leadville it may be well to

describe somewhat in detail the rock as found here. That from the west face of Lamb Mountain (46), which is comparatively fresh, is a compact rock, of a light pinkish-brown color, whose only visible crystals are a few small and well-defined orthoclase individuals. No quartz is to be seen. Minute cavities lined with yellow ocher indicate a former constituent, but the forms of the cavity are not sufficiently well preserved to indicate its character. It may have been pyrite. Under the microscope the rock appears granular, with easily determinable quartz, orthoclase, plagioclase, and muscovite. There is no trace of a microscopic groundmass between the grains. Both orthoclase and plagioclase are abundant, but muscovite is less developed than is usually the case in White Porphyry; contrary to the usual rule, it is as often found forming in plagioclase as in orthoclase. With a low power, the feldspars seem full of fine dust or specks, which in many cases are evidently arranged on the cleavage plane. These specks are also seen, though less frequently, in the quartz. By the use of a higher power it is seen that some of these specks are fluid inclusions, with rapidly moving bubbles, and it is therefore probable that a sufficiently high power would prove that all are similar inclusions. No glass inclusions were found. The main rock on the northwest slope of Sheep Mountain (47) is of porphyritic appearance, owing to the large development of muscovite; otherwise it does not differ microscopically from the Lamb Mountain rock. A contact specimen of this body is so fine grained that its exact composition cannot be made out, yet it does not seem to differ essentially from the average rock. Portions of the body are perfectly white and homogeneous, and when breathed on have a strong earthy smell. The specimens examined contained little, if any, plagioclase and almost no muscovite. The body included in the Weber Grits formation (49) is exactly the same as the ordinary rock. That from the saddle between Sheep and Lamb Mountains contains even more plagioclase than the Lamb Mountain type. That from White Ridge (44), in the Four-Mile amphitheater, is extremely white and very compact, so that the constituents are mostly indistinguishable. The process of alteration from feldspar to muscovite can readily be distinguished by the naked eye.

## SOUTHERN DIVISION.

The remaining portion of the eastern slopes of the range included in the map, south of Horseshoe gulch, presents but few good exposures as compared with the region already described. Its altitude is generally lower and the surface is covered with forest growth and very considerable accumulations of Quaternary gravels; still, the general outline of its structure is not difficult to seize.

**Sheep Ridge.**—From Sheep Mountain to Round Hill the crest of this ridge becomes gradually lower, and beyond the latter it disappears under the plain. Immediately south of the summit of Sheep Mountain is a slight depression, from which the White Porphyry has been eroded off, exposing the underlying Blue Limestone. Again, at the first prominent saddle in the ridge, Blue Limestone forms the crest and the eastern slopes, and beyond this to Warm Spring pass White Limestone outcrops along the crest, showing that the topographical slope descends more rapidly than the geological. At Warm Spring pass fragments of Red-cast beds on the crest indicate that the whole thickness of the Silurian probably comes to the surface here, although no actual outcrops of Cambrian beds could be detected. The steep western slopes of the ridge toward Sheep Creek, in this extent, are formed of easterly-dipping Weber Grits, and are therefore on the western side of the London fault. On the eastern slope the White Porphyry sheet appears to be continuous above the Blue Limestone, and at the Warm Spring pass has thinned out to 20 feet. The so-called Warm Spring furnishes a considerable flow of water, of a temperature of about 60°, from the upturned strata near the base of the Blue Limestone. South of Warm Spring pass, judging from the meager data afforded by outcrops, the geological slope becomes greater than the topographical. The Blue Limestone forms a cliff half way up the slope on the south side of the pass, and beyond this the only rocks found on the surface are those belonging to the Weber Grits; these on Round Hill have an anticlinal structure, dipping to the east, south, and west, although along its extreme western face an eastern dip is again found, which is the commencement of the slope of the beds upwards toward the crest of the main range. The explanation of the structure of this portion of the hill is that the fault movement has died out and only the fold remains.

The surface of the South Park, east of Sheep Ridge, is uniformly covered to a considerable depth by Quaternary gravels, the only outcrop of underlying beds within the limits of the map being north of the bend of Four-Mile Creek, where an anticline in the Weber Grits can be seen, a continuation of the secondary roll already noticed to the north. East of the limits of the map the approximate location of the Triassic beds is indicated by the red color of the soil, and the more resisting beds of this and the higher formations form low north and south ridges, which rib the surface of the park. With these are associated sheets of eruptive rock, probably analogous to the intrusive sheets already described. On one of these ridges was found the rhyolite tufa which is described in Appendix A.

**Black Hill.**—Out of the South Park plain, at the extreme southeast corner of the map, rises to a height of about 600 feet an isolated, forest-covered hill, nearly circular in shape, known as Black Hill, only the northern edge of which comes within the limits of the map. It is entirely composed of rhyolite (140). The occurrence is interesting on account of the rarity of Tertiary eruptive rocks in the region under consideration. It is noticeable that it is on a direct line with the continuation of the London fault, and that the prolongation of the same fault to the northwest would nearly pass through the other occurrences of rhyolite in Chalk Mountain, on the northern edge of the map. The whole mass of the hill is composed of rhyolite, as far as can be distinguished. The outflow has apparently taken place through the upturned sedimentary beds and spread out over their edges, without, however, exercising any very marked influence on their structure lines, as is the case with the secondary intrusive masses. The outcrops of these sedimentary beds are somewhat obscure, being mostly covered by surface accumulations, but, from their lithological character and from the succession observed along the valley of the Little Platte, south of the limits of the map, they are assumed to belong to the horizon of the Upper Coal Measure formation. On the northern base of the hill is a considerable accumulation of impure gypsum in mud shales. Directly south of the hill, along the basin of the Little Platte, quite a succession of thin-bedded clay shales, with some limestone beds, is found, standing nearly vertical and striking due north and south. In a prospect hole these shales are seen to be remarkably con-



torted, which is probably due to the original compression of the beds, and not dependent on the outflow of rhyolite. The lines of strike, so far as observed, run continuously through the hill, and do not curve round it. Almost the whole surface of the hill is covered with loose fragments, detached through frost and atmospheric action, but its south and southeast faces present steep cliffs. On the lower northeastern slopes of the hill are two or three large boulders of coarse reddish granite, half buried in the soil, in company with quartzites and sandstones, which are evidently erratics and show that at one time the glacier from Twelve-Mile Creek reached down as far as this.

The rhyolite of Black Hill is remarkably uniform in general character. It has a delicate pinkish-gray color, a conchoidal fracture, and shows in the unaltered specimen white glassy feldspars, fresh black mica, and some hornblende, with prominent and rather smoky quartz in a distinctly marked groundmass. The existence of this groundmass makes a marked distinction from the rhyolite of Chalk Mountain, which is seen macroscopically to be made up entirely of crystalline elements. To the naked eye it is apparent that the quartz contains many bays of the groundmass. Under the microscope the groundmass is seen to be entirely microcrystalline, being composed mainly of quartz, with some rather cloudy feldspars. The large feldspars are plagioclase in part and contain a few gas pores and some fluid inclusions, which often carry cubes of a mineral like salt. Undoubted glass inclusions are not visible, but there are some dihexagonal in form, which are either devitrified inclusions or represent the character of the groundmass at a time prior to its complete crystallization. In decomposition the feldspars seem to tend more to a kaolin substance than to muscovite.

**Twelve-Mile Creek.**—In the region between Sheep Ridge and the main crest of the range are the valleys of Twelve-Mile and Sheep Creeks. The surface is covered with outcrops of Weber Grits formation, or, in its lower portion, with surface gravels, either actual moraines or rearranged drift material. At the head of Sheep Creek, near the south base of Lamb and Sheep Mountains, is a little valley or park, bounded on the north and east by steep talus slopes of débris from these peaks, and by forest-covered spurs of Weber Grits on the south and west. On the broad ridge between Horse-

shoe and Twelve-Mile Creeks the shallow syncline in the Weber Grits, already mentioned, can be traced as far as the Twelve-Mile gulch. It is only in the deeper cuts near the crest of the ridge that the details of structure are distinctly visible. Twelve-Mile Creek heads in four separate basins or amphitheatres, to the distinctness and grandeur of whose forms the scale of the map can do but scant justice. The exposures of Archean rocks in these amphitheatres present a great variety of gneiss and granite, the most noticeable of which have already been described in Chapter III. The deeper of these amphitheatres is that to the north, whose northern wall is capped by beds of the lower Paleozoic series, the Lower Quartzite forming, as shown on the map, the crest of the range at its head. The sheet of White Porphyry above the Blue Limestone has a broad outcrop, prominent by its white color, extending across from Horseshoe Ridge and sweeping down the wall across the mouth of the amphitheater. On the ridge between this north amphitheater and the one adjoining it, a shell of Lower Quartzite still remains at its eastern end. South of this, Paleozoic outcrops are confined to the meadows at the lower extremity of the amphitheater, where a number of springs come from them. On the south wall of the southern amphitheater the lower Paleozoic beds again sweep up for a considerable distance on the spur, the white quartzite of the Cambrian and the interbedded White Porphyry being prominent by their color. The eastern end of this ridge is formed by the continuation of the main White Porphyry body; while along its wall can be traced an offshoot from this body, cutting across the Blue Limestone and occupying the horizon between the Blue and the White Limestone. The white quartzite extends nearly up to the prominent shoulder of this spur, and is found again on the very summit of Weston's Peak, at the head of the spur. Here it lies nearly horizontal, bending over slightly on its western edge. This mass of quartzite is evidently, as shown in Section H, a remnant of the crest of the anticlinal fold, whose axis relatively to the present slope of the ground is descending to the southward. The outcrops of the sedimentary beds on the east of the axis, therefore, gradually rise along the eastern slopes of the ridge; their outlines as shown on the map present a series of regular curves, due to the erosion of the ravines which score the surface, which are distinguishable in the

field from a considerable distance through the whiteness of the quartzite and of the interbedded White Porphyry. The anticlinal fold of the main crest, like that of Sheep Ridge, gradually dies out to the south of the map, and at Buffalo Peaks has entirely disappeared, being merged into a single monoclinal continuation of that to be described on South Peak.

Weston's pass.—On the steep western face of the crest, towards the valley of the Little Platte below Weston's pass, the Lower Quartzite and White Limestone beds lie at an angle of  $45^{\circ}$  to  $50^{\circ}$ , resting against the steep slope of the hill like tiles on a roof. The valley of the Little Platte presents a somewhat singular structure. At first glance it is a simple synclinal fold. On the east side are the beds of the Lower Quartzite and White Limestone dipping steeply westward, while on the west they rise with the slope of the next ridge, which from South Peak southward forms the main crest of the range. More careful examination, however, shows that the series of beds on either side of the syncline do not exactly correspond, and that the change from eastern to western dip is abrupt and not gradual, as it should be in a normal syncline. The bottom of the valley, where outcrops are visible, shows the Blue Limestone dipping eastward, and above it a thin bed of White Porphyry, succeeded higher up by sandstones and black shales of the Weber Grits formation. Through the latter, near the head of the Little Platte, and just at the boundary of the map, a branch from the northeast has cut a deep, picturesque gorge. Climbing the eastern slopes of the gorge to the main ridge, across easterly dipping Weber Shales, one comes suddenly, at the foot of the steeper slope, upon beds of White Limestone dipping steeply to the westward. It is evident, therefore, that the movement of the Weston fault has been continued somewhat beyond the boundary of the map, though it dies out before the Little Platte takes its bend to the eastward, just south of this boundary.

On the summit of Weston's pass the structure can be more clearly seen, though it is complicated here by a sudden curve in the beds which form the western member of the fold, giving them for a short distance a strike nearly east and west, instead of northwest and southeast. This pass, which has an elevation of only 11,930 feet, was formerly the main approach to Leadville from the east. Its summit is a low saddle, on the east of which

the steep granite wall of Weston's Peak rises over 1,500 feet in a distance of about half a mile. At the very summit of the pass is a thin bed of White Porphyry, overlying considerable outcrops of Blue Limestone, very much metamorphosed and iron-stained, and dipping from  $35^{\circ}$  to  $45^{\circ}$  to the north and east. West of this the underlying White Limestone and Lower Quartzite sweep up, at a gradually shallowing angle, almost to the very summit of South Peak. On the eastern side of the pass black shales and quartzitic sandstones of the Weber Grits can be traced for several hundred feet up the face of the slope. These are suddenly cut off by a bed of white quartzite, standing at an angle of  $70^{\circ}$  to the westward, and succeeded on the east by granite and gneiss. Between the two is the line of the Weston fault. Following this line southward around the angle of the upper spur to the basin at the foot of Weston's Peak, the quartzite becomes steeper and finally bends over with an angle of  $50^{\circ}$  to the westward. The actual fault line cannot be traced, inasmuch as it is covered by the talus slope. The thin bed of fine-grained brown conglomerate which forms the base of the Lower Quartzite, in contact with the Archean, is, however, not to be mistaken. In the Archean itself there seems to be a tendency to a bedded structure parallel with this lower bed of the Cambrian, and, moreover, a sort of actual passage from sedimentary into crystalline rocks, as shown by an increasing development of well-defined crystalline feldspars. These transition beds pass into a peculiar granite of yellowish-red color. It belongs to the coarsely crystalline type, and apparently owes its color to the hydration of the oxide of iron, which gives the flesh-colored tint to the orthoclase of the normal granite of the region.

**South Peak ridge.**—From Weston's pass southward the South Peak ridge, which follows approximately the direction of the major strike of the formations, viz, S.  $20^{\circ}$  to  $30^{\circ}$  E., constitutes the main crest of the range. The summit of this ridge and its eastern slopes are covered with a thin shell of Lower Quartzite beds, whose dip, quite gentle on top of the ridge, steepens to  $45^{\circ}$  on the eastern spurs. Archean exposures cover the whole western slope of the range south of Weston's pass and are disclosed in the deeper cañon cuts on the east side by erosion of the overlying quartzites.

From Weston's pass to the north base of Buffalo Peaks, a distance of about 10 miles, the upper valleys of the Little Platte and of Rough-and-Tumbling Creek form a continuous line of depression parallel to this ridge. These two streams bend to the eastward and flow together at the southern end of the Weston's Peak ridge, where the anticlinal fold dies out as the ridge disappears under the plain. It is here that the geological structure of the range changes from a double anticlinal to a single monoclinical ridge, a change which is shown in the varying strikes and dips of the low hills at the junction of these streams. Along upper Rough-and-Tumbling Creek the Paleozoic beds all dip eastward in apparent conformity, though with some variation of angle, and continue their regular southeast strike, not only close up to the base of the Buffalo Peaks mass, but apparently beyond it, without any sensible change of direction. It would appear, therefore, that the flows of andesitic lava, of which these peaks consist, have been poured out through the upturned strata and spread out across their edges, covering thus a geological horizon extending from the Archean up to the Upper Carboniferous, or possibly the Trias, in marked contrast to the manner in which the intrusive sheets of the earlier eruptives have been formed.<sup>1</sup>

**Western slopes.**—From Weston's gulch southward beyond the limits of the area mapped, the western slopes of the range are composed of Archean rocks, among which granite is very prominent. There are doubtless many eruptive dikes cutting through them in this area besides those of White Porphyry at the mouth of Granite Creek, represented on the map, but time did not admit of a sufficiently detailed examination to determine their outlines and location.

Weston's gulch, below the junction of its two heads or forks, which run with the strike of the formations northeast and southwest, is a straight narrow gorge cut out of Archean granite and gneiss. Its form suggests partial glacier carving, but later erosion has removed all traces of moraine material except a few erratics. Below this narrow gorge it passes into an open country, occupied by partially eroded terraces of the Quaternary Lake

---

<sup>1</sup> A more detailed description of the Buffalo Peak region will be found in Bulletin No. 1, United States Geological Survey, Washington, 1883.

beds, which will be described later. The Archean area, with its covering of Lake beds on the lower spurs, extends north as far as Empire gulch, but beyond that line it no longer outcrops, except where brought to the surface by faulting and erosion in the deep amphitheatres near the crest of the range.

**Weston fault.**—From Weston's pass northwestward the Weston fault follows the foot of the steep western slope of the main crest of the range, approximately parallel to and a little east of the valley bottoms of the two forks of Weston's Creek. East of it are Archean exposures, capped, either on the crest of the range or on its eastern slopes, by easterly dipping Paleozoic beds. To the west is a fringe of successive outcrops of the same beds, also dipping regularly eastward, whose varying outlines, as shown on the map, are entirely due to the relative depth of erosion of the various gulches. Were the structural conditions studied on a single transverse line in this area they would be naturally supposed to be those of a simple monoclinical fault; but the unmistakable evidence of the synclinal fold, as already described on Weston's pass, and the conditions found on Empire Hill, which will be described below, show that before erosion had removed it there must have been a fold somewhat as indicated by the dotted lines in Section G, Atlas Sheet IX. From the pass down the south branch of Weston's Creek nearly to the forks, the Lower Quartzite extends up the west slopes of the valley, while the Blue Limestone forms a decided shoulder on the eastern slopes; the White Porphyry body, which is only about twenty feet thick at the pass, thickens to the northward and by its white color forms a prominent feature in the landscape.

Just above the forks the north branch of Weston's Creek runs in a narrow ravine, in which the dip of the beds is somewhat steeper than in the south branch, which may be explained by its proximity to the fault line. On the northwest side of this ravine the Paleozoic beds sweep up on a broad flat shoulder, which forms the southern continuation of Empire Hill, gradually assuming a shallower dip as they extend farther westward.

**Empire Hill.**—This name is given to the upper part of the spur between Weston's and Empire gulches and the broad shoulder or secondary ridge lying between the branches of these gulches and the head of Union gulch.

Along the steeper western face of this shoulder the Cambrian and Silurian outcrops rest on the Archean, and the top of the shoulder is at the contact of the Blue Limestone and overlying White Porphyry, which has been quite extensively prospected, without, however, disclosing any considerable ore bodies.

At the head of the north branch of Weston's gulch the ridge which separates it from Empire gulch presents a steep slope to the southward, which affords a good section of a series of limestones, shales, and sandstones in a thickness of from 300 to 600 feet, belonging to the Upper Coal Measures, from which the following fossils were obtained:

*Archæocidaris*, sp. undet.  
*Polypora*, sp. undet.  
*Fenestella perelegans*.  
*Synocladia*, sp. undet.  
*Rhombopora lepidodendroides*.  
*Paleschara*, sp. undet.  
*Streptorynchus crassus*.  
*Chonetes granulifera*.  
*Productus costatus*.

*Macrocheilus ventricosus*.  
*Phillipsia*, sp. undet.  
*Productus Nebrascensis*.  
*Chonetes glabra*.  
*Spirifera Rockymontana*.  
*Athyris subtilita*.  
*Productus Prattenanus*.  
*Nucula*, sp. undet.  
*Astartella*, sp. undet.

Section F, Atlas Sheet IX, which passes through the ridge, shows the structural conditions which prevail here. Where these beds join the fault they stand quite vertical and give evidence of having been subjected to great pressure, as shown in the specimen represented in Fig. 2, Plate V (page 60); but at a little distance from the fault it can be seen that near the top of the ridge they gradually bend over to the westward, until a few hundred yards west they assume the normal dip of  $20^{\circ}$  to the eastward. Below these, both on the ridge and in geological succession, are the sandstones of the Weber Grits, which form the mass of a low rounded hill. Along the western face of this hill, and immediately above the White Porphyry, is a considerable thickness of compact black argillaceous shale, impregnated with pyrites. This black shale has been opened in several places by prospect holes, and from it were obtained numerous casts of fossils, in which the calcareous matter of the original shell has been entirely replaced by very minute crystals of iron pyrites, so minute that the form of the shell is still distinctly visible in those which are newly opened, though they rapidly decompose on

exposure to the air. The contrast of the glittering yellow of the pyrite with its dull-black background of shale is extremely beautiful. This bed of black shale represents the base of the Weber Shale formation. From it were obtained the following forms :

*Discina Meeki.*

*Orthis carbonaria.*

*Chonetes granulifera.*

*Streptorhynchus crassus.*

*Aviculopecten rectilaterarius.*

Below the black shales is the main sheet of White Porphyry in considerable thickness, succeeded by the Blue Limestone which forms the eastern edge of the spur or shoulder, while the White Limestone and underlying quartzite can be traced along the steep slopes below. The series is here, therefore, complete from the Lower Quartzite up to the Upper Coal Measure; and, even had the fossils obtained in the latter not been found, the existence of such considerable thicknesses of limestone above the Weber Grits would have been enough to determine their horizon. The gradual passage observed from the shallow dip of  $20^{\circ}$  to the vertical dip adjoining the fault is proved by actual observation and furnishes an analogy for the vertical dips already observed at the London fault. The fault line itself is exposed in a tunnel and is exceptionally distinct on the ridge, its direction being here N.  $25^{\circ}$  to  $30^{\circ}$  W.; the adjoining rock on the east is a coarse-grained granite and on the west shales and grits. Where opened, the fault shows slickensides and a considerable development of clay selvage, with a fine breccia of very dark color, the result of friction. In the granite adjoining the fault there is visible decomposition for some ten or fifteen feet, consisting in a partial kaolinization of the feldspars and a hydration of whatever oxides of iron it contains, which is evidently due to the action of waters which have followed the plane of the fault.

In the basin at the head of the north fork of Weston's gulch, only a few feet east of the line of the fault and apparently parallel with it, is a vein of quartz in granite, some six or eight feet in thickness, which can be traced up the wall of the ridge. In the first saddle of the ridge above Empire Hill is a dike of White Porphyry about twenty feet thick, in the vicinity of which the granite is decomposed in a manner similar to that near the Weston fault. This saddle is on a line with the fault which runs between Sheridan



and West Sheridan, and although at this point, owing to the fact that granite is on either side and the surface is largely disintegrated, the fault could not be visibly distinguished, it is supposed that the Sheridan fault crosses this saddle to connect with the Weston fault. The White Porphyry dike would thus at first glance seem to be due to an eruption which had taken place along the plane of an already existing fault; but the evidence obtained elsewhere all goes to show that the time of eruption of the White Porphyry was entirely antecedent to the action of faulting; and it is therefore more probable that the White Porphyry dike had followed a line of weakness or possible fracture, which in the subsequent dynamic movements would have been more susceptible to faulting than other portions of the formation.

Between the head of Union gulch and Empire gulch, below the steeper slope of Empire Hill, is a triangular area in which are relics of the lower Paleozoic series, with included porphyries, which have been folded and faulted in an extremely intricate manner. A simple expression of their structure is shown in Section E, in which it is seen that at the foot of the steep slope of Empire Hill a second fault has cut off a portion of a synclinal basin. The upper member in the trough of the syncline is the White Porphyry, immediately overlying the Blue Limestone. A shaft has penetrated this porphyry into the Blue Limestone below. On the east of the syncline the beds dip  $25^{\circ}$  to the westward, while on the west side they dip at an average of  $10^{\circ}$  to the eastward. The southern extremity of the fault is seen near the forks at the head of the north branch of Union gulch, where a little patch of Lower Quartzite rests against the fault, with granite on either side.

Here occurs a singular eruption, apparently in the form of an interrupted dike, of a rock whose lithological characters ally it to the Tertiary eruptives. It has been colored on the map as a rhyolite, though it might more strictly be classed as a quartziferous trachyte. It is a rather fine-grained grayish rock, of thoroughly trachytic texture, whose most prominent elements are small glistening hexagonal leaves of biotite; a few rounded grains of quartz are also visible, and the rest of the rock is made up of small, rather glassy grains of feldspar. Between the crystalline elements is an ill-defined groundmass of gray color. The rock has included fragments of quartzite. Parts of the groundmass are truly microfelsitic, and in some

places undoubted glass substance is present. The rock also contains fragments of another eruptive rock, in some respects resembling the Gray Porphyry, and in whose cryptocrystalline groundmass are numerous aggregates of tridymite.

From the head of Union gulch northward, on the west of the syncline, the outcrops of Lower Quartzite and White Limestone grow wider, owing to shallowing dip, till they are cut off by the valley of Empire gulch, and are succeeded on the west by the underlying granite. On either side of the syncline the Blue Limestone forms prominent outcrops or ridges. On the north end of the syncline, toward the ravine which runs down to a little lake adjoining the meadow of Empire gulch, is a small body of Gray Porphyry, apparently occurring between the Blue and the White Limestone. Following the line of the fault northward from the head of Union gulch, the Lower Quartzite, White Limestone, and Blue Limestone are found successively in contact with the granite; and finally the White Porphyry almost touches it. Farther north the series is reversed, until in the bed of the ravine at the foot of the north end of Empire Hill granite is exposed on either side of the fault. There is here an anticlinal fold whose axis corresponds with the major strike and from whose crest the sedimentary series have been removed down to the Lower Quartzite. Continued north, the line of the axis of this anticline nearly corresponds with the Mike fault, which is first seen on the north wall of Empire gulch and which will be described in detail in the chapter devoted to the vicinity of Leadville.<sup>1</sup>

Union fault, which thus far has followed the foot of the steep slope of Empire Hill, now cuts across the northwest spur of this hill, and beyond Empire gulch, after crossing Long and Derry Hill, joins Weston fault. The displacement of this fault, like that of most of the faults of the region, is an upthrow to the east. Consequently in ascending the steep northwest spur of Empire Hill from the meadows in Empire gulch or from the anticline above mentioned, one crosses a double series of easterly-dipping lower

---

<sup>1</sup>By an error of the engraver, overlooked in proof-reading, the line of Mike fault has been carried across Empire gulch to a connection with Union fault, following what was intended to be simply the dividing line between the Cambrian and Silurian formations.

Paleozoic beds. At the foot of the steep slope, between the Lower Quartzite and the White Limestone, is a small body of eruptive rock whose outcrops are so obscure that its structural relations could not be accurately determined. It is a fine-grained, nearly white rock, with minute specks of biotite and small white feldspars macroscopically visible as porphyritic constituents. Microscopical and chemical examinations show it to be an orthoclastic rock, containing 68 per cent. of silica. Glass inclusions occur in both quartz and feldspar, but no fluid inclusions. It has been classed as a rhyolite and is chiefly interesting on account of its isolated occurrence and want of resemblance to any other rocks found in the region.

Empire gulch. — Empire gulch is one of the glacier-carved valleys of the western slope of the range. At its head is a grand amphitheater cut out of granite and gneiss, with a rim of sedimentary strata and intrusive porphyry sheets crowning its wall. Two faults theoretically cross its upper portion — the Sheridan fault and the Mosquito fault — which, however, are not visible in its Archean bed, as there is no distinction in the character of the rock on either side to mark their position. At the Weston fault, however, the Lower Quartzite occurs in the bed of the gulch, with an eastern dip, and its outcrops sweep up the wall on either side; these outcrops are partially masked by two very well defined lateral moraines which border the immediate bottom of the valley.

On the south side of the gulch, in the basin inclosed by the north arm of Empire Hill, is a shallow glacier lake, dammed up by one of these moraines. In this basin prospect holes prove the existence of black shales and overlying Weber Grits above the lake, while below it is the Blue Limestone, succeeded by the White Limestone and Lower Quartzite, the line of the Union fault being marked by the sudden appearance of White Porphyry, which adjoins either of these two formations. Above the White Porphyry, on the steep slope at the north point of Empire Hill, immediately west of the fault, is a little remnant of Weber Shale.

The moraine ridges terminate about a mile below this north point of Empire Hill. Here the valley of Empire gulch opens out into a broad alluvial meadow, below which it is cut mainly out of Quaternary Lake beds,

and consequently loses the distinctive form due to glacial erosion. The succession of beds crossed in descending the ridge from the north point of Empire Hill to this meadow is sufficiently indicated on the map.

On the north side of the gulch the structure is even more complicated than on the south, and the rock surface is more obscured by morainal and other detrital material. Were it not for the numerous prospect holes this structure could hardly have been unraveled. It is shown in much more detail on the large map of Leadville and vicinity, and its description is reserved for the chapter which treats of that region.

Leaving aside then, for the moment, the region included within the limits of this map, the crest of the range and that portion of its western slope not included therein will next be described.

**Main crest north of Ptarmigan Peak.**—At Ptarmigan Peak and for some distance north the entire ridge is composed of Archean, in which granite and coarse porphyritic gneiss are the main components; thence north to Horse-shoe Mountain successive shells of Lower Quartzite, White Limestone, Parting Quartzite, and Blue Limestone form the crest. Round the head of Empire gulch their outcrops form a semicircular rim, sweeping round the western point of Mount Sheridan, while the crest of the ridge is covered by the main body of White Porphyry. Under Peerless Mountain a second body of White Porphyry comes in between the Blue and White Limestones, and extends as far north as the base of Dyer Mountain, where it seems to pass down to successively lower horizons, until in Dyer amphitheater it is found quite at the base of the lower Paleozoic series. Remnants of this second body of White Porphyry form the cap-rock on the western spur of Mount Sheridan, known as West Sheridan, whose mass, by the slight movement of displacement of Sheridan fault which runs through the saddle separating these two peaks, has been let down relatively to the mass of Mount Sheridan itself; in other words, its upthrow is to the eastward. This rather singular fault passes partly across the head of Iowa Amphitheater, where it is joined by a fault at right angles to it, or running nearly east and west; as the result of their movement, a little segment of beds of the Lower Quartzite, White Limestone, and overlying White Porphyry is left in the

bed of the gulch at the entrance to the north branch of this amphitheater, their northern and eastern continuations being found near the top of the adjoining cliffs.

**Lake beds.**—From a little south of the mouth of Weston's gulch north to the valley of the East Arkansas, the gently-sloping, flat-topped, lower spurs of the range are formed of the Lake bed deposits already described. Actual outcrops of these are only found in the southern portion of this region, as in the neighborhood of Leadville they are covered by rearranged moraine material, which has received the local name of "Wash." The best opportunities for observing these within the area of the map are on a narrow ridge south of Little Union gulch and along the south wall of Lower Empire gulch. At the former locality is exposed a thickness of 300 feet of outcropping beds sloping regularly  $3^{\circ}$  to the westward, which is also the slope of the adjoining mesa-like ridges. They consist of gravel and coarse sand, alternating with beds containing large subangular or partially rounded fragments of the various rocks which make up the higher portions of the range. On the top of the ridge facing lower Empire gulch they have been opened by prospect holes, and show a conglomerate with lime cement overlying a bed of granite sand, with one iron-stained streak between. Here the dip is still  $3^{\circ}$  to the westward, but in the bed of Empire gulch, where the stream is deflected from its course by a knob of Archean granite projecting about 150 feet above the valley, they are found to have a dip of  $15^{\circ}$  to the northeast, showing that there has been some local movement since they were deposited. There are several outlying patches of these beds left high up on the spurs in the region shown on the Leadville map. Since the presence of the beds within this area could only be proved by underground workings, the outlines there given are necessarily somewhat hypothetical, and may be subject to change when they shall have been pierced by shafts at other localities. The highest points at which their existence has been proved in this area are on the western slopes of Long and Derry and Printer Boy Hills, respectively, where they extend up to the 11,000-foot curve. This is just 1,000 feet above the outcrops between Little Union and Empire gulches, and higher than the dip of  $3^{\circ}$ , already a very considerable inclination for an average angle of deposition over a large area, would carry

them; this, taken in connection with the observed angle of  $15^{\circ}$ , leads to the inference that the mountain mass has been elevated to some degree above the Arkansas Valley since the beds were deposited.

#### NORTHWESTERN DIVISION.

The northwestern division comprises the area west of the Mosquito fault and north of the area of the Leadville map. It is a region which is comparatively unbroken by faults, and from its lower elevation one in which the structure lines are more difficult to read, owing to want of continuity in the outcrops. Between this and the area last described lies the complicated region represented on the Leadville map, which will be treated in the following chapter. Its broad general features, so far as are necessary for the comprehension of what follows, may be given in a few words. The sedimentary beds, within which was an enormous development of eruptive rocks, largely in the form of intrusive sheets, have by the force of contraction been compressed into a series of anticlinal and synclinal folds, and broken by transverse fractures or faults, only two of which extend out to any considerable distance beyond this area, viz, the Weston fault on the south and the Mosquito fault on the north, which are practically part of one great displacement. As shown on the western ends of Sections D and E, by these faults the area is broken into blocks, which have been successively lifted one above the other toward the crest of the range. These faults have in general some definite relation to the axis of the folds, and as they pass northward merge into them. Thus out of the six faults represented on Section E two have already disappeared before reaching the line of Section D, and on the line of Section C, which passes through Prospect Mountain along the northern edge of the Leadville map, the structure has simplified itself into two broad anticlines, with an included syncline, and there is no visible fault west of the Mosquito fault.

**Prospect Mountain.**—The surface of the massive of Prospect Mountain, which lies between Big Evans and Bird's Eye gulches and extends from the Mosquito fault to the east fork of the Arkansas, is covered to a considerable depth by broken masses of porphyry and of sandstones and schists of the Weber formation, so that but few outcrops are found. Fortunately

there are many prospect holes, showing the character of the rock beneath the covering of débris, by means of which the general outlines of its structure can be determined. These are shown in Section C, Atlas Sheet VIII, and in Section K, Atlas Sheet X, the former of which follows the crest of the ridge in an east and west direction, while the latter crosses it in a north-west direction. From these it is seen that from the summit of Prospect Mountain eastward to the Mosquito fault the surface is occupied by beds of the Weber formation, with a general easterly dip. They are crossed by a few dike-like masses of eruptive rocks, the most prominent of which are two dikes on the crest of the ridge: the one a coarse-grained quartz-porphyry, with large crystals of orthoclase, which resembles a Gray Porphyry; the other a fine-grained micaceous rock resembling a diorite, but yet containing a large proportion of orthoclasic feldspar. The latter rock also occurs on the north slope of the massive near the head of Indiana gulch, and in an important body at the mouth of Bird's Eye gulch where it debouches into the East Arkansas Valley. West of the summit of Prospect Mountain, however, the slopes toward the adjoining valleys are very steep and cut through the Weber beds, disclosing a somewhat complicated anticline, or rather the intersection of two systems of anticlines, and the development of a large body of porphyry found only in this mountain and on Mount Zion, which is separated from it by the deep cut of the East Arkansas Valley. This porphyry, which has already been described as a more crystalline variety of the White Porphyry and which is designated by the color of that rock on the map, is called, from the locality of its principal development, Mount Zion Porphyry.

**Mount Zion Porphyry.**—This porphyry is exposed in great thickness under the Weber Grits on Mount Zion and on the northeast slope of Prospect Mountain; it is also denuded at the head of the north fork of Little Evans by the deep erosion of the gulch. It apparently replaces in part the main sheet of Gray Porphyry, which directly underlies the Weber Grits to the north and south of it and thins out as the former grows thicker. For this reason it has been indicated on the sections as a rapidly thickening sheet, though it is not at all improbable that it may be a laccolithic body, like those of White Ridge and Gemini Peaks, and have its vent, or channel

through which it came up, somewhere under Prospect Mountain. It varies much in external appearance: in its most unaltered form, as obtained at a depth of 200 feet in the Hattie bore-hole, it resembles a fine-grained granite or granite-porphry, while in the extreme of alteration, as found in some of the shafts on the southwest slope of Prospect Mountain, it is hardly to be distinguished from decomposed White Porphyry. It differs microscopically from the fine-grained granites by the absence of microcline and by the presence of prismatic microlites of plagioclase with rounded ends, which are particularly abundant in the quartz and orthoclase.

The structure of the southern slopes of Prospect Mountain, which is somewhat complicated, is described in detail in Chapter V, and the relations of the White and Mount Zion Porphyries are shown on the map of Leadville and vicinity, where they have distinct colors. The outcrops of the thin sheet of the former and of the underlying Blue Limestone, which occur along the East Arkansas Valley at the foot of Prospect Mountain, are only proved by prospect holes, the actual rock surface being buried under débris slopes.

**Mount Zion.**—The mountain mass of Mount Zion and its southwestern shoulder, known as Little Zion, presents a somewhat similar structure to Prospect Mountain, of which it originally formed a part, and shows better outcrops by which to trace its geological structure. Towards the valley of the East Arkansas, on the southeast face of Little Zion, are fine cliff sections showing an arch of Archean, over which the Paleozoic beds and included sheets of porphyry are folded, with a steep dip to the northeast and a more gentle one to the southwest. Along the south face of Little Zion the Blue Limestone outcrops can be distinctly traced, gradually descending the hill with a southeast dip until, opposite the brewery in the Arkansas Valley, they come down to the level of the flood plain and furnish raw material to several lime-kilns. At the western extremity of the Little Zion Ridge, beyond the limits of the map and opposite the junction of the East fork with the Tennessee fork of the Arkansas, is a little hill of granite, which is remarkable as being the only place where direct evidence is afforded of any considerable inequalities in the Paleozoic ocean bottom.



In every other case where the junction of the Paleozoic outcrops with the Archean has been observed, practically the same bed of quartzite has been found at the contact. In this case, however, on the saddle east of this little hill, the White Limestone is found to abut against the granite, while the Lower Quartzite sweeps around its northwest and southwest slopes, showing that this point projected as a submerged island above the level of the Cambrian beds at the time of their deposition. In the bed of the stream opposite this saddle the Lower Quartzite beds are exposed in a little cañon gorge, with a strike of N. 30° E., and dipping 20° to the southeast under the Lake beds which cover the spurs up to the steeper slope of the hills near Leadville.

The valley above has alluvial meadows, with flood-plain benches on either side. In these benches on the northwest side is the Dugan quarry, whence limestone was formerly taken as a flux for the Leadville smelters. Higher up the valley, where the beds bend up over the arch of Archean, a careful measurement was made of the cliff-exposures at two points, which, in descending order, are as follows :

1. *Cliffs back of toll-gate.*

	Feet.
	?
	25
Lower Carboniferous .	125
	— 150
	15
	15
	8
Silurian . . . . .	66
	28
	22
	27
	40
	— 221
Débris slopes to valley bottom.	

2. *Section across arch of Archean.*

	{	Débris slopes above cliff.	
Cambrian.....		Saccharoidal quartzite, white and thin-bedded.....	60
		Saccharoidal quartzite, like above, but stained and discolored .....	60
		Coarse quartzite, with fragments of feldspar .....	1
		121	
Archean.....		Red granite; upper beds very much decomposed; red feldspars turned yellow by hydration of iron oxide; 250 feet to base of cliffs.	

The White Limestone seems relatively thicker and the Blue Limestone thinner than usual. The evidence of erosion on the sandstone underlying the latter, which consists in hollows and ridges two or three feet in depth or height filled by a limestone breccia, is important as indicating a land surface at the close of the Silurian. Unfortunately this was the only point at which it was detected, so that it cannot be said with certainty that the land elevation at that time was very widespread, although the apparent absence of Devonian beds is indirect evidence that it was, as is also the great variation observed in the thickness of the upper member of the Silurian, the Parting Quartzite.

The White Porphyry above the Blue Limestone has a maximum thickness of about fifty feet on the west point of Little Zion and rapidly wedges out to the north and east. It has the usual appearance of the normal rock, but the fresh-looking hexagonal crystals of dark mica are rather more abundant than usual, for which reason they were separated and analyzed, and found to be muscovite instead of biotite, with which determination their optical properties agree. (See Appendix B, Table I, Anal. II.) Above this is the Gray Porphyry, which readily disintegrates and crumbles into coarse sand, and therefore can be traced along the west slope of Mount Zion by the gentle slope which it forms at the foot of the steeper slope of Mount Zion Porphyry above it. It has here a thickness of about 100 to 150 feet, which increases to the northward; it evidently connects with the immense sheets of Eagle River Porphyry at the northern limits of the map. The Mount Zion Porphyry has a thickness of about 800 feet on the crest of the ridge, but rapidly wedges out to the north. In its upper part, near

the summit of Mount Zion, is an included sheet, about one hundred feet thick, of sandstones and shales of the Weber formation, which can be traced down the south slopes to the East Arkansas Valley.

**Tennessee Park.**— From Little Zion northward the Lower Quartzite beds form a flat shoulder along the lower slopes of Mount Zion facing Tennessee Park for a distance of several miles. Below this shoulder the steeper slopes, scored by shallow ravines, are in the granite of the Archean, while above are successively White Limestone, Blue Limestone, and Gray Porphyry, with Weber Grits capping the whole and covering all the hills to the east and north. Between No Name and Tennessee gulches there is a discrepancy in the outcrops of the lower beds, which can only be explained by a fault, approximately as shown on the map, by which their northern continuation is thrown more to the westward. All these western slopes are thickly covered with timber, and it is not always possible to determine accurately the outlines of the formations. Tennessee gulch heads on the western slopes of Buckeye Peak and, flowing first westward past Cooper's Hill, takes a bend to the southward, afterwards bending again westward into the open valley of Tennessee Park, beyond the limits of the map, where it joins the main branch of the Arkansas, which descends from the slopes of Homestake Peak. Between the south bend of Tennessee gulch and the main Tennessee Valley, just west of the map, is a low ridge of granite, gradually covered, as one goes north, by nearly horizontal beds of Lower Quartzite. These beds can be traced across Tennessee pass westward to the northern flanks of the Sawatch Range, where they cover the spurs extending northwards to the valley of Eagle River.

Along the western borders of the map northwards from Tennessee gulch a fringe of outcrops of lower Paleozoic beds follow the foot of Cooper's Hill and cross the upper valley of Piney Creek, which flows into Eagle River through Tennessee pass. The body of Gray or Eagle River Porphyry overlying the Blue Limestone becomes very much thicker in this region, and on the slopes of Buckeye Hill rises in horizon, leaving a portion of the Weber Grits formation, consisting of shaly beds, beneath it. On El Capitan Creek there is also a portion of the Weber Grits included in the body of porphyry. On Taylor Hill, north of the head of Piney Creek and

just beyond the extreme northwestern corner of the map, is the El Capitan mine, which is of interest as being the only considerable ore deposit thus far developed in this region at the Blue Limestone contact. In the Weber Grits, which form the surface rocks from Piney Creek eastward across Chicago Ridge to Chalk Mountain, as shown in Section A, are numerous bodies of porphyry, which doubtless originate in an immense laccolitic body which occurs just north of the limits of the map, near the head of Eagle River, and on a line with Chicago Ridge.

**East Arkansas Valley.**—The flood-plain deposit, which forms benches on either side of the alluvial bottom of the east fork of the Arkansas, extends up a little distance beyond Howland post office, above the lower bend. Under this no rock outcrops are visible. The south wall of the valley, formed by the slopes of Prospect Mountain, is mostly covered by débris, but the north wall on the Mount Zion side has cliff-faces and abundant outcrops. Above the arch of Archean, already described, the successive beds of the lower Paleozoic series, the Gray and Mount Zion Porphyries, and the thin bed of Weber Grits included in the latter descend into the valley at a steep angle. The dip of the beds rapidly flattens out, however, as one ascends the valley, and near the mouth of Buckeye gulch the Weber Grits have become nearly horizontal.

Between Buckeye gulch and the bend of the valley below Howland an important body of Lincoln Porphyry, with characteristic large orthoclase feldspars, comes in, which can be traced up the valley wall for a distance of two miles, apparently conformable with the bounding beds of Weber Grits. A similar body exists on the east side of the valley, extending from the mouth of Bird's Eye gulch up to a terminal moraine ridge half way between Howland and Chalk ranch. It would seem that these two outcrops are parts of the same great sheet of porphyry, though their connection across the valley is not very distinct. The prevailing dip of the inclosing sandstones is generally to the southeast. On the ridge between Arkansas Valley and Buckeye gulch this dip is quite pronounced and in places as steep as  $45^{\circ}$ . Towards its north end the eastern body forms a prominent hill, called the Dome, with a steep face toward the valley, which shows a tendency to columnar structure. The porphyry body is here much thicker

than at any other point, and it is not improbable that this is the laccolite from which the rest of the body has spread out. The rock of this porphyry mass (72) is a fresh-looking, light-gray rock, containing large pinkish crystals of orthoclase, abundant quartz (showing generally a crystalline form), and small hexagonal leaves of biotite. The groundmass is gray and subordinate to the crystalline constituents in quantity. Under the microscope it is seen that nearly half of the smaller feldspars are triclinic and much altered, while the larger ones are comparatively fresh. This porphyry is as nearly the equivalent of the Lincoln as of the Eagle River type, and is one link in the chain of evidence showing that all these allied types constitute one large group. (See Appendix A.)

At the base of the Dome is an outcrop of quartzite dipping to the southeast, which rises as one follows the cliff southward. In the little ravine next south is a second body of porphyry, separated from the main sheet by quartzites and shales through which it penetrates somewhat irregularly; it may be an offshoot from the main body, though it differs somewhat lithologically and is moreover impregnated with secondary pyrite; as it is very much decomposed, its character cannot be definitely determined. At the mouth of Bird's Eye gulch the porphyry body has risen to a considerable height on the ridge; while below it, between the mouth of Bird's Eye gulch and Indiana gulch, is a body of the finer-grained dioritic-looking porphyry already mentioned, which crosses over into the bed of Indiana gulch higher up, in the direction of the dike of the same rock on Prospect Mountain Ridge.

The slopes of Mosquito Range between Bird's Eye and English gulches, east of the porphyry body, are mostly made up of sandstones and occasional beds of black shale of the Weber Grits formation, whose prevailing dip is  $10^{\circ}$  to  $15^{\circ}$  a little to the south of east. On the summit of the ridge between the head of Bird's Eye gulch and the Arkansas Valley, however, the beds have a shallow dip to the west, giving evidence of a slight synclinal roll, as has been indicated in Section B.

On the west face of the ridge separating the head of Bird's Eye gulch from that of English gulch is an outcrop of limestone, which is probably one of the beds that occur in the middle of the Weber Grits series. Asso-

ciated with this is a porphyry different from those hitherto described, and characterized by small feldspar crystals of a deep purplish-red color. This and a decomposed green mineral, which are its only porphyritic components, lie in a light-green groundmass. Under the microscope the green mineral is seen to be altered to chlorite, so that its original condition cannot be determined, though it was probably biotite. The coloring matter of the feldspar is a reddish substance in small flakes, possibly oxide of iron. From the limestone outcrop eastward to the Mosquito fault the ridge is made up of coarse white sandstones, having a gentle easterly dip. Beyond the fault line the steeper slopes of the range are made up of fine-grained granite, which resembles an eruptive granite. In this about half way up the slope is an irregular dike of porphyrite.

At the mouth of English gulch, just north of the Dome, are several bodies of porphyry, and the structure of the sedimentary beds is extremely irregular, the dip being rather to the northeast or away from the porphyry mass, while on the ridge between English and French gulches the beds dip to the west and southwest, giving further evidence of the synclinal fold shown in Section B.

In the lower portion of French gulch the south and west dips still continue, and several small bodies of limestone are found between beds of quartzite or altered sandstone. About a mile up the gulch, at the Mountain Lion claim, is a body of diorite of blue-gray color and largely impregnated with pyrites. It has a thoroughly granitic texture and shows macroscopic crystals of feldspar, hornblende, biotite, and quartz. At the head of the gulch easterly dips again come in; but these change again to the west before the fault line at the foot of Mount Arkansas is reached, showing a second syncline, which may be a continuation of the syncline adjoining the fault that is so well developed at the north edge of the map, though the general strike of that fold would carry it to the west of this. On the divide between the head of French gulch and the Arkansas was observed a body of Lincoln Porphyry, opened by a prospect hole to a depth of twenty feet or more, which is so thoroughly disintegrated that when cut down by a pick it crumbles in the hand.

**Buckeye Peak.**—On the west of East Arkansas Valley, between it and Eagle River, is a broad-topped mountain mass, whose highest point is Buckeye Peak, at the head of the gulch of the same name. To this peak, on the Hayden map, no name is given, but a minor point of the ridge to the north is called Mount Arkansas—a name which has been given by the miners, with more propriety, to the prominent peak west of the Arkansas amphitheater; this transfer of the latter name has therefore been adopted on the present map. On the south face of Buckeye Peak, forming the wall of its amphitheater in a height of nearly 1,000 feet, is exposed a great mass of Eagle River Porphyry, whose prominent vertical cleavage planes and joints give the appearance of columnar structure observed on the summit of Mount Lincoln. On the débris-covered slopes and grassy ridges its outlines could not be traced with perfect accuracy, but it seems probable that it is a laccolite body, from which the other irregular bodies of the same rock in the vicinity may be offshoots. It is somewhat lighter colored than the porphyry observed in the Arkansas Valley, and under the microscope shows no glass inclusions, but otherwise is identical with that rock. A dike-like offshoot from the body extends to the west along the ridge at the head of Tennessee gulch. To the south the beds of the Weber Grits formation seem to dip away from it for a short distance and then resume their southeasterly dip. Above it, on the summit of the peak, these beds lie nearly horizontal. On the eastern base of the peak, at the head of the spur which runs down between Buckeye gulch and the Arkansas, is a small outcrop of decomposed porphyry, so white that it might be taken for Nevadite or White Porphyry. Microscopical examination, however, shows that it is probably a portion of the Eagle River Porphyry body. Across the northern ridge of Buckeye Peak runs a dike-like mass of porphyry about 200 feet in thickness, which can be traced almost continuously down the bed of Delmonico gulch in a steep wall, through which the present stream has cut a steep, narrow bed. Its outcrops are obscured by moraine material. This gulch, as well as the other main gulches which radiate out from Buckeye Peak, bears evidence of having been once filled by a minor glacier, both in the fact that relics of moraines can be found along its sides and in that its slope is not such a

continuous one as would result from the erosion of running water, but is comparatively gentle for a considerable distance from the head and then descends abruptly into the valley of the Arkansas.

Along the western slopes of Buckeye Peak, as already mentioned, are two principal bodies of quartz-porphry, apparently interstratified in the Weber Grits, which extend northward beyond the limits of the map. East of these are several irregular bodies of the same rock, whose outlines are given on the map with tolerable accuracy. They are probably connected in origin with the large laccolitic mass of Eagle River Porphyry which lies just beyond the border of the map to the north. They are in part interstratified, but little satisfactory evidence was obtained bearing upon their underground extension. In the basin between Chalk Mountain and Chicago Ridge, whose waters drain into Eagle River, a synclinal fold can be distinctly traced, which basins up to the southward. Its outlines are well marked by an interbedded sheet of Eagle River Porphyry. The inclination of the fold is comparatively shallow on the west, though in some places dips of as high as  $25^{\circ}$  are observed; while on the east the angle is still steeper, as shown in Section A, Atlas Sheet VIII. In its trough above the porphyry is a small bed of limestone.

**Chalk Mountain.**—From the head of the straight north and south portion of Arkansas Valley projects a singular ridge, like a huge railway embankment, prominent by its brilliant white color in the somber surrounding of pine trees. From the material of which it is composed and which, in the fact that it is soft and white, has a certain resemblance to chalk, the person who first settled at its base gave to his home the name of Chalk Ranch. At this point the Arkansas Valley bends sharply to the eastward and its level rises abruptly 100 feet or more; while the direct northern continuation of the valley below is formed by a still more elevated valley, the bed of a little stream known as Chalk Creek, which a short distance above Chalk Ranch falls in a picturesque cascade from the upper valley level into a deep narrow basin and flows in a narrow gorge to join the Arkansas just below the ranch. The Denver and Rio Grande narrow-gauge railway, in order to gain grade enough to overcome this sudden elevation of the valley level, climbs gradually along the western wall of the Arkansas Valley.



reaching the gorge a few feet below the falls, and then curves sharply to the east, spanning the chasm with a picturesque bridge, and, emerging through a 66-foot cut in the ridge beyond, reaches the south slopes of Chalk Mountain completely above the Chalk Ridge.

Between the valley of Chalk Creek on the west, the Arkansas Valley on the south, and the head of Ten-Mile Creek on the east, is a table-topped mountain of rudely triangular shape, presenting steep escarpments to the south and east. This low mountain mass, which forms part of the continental divide, is also formed of a very light-colored eruptive rock, and has from this fact received the name Chalk Mountain. Both the rock of Chalk Mountain and that of the white ridge below are rhyolite, but of somewhat different types. The former is coarse in texture, and, though seen to be distinctly porphyritic when closely examined, it seems in some cases almost granitic in structure. It is of the variety known as "Nevadite." Upon the southern and northwestern edges of the plateau of Chalk Mountain the surface is strewn with huge blocks of Nevadite, in which the large sanidine crystals, with their brilliant satiny luster, and the dark smoky quartz crystals are especially noticeable. Over the remainder of the surface the rock is somewhat finer grained, the quartz crystals being the most prominent constituent.

The rock of Chalk Mountain is different from that of all the neighboring bodies, not only in the character of its constituents, but in the time and manner of its eruption. It has disturbed the adjacent strata to an extent not noticed in connection with any other eruptive of the region, and by cutting off bodies of Eagle River and other porphyries its later age is proven. The masses of débris upon the steep southern slopes cover its contact with the sedimentaries, but upon the east, north, and west numerous outcrops appear, which illustrate the disturbing influence of the Nevadite mass. The map shows an arm of the Weber Grits projecting up the eastern slope to the level of the plateau, and in these elevated beds is a dike of older quartz-porphry, cut off to the west by Nevadite. Fig. 1 of Plate XIX shows this relation in detail. The strike of the beds is indicated by the lining on the sketch, and the easterly dip measures about  $70^{\circ}$  at the extremity of this arm, declining to  $30^{\circ}$  at the edge of the cliff. South of

this arm is another small area of quartzites, which seem to be entirely inclosed by the Nevadite. Farther north, upon the eastern side of the body, the strata are much disturbed and show varying strikes and dips, and upon the northern slopes, within the Ten-Mile district, the strike of the Weber beds is found to be east to west, with a northerly dip of  $80^{\circ}$  near the Nevadite, which lessens to  $25^{\circ}$  at a distance of half a mile. At the northwest corner of the mass, just beyond the line of the map, the eastern extension of the Eagle River Porphyry sheet shown in the synclinal fold is found to be cut through by the Nevadite. Along the western contact steep westerly dips are found in the sedimentary beds, and several thin sheets of Eagle River Porphyry seem to be cut by it, but the relations are not clear. A branch of Chalk Creek cuts deeply into the Nevadite and testifies to the thickness of the body upon this side.

Three of the smaller outlying bodies of rhyolite are apparent offshoots from the Chalk Mountain mass, but the rock of Chalk Ridge is of another type, allied closely to the body shown in the synclinal fold on the north line of the map east of Ten-Mile Creek. This rock is fine grained, showing only a few quartz grains and minute feldspars, and disintegrates readily into a gravel-like mixture. The outcrop of Chalk Ridge is only a few hundred yards in length, forming a sharp point between the mouth of Chalk Creek and the Arkansas. Above it are sedimentary beds, dipping at a shallow angle to the north and east and inclosing thin beds of Eagle River Porphyry.

Opposite Chalk Ridge, on the west bank of the creek, a white rock is disclosed in a little tunnel, which at first glance might be mistaken for rhyolite, but which on close examination proves to be simply altered Weber sandstone, composed of limpid grains of quartz, white muscovite, and kaolinized feldspar. In the gorge of Chalk Creek the first outcrops above the Chalk Ridge are thinly-bedded limestones and shales. Higher up, where the chasm is spanned by the railway bridge, are sandstones and quartzites, with intrusive bodies of porphyry, generally interbedded, but also crossing the strata. In the railroad cut on the eastern side of this gorge a section is exposed, showing one of these intrusive masses crossing transversely the beds and spreading out above. Figs. 2 and 3, Plate XIX, represent sketches taken on the spot at the time when the cut was freshly

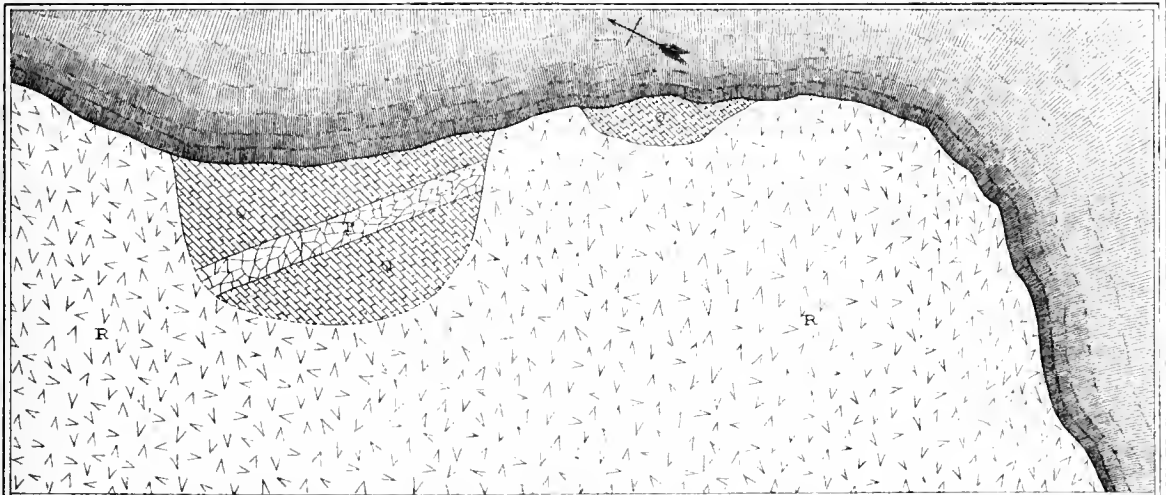

FIG. I. PLAN OF EASTERN EDGE OF MOUNTAIN SHOWING QUARTZITE AND PORPHYRY DIKE ENCLOSED IN RHYOLITE.  
R RHYOLITE Q QUARTZITE P PORPHYRY

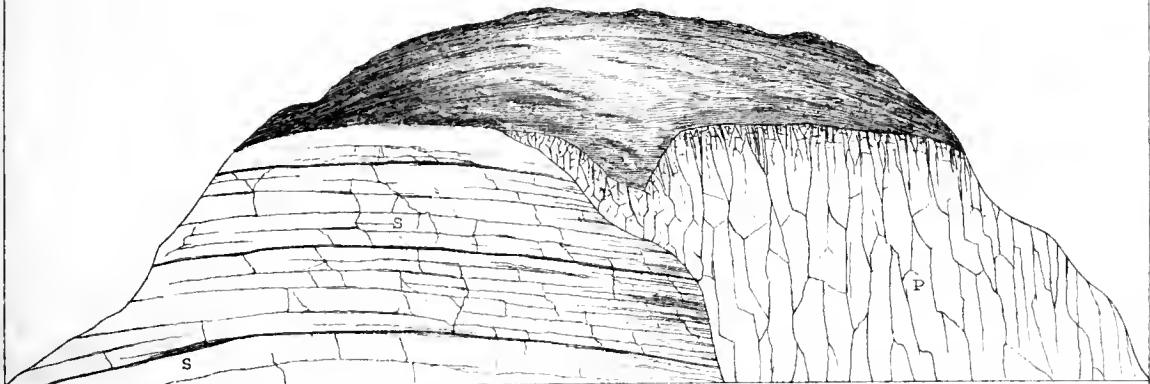

FIG. II. NORTH SIDE OF R.R. CUT AT SOUTH END OF CHALK M<sup>t</sup> SHOWING PORPHYRY CUTTING THROUGH SANDSTONE.

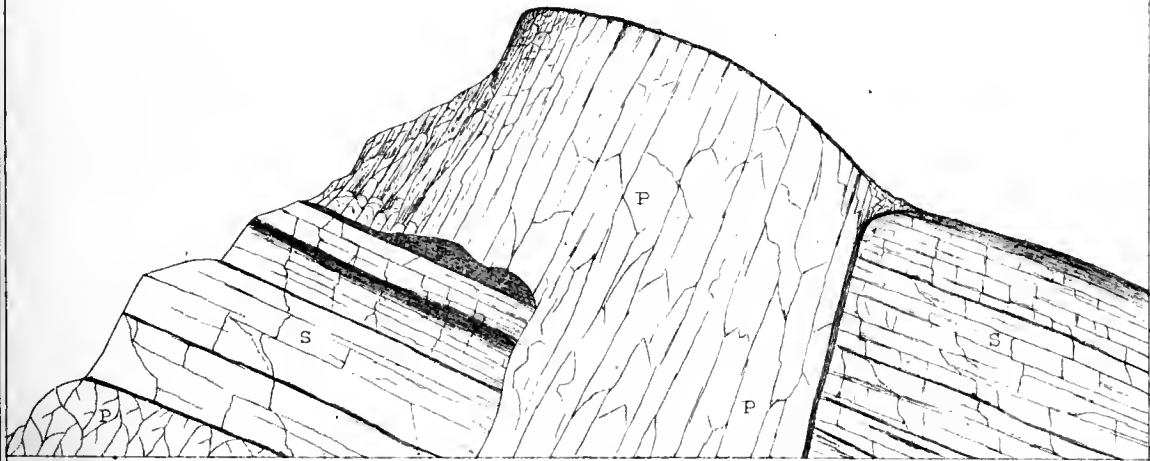
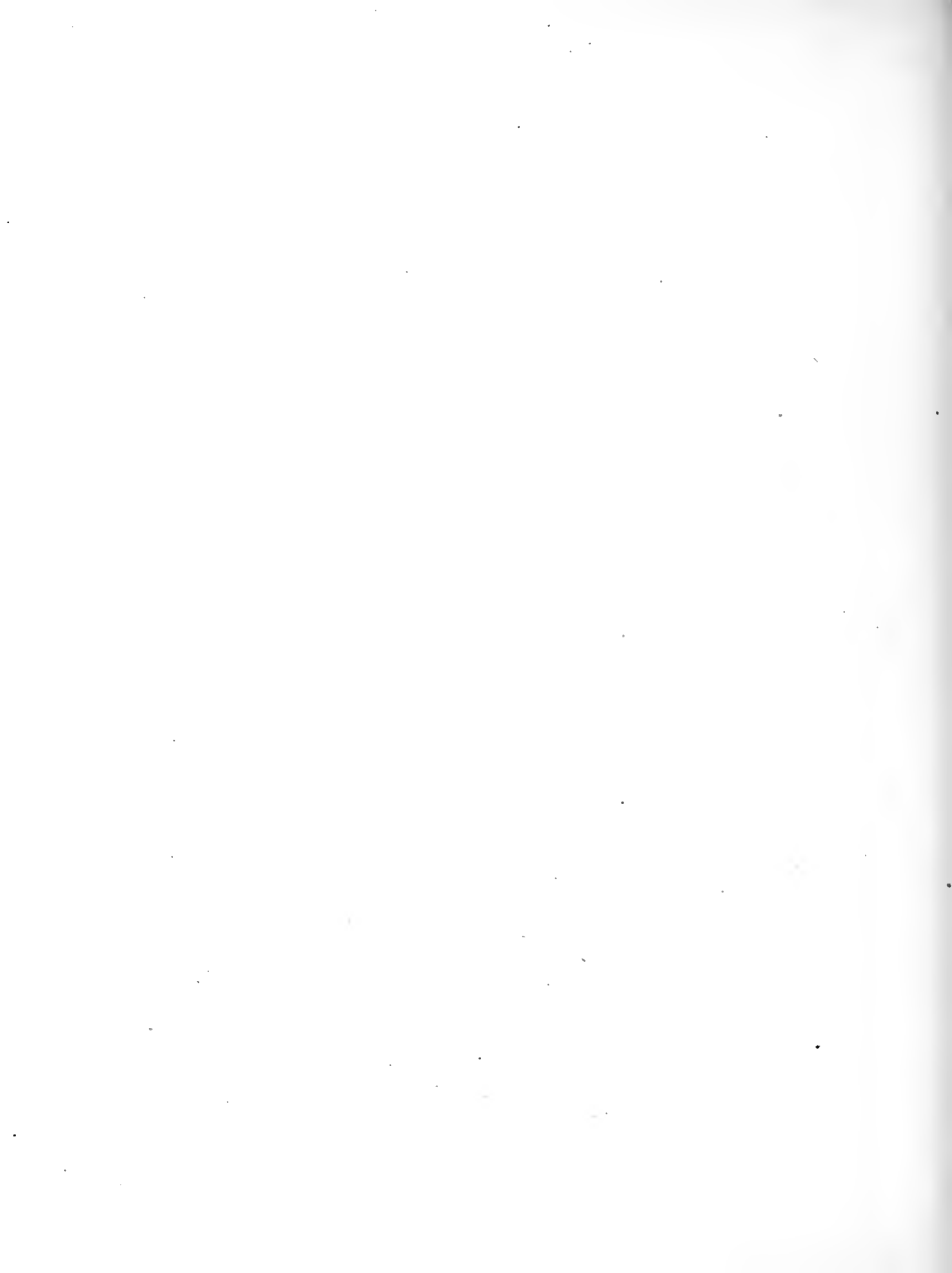

FIG. II. SAME CUT SOUTH SIDE P PORPHYRY S SANDSTONE Sh SHALE



made. The porphyries exposed here are quartz-porphyries, not closely allied to any particular type; but on the slope of the hill about one hundred yards above the cut is an outcrop of lavender-colored rock, which in its fresh fracture shows characteristic features of the Eagle River Porphyry. In the railway-cut on the western side of the gorge both sandstones and porphyries are thoroughly decomposed, but it can be seen that the latter both spread out between and cut across the beds. On the spur which extends from Chalk Ranch up to the Buckeye Peak ridge the sedimentary beds dip conformably to the northeast at an angle of  $20^{\circ}$  to  $25^{\circ}$ . This dip continues across the creek and up to the Nevadite at the southwest extremity of Chalk Mountain, the disturbance produced by it being slight at this point. A blue-gray limestone 6 feet thick is seen in the third railway-cut east of Chalk Ranch, where it has an apparent northwesterly dip. On the eastern side of the Arkansas Valley, just below and also a little above Chalk Ranch, the beds dip  $45^{\circ}$  to the west and southwest. The evidences thus afforded in regard to the structure of the sedimentary formations in this region are not very satisfactory, showing simply that the beds are much broken up and indicating that the influence of the intrusive Nevadite mass has not been felt beyond narrow limits.

**Upper Ten-Mile Valley.**—The remaining area of sedimentary rocks is embraced between Chalk Mountain on the west, the Arkansas Valley on the south, and the Mosquito fault on the east. Through it passes the continental divide, separating the waters of the Ten-Mile from those of the Arkansas. The low, wooded Frémont's Pass has an elevation above sea-level of 11,350 feet, and over it passes the Blue River branch of the Denver and Rio Grande Railroad, the steep rise of 500 feet from the Arkansas Valley being overcome by means of a long loop, as shown by the map. Ten-Mile Creek has its head in a small rugged amphitheater in the Archean, just east of the Mosquito fault, whence it flows directly west to the base of Chalk Mountain, then turns abruptly northwest, and soon after passing the limits of the map bends to the north and then to the northeast. The gentle slopes near the creek are wooded, and outcrops are rare until the neighborhood of the great Mosquito fault is reached.

The geological structure of this small area is the expression of the ending of the great synclinal fold which is the predominant feature in the structure of the Ten-Mile district on the north. The beds taking part in this fold basin up to the southward, as they pass within the limits of the Mosquito map. In the central part of the fold occur strata of the Upper Coal Measures, the highest horizon represented west of the Mosquito fault within the limits of this map. Forming the dividing line between the Weber Grits and the Upper Coal Measures is the Robinson Limestone, the tracing out of which gave the key to the structure represented. Above the Robinson Limestone is an intrusive sheet of quartz-porphry, which has also been folded, and thus assists in bringing out the basin-like form of this fold. The observed dips upon the western and southern sides of the basin vary from  $25^{\circ}$  to  $60^{\circ}$ , the strike curving as shown upon the map. Upon the east the proximity of the great fault has somewhat complicated matters and the strata dip very steeply westward. Section A A, Atlas Sheet VIII, represents the relations at this point. The intrusive quartz-porphry mentioned does not resemble the Chalk Mountain Nevadite, and yet it is a coarsely porphyritic rock, whose prominent constituents are large sanidine-like feldspars and well-formed quartzes, and whose general habit is that of a comparatively recent rock. The facts that on the one hand this body appears as an intrusive sheet which has been folded and that on the other it is cut by a rhyolite of the type occurring in Chalk Ridge have led to its classification as a quartz-porphry. In the center of this fold are several minor bodies of rhyolite, of quartz-porphry, and of a hornblendic porphyrite. These rocks, as well as the fold in which they occur, are much more important features in the geology of the Ten-Mile district, and the further discussion of their relations will be reserved for the report upon that region.

**Mosquito fault.**—The line of the Mosquito fault is well defined along the base of the steep slope of Bartlett Mountain by the abrupt transition from sedimentary to crystalline rocks; but farther south, where it crosses the opening of the Ten-Mile amphitheater and the valley of the Arkansas, owing to the covered nature of the surface, its exact location is difficult to determine.

At the foot of the steep western slope of Bartlett Mountain, and on the very northern edge of the map, a small cliff-face of rock juts out from the

débris slopes east of the fault line. Its material is a silicious rock, more or less iron-stained and of somewhat cherty nature, in some places honey-combed and porous like the quartzite knob adjoining the London fault on Pennsylvania Hill. Its structure lines, though somewhat indistinct, appear to indicate a vertical dip in the stratification, and among the fragments at the upper part of the cliff are some of limestone, resembling the base of the White Limestone. All this material is too much metamorphosed to permit of an absolute identification of its original character, but it evidently belongs neither to the Archean on the east side of the fault, nor to the Upper Coal Measure beds on the west. It is fair to assume, therefore, that it represents a portion of the Cambrian and, possibly, of the Silurian beds belonging to the steep western side of the fold, which once arched over the top of Bartlett Mountain (as indicated by the dotted line in Section A), and which, by the friction and pressure that accompanied the displacement of the Mosquito fault, have been compressed and metamorphosed until they are no longer recognizable. Further evidence in favor of this view is found on Little Bartlett Mountain, a continuation of the Bartlett Mountain ridge just beyond the limits of the map, upon which a fragment of Cambrian beds, consisting of characteristic saccharoidal quartzite, is found capping the summit and extending part way down the western slope, with a dip of  $45^{\circ}$  to the northwest. They end in a little cliff a few hundred feet above the fault line, on which the contact with the underlying granite is well exposed; a bedding parallel to that of the quartzite can be traced for some distance into the granite, with an apparent arrangement of the feldspars in layers parallel to this bedding. The actual contact consists of the usual fine-grained conglomerate, with small rounded pebbles of limpid quartz. The quartzite at the summit of Little Bartlett Mountain alternates with Lincoln Porphyry in such manner as to make it probable that the latter is a relic of an interbedded intrusive sheet.

**Arkansas amphitheater.**—In the Arkansas amphitheater, remarkable for its semicircular form and magnificently steep eastern walls, which rise 1,500 to 2,500 feet above the stream bed, the débris in its bottom gives evidence of a very large development of eruptive dikes, among which hornblende-porphyrites and biotite-porphyrites play an important part. Nearly all the

larger masses of this rock contain numerous rounded fragments of Archean schists, gneiss, and granite. One of the most prominent features is a body of porphyrite, near the summit of the eastern wall of the amphitheater, which can be traced continuously from below as a dark horizontal line. Near the head it sends down a branch across the cliffs to the bottom; and what is probably a continuation of the upper branch was observed, as already mentioned, in Buckskin amphitheater, on the southeast side of Democrat Mountain. In the bottom of the amphitheater, near its head, is a remarkable dike of porphyrite, from 20 to 50 feet wide, which has a straight northeast and southwest course and cuts through the narrow wall separating this from the amphitheater at the head of English gulch. The main body of the dike is a fine-grained, dark-colored rock, more or less impregnated with pyrites. Irregularly contained within its mass is a second body of darker shade, characterized by inclusions of rounded orthoclase pebbles and large crystals or rounded grains of quartz. A specimen of this singular rock is shown in Plate VII (p. 86). It is evidently a later eruption within the mass of the previously existing dike. Both rocks and their relations are described in Appendix A.

In the Archean rocks here exposed are found all the types previously described, and from a face of rock at the head of the amphitheater was made the sketch, which is shown in Fig. 1, Plate IV (p. 52), to illustrate the relative ages of the different varieties, normal mica-gneiss being the oldest, which is penetrated by the even-grained eruptive granite, and this again in its turn crossed by veins of white pegmatite. There are evidences of extensive mineralization, but no ore bodies have been sufficiently opened to afford an opportunity for systematic study. Parallel with the dike in the bed of the creek, at the head of the amphitheater, was observed a deposit of galena, following the wall of one of the larger pegmatite veins.

In the mass of Mount Arkansas are many eruptive bodies which could not be traced out, although their existence was shown by the numerous fragments in the débris. On a northern spur of the mountain two dikes were seen, one of a quartz-porphry, allied to the Lincoln type, the other a hornblende-biotite-porphryite.



**Ten-Mile and Clinton amphitheatres.**—The Archean types represented in the area embracing these basins are as varied as those which have already been described from the adjacent region to the east and south. In Clinton amphitheater there is an unusually large amount of the rudely porphyritic granite referred to earlier in this chapter, and in both are numerous dikes of eruptive rocks, among which the Lincoln Porphyry and a dark hornblendic porphyrite are the most frequent. These bodies cannot be indicated upon the map with satisfactory accuracy, and are for the most part omitted. A rhyolitic rock of coarse grain in Ten-Mile amphitheater seems more closely related to the Chalk Mountain Nevadite than to any other.

Bartlett Mountain, which separates the two amphitheatres, has a dike of dark-green porphyrite running through its summit and down into the Ten-Mile basin. Upon the western slopes of this mountain are large masses of white quartz which might at first glance be considered as derived from a remnant of the Cambrian strata left on the east side of the Mosquito fault, but they are quite homogeneous and have no trace of the granular or sandy structure which is found even in the most glassy quartzites; they were probably derived from some of the vein-like masses of quartz which are found developed on a large scale in the Archean of other parts of the Rocky Mountains, and which have been removed by erosion. Abundant evidences of glaciation exist in these as in other amphitheatres which have been described.

## CHAPTER V.

### DESCRIPTIVE GEOLOGY OF LEADVILLE AND VICINITY.

#### GENERAL STRUCTURE.

The central region of the general map is, as has already been seen, the region of the greatest dynamic as well as eruptive action. A section across the range at Leadville shows, as the result of dynamic action, five anticlinal folds and six principal faults. On the east side of the range, as already seen, the structure is relatively simple. The beds sloping back to the eastward are broken by one main anticlinal fold and its accompanying fault, the London fault. On the west of the crest, however, instead of one main fault, as in the regions north and south, the continuity of the beds is broken up by six principal and several minor faults.

The map of Leadville and vicinity (Atlas Sheets XIII and XIV) shows the most important features of the geology of that region. Its eastern border extends to within two or three miles of the main crest, which consists of Archean rocks capped by easterly dipping Paleozoic beds and intrusive porphyries. For a better comprehension of the description which follows, the reader is requested to refer constantly to this map and its accompanying sections. He will there see that its area is divided into a series of irregular zones or blocks by the lines of six principal faults having a general north and south direction. For purposes of description these have received the following names, commencing on the east: 1, Mosquito fault; 2, Ball Mountain fault; 3, Weston fault; 4, Mike fault, with a branch called Pilot fault; 5, Iron fault; 6, Carbonate fault, with a branch called Pendery fault. Besides these there are the following minor and cross faults: 1, on the

southern edge of the map, the Iowa gulch cross-fault, which connects the Weston and Ball Mountain faults; 2, the Union cross-fault, which extends from the head of Union gulch across upper Long and Derry Hill and joins Weston fault in the bed of Iowa gulch; 3, the Colorado Prince fault, north of Breece Hill, a diagonal cross-fault approximately parallel to South Evans gulch, which connects Ball Mountain and Weston faults; 4, on the west slope of Breece Hill another cross-fault, the Breece fault, running nearly east and west, joining the northern end of Mike fault with Weston fault; 5, a little farther west the Adelaide cross-fault, which connects Iron and Mike faults; 6, at California gulch the southern continuation of Iron fault is formed by three different faults: Dome fault, connected with Iron fault by the California cross-fault, following the line of the gulch, and Emmett fault, which connects California fault with Iron fault. Pilot fault, already mentioned, is a short north and south fault, crossing California gulch above Mike fault, running across the west end of Printer Boy Hill, and joining Mike fault in Iowa gulch. The Pendery fault, already mentioned, and the South Dyer fault, a cross-fault running eastward from the Mosquito fault along the south slopes of Dyer Mountain, raise to seventeen the total number of faults represented on the map.

In ground broken by such a complicated network of fractures and subjected since to the enormous erosion which is shown to have taken place in this region, it is extremely difficult even for a trained geologist to reconstruct ideally the original folds into which the sedimentary beds and their included sheets of porphyry were once compressed. As, however, the action of faulting was so intimately connected with that of folding and the displacements in many cases pass into simple folds, it is essential, in order to obtain a clear idea of the relative position of the different beds below the surface and the depths at which they may be found, that one should be able to reconstruct in his mind the original folds, and then figure to himself the faulting action which has brought the beds into the discordant juxtaposition in which they are now found on the surface, as shown on the map. For this purpose the general structure along certain east and west lines will be first described, and after that the present condition of the surface and the underground structure, as revealed by shafts in each zone or

block of ground included between the principal fault-lines, will be described in detail. The three cross-sections of the general map which cross the area of the Leadville map will serve perhaps best to show the general outlines of structure.

In Section E, Atlas Sheet IX, which is drawn approximately through the middle of the map, and which may, therefore, be considered as a type-section, the effect of displacement is more prominent than that of folding. Its line runs through the southern edge of the town of Leadville itself, across Carbonate, Iron, and Breece Hills, passing just north of the crests of Ball Mountain and of East Ball Mountain to the summit of West Dyer Mountain. Along this line, going from west eastward, the following are the main features of folding: In the region under Leadville, or from the western edge of the map to the Carbonate fault, a shallow syncline; under Carbonate Hill, or from Carbonate to the Iron fault, a second shallow syncline; and from Iron Hill eastward, a third; in all of which the prevailing dip is eastward, only a small portion of the easterly edge of the basin having a westerly dip. In the region between Iron Hill and Ball Mountain, or, in other words, on the western slope of Ball Mountain, the surface is so uniformly covered with Pyritiferous Porphyry that there is no direct evidence of any folding, although a slight anticlinal fold might be expected near the line of the Pilot fault, from the fact that one exists on its strike both north and south. At Ball Mountain is a sharp anticlinal fold, and east of that the beds slope back in a monocline to the eastward. The effect of displacement produced by the faults has been to lift each successive block of ground up to the east of the fault, except in the case of a wedge-shaped portion included between the Mike and Pilot faults, in which there has been a slight downward movement.

On an east and west line south of this (Section I I, Atlas Sheets XIX and XX), the beds of Blue Limestone would be first met about due south of the summit of Carbonate Hill, sloping east in a shallow synclinal basin and rising again in an anticline whose axis corresponds to the southern continuation of the Dome fault. The crest of this fold having been planed off by erosion, the contact would be wanting for something over half a mile, and be found at the head of Thompson gulch dipping to the eastward, but

rising gently as it approached the continuation of the Mike fault. The ground east of this fault having been lifted up, the Blue Limestone has been in part removed by erosion and would next be found at the Long and Derry mine, sloping again eastward as far as Union fault. Beyond this fault it has again been removed by erosion, a little remnant only being found above the White Porphyry in the uplifted portion adjoining the Weston fault. Between this and the Mosquito fault is the arch of an anticlinal fold on which only Lower Quartzite is left. Beyond the Mosquito fault erosion has cut down to the Archean rocks, the Blue Limestone being next found on the western face of Mount Sheridan, along either of whose sides it may be traced, sloping back to the crest of the main ridge.

On the line of the section north of the first described (Section D, Atlas Sheet VIII), which passes through Fryer and Yankee Hills, the faulting action is less prominent, owing to the fact that many of the faults have in their northern continuation merged into folds. On the north of Leadville, extending from the western limit of the map to the eastern edge of the town, is the same broad syncline noticed in the first section. From here to the western edge of Fryer Hill is a short anticline, from whose crest the Blue Limestone has been planed off. It is succeeded by a shallow synclinal fold under the western half of Fryer Hill, followed by a short anticline at its crest, while in the gulch back or east of the hill is found the rim of a deep synclinal basin which passes under Little Stray Horse Park. At the west foot of Yankee Hill the ore-bearing horizon rises to the surface and descends to the eastward again just beyond the summit of this hill, the crest of the intervening anticlinal fold, into which the northern continuation of the Iron fault merges, having been eroded off. From this point the strata descend to the eastward, rising in a gentle wave near the Great Hope mine, but not reaching the surface, and then sloping again eastward until they rise on the South Evans anticline or are cut off by Weston fault. East of Weston fault, in the region around the mouth of South Evans gulch, is another anticline or quaquaversal fold, whose summit has been worn away, leaving the outcrops of succeeding beds in a series of concentric rings. On the east of this fold the beds slope continuously to the eastward

at angles of from  $15^{\circ}$  to  $20^{\circ}$ , a conformable series, extending high up into the Weber Grits, being still left uneroded on the summit of Little Ellen Hill.

In Section C, Atlas Sheet VIII, which follows nearly the northern boundary of the map, the faults have apparently all been eliminated, and the outlines of formations shown on the map owe their form entirely to folding and erosion. One broad anticline under the west slope of Prospect Mountain and a shallow syncline in the Arkansas Valley express the broader general features of folding. Near this line, at the mouth of the east fork of the Arkansas, are found the westernmost actual exposures of Paleozoic rocks within the area surveyed. These consist of beds belonging to the Lower Quartzite formation, exposed in the bed of the stream and in the cliffs south of it, dipping to the southeast. They constitute the most definite evidence of the synclinal basin supposed to underlie the town of Leadville.

#### DISTRIBUTION OF PORPHYRY BODIES.

Before proceeding to the detailed description of this region it will be well to give a brief outline of the distribution of the various porphyry bodies, which form so important an element in its structure and have had so great an influence upon its ore deposition. It is first to be observed that the features of this distribution have a certain uniformity along northwest and southeast lines in approximate parallelism with the line of major strike of the sedimentary beds. As by far the greater portion of these bodies are in the form of sheets either actually or approximately conformable with the bedding of the inclosing sedimentary rocks, in cases where explorations were insufficient to determine whether they were sheets or transverse dikes the former has been assumed to be the case in drawing the ideal portion of the various sections, and dikes have been indicated only when actual explorations have proved that they were coming up directly from below. It may readily happen, therefore, in the case of imperfectly explored bodies, that future explorations may show the latter form to be more common than has been indicated in the sections.

**White Porphyry.**—The most important of these bodies is the White Porphyry, which is generally found as a sheet immediately overlying the Blue

Limestone. As it forms the surface rock over a great part of the area, and has hence been subjected to considerable erosion, it is impossible to determine its maximum thickness. Its original extent to the southwest is also completely unknown, since it, together with the inclosing sedimentary beds, has been entirely eroded off from this portion of the area. Along a certain zone, moreover, it occurs below as well as above the Blue Limestone. This lower body is connected with the upper or main sheet along a line running diagonally through the south edge of Fryer Hill, in a southeast direction, toward upper Long and Derry Hill and West Sheridan, to the northeast of which there are two sheets of porphyry, and to the southwest only one. On this line, which is rather a zone than a line and can, in the nature of things, be only approximately determined, it is found that there is a cross-cutting sheet of porphyry connecting the two sheets to the northeast with the one sheet to the southwest, and the Blue Limestone is in consequence found to be split into wedge-shaped and partially-overlapping bodies. The greatest development of White Porphyry appears to be a little southwest of this zone of cross-cutting, on a line passing through Carbonate, Iron, Printer Boy, and Long and Derry Hills, where it attains in places a possible thickness of 1,000 feet. To the northeast of this zone both sheets thin out rapidly, the lower one before reaching a line running through the forks of Little Evans and along the general course of South Evans gulch, and the upper one at a little distance beyond this line. Along a line running N. 50° W. from the saddle east of Ball Mountain to the East Arkansas Valley, at the foot of Canterbury Hill, this upper sheet is entirely wanting for short distances, coming in again, however, northeast of that line.

Besides these two main sheets there is a very considerable development of White Porphyry along a southeast zone, passing just east of the crest of Ball Mountain, where it occurs in the White Limestone and extends down to the contact of the Archean. It is a significant fact that in this zone it has been proved in two instances to be cutting up through the Archean, in the one case in South Evans gulch, near its mouth, and again on the north side of Iowa amphitheater.

**Gray Porphyry.**—Next to the White Porphyry the most important body is the main sheet of Gray Porphyry, which, northeast of the Fryer Hill-Sher-

idan line, is found directly over the upper sheet of White Porphyry in very considerable thickness. How great this thickness may have been there is no direct means of determining, since, except on Prospect Mountain (where no shafts have been sunk to any great depth), no sedimentary rock remains above it to give its upper limits. Its greatest observed thickness is 420 feet in the Independent shaft. What was the original extent to the southward of this Gray Porphyry sheet before any portion of it had been removed by erosion, there is also no means of determining. At present it extends but little beyond the median line of the map. Its source must probably be looked for to the northward, beyond the limits of the map, since in that direction it passes into Lincoln or Eagle River Porphyry, of which it seems to be merely a decomposed variety.

**Pyritiferous Porphyry.**—Next in importance in point of superficial extent, and possibly of greater importance in its bearing on the ore deposits of the region, is the Pyritiferous Porphyry. The main sheet of this porphyry, which covers the lower slopes of Breece Hill, seems to be a stratigraphical replacer of the Gray Porphyry, which however, along the line of the Breece fault, it overlaps. It may therefore be supposed to have been in point of time a later intrusion. As is shown in Section G, one of the vents, and possibly the sole vent, probably existed beneath California gulch. Its extent to the north and east could not have been much greater than at present. To the south and west, however, it may have covered a considerably larger area immediately above the White Porphyry. Of the upper sheets in the Weber Grits no opinion can be formed, so completely has all trace of this formation been removed by erosion. It is perhaps fair to assume that it extended to the south as far as the present crest of Long and Derry Ridge, and to the westward over Iron Hill, and, possibly, as far as Carbonate Hill.

**Other porphyries.**—Of the other bodies of porphyry, the most important in their bearing upon the ore deposition of the region are those which are essentially of the same rock as the main sheet of Gray Porphyry, though having no apparent connection with it. The most extensive sheet of this rock is found under Iron and Carbonate Hills, near the base of the Blue Limestone, and cutting up across this horizon to the westward; various irregular, dike-like bodies found in the different mines are, doubtless, offshoots



from this sheet. A small sheet is found above the Blue Limestone on Iron and Dome Hills. A large body, probably coming up from below, occurs on the southeast face of Yankee Hill, extending across Adelaide Park. Several small sheets are found in the White Limestone on the north end of Iron Hill and in California gulch, and three well-developed dikes cross Printer Boy and Long and Derry Hills.

On the northwest slope of Printer Boy Hill the Printer Boy Porphyry forms an important mass; in Iowa gulch is the Green Porphyry, under the White Limestone; and on Long and Derry Ridge, the Josephine Porphyry, above the Blue Limestone. Mount Zion Porphyry, which is closely allied to the White Porphyry, forms a body of great thickness in the Weber Grits on Prospect Mountain, and is found also in Evans gulch, but seems to be simply a local occurrence which reaches its greatest development beyond the limits of the map, and has apparently had little or no influence upon the ore deposits of the district.

In what follows will be given in detail the various facts upon which the geological deductions represented on the map and sections have been founded, which will probably prove of interest only to those who wish to verify these deductions on the ground or examine into their soundness. For convenience of description the region will be divided into the areas naturally blocked out by the lines of the principal faults, and these will be treated in topographical order, proceeding from the east westward, and in each block from the south northward.

#### AREA EAST OF MOSQUITO FAULT.

Between Mosquito fault and the crest of the range is a considerable area, occupied principally by Archean exposures, whose description properly belongs to that of the Leadville region, although only a small portion of it is actually shown in the extreme southeast corner of that map. In it, immediately below the main crest, are the two great glacial amphitheaters in which headed the glaciers that carved out Evans and Iowa gulches, and which offer the best opportunities in the immediate vicinity of Leadville for the study of the relations of the ancient crystalline rocks and of the eruptive bodies that have been intruded through them into the over-

lying Paleozoic formations. Their scenery is moreover of an imposing and Alpine character that would hardly be expected from the somewhat tame appearance of the immediate vicinity of the city itself. For this reason a view of the more picturesque and instructive of the two, that of Iowa amphitheater, has been chosen for the frontispiece of this volume.

**Frontispiece.** — Iowa amphitheater, as will be seen on the Mosquito map, is a bowl-shaped depression some 2,500 feet deep, with three main branches or subsidiary amphitheatres extending up to the north, northeast, and south between the bounding peaks, Dyer Mountain, Mount Sherman, and Mount Sheridan. The view given in the frontispiece is the reproduction of a not altogether satisfactory photograph taken from a point on the north side of Iowa gulch, at the foot of the steeper southern slope of East Ball Mountain. The spur in the foreground, on the right, is a portion of the north slope of West Sheridan, formed of Archean rocks capped by Lower Quartzite; that on the left is the south spur of East Ball mountain, along which runs the Mosquito fault; while the background is formed by the west face of Mount Sherman, an almost vertical wall 2,400 feet in height. On this wall the up per 1,400 feet are occupied by the main sheet of White Porphyry, overlying the lower Paleozoic beds, in which are also several minor sheets of the same rock, too small to be indicated except in a general way on the Mosquito map; and the base of the cliff is formed by Archean rocks. In the view the horizontal lines of the stratified beds can be readily distinguished from the somewhat gothic forms of weathering of the great mass of porphyry above, but the lower portions of the cliff are almost entirely hidden beneath talus slopes of débris, through which only here and there projects a portion of the Archean granite.

In the granite exposures on the south bank of Iowa Creek, a little above the point from which the frontispiece view is taken, are the best examples of glacier action on rock surfaces in this region. The granite bosses here have a gentle slope to the east and are steep on the west, the whole upper surface of the rock being beautifully polished, grooved, and striated, and the lines being parallel with the direction of the gulch. These

striation lines are particularly fine on the surface of the large feldspar crystals, where, when closely examined, they are seen to resemble the parallel lines of a steel engraving.

**Mosquito fault.**—The average course of Mosquito fault, which forms the western boundary of this area, is magnetic north or north  $15^{\circ}$  east. From the point where it branches off from the Weston fault, in the bed of Empire gulch, it runs across Upper Long and Derry Ridge at the foot of the steep face of West Sheridan, through Iowa gulch, along the west face of East Ball Mountain, and through the narrow saddle on the ridge between West Dyer Mountain and Little Ellen Hill into Evans amphitheater, which it crosses diagonally, near if not actually through the shaft of the Best Friend mine, to the foot of the zigzag road descending from Mosquito pass. Owing to the absence of shafts in the region, its location can only be determined by actual rock outcrops, and where these are obscured by débris it may vary a little one way or the other from that given on the map. Its throw, which varies somewhat at different points, may be taken at an average of 4,000 feet.

**Minor faults.**—Of the minor or cross faults in this area only one, the South Dyer fault, appears on the Leadville map. By its movement, which was an upthrow to the north, a fragment of the Lower Quartzite beds, with an included sheet of White Porphyry, has been left on the southwest spur of East Ball Mountain, where it forms a shoulder half-way down the slope and is entirely surrounded by Archean outcrops. Beyond the line of the map it crosses the south foot of Dyer Mountain, where a dike of White Porphyry cuts through the Archean on its probable continuation and joins the Sheridan fault in the bed of Iowa gulch. The Sheridan fault runs at right angles to the former in a southwest direction across the saddle between Mount Sheridan and West Sheridan, and is supposed to join Weston fault in the north head of Weston gulch. Its movement is a slight upthrow to the east, and the combined displacement of these two faults explains the existence of a singular triangular-shaped mass of White Limestone and Lower Quartzite at the entrance to the north branch of Iowa amphitheater, in the very bed of the gulch. As the normal continuation of these beds is found high up on the face of the surrounding mountains, it might seem at

first to have been dropped down here by a sudden sinking of the ground. Nearly parallel with the South Dyer fault is the Dyer Mountain fault, whose presence is indicated by a slight discrepancy in the stratified beds at the head of Dyer and North Iowa amphitheatres. Its extent as well as its movement is apparently small, as it could not be traced beyond these valleys in either direction, and in the Dyer amphitheater is shown only on the east wall, there being apparently no break in the lines of stratification on the West Dyer Mountain side. The amount of displacement caused by these two faults is shown in Section M, Atlas Sheet X.

**West Sheridan.**—West Sheridan Mountain, which is in point of fact simply a Y-shaped spur extending out westward from the main Mount Sheridan, has, as it were, three summits, two of which are capped by the remains of the White Porphyry sheet, which here separates the Blue Limestone from the White. The remainder of the crest of the ridge is formed by beds of White Limestone, under which is a fringing outcrop of Lower Quartzite. In those on the north and west slopes are several small bodies of White Porphyry. An estimate of the thickness of White Limestone and Lower Quartzite on the western face of the south and north spurs of West Sheridan, respectively, gave 250 and 275 feet, the difference being accounted for by included sheets of White Porphyry.

**Dyer Mountain.**—Dyer Mountain, as shown in Section M, whose line runs from the summit of the mountain southward through the spur represented in the photograph, is composed of the following beds in descending series:

Sacramento Porphyry.	White Limestone.
Weber Grits.	Lower Quartzite.
White Porphyry (main sheet).	White Porphyry.
Blue Limestone.	Archean.

The main sheet of White Porphyry is the cap-rock of that portion of spur shown in the frontispiece. The lines of stratification on the face of the spur toward the observer, dipping gently to the north toward the head of Dyer amphitheater, belong to the Lower Quartzite and to the underlying bed of White Porphyry, which is here two hundred to three hundred feet in thickness. On the south face of this spur, toward Iowa gulch, in the Archean apparently near or on the line of the South Dyer fault, is an irregular out-

crop of White Porphyry, somewhat in the form of a dike, parallel to the fault, but with ramifying branches extending in various directions. This body is interesting as being one of the few cases where the White Porphyry could be seen to have been directly erupted through the Archean, and is very probably the source from which the lower sheets of this rock have spread out between the lower Paleozoic beds below the horizon of the Blue Limestone; it seems hardly of sufficient size, however, to account for the immense thickness of the main sheet of White Porphyry above that horizon, and whose source, as already shown, is supposed to exist in the White Ridge near the head of Four-Mile Creek.

On the east wall of Dyer amphitheater, in the upper part of the White Limestone near the Parting Quartzite, are the deposits of the Dyer mine, from which the mountain has derived its name. This mine is one of the earliest discoveries of the district, antedating by many years that of the carbonate mines, but owing to its great altitude and difficulty of access it has been but intermittently worked. A section measured along a steep hillside, with a slope of  $32^{\circ}$ , just south of the Dyer mine, gave the following thicknesses:

		Feet.	
Lower Carboniferous	}	<i>Blue Limestone:</i>	
		Dark blue, weathering black, with black chert.....	150
		—	150
Silurian	}	<i>Parting Quartzite:</i>	
		Sandstone and silicious limestone . . . . .	10
		<i>White Limestone:</i>	
		Thin-bedded, bluish limestone.....	35
		Light-blue limestone, conchoidal fracture, passing into pinkish, clayey material.....	15
		Gray, semi-crystalline limestone.....	40
		Sandy lime tone, with some sandstone.....	30
		—	140
Cambrian	}	<i>Lower Quartzite:</i>	
		Red-cast beds . . . . .	10
		Reddish-brown quartzites . . . . .	50
		—	100
		—	160
		White Porphyry, 200 feet.	
Archean		Granite .....	

Just below the Dyer mine a bed of limestone of a light steel-blue color is singularly changed into a light-pink, clayey material, so different in appearance from the unaltered rock that a partial analysis of the two was made in order to determine the chemical change that had produced this appearance. The following figures were obtained:

	Unaltered limestone.	Altered limestone.
Lime . . . . .	20.31	19.21
Magnesia . . . . .	10.35	9.58
Alumina and iron . . . . .	6.23	5.23
Insoluble . . . . .	31.27	34.56

From which it is seen that the alteration consists mainly in the removal of a portion of the soluble bases and a consequent relative increase in the proportion of silica. It also shows that a very essential change in the physical character of a rock may be made by the action of percolating waters, with very little actual chemical change.

The break in the beds north of the Dyer mine, caused by the movement of South Dyer fault, is very evident in the Blue Limestone, but cannot be traced much below that horizon. On the west wall of the Dyer amphitheater the beds slope up the face of West Dyer Mountain in an unbroken line, showing no trace of the fault; the main sheet of White Porphyry which forms the saddle between Dyer and Evans amphitheaters thins out very rapidly to the northwest, and on the face of West Dyer Mountain shows an outcrop of only about ten feet, the summit of the peak being formed by a few remaining beds of Weber Grits.

*Evans amphitheater.*—The basin at the head of South Evans gulch, as well as the main Evans amphitheater, shows mainly outcrops of Archean rocks, those of the Weber Grits, which adjoin them west of the fault line, being generally covered by débris. The wall of Mount Evans facing the amphitheater presents similar conditions to the wall at the head of Iowa gulch, namely, an eruptive mass underlaid by horizontal stratified beds, and the same strong contrast in their weathered forms, the difference being that in this case it is the Sacramento instead of the White Porphyry that forms the intrusive mass. In a shallow ravine on this wall just south of the Mosquito pass there is a slight break in the continuity of sedimentary outcrops, caused by a small cross-fault with a slight upthrow on the north.

**East Ball Mountain.**— The crest of what is known as East Ball Mountain, which is in reality only a spur of West Dyer Mountain, is capped by Lower Quartzite, with a sheet of White Porphyry between it and the underlying Archean. This sheet is evidently the same which has already been noticed on the south spur of Dyer Mountain; in the recess of Dyer amphitheater, however, it must cut partly across the Lower Quartzite, since on the west wall of the amphitheater there is a considerable thickness of Lower Quartzite below the White Porphyry.

AREA BETWEEN MOSQUITO AND BALL MOUNTAIN FAULTS.

**Ball Mountain fault.**— The direction of the Ball Mountain fault is somewhat to the west of north, nearly parallel with that of the Weston fault, and therefore convergent with the Mosquito fault, which it joins on the crest of the Upper Long and Derry Ridge at the foot of the steep slope of West Sheridan. From here it runs in a direct line across Iowa gulch, through the top of Ball Mountain, and bends sharply to the west on its northern slope, passing through the End Squeeze or Cleopatra shaft (F-12).<sup>1</sup> Its movement is defined here by the Fat Purse (F-17), which is in Weber Grits on the west of the fault, and the John Mitchell (E-11), which is in Lower Quartzite on the east; it then runs northward across South Evans gulch, through the Nevada tunnel, which has been driven nearly three hundred feet on its line, and just west of the Seneca shaft, which is in the White Limestone. Farther north its existence is shown only by the widening of the outcrop of Weber Shales and by a slight discrepancy in the outlines of the body of Mount Zion Porphyry in Evans gulch. Its movement of displacement is an upthrow on the east, which has a maximum at the southern end, or in Iowa gulch, of 2,250 feet, and gradually decreases to the northward, being only a few feet in Evans gulch and disappearing entirely in Prospect Mountain.

**Prospect Mountain Ridge.**— On the spur from Prospect Mountain west of the Prospect amphitheater, which is on the line of the fault, there is a slight variation in the regular easterly dip of the Weber Grits, which suggests

<sup>1</sup> The letters and numbers following the names of shafts indicate, respectively, the square and the number within that square, by means of which the shaft may be found on the Leadville map.

that the influence of the fault has produced a slight anticlinal fold. Prospect Mountain, from its summit eastward to the foot of Mosquito pass, is made up of coarse sandstones and micaceous shales of the Weber Grits formation, which dip a little north of east.

**Little Ellen Hill.**—The same beds are found to extend through the main portion of Little Ellen Hill and across the upper part of South Evans gulch, and outcrops where visible have a prevailing dip of  $20^{\circ}$  to the eastward. The lines of structure in a series of beds of such uniform composition are difficult to trace in a country where the surface is so much obscured as here. It is possible, therefore, that the eastern ends of Sections A, B, C, and D, which pass through this region and have been constructed somewhat theoretically, give too great a thickness for this formation; in other words, place the ore horizon at too great a depth below the surface, since the structure lines obtained from other portions of the region, where definite data are more frequent, show no such extent of regular slope, but much more frequent waves or folds. Such, however, have not been indicated here, as in the absence of definite data they would be purely imaginary.

**Eruptive dikes.**—In this area are several outcrops of eruptive bodies, which apparently belong rather to the dike type than to that of intrusive sheets. Two of these occur on Prospect Mountain ridge, the easternmost of which is a coarse-grained quartz-porphry, with large orthoclase feldspars, resembling the Lincoln Porphyry; its feldspars are partly reddish and partly light green, the coloring being due to iron oxide on the one hand, or to light-green mica as an alteration product on the other. The western of these dikes is a fine-grained, dioritic-looking rock, similar to that found in the Arkansas Valley between Indiana and Bird's Eye gulches and at the heads of these gulches. On the north slope of Little Ellen Hill is an outcrop of the same coarse-grained porphyry that is found in the eastern dike. In the bed of Evans gulch, above the Virginus mine and extending up some distance on the north side of the gulch, is an eruptive mass of rather irregular form, whose outlines are somewhat obscured by surface accumulations. It belongs, as well as could be ascertained from the partially decomposed specimens obtained, to the Mount Zion type of porphyry.



**Coal in Weber Shales.**—The carbonaceous beds of the Weber Shales series are unusually well developed in this region and often contain considerable impure anthracite. The greatest developments of this coal are found in the Ellesmere (B-2) and Little Providence (C-8) shafts, in the former of which it is said to have a thickness of eighteen inches and in the latter of seven feet. The coal, however, has thus far proved too impure to be of economic value. Similar beds of coal have been observed by the writer at what is very probably nearly the same horizon in the Pancake Mountains west of White Pine, a short distance from Argenta on the Central Pacific Railroad, and some 30 miles north of Elko on Coal Creek, in Nevada. Explorations at all these localities have, however, failed to develop any workable beds of good coal. In a region like Colorado, therefore, where the Cretaceous formations which are known to contain abundant beds of excellent coal are so widely developed, it seems scarcely advisable to spend much labor in searching for coal at this lower horizon. The name "Carboniferous," which was given to this formation in the early days of geology, when it was supposed to be the only coal-bearing horizon, is a practical misnomer in the Rocky Mountain region, and apt to mislead the untechnical.

**Blue Limestone.**—The outcrop of Blue Limestone from the point where the Ball Mountain fault crosses South Evans gulch, just below the Seneca shaft, follows up the north bank of the gulch and then bends to the south up Alps gulch to the saddle between Ball Mountain and East Ball Mountain. Its existence is proved by explorations of the Little Rische (G-6), Little Ellen (G-5), Lulu (G-4), Izzard (G-3), Gnome (G-2), Wall Street (G-1), Dauntless (C-13), and Alps shafts, which have cut through the overlying White Porphyry to the contact. In the Little Ellen alone has any considerable body of ore been discovered at the contact. Iron vein material of considerable thickness has been found on the contact in the workings of the Alps group of mines, but as far as known little rich ore has been developed. The White Porphyry is here very thin, and at the head of Alps gulch disappears entirely, coming in again on the south side of the ridge. From this saddle the outcrop of the Blue Limestone sweeps round to the eastward to the Black Hawk shaft. This shaft passed through 80 feet of White Porphyry and a little black shale before reaching the Blue Limestone. Beyond

this the Blue Limestone is cut off by the Mosquito fault at the sharp spur running out southwest from East Ball Mountain toward Dyer gulch. Actual outcrops of Blue Limestone and Parting Quartzite, dipping steeply to the east, are found on the saddle east of Ball Mountain. The summit of Ball Mountain, from the saddle westward to the fault, is formed of White Porphyry, of which a thick body here separates the Parting Quartzite from the White Limestone.

The structure of the area between the crest of Ball Mountain and the south slope of Ellen Hill below the outcrop of Blue Limestone is somewhat obscure; but the explanation presented on the map, viz, that of a quaquaversal or anticlinal fold in part cut off by the Ball Mountain fault, is one which best fits the following observed facts.

On the north slope of Ball Mountain, immediately under its crest, can be traced outcrops of White Limestone and of a portion of the Lower Quartzite beneath it. The prominent ridge which extends out on the steep slope towards the valley of South Evans consists entirely of fragments of quartzite derived from the above-mentioned outcrop. Shaft F-6, however, which has penetrated this covering of débris, shows that the underlying rock is White Porphyry. The John Mitchell shaft, west of this, has gone through another body of Lower Quartzite and a second underlying White Porphyry to granite. North of the John Mitchell, at the base of the hill, is a small outcrop of granite, with a little white quartzite resting on it. Still north of this are the Ocean and Seneca shafts, the former in Lower Quartzite, the latter in White Limestone, dipping to the northward. It seems, therefore, that the White Porphyry is here splitting the Lower Quartzite into several distinct bodies, and it may naturally be inferred that somewhere in this region it has been intruded into the Lower Quartzite from the underlying Archean.

The Nevada tunnel discloses a body of White Limestone, resting on quartzite, east of the fault, which dips at  $45^{\circ}$  to the north. This dip is somewhat abnormal to the quaquaversal structure deduced from observations in other shafts of this region, but its proximity to the fault may account for the irregularity.

South slope of Ball Mountain.—On the south slope of the Ball Mountain Ridge, towards Iowa gulch, the White Limestone is also split into three distinct sheets by intrusive masses of White Porphyry. They might perhaps be considered to be simply caught up and included in the porphyry body. One or more of these sheets can be traced on the upper slope of Long and Derry Ridge, in the angle between Ball Mountain and Mosquito faults. South of the crest of Ball Mountain the Emma tunnel (C-10) is run on the contact of White Porphyry and White Limestone, following some iron-stained vein material. West of this and adjoining the fault, the Lower Quartzite outcrops under the White Limestone, dipping at an angle of  $50^{\circ}$  to the east. Another portion of the Lower Quartzite is found adjoining the fault on the shoulder south of Ball Mountain, and in the bed of Iowa gulch erosion has exposed the full thickness of the Lower Quartzite, with a small area of Archean rocks next to the fault on the east, the quartzite dipping east at an angle of  $18^{\circ}$ .

The distribution of the White Porphyry bodies in this area is rather exceptional, as they are principally developed in the lower horizons, forming several sheets within the Lower Quartzite and White Limestone, while the bed above the Blue Limestone is comparatively thin, and at one point entirely wanting. It might be inferred from this that near here is one or more of its vents or points where it has been intruded through the Archean into the overlying Paleozoic beds.

#### AREA BETWEEN BALL MOUNTAIN AND WESTON FAULTS.

This area presents a still more complicated structure than the one just described, owing, first, to the existence of a well-defined anticlinal or qua-quaversal fold, the South Evans anticline; second, to the disturbance produced by the Iowa gulch and Colorado Prince cross-faults, which run transversely across the area; third, to the peculiar movement of displacement of the Weston fault, which has the normal upthrow to the east at its northern and southern extremities, but in the intermediate region has partly a reversed throw or to the westward, and in one portion no displacement at all; and, fourth, to the branching of the Weston fault at its southern end, by which

part of its movement of displacement is distributed to the Union fault. The prevailing dip of the formations is to the east, except in the vicinity of the South Evans anticline.

**Weston fault.**—This fault is approximately parallel with Ball Mountain fault, and follows the same general direction that it had in the area already described outside the limits of the Leadville map. From its intersection with Mosquito fault in Empire gulch, it crosses the Long and Derry Ridge, near the foot of the steeper slope of the Upper Long and Derry Hill, and descends into Iowa gulch just east of the Ella Beeler tunnel (E-7), where it is joined by the Union fault; it runs thence diagonally up the southwest slope of Green Mountain, a little east of the North Star (E-23) and Alta (E-22), and crosses the head of California gulch between the Tiger shaft (E-24) and the Ella tunnel (F-39). From here up the slope of Breece Hill its position cannot be exactly defined, owing to the fact that Pyritiferous Porphyry forms the rock surface on either side. In the ground of the Highland Chief No. 2, however, it passes between two shafts of that claim (F-40 and F-41), the former of which is in the Weber Grits and the latter in Pyritiferous Porphyry, and just east of its main shaft (F-59); it then follows the crest of the ridge to its north point and down its steep north slope between the Chemung tunnel on the east and the Fenian Queen on the west, along the line of the west fork of Lincoln gulch to Big Evans gulch, which it crosses just above the mouth of Lincoln gulch. On the south slope of Prospect Mountain its movement of displacement becomes very slight, and is proved only by the discrepancy in the position of the dividing line between Weber Shales and Gray Porphyry, as shown in the Stillwell (K-11), La Harpe (K-12), and other shafts in Little Evans gulch on the one side and in the Mary Able (K-35) on the other.

The movement of displacement of this fault is quite remarkable, being an upthrow to the west of about six hundred feet in Iowa gulch and about the same amount of displacement reversed, the upthrow being on the east side, near the mouth of Lincoln gulch, opposite the South Evans anticline. This movement becomes null between these two points somewhere in the neighborhood of the Yates shaft (F-66) on Breece Hill.

**Iowa fault.**—The Iowa cross-fault runs east and west along the foot of the cliff, on the north face of Upper Long and Derry Hill, and connects Weston and Ball Mountain faults. The shafts and tunnels between it and the bed of the gulch are either in Weber Grits or Pyritiferous Porphyry, while Archean granite forms the cliff above it on the south. The estimated displacement of this fault is an upthrow of 2,700 feet to the south. It might perhaps be better considered a downthrow to the north, since that portion of the area which immediately adjoins it on that side is in the abnormal position of being relatively lower than the corresponding block of ground on the west of Weston fault.

The uplifted block of ground inclosed by Iowa and Weston faults consists of Archean rocks, principally coarse red granite, with a narrow strip of Lower Quartzite resting on them along the crest of upper Long and Derry Hill. This quartzite is apparently the crest of a shallow north and south anticlinal fold, now almost entirely eroded away. The curve of the strata can be readily seen on the cliff from Iowa gulch; at the western end, toward the fault, the dip steepens to  $30^{\circ}$ . At the eastern end, on either side of the ridge, is an outcrop of a much decomposed, coarse-grained quartz-porphyry, which apparently forms a sheet between the quartzite and underlying granite.

**Southwest slope of Ball Mountain.**—From Iowa fault northward, across Iowa gulch and up the southwest slope of Ball Mountain, the surface is mainly covered by Pyritiferous Porphyry, with occasional outcrops of the sandstones and shales of the Weber Grits. The sedimentary beds all have a gentle dip to the northeastward and are separated by intervening porphyry sheets into three distinct series, the lowest of which is classed as Weber Shales, although black shales are found to a greater or less extent through all the beds.

This lowest series, which crosses Iowa gulch opposite the Ella Beeler tunnel and extends part way up the slope of Green Mountain, comes in juxtaposition with the White Porphyry beyond the fault to the west, and is overlaid by a thin body of Pyritiferous Porphyry, which is cut in a tunnel (E-21) on the slope of Green Mountain.

The base of the Weber Grits, consisting of quartzite, conglomerate, and shale, is shown on the south side of Iowa gulch in the Little Hercules tunnel (E-6), and on the north side in the Black Cloud shaft, which cuts through it into the underlying porphyry. On Green Mountain the Hoosier (E-19) and adjoining (E-20) shaft are sunk in it, and the Equator (E-17) tunnel runs on the contact breccia material between it and a second sheet of Pyritiferous Porphyry above. The outcrops of this body, consisting of iron-stained decomposed porphyry, can be easily traced along the slope of Iowa gulch, but the underlying Weber Grits are obscured by débris. South of the gulch it is shown in the Mount Carbon tunnel and on Green Mountain in the Tiger shaft and in the Ontario and Bloomington (E-9) tunnels. The former passes at 200 feet from its mouth into micaceous sandstones and shales of the second sheet of Weber Grits, while the shaft (E-18) shows breccia material between the sandstones and the underlying porphyry.

The outcrops of the second body of Weber Grits sweep round the upper part of Green Mountain, where the Green Mountain and Lawrence (E-10)<sup>1</sup> shafts have reached it after crossing the lower part of the upper body of Pyritiferous Porphyry; it widens out in the vicinity of the Little Frank (D-2) shaft and the Alleghany and Pine Forest tunnels, and again thins to thirty or forty feet as it crosses Iowa gulch to the Iowa fault below shaft D-4. Above this body of Weber Grits the main sheet of Pyritiferous Porphyry extends up to the crest of Ball Mountain and east to the fault, broken only by isolated outcrops of Weber Grits, apparently representing fragments of this formation caught up in the mass of the porphyry at the time of its intrusion. Such a fragment, consisting mainly of black shales, is cut in the Silver Queen tunnel on the hill slope above the Pine Forest.

The weathered surface of the Pyritiferous Porphyry in general shows no pyrites, but only the cavities from which its crystals have been dissolved out. The old Mariner tunnel, above the Silver Queen, has been run 125 feet from the surface in porphyry thus decomposed, and at the mouth of the former is a deposit of needles of spruce, cemented together and partly

---

<sup>1</sup>Wrongly named Leavenworth on the index sheet of the Atlas.

replaced by limonite resulting from the leaching out of the pyrites. The Weber sandstones at the contact with the porphyry are often brecciated and so impregnated with pyrites as to be scarcely distinguishable from the porphyry. To understand the distribution of the various bodies of this porphyry and their supposed continuation below the limits of exploration it will be necessary to refer to Section G, Atlas Sheet XX. According to this it will be seen that there are three distinct sheets of porphyry above the Weber Shales, while a fourth occurs beyond Weston fault, between the Weber Shales and White Porphyry, which connects with a fifth body found in California gulch, where it crosses the White Limestone and White Porphyry along the cross-cutting zone already mentioned. It is supposed, as shown in the section, that it is in this vicinity that the porphyry came up through the Archean.

**Northwest slope of Ball Mountain.**—The bodies of Pyritiferous Porphyry thin out towards the north, and on the upper part of Breece Hill, or the northwest slope of Ball Mountain, all except the upper one disappear before reaching the Colorado Prince and Ball Mountain faults. No trace of Pyritiferous Porphyry has yet been found east of the latter fault. To the north the lower sheet is stratigraphically replaced by the main sheet of Gray Porphyry, since farther west they are each underlaid by the main body of White Porphyry. In the few cases where underground explorations have disclosed the relations of the Pyritiferous and Gray Porphyries the former is found to overlap the latter.

In this region the beds which have been assigned to the Weber Shales horizon are found to have a much larger proportion of sandstone than the corresponding beds on Little Ellen Hill, but in either case the data are somewhat meager, as no shafts are so situated as to afford a complete or continuous section. The Antelope shaft found 100 feet of white quartzite immediately above the Gray Porphyry. The Quandary shaft found micaceous sandstone; the Garbutt, sandstone and shale; and the shafts of the Ontario (F-50 and F-51), a coarse sandstone. The Capitol (F-57) and the Highland Queen (F-56) shafts passed in depth into a body of quartz-porphyry of different character from the Pyritiferous Porphyry. It were too long to enumerate all the other shafts on this slope, the infor-

mation obtained from which is sufficiently indicated on the map and sections. The Gray Porphyry sheet under the Pyritiferous also thins out to the eastward and cannot be traced beyond the Colorado Prince fault.

**Colorado Prince fault.**—The movement of displacement of the Colorado Prince fault is an upthrow to the southwest, which is about two hundred feet in the middle and reaches a maximum at its junction with the Ball Mountain fault and a minimum at that with the Weston fault. By this movement the southern portion of the South Evans anticline has been cut off and leaves, along the cliff at whose foot the fault runs, a succession of beds dipping generally to the southward; to the faulting and consequent exposure of the edges of these beds the steepness of the cliff is doubtless due.

The White Porphyry sheet immediately over the Blue Limestone is here very thin and in places entirely wanting. The Chemung tunnel at the western edge of this area, near the Weston fault, runs in a southeast direction on the contact between the Gray and White Porphyries, and, cutting across the latter, passes into the Blue Limestone. The Highland Chief and adjoining shafts, a little east of this, pass through the Gray Porphyry directly into silicious vein material, which is the replacement here of the Blue Limestone. North of this the Eliza No. 2 (K-3) strikes Blue Limestone, the Little Alice (K-2) Parting Quartzite, and the Eliza No. 1 (G-58) White Porphyry after passing about twenty feet of Wash, the last reaching White Limestone at a depth of 180 feet. Shaft No. 2 (G-51) of the Miner Boy finds a small body of black shales directly above the limestone, between it and the overlying Gray Porphyry. The Uncle Sam shafts (F-32 and F-33), at the east end of Idaho park, find vein material between Gray Porphyry and Blue Limestone. The Rattling Jack and Little Johnny, still farther east, find a sheet of White Porphyry between the Gray Porphyry and Blue Limestone, with vein material at its contact with the latter. The body of White Porphyry cut in the Little Alice and Eliza No. 1 shafts is evidently of limited extent, as it has not been seen in any other workings.

The White Limestone and Lower Quartzite are cut by the various shafts and tunnels of the Black Prince, Miner Boy, and Colorado Prince claims, the tunnel of the last running south through a body of White Porphyry between the granite and Lower Quartzite and in close proximity



to the Colorado Prince fault. A more detailed description of the structure in the immediate vicinity of these mines will be found in Part II, Chapter V.

In the east fork of Lincoln gulch, according to Mr. Jacob, the Boulder incline is sunk on the line of the Colorado fault at an angle of  $45^{\circ}$  to the north, with granite in the roof and White Porphyry in the foot-wall; while the Cumberland shaft, a short distance east, is sunk 150 feet in White Porphyry. The evidence of the former would prove, therefore, that the Colorado Prince fault at this point is a reversed fault, viz, that the upthrow is on the hanging-wall side, instead of, as is usually the case, on the foot-wall; and the fact that the latter was sunk to so great a depth in White Porphyry without reaching granite would be explained by the nearly vertical position of the sheet. This explanation, which considers the White Porphyry as an interbedded sheet, is supported by the apparent continuity of White Porphyry north of the Colorado Prince fault, around the outcrop of Archean. It seems possible, however, that these shafts may be sunk in the actual channel through which the porphyry came up across the Archean. The Fiteburg incline, on the south side of Lincoln gulch, opposite the Boulder, was run down on the contact of Lower Quartzite and White Limestone, which here dip  $20^{\circ}$  to the southwest.

**South Evans anticline.**—The granite body which forms the crest of South Evans anticline, extending from the north fork of Lincoln gulch to the mouth of South Evans, is shown wherever prospecting has stripped the rock of the overlying soil; also, by the Caledonia (G-59) and Slim Jim (G-46) shafts and by the Silver Tooth bore-hole (G-45). This bore-hole was sunk 314 feet, cutting in its passage downwards 49 feet of White Porphyry, probably a small dike within the granite. The granite in the Caledonia is red and coarse grained; that from the bore-hole, compact and fine grained. The White Cloud shaft (K-15) on the west side of the fold in Lincoln gulch was sunk in the Lower Quartzite, which also outcrops near the road, showing a western dip. A shaft (K-14) on the north side of Evans gulch has found quartz-porphyry directly under the Wash. The Hoosier Girl (G-44), on the east, is in Lower Quartzite, which must be a portion separated from the main body by the lower sheet of White Porphyry. This lower sheet of White Porphyry forms the western point of

Little Ellen Hill, between South Evans and Evans gulches; it is coarser grained than the normal rock and contains numerous quartz crystals. The successively higher horizons of Lower Quartzite, White Limestone, Blue Limestone, White Porphyry, and Weber Shales are crossed as one ascends the hill to the eastward, their existence being proved by the numerous shafts which dot this point of the hill. A small body of quartz-porphyry is found on the slope of the hill toward South Evans gulch, between the Parting Quartzite and White Limestone, which may correspond to that found on the other side of the anticline in K-14. The contact of the Blue Limestone with White Porphyry has been proved in the Virginias, Tenderfoot, and Cleveland shafts, where it is more or less replaced by vein material, and in the first is said to have contained large bodies of low grade and some rich ore. Southward across South Evans gulch this contact is practically unprospected.

The north slope of the anticline is proved on the north side of Evans gulch, in the United States Mint shaft (G-38), which is sunk in the shaly beds at the top of the Lower Quartzite. The northern rim of the anticline is buried below 400 feet of gravel of the Evans moraine, and it is only on the steeper slopes of Prospect Mountain, adjoining Little Evans gulch, that rock in place is found. Here the workings of La Harpe, Stillwell, Little Louise, Golden Eagle, and other claims have proved the contact of the main Gray Porphyry sheet and the overlying Weber Shales. The main Gray Porphyry sheet is not found east of the South Evans anticline, and therefore must thin out rapidly beyond these claims. The body of Mount Zion Porphyry, which crosses Evans gulch above the Ball Mountain fault, as already described (if, as supposed, an interbedded sheet), comes between the Weber Shales and the Weber Grits, commencing opposite where the Gray Porphyry sheet dies out.

#### AREA BETWEEN WESTON AND MIKE FAULTS.

*Mike fault.*—The Mike fault runs more nearly parallel with the Weston fault than the Ball Mountain fault. On the south it extends a short distance beyond the limits of the map, as shown in discrepancy of outcrops on the south slope of Long and Derry Hill, but it cannot be traced beyond the

alluvial deposits of Empire gulch, and apparently passes into an anticlinal fold on the west slope of Empire Hill.<sup>1</sup> On Long and Derry Ridge it is defined at the Kenosha tunnel, where a body of greenish quartz-porphry on the east comes into juxtaposition with White Porphyry on the west; the former body belongs below the horizon of the White Limestone, the latter above that of the Blue. It descends into Iowa gulch near the point where the Long and Derry grade reaches the crest of the hill, crossing the gulch just west of the Now-or-Never (M-49) shaft; passes the western foot of the Printer Boy Hill to California gulch between its junctions with Eureka and White's gulches, and along the western slope of Breece Hill, through the workings of the Mike and Star mine, from which it receives its name.

In the latter region the surface indications do not prove its existence, since White Porphyry is found on both sides; but its movement is proved by the relative depths of the Blue Limestone horizon under the White Porphyry in the two shafts of the Park mine (O-1 and O-4). Its movement cannot be traced north of Adelaide park, and it is supposed to end at its junction with the Breece Iron fault.

Its movement of displacement at the south end is an upthrow to the east, which is about one thousand feet on Long and Derry Ridge and decreases to the northward. North of its junction with Pilot fault, in Iowa gulch, as above stated, the only data are derived from the Park mine, from which it is inferred that the movement is reversed and is an upthrow on the west, gradually increasing from that point to a maximum of about three hundred feet.

**Pilot fault.**—Pilot fault might in one sense be considered the normal continuation of the main Mike fault, from the fact that its upthrow is the same and that the amount of its displacement decreases continuously to the north until its movement is entirely lost in the body of Pyritiferous Porphyry on Breece Hill. Its direction diverges at first very sensibly from that of the Mike fault, being a northeasterly direction across the western slope of

<sup>1</sup> On the Mosquito map (Atlas Sheet VII), by an error of the engraver, which had been overlooked, it has been continued south of Empire gulch to a junction with Union fault on a line which is simply the boundary between White Limestone (c) and Lower Quartzite (b).

Printer Boy Hill and bending to the north beyond the Pilot tunnel, from which it receives its name. It crosses California gulch a little above the Lower Printer Boy mine, and White's Hill just east of the shaft L-34. Beyond that point its position can no longer be defined, but it seems probable that it passes through a slight anticlinal fold under the Breece Hill body of Pyritiferous Porphyry, the continuation of a fold farther north which is proved by the explorations of the shafts in the neighborhood of the Great Hope mine, above Evansville.

**Union fault.**—The Union fault, which is principally developed south of the limits of the map, has a direction nearly parallel with the Mosquito fault. As described in the preceding chapter, it crosses the western slope of Empire Hill and disappears to the southward in the granite area adjoining lower Weston gulch. Its displacement is an upthrow to the east, which from a null point at its south end increases towards the north, reaching a maximum of about one thousand feet at its junction with the Weston fault, in Iowa gulch below the Ella Beeler tunnel, where the Archean comes in contact with the upper portion of the White Porphyry above the Blue Limestone.

In the bed of Empire gulch Archean is exposed east of this fault, and the overlying Cambrian and Silurian beds can be traced, sweeping up the slopes on either side of the gulch, where not covered by the Empire moraines. A few shafts and tunnels have penetrated the moraine material to the underlying quartzite and silicious limestone. Such is the Little Annie tunnel, just east of the fault, on the south slope of Long and Derry Hill, which ran through moraine material into White Porphyry, and at whose end a winze was sunk into the underlying limestone. Farther east the Coffee, Louis Tell, California Rose, and Caledonian tunnels are run upon the contact of White Porphyry and Silurian limestone, which beyond them abut against the granite on the other side of Weston fault.

**Long and Derry Ridge.**—The structure of this ridge is best explained by Section I, Atlas Sheet XX. The actual line of the Union fault on the crest of the ridge is undefinable, since White Porphyry is found on either side. Two small outcrops are found near the crest of the hill, adjoining the Weston fault, which represent portions of the Blue Limestone above the lower beds

of White Porphyry that have escaped erosion. Of these the more northerly one is entirely replaced by iron-stained chert, which forms a rocky outcrop near the crest of the ridge

On the north slope of the ridge, in the sharp angle formed by the two faults, the Ella Beeler tunnel ran in on granite and struck a coarse quartzite dipping southwest, which forms the base of the Lower Quartzite.

From Union fault down to the Long and Derry mines the ridge is covered by the upper main body of White Porphyry, in which are included two comparatively thin beds of sandstone and shale belonging to the Weber Shale formation, associated with which are two small bodies of later quartz-porphyry. The dip of these beds is at a low angle to the eastward, the upper being shown by actual outcrops; the lower, which consists of shales with some sandstone, is shown in the Pride of the West (E-15), Campbell (E-25 and E-26), Gildersleeve (E-27), and Hoosier shafts on the south slope, and by the Herculaneum (E-14) tunnel on the north slope of the hill.

The Blue Limestone is proved on the south slope of the hill by the workings of the Aerial Queen (E-34), Homestake (E-36), and other shafts, which have reached it through the overlying White Porphyry, and by the Himalaya (E-35) tunnel; and on the north slope of the hill by the workings of the Long and Derry group of mines.

On the steep face of the ridge facing Iowa gulch, above Long and Derry grade, is found one of the few distinct outcrops of the two bodies of limestone, the Blue and the White. Here they dip regularly to the eastward at an angle of  $10^{\circ}$  to  $15^{\circ}$ , and are underlaid by a body of Green Porphyry. The Belcher<sup>1</sup> tunnel (M-5) runs in on an ore body in the lower part of the Blue Limestone. Above this and a little to the eastward is a prominent black rock-mass resembling at a little distance the outcrop of a body of iron ore. This is the upper portion of the Blue Limestone body, which is here largely replaced by chert and oxides of iron and manganese. Immediately above this and directly under the porphyry is a body of conglomerate, from 25 to 30 feet thick, which is assumed to be a portion of the Weber Shales cut off from the main body by the porphyry sheet.

---

<sup>1</sup>Wrongly given in the Index of Shafts, etc., as Beecher.

**Long and Derry mines.**— The Long and Derry workings consist of a number of shafts and tunnels, the former of which—the Dana (M-3) and Porphyry (E-37)—reach the contact through the overlying White Porphyry. Two tunnels on the Faint Hope claim (M-2 and M-4) start in the limestone, the latter reaching the contact between porphyry and limestone at 183 feet, while the Long and Derry tunnel (E-32) is run in through the porphyry for a distance of 400 feet. Mineral action has here extended down into the limestone body, and ore is found not only at the contact, but in irregular chambers, at considerable depths below it.

**Dikes.**— Immediately in front of Faint Hope tunnel (M-4) is an outcrop of Gray Porphyry almost identical lithologically with the main sheet of Gray Porphyry. This is part of a vertical dike fifty to sixty feet wide, which can be traced past the Belcher Mine, across Iowa gulch, to the Minor tunnel on Printer Boy Hill. There are three of these vertical dikes, which can be most distinctly seen on the steep slopes of Printer Boy Hill, where in some cases they stand as projecting outcrops, the adjoining rock having been eroded away. They vary from thirty to fifty feet in thickness, and, as well as could be traced on the surface, are nearly parallel and all of the same character of rock.

For some distance from the Long and Derry mines westward no actual rock outcrops are found on the surface of the ridge. Along its southern slope the presence of the White Limestone and of an included body of coarse-grained quartz-porphyry, somewhat resembling the Josephine Porphyry, was detected by means of several small prospect holes, too unimportant to have been indicated on the map. The fine-grained Green Porphyry is much decomposed and of lighter color than in Iowa gulch. The secondary ridge or shoulder of the main ridge, at the very edge of the map, overlooking Empire gulch, is formed by the Empire north moraine, through which few, if any, prospectors have succeeded in reaching the underlying rock. On the north slope of the ridge, as already mentioned, the White Limestone forms continuous outcrops, crossing which can be detected the vertical dikes which cut the strata at right angles.

**Iowa gulch.**— In the bed of Iowa gulch, as shown in outcrops along the creek at the foot of the Long and Derry grade, and in the Minnehaha (M-15

and M-16) and other shafts, is a considerable body of compact Green Porphyry, apparently part of an interbedded sheet underlying the White Limestone. This extends some distance above the bridge, but opposite the Belcher tunnel the outcrops of gray limestone belonging to the Silurian formation are found resting on it, dipping  $12^{\circ}$  to the northeast. In this limestone can be seen the outcrop of a body of coarse-grained quartz-porphyry similar to the rock of the dikes. For several feet from its contact the limestone seems to be hardened and silicified, with small veins of porphyry running into it. It is probably either an offshoot from one of the dikes already mentioned or a separate dike.

From the steep cliff of White Porphyry above the Long and Derry tunnel an immense talus cone of tabular and sherry fragments of White Porphyry spreads out into the valley, so as almost to block it up and to completely cover the outcrops of the Blue Limestone. At first glance it would seem that this immense accumulation of débris must be due to some unusual cause. As none such could be found, the great height and steep slope of the ridge which is occupied by the body of White Porphyry and the peculiar weathering of this particular rock, which, under the influence of atmospheric agents, disintegrates very rapidly into tabular sherry fragments, must be considered an adequate explanation. These fragments, which are very light in proportion to their superficial area, slip down rapidly under the influence of rain, snow, and frost, and soon accumulate in very considerable talus cones at the foot of any steep slope whose surface is largely composed of White Porphyry. Owing to the depth to which the rock surface is buried under this débris, the contact has not been prospected between the Long and Derry mines and the First National.

**Printer Boy Hill.**—On the north side of Iowa gulch, along the south slope of Printer Boy Hill, the contact of the Blue Limestone and White Porphyry is well marked by a series of tunnels and shafts. The First National shaft finds ore at the contact after sinking through 75 feet of White Porphyry. The Seek-no-further (E-38), Mammoth (E-39), and some other shafts have also reached the contact through the porphyry. The Minor tunnel and the upper tunnel of the Florence are at the highest part of the contact, while the J. D. Ward shaft, on the summit of the hill, sinks 300 feet

through porphyry to reach it. From the Florence westward the contact slopes down again towards Iowa gulch through the Sangamon (M-24) tunnel, Brian Boru, Wilson (M-38), Blacktail (M-40), G. M. Favorite (M-44), and other claims and crosses the gulch.

On the north bank of the creek southeast of the G. M. Favorite are found outcrops of Parting Quartzite, consisting here of sandy beds with some purplish shale, and of the top of the White Limestone, dipping  $20^{\circ}$  to the westward. These facts and the outline of the Blue Limestone on the north side of Printer Boy Hill and along California gulch show that under this hill is an anticlinal fold whose axis runs north and south through the west end of the hill, and which, like the other folds, has a steeper slope to the west. On Long and Derry Ridge its western half has been cut off by the Mike fault. The White Porphyry above the Blue Limestone, on the western side of this fold, is cut in the Now-or-Never (M-49) and other shafts in Iowa gulch; and the Nestor (M-28) shaft, on the crest of the ridge, has reached limestone after passing through 170 feet of White Porphyry.

On the north side of Printer Boy Hill, along the upper portion of California gulch, the presence of the Blue Limestone is proved in the Lovejoy shaft (M-29) and in the workings of the Eclipse mine (M-7 and M-9). The Lovejoy passes through the limestone into an underlying bed of quartz-porphyry, which is also found in the Stars and Stripes tunnel and which very closely resembles the Green Porphyry body found in Iowa gulch under the White Limestone. The Eclipse tunnel (M-7) runs in 170 feet through limestone and then strikes the contact of the overlying White Porphyry, which it follows. The porphyry is here unconformable to the limestone, cutting across its stratification. The dip of this limestone is  $15^{\circ}$  to the south. The lower tunnel (M-9), about thirty feet below this, is run on the contact of Blue Limestone and Parting Quartzite; both contacts show vein material. The small thickness of limestone included between Parting Quartzite and overlying White Porphyry is an additional evidence that the latter is here cutting across the Blue Limestone.



**Head of California gulch.**—At the head of California gulch, on the north, the Ohio Bonanza tunnel (not on map) runs in at the surface of a fragment of Blue Limestone which has been left above the White Porphyry; still higher up, the Snowbird shows a sandstone completely impregnated with pyrite and surrounded by Pyritiferous Porphyry, which is supposed to be a detached fragment of Weber Shales. On the south side the Tinker (E-43) shaft has penetrated the White Porphyry to the underlying limestone. The Belle Vernon shaft was sunk through 80 feet of Wash and 150 feet of White Porphyry without reaching it.

The occurrence of Wash here in California gulch is significant, as showing that the Iowa gulch glacier must at one time have filled the valley to the height of the saddle east of Printer Boy Hill and a part of its moraine material must have been pushed over into the head of California gulch, or else that a portion of the glacier actually extended over the ridge. In the lower part of the gulch there is no evidence of glacial action.

**Pyritiferous Porphyry.**—On the south side of Green Mountain, overlooking Iowa gulch, is the Alta tunnel, which runs 30 feet through Wash, 63 feet through White Porphyry, and 192 feet into the overlying body of Pyritiferous Porphyry, here dipping northeastward, while the North Star shaft (E-23), just above it, is sunk in Pyritiferous Porphyry. The rock here, though characteristic, does not contain much pyrite, except at the end of the Alta tunnel, where it is associated with stains of galena. Little Schuyll kill shaft, in the south head of California gulch, has been sunk through Pyritiferous Porphyry into the underlying White Porphyry, while the Ella and adjoining (F-38) tunnels are run in Pyritiferous Porphyry. All these shafts are just below the Weston fault, and the Pyritiferous Porphyry belongs to the main sheet which covers the greater part of the slopes of Breece Hill, and which corresponds with the lowest sheet east of the fault, viz, that found just above Idaho Park.

In California gulch, as already stated, there is a still lower body of Pyritiferous Porphyry, whose rock, though not absolutely identical with the other, resembles it closely enough to form a part of the same body, and which comes at different points in contact now with the Blue Limestone and now with the White Limestone. It is therefore supposed to be cutting

up across these beds. It is proved on the south side of the gulch in the Ben Franklin tunnel and shaft and in the Kid, Burt (M-13), Soda Card (M-20), and other shafts. The Wynan shaft (M-12) has sunk into it through the Parting Quartzite, while the Eclipse No. 2 shaft (M-8) is still in White Limestone.

North side of California gulch.—On the north side of Upper California gulch the Parting Quartzite outcrops at Pigtail gulch and can be traced in a number of prospect holes and in the slide. In the Iron Duke it shows iron ore which deflects the needle. The Frank shaft (L-26) has gone through the White Porphyry into underlying White Limestone. The Charlie P. (L-28) tunnel in Pigtail gulch and the P. I. R. (L-29) and Comstock tunnels run also in White Porphyry, which gradually thins out to the westward between the two bodies of Pyritiferous Porphyry. The Comstock runs in on the contact of this White Porphyry and a thin layer of dark, impure limestone, which dips 15° to the northeast and is considerably mineralized. From it has been obtained serpentine similar to that found in the Red amphitheater of Buckskin gulch. The lithological character of this limestone gives no definite indication of its horizon. The presence of the serpentine allies it to the White Limestone, but general stratigraphical considerations favor its reference to the horizon of the Blue Limestone.<sup>1</sup> In either case it is evident that the White Porphyry, as well as the lower body of Pyritiferous Porphyry, is here cutting up across the strata.

Printer Boy Porphyry.—Lower down the gulch the portion of Printer Boy Hill included between the Pilot and Mike faults, a wedge-shaped block of ground which seems to have been let down between them, shows at the surface only a body of quartz-porphyry, which is noticeable as being that in which the principal developments of gold ore have thus far been found, those of the Printer Boy and "5-20" mines. This porphyry is generally decomposed and does not correspond exactly to any other found in the region, though somewhat resembling the Gray Porphyry. It has a greenish-gray matrix, owing its color doubtless to the decomposition of bisilicates, with large white opaque feldspars often two to three inches long. Its eastern limits are defined by the Abe Lincoln (M-36), Nightingale (M-33), and

<sup>1</sup> On the map this limestone is outlined, but the blue color has been omitted.

Pilot tunnels, the latter of which is directly on the fault line. The workings of the various shafts of the Printer Boy mine follow a crack or fissure in the body of this porphyry and cut an apparently included body of Pyritiferous Porphyry. The Gray Eagle tunnel in Eureka gulch is on the western limits of the body, in contact with an underlying mass of Pyritiferous Porphyry. The Fitz-James (?) shaft (M-54), at the head of Eureka gulch and just west of the Mike fault, after penetrating the Wash, was sunk through a large mass of decomposed porphyry, apparently of two kinds, one supposed to be Pyritiferous Porphyry, and reached the White Porphyry, still below that. This body of Pyritiferous Porphyry is apparently part of the main sheet that covers Breece Hill, and seems to thin out to the south and west. It forms the bed of California gulch from Oro City up to the Pilot fault, while the underlying White Porphyry outcrops below Oro City. The shaft L-44, still on the east side of the Mike fault, is sunk in this same underlying White Porphyry.

**Mike mine.**—The Mike mine, just east of the head of Nugget gulch, is also sunk in the White Porphyry, a little west of the line of the fault. The porphyry here shows a very peculiar semi-columnar structure, which is evidently due to the pressure and movement caused by the fault. It separates out in long, flattened prisms, and the porphyritic structure of the material, which is reduced practically to a clay, is almost lost. The flat surfaces of the prisms are parallel to the fault plane, and not at right angles to it, as would be the case if it were the columnar structure of a dike.<sup>1</sup>

**Breece Hill.**—The whole surface of Breece Hill north of California gulch and east of the Mike fault shows nothing but Pyritiferous Porphyry. In the weathered rock, as has already been stated, pyrites are not generally found, having been dissolved out by surface waters; but wherever it is exposed by shafts or tunnels it is found to contain, at a distance from the surface, a most remarkable quantity of fine crystals, varying from almost microscopic size to one-eighth of an inch or more in diameter. These are frequently concentrated along natural joints in the rock, and in such cases

<sup>1</sup>Developments made in this mine since the completion of field-work have confirmed the assertions made in regard to the structure at this point, and shown on Atlas Sheet XVIII, Section FF. The contact was struck in the shaft at a depth of 426 feet, and the fault proved by a drift run east. The formation dips 20° to the southwest, showing that the amount of basining-up was under rather than over valued. The ore found is principally sulphurets and said to be exceptionally rich.

sometimes accompanied by a slight deposit of galena, as, for instance, in the Printer Girl, Lalla Rookh, and Lillie tunnel. Thus far no valuable deposits of ore have been found in this body, nor, except on its northern edge, has its thickness been determined. On its southern and western borders it is found to be underlaid by White Porphyry, and on the northeastern edge the main sheet of Gray Porphyry intervenes between the two. As already explained, it is evidently cutting up across the formations in California gulch, and on White's Hill it rests directly on the lower sheet of White Porphyry, probably cutting up across Blue Limestone and upper White Porphyry to the north, as shown in the north and south sections, K and L, Atlas Sheet XXI. The numerous prospect shafts which have been sunk in this body were mostly deserted at the time of this visit, so that definite data as to their depth could not always be obtained. The Comstock (L-17) and Tribune (L-11) shafts had reached a depth of 300 feet and were still in it. The Cumberland shaft, at a depth of 450 feet, had struck the underlying Gray Porphyry, into which it had penetrated 25 feet. The Lady Jane shaft, a little to the west, had also reached the Gray Porphyry, but its depth was not ascertained. At the northwestern corner of the body, the Ishpeming shaft (L-42) and the Kent shaft (L-43) had also penetrated the Pyritiferous Porphyry, the former to a depth of 90, the latter of 100 feet, and reached the underlying White Porphyry, showing that the Pyritiferous Porphyry rapidly thins out in this direction.

**Breece fault.**—The northern limits of the body are sharply defined by the Breece cross-fault. This fault, which has porphyry on either side and at its western end identically the same rock, cannot be traced on the surface. It has a nearly east and west direction, extending across Adelaide Park, through the Silver Cloud (K-59) and Eureka shafts, north of the Kent, south of the Breece Iron, north again of the Glasgow and Comstock shafts, which are in the Pyritiferous Porphyry, and south of the Pennsylvania shaft (K-19), which is in the Gray Porphyry. The porphyry in the Silver Cloud shaft shows the same evidence of pressure as that already described in the Mike, while the Eureka shaft shows a breccia material made up of small fragments of what would appear, under the microscope, to be volcanic rock of the rhyolitic type. No satisfactory explanation of this

peculiar occurrence has been found, nor can it be hoped for until work on the now abandoned shafts shall be resumed.

The upthrow of the Breece fault is to the north, and apparently reaches a maximum at its eastern end, where it is estimated at about 500 feet.

**Breece Iron mine.**—The Breece Iron mine, which is situated on the western slope of Breece Hill, overlooking Adelaide Park, has a remarkable deposit of red hematite, mixed with magnetite, which occurs at the contact of the main sheets of White and Gray Porphyries. Its ore is found at the surface in two bodies, having a maximum thickness of nearly thirty feet each, the lower of which is underlaid by White Porphyry, while, between it and the upper body, which is apparently an offshoot from the main body, is a sheet of decomposed porphyry which has certain resemblances both to the Pyritiferous and to the Gray Porphyry. This deposit is apparently due to the oxidation of a mass of iron pyrites, which were brought to their present position in solution in a similar manner to the other ore deposits of the region. Indications of iron are found along the contact line between the White and Gray Porphyries, to the eastward, but as yet no considerable bodies of iron have been developed.

West of the Breece mine, the Superior and Mountain Boy, on the ridge connecting Breece and Yankee Hills, have also struck a considerable body of iron between the Gray and White Porphyries, dipping north. This may be a continuation of the Breece Iron body, the intermediate portion having been removed by the erosion of the head of Stray Horse gulch, which has brought to the surface the White Porphyry underlying the Gray. On the other hand, while the Breece iron is an anhydrous red hematite, the material developed in these shafts consists of brown hematite and bluish-gray chert, the usual replacement material of Blue Limestone, for which reason the outcrop is indicated on the map by the color of that formation. The Theresa (K-57) shaft, to the northeast, finds shales impregnated with pyrites at the contact of the two porphyries, at a depth of 325 feet.

#### AREA NORTH OF BREECE FAULT.

The line of Mike fault, if continued northward, would pass through an anticlinal fold, whose crest reaches from the north slope of Yankee Hill to

the southwest foot of Canterbury Hill, just below the forks of Little Evans gulch. To this line converges also the northern end of the Iron fault, whose throw becomes null at the crest of the fold. The simplest expression of the structure of the region between Fryer Hill and Weston fault north of Stray Horse gulch is that of a synclinal basin in Little Stray Horse Park, the eroded crest of an anticline at Yankee Hill, and a syncline farther eastward, whose rim is partially cut off by the Weston fault. The intrusive masses of porphyry here associated with the regular sedimentary series are a lower sheet of White Porphyry between the White Limestone and Parting Quartzite, an upper sheet of White Porphyry above the Blue Limestone, and the main sheet of Gray Porphyry above it. This comparatively simple structure, resulting from folding alone, which obtains along the line of Big Evans gulch, on the north slope of Yankee Hill, is complicated on the south, first, by the displacement of the Iron fault, which cuts diagonally into the crest of the fold after crossing Stray Horse gulch west of the Argentine tunnel and passing between the Double-Decker and Highland Mary shafts, the east and west shafts of the Hard Cash mine, and through the eastern end of the Chieftain tunnel; secondly, by the movement of the Adelaide cross-fault, which extends from the Iron fault opposite the mouth of the Argentine tunnel, just west of the Laura Lynn shaft, to the saddle between Adelaide Park and the head of Nugget gulch; and, thirdly, by the intrusion of several irregular masses of Gray Porphyry.

*Syncline east of Yankee Hill.*—The greater part of the surface between Yankee Hill on the west, the mouth of Lincoln gulch on the east, and the steep slopes of Prospect Mountain on the north is covered by the main sheet of Gray Porphyry, which directly overlies the upper sheet of White Porphyry. The White Porphyry only comes to the surface along the flanks of the Yankee Hill anticline and in the valley of Upper Stray Horse gulch and Adelaide Park. The contours of the map in the latter region would seem at first glance to negative the idea that the exposure of porphyry was simply due to a deeper erosion, since they show in the White Porphyry area not only a valley but also the summit of a ridge. It must be borne in mind, however, that these contours represent the actual surface of the ground and not the rock surface, whereas the geological outlines refer only

to the latter; and the records of the depth of Wash in various shafts here show that this ridge was formed by the south moraine of the Evans glacier.

The Keystone (K-58), Uranus (K-53), Tiger bore-hole (K-47), White Check (K-48), Tootie Gaylord (K-46), Big Six, and the lower shaft of the Breece Iron have found White Porphyry immediately under the Wash, the latter shaft being sunk into it for a depth of 350 feet, while the Tiger bore-hole, at a depth of 500 feet, was, as well as could be ascertained, still in it.

On the upper northwest slope of Breece Hill are a number of shafts in the Gray Porphyry, most of which have not gone through it. The Fenian Queen, adjoining the road, passed through 150 feet, respectively, of Gray and White Porphyry into the underlying Weber Shale. The Nora, near the foot of the slope below it, reached the contact under the Gray Porphyry without finding any intervening White Porphyry.

A group of shafts in the neighborhood of the Great Hope and Across-the-Ocean find the Blue Limestone at a comparatively small depth, in general not more than seventy to eighty feet, and the White Porphyry between it and the Gray Porphyry is either very thin (fifteen to twenty feet in the shafts above mentioned) or entirely wanting, as in the Bosco (K-28). The Great Hope, after passing through these sheets of White and Gray Porphyry, found 60 feet of vein material, and reached the Parting Quartzite, here carrying gold, at a depth of 130 feet. On the other hand, directly west of these shafts, the Independent has been sunk 420 feet in the Gray Porphyry and the H. M. L. 160 feet without reaching the bottom, while the Onota, which is 150 feet lower than the Independent, found vein material at a depth of 400 feet, after passing through 300 feet of Gray Porphyry and 100 feet of White Porphyry. There is, therefore, evidently a synclinal basin between the Great Hope and the crest of Yankee Hill, and also some indication that the contact sinks to the eastward before rising up under the influence of South Evans anticline against Weston fault; in other words, that there is a slight ridge or secondary fold in the strata on the line through these shafts, as shown in Section D, Atlas Sheet XVIII.

The Little Prince, on this same line, but higher up on the slope of Breece Hill, reached the Blue Limestone horizon, which is here represented by a

mass of silicious vein material containing pockets of carbonate, at a depth of 230 feet. Inasmuch as this shaft starts at an elevation of about two hundred and fifty feet above the Great Hope, the absolute level of the contact is here even higher than at the Great Hope, as shown in Section L, Atlas Sheet XXI.

A number of shafts near this—the Galesburg (K-33), the White Prince (K-36), and Nettie Morgan (K-38)—have also reached the contact after passing through Gray and White Porphyry. The Big Six, at a depth of 300 feet, and the Tiger bore-hole, at 500 feet, as already mentioned, were still in White Porphyry, showing that in a southwest direction it thickens very rapidly. Between Evans gulch and Little Evans the moraine ridge buries the rock surface to such a depth that except at its western end it has not been reached.

On the slope of Prospect Mountain, as will be shown later, the Gray Porphyry is overlaid by the Weber Shales. The underlying White Porphyry is thinning out to the northeast, while still farther north the Mount Zion Porphyry comes in between the Gray Porphyry and the Weber Shales.

**Yankee Hill anticline.**—Across the west slope of Yankee Hill, just below its crest, runs the axis of an anticlinal fold, which in Evans gulch probably bends to the southwest to connect with the anticline shown at the forks of Little Evans, at the south base of Canterbury Hill. The rock surface in the crest of the fold on Yankee Hill is formed of White Porphyry, belonging to the sheet which comes between the White and Blue Limestones, this region being northeast of the imaginary line already mentioned as running southeast from Fryer Hill, along which the main sheet of White Porphyry splits in two, one portion remaining above the Blue Limestone and the other being found below it.

**North slope of Yankee Hill.**—The regular succession of beds on either side of the axis of this anticlinal fold is best shown in the shafts on the north side of the hill. In Johnson gulch the Andy Johnson (P-1) shaft reaches the contact after passing through both the main sheet of Gray Porphyry and the underlying White Porphyry, the latter being here 84 feet thick. The Bevis No. 3 (P-5), Bevis Discovery (P-6), and the Boulder Nest (P-8) shafts have started in White Porphyry and reached the contact



at depths below rock surface of 170 feet, 45 feet, and 50 feet, respectively, the latter having also 70 feet of Wash. The Hidden Treasure tunnel (P-7) is run in on the contact line. The William and Mary tunnel (P-12) runs on the contact of the Parting Quartzite and White Limestone, and the Sappho shaft develops the contact of White Limestone, dipping  $10^{\circ}$  east, with underlying White Porphyry. This White Porphyry is the lower sheet which occurs normally between the Blue and White Limestones, and the White Limestone developed in the two shafts is evidently a portion split off from the main formation by this porphyry sheet and left above it. The White Rabbit (P-17) and Little Stella are sunk in the lower sheet of White Porphyry, the latter having reached the main body of White Limestone below it. The Bismark (P-20) and Holden (P-24) are sunk in the lower portion of the White Limestone, near the crest of the fold, the latter having reached the Lower Quartzite beneath it.

On the west of the fold the J. B. Grant and the Dania (P-30) are sunk through the lower sheet of White Porphyry into the underlying Limestone, while the First Chance (P-37), Bobtail (P-40), and the Cordelia Edmonston find Blue Limestone, or the vein material which replaces it, immediately below the Wash. These outcrops form part of the eastern member of the Little Stray Horse syncline.

**South slope of Yankee Hill.**—On the south side of Yankee Hill, towards Stray Horse gulch, the simple anticlinal structure shown above is considerably complicated. The first disturbing element is the Iron fault, which may be regarded as the result of an anticlinal fold, since the beds dip away from it on either side. Hence, an eastern dip is found here in a position on the slope corresponding to the western dip shown in the last-mentioned shafts, and, by the movement of the fault, Lower Quartzite and Archean outcrops are exposed directly east of it. Besides this, there extends from the crest of the hill southward across Adelaide Park a large mass of porphyry resembling Gray Porphyry, which splits the Blue Limestone, and which, from the meager data obtainable, seems to be cutting up across the formation from below. For convenience of description this mass of porphyry will be called the Adelaide body. Near the crest of Yankee Hill a considerable body of iron-vein material has been developed, which passes into Blue

Limestone to the south and belongs to the eastern member of the Yankee Hill anticline, being a continuation of that found in the Andy Johnson and other mines.

The Little Champion (P-11) and Greenwood shafts were still in this body of vein material, the former at a depth of 200 feet, after having passed through 30 feet of Wash and 15 feet of White Porphyry. The Clara Dell shaft, close by, found Wash, 126 feet; vein material, 5 feet; White Porphyry, 95 feet; Adelaide Porphyry, 20 feet; and White Porphyry again, 121 feet. The Rothschild (P-9) was sunk 65 feet in Adelaide Porphyry, while the Leavenworth (P-4), a short distance east, reached the Blue Limestone after passing through 220 feet of White Porphyry without finding the Adelaide body, which must therefore go down very steeply on this line. The Louisville (O-13) on the north and the Laura Lynn (O-15) on the south side of Adelaide park are both in Adelaide Porphyry, while the Day bore-hole (O-14) in the middle furnishes the following important section, as derived from an examination of drill-cores: Adelaide Porphyry, 100 feet; White Limestone, 87 feet; Adelaide Porphyry, 39 feet; White Limestone, 37 feet; Lower Quartzite, 116 feet; Archean, 2 feet. It thus appears that the Adelaide Porphyry is here in part immediately above the White Limestone, whereas in the Clara Dell it was in the lower body of White Porphyry, which is wanting at this point. From the extremely short distance between the Rothschild and Leavenworth and from the great depth of the Blue Limestone in the latter, it is assumed that a probable angle of dip of the Blue Limestone would bring it to the surface near the former, were it not that it is here cut off by the Adelaide Porphyry, which must cross it nearly vertically. South and east of the Day bore-hole again, the Park (O-4) shaft, the shaft O-6, and the Lily (O-5) shaft find Blue Limestone beneath the Wash, the last having reached White Porphyry beneath it. In the two latter shafts and in the eastern Park (O-1) shaft the limestone has a cream-colored tint, resembling decomposed White Porphyry, while in the western Park shaft it has the characteristic blue-gray color. The underlying White Porphyry is cut in the adjoining shafts (O-10), (O-12), and Keno (O-11), while Keno (O-7) is near the probable line of the Adelaide fault. The Horseshoe shaft, just south of these, at the head of Nugget

gulch, passed through over four hundred and eighty feet of the upper sheet of White Porphyry before reaching Blue Limestone.

**Adelaide fault.**—The Adelaide cross-fault follows nearly the bed of Stray Horse gulch from the Iron fault up as far as the Adelaide smelter, from which point it bends southward, passing to the south of the Laura Lynn shaft. In this portion, however, it is impossible to determine its location with any approach to accuracy, as but few shafts are sunk and at its eastern end White Porphyry occurs on either side of it. Its displacement is slight, its upthrow being on the northeast, and probably reaching a maximum at its eastern end. It might be considered as a branch of the Mike fault, that fault having split into two at its northern extremity.

It must be admitted that the triangular piece of ground in Adelaide Park between the Mike fault and the Adelaide cross-fault, in which the few deep shafts that have been sunk are mainly in different varieties of porphyry which the miners do not distinguish apart, shows a complication of structure of which the explanation afforded by the map and sections may not prove entirely accurate when more extended explorations are made. There seems little doubt, however, that the irregular body of Adelaide or Gray Porphyry has been forced up directly from below somewhere in this region; that it crosses the strata, and by thus interrupting the currents has been influential in determining the deposition of metallic minerals in this neighborhood, which are not only very abundant, but very irregularly distributed.

**Southwest slope.**—On the southwest slope of Yankee Hill the succession of outcrops indicated by the shafts is as follows: The Shenango (P-16) and Logan No. 2 shafts are in White Porphyry, below the Wash, while the Woodruff and Red-Headed Mary (P-22) have penetrated this body and reached the White Limestone beneath it. The shaft P-25 finds White Limestone below the Wash; the Hard Cash (P-31) and the Moonstone (P-32) shafts are in Lower Quartzite, and the Hard Cash (P-35), Logan No. 1 (P-27), and Silver Basin shafts have penetrated the Lower Quartzite to the underlying Archean. The Double-Decker shafts (P-47 and P-48) have been working on a body of gold ore in the Lower Quartzite, near the junction of the Adelaide and Iron faults.

**Moraines.**—The depth of Wash, where it could be obtained, affords data for locating the limits of the south branch of the Evans glacier. These nearly coincide with the bed of Stray Horse gulch, which has been eroded along the contact of its moraine with the rock surface to the south. South of this line there is practically no Wash, while the line of shafts just north of it show the following depths of moraine material: Leavenworth (P-4), 207 feet; Rothschild (P-9), 260 feet; Clara Dell, 126 feet; Woodruff, 148 feet; Logan, 100 feet; Silver Basin (P-33), 231 feet; Indiana (P-53), 180 feet; Raven, 200 feet; Right Angle (P-69), 200 feet; Hunkidori (in the gulch), 35 feet; Denver City shafts, 180 feet.

#### AREA BETWEEN MIKE AND IRON-DOME FAULTS.

The area west of the Mike fault is divided into three faulted blocks by the displacement of the Iron-Dome and Carbonate faults. North of the line of Stray Horse gulch these faults merge into folds, and the structure is that of a series of anticlines and synclines, of which the Yankee Hill anticline and syncline have just been described. In what follows, the areas included between the two faults will be first taken up; then the Little Stray Horse Park syncline and Fryer Hill double anticline; after that the Prospect Mountain region north of Evans gulch, in which the folds are merged into one broad anticlinal and synclinal fold, and finally the as yet unknown mesa region under Leadville itself.

**Iron-Dome fault.**—The Iron fault has been actually cut by underground workings and its plane explored to a greater extent than any other in the region, so that the line of its intersection with the rock surface is the most accurately determined, and perhaps for this very reason the most irregular. This irregularity has no doubt been exaggerated by the effect of erosion, and if the intersection of the fault plane with the rock surface were in a horizontal plane it would show less abrupt curves, but still present a marked contrast to the lines usually employed to represent fault outcrops.

At its north end, on the west slope of Yankee Hill, as already shown, it merges into an anticlinal fold. Its plane is first cut at the end of the Chieftain (P-43) tunnel, which runs 360 feet in an average direction S. 55° E. through Blue Limestone and vein material, much compressed and

broken, and passes suddenly into granite; the plane of the fault is here nearly vertical. South of this point it passes between the (P-46) shaft of the Hard Cash mine in vein material on the west and the two (P-31 and P-35) which are in Lower Quartzite on the east. It crosses Stray Horse gulch between the Argentine tunnel and the Devlin shaft, then is lost sight of in an area of White Porphyry, in which it bends to the west, and is next seen in the Codfish Balls (O-37). Its course beyond this through the mines of Iron Hill will be described in detail in Part II, Chapter II.

Beyond California gulch it is again lost sight of in porphyry, but its line would carry it into the axis of a synclinal fold between California and Iowa gulches. The actually proved continuation of its movement is along the California fault up California gulch to the Dome fault, which runs south across Dome Hill and in Iowa gulch passes into a probable anticlinal fold. The displacement of this fault is an upthrow on the east, its maximum of about one thousand feet being reached opposite the Iron mine, and decreasing both to the north and south.

The area between Mike and Iron-Dome faults from the southern boundary of the map to the Adelaide cross-fault is practically a block of easterly-dipping beds, the surface being principally formed by the main sheet of White Porphyry, with a fringing outcrop on the west of the Blue Limestone, and, where erosion has cut deep enough before the Iron-Dome fault is reached, by those of the lower formations. These are actually exposed only on the south slope of Iron Hill, facing California gulch.

**Long and Derry Ridge.**—On Long and Derry Ridge, west of the Mike fault, the underlying rocks are buried beneath the moraines of Empire and Iowa gulches, and, as shown on the general map, by Lake beds, so that the indications afforded by shafts of the position of the outcrops of Blue Limestone are comparatively rare. As far as known, the Echo and Hoodoo, at the head of Thompson gulch, are the only ones that have proved it, the one at a depth of 160 feet, the other at a depth of about one hundred and ten feet.

**Josephine Porphyry.**—The Josephine, Pine Tree, Aurora, and other shafts have developed a body of porphyry which has been called after the first-named shaft, in which it has been best developed. It apparently forms a sheet between the White Porphyry and underlying Blue Limestone, the

Pine Tree having reached it after crossing 145 feet of White Porphyry. It is a coarse-grained, gray rock, containing white and rather glassy feldspars, quartz in smoky, rounded grains, and biotite in distinct crystals. Cavities filled with white opaque calcite are frequently found. The gray color of the groundmass is due to numerous black specks, many of which are ore grains and others minute biotites. The feldspars under the microscope are seen to be partly triclinic, although monoclinic feldspar predominates. Both quartz and feldspars contain inclusions of the groundmass and glass inclusions. In the quartz, in one case, fluid inclusions with a moving bubble are also observed. Calcite is present in considerable quantity, both in the groundmass and in the feldspars. In general, from the microscopical examination alone, Mr. Cross would have been inclined to class this rock among the Tertiary eruptive rocks. If it be so, it is probably not an intrusive sheet, as has been assumed, but an irregular dike. These indications do not, however, seem sufficiently decisive to outweigh those of its field habit and mode of occurrence, which ally it to the later intrusions of porphyry of pre-Tertiary age.

**Lake beds.**—Lake beds were found in a prospect hole near the shaft M-41, were passed through by the Pine Tree shaft, and penetrated to a depth of 175 feet in the Continental shaft (M-50), which was sunk in the Iowa south moraine. Several shafts and tunnels have been run in this moraine and have very probably penetrated the underlying Lake beds, but, as far as known, have not reached rock in place on the south of Iowa gulch.

**Iowa gulch.**—On the north bank a number of shafts and tunnels have proved the existence of outcrops of Blue Limestone in the vicinity of the Nisi Prius workings, one of whose tunnels has followed the contact for a distance of 700 feet, disclosing a considerable body of contact vein material. The Little Birdie (N-18) tunnel was driven 200 feet in the moraine without reaching rock in place.

**Dome Ridge.**—On Dome Ridge the principal developments have been made near the outcrops of the Blue Limestone, the few shafts in porphyry at considerable distance east of this not having been sunk to any great depth. No definite data are therefore obtainable as to the aggregate thickness of the White Porphyry sheet. The principal workings are those of the

Dome, Rock, and La Plata mines, the former of which is an incline following down the contact to the east, and the two latter tunnels running in at or near the contact, in a southerly direction. On the steep hillside, at the mouth of the Rock tunnel, stood once a huge outcrop of hard carbonate, from which was obtained the first ore of this character found in the region. A short distance above the contact, on Dome Hill, is an intrusive sheet of Gray Porphyry, which, on the western point of the outcrop, cuts up into the White Porphyry, but in California gulch comes actually in contact with the limestone, and at the La Plata mine cuts into it so that a small detached portion of the limestone is left above this intrusive sheet. It also extends up the south slope of Iron Hill, parallel to the contact, and only separated from it in places by a thin sheet of green *Lingula* shales, which belong to the Weber Shale formation. At the foot of the steep slope of Iron Hill, opposite the Rock mine, the Blue Limestone is laid bare in the quarry of the Montgomery claim.

South slope of Iron Hill.—The steep north slope of California gulch, from here down to the Iron fault, which crosses the gulch at the Garden City mine, presents actual outcrops of the lower Paleozoic formations, the Blue Limestone, Parting Quartzite, White Limestone, and Lower Quartzite, together with an intrusive sheet of Gray or Mottled Porphyry near the bottom of the Blue Limestone. In point of fact, these outcrops are covered by from six to ten feet of slide material, but are readily seen in the numerous prospect holes which dot the side of the hill. The dip of the limestone, as shown by the various inclines on Iron Hill, varies from  $12^{\circ}$  to  $25^{\circ}$ , while its strike is more nearly north and south than the average strike of the sedimentary beds throughout the region. In the Iron mine itself the dip shallows as it is followed into the hill, and becomes, beyond the Tucson shaft, nearly horizontal; while in the Horseshoe shaft, at the head of Nugget gulch, which has reached the contact at a depth of 482 feet, the limestone is said to have dipped  $8^{\circ}$  to  $10^{\circ}$  to the southwest, showing a tendency to a synclinal structure in this block of ground, which is still more marked in the block next west. The Colonel Sellers shaft and drill-hole, south of this, near the mouth of Nugget gulch, had not yet reached the contact.

**North Iron Hill.**—From the Codfish Balls shaft northward to Stray Horse gulch the line of the Iron fault is somewhat indefinite, the miners who sunk the few shafts not having found any valuable ore bodies at the contact and having confounded the limestone, which is here bleached quite white, with the overlying porphyry. In the angle between the Iron fault and the Adelaide cross-fault, as shown by the workings of the Argentine and Adelaide mines, the formation dips to the southeast, so that successive outcrops of White Limestone and Lower Quartzite are brought to the surface. The structure at this point, which will be explained in detail in Part II, Chapter II, is still further complicated by the intrusion of minor sheets of Gray and White Porphyry, which have split up the Silurian formation, and by the crossing of the main sheet of White Porphyry down to the horizon of the Parting Quartzite across the basset edges of the Blue Limestone. The principal mineralization has here taken place at the contact of this White Porphyry with the Parting Quartzite, instead of, as in other cases, on the surface of or in the Blue Limestone.

#### AREA BETWEEN IRON-DOME AND CARBONATE FAULTS.

**Carbonate fault.**—Carbonate fault has a general direction a little more to the east of north than Iron fault. Its upthrow is likewise to the eastward, and the displacement has a probable maximum in the bed of California gulch, where Silurian beds are proved by shaft developments to come in contact with White Porphyry. On the southern slope of Carbonate Hill its plane is actually proved in the shafts of the *Ætna* and *Yankee Doodle* mines. Here its movement is only about two hundred feet; but a second fault is found crossing the *Glass-Pendery* claim, the amount of whose movement, which is also an upthrow to the east, is not known, since the contact has not been reached on its west side. This fault apparently joins the Carbonate fault before reaching California gulch. Northward the movement of the Carbonate fault gradually decreases and is partially distributed among some smaller faults and folds. In this portion its actual plane has not been proved; and it is very possible that it does not extend as a continuous fault as far as indicated on the map. Indeed, in the



Waterloo claim its continuation shows a slight upthrow to the west, so that at some point south of that its movement must be null.

**South of California gulch.**—Of the actual rock surface of the southern portion of this area, which is deeply buried beneath thick deposits of Lake beds and the superincumbent moraines of the Iowa glacier, nothing is as yet definitely known. The outlines as given on the map must therefore be regarded as theoretical deductions from the structure of the adjoining regions developed by actual explorations. That a synclinal fold exists here is well proved, and the probable slope of the rock surface beneath the Lake beds would cut off the successive sedimentary formations approximately along the lines represented on the map.

In Iowa gulch the few prospect shafts were still in surface material. The Black Cat shaft, on the ridge north of the gulch, had been sunk 530 feet through moraine material and underlying Lake beds.

In Georgia gulch the developments of the Coon Valley shaft, where a drill was supposed to have reached contact at 575 feet, show a thickness of 200 feet of Wash, 375 feet of Lake beds, and 75 feet of White Porphyry, with the contact not yet reached at 650 feet. The Resumption shaft, near this, found the same thicknesses of Wash and Lake beds, but had not reached the porphyry. In the Zulu King (N-24) and Commercial Drummer (U-1), northwest of this, near the top of the ridge overlooking California gulch, White Porphyry was found at comparatively shallow depth immediately under the Wash, showing that beneath Georgia gulch a bay once existed in the original Arkansas lake.

**Proof of synclinal fold.**—The intrusive body of Gray Porphyry between White Porphyry and Blue Limestone comes to the surface on the banks of Iowa and California gulches, adjoining Dome fault on the west, thus proving a westward dip in the underlying formations; in other words, that they basin up to the eastward and that the Dome fault runs along or near the axis of a shallow anticlinal fold. It has been reached after passing through White Porphyry on the California gulch side by the Bank of France shaft, in the angle of the Dome and California faults; by the City Bank and Oro City shafts, higher up the slope; and by the Vining (N-19), near the fault

on the crest of the ridge, which reached it after passing through the overlying White Porphyry.<sup>1</sup>

**Emmet fault.**—The Robert Emmet tunnel (O-45) starts in near the contact of Gray Porphyry and overlying White Porphyry. A winze was sunk in the tunnel, from which a drift to the west has cut the Emmet fault, a short cross-fault, by whose movement a little triangular block of ground is lifted up on the westward. Parallel with this fault is a slight anticlinal fold, along the axis of which the Columbia tunnel runs in on the contact and finds the formation dipping away to the right and left, but more steeply to the westward. The Blue Limestone is found in actual rock outcrop on the bank of the gulch below this. The Crescentia shaft, a little west of the Columbia, had reached the Gray Porphyry under the White Porphyry at a depth of 335 feet. It is probable that this body of Gray Porphyry thins out to the west of this.

As to the exact line of the continuation of the Iron fault on the south side of the gulch, if it extends so far, no data have yet been obtained, nor can it be definitely stated whether Crescentia shaft is to the east or to the west of this line. The dip of the formation west of the Columbia tunnel is steep enough to account for the contact not yet having been reached in this shaft at a depth of 335 feet.<sup>2</sup>

**Graham Park.**—On the steep west slope of Iron Hill toward Graham gulch the White Porphyry is probably at its thickest in this area. The Blind Tom shaft has been sunk in it to a very considerable depth, though the exact depth could not be ascertained. The City of Paris shaft and bore-hole are said to have passed through 200 feet of Lake beds and 600 feet of White Porphyry below them. Other shafts on the Carbonate Hill side have reached depths of 500 feet and are still in the porphyry. The Devlin shaft, however, on the northwest slope of Iron Hill, reached the contact at 200 feet and the Highland Mary (P-52) found it at 175 feet. These facts furnish a direct evidence of what might have been assumed by analogy, that the

<sup>1</sup> Since the close of field-work contact has been reached in the Viuing at 317 feet and in the Little Rosie at 375 feet, in the latter of which the formation is said to dip 30° to the southwest, thus confirming the deductions made from the relations of the two porphyry bodies.

<sup>2</sup> Since the close of field-work a westerly-dipping contact is said to have been reached by a drift east from the bottom of the Crescentia shaft, at a distance of 300 feet.

synclinal structure of Little Stray Horse Park, which is on the direct northern continuation of this block, continues in modified form to the southward. It is very probable, therefore, that the contact rises to the eastward before reaching the Iron fault along its entire extent, though it is impossible to say at what angle. In the Agassiz, Greenback (O-53), and adjoining shafts a sheet of vein material of relatively small thickness is found dipping to the northeast, with White Porphyry on either side. This represents a portion of the Blue Limestone which has been split off from the main body by the cutting down of the White Porphyry; that is, the lower sheet of White Porphyry here crosses the Blue Limestone formation at a low angle, leaving wedge-shaped portions of the latter above and below it overlapping each other. The folding of the Little Stray Horse syncline and subsequent erosion have produced a curved line of outcrop, approximately as given on the map. The thin streak of blue on the south side of Stray Horse gulch represents a thin sheet split off from the main body of Blue Limestone, which to the northward thickens so as to include the whole of this body on Fryer and Yankee Hills; while here the bulk of the Blue Limestone is separated from this thin sheet by a great thickness of White Porphyry, probably not less than 600 to 800 feet.

The Greenback shaft, after passing through Wash and Lake beds and 10 feet of White Porphyry, found vein material and limestone in a thickness of 55 feet. The Mahala (T-2) passed through 145 feet of overlying White Porphyry, 10 feet of vein material, and 105 feet of underlying White Porphyry. The Agassiz passed through 40 feet of overlying White Porphyry, 5 feet of shales, and 30 feet of vein material. The Gone-Aboard (T-4) also found vein material, after passing through White Porphyry, at a depth of about seventy-five feet. The Robert Emmet shaft (S-3), after passing through 210 feet of Wash and White Porphyry, cut 50 feet of vein material and passed again into White Porphyry, showing a considerable thickening in the body of vein material to the northward. An actual outcrop of this body of iron is found on the south side of Stray Horse gulch, near the Robert Emmet tunnel (S-13). The Wolfe Tone shaft (T-5), which is about five hundred feet west of the Agassiz, has been

sunk to a depth of over five hundred feet in the White Porphyry, which is here underlying the Agassiz deposit, but without reaching the lower Blue Limestone.<sup>1</sup>

California gulch.—On the west side of the area under consideration rock in place has not been found south of California gulch, except in the Swamp Angel and Jordan (T-14) tunnels on its south bank, which have been run for some 400 feet southward on the contact. The Deadbroke (T-16) and Rosebud (T-18) have also developed the contact on the north side of the gulch, and the J. Harlan shaft has been sunk through Blue Limestone into an underlying sheet of Gray or Mottled Porphyry. Higher up the gulch the Last Rose of Summer and some adjoining shafts struck slates and sandstones belonging to the Weber Shale formation, which belong to a portion of the formation included in the White Porphyry. The Prospect incline, starting in at an angle of 23° in the White Porphyry, reached the contact, whose angle is somewhat shallower (averaging from 12° to 20°), and followed it in for a distance of over five hundred feet. At 375 feet from the mouth was a sharp fold, possibly accompanied by some displacement, in which the contact went down almost perpendicularly for about one hundred and twenty-five feet, and was found again in its normal position at a distance of 14 feet beyond in the regular course of the incline.

The White Limestone is opened in a quarry adjoining the road on the north side of California gulch, directly below the Prospect incline. This is the only point where the White Limestone is found actually visible on the surface in the immediate vicinity of Leadville. The O'Donovan Rossa shaft is also in White Limestone, while the Irish Giant, above it, is sunk through the same sheet of Mottled Porphyry shown in the J. Harlan, into the underlying half of the Blue Limestone. The shaft (T-46) is also in White Limestone, while the adjoining Blind Tom shaft is in White Porphyry on the west side of the fault. A second intrusive body of Gray or Mottled Porphyry in the White Limestone itself is proved by some small shafts in California gulch not indicated on the map, which also show the cropping of

---

<sup>1</sup>Since the close of field-work the Wolfe Tone shaft has reached vein material and limestone at a depth of 625 feet, and after passing through it struck another body of porphyry, whether belonging to the underlying intrusive sheet of Gray Porphyry or White Porphyry is not known. It is probably the former.

the upper portion of the Lower Quartzite adjoining the fault. A shaft still lower down, opposite the sampling works on the edge of the creek bed, is sunk several hundred feet in White Porphyry.

**Carbonate Hill.**—The area east of Carbonate fault, included in the Carbonate Hill map, will be treated in detail in Part II, Chapter III, and only the general features need here be mentioned. The strike of the Blue Limestone is nearly north and south, bending somewhat to the eastward toward the northern end of the hill. Its dip may be taken at an average of  $21^{\circ}$ , but is found locally to vary very considerably on account of a series of longitudinal waves or folds in the formation. The sheet of Gray or Mottled Porphyry within the Blue Limestone is very persistent, and is evidently a later intrusion. From data obtained from the few points at which it has been proved by underground workings, it is evident that it is not confined to any particular horizon, but locally cuts across the beds, sometimes at a considerable angle. It is best shown in the Evening Star mine, where it seems to be at the base of the Blue Limestone. What is apparently an offshoot from it is found at the contact in the Morning Star mine and extending up into the overlying White Porphyry, while west of the line of the fault in the Forsaken and Henriett mines the main sheet is found cutting across the Blue Limestone, and the principal mineralization has taken place between it and the portion of the Blue Limestone which underlies it.

Of the country underlying Stray Horse gulch, Stray Horse Ridge, and Little Stray Horse gulch the structural data obtained from explorations are somewhat unsatisfactory; but on Fryer Hill the continuation of Carbonate fault is found to be a gentle anticlinal fold whose axis runs in a northeasterly direction through the Dunkin ground.

**Little Stray Horse syncline.**—Between Yankee Hill and the crest of Fryer Hill, through which also runs a general anticlinal fold, is included a basin or synclinal fold in the formation, whose deepest portion underlies Little Stray Horse Park. The surface rock in the center of this basin is the main sheet of Gray Porphyry, which is separated from the underlying Blue Limestone by a comparatively thin sheet of White Porphyry. The angle of dip of the beds follows the general rule which prevails in the folds in this region and is steeper on the east side of this syncline than on the west.

Eastern rim.—The Blue Limestone, which is largely replaced by vein material, comes to the surface on the eastern rim of the basin along the foot of the steeper slope of Yankee Hill. It is found directly under the Wash in the Cordelia Edmonston and adjoining shafts. The Birdie Tribble (P-42), at the very edge of the basin, found five feet of porphyry above the vein material and limestone. In the shafts of the Kennebec (P-55) both Gray and White Porphyry are passed through before reaching the limestone, and a sheet of porphyry six feet thick was also cut in the body of the limestone. The Chieftain tunnel and incline run in a southeasterly direction 360 feet through vein material and limestone, finding the Iron fault with granite on its farther side at the end. The limestone here shows the effects of a movement against the fault plane, being compressed into short sharp folds and much metamorphosed. There is a general tendency, however, to dip to the northwest; and it is probable that the extremity of the incline is in the White Limestone, although lithological indications are here extremely deceptive, owing to the alteration to which the rocks have been subjected. The Scooper shaft (P-44), a little to the south of the Chieftain, passed through 20 feet of Gray Porphyry and 5 feet of White Porphyry before reaching the Blue Limestone. The contact here stands so nearly vertical that it was supposed by the superintendent to be a fault. This supposition was rendered more probable by the fact that the line of this contact runs in a southeasterly direction. It is probably, however, only an exceptionally steep dip on this side of the basin. South of this the Del Monte (P-45) shaft is in Gray Porphyry. The Hard Cash (P-46) shaft is in vein material. The Fairplay (P-34) is still in White Porphyry, below the Blue Limestone. The upper White Porphyry, so thin in the Scooper, disappears entirely a little farther south, being altogether wanting in the Rarus shaft (P-61); or, as it might be considered, it is found entirely below the upper sheet of Blue Limestone.

The fact that the Blue Limestone is split into two sheets by the White Porphyry is shown in the shafts east of the Rarus in Stray Horse gulch. The Indiana shaft (P-53) finds the limestone directly under the Wash. East of this the Young Caribou (P-59) finds White Porphyry under the

Wash; and the Highland Mary (P-52) and Snowstorm (P-50), after passing through White Porphyry, reach the lower sheet of Blue Limestone beneath it.

**Center of basin.**—Towards the center of the basin a number of shafts have been sunk to a considerable depth in the overlying Gray Porphyry, and generally find sandstones or black carbonaceous shales at its contact with the overlying White Porphyry, but none have as yet reached the Blue Limestone. The greatest depths obtained have been in the Little Miami (P-58), which went through 269 feet of Gray Porphyry and 30 feet of White Porphyry, having a total depth of 396 feet; the Indiana (P-64) shaft, 230 feet of Gray Porphyry in a total depth of 330 feet; the El Paso, 325 feet of Gray Porphyry, having a total depth of 470 feet, and the Lickscumididrix bore-hole (P-68), which went through 400 feet of Gray Porphyry without reaching the White Porphyry. The deepest portion of the basin is probably somewhere near the latter.

**Western rim.**—On the western rim of the basin contact has been reached in the shafts of the Denver City, Tip-top, and Little Sliver mines, in which a varying thickness of black shale and sandstone, belonging to the Weber Shale group, has been found at the contact of Gray and White Porphyry. The Bangkok (P-77) has penetrated the Gray Porphyry to the underlying White Porphyry, while the Forepaugh (P-76), Cora Bell (P-78), and Union Emma (P-79) are still in Gray Porphyry. The Hunkidori shaft, in Little Stray Horse gulch, at the southern end of the basin, has already reached White Porphyry under the Gray. The Denver City (P-82), Wright (P-74), and Shamus O'Brien (P-73) shafts found Gray Porphyry under 180, 157, and 165 feet of Wash, and reached the Blue Limestone horizon at 234, 320, and 362 feet, respectively, each disclosing about ten feet of sandstone and shale, which carried as high as 22 ounces of silver, between Gray and White Porphyries.

#### FRYER HILL.

As the structure of Fryer Hill will be given in detail in a later chapter, it is only necessary here to give a brief outline of its structure as bearing on that of the surrounding regions.

In this area the formations have a general dip to the northeast, while along an east and west line they partake of the anticlinal and synclinal structure, which is already under discussion. On such a line, as shown in sections C and D, it is seen that the formations developed on Fryer Hill constitute the western rim of the Little Stray Horse basin, being at the same time compressed into a shallow anticlinal and synclinal fold. The axis of the anticline runs through the crest of the hill in the ground of the Dunkin mine, on a line with the continuation of the Carbonate fault. West of this is a broad, shallow synclinal fold, which takes in the ground of the Little Chief, Little Pittsburgh, and Chrysolite mines, giving to the outcrop of the Blue Limestone, as shown on the map, the form of an **S**. In the western portion of the Chrysolite mine ground, successively lower sheets of the lower White Porphyry, White Limestone, and Lower Quartzite come to the surface along the crest of an anticlinal fold, on whose western side, so far as the meager data obtained show, these beds dip steeply under the Wash and Lake beds which form the mesa-like surface of North Leadville. The difficulty of reading the geological structure of this area, which in the above brief statement seems simple enough, is enhanced by a variety of causes. In the first place, here, as in Little Stray Horse Park, there are no outcrops of rock in place, the rock surface being buried beneath about 50 to 100 feet of Wash. The data have therefore to be entirely obtained from shafts, and cannot be intelligently considered until they have been thoroughly mapped. Secondly, the replacement action has proceeded so far that practically no limestone is left, its whole mass having been replaced by vein material. Thirdly, this mass has been split up locally into two or more distinct sheets by the intrusion of White Porphyry. Fourthly, the lower sheet of White Porphyry is cutting across the formation; and, southwest of a line drawn diagonally through the corners of the Fryer Hill map, a wedge-shaped portion of the Blue Limestone is left below this sheet. Fifthly, there are later intrusions of Gray Porphyry extremely difficult to trace, as in their decomposed state they are scarcely distinguishable from the White Porphyry. An interrupted dike of this rock runs through the middle of the area in an east and west direction; and an intrusive sheet cuts diagonally across the White Limestone up into the lower



sheet of White Porphyry, and on the north slope of Carbonate Hill into the Blue Limestone. This Gray Porphyry is exposed in the Vulture No. 2 workings of the Chrysolite mine, in the No. 5 shaft and drifts connecting it with No. 1 of the New Discovery mine, and on Carbonate Hill in the lower workings of the Waterloo and Henriett claims. The porphyry dike is seen in the workings of the Chrysolite, Little Chief, Little Pittsburgh, Amie, Big Pittsburgh, Hibernia, and Lee mines. The White Limestone has been reached in the Amie No. 2 shaft, New Discovery No. 6, and found at the surface under the Wash in the shafts of the Fairview, All Right, and Kit Carson, and in the Chrysolite No. 6 (S-51), while the Lida shaft (S-52), near Cumming & Finn's smelter, and the Little Eva (S-53) reach the Lower Quartzite below the Wash, the former finding a small body of White Porphyry included in it.

## PROSPECT MOUNTAIN.

North of Evans gulch the geological structure, although probably more simple, is more difficult to read, owing to the thickness of loose detrital material above the rock surface and the relatively small amount of underground exploration. The North Evans moraine covers an area, widening towards its lower end, which but few miners have been enterprising enough to penetrate to the rock surface beneath, while on Prospect Mountain itself the Weber formations and the various porphyry bodies, of which it is mainly composed, present but few definitely distinctive characters by which to guide the geologist. In this region faulting action has apparently entirely ceased, and the structure is that of a somewhat irregular system of anticlinal and synclinal folds, whose axes run in such varying directions that it is difficult to deduce from them a satisfactory system. Sections A and B, Atlas Sheets XV and XVI, which run east and west, and Sections M and N, Atlas Sheet XXII, which run north and south, give a graphic delineation of the system of folds at right angles to either.

*Crest of the ridge.*—To the north and east the White Porphyry gradually thins out and the Gray Porphyry comes in contact with the Blue Limestone, while above this a sheet of Mount Zion Porphyry rapidly thickens and reaches its maximum on the north side of the Prospect Mountain, facing

the East Arkansas Valley. West of the summit of Prospect Mountain the structure is that of a broad anticlinal and synclinal fold. On this line, by a deeper erosion at the head of the north fork of Little Evans, the body of Mount Zion Porphyry has been exposed, to be covered again farther west by portions of the Weber Shales and Weber Grits which have escaped erosion on the top of Canterbury Hill, while at the foot of the steep slopes in the valley of the east fork of the Arkansas the Blue Limestone comes to the surface beneath the overlying Gray and White Porphyries. The Weber Shales, which are brought to the surface by erosion, on the east side of the Mount Zion Porphyry, are shown in the Esmeralda, Spotted Tail (I-2), Little Mand (I-3), and Peru (I-5). The Thin Space (I-6) shaft penetrated them to the underlying Mount Zion Porphyry, and the Texas Ranger and Texas Boy's Chance, together with the intervening shafts, are in the outcrop of Mount Zion Porphyry, which is traced as far west as the Liberator.

**Southern slope.**— Along the foot of the steep southern slope of the mountain runs an anticlinal fold with an east-and-west axis, whose culminating point, as shown in Section N, is at the forks of Little Evans gulch. Between this and the top of the ridge is a shallow syncline, along whose axis a portion of the Weber Grits is left above the Weber Shales. The Gray Porphyry underlying the Weber Shales on the west side of this syncline is developed by the Brick Top, Bosco, Moose, and neighboring shafts. Towards the north fork of Little Evans the Hecla and Mountain Lion shafts and the Boettcher (Q-20) and adjoining (Q-19) tunnels are in the Weber Shales; the Geneva Lake (Q-3), Mary Ella (Q-4), Katie Sullivan (Q-11), and Buncombe (Q-13) in the underlying Gray Porphyry.

On Canterbury Hill the Garland (Q-33), Little Willie (Q-49), and adjoining shafts are also in the Weber Shales, on the south side of the syncline; likewise the Maryland, which develops the commencement of the body of Mount Zion Porphyry, here only five feet in thickness. The Resumption (Q-60) shaft is in the Weber Grits, in the middle of the syncline. The Cardinal (Q-39) shaft finds a thin detached body of Weber Shales between Gray and White Porphyries

The Great Prince and Minneapolis, on the north side of the syncline, develop the Mount Zion Porphyry under the Weber Shales, of which in the latter shaft a bed 30 feet thick seems to be included within the body of Mount Zion Porphyry. Between the Princeton (Q-52) and Little Blonde tunnels and the St. Louis shaft the data furnished by intervening shafts show the existence of a second minor syncline. The St. Louis reaches the limestone after passing through 45 feet of Gray Porphyry and 30 feet of White Porphyry. The Mary Ann shafts (Q-51 and Q-56) find White Porphyry at the surface on the crest of a minor anticline. The shafts Q-45 and Q-46 are in Gray Porphyry at the surface, while the Little Blonde and Princeton tunnels develop a considerable body of iron-stained chert, replacing the Blue Limestone and dipping to the north under the White Porphyry.

**Little Evans anticline.**—Immediately below these two tunnels is the apex of the Little Evans anticline, whose main axis runs east and west. It is also connected with the Yankee Hill anticline by a fold running southeasterly and with the Big Evans anticline by one running southwesterly, between which is included the northern extension of the Little Stray Horse syncline. The lowest formation exposed on the crest of the Little Evans anticline is the Lower Quartzite, which is found below the Wash in the Lucknow shaft (Q-54). The Norcom (Q-55) shaft, a little north, finds the White Limestone dipping northward, and the Little Clara (Q-63), south of this, penetrates the White Limestone to the underlying quartzite. A little northwest of this the Lac-la-Belle finds Blue Limestone beneath the Wash.

The axis of the east and west fold, which sinks to the eastward, can be traced in a line of shafts from the Lucknow to the Uncle Sam. The Catawba tunnel (Q-41) runs in on the Blue Limestone just above the Parting Quartzite. The Carbonate No. 2 (Q-37) shaft is sunk through a body of Gray Porphyry, which is included in the Blue Limestone, into the Blue Limestone below, at a depth of 140 feet. The Swing tunnel (Q-42) and the Copenhagen (Q-43) and Carbonate King (Q-36) shafts are in the Blue Limestone on the south side of the fold. In the Hancock (Q-31) and Providence (Q-32) shafts, on the crest of the fold, Blue Limestone dips with it eastward. The Pacific shaft (Q-35) shows a southward dip in the Gray

Porphyry overlying the Blue Limestone. The Columbia shaft, between the forks of Little Evans, penetrates 30 feet of Gray Porphyry and 100 feet of Blue Limestone to the Parting Quartzite beneath. The Humboldt and other shafts between the last mentioned and the Uncle Sam are all in Gray Porphyry. At the Uncle Sam shaft the White Porphyry comes to the surface in the crest of the anticlinal fold, whose axis here rises so that for a short distance the porphyry has been eroded off it. The Uncle Sam shaft has been sunk for a depth of 420 feet, passing through 100 feet of White Porphyry, the underlying Blue Limestone, Parting Quartzite, and White Limestone, and extends 40 feet into the Lower Quartzite, while the Uncle Sam tunnel has been run 250 feet into the overlying Gray Porphyry, and the Powhattan (Q-7) shaft adjoining was sunk through White Porphyry into the Blue Limestone. The Powhattan (Q-9), Rome (Q-6), Eaton (Q-10), and others on the hill above are in Gray Porphyry.

**Yankee Hill anticline.**—Of the anticlinal ridge connecting the Little Evans with the Yankee Hill anticline, few data have been obtained. The Little Hoosier, Abe Lincoln, and shafts P-29 and P-38 have penetrated the Wash to the underlying Gray Porphyry, in which the first named has been sunk 170 feet, the moraine material at this point being 120 feet deep. The shaft P-39 has reached the Blue Limestone beneath the Wash, and the Chicago Boy (P-67) passes through the Parting Quartzite into the lower sheet of White Porphyry. This lower sheet of White Porphyry has not been found north of this point, and is supposed to wedge out.

**Little Stray Horse syncline.**—In the northern continuation of the Little Stray Horse syncline the Buffalo shaft and drill-hole, on the Evans moraine ridge, is said to have reached a depth of 450 feet and is still in Gray Porphyry; and the shaft S-10 is also in Gray Porphyry. No other data could be obtained as to the depth of this basin, so that it can only be said that in its center the contact is probably 500 feet deep at least.

**Big Evans anticline.**—Of the Big Evans anticline, which is a continuation to the northward of that shown on the west edge of Fryer Hill, data are still more meager. The Argo (R-5) shaft finds White Porphyry beneath the Wash and is sunk into the underlying Blue Limestone. Adjoining this on the east is the Douglas (R-4a) shaft, and on the north the R-4 shaft,

each in White Porphyry on either side of what is supposed to be the ridge of Blue Limestone connecting this anticline with South Evans anticline. The Third Term (S-44) bore-hole, just across Evans gulch from the Cumming & Finn smelter, passed through 170 feet of Wash into the Lower Quartzite, in which it found a small body of White Porphyry, supposed to be the same as that already mentioned as found in the Lida (S-52) shaft, on the other side of the anticline. The outcrop of Archean indicated on the map has not been proved by any shaft, but is simply a theoretical deduction from the dip of the beds, the rock surface being buried beneath one to two hundred feet of Wash. On the southwest slope of this anticline the Mystic and Silver Pilot (R-8) have been sunk a short distance in the overlying Gray Porphyry. The Oölite (S-57) shaft passed through 100 feet of Gray Porphyry and 15 feet of White Porphyry, reaching a considerable body of vein material and chert, in which were found fossils characteristic of the Blue Limestone horizon. The Sequa shaft (S-58), about eleven hundred feet west of this, reached a depth of 280 feet, still in Gray Porphyry, showing that the actual contact must be at a still greater depth, and thus proving the southwestern dip on this side of the anticline and a synclinal fold to the west.

#### AREA WEST OF CARBONATE AND FRYER HILLS.

**General structure.**—From the foot of Carbonate and Fryer Hills extends a broad, flat, mesa-like ridge, sloping at a regular angle of about two and a half degrees to the Arkansas Valley. This even surface is doubtless conformable with the surface of the stratified Lake beds which underlie it, over which rearranged moraine material or Wash has been spread out with comparative uniformity by the action of water. The relics of the moraines which were left by the Big Evans glacier are found in the ridge which extends from the west end of Fryer Hill to Capitol Hill; also, in James Ridge, adjoining the mouth of Big Evans gulch, and in a smaller ridge between the two, below North Leadville. No shaft has yet reached the rock surface beneath these recent accumulations of detrital material. The outcrops indicated on the map, and the basin character of the area, as shown in cross-sections, are therefore, in one sense, purely theoretical. As they have been determined, however, after a careful consideration of all the known facts

and probabilities, it is well to state somewhat in detail the grounds on which the existence of a synclinal basin is rendered probable. The first argument in its favor is that of analogy, drawn from the existence of a synclinal basin adjoining it on the east, in Little Stray Horse Park, which evidently continues southward through the block of ground between the Carbonate and Iron-Dome faults. The facts to support this argument, viz, the proof of an actual dip towards the center of the basin from either side, are as follows:

Eastern rim of basin.—First, a western dip in the overlying beds on the west side of the Big Evans anticline is shown by the developments of the Oölite and Sequa shafts. Secondly, the Bob Ingersoll shaft and drill-hole, on the moraine ridge west of Fryer Hill, in East Ninth street, after passing through moraine material and Lake beds, are said to have penetrated nearly three hundred feet of White Porphyry. This shaft is southwest of the line where the White Porphyry cuts down below the horizon of the Blue Limestone. It is probable, therefore, that the porphyry cut in this shaft belongs to the upper sheet above the Blue Limestone, and the fact that so great a depth as 300 feet has been reached without finding contact indicates a very steep dip to the westward. The owners of the American Eagle shaft, at the west base of Fairview Hill, state that the limestone in their workings, which the dump shows to be White Limestone, dips both eastward and westward, which would show that there is an anticlinal fold here.<sup>1</sup> Third, along the west base of Carbonate Hill, the Pocahontas (T-40), Weldon (T-41), Rough and Ready, and other shafts have been sunk to a considerable depth in the White Porphyry beneath the Wash, and the California tunnel is also in White Porphyry until it reaches the Blue Limestone beyond the fault. This White Porphyry can be no other than that which overlies the Blue Limestone, since in this region no considerable body of White Porphyry is known to exist below this horizon; moreover, in the Niles-Augusta, Wild Cat, Washburne, and other mines, as will be explained in the detailed chapter on Carbonate Hill, there are indications of a prevailing western dip to the formations west of Carbonate fault. This summarizes the evidence of westerly dipping beds on the east side of the synclinal basin.

<sup>1</sup>Since the close of field-work, Mr. R. N. Clark, superintendent of the Chrysolite mine, states that the extreme west workings of that mine show the Lower Quartzite and White Limestone to be dipping to the westward.

*Western rim.*—On the western side, in the little cañon at the mouth of the east fork of the Arkansas, adjoining the west end of James Ridge, the Lower Quartzite is exposed in considerable thickness at the surface, dipping at an angle of  $8^{\circ}$  to  $10^{\circ}$  to the southeast, and some workings to the east of this, along the northern edge of James Ridge, are said to have disclosed the overlying White Limestone. The Peoria shaft, on James Ridge (not indicated on the map), may be expected to afford further data as to the actual line of outcrops of the formations and what portion of them have escaped erosion, when it reaches the rock surface. At the time of writing this shaft had a depth of 375 feet and was still in the marl of the Lake beds.

From these meager data and from the probable thickness of Lake beds and the angle of dip of the underlying formations the line of outcrops of the western rim of this basin have been constructed. While, therefore, the fact that a synclinal basin exists beneath this area seems fairly well established by the evidence just given, there is only a possibility that the line of outcrops given on the map will be found by future exploration to be strictly correct. They are dependent on two as yet unknown quantities: first, the angle of dip of the formations on either side of the basin, and, secondly, the amount of erosion which had taken place before the Lake beds had been deposited, or, what amounts practically to the same thing, the thickness of the Lake bed deposits which now underlie Leadville.

#### EXPLANATION OF TRANSVERSE SECTIONS.

The detailed description given above of the geology of the Leadville area can perhaps best be summarized in a consideration of the various sections which accompany the map, and in which this structure is graphically delineated. For its better comprehension the reader is requested to place these sections one above the other in the order indicated by their letters, commencing at the top. The first nine sections (A to I) are on east and west lines, approximately parallel with each other. These sections, being in general across the strike and more or less at right angles to the fault planes, show not only the amount of displacement occasioned by these faults, but the longitudinal folds into which strata have been compressed,

and which are more or less intimately connected with the faults. The other seven sections (J to P) run north and south and give the effects of lateral-pressure. As these are more or less parallel to the fault planes, they intersect the latter generally at an acute angle, and the angle of intersection is often much lower than the actual slope of the fault plane.

In representing the slope of the fault planes, in all cases where there were no data from actual developments it has been given as inclining toward the hanging-wall side at an average angle of  $75^{\circ}$ , and when cut diagonally by the plane of the section the angle of intersection was calculated from these premises. As all these sections are carefully constructed to scale and have a common base line, which is taken at 9,000 feet above sea-level, they represent with a high degree of accuracy the surface of the country and the relative thickness of the different sedimentary bodies, and in less degree that of the porphyry bodies, as far as can be deduced from their surface outcrops. In order to show as far as possible the data from which these sections have been constructed, the various shafts on or in close proximity to the plane of each have been indicated on the sections by lines running below the surface to show the depth to which their explorations have reached, full lines indicating those on the section plane, dotted lines those near it. The relative frequency of these shafts is therefore an indication of the comparative accuracy of the different portions of the section. It must, however, be borne in mind that the underground structure has been arrived at not solely by consideration of the shafts on the actual line of the section, but also by the consideration of the data obtained from the exploration of shafts over a comparatively large area, which afford grounds from which the theoretical structure may be deduced.

**Section A.**—Section A runs along Prospect Mountain ridge a little south of its crest and crosses diagonally the valley of the east fork of the Arkansas near its mouth. Its line lies entirely north of the extreme limits to which the movements of the faults have been traced. Its structure lines contrast strongly with those of the other sections on account of the broad and regular curves. This contrast is probably greater than that existing in nature from the fact that actual data from beneath the surface along this line are almost entirely wanting, and the underground outlines are simply



theoretical prolongations of observed dips. The depth of the Blue Limestone horizon at the east end of the section is probably a maximum. Analogy renders it probable that the eastward dip shallows, and it is possible even that the beds rise somewhat towards the Mosquito fault. This remark applies equally to the corresponding points in the next four sections. The sheet of Sacramento Porphyry is represented here between the Weber Shales and Weber Grits, the horizon at which it occurs on the crest of the range east of the Mosquito fault, since it is fair to suppose that the sheet extended as far west as indicated on the sections. The thickness of the Mount Zion Porphyry on the west slope of Prospect Mountain can only be a matter of conjecture; it is fair to infer that it reaches at least 700 feet in its maximum development. The extension of Lake beds as far north as the line of this section in the Arkansas Valley is proved by excavations on the north bank of the stream. At the western end of the section the shore line against the Archean is shown in the abrupt termination of the Lower Quartzite. This would have been more striking had the section line been placed a little farther north, when the White Limestone would have been found to come in actual contact with the Archean.

**Section B.**—Section B follows in its western course the bed of Evans gulch; then, cutting across the southern spur of Prospect Mountain below the Prospect amphitheater, follows approximately the line of Little Evans gulch, and, crossing the two gulches diagonally just above their junction,<sup>1</sup> runs out on to the mesa at the intersection of the railroad line with Evans gulch. It thus shows portions of the Evans north moraine and, at its crossing of Evans gulch, the supposed shore-line of Arkansas lake. The eastern half of the section shows practically the same structure as Section A, except that the Weston fault comes in in the axis of the broad anticline. In its western half it cuts across the northern extension of the Yankee Hill and the Big Evans anticlines, and of the included Little Stray Horse syncline; and west of this shows the probable slope of the beds in the syncline beneath the mesa, as proved by the explorations of the Oölite and Sequa shafts; also, the White Porphyry, cutting across the Blue Lime-

---

<sup>1</sup> On the section its intersection with Little Evans gulch is wrongly marked "ditch."

stone where the northwest and southeast zone through Fryer Hill would intersect the section-plane.

**Section C.**—Section C runs through the crest of Little Ellen Hill in a direction a little north of west, crossing the South Evans anticline opposite the western point of the hill; thence following the south bank of Big Evans gulch across the north slope of Fryer Hill, it passes through the mesa just north of the railroad station in North Leadville. It thus shows at its east end the movement of the Mosquito fault; and, between this and the mouth of South Evans gulch, the same regular easterly dipping beds seen on the previous sections, slightly displaced by the movement of Ball Mountain fault. On either side of its intersection with South Evans gulch the considerable accumulation of recent material (*r*) represents the moraine left by the Evans glacier. The White Porphyry above the Blue Limestone, which in the preceding sections had thinned out near the crest of the fold, is now supposed to extend back to the Mosquito fault, but in a comparatively thin sheet; while in the crest of the South Evans anticline the dike cut by the Silver Tooth bore-hole is represented as the source of the White Porphyry sheet immediately overlying the granite. The plane of the section intersects that of the Weston fault at its junction with the Colorado Prince fault, and, on the theory of an inverted dip to the latter (assumed from the fact that granite overlies White Porphyry in the Boulder incline), would also intersect the plane of the latter at the angle given in the section. Beyond Weston fault the upward roll in the beds at the Great Hope mine is graphically shown, and the syncline included between this ridge and the crest of Yankee Hill. The section line passes north of the summit of this hill, and beyond this point shows the increasing thickness of the Wash or moraine material left by the Evans glacier. Its intersection with the Iron fault is at the northern extremity of that fault, whose movement is deduced from data furnished by the Little Stella and J. B. Grant shafts, on either side. Beyond this it passes through the Little Stray Horse syncline, the anticline in the Dunkin ground, and the syncline on the north side of Fryer Hill. The relative thinning out of the Blue Limestone on Fryer Hill, where it is entirely replaced by vein material, is to be remarked. This replacement, which is shown by a cross-

marking, is not indicated in the Blue Limestone in the basin of Little Stray Horse Park, not because there is any reason to suppose that it does not exist there, but simply because explorations have not proved its existence and in drawing sections the practice has been established of only indicating replacement where it has been actually proved. The steep slope given to the beds west of Fryer Hill, as they pass under the western syncline, is deduced from data obtained on the line of the next following section. It will be observed that the intersection of the line along which the White Porphyry cuts across the Blue Limestone is here farther east than in the preceding section, and that the eastern extent of the lower White Porphyry body is considerably greater is proved by actual development.

**Section D.**—Section D starts from the same point on the eastern edge of the map as the preceding, but follows a line slightly divergent from it, running due west. The planes of the two sections are so close together that it will be only necessary to mention the points in which the structure of the latter differs. In the South Evans anticline it shows the irregular intrusive sheet of porphyry at the base of the Blue Limestone, developed in the Last Chance shaft, and the lower sheet of White Porphyry, cutting up into the Lower Quartzite and splitting off a portion of it, as shown in the Hoosier Girl (G-44). The intersection with the Colorado Prince fault at an acute angle renders the representation of the western slope of the South Evans anticline somewhat less simple. Its line passes through the crest of Yankee Hill, showing the replacement of the Blue Limestone in the Greenwood and Little Champion shafts, and, on the eastern rim of the Little Stray Horse syncline, the steep dip of the contact which is developed in the Scooper shaft. At Fryer Hill it passes along the bed of Little Stray Horse gulch, showing that the Blue Limestone horizon has there been eroded off. It likewise passes through the Bob Ingersoll shaft, and shows the steep dip theoretically required on the western slope of the anticline by the development of this shaft.

**Section E.**—Section E runs due east and west along the parallel of latitude  $39^{\circ} 15'$ , which forms the middle of the map, and is but a comparatively short distance south of the line of the two previous sections. On the

eastern end it shows the Mosquito fault and a patch of Lower Quartzite left to the east of it, on the slope of West Dyer Mountain. In the block between Mosquito and Ball Mountain faults the easterly dip prevails; but in the neighborhood of the latter fault the influence of the anticline at the north foot of Ball Mountain is seen in a slight curvature of the beds. Between Ball Mountain and Weston faults the Colorado Prince fault cuts through the southern extension of the South Evans anticline; and the section shows a minor anticlinal and synclinal structure between this and the Weston fault, which is shown by the developments of the Highland Chief and Lowland Chief shafts and the Chemung tunnel. Replacement in the Highland Chief mine is supposed to have extended through the entire thickness of the Blue Limestone horizon and to have been influenced by the dike of Gray Porphyry which is shown in that mine. The recent formation (*r*) east of the Highland Chief mine is a portion of the moraine left by the South Evans glacier on the shoulder now called Idaho Park.

In the block west of Weston fault the shallow anticlinal and synclinal structure developed in the two previous sections is supposed to extend into the plane of this section, the underground data confirming this idea as far as they go. The plane of the section is very nearly coincident with the line of the Breece cross-fault, which, however, in its curves crosses it at an extremely acute angle. The projection of the intersection of these two planes, as shown on the section, is a line cutting the surface between the Breece Iron and Louisville shafts, which has a certain parallelism with the formation lines, with which it might be confounded. The plane of the section passes just north of the extremity of the Mike fault, whose movement is therefore not shown. The body of Adelaide Porphyry is represented as coming up across the Lower Quartzite and White Limestone, and then spreading out, sending an offshoot between the beds of the latter. At this point the plane of the section crosses the moraine ridge, north of Adelaide Park, forming a portion of the Evans south moraine. In the block between Iron and Carbonate faults the line of section illustrates plainly the synclinal structure and the splitting of the Blue Limestone into two sheets, as proved in the Cyclops, Gone-Aboard, and adjoining shafts. On the west slope of Carbonate Hill the section passes through the

upper Henriett workings and the lower workings of the Waterloo claim, and shows the anticlinal axis, which very nearly corresponds with the Carbonate fault, in the latter. This axis, as already stated, is found to coincide with the line of the fault farther north; and it is possible that on the line of the section the fault movement may have already died out, since its actual plane has not been proved.<sup>1</sup> Of the synclinal basin under Leadville in the line of this section the depth and angle of the formations on its eastern rim are deduced from actual data, which are not, it is true, as complete as could be wished. The location of the western rim, however, is more theoretical.

**Section F.**—Section F, on a slightly broken line, passes through the crest of East Ball and Ball Mountains, from the latter across the slope of Breece Hill to the head of Nugget gulch, through the middle of Iron Hill, and along the bed of California gulch, into the mesa country. East of the Mosquito fault it shows a patch of Lower Quartzite left on the crest of East Ball Mountain. Between Mosquito fault and Ball Mountain fault it shows the development of White Porphyry in the lower horizons and its comparative absence above the Blue Limestone; between the converging Ball Mountain and Weston faults, the great development of Pyritiferous Porphyry and the probable continuation of the numerous sheets of White Porphyry in the lower horizons. The anticlinal structure shown in the eastern portion of this block represents the supposed influence of the anticline observed at the north base of Ball Mountain, which, owing to the curvature of the line of Ball Mountain fault, is the proper continuation of this portion of the area. The distribution and thickness of the numerous bodies of porphyry in the latter block are deduced mainly from the data obtained in the adjoining regions, since along the actual plane of the section, as will be evident from its examination, there are few data obtained from underground workings. In the next block, between Weston and Pilot faults, a body of Pyritiferous Porphyry is shown in section, whose thickness is largely a matter of conjecture, the only direct evidence being that of the Cumberland shaft, near its northern edge, where it is 450 feet. As the plane of the section probably cuts through the thickest portion of the body, the thickness of

<sup>1</sup> Later developments render it probable that the sheet of Gray Porphyry is in the Blue Limestone, above the line of Carbonate fault, instead of at its base, as shown in the section.

600 feet given must be considered a conservative estimate. The underlying White Porphyry is shown as disappearing in the middle of this body, since the latter is supposed to connect with the lower body in California, as shown in Section L. A slight anticlinal structure is shown in the sedimentary beds beneath the porphyry, as a probable connection between the Great Hope anticline on the north and that under Printer Boy Hill on the south. The block between Pilot and Mike faults, it is seen, is practically a wedge-shaped mass which has slipped down between the two faults. In this area is the intersection of the line of cross-cutting White Porphyry, which is therefore indicated here as spreading out under the Blue Limestone. On Iron Hill the line of section passes through the workings of the Iron mine; and the data down to the horizon of the Blue Limestone are derived from actual exploration. The transverse body of Gray Porphyry developed in these workings is supposed to be an offshoot from the intrusive sheet at the base of the Blue Limestone; it should not have been represented as actually projecting into the White Porphyry.

West of the Iron fault the section crosses what is probably the greatest thickness of White Porphyry left above the Blue Limestone, but the depth of the latter immediately adjoining the fault is, as already stated, purely theoretical and given as a probable maximum.

**Section G.**—Section G follows also a slightly broken line along the south slope of Ball Mountain, through Green Mountain and the head of California gulch, and then along the northern edge of Dome Ridge. At its eastern end it crosses diagonally the South Dyer fault. Between Mosquito and Ball Mountain faults the development of White Porphyry in the lower horizons is even more striking than in the preceding section. Between Ball Mountain and Weston fault the distribution of the porphyry bodies is similar to that in the preceding section, but the Pyritiferous Porphyry is supposed to be thinning out to the southward.

Between Weston and Pilot faults the section shows a probable vent of the lower body of Pyritiferous Porphyry, which is known to cut across the strata, and probably comes through the Archean in this vicinity. In the wedge-shaped mass between Pilot and Mike faults a sheet of Pyritiferous Porphyry is supposed to extend between the White and Blue Lime-

stones, as a continuation of the lower sheet of Pyritiferous Porphyry which forms the bed of California gulch above the Pilot fault. West of Mike fault the contact has been carried back at the angle shown in the developments of the Oro La Plata mine, and the intrusive body of Gray Porphyry, which cuts across it at the mouth of the Oro La Plata tunnel, is represented as probably thinning out to the eastward. It is possible, however, that the contact basins up toward the Mike fault, as it does on Iron Hill and the Gray Porphyry sheet may have an underground connection with the Printer Boy Porphyry, which it somewhat resembles, and both come up through the same channel or vent. West of the Dome fault the westward slope of the beds in the lifted-up block of ground between the Robert Emmet and Iron faults is shown. Beyond the Iron fault the only data obtained from shafts are the relative positions of the Wash, Lake beds, and underlying porphyry.

**Section H.**—Section II is taken along a straight line running from the bed of Iowa gulch, on the eastern border of the map, through Printer Boy Hill and down the bed of Georgia gulch. The three eastern blocks do not differ sensibly from those of the preceding section, except that, as proved by actual developments on Printer Boy Hill, the White Porphyry above the Blue Limestone is exceedingly thick, for which reason its thickness in the adjoining block to the eastward is proportionally increased over that of Section G. The cross-cutting of the White Porphyry comes just west of the Weston fault, and, though entirely below the surface, is not wholly theoretical here, but proved by developments of adjoining mines. The anticlinal structure of Printer Boy Hill, the intrusive sheets of porphyry, and the three vertical dikes are also proved by actual observation. The convergence of the planes of the Mike and Pilot faults is a theoretical deduction founded on the theory of fault planes by observers in other parts of the world. The existence of Lake beds at this height is proved by the data afforded by the explorations of the Printer Boy mine. The depth shown for the Blue Limestone here may possibly be too great, since it is obtained by carrying back the angle of dip at the surface near the Dome fault, and it is very possible that the beds turn upwards towards the Mike and Pilot faults, under the influence of the Printer Boy anticline. The thickness of

Lake beds below Dome fault and the depth of the contact are derived from actual data as far west as the Coon Valley; beyond that they are theoretical deductions.

**Section I.**—Section I is a broken line following, as near as may be, the crest of Long and Derry Ridge from West Sheridan Mountain westward. It shows the beds left on the crest of West Sheridan; the anticlinal structure developed on Long and Derry Hill, between Mosquito and Weston faults; the uplifted block of ground between Weston and Union faults; the outcrop of Blue Limestone and general character of its replacement in the Long and Derry mines and the great thickness of the White Porphyry above it (the cross-cutting of the lower sheet of White Porphyry must have occurred in the part eroded off); the transverse dikes of Gray Porphyry, and the intrusive sheets of Green Porphyry between the White Limestone and Lower Quartzite; and, west of Mike fault, the outcrops of the Blue Limestone shown in the Hoodoo and Echo shafts, and the supposed form of the body of Josephine Porphyry, between it and the overlying White Porphyry. The depth assigned the contact adjoining the Mike fault may be too great, as in the previous section, since it is possible that the beds rise toward an anticlinal fold. In the actual plane of the section the Lake beds are not shown to reach as high up as they do on Section H; but their extent on a line immediately north and south of this plane would be equal to that of the former. West of the Hoodoo outcrop is indicated the anticline which forms the southern continuation of the Dome fault, beyond which a syncline must exist, as an extension of the synclinal basin proved, to the north; but what portion of the synclinal beds involved in these folds has escaped erosion is a matter of pure speculation.

Perhaps the most suggestive teaching afforded by the north-and-south sections is the graphic representation they give of the relative character and amount of Glacial and Post-Glacial erosion. They afford successive cross-sections of the various spurs represented on the map from the summit down to the mesa below. Where Lake beds still exist, the rock surface below them is the result of erosion in the earlier portion of the Glacial period. The rock surface beneath the moraine material (*r*), whether in its original ridges or rearranged, is probably practically the same as it was at the close



of the Glacial epoch, while the sky-line of each section represents the final form which water has given to the surface left at the close of the Glacial epoch, whether it be rock or detritus.

**Section J.**—In Section J, which crosses Prospect Mountain ridge, the lower portion of Little Ellen Hill, Ball Mountain, and upper Long and Derry Ridge, are seen the main depressions made by the Evans, South Evans, and Iowa glaciers, the outlines of their beds somewhat rounded off by Post-Glacial erosion. The formations are seen to have three broad undulations rather than folds, the two southern of which are broken by faults.

**Section K.**—In Section K, which passes through Prospect Mountain, Breece Hill, the head of California gulch, and Long and Derry Hill, the two Evans glaciers had come together in one broad sheet of ice a mile in width and not less than six hundred feet in thickness. Of the moraine material still remaining here, a portion evidently belongs to the lateral moraines, and in the middle is left a relic of the medial moraine formed by the junction of the two glaciers. In Iowa gulch at this point, as evidenced by the moraine material remaining on Printer Boy Hill, the Iowa glacier was also about six hundred feet thick and possibly sent a small branch some distance into the head of California gulch. The folds have the same character as in the previous section, but their crests are farther north.

**Section L.**—In Section L, which passes through the lower portion of Breece Hill and the west slope of Printer Boy Hill, the bed of the Evans glacier retains about the same size as in the preceding section, although its outlines are somewhat more regular. The Iowa glacier, confined on the north by Printer Boy Hill, had spread out somewhat to the south, leaving its moraine material well on the crest of Long and Derry Ridge. California gulch has been cut in the crest of one of the folds mentioned above, and in it the lower sheet of Pyritiferous Porphyry is seen to be cutting across the formations.

**Section M.**—Section M, passing through the crest of Yankee Hill and just east of Iron Hill, shows the Evans glacier split again into two streams, having a total width of over eight thousand feet, but whose thickness is

probably somewhat diminished. The Iowa glacier, on the other hand, seems to be contracting as it descends, and in the plane of this section the distance between the crests of its bounding moraine ridges is only a little over one thousand feet. Here the outline of the Lake beds shows a bay in the ancient lake Arkansas and that the older Iowa glacier occupied a wider bed than the later one. Except at the foot of the Prospect Mountain, the beds lie in an almost horizontal position.

**Section N.**—In Section N the teaching of the Lake beds is still more suggestive. The moraine material of the Evans glacier, which was probably again united into one sheet, is spread out over a still wider surface; while the reconstructed outline of the Arkansas lake shows that from Graham Park across to Georgia gulch a ridge then extended, through which the present bed of California gulch has been carved out since the Glacial epoch.

**Section O.**—In Section O, which runs through Fryer and Carbonate Hills, only the top of the latter and a portion of what is now California gulch probably remained above water during the Glacial epoch.

**Section P.**—In Section P, which runs across the mesa country, Lake beds and Wash cover the whole surface as far as the ridge north of the mouth of the Arkansas. The underlying beds are represented as lying in a single broad syncline, since, while there may probably be minor undulations, as in the sections above, there naturally can be no data for determining their position.

As regards underground structure the transverse sections are mainly useful as showing probable depths at which the ore-bearing horizon may be found. They are too nearly parallel to the direction of major strike, which is that of the majority of the folds, to give a correct idea of these folds; and their intersection with fault planes, being also at an acute angle, presents a somewhat distorted angle of dip. Still it may be observed that on these north and south lines the beds have a tendency to form anticlinal and synclinal folds. Bearing in mind that the prevailing direction of strike is in a northwest direction, the continuation of the folds will be found a little farther to the north in each successive section; for instance, in Section J the fold under Ball Mountain finds its normal continuation in Section K at

the mouth of South Evans gulch, and in Section L joins the slight fold at the south face of Prospect Mountain. The form of the east-and-west folds, as shown in Sections L, M, and N, along the base of Prospect Mountain, suggests that the mass of Prospect Mountain afforded more resistance to compression than the adjoining country to the south, so that the folds are compressed sharply up against it. The reason of this may be found perhaps in the unusual thickness of the porphyry bodies on Prospect Mountain, which are probably much less plastic than the sedimentary beds.

## CHAPTER VI.

### DISCUSSION OF GEOLOGICAL PHENOMENA.

In the last two chapters the observations gathered have been presented in the form which it was supposed would be most useful to the geologist or miner who wished to study the region itself. For those who have no occasion to examine the actual ground, it may be well to present concisely and in a generalized form some of the more suggestive facts observed, in a geological rather than topographical order, which will be the object of the following pages.

#### SEDIMENTARY ROCKS.

*Archean.*—That Archean land masses must have existed during the deposition of the Paleozoic and Mesozoic beds found in this region is abundantly proved, aside from all structural evidences, by the occurrence at various horizons, in beds evidently of littoral formation, of rolled grains and pebbles of Archean rocks. Among these grains and pebbles that which would best resist abrasion, quartz, forms naturally the larger proportion, but granite and even gneiss are found, and, among the finer materials, feldspar and mica often form a large proportion of the sandstones. It is further noteworthy that these pebbles do not differ in character from the present Archean rocks; in other words, afford no evidence that the latter have been changed by metamorphism since the Cambrian epoch. The fact that only at one point, and this close to a supposed shore line, is any but the characteristically lowest bed of the Cambrian found in contact with the Archean, shows that the upper surface of the latter, or the bed of the Cambrian ocean,

must have been comparatively smooth and have presented no abrupt cliffs or slopes which were too steep for a uniform deposition of sediment over them.

Bedding planes were frequently observed in the Archean in proximity to its upper surface, perfectly parallel with and corresponding to the bedding planes of the Cambrian quartzite immediately above it. As this distinctness of bedding planes occurs in granite as well as in gneiss and as in general the bedding planes of the Archean, as seen on a large scale, are almost invariably discordant with those of the overlying beds, it seems that they must have been produced by the pressure of the superincumbent mass of beds.

The eruptive granite of this region is, in all cases, pre-Cambrian in age, no instance having been observed of its intrusion into the rocks of any formation later than the Archean.

As regards the relative age of the rocks which form the Archean, the little study that could be devoted to this subject goes to show that the amphibolites, gneisses, granite-gneisses, and, probably, part of the granites proper constituted the older or original formation; that these were succeeded by the distinctly eruptive granites, which cut through and include fragments of the above; and that the vein-like masses of pegmatite are the most recent formations of all the Archean rock masses.

While the structure lines which give evidence of original bedding or stratification in these rocks are less distinctly marked than in other parts of the Archean of the Rocky Mountains and were often so obscure that no attempts were made to trace out any structural system in the Archean as a whole, they are nevertheless sufficiently well marked to suggest an original horizontality in the different layers, and that they have been subjected to an infinitely greater compression and folding than the later formations, while the parallelism of certain upper planes with the lower ones of the Cambrian, which has been remarked above, and the varying angle at which both are found, show that the Archean has partaken of the folding to which the Cambrian and later beds have been subjected.

*Paleozoic.*—The lower 600 feet of the Paleozoic system in this region, comprising the Cambrian, Silurian, and Lower Carboniferous formations,

which are remarkably persistent as a whole, though varying from point to point in the relative proportions of calcareous and silicious material entering into their composition, give evidence, in their even and thin beds and in their fineness of grain, of a slow and uniform deposition in quiet and rather deep waters. Even in the conglomerate, which is invariably found at the base of the series, only very small pebbles of the very hardest and most tenacious forms of quartz are found. Neither fragments of Archean rocks nor even feldspar fragments occur in them. The lower calcareous beds also, in spite of their dolomitic character, are usually compact and fine grained.

In the middle member of the Carboniferous, however, a decided change in the character of the sediments takes place: they become, as a rule, very coarse-grained, carry feldspar and mica and rolled pebbles of granite and schist; they often contain carbonaceous matter, which is sometimes concentrated into actual beds of coal along the borders of the original land mass, and remains of plants peculiar to the Carboniferous period are found in them at a considerable distance from the supposed shore line. It is evident, therefore, that in the middle Carboniferous epoch the seas became shallower, that the abrasion of the land masses was more rapid than theretofore, and that on the land vegetation flourished luxuriantly in this mountain region, as it did at the same period in other parts of the world.

During the succeeding Upper Carboniferous epoch and also in the Mesozoic era the same coarser character of sediments prevails, although carbonaceous deposits are wanting until towards the close of the Cretaceous. Both in the Weber Grits and the Upper Coal Measure formations the calcareous deposits are not only very subordinate in quantity but very variable; at one point in a given thickness of rocks only a single thin bed of dolomitic limestone will be found, whereas within the same horizon, at another point not very far removed, several may occur.

**Dolomitic sediments.**—One of the most noteworthy facts developed by the study of the sediments of this region is the prevalence of dolomites among the calcareous deposits. All the calcareous beds below the Robinson limestone, which was taken as the base of the Upper Coal Measures, are, with the unimportant exception of a locally developed silicious limestone in the Cambrian, true dolomites of varying purity. In the hand specimen they have

generally the granular structure characteristic of dolomites, and under the microscope it is seen that there is little or none of the twin structure peculiar to calcite, and that they are therefore composed, not of a mixture of calcite and carbonate of magnesia, but of true dolomite or double carbonate of lime and magnesia. The upper bed of the Robinson limestone, on the other hand, and also the few limestones of the Upper Coal Measure formation that were examined are true limestones and have a characteristically different appearance from the dolomites in the hand specimen. They are fine grained and compact, instead of granular, generally of light color, and often have the conchoidal fracture and fine texture of a lithographic stone. The lime and magnesia contents of twenty different specimens of limestones from different horizons and localities are given in Table VI, Appendix B.

It is also noteworthy that all of these limestones, as far as tested, were found to contain chlorine in appreciable amount. Microscopical examination of the Blue Limestone collected at Leadville, whose contents in chlorine amounted to one-tenth of one per cent., showed that it probably occurs in the form of a solution of chloride of sodium, in extremely minute fluid inclusions within the grains.

These investigations were made in the hope that they might throw some light upon the cause and manner of formation of dolomites in general. It can only be said that it seems evident that the magnesia is an original constituent of the rocks, and not introduced later by metamorphic action. It were difficult to conceive of such an action, for instance, in the case of the Robinson Limestone, the upper fifteen to twenty feet of which are almost chemically pure carbonate of lime, while the lower ten feet contain less than 88 per cent. of carbonate of lime, the rest being carbonate of magnesia and insoluble material; or how such metamorphic action should be so widespread and uniform over this great area and yet stop at a given bed or horizon.

T. Sterry Hunt,<sup>1</sup> who, with others, has advocated the theory that dolomites are formed by the actual precipitation of the carbonate of magnesia, maintains that its separation requires the absence of chloride of calcium

---

<sup>1</sup> Chemical and Geological Essays, Boston, 1875, p. 92.

from the waters in which it is deposited and that isolated or evaporating basins are indispensable conditions of the formation of dolomite. In this particular region these conditions might have been fulfilled, since the Archean land masses certainly inclosed the sea on two sides. His theory requires, however, that all the lime contained in the sea waters should have first been precipitated by the carbonate of soda, which would then act on the chloride of magnesium and throw it down as carbonate. It would seem, however, from the character of the rocks, which are formed of crystalline grains of the double carbonate, that the two salts were probably precipitated at the same time and that a certain amount of chloride in solution was inclosed in the grains as they crystallized.

As regards the question whether carbonate of lime is more readily dissolved out of a dolomite than carbonate of magnesia, the evidence goes to show that percolating waters act upon the double salt, and not upon its more soluble member alone, since the veins and cavities, such as are shown in the lower specimen on Plate VI (p. 64), which have been refilled by white crystalline material deposited by these waters, are found to have the same composition as the original dolomite. Moreover, where the entire rock has been apparently changed by the action of waters, as in the so-called "lime sand" found in the mines, which is Blue Limestone from which the cementing material of the grains has been removed, or in the case of a given bed in the White Limestone of Dyer Mountain, which in one part has, by this action, from a compact light-blue rock, become clayey in structure and pink in color, analysis shows that the proportions of carbonate of lime and magnesia remain essentially unchanged, whatever variation there may have been in the other constituents.<sup>1</sup>

In both the above cases the metamorphism, or change in the character of the limestone, must have taken place about the time of the deposition of the ore bodies in these regions, and would therefore not have been produced by surface waters. The action of surface waters, using this term in its ordinary, restricted sense of waters which come from the surface under essentially the same conditions that exist at the present day, is apparently different from the above, judging from the following observation.

---

<sup>1</sup> See Analyses 5, 6, 9, and 10. Table VI, Appendix B.



The conglomerates which form the Lake-bed deposits are often found to have a calcareous cement, that can be readily separated from the pebbles which it incloses. This conglomerate is of so recent date that at the time of its formation the structural conditions of the range must have been essentially those which prevail at the present day, and the waters from which the cementing material was derived were surface waters, which may be supposed to have drawn their calcareous constituents from the outcrops of the various dolomitic beds of the lower Paleozoic series. Chemical tests show that the cement is made up almost entirely of carbonate of lime, with little or no carbonate of magnesia. It would seem, therefore, that when exposed to the action of surface waters the dolomites of this region have yielded up their carbonate of lime more readily than their carbonate of magnesia. This may be due to a previous disintegration under the action of atmospheric agents which rendered them more attackable or to a superior solvent power of surface waters over underground waters in their action upon the carbonate of lime.

**Serpentine.**—The development of serpentine in the Silurian beds of this region is, it is believed, the first observed instance of its occurrence in the Rocky Mountain region, and therefore deserves some detailed mention. Its principal point of development is in the Red amphitheater in Buckskin gulch, on the south face of Mount Bross, where it is found mainly in the transition beds at the base of the Silurian formation, though extending to a limited extent up as far as the base of the Carboniferous. It was also observed in limited development on the cliffs at the south base of Mount Lincoln, and specimens were obtained in the Leadville district from the Comstock tunnel in California gulch, where its exact horizon could not be definitely determined. No actual serpentine was found at any other point, but a greenish-colored bed was observed frequently at about the same horizon, which by a microscopical examination of certain specimens was proved to contain amphibole or pyroxene.

As developed in the Red amphitheater, it occurs generally in limestone, forming a greenish, veined, and clouded rock, like verd-antique, the veins or streaks of serpentine generally running parallel with the stratification, but sometimes crossing it at right angles. It also occurs in a yellow, homo-

geneous-looking rock, resembling yellow beeswax, which proves by analysis to be an intimate mixture of calcite and serpentine. A complete analysis of the soft green material from a specimen of the darker-colored rock is given in Analysis I, Table VII, Appendix B, which proves it to be an almost normal serpentine, the oxygen ratio being 3 : 3.95 : 2.11, instead of 3 : 4 : 2, which is the theoretical proportion. Analysis II, in the same table, is that of the whole mass of yellow rock, which is found to contain 57.57 per cent. of carbonate of lime. If this be deducted, the composition of the residue is essentially the same as that of I. The microscope confirms the conclusion that the rock is a simple mixture of serpentine and calcite, as no other mineral can be distinguished by it. It also shows that the major part of the rock is in grains which show the cleavage distinctly, whereas the small grains of calcite which are sometimes found in the dolomites show no such cleavage lines; hence it is evident that the calcite has been recrystallized.

*Origin of the serpentine.*—It is evident, from the manner of its occurrence in and intimate admixture with the sedimentary rocks, that the serpentine is not of eruptive origin. It seems equally improbable, from its extremely local development, that it could have been formed at the time of the precipitation and deposition of the original sediments. It is noteworthy, further, that the localities where it was found have been near centers of eruptive action and of consequent intense metamorphism. The dolomites of this horizon, which are all more or less silicious, contain all the constituent elements of serpentine, except water. If by the addition of this element a reaction between it and the silica and magnesia could be brought about, serpentine might have been formed directly from the dolomites. As, however, it is difficult to conceive of such a direct reaction, it seems better to seek some intermediate step. Among the specimens of serpentinous rock from the Red amphitheater, one has gray portions, comparatively free from serpentine, in which fibrous silky crystals can be observed. The microscope showed that these are amphibole crystals, and, further, that pyroxene was present. Analysis III, Table VII, shows the composition of these silky crystals after they had been separated from the rest of the mass, which is practically that of actinolite. The part supposed to be pyroxene, which is distinguishable as being less lustrous, was not analyzed. Now, the for-

mation of serpentine as an alteration product of amphibole and pyroxene has been not unfrequently observed and actual pseudomorphs have been found.<sup>1</sup> It thus appears evident that a part at least of the serpentine in these rocks is an alteration product of amphibole and pyroxene, and in further confirmation of this hypothesis the microscope shows, in specimens of a green silicious rock from the lower part of the Red amphitheater and of a similar rock from the south base of Mount Lincoln, among fresh and unmistakable amphibole crystals, some in process of decomposition, whose end product is serpentine, the remaining components of the rock being quartz grains and calcite in alternate layers.

J. D. Dana,<sup>2</sup> in treating of similar occurrences of serpentine in the dolomitic limestones of Southern New York, supposes that the process of change was that by a first metamorphism the uncrystallized dolomite became penetrated with tremolite, actinolite, and other magnesian silicates, and that "these beds underwent a later transformation, converting the tremolite and other magnesian silicates and part of the remaining dolomite into hydrous magnesian silicates and mostly into serpentine." At first glance the Mosquito Range phenomena seem to present a further analogy with those of Southern New York in that there are presented two periods of possible metamorphism (or activity of metamorphic action), viz, that following the intrusion of the porphyries and diorites and that following the folding and faulting which accompanied the uplift of the range. There is, however, no evidence that the dynamic movement was either accompanied or directly followed by any widespread metamorphic action. The decomposition of metallic minerals, which was a metamorphic action, preceded this movement and followed the eruption of porphyries.

As to whether the serpentine has been derived entirely from amphibole and pyroxene, or whether a part may have been derived directly from dolomite, as suggested by Dana in regard to the New York occurrence, no definitely conclusive evidence has been obtained. No opportunity was offered for tracing the yellow rock, which would seem probably to have

<sup>1</sup>J. Roth: *Allgem. u. chem. Geologie*, pp. 123, 127, 131. Berlin, 1879. A. Lagorio: *Mic. Anal. Ostbaltischer Gebirgsarten*, p. 43. R. B. Hare: "Die Serpentin-Masse von Reichenstein" (*Neues Jahrbuch*, II. Bd., p. 346. 1880.)

<sup>2</sup>*American Journal of Science*, Vol. XX, p. 32. July, 1880.

been derived from a limestone bed relatively free from quartz, to a less completely altered condition, where it might have been seen whether there had been a previous formation of amphibole. In the dark-green rock, however, there seems little doubt that the serpentines are derived from silicates.

With regard to the formation of amphibole and pyroxene, their distribution seems wider and more even, and the question presents itself whether they have been formed in situ by a slow process of metamorphism preceding the appearance of the eruptive rocks, or after this period and immediately preceding that of the serpentine, or, again, whether they are simply derived from the Archean rocks mechanically. In favor of the last supposition is the fact, observed by Mr. Cross in one specimen, that the amphibole penetrates the quartz grains and is sometimes entirely encircled in them, and that these latter contain fluid inclusions with moving bubble.

#### STRUCTURAL FEATURES.

The most striking features in the geological structure of this region are the forms of the folds and the close relation between them and the great faults which traverse it from north to south.

*Folds and faults.*—The typical form of the former is what has been called the **S**-fold, in which the anticline has a steep and almost vertical face to the west, or towards the original land mass of the Sawatch, and a gentle slope to the east, while in the adjoining syncline the conditions are reversed, and the gently rising slope is to the west. This is the most natural form of fold which would result from the supposed cause of uplift of the range, namely, a horizontal thrust of the beds against the Archean mass of the Sawatch. In a fold produced in this way the line of greatest tension, and where the tendency to fracturing and displacement would be greatest, is, as shown by Daubrée's well-known experiments,<sup>1</sup> along this steep side of the fold, and in point of fact it was found that along this line occur the great strike-faults of the range.

By reference to the sheets of sections (Atlas Sheets VIII and IX) it will be seen that the great Mosquito fault, which extends for an unknown distance beyond the northern limits of the map, and its two southern branches, the London and Weston faults, fulfill in the main these theoretical conditions.

---

<sup>1</sup>A. Daubrée: *Géologie Expérimentale*, p. 321. Paris, 1879.

It is rarely possible to trace upon the surface the actual line of a fault or the structure lines of the immediately adjoining beds, for the reason that the rocks are generally metamorphosed and disintegrated to such an extent as to render them obscure. The theoretical studies of fault structure have, moreover, been mainly made in underground workings, especially in coal mines, where it is often the case that the movement of displacement is so slight and the thickness of beds involved so small that it is questionable whether they should not more properly be considered as joints, rather than as fulfilling the same conditions as these great faults many miles in length and with displacements involving thicknesses of beds of as many thousand feet. Even in this region, where the opportunities for observation are exceptionally favorable, the actual fault planes and the structure lines of the adjoining beds can but rarely be distinguished. Either only Archean rocks, in which no structure lines are visible, are to be found on one side of the fault, or the surface conditions are such that the structure lines are entirely obscured in its vicinity. In drawing the sections, moreover, the endeavor was to represent the facts as far as observed, without reference to any structural theory, and they were already engraved before any theoretical study of the structure as a whole was undertaken. If, then, in any case they misrepresent facts, the error is as likely to be against the above theory as in its favor.

At the northern edge of the map a syncline is plainly traceable in close contact with the fault line on the west of the Mosquito fault, and the remains of the corresponding anticline on its east side are found in the fragment of Cambrian quartzite resting on the Archean just beyond the limits of the map. From here southward to Empire gulch either the Archean alone adjoins the fault line or the stratification lines of the sedimentary beds in its immediate vicinity are entirely obscured; those given in the sections are only the theoretical prolongation of dips observed at such a distance that there is room for a very marked flexing to have occurred before they reached the fault plane. On Empire Hill is what might be classed as a monocline to the west of the fault, were it not that its continuation farther south at Weston's pass shows that it is part of a deep syncline, cut off by the fault, and a portion of

the crest of the corresponding anticline on the east side still caps Weston's Peak. It is in the London fault, however, that the relations of the fold and the fault are most clearly seen, because the sedimentary beds still remain on either side to show the structure lines and erosion has cut down into the rock mass so deeply as to afford to the observer actual sections of the earth's crust several miles in length and one to two thousand feet in thickness. These have been described in detail on pages 143-165 and illustrated by sketches in Plates XV, XVI, and XVII, so that it will be hardly worth while to redescribe all the conditions here.

It is probable that the steepness of the angle of dip of the beds on either side of the fault plane in these cases may be due to a continuation of the movement of contraction, or the lateral thrust, since the original faulting and folding, for it is now generally conceded by geologists that the elevation of mountains is continued in a somewhat modified form long after the original dynamic movement, and may very probably be going on at the present day. In the case of the fold at Weston's pass a lateral movement along the fault plane seems also necessary to explain the observed conditions.

This dipping downward of the beds on either side of the fault would seem at first sight to be an exception to what is given in text-books as the rule for the plication of beds adjoining a fault plane, namely, that they bend in opposite directions down toward the fault on one side and up toward it on the other. It is not really so, however, as mature reflection will show. In the case presented by the text-books of strata dipping in opposite directions on either side of the fault, if the beds were brought back to the position they occupied before the displacement, they would be found to have a simple monoclinical fold, such as is described as common in the Colorado Plateau region by the geologists who have written upon it, and which, according to them, is often associated with a fault. These folds and faults differ from those in the greater intensity of the plication and in the different position of the fault plane in regard to the flexure. If one of the S-folds described here could be drawn back to its incipient state of flexure and the strata adjoining it brought to an approximately horizontal position, it would gradually become the monoclinical flexure described by them; or

one might imagine the monoclinial flexure under conditions of greater pressure, and with a general uptilting of the whole sedimentary series involved, developing into one of these **S**-folds. As regards the position of the fault plane, in the supposed case of the monocline it actually cuts the steep side; but here it cuts generally through the syncline on one side of it. It can readily be seen by reference to the section that a comparatively slight lateral displacement of the fault planes to one side or the other would produce the above-quoted conditions of an opposite dip on either side of the fault, or, to be more accurate, opposite as regards the fault plane, since the actual dip is the same on both sides of the fault in the case of the monoclinial fault and reversed in the case described here.

In connection with the shorter and less important faults which traverse the region of the Leadville map, the folds are much more gentle and less strongly marked than in the case of these larger faults; but in almost every case where it is possible to obtain data it is found that the same interdependence of folding and faulting exists.

**Hade of faults.**—In the few instances where it was possible to obtain actual measurements of the hade of the fault planes, or their inclination from the vertical, it was found to be towards the downthrow side, or that the plane of the fault slopes away from the side which has risen; this is the condition which generally prevails, and it is explained on the theory that the uplifted side has thus a broader base than the downthrow side. In only a few isolated cases was evidence found, and only indirect evidence at that, of the opposite conditions, or of a reversed fault. The angle of hade in the observed cases was almost equal to the angle of dip of the strata; in other words, the fracture was directly across the beds. In drawing the faults where the angle could not be observed, as was the case in the majority of instances, they were constructed to accord with this condition. The objection has been made to the assumption that the normal hade of faults should be in the direction of downthrow, that it is opposed to the theory that faulting, like folding, is the result of contraction, inasmuch as hading in this direction tends to lengthen the linear space occupied by a series of beds on a given cross-section, rather than to contract it. This may be graphically seen in the sections on Atlas Sheet VIII. In Section A, for instance, where

only one fault crosses the section, the linear contraction of a given bed, as there drawn, is about three thousand feet in the length of the section, or  $3\frac{1}{2}$  per cent. On Section D the apparent amount of contraction is the same, although the beds are much more sharply flexed; but it is found that, by reason of the angle of hade given to the faults, there has been 1,500 feet of apparent expansion of the beds; or, if the fault planes had been made vertical, the same amount of flexing would have given 1,500 feet more length to the beds and the contraction would have been 4,500 feet, or  $5\frac{1}{2}$  per cent. The sections present probably an exaggerated statement of what actually exists, for it is possible and even probable that the planes of the great faults stand more nearly in a vertical position; still, observation renders it probable that the average hade in the faults of this range is with the downthrow, and for this reason the displacement of the faults has not tended to contract the linear distance occupied by a given series of formations on a transverse line, but rather to expand it slightly. It seems probable that the plication of the beds has been a gradual and uniform movement, though relatively accelerated at the period assigned to the dynamic movements; but that the actual fracturing of the beds along the present fault planes was primarily produced by some violent shock, similar to the earthquake shocks of the present day; that the direction of a fracture plane across the beds, as thus primarily determined, would not necessarily be dependent on the force of contraction, although its position would naturally be on lines of greatest tension or weakness.

It may also be conceived in a region like the one under consideration that, while the folding is evidently a result of tangential contraction, the faulting may be, in part at least, the result of radial contraction. It is probable that tangential pressure acts only on a comparatively thin shell of the upper crust of the earth, for very sharp folds, where observation in depth is possible, are found to become gradually more rounded and gentle as the distance from the surface increases; also, that the force which has been exerted in an intensely plicated region is the expression of the accumulated energy of contraction over a wide area. Thus, in the case of the Mosquito range, tangential pressure may be conceived to have pushed up a roll of the earth's crust into a ridge, which would have been much higher



than the restoration of the eroded beds in their present position would give, if it had not been for the counteracting effect of faulting; and faulting might, in this sense, be considered a result of subsidence or of radial contraction. It is easily seen, for instance, by studying any one of the given cross-sections of the Mosquito range, that were the movements of the faults reversed, so as to bring the beds on either side of each back into their original position, and thus leave them as they would have been if influenced by plication alone, the range would have been about four thousand feet higher than at present, supposing erosion to have acted under those conditions with the same energy that it has under the present. This view of the elevation of the range involves, it is true, a subsidence of the region adjoining the Sawatch shore line and probably of the whole Sawatch mass. Subsidence and elevation in cases like this, which refer to a far distant period of the earth's history and where limited areas are involved, are more or less interchangeable terms, since the only fixed point to which they can be related is the center of the earth, whose distance cannot be determined with a possible error less than the amount of movement involved, and we have to content ourselves with the assumption that there must be a tendency in all movements of the earth's crust to preserve a certain equilibrium, and that, where one portion of the crust has been elevated in relation to an adjoining one, the apparent movement is probably the sum of an actual elevatory movement on the one side and of a subsiding movement on the other, each of which is necessarily less in amount than the apparent movement.

The same may be said of areas large enough to assume an almost continental importance. Thus the Plateau region of the Colorado River has evidently subsided relatively to the adjoining mountain areas of the Wasatch and of the Rocky Mountains, as shown by the great average difference of level of corresponding formations in these areas; but the Plateau region must always have been relatively lower than these, since it was from the abrasion of their land masses that its sediments were in large measure derived. It may, however, be considered in general to represent an area of subsidence, and the others to be areas of elevation; and the type structure which prevails there, namely, that of broad level blocks descend-

ing abruptly along given lines by monoclinical flexures and faults to lower levels, to be more frequently the result of subsidence, while the movements in the adjoining mountain masses were probably more often true movements of elevation.

The one-sided or S-shaped fold.—In the above remarks considerable stress has been laid upon the one-sided or S-fold and its frequently associated faulting, because it seems to be the extreme development of the most common form of plication throughout the Rocky Mountains and the region of the Great Basin. In the latter region it often happens that only one side of the fold protrudes above the Quaternary deposits, which cover the greater portion of its surface, so that the narrow mountain ridges present only a monoclinical slope. For this reason the structure of what is called the Basin province has been characterized as a region of faulted blocks uptilted in different directions and practically without plication.

I dissent from this reading of the geological structure, first, because my own observations in the region mentioned have shown many unmistakable instances of the above-mentioned structure, in which it is true the flexing is often gentle, but nevertheless a true plication, and which have led me to believe by analogy that in other cases, could the structure beneath the valleys be seen, the missing faulted-down members of the fold would be found; secondly, because the diversely tilted blocks which are given in the sections involve what seems to me to be a geological impossibility, or at least one which is not yet found possible by observation, namely, the actual annihilation of considerable wedge-shaped segments of stratified beds by the simple action of faulting. Even in the Uinta Range, which differs from the Rocky Mountain ranges in that it is the truncation of a complete arch of sedimentary strata, with no evident pre-existing elevation beneath it, the anticlinal fold has the one-sided structure. The axis of this range is along the northern edge of the uplift; to the south of the axis the beds descend in gentle slopes; to the north they dip steeply at angles of 40° or 50°, and are partly faulted along this steep side. On a line with this steep side, at the eastern end of the range, is a submerged ridge of Archean, whose resistance, as I have already suggested,<sup>1</sup> probably caused the sharper and more

---

<sup>1</sup> Exploration of the Fortieth Parallel, Vol. II, Descr. Geol., p. 201. Washington, 1877.

complete plication of the formations at that end of the range. This ridge may extend westward at a greater depth along the whole length of the range, and be the unyielding mass whose resistance caused the sharper flexure along its northern edge.

I also differ from the views advanced by some geologists with regard to the structure of the Rocky Mountain region, or the Park province, as they designate it. One considers the type structure of this region, as represented by the Colorado and Park Ranges, to be the same as that of the Uinta, viz, that the sedimentary strata formerly arched over them, and that the uplift was that of a broad platform raised by vertical movement, having a fault or monoclinical fold along either edge. Another, in speaking of the whole Cordilleran system east of the Sierra Nevada, says it has no plication properly speaking, as expressed by the folds of the Appalachian, although he admits that some regions show a certain amount of flexure, including in them probably the Basin and Park provinces. In regard to these provinces he says that these flexures are not, so far as can be discerned, associated with the building of the existing mountains in such a manner as to justify the inference that the flexing and the rearing of the ranges are correlatively associated; that the flexures were in the main older than the mountains, and that the mountains were blocked out by faults from a platform which had been plicated long before, and after the irregularities due to such pre-existing flexures had been nearly obliterated by erosion. He says further that the amount of bending caused by the uplifting of the ranges is just enough to give the range its general profile and seldom anything more.

I have already shown, in Chapter II, my reasons for considering that the main Archean masses of the Rocky Mountains, as represented by the Colorado and Park Ranges, were never submerged, and that therefore the sedimentary strata could not have arched over them as they did over the Uinta Range; also, that the Mosquito Range, which might be considered at first sight an exception, is not geologically part of the Park Range, but an uplift of later formation, contemporaneous with and of analogous formation to the so-called "Hog-back" ridges on the east flanks of the Rocky Mountains, though of more complicated structure, owing partly to its eruptive masses and

partly to a more intense movement of compression. On the eastern flanks of the mountains the anticline, east of the first monoclinical slope which rests directly on the Archean, is rarely seen, being concealed beneath later deposits. Its slopes are probably relatively gentle, as it is not compressed between two Archean masses like those of the Mosquito Range, but has a broad mountainless area at its back. Could this fold be seen it would probably be found to have the S character; that is, a steeper slope to the west. The fact that the monoclinical slopes on the eastern flanks are sometimes very steep I judge to be due to a later movement of contraction since the dynamic movement, by which the upper beds have been pushed against the Archean and the beds which rest directly on it, and thus brought into a vertical or even an inverted position.

As regards the correlation of folding and faulting, the geological evidence, as I read it, is entirely opposed to the idea that the uplift of the ranges was independent of and later than the flexing, and produced mainly by faulting. The evidence of the Mosquito Range, which may be fairly taken as a type, though perhaps an extreme one, of Rocky Mountain structure, certainly shows a close interdependence between folding and faulting. That the rocks forming the Archean land masses were plicated and eroded long before is quite evident, but that they were blocked out by faults and lifted into a platform is purely hypothetical and incapable of proof. Again, while the closely appressed folds of the Appalachians are rarely found in the Rocky Mountains, I consider the folding that does exist there none the less a true plication. The peculiarly regular, narrow folds of the Jura Mountains and of the Appalachian system are simply the extreme type of closely folded strata, due to peculiarly favorable conditions which it is not now worth while to discuss at length, and differ from those of the Rocky Mountains in amount rather than in kind.

#### ERUPTIVE ROCKS.

The eruptive rocks of this region fall naturally into two groups or series, whether considered from the point of view of their age, of their manner of eruption, or of their internal structure and composition.

Here, as in all attempts at establishing geological classification, there are found to be occurrences which form intermediate or transition members between the two groups, but yet do not invalidate the legitimacy or advisability of establishing such a division or classification. Geologists have hitherto been divided in opinion as to the nature of the relation between the age of an eruptive rock and its internal structure and composition, the extremists on one side maintaining that this relation is an absolute and fixed one, and that where, as is so often the case, its geological and external structural relations furnish no evidence as to the age of a rock, a careful study of its internal structure is sufficient to determine within certain limits its period of eruption; those of the opposite school maintain that no such relation exists, that the correspondences observed are merely accidental coincidences not dependent on age, and that the many subdivisions established by the former school are not legitimate, and, inasmuch as there are an infinity of intermediate members, could with advantage be reduced to a few general divisions. The manner of eruption, whether as an intrusion or as a surface flow, has not in general been considered an essential function of classification. In this region it would seem that the characteristic differences of internal structure of the above two classes depend rather upon the conditions under which they have consolidated than upon the absolute geological age of either class, although their relative ages, which are distinctly marked, correspond, as it happens, with the differing conditions of consolidation.

*Age.*—As regards their period of eruption, the rocks of this region may be divided into an older and a younger series, the former of which were erupted before the dynamic movement which caused the uplift of the range and were involved with the inclosing sedimentary strata in the consequent folding and faulting, while the latter are of later date than that dynamic movement.

An exact definition of the age of either group is unfortunately not yet possible. In the first place, the time of the dynamic movement is assumed as at the close of the Cretaceous period, this assumption having been adopted by the consensus of the geologists who have studied the Rocky Mountain region, for the reason that the Tertiary beds, where found in contact, are

seen to have been deposited unconformably upon the Cretaceous. But in the district included in this examination no Tertiary beds are found. Moreover, it is not impossible that later and more detailed studies may lead to a modification of this view. Secondly, although the older eruptives are only found in Paleozoic formations within the limits of the map, rocks almost identical were observed in Triassic and even in Cretaceous strata, not far beyond those limits. Moreover, the same class of rock, as will be shown below, is found in other parts of Colorado to cut through the latest Cretaceous beds. It seems probable, therefore, that though the eruption of this type of rock may have commenced much earlier, it lasted in this region till near the close of the Cretaceous. As regards the age of the younger series, the entire absence of Tertiary beds in the region renders it impossible to assign their eruption to any particular division of this era. The time that elapsed between the eruption of the last of the older series and the first of the younger must, however, have been much longer than the above statement would seem at first glance to warrant, since in it not only were the inclosing beds elevated above the ocean, and by plication and faulting brought practically into their present position, but erosion must have removed their upper portions down to a general level, which could not have been much higher than that of the average peaks and ridges of the present day.

But little direct evidence was obtained as to the relative age of the varieties composing either group, but what was found, as well as the indirect evidence and a certain indefinable habitus of the rocks, goes to confirm Clarence King's theory<sup>1</sup> that in each series of rocks composing a local eruption, and which may be considered in general to have a common source, the acidic rocks were the earlier, and the more basic followed in the order of their relative basicity. Thus, among the older series of rocks the more basic porphyrite is younger than the acid quartz-porphyrines. Direct evidence of this is confined to the single instance observed of actual contact of the two varieties of rock on the extremity of the east spur of Mount Lincoln; and here, owing to the character of the exposure, the apparent cutting of Lincoln Porphyry by porphyrite cannot be considered entirely unquestionable. The external habit and internal structure of the rocks, however, both con-

---

<sup>1</sup> Exploration of the Fortieth Parallel, Vol. I, Systematic Geology, p. 715. Washington 1878.

firm the above conclusions. In the hand specimen some of the porphyrites might readily be taken for Tertiary eruptives. Among quartz-porphyrines the White Porphyry, which is the most acid of the group, not only has the characteristics of an older rock in its internal structure, but is actually cut by transverse bodies or dikes of the Gray or Lincoln Porphyry, and a small sheet of it, together with inclosing sandstones, is included in the great mass of Sacramento Porphyry. An apparent exception to this evidence of the earlier age of its principal mass is found in the existence of two dikes of White Porphyry cutting Lincoln Porphyry, on the north wall of Cameron amphitheater, but their mass is relatively very small and the occurrence altogether an exceptional one.

Among the Tertiary eruptives Nevadite seems to be older than the andesites, judged by its internal structure and its geological surroundings, but the rocks are so widely separated that no direct evidence was obtainable.

**Manner of occurrence.**—The two groups are further distinguished by the fact that the older rocks are entirely intrusive and the younger extrusive; in other words, that the former never reached the surface, but were consolidated within the sedimentary strata and under the pressure of a considerable mass of overlying rocks, while the latter were, as far as can be determined at the present day, actually extruded upon the surface before final consolidation. This is an important distinction in its bearings upon the internal and petrographical structure of the rocks, and one upon which it seems geologists have hitherto not laid sufficient stress.

**Intrusive sheets.**—The greater mass of the older rocks occurs as sheets between the strata of sedimentary rocks, generally following a given horizon over great distances. That they were not poured out upon the surface and the overlying sedimentary beds deposited upon them—that is, that they are not interbedded sheets—is abundantly proved by the facts that they frequently cross the strata from one bedding plane to another and that they also occur as dikes cutting across the strata transversely, whose actual connection with the intrusive sheet it was sometimes possible to observe; large fragments of the overlying beds are, moreover, often found entirely included in them. The great number and extent of these intrusive sheets are very

remarkable. They vary in thickness from a foot or two up to over a thousand feet. In Mosquito gulch sheets of porphyrite averaging 20 feet in thickness can be traced continuously on the cañon walls for several miles without showing any vent, and the sheet of White Porphyry which covers the Blue Limestone is shown by its outcrops to have been practically continuous over the area of the southern half of the Mosquito map. The only direct evidence of a channel or vent leading to this sheet of porphyry from below is at White Ridge, the point where it occurs in maximum thickness, whence it might be assumed to have spread out from this point as a center of eruption. In this case it would have spread ten miles from its center, gradually thinning out from 1,500 feet over the vent and 500 feet within a mile or two of it to 20 feet at the farthest point observed. The reconstructed form of this body, as shown in Section F, corresponds to that of the dome-shaped bodies in the Henry Mountains, described by G. K. Gilbert<sup>1</sup> under the name of laccolites. Indeed, it is evident that the manner of eruption of all the older igneous rocks of this region was analogous to that of the Henry Mountain rocks, although the amount of plication, dislocation, and subsequent erosion to which these have been subjected renders it more difficult to reconstruct accurately their original form, and it is probable that if they were restored they would be found to want the regular, symmetrical shapes he describes. The large dome-shaped bodies are rare, but relatively thick sheets, one above another, are often very numerous; for instance, in the Ten-Mile district, just beyond the northern limits of the map, the outcrops of seventeen were observed in a single transverse section across an estimated thickness of less than 15,000 feet of sedimentary strata.

**Dikes.**—Normal dikes in the sedimentary strata were rarely observed, and wherever the sheets cross the strata transversely it is usually at a very low angle. In the Archean formations, on the other hand, the older rocks were almost invariably found in the form of narrow and rather irregular dikes, as a rule not over fifty feet in thickness, the principal eruptions being two large bodies of diorite, whose outlines were not very accurately determined.

---

<sup>1</sup>Geology of the Henry Mountains Washington, 1877.



The Archean exposures studied in this region were once covered by portions of the same sedimentary series in which these intrusive sheets are now found. It may, therefore, be assumed that the form of the channels through which the fused masses were forced up into the overlying beds is fairly represented by the average outline of these dikes. According to this reasoning it is evident that the channels in the Archean were extremely small as compared with the extent of the sheets themselves, and were rather in the form of the narrow fissure, which has been supposed to be the source of so-called massive eruptions, than of the rounded "necks," which have sometimes been observed as the actual vents of volcanic eruptions.

*Relation of form to composition.*—In comparing the relative form of the intrusive bodies with the composition and structure of the rocks which compose them, it is found that the more basic the rock the thinner is the sheet and the greater its relative extent in a horizontal direction. It is true the range of relative acidity in this region is not the very widest, the White Porphyry, whose beds are relatively the thickest, having about 70 per cent. of silica, while the hornblende-porphyrite, which occurs in the thinnest sheets and at the same time with relatively great horizontal extension, has a little over 56 per cent. of silica. Basalts range from 45 to 50 per cent. of silica. The great sheet of White Porphyry has an estimated thickness of 1,500 feet at the point of its supposed intrusion from below, and the least thickness observed is 20 feet. The Sacramento Porphyry, which is slightly less acid (having 65 per cent. of silica) and whose greatest thickness is found immediately adjoining the White Porphyry laccolite, is evidently somewhat thinner, being probably less than 1,000 feet at its maximum, while the hornblende-porphyrite sheet of Mosquito and Buckskin gulches is found in a maximum thickness of 25 feet, and frequently thins to 6 feet, or even less; yet its practical continuity over considerable areas is even more readily evident than in the case of the larger masses of quartz-porphry. A more remarkable instance of the great relative area of a basic intrusive sheet is that of the Whin Sill, in Northumberland, England, which, according to Messrs. Topley and Lebour,<sup>1</sup> is a basaltic intrusive sheet, that has been traced with unimportant breaks for a distance of 75 to 80 miles in a thickness of

---

<sup>1</sup>Quarterly Journal of the Geological Society, XXXIII, pp. 406-421, 1877.

about seventy feet. It occurs in the Carboniferous formation, and, like the porphyrite of Mosquito gulch, while apparently following a given bedding plane, actually changes from one horizon to another within a vertical range of about seventeen hundred feet.

It is apparent from the above facts that in underground flows of igneous rocks, as in lavas flowing on the surface, the coefficient of extent in relation to thickness of flow is a function of the relative basicity and consequent fluidity of the fused mass.

**Amount of intrusive force.**—In studying these intrusive sheets one is forcibly impressed with the magnitude of the force exerted during the intrusion of the lava, which here seems almost capable of actual measurement. Assuming as a type of these sheets the great body of White Porphyry above the Blue Limestone, it is seen that at its thickest point under White Ridge it has pried open the strata a distance of about fifteen hundred feet vertically, since that estimated thickness of White Porphyry is now found between the Blue Limestone and the overlying Weber Grits. The fused rock-mass at the time of its eruption must have been nearly fluid enough to obey the laws of hydrostatic pressure, in accordance with which the force applied to it at any point would be equally distributed throughout its mass and equally transmitted in every direction against its boundary walls. As long, therefore, as it retained the fluid condition, this force would be expended, not only in raising the beds immediately over the vent, but in spreading open the strata at as great a distance from this vent as the fluid mass could penetrate. The fluid condition was not, however, retained indefinitely, but the mass cooled gradually, and, in cooling, became solid and no longer capable of transmitting the hydrostatic pressure; therefore, the force available for prying open the strata became gradually less as the distance from the vent increased, and the distance by which the strata were forced apart at the vent may be assumed as the measurement of the maximum force exerted. It has been seen that the thickness of beds above this horizon to the top of the Cretaceous, which is the series assumed to have accumulated before the igneous rocks were injected or intruded, is estimated at 10,000 feet. It is possible that at the time of intrusion these beds were still under water, in which case the weight of the water should also be added. But

this is too uncertain a matter to enter into even so crude a calculation as the present, and may therefore be neglected. The average specific gravity of these beds may be assumed at 2.50, as the upper beds were probably somewhat lighter than the average of those observed in this region. A cubic foot would therefore weigh 155.8875 pounds, and 10,000 cubic feet 1,558,875 pounds, which is the theoretical pressure exerted by gravity on each square foot of surface, and to raise this 1,500 feet would require a force of 2,338,312,500 foot-pounds exerted on each square foot of surface.

The above figures are to be considered rather as an indication of the magnitude of the subterranean forces involved than an actual value of any particular force, since the assumptions on which they are founded cannot be mathematically proved. For instance, on the contraction theory of the folding of the beds, the tangential strain to which they were already subjected may have been sufficient to produce a tendency in the beds themselves to split apart, and thus in part have counteracted the theoretical pressure exerted by gravity.

Mathematical demonstrations, as applied to geological phenomena, are at best of very doubtful value, owing to the impossibility of obtaining data or measurements of an exactness that may be considered of mathematical accuracy, and it often occurs that such demonstrations, which undoubtedly display a high order of mathematical ability on the part of their author, are comparatively worthless, or even misleading, owing to his assumption of a premise which cannot be proved to be true.

**Source of intrusive force.**—What may have been the impelling force which brought the fused material to its present position is evidently a purely speculative question, and therefore hardly appropriate to be discussed here. Whatever it may have been, it was undoubtedly of the same nature as that which has caused flows upon the surface. Much ingenuity has been displayed by theoretical geologists in discussing the source of volcanic energy, but in the present stage of experimental or synthetic geology it is impossible to find direct proofs for or against their views. The theory advanced by Clarence King (op. cit.) is among the latest, and is deserving of consideration because of his long and varied field experience. It may be stated in a crude, brief way as follows: Starting with the assumption of a solid interior,

he shows that the increment of heat and the increment of pressure from the surface toward the interior of the earth are not the same, but may be expressed by two curves which would cross each other at a given depth. Under normal conditions, by the time the temperature in depth has increased to the ordinary fusion point of rock masses, the pressure has also increased to such a degree as to raise the fusion point of these rock masses, so that it is no longer possible for them to fuse. This he considers the permanent condition of the earth below the point of junction of the curves of temperature and pressure. Now, if for any reason the pressure is suddenly decreased, as it would be by the removal of a considerable weight of rock from the surface over a given area, and if this removal is more rapid than the change of temperature, which owing to the low conductivity of rocks must be very slow, fusion would set in and a subterranean lake of molten rock be formed. He conceives that for mountain areas the removal of large amounts of rock material by erosion would be relatively rapid enough for this purpose. Upon the thus melted mass there would be exerted the pressure of the rocks above it, and probably also an additional pressure due to expansion of its own mass by fusion, which would force the liquid magma toward the surface.

Why intrusive and not surface flows?—The next question that suggests itself is, why did the fused masses which formed the older rocks stop in their upward course at a given horizon and spread out there, instead of continuing on upwards to the surface, as did the more recent flows? Was it owing to a difference in the chemical composition of the magmas from which either series were formed or to a difference in the quality and amount of the impelling force, or, again, to a difference in the resistance offered by the rock masses through which they passed? The first of the three alternatives may, it would seem, be at once answered in the negative, since the same range in ultimate chemical composition is found in intrusive rocks as in recent lavas. The distinction that petrographers have claimed to find between the older or intrusive rocks, as a class, and the recent lavas, depends on internal structure and the arrangement of the mineral constituents, while they acknowledge that the chemical composition of the two classes may be practically identical. In this region White Porphyry and Nevadite among

the acid types of the two classes, and hornblende-porphyrite and hypersthene-andesite among the more basic, are almost identical in chemical composition.<sup>1</sup> The loci of eruption in either case are not more than ten miles apart, and yet in one instance the molten material congealed at a depth of over ten thousand feet and in the other at the very surface; and the resulting rocks are distinct varieties, differing more in the case of the basic ones, where composition is more closely alike, than in the acid.

In a discussion of the origin of a certain group of laccolites, an argument has been made in favor of the theory that their laccolitic or intrusive character is dependent on the density of the eruptive magma (which is necessarily a function of its chemical composition); that the molten mass would stop in its upward progress through the sedimentary strata, when it had reached a point at which the average density of the rocks below it was greater than, and that of the rocks above it less than, its own average density. This argument is, however, materially weakened by the instability of some of the premises. First, it is assumed that the density of laccolitic or intrusive rocks is less than that of erupted lavas. Even should this prove to be true of that group, it would not be a sufficiently wide basis on which to found a generalization for laccolitic or intrusive bodies as a whole. Secondly, the data used in support of a necessary condition of this argument, namely, that "the acidic rock of the laccolites must have been heavier in its *molten* condition than the more basic rock of the neighboring volcanos," are, as the author acknowledges, insufficient, even if trustworthy. Aside from the value of this argument as such, however, the facts observed in this region, as mentioned above, afford a direct proof of observation against it. Moreover, as no chemical analyses of the rocks of this group of laccolites were made, it is by no means impossible that they are, as a class, much less acid than the author supposed.

Whether or not there was a difference in the impelling force in the case of intrusive sheets and of surface flows is a purely speculative question, for which no direct evidence can be obtained. It might perhaps be argued that, if the magma from which each of these series was formed originated at essentially the same position within the earth's crust, it would

---

<sup>1</sup>See analyses 1 and 9 and 5 and 10, Table I, Appendix B.

have required about the same amount of force to bring the earlier intrusions to their place of consolidation, 10,000 feet below the surface, that it did to bring the later flows to the surface after the 10,000 feet of superincumbent strata had been removed by erosion.

In regard to the third alternative, it seems that a part at least of the reason for the stoppage of the intrusive magma at its present position may be found in the resistance to its passage offered by the sedimentary strata. If it were a question only of the porphyry sheets above the Blue Limestone, it might be assumed that the Weber Grits offered some special conditions of impenetrability; but, in point of fact, although intrusive sheets are almost always found at this horizon in the Mosquito region, they also occur at many other horizons, both above and below. While it cannot be maintained, therefore, that any particular bed offered special resistance to the passage of the fused mass, it is not only evident a priori, but supported by observations of many of the transverse sheets and dike-like bodies, that a continuous and unbroken horizontal rock stratum would offer more resistance than one that was inclined, broken, or fissured. The molten rock-mass would naturally seek joints or fault planes, or, in default of these, follow the lines of least resistance along bedding planes. That the intrusive bodies are not found following the planes of the great faults of this region would in itself be a sufficient proof, were none other available, that these faults are subsequent to the intrusion of the older igneous rocks. Taken as a whole, it seems evident that the upward passage of a molten stream would be much more impeded in a series of horizontal and comparatively unbroken strata, such as are supposed to have existed here at the time of the intrusion of the older rocks, than it would be after they were uptilted, flexed, and dislocated, as they were at the time of the eruption of the younger series. In the case of each of the three larger masses of true eruptive rocks of the region, viz, those of Chalk Mountain, of Black Hill, and of Buffalo Peaks, wherever the sedimentary strata are visible in close connection with the eruptive mass they are seen to be standing at a very steep angle and the eruptive mass has apparently flowed over their basset edges.

*Internal structure.*—From this point of view the division of the igneous rocks of the region is also well marked, although it is in the nature of

things more difficult to draw a sharp and definite line of separation than in the case of the two characteristics already discussed. It is also to be remarked that, whereas these structural distinctions have hitherto been considered to be essentially a function of the age of the rocks, the studies conducted during the present investigation tend rather to the conclusion that these distinctions are primarily dependent on the manner of occurrence of the bodies, or, in other words, the conditions under which they consolidated, and only secondarily on their age; hence that the age of a rock can only be relatively and not absolutely determined by its internal structure and petrographical constitution. The details of the microscopical structure of the various rock species are so fully described and discussed by Mr. Cross in Appendix A that only a few of the more prominent characteristics of the two types, such as will serve to correlate them with those of other regions, need to be given here. The older series are either entirely granular, or, where porphyritic, are characterized by the holocrystalline structure of the groundmass and an absence of isotropic or amorphous material, when examined under the microscope. Many of the orthoclastic varieties have extremely large crystals of that feldspar, which give a striking and easily recognizable appearance to the rock masses; although very prominent in Colorado, this peculiarity can hardly be regarded as an essential characteristic of the type. They are not vesicular or scoriaceous; in other words, they present the external characteristics of a rock cooled under pressure. The younger type, however, while in exceptional instances almost holocrystalline, generally contains isotropic material or actual glass substance. Its orthoclastic feldspars are essentially sanidine, it may be vesicular and scoriaceous, and in general carries abundant glass inclusions and bears evidence, either in its structure or in the constitution of its mineral constituents, of having cooled at or near the surface, and consequently more rapidly than the older type. In the Mosquito region there is apparently a definite relation between age and relatively granular character of the different varieties of either type; thus White Porphyry is the most thoroughly granular rock among the older series, and Nevadite among the younger. Although the relation of pressure and conditions of cooling to internal structure are so marked and important in the two great series, or, so to speak, generically,

the difference of internal structure in a given species, due to difference of pressure, is, if it exists at all, so slight as to escape observation. Thus, between the lowest body of White Porphyry, which occurs in the Archean, and the highest, which is near the top of the Weber Grits (a vertical range of about three thousand feet), no essential difference in internal structure was detected. It would appear, therefore, that, while very wide differences in the conditions of cooling may produce a generic difference between two series of rock varieties, the internal structure of a given variety is not dependent on those conditions alone, but that the species possesses certain essential characteristics of its own which are dependent on other factors.

While the petrographical studies made in the course of this investigation, forming only an accessory and not an essential part of it and being confined to a limited area, are not sufficiently complete to form the basis of an essential change in the classifications hitherto adopted, they point decidedly to the fast approaching necessity of some essential modification in them. Thus, the White and Lincoln Porphyries would a few years ago have been unhesitatingly classed by petrographers, from a study of their specimens and aside from any field observations on their geological relations, as granite-porphyry or mica-granite, and probably of Paleozoic or early Mesozoic age, from their resemblance to well-known rocks of that age in other parts of the world. The hornblende-porphyrites, on the other hand, might from the same standpoint have been classed as Tertiary andesites.

*Orthoclasic and plagioclastic rocks.* — The now universally adopted chemico-mineralogical classification (based on Tschermak's classical studies) of orthoclasic and plagioclastic rocks is one which presents ever-increasing difficulties of application with the progress of microscopical and chemical investigation. In the present instance the older rock series contain relative proportions of orthoclase and plagioclase feldspar, often so evenly balanced that the slight variations in their proportions, which may be found in different parts of what is apparently the same mass, would be sufficient to justify the placing of the same rock now in the orthoclasic division now in the plagioclastic. Again, in those porphyries in which the orthoclasic feldspars have developed in large individuals, it is evident that so much orthoclasic material has thus been abstracted from the groundmass that, were the latter taken



as the type of the rock, it would be classed as plagioclastic, while in the rock as a whole, or in those varieties in which the large orthoclases have not been developed, orthoclase predominates. It is apparent, moreover, that, owing to the increased facilities which the microscope now affords for the detection of plagioclase among the microscopical constituents of a rock, an ever-increasing number of rocks hitherto supposed to be orthoclastic will be found to have a predominance of plagioclase feldspars, and that, if this distinction remains without modification as a basis of classification, the extent of rock species of the orthoclastic type will become more and more restricted and eventually rather rare.<sup>1</sup>

Distribution of intrusive rocks in the Rocky Mountains.—The older and intrusive series of rocks, represented in this region by the porphyries, porphyrites, and diorites, form undoubtedly a very large proportion of the igneous rocks of Colorado and adjoining regions which have hitherto been classed as Tertiary eruptives or as eruptive granites. To how great an extent they should be substituted for the latter on the existing geological maps it is not yet possible to determine with accuracy, owing to the incompleteness or absence of characteristic specimens. An opportunity was, however, offered in the case of the Henry Mountains, so ably described by Mr. Gilbert, who kindly loaned a considerable number of the actual rock specimens and sections, upon which the determinations for his work were founded. These were submitted to Mr. Cross for microscopical examination, several new thin sections being made by him for this purpose. The results of his investigation, although (owing to the incompleteness of the series and the altered condition of many of the specimens) not adequate to afford a complete characterization of all the rock masses found there, show conclusively that they belong to the same structural type as the older intrusive rocks of this region. Out of 19 varieties represented by specimens or thin sections, 14 were found to correspond very closely in composition and structure to the

---

<sup>1</sup>A remarkable instance of this tendency is found in the recent review of rock determinations of the fortieth parallel by Messrs. Hague and Iddings (*American Journal of Science*, xxvii, 453, 1884), which shows that in the vast area covered by that survey only a single true trachyte, and that not of the most characteristic type, was observed, although in the original determinations, made in the light of the best petrographical science as it existed twelve years ago, these rocks were supposed to form a large and important class there.

hornblende-porphyrites of the Mosquito Range and 3 differed from the Mosquito rocks in containing a peculiar development of augite in the place of hornblende.<sup>1</sup>

Mr. Gilbert enumerates various isolated groups of mountains in the plateau region—the Sierra La Sal, Sierra Abajo, Sierra El Late, and Sierra Carriso—which, from the description of geologists who have visited them, he infers to be true laccolites. He also infers that their rocks are analogous to those of the Henry Mountains, which is very likely to prove true in so far that what he describes as porphyritic trachyte may correspond to the porphyries with large crystals above described. His further generalization that the two types of mountain structure, the laccolitic and the volcanic, necessarily involve two chemical types of rock, the one acidic, the other basic, is, as shown above, not authorized by the observed facts. It might fairly be reasoned that the more acidic lavas, when intrusive, owing to their greater viscosity, would tend to form thick, dome-shaped masses like his laccolites, rather than basic lavas; but even this tendency is not without its exceptions.

It is the intrusive quality, not the relative acidity or basicity of the magma, to which the characteristic structure of this rock type is due.

Dr. Peale<sup>2</sup> has further extended the probable development of intrusive bodies, more or less analogous to the laccolites in form, but furnishes no decisive determination of their petrographical structure or composition. From specimens seen or actually collected by the writer, it may be stated, however, as a fact about which there can be little question, that the type of intrusive rock represented by the older series is extensively developed between the North and Middle Parks, in the Middle Park, and between the Middle and South Parks, that it forms the mass of Spanish Peaks, and occurs in enormous developments in the Gunnison region, where the varieties characterized by large feldspars cut across Cretaceous strata. Similar bodies also exist beneath the more recent lavas of the San Juan region, which lends probability to the supposed similarity of the rocks forming the isolated mountains of the Sierra El Late, Sierra Carriso, and others.

---

<sup>1</sup>Mr. Cross's detailed description of these rocks will be found at the end of Appendix A.

<sup>2</sup>"On a peculiar type of eruptive rocks in Colorado." *Bulletins United States Geological and Geographical Survey*, Vol. III, pp. 551-564.

**Contact metamorphism.**—There is a notable absence of caustic phenomena in this region, either on the inclosing or the included sedimentary rocks at their contact with the intrusive masses, such as are generally supposed to accompany the eruption of igneous rocks.

In the case of such numerous and large bodies they might naturally be expected to be exceptionally frequent and well marked, since the eruptive masses must have retained great heat for an unusually long time on account of the depth at which they were consolidated. Perhaps the absence of any evidence of fusion in these rocks might be explained on this very ground, that at that depth the pressure was so great that the fusion point was considerably raised, and hence a temperature sufficient to hold in a molten condition the mixed material already fused would be insufficient to melt homogeneous and by themselves comparatively refractory rocks, like sandstones and dolomites. However this may be, nowhere was any evidence of fusion observed in the sedimentary rocks, even in the case of very small fragments entirely included in the eruptive rock. Even in the dikes of porphyrite cutting through the Archean, in which inclosed fragments of country rock, generally of small size, are particularly abundant, neither quartz, granite, nor gneiss, of which these fragments generally consist, shows any alteration at the contact, though the porphyrite material often fills small cracks in them, showing that it was in a thoroughly fluid condition at the time they were caught up. Such alteration as was found could more readily be ascribed to the combined action of heat and water than to heat alone.

On the other hand, the reflex action of the colder sedimentary rocks on the eruptive mass is generally noticeable, and is such as is ordinarily found, showing itself in a fine-grained or even compact structure for a few inches or more from the contact, and in a somewhat different arrangement of the mineral constituents of the rock. It is much more prominent in the narrow dikes than in the large intrusive sheets, but occurs at both upper and lower contacts of the latter, and may also be detected around the included fragments. Even in these cases, however, there was no appearance of vitrification

Instances of regional metamorphism are not wanting. Sandstones are changed to quartzites, dolomites frequently into marbles and less often more or less serpentized; but these changes cannot be assigned to the direct action of heat, since they are in no sense contact phenomena. Their development is local and irregular, extending over considerable areas, where there is no actual contact of the altered beds with intrusive rocks, and, on the other hand, being more generally absent from the actual contact with these rocks.

*Non-absorption of sedimentary rocks by eruptive masses.*—Another important observation in regard to these intrusive bodies, and in one sense a corollary of the above statements, is the fact that, although they have split apart and pried open the sedimentary strata and caught up or entirely surrounded both large and small fragments of sedimentary rocks, there is no evidence of their having absorbed or assimilated within themselves by actual fusion any portion of these sedimentary rocks; certainly not any considerable masses thereof. Not only are there no relics of fusion at the present contact, as there necessarily would have been if a portion had already been fused, but in reconstructing the sections on actually measured profiles there is no portion of the sedimentary strata missing, which cannot be accounted for by erosion. Along the contact surface the fused mass has cracked off fragments, often quite small, which have consolidated again into a sort of breccia; again, the thinner sheets have sometimes bent back and contorted a stratum of limestone or quartzite at the end of the flow or as it crossed from one bed to another; but of fusion, as already stated, there is no sign.

I have insisted on this point because the question of the capability of an igneous mass to absorb, or eat up as it were, the sedimentary or even already consolidated igneous rock through which it passes, is one which has always interested me, and for which, in a field experience of over fifteen years, largely among eruptive rocks, I have vainly sought for demonstrable proof. It is customary among geologists to draw their ideal underground sections of igneous masses as if this capability were unlimited, and geological text-books seem to tacitly assume that it is so, without offering an explanation of how it is possible or the grounds on which the assumption is made.

So far as I know, the English geologists are the only ones who have met the question distinctly and have brought forward instances in nature to prove that igneous eruptions have eaten up practically unlimited amounts of sedimentary rocks. These instances are the so-called granite bosses in Ireland (Mourne Mountains), Scotland, and England (Devon and Cornwall), cutting through upturned Cambrian and Silurian rocks, which are comparatively undisturbed by the eruption and maintain their normal strike up to these granite masses on either side.<sup>1</sup>

Professor Geikie goes so far (*op. cit.*, p. 550) as to ascribe the variability in composition and structure of intrusive masses to involved and melted-down portions of sedimentary rocks. It would be presumptuous to doubt the correctness of the field observations on which these generalizations are founded, and yet it is not only possible, but has sometimes come under my observation that a granite boss has been found protruding through a given rock or series of rocks, and therefore been judged by the geologist who examined it to be younger than the latter, whereas, in fact, the reverse was the case, and the latter rock had been deposited, or had flowed, around an already-existing granite protrusion. In many cases it is difficult to obtain direct proof whether the protruding or the inclosing rock is the older, and in such a case the probability one way or the other may be dependent on this very question of the capability of igneous rocks to assimilate large masses of sedimentary rocks.

A case in point is the granite body of Little Cottonwood cañon, in the Wasatch Mountains, of which a section some seven miles long has been exposed by the erosion of the cañon. The present outcrops of the body occupy an area whose dimensions may be roughly stated as 7 by 15 miles; and a thickness of some 5 miles of sedimentary rocks abuts against its northern side, the upper members sweeping round and in part covering its eastern portion, and continuing southward in an almost horizontal position. There is no special disturbance of these beds in contact with the granite; so far as observed, they follow the normal dip and strike induced by the dynamic movement of the region. Neither are there any masses or fragments of sedimentary rocks included in the granite. Regional metamorphism exists

---

<sup>1</sup>A. Geikie: *Text Book of Geology*, pp. 541 et seq. London, 1882.

in the changing of sandstone to quartzite and of limestones to marble, but these are by no means contact phenomena, and occur as often, if not oftener, at considerable distances from the granite as in direct contact with it. Porphyry dikes also cross the sedimentary strata in the vicinity, but these have no more necessary connection with the granite than have the neighboring bodies of volcanic rocks. They are not direct offshoots from it, and, so far as their manner of occurrence and structure go, may bear the same relation to it that the porphyries of the Mosquito Range do to the Archean eruptive granite. When I examined this region on the Exploration of the Fortieth Parallel, my first impulse, guided by my teachings as a student of geology, was to consider the granite an intrusive mass cutting Carboniferous strata; it was, however, difficult to conceive that it should have eaten up over five hundred cubic miles of sedimentary rocks without leaving some more definite evidence of this action than it has. This, together with other considerations, led me, after a careful weighing of the evidence, to the view that the granite must have been erupted in Archean time, and that in the ocean of the Cambrian and subsequent periods it formed a submerged reef around which the sedimentary beds were deposited. Professor A. Geikie, the English geologist, whose eminent ability none can recognize more fully and heartily than I do, after a visit to the region, occupying only a few days, decided promptly that my view was wrong, and, evidently basing his opinion on the granite bosses of his own country, has published it in his text-book<sup>1</sup> as an instance of Post-Carboniferous granite. While, owing to the necessarily hasty character of reconnaissance work like that of the fortieth parallel, it is very possible that a more detailed study might lead us to modify our own views, especially in regard to so complicated a district as that in question, I should still be unwilling to admit, even at the instance of so experienced a geologist as Professor Geikie, that the Cottonwood granite can be Post-Carboniferous, even if my only reason were that I do not admit the possibility that the granite had eaten up or assimilated this enormous mass of sedimentary rocks without leaving any trace of fusion on the adjoining rocks, any incompletely assimilated portions within its own mass, or without showing in its own structure and composition any marked variation from that of the normal rock.

---

<sup>1</sup>Op. cit., p. 646.

It seems to me that there is a marked distinction between the metamorphism that is found in regions where igneous rocks abound (and which is generally admitted to be the result of the combined action of heat, pressure, and water) and that which involves the entire absorption and assimilation of foreign rock masses into the substance of the igneous mass itself. The former in its extreme phase supposes a simple rearrangement of the materials of a rock, a change in their form without any essential change in their chemical composition, and involves at most the bringing of them to a viscous state, not to that of fusion. The latter must be a dry process and involves a fusion of the foreign materials as complete as that of the original magma in the deep-seated source from which it came. For fusing the 500 cubic miles of sedimentary beds supposed to have been assimilated by the Cottonwood granite body an enormous amount of heat must have been abstracted from that body. Now, to have this amount of heat to yield up, and yet to be able to maintain itself in a state of fusion long enough to crystallize in the same way that it would without this addition of foreign material, supposes an amount of original heat stored up within its mass that ought to have vitrified some of the rocks through which it passed. It is not difficult to conceive of such heat in the deep-seated source from which the igneous rocks came, but that it should still exist in these rocks when they have reached the point where they are ready to solidify, and which may be assumed to be near the limit that this heat would carry them, seems highly improbable. The only cases of actual vitrification of inclosed fragments in igneous rocks that I have read of have been in recent volcanic rocks, where the fragments were extremely small.

As suggested above, the pressure under which the intrusive rocks of the Mosquito Range were consolidated would necessitate a higher temperature to produce fusion. In the case of the Cottonwood granite the pressure under which consolidation took place and the consequent temperature of the fusion point must have been greater still. But the Mosquito porphyries retained a very fluid condition, and therefore a temperature higher, as compared with the fusion point, than the Cottonwood granite, for a very long time, since they were spread out in thin sheets and ramifying bodies in every direction at considerable distance from the central mass, while the

Cottonwood granite, as far as can be seen, formed only a single massive body without ramifications. The porphyries must therefore have had more superfluous heat than the granite to devote to the work of melting up the included masses of sedimentary rocks, and one can see here, as one cannot in the granite, that such masses were actually caught up and included in the fused rock. It would be fair to assume, therefore, that in this case relatively larger amounts of sedimentary rocks would have been fused and that the evidence of such fusion would be more apparent.

In the present condition of microscopical investigation we may trace the development of one mineral from another and detect its most minute alteration, either by fusion or by chemical interchange; and, had any of these sedimentary rocks been assimilated into the igneous mass, it would seem hardly possible that every trace of the process should have escaped our observation in the thousands of rock sections that have been examined. In point of fact, however, although in the case of the porphyrite dikes the eruptive material is found to fill minute cracks in the inclosed fragments of Archean rocks, there could be detected no evidence of fusion on either adjoining or inclosed sedimentary rocks. In the eruptive rocks themselves, moreover, the alterations of mineral constituents are all the result of secondary processes after the mass had fully cooled and crystallized.

The testimony of the chemical composition of these rocks is, so far as it goes, equally opposed to the supposition that foreign matter has been assimilated by any of these intrusive bodies. Of White Porphyry too few specimens were analyzed to afford a decisive test; but it is to be remarked that the two specimens (see Table II, Appendix B) which show an abnormally high percentage of silica are from the London and New York mines and are extremely decomposed and altered, a secondary action which has decreased the proportion of more soluble basic constituents and correspondingly increased the percentage of silica. Of the Lincoln or Gray Porphyry six specimens from different bodies show an average of 68.08 per cent. of silica, with an extreme variation from this average of 2.63. For the combined alkalis, three specimens show an average of 6.14 and an extreme variation of 0.86; and for lime and magnesia combined, three specimens show an average of 4.03, with an extreme variation of 0.19.



The Cottonwood granite, which, on the supposition advanced by Professor Geikie, must have taken up an enormous amount of silica, lime, and magnesia, shows, however, no abnormal amount of these constituents in its composition, which is that of a normal granite rather rich in plagioclase.<sup>1</sup>

<sup>1</sup>The composition of this granite, as given in Exploration of the Fortieth Parallel, Vol. II, p. 357, is as follows:

SiO <sub>2</sub> .....	71.78
Al <sub>2</sub> O <sub>3</sub> .....	14.75
FeO.....	1.94
MnO.....	0.09
CaO.....	2.36
MgO.....	0.71
Na <sub>2</sub> O.....	3.12
K <sub>2</sub> O.....	4.89
Ignition.....	0.52
	100.16



---

---

APPENDIX A

---

PETROGRAPHY

BY

WHITMAN CROSS

---

---



# CONTENTS.

	Page
Introduction .....	319
Classification of Mosquito Range eruptives .....	322
Older eruptives .....	323
Quartz-Porphry .....	323
Mount Zion Porphyry .....	323
White or Leadville Porphyry .....	324
Pyritiferous Porphyry .....	326
Mosquito Porphyry .....	327
Lincoln Porphyry .....	328
Gray Porphyry .....	330
Diorite .....	333
Quartz-mica-diorite .....	333
Hornblende-diorite .....	333
Augite-bearing diorite .....	334
Porphyrite .....	334
Principal group .....	335
Sacramento Porphyrite .....	341
Silverheels Porphyrite .....	342
Miscellaneous porphyrites .....	343
Younger eruptives .....	345
Rhyolite .....	345
Chalk Mountain Nevadite .....	345
Black Hill rhyolite .....	349
McNulty gulch rhyolite .....	350
Empire gulch rhyolite .....	351
Other rhyolites .....	352
Rhyolitic tufa in South Park .....	352
Dike in Ten-Mile amphitheater .....	352
Breccia in the Eureka shaft .....	352
Quartziferous trachyte .....	352
Andesite .....	353
Pyroxene-bearing hornblende-andesite .....	353
Hypersthene-andesite .....	354
Tufaceous andesites .....	354
Résumé .....	354
The rock structures observed .....	355
Individual rock types .....	355
Mutual relations of rock types .....	356
Rock constituents .....	356

	Page.
Résumé—Continued.	
Decomposition of rock constituents .....	356
Negative observations .....	357
Chemical composition .....	357
Notes on the Henry Mountain rocks.....	359
Hornblendic rocks .....	359
Augitic rocks .....	361
Résumé .....	362

# PETROGRAPHY.

---

BY WHITMAN CROSS.

---

## INTRODUCTION.

The eruptive rocks of the district embraced by this report are naturally divisible into two groups, according to age. Although the age of neither group can be exactly defined in geological time, the larger and more important one is unquestionably older than the period of disturbance which produced the great faults and folds described in other parts of this volume, while the other group is younger. In this district, rocks of the former group penetrate the Upper Coal Measure strata; in adjoining regions they occur in similar manner in the Trias; and masses of nearly identical character are found in the Cretaceous of districts not far removed from the Mosquito Range. The conclusion that the rocks of the older group are of late Mesozoic age seems warranted by all that is known concerning their occurrence. In regard to the period of dynamic disturbance, it has already been stated in Chapter II that the known evidence places it at the beginning of Tertiary time.

It is plain, then, that the rock groups mentioned might be considered the direct equivalents of the Tertiary and Pre-Tertiary divisions of many writers, but it is thought best to refer to them simply as the *older* and the *younger* groups, and by this division it is intended to express merely the actual relationship as to age which is shown by the observed occurrences. The question concerning the possible influence of age upon the structure of these groups cannot be fully discussed at the present time, because the rocks of other districts in Colorado, the study of which has been undertaken, form with those of the Mosquito Range a connected series, requiring a correlation of observations upon all of them before justifiable conclusions can be drawn.

All of the older eruptives and some of the younger series are fully crystalline, although few of them are typical granular rocks, and the structural forms presented are such as render advisable some statement as to the sense in which the terms "granular" and "porphyritic" are used in the descriptions that follow. When these terms are applied with the old and natural meaning, to designate certain universally recognized rock structures, it is probable that the groups formed by the application will be practically the same, whether the attempt is made to accurately define the boundary line or

not. All consider granite as a typical granular rock; and that rock which would be cited by any one as typical of the porphyritic structure could scarcely be placed elsewhere under any existing definition. This latter assertion is at least true now that Rosenbusch has withdrawn his earlier definition,<sup>1</sup> by which the presence of some amorphous matter in the groundmass was made essential to a porphyry. The new ground taken by Rosenbusch<sup>2</sup> in regard to the essential difference between the granular and porphyritic modifications of eruptive rocks seems to the writer open to some serious objections, although the great value of many of the points so clearly presented must be gratefully acknowledged by all. While a full discussion of the question cannot be entered upon in this place, the chief objections to the new definition may be briefly stated.

If the writer correctly understands the position taken by Rosenbusch in his essay upon the essence of the granular and porphyritic rock structures, the latter wishes so to redefine the terms "granular" and "porphyritic" that they shall henceforth indicate genetic and not structural relations. It is claimed that the typical structures hitherto designated by these terms have their origin in the history of each individual rock mass; the granular rocks having come to complete solidification in the course of what may be termed a single *phase*; the porphyritic types, on the other hand, having passed through two phases, in the second of which the groundmass was formed—the matrix for the crystals of the earlier phase. The genetic groups thus outlined are to replace the structural ones, while the terminology is to remain the same.

The first objection to be raised is that a new division of eruptive rocks according to a genetic principle does not in any way destroy the purely structural groups already existing, even if the divisions produced by the two principles are exactly coincident in extent. It will still be desirable and necessary to refer to rock structures independently of genetic connections, and the terminology of the science is not simplified but rather complicated by the application of a given term in two distinct senses. Granular cannot be logically used with a genetic meaning while, at the same time, it is desirable to apply it in accordance with existing usage as a purely structural term. In the second place, it seems a matter for debate as to whether the groups formed on the new principle *are* coincident with the structural ones. If not, we surely cannot cover them by a single definition, nor use the same terms in their description.

That the new definitions, when logically applied, do produce divisions widely different from the corresponding structural groups is well illustrated in the case brought up by Rosenbusch himself, in a passage of which the following is a free translation:

If we follow in thought the process of granite formation, we reach at length a point, after the separation of ore-grains, apatite, zircon, biotite, hornblende, or augite, and a part of the feldspars, where, between the ready-formed mineral particles which are to make up the mass of the rock, a very fluid, acid residue remains, out of which some feldspar and quartz are yet to be formed. If now, through any cause, the solidification of the rock be suddenly interrupted at this point, the residue will solidify as amorphous substance (it might under certain conditions be spherulitic or even granophyritic) and we have thus a granular mixture of the granite minerals (with the exception of quartz) and irregular

<sup>1</sup>Physiographie der massigen Gesteine, pp. 86, 87.

<sup>2</sup>"Ueber das Wesen der körnigen und porphyrischen Structur bei Massengesteinen." Neues Jahrbuch für Mineralogie, etc., II, 1, 1882.



patches or particles of a very acid glass—a case described by G. vom Rath in a so-called trachyte from Monte Amiata, in Tuscany. Such a rock can only be designated as a granular rock which is not entirely holocrystalline. On the other hand, if the rock contains quartz among its crystalline particles, then it may no longer be regarded as granular, but rather as a porphyritic rock.<sup>1</sup>

According, therefore, to the new rule, strictly applied, we may have a granular rock containing glass. In the case cited the glass is described as in isolated particles; but the classification could not have been different had it appeared as a base holding and cementing together the mineral grains, neither can the amount of this glass be restricted under the considerations which gave rise to the definition. A rock of the orthoclastic series, containing crystals of ore, biotite, apatite, plagioclase, and some orthoclase, imbedded in glass or microfelsite, which might compose more than half of the mass, would still be a *granular* rock, while, had the crystallization proceeded further and some quartz been added to the other minerals, the product would have been a *porphyry*. Again, in referring to the observed difference between diabase and gabbro resulting from the formal development of the feldspars, Rosenbusch remarks that this difference is only an apparent one, if the essence of the diabase *structure* be considered as lying in the *relative age* of the feldspars and not in their *form*.<sup>2</sup> Yet this formal difference still exists and must be described; but, if Rosenbusch's definitions be adopted, it cannot be described as structure.

These instances have been considered somewhat in detail, to show clearly the correctness of the statement that Rosenbusch desires to *replace* the structural groups by purely genetic ones, and also to show that the two divisions are not coincident in extent. In regard to the latter point it seems to the writer that it may fairly be questioned whether all granular rocks are the result of one phase and whether all porphyritic rocks have required two phases of consolidation.

Finally, the great precision aimed at by Professor Rosenbusch in his new definitions seems to be unnatural. Rock groups blend insensibly in all directions; therefore sharp boundary lines are arbitrary and undesirable.

In the following rock descriptions the terms "granular" and "porphyritic" are used in the purely structural sense. Were the genetic principle applied the grouping would be the same.

---

<sup>1</sup> "Verfolgen wir in Gedanken den Act der Granitbildung in seinem Verlaufe, so wird nach Ausscheidung der Erze, Apatite, Zirkone, Biotite, resp. Amphibole oder Pyroxene, und eines Theils der Feldspathe ein Stadium eintreten, wo zwischen den ausgeschiedenen, die fertige Hauptmasse des Gesteins bildenden Gemengtheilen in unregelmässigen Partien eingeklemmt ein sehr acides Magma vorhanden ist, aus welchem sich der letzte Rest der Feldspathe und der Quarz auszuschneiden hätten. Denken wir uns nun durch irgend welche Ursache an dieser Stelle den Bildungsprocess des Gesteins plötzlich unterbrochen, so wird der Rest von Mutterlauge amorph erstarren (er könnte unter Umständen auch sphärolithisch, ja granophyrisch erstarren) und wir erhalten so ein körniges Gemenge der Granit-mineralien (mit Ausnahme des Quarzes) und unregelmässige Brocken und Partien eines sehr sauren Glases—bekanntlich ein Fall der nach G. vom Rath's Beschreibung bei einem sogenannten Trachyt vom Monte Amiata in Toscana vorliegt. Ein solches Gestein kann nur als ein körniges Gestein mit nicht ganz holokrystalliner Ausbildung bezeichnet werden.—Enthielte dagegen das Gestein unter den krystallinen Ausscheidungen auch den Quarz, so wäre es dann nicht mehr als ein körniges, sondern als ein porphyrisches zu betrachten." Op. cit., p. 15.

<sup>2</sup> "Wenn man das Wesen der Diabasstructur nicht in der Form, sondern in dem relativen Alter der Feldspathe sieht." Op. cit., p. 8.

Classification of Mosquito Range eruptives.—The eruptive rocks of the Mosquito Range are classified as belonging to the following groups:

Older . .	}	Quartz porphyry.
		Diorite.
		Porphyrite.
Younger	}	Rhyolite.
		Andesite.

For the reasons given in the chapter on rock formations, the possible eruptive granites of the Archean areas are not included in this discussion. It is at once noticed that basic eruptives, such as diabase or basalt, do not occur in this region, and even the andesites above mentioned are only found outside the area mapped.

Nearly all the important rocks of the district are described as quartz-porphyry or as porphyrite. Of these two classes there are several marked types, and they are so connected by intermediate or transition forms as to build an almost complete series, uniting the dissimilar extremes. The treatment of these rocks in the present chapter, which has been revised in the light of experience gained in adjoining districts, is somewhat different from that at first adopted; hence a few minor discrepancies may be noted between the classification here given and that indicated by the coloring of the map and the text of the main work. The map was engraved and colored before this information from other districts was obtained, and could not, therefore, be changed; the general text is, however, consistent with the divisions of the map. The inconsistencies alluded to are really of but little moment, as they relate to certain more or less questionable forms near the line between quartz-porphyry and porphyrite, which, taken by themselves, might readily be differently classed by different persons. The changes are introduced here for the sake of preserving, as far as possible, a uniform system in this and in forthcoming reports on adjoining districts.

## OLDER ERUPTIVES.

### QUARTZ-PORPHYRY.

#### MOUNT ZION PORPHYRY.

This rock occurs in the masses of Mount Zion and Prospect Mountain and is designated by a special coloring upon the detailed Leadville map, while it is united with the White Porphyry on the map of the Mosquito Range.

In structure it resembles a fine-grained granite at first glance, there being but few biotite leaves, with occasional feldspar and quartz crystals, which by reaching a diameter of three or four millimeters become conspicuous in the mass of the rock. When the rock is fresh the naked eye easily distinguishes many quite uniformly small quartz grains imbedded in the feldspar, which is the chief constituent. Biotite is uniformly but sparingly present in small, irregular leaves.

Microscopical.—By the aid of the microscope the following constituents are found, named in order of their formation: Zircon,<sup>1</sup> magnetite, apatite, biotite, plagioclase, orthoclase, and quartz.

With a low power of the microscope the chief part of the rock is found to consist of an irregular granular mixture of orthoclase and quartz, the latter occurring in roughly rounded grains 0.3<sup>mm</sup> to 0.7<sup>mm</sup> in size, which often seem inclosed in the more irregular and frequently larger grains of orthoclase. The presence, in almost every grain of these two minerals, of plagioclase microlites having a prismatic habit with apparently somewhat rounded terminations, and averaging 0.1<sup>mm</sup> in length by 0.01<sup>mm</sup> to 0.03<sup>mm</sup> in width, shows their coincident formation. These microlites, which consist of from two to five laminae, are very numerous and form the most characteristic constituent of the rock. Plagioclase grains occur, corresponding in size to those of orthoclase and quartz, but they usually show some crystal outlines, and through their freedom from the microlites the correspondence of these grains to the larger, stout crystals, which are sometimes 4 millimeters in diameter, seems clearly established. The total absence of the microlites, the difference in form, and the larger angle of extinction, reaching in some observed cases 20° either side of the twinning plane, show plainly that these crystals represent an earlier and doubtless more basic variety of plagioclase than the microlites. The larger crystals are not abundant, and are seldom prominent in the hand specimen. Biotite is never developed in crystal

---

<sup>1</sup> In nearly all the rocks of this district a mineral, presumably zircon, has been found. Its identity has been proven in a rock from the Ten-Mile district, chemically and crystallographically.

form, and is usually much altered. The three accessory minerals are sparingly present, apatite especially so. In none of the sections examined is there any finer-grained interstitial matter.

**Alteration.**—The decomposing agencies acting upon the Mount Zion Porphyry seem to have been particularly favorable to the formation of *muscovite*, which is the end product of the alteration of the biotite, as well as the immediate one of that of orthoclase and plagioclase. In the latter two minerals the process takes place in the usual way, and in the extreme decomposed state each grain and microcline not wholly inclosed in quartz is replaced by a brilliantly polarizing aggregate of minute, colorless, but lustrous leaves. In the case of the biotite there are visible transition stages. Ore particles and yellow needles (rutile ?) are first formed, and the biotite passes into a yellowish-brown, faintly-polarizing, unknown substance, which soon gives way to a mica indistinguishable from the product of the adjoining feldspars. Occasionally pure leaves of muscovite are found in quite fresh rock, but, as they always increase in quantity in more decomposed specimens, their secondary origin is probable. No other secondary product of importance remains, in the advanced stages of decomposition. Specimens of Mount Zion Porphyry which are bleached through the disappearance of the biotite become indistinguishable from White Porphyry. (See p. 76.)

#### WHITE OR LEADVILLE PORPHYRY.

On account of its relation to the ore bodies, its peculiar mode of occurrence, the large area in which it is found, and its petrographical interest, the White Porphyry must be regarded as the most important eruptive of the district, and it will be described in considerable detail.

**Macroscopical.**—In its most typical form it is a nearly white, compact or finely granular rock, which at first glance seems to be homogeneous, but under close examination usually discloses a number of small feldspar crystals, and, scattered irregularly through the mass, not unfrequently, double pyramids of quartz. Hexagonal crystals of dark brilliant muscovite may occasionally be seen, but this is probably secondary, as are, very certainly, the clusters of pearly leaves of the same mineral, which are characteristic of the rock in some places, as in California gulch, on Lamb Mountain, and in the intermediate region. The total absence of biotite and bisilicates makes the rock seem dull white, except when stained by secondary infiltration products, and decomposition in the ordinary way only makes the rock seem more homogeneous and compact than before. Upon the contact with the wall-rock or in some of the more narrow dikes the White Porphyry is found to contain more numerous crystals of quartz and feldspar, imbedded in a very compact groundmass [235].<sup>1</sup>

Through decomposition the rock assumes in some places a granular appearance, as if composed of small, worn grains,<sup>2</sup> but no corresponding microscopical structure can be seen.

<sup>1</sup> The collection numbers of particular specimens will be inclosed in brackets.

<sup>2</sup> The structure referred to is illustrated by specimens from the Shamms O'Brien [33], Robert Emmet [33a], Little Pittsburgh [32a], and Katie [33e] claims.

**Microscopical.**—The essential constituents of the White Porphyry are plagioclase, orthoclase, and quartz, developed in a remarkably uniform-grained mass, in which lie occasional crystals of one or more of the same minerals. Orthoclase seems to predominate, but never very greatly, and the chemical analysis confirms this view. Compared with the Mount Zion Porphyry, it is found that plagioclase occurs also in microlitic forms, but less abundantly, and in some of the more compact modifications may be wanting. Biotite, which was present in the Mount Zion rock, has never been seen in any of the numerous specimens of White Porphyry collected, nor was it ever noticed in the field, notwithstanding the fact that much of the rock seems quite fresh, judging from the condition of the feldspars. As the White Porphyry seems in all other respects to be very closely allied to the variety mentioned, it is to be particularly noted that many of the muscovite leaves are found to contain yellowish needles (rutile?) or stout crystals (anatase?) directly comparable to those resulting from the decomposition of biotite in the Mount Zion and other porphyries. It is therefore probable, in spite of the singular absence of intermediate alteration products, that a part of the muscovite in the White Porphyry came from biotite. Magnetite is found very rarely, and apatite scarcely more frequently, while zircon in minute, brilliant crystals is quite abundant.

The size of the grains is sometimes but little below the power of vision of the naked eye, and they might frequently be distinguished were it not for the decomposition of the feldspars. In numerous instances, however, usually in dikes or contact specimens, but sometimes in large masses, the texture becomes so fine that it is beyond the power of the microscope to identify separate granules as quartz or feldspar, and the mass thus becomes cryptocrystalline. In all such cases the structure remains evenly granular, there being no tendency towards a development of indistinct fibrous matter, nor does any portion appear amorphous, or, more correctly, isotropic. A few minute, irregular inclusions are usually visible in the larger quartz grains, some of them being undoubtedly fluid, while the others are not recognizable. No glass is determinable, and the minute, dark interpositions in the feldspar are probably secondary—forerunners of the coming decomposition.

**Alteration.**—Here, as in the Mount Zion rock, the conditions have favored the production of muscovite from all changeable constituents. Only in comparatively rare cases do calcite and kaolin appear. Many of the specimens collected are very much altered and show when examined in polarized light under the microscope a number of irregular quartz grains, imbedded in a brilliant, variegated mass of minute muscovite leaves. Little aggregates representing the original microlites of plagioclase penetrate the quartz grains in every direction. It is owing to this decomposition that the quartz is ordinarily invisible in hand specimens, as the muscovite leaves envelope each grain so closely that fracture does not separate them. The leaves of muscovite are so very small that the characteristic luster is seldom detected without close examination.

**Chemical composition of Mount Zion and White Porphyries.**—Analysis I, below, was made by L. G. Eakins, upon a fresh specimen of Mount Zion Porphyry from the Little Harry shaft, Prospect Mountain [24a]. Analysis II by W. F. Hillebrand, upon a typical specimen of White Porphyry from the quarry in California gulch at

the southwest base of Iron Hill [27*p*]. The specimen is no longer fresh, but it is not in an advanced stage of decomposition. It was taken as a representative of the main sheet near Leadville.

	I.	II.
SiO <sub>2</sub> .....	73.50	70.74
Al <sub>2</sub> O <sub>3</sub> .....	14.87	14.68
Fe <sub>2</sub> O <sub>3</sub> .....	.05	.09
FeO .....	.42	.58
MnO .....	.03	.06
CaO .....	2.14	4.12
BaO .....		.03
SrO .....	Trace	Trace
MgO .....	.29	.28
K <sub>2</sub> O .....	3.56	2.59
Na <sub>2</sub> O .....	3.46	2.29
H <sub>2</sub> O .....	.90	2.09
CO <sub>2</sub> .....		2.14
Cl .....		Trace
P <sub>2</sub> O <sub>5</sub> .....	None	
Total .....	100.12	100.29
Specific gravity .....		2.680

The specific gravity of II was taken at 16° C. By special test in the White Porphyry a very small amount of lead was found, = 0.003 per cent. of PbO (Part II, Chap. VI). No CO<sub>2</sub> was found in I; that in II, taken together with the increased percentage of CaO, indicates the presence of calcite, which is probably an infiltration product, as there are dolomite bodies in the neighborhood. The close agreement of these analyses is such as might have been expected from the preceding descriptions and confirms the views expressed as to the close relationship of the two rocks.

#### PYRITIFEROUS PORPHYRY.

This porphyry, so called on account of the remarkable amount of pyrite invariably found disseminated through its mass, owes its importance principally to its supposed connection with the ore deposits of Leadville.

Its geographical extent is limited to the district shown upon the map of Leadville and vicinity, where it seems to occupy a stratigraphical position, which to the north is filled by the Gray and to the east by the Sacramento Porphyry. From the latter it is distinguished in field appearance by its almost universally decomposed condition, and in its constituents by a relatively small proportion of plagioclase; from the former, in addition, by the absence of large crystals of orthoclase, and from both by the want of hornblende.

As a type, will be taken the unusually fresh rock occurring in White's gulch between the Printer Girl and Golden Edge claims [87]. It has a distinct porphyritic structure, showing numerous white feldspar crystals, with quartz, biotite, and pyrite as other recognizable constituents. Altered feldspars are nearly indistinguish-

able from the white groundmass, and plagioclase is but seldom identifiable with the naked eye. There are no large feldspar crystals, as in the Gray Porphyry. Quartz occurs most frequently in irregular fragments and rarely contains bays of the groundmass. Biotite appears in distinct leaves, usually altered to a green chloritic substance. Through a nearly parallel arrangement of its leaves a stratified appearance is produced in some cases. Before disintegration of the rock, the place of the biotite is often occupied by ocher derived from the decomposition of pyrite. The latter mineral is scattered through the whole rock, but concentrated upon fissure planes by secondary processes. Galena appears locally in small quantity, but only on fissure planes. Some specimens contain irregular fragments of other rocks, chiefly quartzites of the Weber Grits formation.

**Microscopical.**—No additional original constituent is shown by the microscope, with the exception of minute crystals of zircon. Apatite, so seldom wanting in rocks of this class, has not been identified in the Pyritiferous Porphyry. Pyrite takes the place of magnetite and seems to be an original constituent. Its particles are included in quartz and appear in arms of the groundmass, which penetrate or separate quartz grains. It is also seen imbedded in biotite and is scattered through the groundmass in the manner characteristic of the original ore minerals in similar rocks. Few of the feldspars are entirely fresh and most of them are replaced by very fine aggregates of muscovite or kaolin. Plagioclase is identifiable in rare cases and was undoubtedly much subordinate to orthoclase in the fresh rock. In the freshest specimen obtained, chemical analysis showed 4.62 per cent. of potash and 2.91 per cent. of soda. Quartz appears in angular grains which are sometimes fractured and show parts of but slightly different optical orientation, separated by thin arms of the groundmass. Fluid inclusions are abundant in many grains, usually with but little fluid, while empty pores are also numerous; but none of glass was seen. Biotite is altered to chlorite or allied products, with a separation of yellow needles and tabular crystals, presumably rutile and anatase, respectively.

The groundmass never reaches the coarseness of grain common in other porphyries of the region. It is always very finely and evenly granular, never allowing a distinction of quartz and feldspar.

#### MOSQUITO PORPHYRY.

This type of quartz-porphyry, found in several distinct bodies and exhibiting in all a marked uniformity in structure and composition, has been named from its principal observed occurrence in the North Mosquito amphitheater [98]. All the bodies are dikes in the Archean, and besides the locality mentioned the rock was seen upon the north wall of Mount Lincoln [97] and in Cameron amphitheater [96], in the latter case penetrating sedimentary beds.

It is a light gray rock of fine grain, whose most prominent constituent is quartz in clear, irregular grains, which seldom exceed 0.5<sup>cm</sup> in diameter. Other recognizable elements are biotite in small leaves, not abundant, and minute feldspars, which can scarcely be distinguished from the light groundmass. A brilliant, black ore in small specks is abundant. Glistening hexagonal prisms of what the microscope proves to be apatite are often seen, upon close examination.

**Microscopical.**—Zircon, ilmenite, pyrite, specular hematite, and probably magnetite are present in small quantity, a diversity in such constituents seldom seen in rocks of this region. Apatite, noticeable even macroscopically, is developed in stout prisms, with many minute inclusions, producing the dusty appearance often described. No other rock of the range exhibits a similar development of this mineral.

Biotite is shown in various stages of decomposition, chlorite being the first product, which sometimes gives way to epidote, or, as is clear in many cases, to a micaceous mineral apparently identical with the muscovite which is formed from adjacent orthoclase. Accompaniments of this change are yellow needles, presumably rutile, while the iron of the chlorite either is carried away or separates out in glistening black ore particles, thought to be specular hematite.

Of the feldspars, orthoclase seems to predominate slightly. Plagioclase is present both in crystals and in the groundmass, where its small microlites are much more prominent than usual. Quartz is regularly but rather sparingly present in large grains, seldom showing crystal outline and containing numerous small fluid inclusions, while none of glass was observed. A microcrystalline, granular mixture of quartz and two feldspars, with but very little primary mica, makes up the groundmass.

Chemical analysis shows 68.01 per cent. of silica, 4.36 per cent. of potash, and 4.26 per cent. of soda. The alkalis are rather more nearly balanced than one would suppose them to be from the microscopical examination.

#### LINCOLN PORPHYRY.

This rock is the most important of the varieties belonging to the second division of the quartz-porphyrines of the district, namely, those in which the porphyritic structure is macroscopically very plain. It has been called the Lincoln Porphyry from the fact that it is best developed in and about the mass of Mount Lincoln, forming the extreme summit of that peak, and in this once important mining district bearing approximately the same relation to the ore deposits which near Leadville is assumed by the White Porphyry. As will be shown later, it is very closely allied to the Leadville Gray Porphyry and has intimate connection with the Eagle River Porphyry and other rocks of the adjoining district upon the north. In the following description will be condensed the observations upon twenty specimens collected at different places. Deviations from the type rock of Mount Lincoln will be specially noted.

**Macroscopical.**—The essential constituents are quartz, orthoclase, plagioclase, and biotite, all occurring in distinct crystals and imbedded in a compact groundmass of varying importance. A part of the orthoclase appears in large, stout crystals, frequently two inches in length, usually pinkish in color, and so fresh and glassy as to resemble markedly the sanidine of younger rocks. They are often Carlsbad twins and contain noticeable inclusions of biotite leaves. For most occurrences of the porphyry these large orthoclase crystals are eminently characteristic, though their development has been hindered in some cases, particularly in dikes and small masses. In some of these instances small crystals of pinkish color are plainly more numerous.



than in the type rock, but in others they cannot be well distinguished from the triclinic feldspar. Plagioclase is always very abundant in white individuals, seemingly less fresh than the orthoclase, although a striation can often be seen on the basal cleavage surfaces. Biotite occurs in small hexagonal leaves, which are sparingly but uniformly scattered through the whole. They are seldom fresh and usually appear to be changed into a green chloritic mineral. The quartz appears as a prominent macroscopical constituent, showing, as a rule, a development of pyramidal planes, to which the prism is occasionally added.<sup>1</sup> The groundmass is dense and homogeneous in appearance, usually grayish in color in fresh rocks, and very distinct. Only occasionally does it become subordinate. Ore particles are plainly distinguishable in it.

Specimens of the rock obtained from exposed surfaces of high mountains are usually bleached and light-gray in color, slightly stained by hydrous oxide of iron, while in tunnels and mine workings the rock is generally greenish through the chloritic decomposition products of the biotite.

**Microscopical.**—The microscopical examination reveals the following as original constituents, named in order of formation, viz: Allanite, zircon, magnetite, titanite, apatite, biotite, plagioclase, orthoclase, and quartz. All the minerals named occur in more or less perfect crystal form and are imbedded in a granular groundmass, consisting of plagioclase, orthoclase, and quartz. The amount of plagioclase in the groundmass is doubtless small, for it is so abundant in the form of imbedded crystals that but little substance could have remained for the second generation. The size of the grains in the groundmass is so small that one cannot well distinguish between quartz and orthoclase, but the holocrystalline nature is evident. No microfelsitic or glassy matter has been found in any rock of this type.

Of the accessory constituents the most noteworthy is *allanite*, which appears very sparingly but constantly in this and other rocks of the Mosquito Range and adjoining regions. It is apparently the first mineral formed, or is perhaps contemporaneous with zircon, these two minerals penetrating even magnetite and apatite. During the first study of these rocks the nature of this mineral was not determined, but, through the subsequent detailed investigation of a similar porphyry of the Ten-Mile mining district, enough was isolated by means of the Thoulet solution to allow of chemical analysis. The analysis, made by W. F. Hillebrand, was not completed, owing to accident, but it established the presence of Ce and La with the absence of Di, while  $\text{Fe}_2\text{O}_3$  and  $\text{SiO}_2$  were the remaining constituents of note. At about the same time Mr. Joseph P. Iddings, of the U. S. Geological Survey, determined the same mineral crystallographically in various rocks of the Great Basin in Nevada. As a rule the allanite is seldom macroscopically visible in the rocks of the Mosquito Range, while it is quite noticeable in those of the Ten-Mile region. It appears in small prisms of maximum length of about 5<sup>mm</sup>, has a brilliant dark resinous luster, and when decomposed stains the surrounding zone in reddish-brown shades. The chance sections show a transparent, yellowish-brown mineral, with no distinct cleavage. The faces developed seem probably referable to  $\infty P$ ,  $\infty P\bar{\infty}$ ,  $0P$ , and  $+P\bar{\infty}$ . It is often twinned, possibly parallel  $\infty P\bar{\infty}$ , as by epidote, and in several sections which

<sup>1</sup> On the ridge east of Hoosier pass the outcrop of a porphyry sheet is marked by quartz crystals which have weathered out of the underlying rock and which show both pyramid and prism.

seemed to lie approximately parallel to  $\infty P \infty$  extinction took place at  $35^{\circ}$  to  $38^{\circ}$  from the vertical axis. Pleochroism distinct, the color varying from light to dark shades of yellowish brown.

Zircon is abundant in minute clear crystals. Fig. 3, Plate XXI, shows two zircon crystals of characteristic form included in a quartz grain of a Lincoln Porphyry. Titanite was seen in but one or two specimens, and then very sparingly. Magnetite and apatite occur as usual in such rocks. Biotite frequently includes apatite and zircon and may be penetrated by allanite. It is otherwise interesting from its alteration products, which will be discussed below.

The plagioclase, which is so prominently developed in crystals, is probably an oligoclase, judging from the extinction in the zone perpendicular to the laminae, the direction being always within the limits of oligoclase. Orthoclase is seldom met with among the crystals of medium size, being present in larger individuals or in the irregular grains of the groundmass, where it presents nothing noteworthy. The significance of this development is pointed out later.

The large quartz grains and crystals contain a few fluid inclusions of irregular shape, and bays of granular groundmass penetrate them without any very marked change in texture of the mass. Glass inclusions are very rare in any specimens of the Lincoln Porphyry and never have been noticed in the type rock of Mount Lincoln. Quartz crystals have frequently exerted an influence upon grains of the same mineral in the adjoining groundmass, which have within a narrow zone the same optical orientation as the crystal. There is no regular relation of the quartz to the orthoclase within this zone.

Alteration.—Biotite is usually more or less altered and presents different products under different circumstances. In a specimen from the head of Clinton gulch, Summit County, the chief product is a micaceous mineral, seemingly muscovite, which contains numerous needles of rutile. In other cases chlorite is first formed, and this is also accompanied by yellowish needles, or by irregular paler grains of undeterminable nature, which resemble titanite or at times anatase. Epidote seems to replace the chlorite, or in other cases to come directly from the biotite without any intermediate stage. The feldspars give place to an aggregate of muscovite leaves in most cases, but calcite is frequently seen as a product from plagioclase and epidote, also, may be often found resulting from the alteration of the triclinic feldspar. As in some of the other types to be described epidote is very commonly a result of alteration of pure feldspar, there appears no good reason for regarding it as induced by the presence of assumed inclusions in the case of the Lincoln Porphyry. Secondary chlorite is sometimes deposited throughout the groundmass, giving a green color to the rock.

#### GRAY PORPHYRY.

This rock, which occurs in the vicinity of Leadville, is the nearest relative of the Lincoln type. It is, however, directly connected with a porphyry which has its chief vent of eruption and largest masses in the adjoining region to the north, at the headwaters of the Eagle River. This latter type will be fully treated in the report upon the geology of the Ten-Mile district, and, as other allied rocks can there be drawn into the discussion, the present description will not go deeply into a comparison of types.

The Gray Porphyry is seldom fresh, as it occurs in the region adjacent to the ore deposits, where agencies of alteration have been active, and presents usually a greenish-gray rock, showing numerous crystals imbedded in a prominent groundmass. The minerals are the same as those of the Lincoln Porphyry, viz, large orthoclase, small and numerous plagioclase, and biotite crystals. In the mines the rock is so bleached that even with its original large crystals, it is not easily distinguished from the White Porphyry. The quartz contains large bays or penetrating arms of the groundmass.

*Microscopical.*—One never-failing and striking peculiarity of this, in distinction to the Lincoln type, is the presence of outlines of a former constituent of the rock, which would seem to belong to hornblende, although no trace of that mineral in fresh condition could be found. These outlines are usually marked by dark grains, and inclose a fine-grained, grayish decomposition product, which acts very feebly in polarized light. They are not wanting in any slide examined, and are always of the same appearance, even when other minerals are entirely fresh.

The feldspars of the Gray Porphyry, unlike those of the Lincoln Porphyry, contain numerous fluid inclusions, which are generally arranged parallel to the chief cleavage planes. Besides these, there are many irregular interpositions, either devitrified glass inclusions or portions of the groundmass in a less crystalline state than it now presents in the main mass of the rock. They are light reddish-brown in color, and plentiful in most of the small crystals. Distinct glass inclusions, although not noticed in any feldspars, are very characteristic of the quartz grains. They are often sharply negative crystalline in form, and sometimes show devitrification; others are spherical, and in these it can often be seen that from opposite poles, which probably lie in the vertical axis of the quartz grains, cracks penetrate the sphere in three planes, cutting each other at about 60°. If the sphere be cut by the section at right angles to the axis uniting these poles and near one of them, there results a delicate six-armed figure, which appears as if contained in the quartz itself. The groundmass, though holocrystalline, is much finer-grained than that of the Lincoln Porphyry, and shows a tendency to an irregular intergrowth of quartz and feldspar.

*Occurrence.*—Gray Porphyry is quite limited in distribution, being confined to the immediate vicinity of Leadville, and to the region northwest of that point. As has been described in detail (p. 80), it occurs chiefly in one large sheet, with numerous offshoots, and the large sheet has been directly traced to a connection with an immense body at the headwaters of the Eagle River. The hornblende of the Gray Porphyry is considered analogous to the crystals of that mineral observed in small dikes which are offshoots from the Eagle River mass.

*Chemical composition of the Lincoln and Gray Porphyries.*—The following rock analyses were made by W. F. Hillebrand.

I is of Lincoln Porphyry, summit of Mount Lincoln [75]. It is quite fresh in appearance, although showing some muscovite, calcite, and chlorite, when examined microscopically.

II is of Gray Porphyry, Ouota shaft, Johnson gulch, near Leadville [59a], fresh appearing, but somewhat altered, with the same products as in the former rock.

	I.	II.
SiO <sub>2</sub> .....	66.45	68.10
TiO <sub>2</sub> .....	0.10	0.07
Al <sub>2</sub> O <sub>3</sub> .....	15.84	14.97
Fe <sub>2</sub> O <sub>3</sub> .....	2.59	2.78
FeO .....	1.43	1.10
MnO .....	0.09	0.09
CaO .....	2.90	3.04
SrO .....	0.07	0.08
MgO .....	1.21	1.10
K <sub>2</sub> O .....	2.69	2.93
Na <sub>2</sub> O .....	3.92	3.46
Li <sub>2</sub> O .....	Trace	
H <sub>2</sub> O .....	0.84	1.28
CO <sub>2</sub> .....	1.35	0.92
P <sub>2</sub> O <sub>5</sub> .....	0.36	0.16
Cl .....	0.05	0.03
Total .....	100.09	100.11
Specific gravity, 10° C ....	2.670	2.636

The relative amounts of soda and potash indicate an abundant soda-lime feldspar. The titanite oxide found corresponds to the suggestion that the yellow needles in the decomposed biotite are rutile, for the magnetite does not give signs of an intermixture of titanite iron through its alteration products. The presence of strontia in determinable quantities is unusual and worthy of note; it doubtless comes from the plagioclase. Instances of its determination in rocks are rare,<sup>1</sup> though it would probably be found in many cases if sought for.

Although the large pink or white orthoclase crystals are characteristic of most of the occurrences referred to the Lincoln and Gray Porphyries, still a number of cases were found where the rock seemed identical with these types in every respect, excepting that the large crystals were wanting. In some bodies of rock, moreover, the large crystals were by no means equally distributed. It seemed therefore desirable to ascertain more definitely the source of the alkalis in the rocks analyzed. In each case enough of the large orthoclase crystals had been included in the material used for analysis to give average results.

In the mass of Mount Lincoln a dike of rock was found which was considered as a representative of the Lincoln Porphyry [78], although it was darker, more compact, and contained none of the large pink orthoclase crystals. Alkali determinations gave 2.42 per cent. of potash and 3.15 per cent. of soda, very nearly the same ratio as in the type rock. There was also found 64.16 per cent. of silica. The reduced amounts of all these are doubtless due to the increased quantity of biotite and of ore in this dike rock.

In the next place the Gray Porphyry, of which the complete analysis had been made, was subjected to further investigation. Alkali determinations were made in the

<sup>1</sup> Streng, Neues Jahrbuch für Mineralogie, etc., p. 537, 1867.

mass of the rock, carefully avoiding the large pink crystals, with the result of 2.95 per cent. of potash and 2.61 per cent. of soda. As small flakes were used for this purpose, it is probable that the groundmass was present in abnormal quantity, thus causing a relative increase in potash, even while excluding the large orthoclase crystals. Plagioclase was found to be much subordinate in the groundmass, as stated above.

The large pink orthoclase crystals themselves were then analyzed, with the result:

SiO <sub>2</sub> .....	62.22
Al <sub>2</sub> O <sub>3</sub> .....	20.33
CaO .....	2.95
K <sub>2</sub> O .....	8.31
Na <sub>2</sub> O .....	3.45
Li <sub>2</sub> O .....	Trace
Ign .....	1.90
Loss .....	.84
	100.00

Careful examination of the material used showed only a few specks of biotite, but some soda-lime feldspar must have been present, judging from the large amount of lime found. A determination in another clear crystal chosen for its apparent purity gave nearly 3 per cent. of lime again. The loss is thought by the analyst, Mr. Hillebrand, to be chiefly soda.

## DIORITE.

Of the distinctly plagioclastic rocks of the region but very few are granular in structure, the great majority being diorite-porphyrines, or porphyrites, as they will hereafter be designated. The three granular diorites found, represent three very distinct varieties, one of them being the only pyroxene-bearing rock occurring within the area of the map. All occur, moreover, in the same gulch, and quite near each other.

## QUARTZ-MICA-DIORITE.

This rock occurs on the south side of Buckskin gulch, Park County, as a broad dike, forming for some distance the southeast wall of one of the elevated amphitheatres on Loveland Hill, and thence projecting as a knoll into the gulch opposite the Red amphitheater. It disappears under loose material before reaching the stream bed, and no continuation of the dike on the north side of the gulch was observed. The rock has a fine, evenly-grained structure, with feldspar and quartz strongly predominating over the small, irregular leaves of biotite.

Microscopical examination shows zircon, magnetite, apatite, biotite, plagioclase, orthoclase, and quartz as original constituents. None of the essential minerals is well developed in crystal form and none shows noteworthy peculiarities. Plagioclase is largely in excess over the orthoclase and quartz is quite abundant. All are quite fresh, the biotite alone showing incipient decomposition [117].

## HORNBLÉNDE-DIORITE.

A broad dike crossing the head of Buckskin gulch from Democrat Mountain in a nearly east-and-west direction was found to consist of a very simple, normal diorite

[116]. It is fine-grained, yet shows distinctly to the naked eye all its prominent constituents. Feldspar, a large part of which is clearly plagioclase, subordinate quartz, hornblende in prisms with occasional terminations, a little brown biotite, yellow titanite, and dark ore grains are all easily recognized. The microscope shows zircon and apatite in addition, while chlorite and epidote are seen to result from the alteration of both biotite and hornblende. Muscovite forms in the orthoclase, which here seems much more attacked than the plagioclase. There is no groundmass and of the essential constituents only hornblende is developed in crystal form.

A very similar diorite was obtained from a prospect tunnel in French gulch, Lake County [115], in which pyrite replaces magnetite as the ore and zircon and titanite are very abundantly developed. Biotite and quartz are even less prominent than in the preceding rock.

#### AUGITE-BEARING DIORITE.

In the Red amphitheater, on the northeast side of Buckskin gulch, there occurs a dike of a darker, finer-grained diorite than either of the preceding types [118]. Hornblende, biotite, plagioclase, and a little quartz may be macroscopically detected. The microscope shows zircon, titanite, magnetite, hematite, apatite, biotite, augite, hornblende, plagioclase, orthoclase, and quartz. Augite appears most abundantly in the freshest specimen, and certainly undergoes alteration to green hornblende, which, though not fibrous, like typical uralite, is still by no means so compact as the common dioritic hornblende. It is not possible, from the specimens examined, to say with certainty that any of the hornblende is original, although the association of the minerals in the freshest specimens is such as to indicate a contemporaneous formation of biotite, augite, and hornblende. The latter two occur in irregular grains and the augite has none of the pinkish tinge common to it when appearing in diorite. This rock is remarkable as the only eruptive of the district in which augite has been found.

Plagioclase appears abundantly in small grains, while orthoclase and quartz form the cementing material. Chlorite and epidote result from the alteration of hornblende and biotite; muscovite and calcite, from the feldspars.

#### PORPHYRITE.

Under this heading will be discussed a large number of distinct occurrences, which, unlike those of the quartz-porphyrines, belong for the most part to small rock masses. There are in this group no markedly prevailing types to which the different rocks can be assigned, and the chief interest here lies in noting the great variations possible, both in structure and composition, in what are practically equivalent masses. One distinction, however, is feasible, viz, that between a variable subgroup, in which a triclinic feldspar is evidently strongly predominant, and a few rocks occurring in larger masses, in which orthoclase is also prominent and which seem at first glance more nearly related to the quartz-porphyrines than to the marked plagioclase rocks of the first division. These latter types are referred to in the main report as quartz-porphyrines, and are so represented upon the map. They are called by the local names Sacramento Porphyry and Silverheels Porphyry. Later investigation has shown them to be plagioclastic rocks, and as such they will here be treated. In describing them the general and variable group will first be considered and then the local types.

## PRINCIPAL GROUP.

The characteristic primary constituents of these rocks are the minerals zircon, allanite, apatite, magnetite, biotite, hornblende, plagioclase, orthoclase, and quartz. To these, as occasional accessories, may be added ilmenite and pyrite. All the common non-essential elements are developed in the ordinary way, and none is so abundant or so rare as to deserve comment. Allanite is not always present in the thin sections examined, but its observed distribution among different types is such as to warrant the belief that it is sporadically present in all the rock masses of this group.

Feldspars.—All crystals of the first period of consolidation which have been identified are plagioclase, with but one possible exception, referred to later (p. 339). Orthoclase may be sparingly developed in this way in a few cases, but the freshness of the plagioclase in nearly all specimens collected and the ease with which the striation can be seen upon the basal cleavage plane make it certain that a monoclinic feldspar must be very rare. In the groundmass, on the other hand, plagioclase is not visibly present at all in many cases, while orthoclase is very abundant.

The plagioclase crystals are small, white, stout in form, and correspond exactly to those described in the quartz-porphyrines. They are chemically near oligoclase, judging from the optical properties, for the maximum observed extinction in the zone perpendicular to the usual twinning plane is but  $20^\circ$ . In a number of crystals twinning according to the Carlsbad law is apparently combined with that of the albite law, as, for example, in one section, falling at right angles to the brachypinacoid, there are 20 laminae, of which five pairs extinguish sharply at  $8^\circ 45'$ , the other five pairs at  $6^\circ$  from the twinning plane. In a few cases more than two directions of extinction were noticed in sections apparently lying in the macrodiagonal zone. In one crystal laminae were found extinguishing at  $1^\circ$ ,  $4^\circ 30'$ ,  $8^\circ$ ,  $13^\circ$ , and  $20^\circ$ , several pairs showing the last two values. A satisfactory explanation for this action has not been found. It may be that laminae of different feldspars are here intergrown, but such a conclusion must be supported by further data than are here available.

A delicate zonal structure is occasionally seen in plagioclase crystals, but the slightly varying angles of extinction do not indicate any pronounced changes in basicity of the different zones.

Biotite.—Biotite appears as a constituent in three distinct forms: as macroscopic hexagonal leaves, in aggregates of small irregular flakes, and as minute leaflets in the groundmass. The large leaves are brown when fresh and often exhibit ragged edges when seen under the microscope, caused by the attachment of many flakes corresponding to those in the groundmass. Allanite, zircon, magnetite, and apatite penetrate the larger leaves. The tiny leaflets which enter at times richly into the composition of the groundmass are irregular in shape and rarely over  $0.03^{\text{mm}}$  in diameter, sometimes sinking to a minuteness requiring the highest power of the microscope to resolve them into separate flakes. They are greenish in color and at first glance it is not easy to discover their nature as mica; but their marked pleochroism and strong absorption in proper position renders their character certain. These flakes of green mica are often arranged one after another, partially overlapping, making needle-like aggregations, easily mistaken for hornblende with a low magnifying power.

Hornblende.—The hornblende is compact, of a green color in ordinary light, and generally presents quite well-defined crystals, the faces  $\infty P$ ,  $\infty P \infty$ ,  $0P$ , and  $P$  being

often visible on macroscopic crystals. It occurs either as a macroscopic element of the rock, in the form of minute needles in the groundmass, or, lastly, in clusters of small irregular individuals, and then usually associated with biotite leaves.

The small needles are sometimes well terminated (see Fig. 3, Plate XX). Still it is the rule to find the ends irregular, while the prism is sharply defined (see Fig. 4, Plate XX). The pleochroism is well marked, and the maximal angle of extinction in the prismatic zone is nearly  $18^\circ$ , measured from the vertical axis. Twinning parallel to  $\infty P \infty$  is common and is frequently polysynthetic.

The hornblende occasionally includes crystals of apatite, magnetite, rarely biotite, and clear microlites of zircon. It is commonly very fresh, and when decomposition has begun the first product is usually chlorite, from which epidote is formed.

Quartz.—There are but few rocks of this kind in which quartz is prominent as a macroscopic constituent. In some of these, usually the more acid ones, it forms well-defined crystals, but it is more common to see it in rounded grains, seemingly quite variable in quantity, in occurrences which are otherwise nearly identical. These rounded particles undoubtedly represent partially remelted crystals of the first generation, and their variability is here not remarkable. The chief development of the quartz is, as perfectly natural, in the groundmass, with orthoclase. Inclusions are not abundant in any of the crystals, though all earlier minerals do penetrate it in observed instances. Glass inclusions have never been found and those with fluid contents are rare. The groundmass seldom penetrates the large crystals.

Groundmass.—The groundmass of those porphyrites which contain hornblende and biotite mainly as macroscopic elements is very uniform in constitution and structure. It consists of an evenly granular mixture of quartz and feldspar, with small octahedrons of magnetite scattered through it. The feldspar is seldom definitely determinable as such, but its presence is inferred from a formation of muscovite, where the rock is much altered, and because the quartz grains, through their stronger polarization, stand out in contrast to the rest of the colorless groundmass. By far the greater part of this feldspar is monoclinic, for plagioclase was observed to enter into the composition of the groundmass in but few cases, and then in the form of thin plates, quite distinct from the irregular grains of orthoclase. The average size of the grains of quartz and orthoclase is  $0.02^{\text{mm}}$ , so that a complete separation of these minerals is never possible. There is never a trace of microfelsitic or glassy substance, and only in contact specimens is the greater part of the groundmass cryptocrystalline. As has been mentioned above, biotite and hornblende enter into the constitution of the groundmass in very varying quantities, and only when present in great abundance do they render the mosaic of quartz and feldspar obscure. The quartz has a tendency to develop in clusters of irregular clear grains in certain cases.

The distinguishing peculiarity of a certain minor subgroup lies chiefly in the character of the groundmass. This consists principally of an intergrowth of quartz and orthoclase, according to no discernible law, now the quartz, now the orthoclase being the inclosing mineral, and their relation is only made clear between crossed nicols, when it is seen that within the limits of certain irregular patches all the quartz and all the orthoclase has each its own optical orientation. The outline of the inclosing mineral has no relation to crystal form, and this intergrowth acts throughout like the ordinary groundmass, filling the interstices between the large crystals. The macro-





Fig. 1



Fig. 2



Fig. 3



Fig 4



scopical effect of this structure is to render the groundmass much less distinct in contrast with the crystals than is the case in the types of the main group. Flakes of biotite, grains of magnetite, &c., are scattered about in this groundmass with the same irregularity as in any other.

A tendency to a micrographic-granite structure was noticed in two of the porphyrites. It seems to have been induced by the presence of the rounded quartz grains above described. Each of these is surrounded by a zone in which quartz and orthoclase are more or less regularly intergrown. The appearance, as seen under the microscope, is that of alternate fibers of quartz and orthoclase, with a more or less distinct radiate arrangement about the large quartz grain, all the quartz substance, in both granule and groundmass, having the same optical orientation. A similar phenomenon was not observed in connection with large particles of feldspars, and those portions of the groundmass showing a regular intergrowth apparently independent of any crystal may have been formerly related to a quartz grain situated just above or just below the plane of the present section.

In such a thoroughly crystalline rock a fluidal structure can only be expressed by the position of the hornblende needles or biotite leaves with reference to the large crystals. Such a relation is often observed, and it is also not rare to find hornblende crystals broken and biotite leaves folded and crumpled, attesting to movements in the partially solid rock.

Structural forms.—The greater number of the rocks observed form a continuous series whose extremes are very dissimilar, and the relationship can be most easily understood and explained with the help of the subjoined table:

Primary division.	Subdivision.		Macroscopic development.	In groundmass.
A	I	{ Biotite	In hexagonal leaves	Entirely wanting.
		{ Hornblende	Entirely wanting	Entirely wanting.
	II	{ Biotite	In isolated leaves	Entirely wanting.
		{ Hornblende	In numerous crystals	Entirely wanting.
B	III	{ Biotite	Sparingly present	Few minute leaflets.
		{ Hornblende	Abundant	Entirely wanting.
	IV	{ Biotite	Abundant	Abundant.
		{ Hornblende	Slightly predominant	Few small needles.
		{ Biotite	Rare or wanting	Sparingly present.
V	{ Hornblende	Very abundant	Very abundant.	
	{ Biotite	Numerous small leaves	Very abundant.	
C	VI	{ Biotite	Rare or wanting	Entirely wanting.
		{ Hornblende	Rare	Much subordinate to hornblende.
	VII	{ Biotite	Rare	Much subordinate to hornblende.
		{ Hornblende	Very abundant	Very abundant.

Under Division A are included rocks with a light, homogeneous appearing groundmass, containing no microscopic individuals of the basic mineral which is so prominent in macroscopic crystals, this in the one case (I) being biotite, in the other (II) hornblende. Under C, at the opposite structural extreme, where the groundmass is filled with minute flakes or needles of a dark mineral, are also two modifications, one a biotite (VI) (Fig. 1, Plate XX), the other prevailing a hornblende rock (Fig. 2, Plate XX). These are both dark and compact, showing comparatively few macro-

scopic elements, standing in marked contrast to those forms under Division A. Between these extremes, in regard to both structure and composition, are the forms embraced under B. In these the groundmass contains more or less of one or both of the dark basic minerals, and in proportion as these minerals enter into the composition of the groundmass the macroscopic elements become less distinct, thus forming a gradual transition to the Division C.

Division A.—The plagioclase usually stands out very plainly in these rocks, and it is evident that no orthoclase is present in macroscopic individuals. Quartz occurs in good crystals and rather plentifully. The groundmass is microcrystalline and possesses a very regular granular structure, its components being almost exclusively quartz and orthoclase. A dike in gneiss, near a little lake northwest of Mount Lincoln, represents the typical hornblende variety [120], while a similar dike in North Mosquito amphitheater is of the corresponding biotite rock [119]. Several occurrences at the head of Buckskin gulch are nearly allied to these type rocks.

Division B.—By far the larger number of the porphyrites in the series fall within this division. In the three subdivisions of the table, one or both of the heavier silicates appear in the groundmass as well as in larger crystals. If the groundmass minerals are regarded as belonging to a second phase of the rock's existence, one of the striking peculiarities of this division is most natural, while from another point of view it might seem strange. The peculiarity referred to is the observed independence of the dark basic silicates occurring in the groundmass, of the species which may be developed as macroscopic constituents. The formation of hornblende in numerous large crystals during the first period of consolidation does not necessarily demand that the same mineral should be developed in the second period. The changed conditions attending the final consolidation may produce biotite or hornblende, or both of them, uninfluenced, or at least uncontrolled, by the earlier crystallizations. The table above shows this, but a study of the variations in the different rocks collected makes the fact much plainer. The rock most frequently met with in all the district belongs to Type V of this division. It is the one found in the intrusive sheets on the sides of Mosquito [127] and Buckskin gulches [126], on Mount Lincoln, or in dikes in the Archean, as on Bartlett Mountain [124] and Democrat Mountain [259]. The lower figure of Plate VII, page 84, shows the macroscopical appearance of this rock very well. Hornblende crystals are frequently well terminated in this modification, and owing to the minute size of many well-shaped prisms, while all intermediate stages are also represented, it becomes difficult to decide whether there has or has not been a recurrence in the formation of hornblende prisms with good crystal form. Fig. 3, Plate XX, was designed to show both large and small prisms of hornblende with good terminal planes, but the imperfect execution of the prints leaves much to the imagination. In Fig. 4 of the same plate are shown needles of hornblende with the more common, irregular terminations.

Division C.—The compact rocks of this division are not very numerous. The two occurrences illustrating best the micaceous and hornblende varieties occur together in North Mosquito amphitheater. One of these, the biotite rock [260], was analyzed (p. 340), and its micro-structure is indicated by Fig. 1, Plate XX. Two other compact rocks deserve special mention under the next heading.

**The Arkansas Dike.**—The long straight dike at the head of the Arkansas presents some remarkable phenomena, which cannot be explained satisfactorily from the data collected in the one short visit made to that area. It is a special matter for regret that no time for further examination could be taken. This dike consists of what are regarded as two eruptions of the same magma. The older rock is fine-grained and exhibits a few small feldspars and biotite leaves as sole recognizable macroscopic constituents [130]. The younger rock [129], which cuts irregularly through the former, now on one side, now on the other, or even running along the center, is also very dark and compact in the main, but is sharply distinguished by numerous large quartz crystals and by worn and well-rounded fragments of slightly pinkish orthoclase.

A heliotype representation of this curious rock is given in the upper figure, Plate VII, natural size. These orthoclase fragments are all like pebbles, showing no trace of sharp angles. They reach a maximum observed diameter of over 5<sup>mm</sup>, and none was noticed of less than 1<sup>mm</sup>. While never glassy, they seem quite fresh, represent but one crystallographic individual each, and are in no way related to anything seen in other occurrences of the porphyrites. The quartz crystals reach a diameter of over 1<sup>mm</sup> in this rock and are always quite well-defined in crystalline form. Hornblende takes a prominent place beside the biotite in the microscopical constitution. It is a curious fact, commented upon later, that in spite of its large quartz crystals the younger porphyrite has but 59.26 per cent. SiO<sub>2</sub>, while the dark, compact, older rock contains 66.29 per cent. Repeated determinations for both rocks show similar results.

The origin of these orthoclase pebbles is very problematic. To consider them as earlier secretions of the porphyrite magma is to assume conditions to which no other rocks of the group have been subjected, judging from the total absence of such orthoclase in them. Inclusions of basic microlites would seem to be almost inevitable, if these orthoclase individuals had formed in the midst of the minerals which one must suppose to have reached consolidation before them. A thin section of one of these pebble-like fragments shows that the feldspar is common orthoclase and that it contains inclusions of magnetite, biotite, and quartz. No zircon, allanite, or apatite was seen. The included quartz grains are small and crowded with fluid inclusions, in many of which the bubble is in active motion.

From the above considerations it is difficult to reach a conclusion as to the origin of these feldspar masses. The absence of zircon and apatite and the presence of quartz with such numerous fluid inclusions seem to indicate that the mineral is not an earlier secretion of the porphyrite magma. The fact that, while rounded fragments of gneiss and granite are abundant in many dikes in the Archean, they were not found accompanying these pebbles, would seem to throw doubt upon the accidental nature of the fragments in question. Until a more thorough examination of the occurrence can be made no satisfactory conclusion seems possible.

**Chemical composition.**—The analyses given below were made by W. F. Hillebrand. Under I is given the composition of the typical hornblendic variety, occurring in thin intrusive sheets on the sides of Buckskin and Mosquito gulches. It is Type V of the table above; its macroscopical appearance is shown in Plate VII, lower figure, and its microstructure in Plate XX, Fig. 3. The specimen analyzed came from the Northern Light claim, in lower Buckskin gulch [126]. The rock as a whole is quite fresh, although the few biotite leaves and occasionally a hornblende crystal are more or less

decomposed, chlorite and calcite being the chief products. The plagioclase is still quite fresh, but some filmy calcite is scattered through the groundmass. Apatite is rather rare in this rock.

Analysis II was made upon a compact biotite rock, Type VI of the table, from North Mosquito amphitheater, where it occurs as a dike in gneiss [260]. There is no hornblende present in this rock and biotite appears mainly in numberless minute, greenish flakes. Quartz is abundant in clusters of small grains in the groundmass, but seldom reaches macroscopic dimensions. Apatite is quite abundant. Pyrite is the chief ore of the rock, accompanied by some magnetite. Except for some calcite and chlorite the rock seems to be very fresh.

	I.	II.
SiO <sub>2</sub> .....	56.62	64.81
TiO <sub>2</sub> .....		0.08
Al <sub>2</sub> O <sub>3</sub> .....	16.74	15.73
Fe <sub>2</sub> O <sub>3</sub> .....	4.94	1.68
FeO .....	3.27	2.91
MnO .....	0.15	0.08
CaO .....	7.39	4.22
SrO .....	Trace	Trace
MgO .....	4.08	2.82
K <sub>2</sub> O .....	1.97	1.43
Na <sub>2</sub> O .....	3.50	3.98
H <sub>2</sub> O .....	0.92	0.62
CO <sub>2</sub> .....	1.15	1.08
P <sub>2</sub> O <sub>5</sub> .....	Trace	0.23
Cl .....		0.04
FeS <sub>2</sub> .....		0.00 = 0.48 S.
Total .....	100.73	100.61
Specific gravity, 16° C. ....	2.768	2.740

**Discussion of analyses.**—There is far more difference between the two rocks than one would surmise from the microscopical study, but it is after all not so remarkable when one considers how little substance is actually represented by the minute flakes of biotite in contrast to that in the numerous prisms of hornblende. The difference lies chiefly in the large amount of hornblende, while the feldspars in both are plainly soda-lime-bearing varieties to a very large extent.

In order to test the influence of the amount of hornblende present, as indicated by the macroscopical appearance of the rock, special silica determinations were made by Mr. Hillebrand upon various types. First, two rocks having closely the habit of that furnishing Analysis I, but occurring as dikes in the Archean, one in Ten-Mile amphitheater [125], the other on the east wall of Arkansas amphitheater [131], were tested, and yielded, respectively, 57.76 per cent. and 57.33 per cent. SiO<sub>2</sub>, figures agreeing quite closely with those of the analysis. Secondly, the compact hornblendic rock from North Mosquito amphitheater [132], which occurs side by side with the corresponding biotite rock (Analysis II), was found to contain 54.54 per cent. SiO<sub>2</sub>. Thirdly, a rock from the extreme head of Buckskin gulch [121], which contained very little hornblende in the groundmass and had a number of the rounded quartz grains macro-

scopically visible, proved to carry 65.73 per cent.  $\text{SiO}_2$ . The range in silica is thus more than 10 per cent., and it is chiefly affected by the amount of hornblende present in the rock.

## SACRAMENTO PORPHYRITE.

This rock, which was at first classed as a quartz-porphry and is so represented on the map, occurs in a large mass at the head of Big Sacramento gulch, whence intrusive bodies extend to the north and to the southeast.

Description.—In structure this rock resembles those modifications of the Lincoln Porphyry in which the formation of the large orthoclase crystals has been hindered. It shows many white plagioclase crystals of the usual stout habit and a number of smaller, less distinct individuals which are less fresh, most of them being orthoclase. Both biotite and hornblende are present in distinct individuals, and quartz occurs in round grains, which are not very plentiful. The groundmass containing these elements is subordinate but yet distinct. It contains pyrite and magnetite, and a sufficient number of small biotite leaves to be dark-gray in color, when fresh. Chloritic decomposition products render it darker in most specimens collected. Epidote, which is often prominent in more or less altered specimens, will be spoken of below.

With the microscope it is found that zircon, allanite, apatite, and titanite iron, the last recognized by cleavage and alteration products, are further components of the rock. Allanite is not so plentiful as in some other types described, but it is observed in one or two slides and is probably a regular but sparsely distributed constituent.

The microscope shows that plagioclase is developed almost exclusively in the form of porphyritic crystals and that but few of these are certainly orthoclase, although the latter mineral forms with quartz nearly the entire groundmass, the dark silicates seldom appearing as constituent particles in this later product of consolidation. Orthoclase is usually more decomposed than plagioclase, being cloudy after the manner commonly seen in much older rocks. The majority of the plagioclase crystals are clear in the center, but show incipient decomposition in the outer zones. The laminae composing them are either broad or very narrow and the maximum angle of extinction in the macrodiagonal zone is  $20^\circ$ , indicating that varieties more basic than oligoclase are rare if present at all.

Hornblende and biotite have a thoroughly normal appearance, and are only interesting through their decomposition products, to be considered below. Inclusions of the early accessory constituents are a matter of course in all the large crystals, but they are never abundant and are never accompanied by glass, so far as observed. Fluid inclusions occur sparingly in quartz and feldspar.

Decomposition products.—Noteworthy facts concerning the decomposition of rock-building minerals may be observed in the Sacramento Porphyrite. The specimens collected are divisible into two classes, the one showing a bleached rock, the other containing macroscopically developed epidote. In the latter rocks [83-85] the microscope shows a more or less marked tendency to the formation of epidote from both feldspars, as well as from biotite and hornblende. In the last two minerals a dark, strongly pleochroic chlorite is the forerunner of the epidote, while in the feldspar no intermediate stage of any kind can be detected. Muscovite and calcite, the common products of alteration in feldspars, are here but slightly developed.

In the second class mentioned the processes of decomposition have produced a light-colored rock, in which the biotite is replaced by a light, straw-colored substance with silvery luster, while hornblende and ore particles have almost entirely disappeared. The microscope shows that decomposition has from the beginning taken an entirely different course from that just described, although here, as there, the tendency has been to the formation of a particular mineral, that mineral being muscovite instead of epidote. Muscovite resulting from the decomposition of biotite has been described (p. 324) in the case of the Mount Zion Porphyry, and the present instance is very similar. The muscovite is filled with minute, pale-yellowish needles and grains (rutile?), which cause the macroscopically visible tinge of color. That this mineral is really muscovite it may be difficult to prove beyond all dispute, but the feldspars in the same specimen are almost entirely altered to an apparently identical substance, with some calcite, while no chlorite or epidote is found, showing that conditions favorable to the formation of muscovite certainly existed. In general it can be stated that those specimens in which the development of muscovite is most distinct occurred in masses covered by drift or exposed in the workings of mines [86], while those containing epidote are from more exposed positions, usually above timber-line. The observations are, however, too few to be considered as indicating any rule in the matter.

Chemical data.—A silica determination proves that quartz must be prominent in the groundmass, as the quartz macroscopically visible is much less than in the Lincoln Porphyry, while the amount of silica found, 65.08 per cent., is but little less than that in the latter rock, viz, 66.45 per cent. [85a]. The Sacramento Porphyrite also contains 3.55 per cent. of soda to 2.57 per cent. of potash [85a], which confirms the classification as a plagioclase rock.

#### SILVERHEELS PORPHYRITE.

Occurrence and previous classification.—The intrusive sheets of eruptive rock occurring in Mount Silverheels, two of which appear in the northeastern part of the Mosquito Range map, belong to a rock which is not easily classified. It is colored as rhyolite upon the Hayden Atlas of Colorado, and called “(trachyte?)” by A. C. Peale in his report upon the region.<sup>1</sup> Unfortunately, its relations were not at first correctly understood by the present writer, and consequently the rock is colored upon the map as quartz-porphyry, while he now regards it as a plagioclastic rock and as belonging to the series of porphyrites.

Description.—This rock is of a greenish or gray color and very fine grained, but it still exhibits a distinct porphyritic structure when not too much decomposed. Its macroscopically visible constituents are feldspar, biotite, hornblende, and, sparingly, quartz, all of them in very small individuals, seldom exceeding 3<sup>mm</sup> in diameter. The groundmass is usually obscured by chloritic decomposition products. Microscopical study shows the usual accessory minerals, including allanite and pyrite.

With regard to the feldspar crystals it is difficult to decide which may have been predominant from simple microscopical study, for many of them are entirely decomposed and the mixture of calcite and muscovite resulting in all cases does not give a

<sup>1</sup> Annual Report United States Geological and Geographical Survey of Territories, 1873, pp. 214-216.



certain clew. An alkali determination in one of the freshest specimens [109] yielded  $\text{Na}_2\text{O}$  4.08 per cent. and  $\text{K}_2\text{O}$  2.70 per cent., which must be decisive in confirming the present classification, for it is to be expected from analogy with the fresher rocks previously described that the larger part of the soda will be contained in the porphyritic crystals of the first generation, while the potash will remain chiefly in the groundmass. When nearly balanced alkalies are, as a matter of fact, so disposed in the solid rock, the soda feldspar certainly becomes the more prominent and should determine the classification.

The groundmass is holocrystalline, in most cases coarsely microcrystalline, and is made up of quartz, orthoclase, and plagioclase, with some biotite. Its constitution is often obscured by chlorite. The amount of quartz seems less than in most porphyrites described, and a silica determination gave but 60.42 per cent. [109b]. Epidote and chlorite are the products of the decomposition of both biotite and hornblende. What seem at first sight to be included fragments of amphibolite are most probably secretions of hornblende from the magma in an earlier period of the rock's history. Biotite and some feldspar accompany the hornblende.

On the extreme southern spurs of Mount Silverheels, beyond the limits of the present map, between the forks of Crooked Creek, a variety of much more distinct porphyritic habit was found, which is colored on the Hayden map as "Porphyritic Trachyte" [108]. Its crystals reach 1<sup>cm</sup> in diameter and predominate over the light-grayish groundmass. All the elements are the same in character as in the Silverheels rock, and it can be regarded only as a modification of the same.

#### MISCELLANEOUS PORPHYRITES.

The "Green Porphyry," a peculiar fine-grained rock, was found occurring in three different places: first, as a dike, running from the northern edge of Bross amphitheater toward Mount Silverheels [98a]; secondly, on the north side of Mosquito gulch, near its mouth, interbedded in Cambrian quartzites [98]; and thirdly, as an interstratified bed on lower Loveland Hill, near the Fanny Barrett and Eagle Bird claims [98b]. It is macroscopically compact, light green in color, with an abundant chloritic decomposition product, which renders it difficult to distinguish clearly each crystal individual, although it is sometimes plain that the rock is almost wholly macrocrystalline. Quartz, feldspar, biotite, and hornblende are, however, recognizable, the latter two being much altered.

Some of the thin sections prepared show no normal groundmass at all, although a distinction can be made between certain well-crystallized elements and wholly irregular fragments. There seem to have been original crystals of feldspar, hornblende, and biotite, all quite small, while the remainder of the rock, solidifying later, was formed of the same minerals, with quartz, in irregular grains, which sometimes have reached the size of the crystals, but more frequently have not.

The feldspars are largely replaced by muscovite and calcite; the dark silicates by chlorite and epidote. Quartz is not abundant, a silica determination yielding but 63.85 per cent. A few fluid inclusions are observed in quartz and feldspar.

In connection with the above rocks should be mentioned several occurrences not to be classed under any of the described varieties, though most closely allied to the

last one [100-106]. In the hand specimen they show but little that can be identified. They are green in color and fine-grained, with some visible feldspar and biotite or hornblende, and, rarely, quartz. The principal decomposition product is chlorite, which renders the structure obscure. The microscope reveals a fully crystalline structure, in which a granular groundmass of quartz and feldspar is of varying importance. Quartz and orthoclase, intimately but irregularly intergrown, make up in some cases the greater part of the rock. Muscovite is the chief decomposition product of the feldspars and seems also to result from the alteration of biotite, after several intermediate stages.

The Green Porphyry and the ones just mentioned are now thought to be more probably porphyrites than quartz-porphyrines.

## YOUNGER ERUPTIVES.

### RHYOLITE.

Among the acid orthoclastic rocks of the district are a few occurrences plainly distinct from any that have been referred to the group of the quartz-porphyrines. Their mode of occurrence is different (see p. 194) and they possess to an eminent degree the habit formerly considered characteristic of the younger eruptives. No exact data as to age are available, but they all seem to be more recent than the period of folding and faulting.

The most important body of rhyolite is that upon the northern boundary of the region under consideration, forming the mass of Chalk Mountain. As this rock has very closely the habit of that subdivision of the rhyolites recently defined as Nevadite by Messrs. Hagne and Iddings,<sup>1</sup> that name will be applied in this description. According to the definition of the writers cited, Nevadite is a rhyolite "characterized by an abundance of porphyritic crystals imbedded in a relatively small amount of groundmass," while liparite is a rhyolite "characterized by a small number of porphyritic crystals imbedded in a relatively large amount of groundmass." These terms simply designate structural extremes in a group which is so large as to need some such treatment. They occupy about the same position as the terms "granite porphyry" and "felsite porphyry."

### CHALK MOUNTAIN NEVADITE.

**General description.**— This rock is characterized by the appearance of very numerous dark quartz crystals and clear sanidines, with but very little biotite or ore, imbedded in a light gray groundmass. On the western and eastern parts of the mountain the feldspars are nearly all small and clear, and, as in this modification there is an almost total absence of biotite and ore particles, the feldspars are scarcely distinguishable at first glance from the enveloping groundmass, which has under the lens an exceedingly fine-grained, homogeneous texture. All this only serves to bring out the more strikingly the abundant dark, smoky quartz crystals, which usually present the prism in very distinct development. They are here invariably fissured in all directions, and fractured surfaces have an unusually brilliant, vitreous luster. In this modification of the rock the quartz crystals seldom reach 1<sup>cm</sup> in diameter, and the feldspars, though occasionally more than 2<sup>cm</sup> in length, are usually less than 1<sup>cm</sup> in greatest diameter.

---

<sup>1</sup> American Journal of Science, III, XXVII, p. 461, 1884.

On the southern edge of the mountain and on the northwestern slope the rock has an even more striking development than that just described. Both quartz and sanidine, but specially the latter, occur in large crystals, and, while the quartz is dark, as before, the sanidine possesses a most beautiful, brilliant, satiny luster upon a surface nearly parallel to the orthopinacoid, which is particularly marked in fractured crystals. At the same time biotite and ore specks appear in sufficient quantity in the subordinate groundmass to give it a tinge of gray and cause it to stand out plainly from the feldspars. The dark, smoky tinge of the quartzes, the delicate but brilliant luster of the sanidines, together with the general freshness of all constituents, give to the rock an extraordinarily beautiful appearance. On Plate VIII, page 88, is a heliotype representation of this Nevadite, which but feebly expresses the strong contrast between various constituents.

**Macroscopic constituents.**—Of the feldspars in this rock only the sanidine is at all prominent, although plagioclase appears in small crystals and sparingly in the groundmass. The plagioclase must be an oligoclase poor in lime, as is shown by the rock analysis later. Sanidine, much more glassy and fresh in appearance than the plagioclase, is by far the most interesting component of the rock. Many of its crystals are Carlsbad twins, sometimes polysynthetic, and exhibit the faces  $\infty P$ ,  $\infty P \hat{\alpha}$ ,  $0P$ , and  $2P \hat{\alpha}$ . The luster which has been mentioned is highly characteristic and is described in detail below.

Some of the large, lustrous sanidines exhibit a peculiar internal structure. On breaking open several crystals there appeared a kernel partially detached from an outer zone or shell about  $1^{\text{mm}}$  in thickness. All free surfaces of the kernel are glistening crystal faces, and the inner surfaces of the shell are likewise regular crystal planes, upon which minute projections are found to be like attached crystals, with the same orientation as the larger individual. The shell usually exhibits the satiny luster more markedly than the kernel, but no other difference was noticed between the substance of the two parts.

From a clear crystal in which the luster was not pronounced a section was prepared nearly at right angles to the edge between  $0P$  and  $\infty P \hat{\alpha}$ , and the optical axes were found to lie near together in a plane normal to  $\infty P \hat{\alpha}$ .

The quartz crystals and grains of this rock are quite free from mineral inclusions; glass has never been observed in them and arms or inclusions of the groundmass are alike rare. Gas pores are, on the other hand, quite abundant, being in part negative crystalline in form. Many pores, seeming at a low power to be merely filled with gas, are really fluid-inclusions with a relatively small amount of fluid. This is very plain if the cavity is irregular, the fluid being pressed into the angles or projecting arms, while the main part of the cavity is occupied by the bubble.

Biotite is very sparingly developed in small hexagonal leaves. Magnetite is the only ore mineral and is present in very small quantity. Apatite and zircon are the remaining accessories, and both are much less abundant than is usual in the rocks of the district.

**The groundmass.**—Quartz and feldspar in a very even-grained mixture are almost the sole constituents of the groundmass. In the coarser variety of the Nevadite the average size of the grains is  $0.02^{\text{mm}}$  to  $0.05^{\text{mm}}$ , and the greater part can be identified as

quartz or feldspar, the larger portion of the latter being monoclinic. The groundmass of the more compact varieties of the rock is cryptocrystalline. Gas pores of irregular shape are present between the granules in all modifications.

While there is no microfelsitic substance and no persistent glassy base, properly speaking, there are irregular, disconnected patches or particles of a clear, structureless, isotropic matter, with branching arms filling spaces between grains of the groundmass. This substance is most clearly developed in the coarser parts of the rock mass, and it is apparently identical in character with the glass observed in the rhyolite from the Hohenburg near Berkum, on the Rhine, Germany, first described by Zirkel.<sup>1</sup> In manner of occurrence of this glass residue the two rocks are very similar, though it is more abundant in the German rock. The latter contains plagioclase abundantly in the groundmass and its basic silicate is hornblende.

**Drusy cavities.**—In the coarser-grained parts of the Nevadite body are numerous small cavities lined by minute crystals. At the northwestern point of Chalk Mountain they reach the maximum in size, some observed being several centimeters in greatest diameter. In the larger ones the crystals reach a determinable size and are found to be chiefly sanidine, in delicate glassy tablets that are always Carlsbad twins, with some quartz, biotite, and topaz. A few stout crystals seem likely to be triclinic feldspar, but they could not be definitely determined. A coating of manganese binoxide is often upon the crystals and dark spots in the mass of the rock seem due to the same substance. Both sanidine and topaz from these druses are worthy of special notice and are described below. No minerals which can be considered alteration products are found in these druses and a natural explanation for the occurrence is to regard all the crystals as sublimation products.

**Topaz.**—Usually but a single topaz is present in one of the druses, and that is larger and more perfect in development than any other crystal. The topaz is attached directly to the walls of the cavity and often bears small tablets of sanidine upon it. The crystals which can be recognized vary from 0.5<sup>mm</sup> to 3<sup>mm</sup> in length, but it seems quite probable that there are some smaller ones, indistinguishable from quartz.

The determination rests upon the crystalline form, which is very distinct and is that of common topaz. One crystal, measuring 3<sup>mm</sup> in length and 1<sup>mm</sup> in thickness, was removed from the rock, and its angles were measured with a Fuess reflection goniometer. This crystal presents  $\infty \check{P}$ ,  $\infty \check{P}2$  and  $2\check{P} \infty$  as the dominant forms;  $0P$  is a narrow face and  $4\check{P} \infty$ ,  $2\check{P} \infty$ ,  $2P$ , and  $P$  are minute, but very distinct. The angles measured are as follows:

$\infty P \wedge \tau P$	124° 16'
$\infty \check{P}2 \wedge \infty \check{P}2$ over $\infty \check{P} \infty$	93° 7'
$0P \wedge 2\check{P} \infty$	136° 30'
$0P \wedge P$	134° 11'
$0P \wedge 2P$	115° 55'

$2\check{P} \infty$  appears as a very narrow face in the zone of  $2P$  to  $2P$ . This is the usual habit, with the occasional addition of  $\infty \check{P} \infty$ , and a more prominent development of  $0P$ . This crystal is also imperfectly terminated at the attached end, showing  $2\check{P} \infty$  most prominently, with  $4\check{P} \infty$  and  $2P$  also recognizable, and there are no signs of hemimorphism.

<sup>1</sup> Mik. Beschaf. der Min. und Gesteine, p. 343.

No occurrence of topaz in eruptive rocks has been previously described, so far as is known to the writer. Topaz is found in other parts of the Rocky Mountains, and in Mexico, where eruptive rocks are said to occur, but the connection between the two has not been demonstrated.

The satin-like luster of the sanidines.—The lustrous surface is in the orthodiagonal zone and inclined a few degrees to the orthopinacoid, as is evident in the Carlsbad twins, usually polysynthetic, the luster reaching its maximum of brightness simultaneously in alternate planes. Microscopical investigation shows a most perfect parting parallel to the surface of luster, and with a knife-blade flakes can be split off in this direction, even more readily than parallel to the basal cleavage-plane. Thin plates parallel to the base (OP) show a very fine striation at right angles to the line of  $\infty P \infty$  and  $\pm$  to the directions of extinction. Thin flakes split off parallel to the lustrous surface show, under the microscope, that the luster is due to interference of light in passing the films of air between the extremely thin plates produced by the parting. The thinnest flakes, composed of a few plates, are transparent and exhibit delicate colors of interference, while those composed of more plates are dull translucent or opaque, the light having been completely extinguished by the repeated interference. The luster is then due to reflected light from the air films near the surface and to its interference. By examination with a good hand lens, a delicate play of colors may be seen upon the lustrous surface of the crystals.

In the drusy cavities above described the sanidines are thin tablets, almost invariably Carlsbad twins, with prominent development of the clinopinacoid. Such crystals examined under the microscope, as they lie upon the predominant pinacoidal face, afford a means of determining approximately the position of the plane parallel to which the parting referred to takes place. The adjoining cut represents one of these crystals, a normal Carlsbad twin, with a third and smaller plate, also in twin position. The faces shown are:  $\infty P$ ,  $\infty P \infty$ ,  $P \infty$ ,  $OP$ , and  $2P \infty$ , as indicated. From all the outlines and from basal cleavage or irregular fissures run dark lines, in uniform direction for each individual of the twin, and penetrating varying distances into the crystal. This undoubtedly represents an incipient stage of that parting, which, in the large crystals of the rock, occasions the brilliant luster, for these dark lines do not represent needles of any mineral substance,

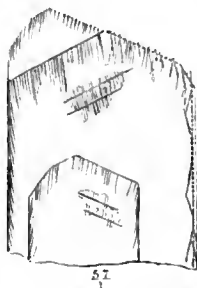

FIG. 1.—Sanidine from Nevada.

but the air films filling the fissures.

This parting may be seen upon all microscopic sanidine crystals of the rock, and even the irregular grains of that mineral in the groundmass, when cut in the right direction, show a very fine, delicate striation, which is undoubtedly due to the same cause. As seen from the figure, the position of the surface is that of a positive hemi-orthodome, for the cleavage plates of large crystals show the plane to be at right angles to the clinopinacoid. Assuming the axial ratio

$$a:b:c = 0.653 : 1 : 0.552 \text{ and } \beta = 64^\circ,$$

as determined by Strüver,<sup>1</sup> for free crystals of sanidine, the face corresponds closely to  $\frac{1}{2} P \infty$ . This would require an angle of  $72^\circ 40'$  with the basal plane, while that

<sup>1</sup>Cited by Tschermak, Lehrbuch der Mineralogie, p. 455, 1883.

measured in the crystal figured was 72° 53'. Of course this cannot be regarded, under the circumstances, as anything more than an approximate determination.

**Chemical composition.**—The specimen subjected to quantitative analysis is from the northeastern part of Chalk Mountain [397] and is of the relatively finer-grained modification. This was chosen in order to obtain more easily an average sample of the rock. The analysis is by W. F. Hillebrand.

SiO <sub>2</sub> .....	74.45
Al <sub>2</sub> O <sub>3</sub> .....	14.72
Fe <sub>2</sub> O <sub>3</sub> .....	None
FeO.....	0.56
MnO <sub>2</sub> .....	0.28
CaO.....	0.83
MgO.....	0.37
K <sub>2</sub> O.....	4.53
Na <sub>2</sub> O.....	3.97
Li <sub>2</sub> O.....	Trace
H <sub>2</sub> O.....	0.66
P <sub>2</sub> O <sub>5</sub> .....	0.01
	100.38

The rarity of biotite and of magnetite in this rock, which has already been emphasized, is certainly confirmed by this analysis. In fact, it is evident that no minerals, aside from quartz and feldspar, play any important rôle. The large amount of soda shown by the analysis made it desirable to know how large a share of it was contained in the sanidine, and an analysis of a large clear crystal was therefore made. The result was as follows:

SiO <sub>2</sub> .....	65.04
Al <sub>2</sub> O <sub>3</sub> .....	20.40
CaO.....	0.79
K <sub>2</sub> O.....	9.74
Na <sub>2</sub> O } .....	4.11
Li <sub>2</sub> O } .....	
H <sub>2</sub> O.....	0.29
	100.37

From this it may be safely assumed that a large part of the soda found in the rock belongs to the sanidine, for no visible impurities were present, such as plagioclase grains. The same holds true for the lime. It is worthy of note that the silica percentage is the highest yet obtained in any rock of the region.

#### BLACK HILL RHYOLITE.

The rhyolite forming Black Hill, in the southeastern corner of the mapped district, is like the Chalk Mountain Nevadite in being composed almost wholly of quartz and feldspar, but the resemblance otherwise is not very marked, for the Black Hill rock possesses a groundmass which is fully equal quantitatively to the small imbedded

crystals. Both feldspars are present in numerous crystals, but orthoclase alone is prominent in the groundmass. Quartz occurs in abundant, slightly smoky crystals. Biotite, in small hexagonal leaves, is sparingly scattered through the whole, and magnetite is also insignificant as a constituent.

Fluid inclusions appear in both orthoclase and quartz, particularly in the latter, and sometimes carry white cubes, apparently of salt. There are glass inclusions also in the quartz, but not plentifully. The groundmass is granular and shows no glass substance like that in the Nevadite.

The orthoclase, though fresh looking, has none of the glassy appearance of sanidine, and it must be confessed that there is little evidence in the observed characteristics of the rock demanding that it be separated from the quartz-porphyrines. There is no direct evidence of its age, and its classification as a younger rock rests chiefly upon the following facts. In mode of occurrence and in composition it is more nearly related to the Chalk Mountain Nevadite than to any other rock of the region described. It lies separated by a considerable space from all other eruptives of the map, but is adjoined at no great distance on the south and southeast by a large series of rhyolites and andesites. It is regarded as most probably related to these in its origin. A silica determination in fresh rock gave 69.54 per cent. [140].

#### McNULTY GULCH RHYOLITE.

**Occurrence.**—On the northern boundary of the area mapped, at the western base of Bartlett Mountain, occurs a rhyolite of peculiar character. It appears in one large and several small bodies at the head of McNulty gulch (not indicated on the map), which runs north and enters the Ten-Mile River at Carbonateville. White Ridge, between Chalk ranch and Chalk Mountain, is also formed of this rock, as are one or two minor bodies west of Chalk Mountain, which are not shown upon the map.

At the head of McNulty gulch this rock cuts porphyrite and the fresh-looking quartz-porphyrine which occurs in the synclinal fold at this point. All these rocks extend northward into the Ten-Mile district, and they will be more fully treated in the forthcoming report upon that region.

**Description.**—In the largest body of this rhyolite, indicated upon the map, the prevailing habit is that of a light-colored rock, showing numerous slightly pinkish quartz crystals, white glassy feldspars, and bright brown biotite leaves, with a subordinate ashen-gray groundmass between them. Few crystals exceed 0.5<sup>cm</sup> in diameter, and the average is much less. Intimately associated with the above variety, usually in alternating bands or streams, with rapid though gradual transitions, is a darker modification, in which the development of the quartz in particular has been hindered, while feldspar and biotite are abundant in smaller individuals than before. The groundmass becomes at once more prominent and darker brown in color, determining the general hue of the rock. The thicker these dark portions are the more completely the quartz disappears. In the most compact parts of the rock a fluidal structure is macroscopically visible and small glistening prisms of hornblende appear. About included fragments of sandstones, etc., this rhyolite grows compact in a similar manner, and also on the contact with wall rock.



The smaller masses, though sometimes light-colored, seldom contain much macroscopically visible quartz, and hornblende is usually more or less abundant with the biotite.

**Microscopical.**—The quartz-bearing variety shows under the microscope a decided preponderance of sanidine over plagioclase. The former is in most cases in fragments of crystals, while the plagioclase is often in well-defined individuals. A few glass inclusions were seen in both quartz and feldspar, while no fluid inclusions were noticed. Apatite and magnetite are rather sparingly present. No hornblende could be found accompanying the biotite in this form. The groundmass is cryptocrystalline and is made up of colorless grains and ferritic specks which are undeterminable. It seems probable that there is some microfelsitic matter present, but it could not be definitely recognized and there is certainly no glass base.

The microscope shows almost as much hornblende as biotite in the compact rock and there is also a larger determinable amount of plagioclase than in the preceding variety, with the same distinction noticed before in contrast with the sanidine, viz, that the latter mineral is more frequently in a fragmentary state, while the former is well crystallized. Quartz is present in clusters of small irregular grains and rarely in crystals. The groundmass is, as before, cryptocrystalline, but its component particles are often minute prisms or flakes and there are more yellowish or opaque grains.

In the darkest modifications a small amount of quartz can always be recognized, but by no means enough to represent the crystals of the light-colored variety. Still everything seems to indicate that the various forms are modifications of one magma and do not differ greatly in chemical composition. So far as the silica is concerned, the truth of this idea was fully established by three determinations made, respectively, in the quartz-bearing variety, the compact form associated directly with it, and, thirdly, in a very light-colored rock from a small isolated occurrence not visibly connected with any other. These yielded, in the order named, 65.75 per cent., 65.21 per cent., and 65.63 per cent. of silica.

#### EMPIRE GULCH RHYOLITE.

About opposite the Long and Derry mine, on the south side of Empire gulch, there is a small body of rhyolite occurring as a bed below the Silurian Limestone [26S]. This is unlike any other of the rocks examined and deserves a short description. It is white, barring the specks of biotite, and very fine-grained, although the lens shows many clear and sharp quartz crystals. The feldspar is distinguishable from the groundmass through its superior whiteness and is apparently no longer fresh. The average size of the visible crystals is about 1<sup>mm</sup>.

Under the microscope the minute quartz crystals are seen to be well-shaped and to contain very characteristic clear glass inclusions, with none of fluid or groundmass, and a very few apatite needles. The feldspars are chiefly orthoclase, though accompanied by plagioclase, and both seem to be much altered, calcite being the most prominent decomposition product. They contain some inclusions of glass, now much devitrified. The biotite is fresh and characteristic. Magnetite is very sparingly present.

The groundmass has a mottled appearance in ordinary light through the gathering of exceedingly minute brownish particles about certain centers, but no optical proofs of a radiate structure could be detected. The quartz crystals are surrounded by a zone of similar constitution. Seen in polarized light, the whole groundmass seems crypto-crystalline, no isotropic matter being visible. The substances forming it could not be identified, and they seem to be rather needle-shaped or foliate than granular. An alkali determination in this rock gave 3.50 per cent. of potash and 2.17 per cent. of soda, while the silica was determined at 68.05 per cent., thus confirming the identification as an acid orthoclasic rock.

#### OTHER RHYOLITES.

Rhyolitic tufa in South Park. — Four miles south of Fairplay and one mile east of the limit of the map is a small outcrop of rhyolitic tufa occurring in the red sandstones of the Upper Carboniferous [141]. It is of very limited extent and is apparently the extremity of an arm reaching out from some of the larger masses of rhyolite lying to the south or east. It is of a pink color, very light and porous, and includes many fragments of sandstone as well as pieces of a still lighter tufa. Glassy feldspar, swarming with delicate glass inclusions, quartz, biotite, and hornblende, can all be recognized. The cementing matter is dull, stained, fibrous, and largely micro-felsite. The tufa contains 70.3 per cent. of silica.

Dike in the Ten-Mile amphitheater. — A rock which seems to be related to the Chalk Mountain Nevadite occurs in the amphitheater forming the source of Ten-Mile Creek, just east of Chalk Mountain [139]. It appears as a dike in the Archean, for the amphitheater lies immediately east of the great Mosquito fault. On account of decomposition of the feldspars, forming a light greenish-yellow mica, the exact parallelism between the two rocks cannot be absolutely established. The macroscopical appearance suggests an intimate relationship.

Breccia in the Eureka shaft. — In the Eureka shaft, Stray Horse gulch, near Leadville, a brecciated material was found, in which, among other rocks, is a rhyolite containing biotite and larger crystals of feldspar than the type from Empire gulch, but with a similar groundmass [204]. The sanidines abound in glass inclusions, and, besides the quartz, which is not specially abundant, there are aggregates of tridymite.

#### QUARTZIFEROUS TRACHYTE.

At the head of Little Union gulch, south of Leadville, a rock was found traversing the Archean and Lower Quartzite in an irregular dike, which must be regarded as a quartz-bearing trachyte [142]. Owing to its small area and minor geological significance, it has not been designated by a distinct color on the map, but has been included under that of rhyolite.

Its macroscopical appearance is very different from that of any other rock of the region. The color is dark gray, its most prominent constituent being a glistening-brown biotite, with small glassy feldspars and a number of rounded yellowish quartz grains. Between these is an ill-defined, gray groundmass, which is quantitatively much subordinate to the crystalline constituents. None of the crystals exceeds 0.5<sup>cm</sup> in diameter.

**Microscopical.**—Orthoclase (sanidine) and plagioclase seem nearly equal in importance. Both are very fresh and in most cases contain few interpositions, although a few crystals carry a very large number of devitrified inclusions. Hornblende in yellowish-green individuals is quite plenty beside the biotite and both minerals are fresh. The amount of quartz seems limited to the macroscopically visible, rounded grains, and these, by their freedom from all inclusions and worn appearance, seem like accidental rather than normal constituents of the rock. Their number is small, and even if original it seems more proper to consider them as accessory. A silica determination of an average specimen yielded but 61.22 per cent., so that it is evidently not to be classed with the acidie group. Magnetite is abundant, as well as pale mineral in irregular oblong grains, which may be titanite. Apatite is inclosed in all the larger elements excepting the quartz.

The groundmass is microfelsitic in large degree and contains few crystalline particles. It shows a distinct fluidal structure, made plain by the contrast between the portions carrying indistinct brown needles and colorless portions. The needles are sometimes grouped in an imperfectly radiate manner about some small crystal, in a manner similar to that in feldspherulites. These act feebly on polarized light, giving a faint black cross when seen between crossed nicols. Some colorless isotropic spots seem to be glass. The movements which produced the fluidal structure are also indicated by the crumpled biotite leaves and broken hornblende prisms.

## ANDESITE.

Andesitic rocks have not been found within the limits of the Mosquito Range map, but at the Buffalo Peaks, a few miles south, a large variety occurs. In the course of a hurried trip a number of specimens were collected from this locality, representing several types; of these, two are sufficiently marked in character and occurrence to merit particular notice.

## PYROXENE-BEARING HORNBLLENDE-ANDESITE.

**Macroscopical.**—The rock which in the form of a sheet caps the mountain is a pronounced hornblende-andesite [143]. Macroscopically it is dark brown in color and contains feldspar in clear or ashen-gray crystals and dark, glistening hornblende prisms as most prominent constituents. With the aid of the lens green prisms of pyroxene and ore particles are quite abundantly visible. The brownish groundmass, which gives tone to the whole rock, is rather more abundant than all the crystals together.

**Microscopical.**—Under the microscope the hornblende is found to possess the usual characteristics of that mineral in such rocks. It has a dark, granular border, or is occasionally entirely replaced by a mass containing opaque ore grains, augite prisms, and some calcite as secondary elements. Besides the hornblende appear both hypersthene and augite, in smaller crystals, but more numerous. The former of these minerals possesses the same characteristics as in the accompanying hypersthene-andesite. Most of the feldspars are distinctly plagioclase and some of them contain irregular glass-inclusions in great number, many of which are now much devitrified. Magnetite and large dusty apatite prisms are sparingly present among the porphyritically imbedded crystals.

The groundmass is a mixture of delicate plagioclase staves, minute prisms of hypersthene and augite, with magnetite and a scanty glass base between them, the latter devitrified by brownish globulites.

#### HYPERSTHENE-ANDESITE.

On the northeast shoulder of the mountain a very dark compact rock occurs, which seems to be an almost typical augite-andesite. Macroscopically there are numerous small glassy feldspars visible and a few green grains and ore specks, but the black, generally vitreous groundmass is much more prominent [144]. The microscopical examination shows a very close resemblance to the well-known Hungarian "augite-andesites" of similar macroscopical habit. The rock contains no hornblende and no biotite, while the pyroxene consists in part of *hypersthene* and in part of common augite. Hypersthene is the more characteristic bisilicate in this rock, and the name is therefore given as above. Its determination rests upon careful optical and chemical investigations.

Comparative study in connection with the above rock has shown that a large number of so-called augite-andesites, both in this country and in Europe, are more correctly to be considered as hypersthene-andesites. Detailed investigations in regard to the Buffalo Peak rock and a comparative microscopical examination of allied occurrences are given in Bulletin No. 1 of the series published by the United States Geological Survey, "On Hypersthene-Andesite," &c.

On Plate XXI are heliotype reproductions of photographs showing the composition and structure of the chief andesite types of the Buffalo Peaks. The result is so unsatisfactory that the figures convey but an indistinct impression. In Fig. 2, however, the small prisms of hypersthene are distinguishable from augite, which occurs chiefly in peculiar aggregates, with magnetite, feldspar, and sometimes with biotite, as shown in the lower left-hand portion of the figure.

#### TUFACEOUS ANDESITES.

The tuffaceous rocks of the Buffalo Peaks are chiefly if not entirely of andesitic character, although they exhibit a very wide range in composition and texture. Some of them are loose or friable ash-beds, others contain a large amount of dark pearlitic glass with the ashy material, and still other beds are so compact as to resemble massive rocks. In composition they vary greatly, especially in regard to the more basic silicates, for hornblende, biotite, hypersthene, and augite are respectively the characteristic minerals in different beds, while they frequently occur together.

The pebbles included in these tufas represent as many types of massive andesites as are indicated by the various beds of tufa. Granite is also frequently found, especially in some layers, and sometimes in large boulders.

#### RÉSUMÉ.

In the following lines are brought together, in concise form, the results and particular features of the preceding description which are deemed of special importance or interest:

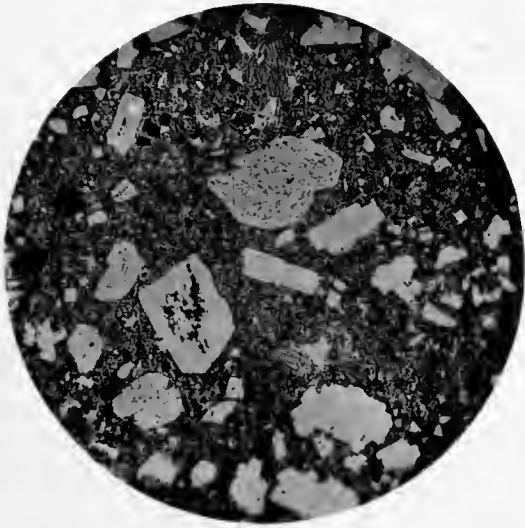

Fig. 1

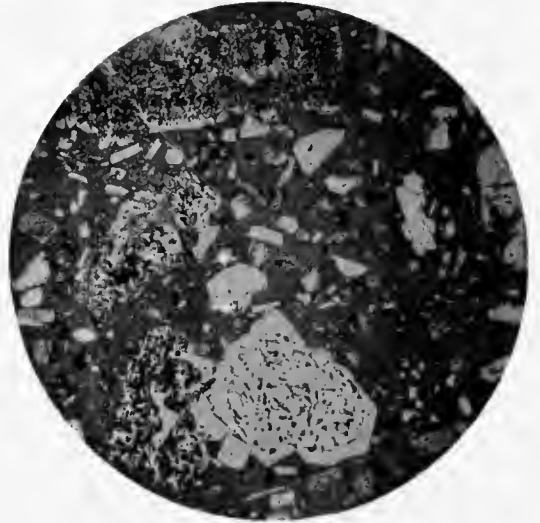

Fig. 2



Fig. 3

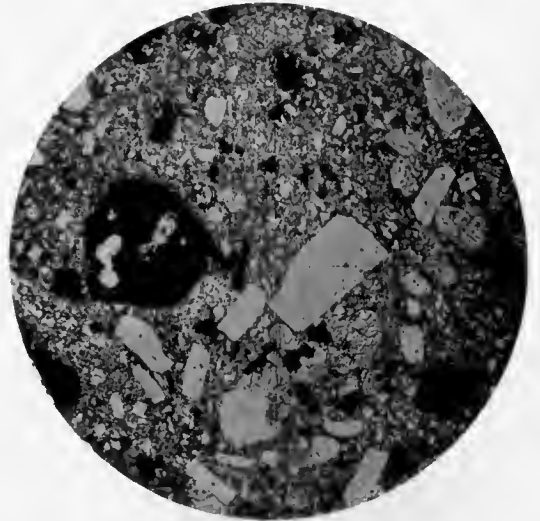

Fig. 4



## THE ROCK STRUCTURES OBSERVED.

But three granular rocks were found, all of them diorites. In striking contrast to this rarity, it is observed that all the numerous quartz-porphyrines and porphyrites are holocrystalline and that the groundmass is in nearly all cases evenly granular. Although these rocks occur both in dikes and in relatively large masses, this markedly crystalline structure is wonderfully persistent through the extent of the existing variation in conditions.

## INDIVIDUAL ROCK TYPES.

Of the various rock types described, the following seem specially noteworthy:

1. *White Porphyry*.—This rock illustrates a transition stage between the granular and porphyritic structures. Its imbedded crystals are few and small, but they evidently correspond to the more prominent constituents of the typical porphyry, whether viewed from the structural standpoint or considered in the light of the genetic principle discussed in the introduction. In mineralogical composition this is an interesting type, because of the absence of biotite or a bisilicate as an essential constituent. Even the intimate relationship to a biotite-bearing rock indicates nothing more than the possible presence of biotite in very insignificant quantity. The common accessories, apatite and magnetite, are also very rare.

2. *Lincoln Porphyry*.—This widely distributed type is remarkable for its large orthoclase crystals, developed during the later stages of consolidation, in the presence of abundant plagioclase. The persistency with which these crystals are found in masses of various conditions of occurrence gives at first a somewhat erroneous impression as to the distinctness of the type. Only the observance of many occurrences leads to a correct understanding of the relations of this rock.

3. *Nevadite*.—This variety has solidified at a stage seldom illustrated by instances which have been previously described. In its granular groundmass, consisting almost wholly of quartz and orthoclase, are still a few isolated particles of clear glass, a case directly analogous to but one occurrence known to the writer. The present form may be considered as a fair type of the division of the rhyolite called "Nevadite" by Messrs. Hague and Iddings. The peculiar mineralogical components are referred to below, and a glance at the quantitative analysis will show a wonderfully simple chemical constitution. Silica, alumina, potash, and soda make up 97.67 per cent. of the whole, no other element reaching 1 per cent.

4. *Hypersthene-bearing andesite*.—The rocks from the Buffalo Peaks, in which hypersthene<sup>1</sup> was identified as a prominent constituent, are especially noteworthy only as the first ones in America in which the important rôle played by that mineral was recognized. The experience of the last two years has shown the writer that andesites containing hypersthene as an essential constituent are very abundant in Southwestern Colorado, while their distribution in the Great Basin and among the volcanoes of the Pacific coast has been shown by the publications of Messrs. Hague and Iddings<sup>2</sup> and Diller.<sup>3</sup>

<sup>1</sup> Bulletin No. 1, United States Geological Survey, 1883.

<sup>2</sup>American Journal of Science, III, XXVI, 222, 1883. *Idem.*, XXVII, 453, 1884.

<sup>3</sup>American Journal of Science, III, XXVIII, 252, 1884.

## MUTUAL RELATIONS OF ROCK TYPES.

The large number of porphyrites constitute a series connecting the most distinctly plagioclasic forms with those in which orthoclase assumes a very prominent place by virtue of its abundant large crystals. The full significance of this transition will be shown in a forthcoming report upon the Ten-Mile mining district, which lies immediately north of the Leadville region.

## ROCK CONSTITUENTS.

During the study of the eruptives which have been described several constituents were found to possess unusual development, while some of great rarity were noticed.

1. Lustrous sanidine.—The sanidine of the Chalk Mountain Nevadite is characterized by a delicate but perfect parting, parallel to a plane in the orthozone, determined approximately as  $\frac{1}{2} P_{\infty}$ . When this parting is highly developed it causes a brilliant satiny luster parallel to the plane of parting. (See p. 348.)

2. Zircon.—Minute but highly perfect crystals of nearly colorless zircon are regularly, and sometimes abundantly, scattered through nearly all of the rocks described.

3. Allanite.—The main group of the quartz-porphyrines and porphyrites contains allanite regularly, but sparsely, distributed through it. With the exception of the contemporaneous identification by Mr. Iddings, no instance of the occurrence of this mineral in such rocks is known to the writer. (See p. 329.)

4. Topaz.—This does not appear as a rock constituent proper, but is found in drusy cavities in the Nevadite. It is associated here with quartz, sanidine, and biotite crystals and seems to be a sublimation product. (See p. 347.)

5. Orthoclase fragments.—In a dark porphyrite containing abundant hornblende and biotite and occurring as a dike in the Archean, were found numerous pebble-like fragments of orthoclase, each belonging to a single individual and unlike anything observed in other rocks of the region. These rounded pieces are analogous to worn fragments of foreign rocks often seen in neighboring dikes, but their true nature could not be definitely established. (See p. 339).

## DECOMPOSITION OF ROCK CONSTITUENTS.

Notwithstanding the uniform and simple composition of the rocks described, a few points of great interest were observed in connection with the decomposition of their constituents.

1. The Sacramento Porphyrite illustrates the tendency to the formation of a single end product from all the chief decomposable elements, to a degree hitherto unknown to the writer, either in literature or in personal experience. Some specimens of this rock show epidote replacing hornblende, biotite, orthoclase, and plagioclase, all other secondary products being comparatively insignificant in these cases. In certain other specimens of the same rock a common result of the decomposition of biotite, orthoclase, and plagioclase is muscovite, epidote and all other alteration products being here subordinate. (See p. 341.)



2. *Muscovite from biotite.*—The unusual process by which biotite is replaced by a mineral indistinguishable from the adjacent decomposition product of orthoclase is further illustrated in the Mount Zion (p. 324), Lincoln (p. 330), and Mosquito (p. 328) Porphyries. The intermediate stages are referred to in the text.

3. *Epidote.*—This mineral undoubtedly replaces both feldspars in several rocks where no intermediate stage can be seen. While the chemical replacement of orthoclase substance by epidote is not easily understood, it is a fact that the replacement does occur when the conditions, whatever they may be, are favorable (p. 341).

4. *Hornblende outlines.*—The Gray Porphyry has fresh or partially decomposed biotite, while containing evidences that hornblende was a former constituent, although it is now always represented by various extreme decomposition products in areas having the characteristic outline of hornblende. This hornblende must represent an early product of consolidation, destroyed in the manner commonly noticed in andesites, and both its former existence and its destruction are very probably connected with the fact that the Gray Porphyry sheet at Leadville is 12 miles away from the eruptive channel upon Eagle River. (See p. 331.)

5. *Rutile and anatase from biotite.*—The early stages of the decomposition of biotite are usually accompanied by the formation of yellow needles or of small, apparently tetragonal tablets, or of both forms. The identity of the former with rutile is exceedingly probable, as they are often twinned in the characteristic manner and correspond to what have been elsewhere identified. The nature of the latter forms is less easily shown, but they agree well with the descriptions of anatase by Diller,<sup>1</sup> while the association with the needles seems confirmatory of this determination.

#### NEGATIVE OBSERVATIONS.

The *absence* of certain minerals as constituents in some cases is worthy of note. Thus in the White Porphyry no biotite or bisilicate appears, even in small quantity; apatite is very rare in the same rock and seems to be wanting entirely in the Pyritiferous Porphyry; augite appears in a single rock, and olivine-bearing types are wholly wanting.

#### CHEMICAL COMPOSITION.

The simple composition of the Nevadite and of the White Porphyry has been referred to above. The relations of the types are noteworthy and will be apparent from an examination of the accompanying table, in which the analyses previously given are reproduced.

---

<sup>1</sup>Diller, J. S. Neues Jahrbuch für Mineralogie, etc., I, 187, 1883.

*Analyses of eruptive rocks.*

	SiO <sub>2</sub>	TiO <sub>2</sub>	Al <sub>2</sub> O <sub>3</sub>	Fe <sub>2</sub> O <sub>3</sub>	FeO	MnO	CaO	BaO	SrO	MgO	K <sub>2</sub> O	Na <sub>2</sub> O	Li <sub>2</sub> O	H <sub>2</sub> O	CO <sub>2</sub>	P <sub>2</sub> O <sub>5</sub>	Cl	Total.
Mount Zion Porphyry, p. 323..	73.50		14.87	0.95	0.42	0.03	2.14		Tr.	0.29	3.50	3.46		0.90				100.12
White Porphyry, p. 324 .....	70.74		14.68	0.69	0.58	0.06	4.12	0.03	Tr.	0.28	2.50	2.29		2.09	2.14		Tr.	100.29
Mosquito Porphyry, p. 327 ..	68.01										4.36	4.26						
Pyritiferous Porphyry, p. 326 ..											4.62	2.91						
Lincoln Porphyry, p. 328 .....	66.45	0.10	15.84	2.59	1.43	0.09	2.90		0.07	1.21	2.89	3.02	Tr.	0.84	1.35	0.36	0.05	100.09
Gray Porphyry, p. 330 .....	68.10	0.07	14.97	2.78	1.10	0.09	3.04		0.08	1.10	2.93	3.46		1.28	0.92	0.16	0.03	100.11
Sacramento Porphyrite, p. 341 ..	65.08										2.57	3.55						
Silverheels Porphyrite, p. 342 ..	60.42										2.70	4.08						
Hornblende mica Porphyrite, p. 340 .....	56.02		16.74	4.94	3.27	0.15	7.39			4.08	1.97	3.50		0.92	1.15	Tr.		100.73
Biotite Porphyrite, p. 340 .....	64.81	0.08	15.73	1.68	2.91	0.08	4.22		Tr.	2.82	1.43	3.98		0.62	1.08	0.23	0.04	FeS <sub>2</sub> 0.90 100.61
Nevadite, p. 345 .....	74.45		14.72	none	0.56	MnO <sub>2</sub> 0.28	0.83			0.37	4.53	3.97	Tr.	0.66		0.01		100.38
Rhyolite, Empire Gulch, p. 351 .....										3.50	2.17							

## NOTES UPON THE HENRY MOUNTAIN ROCKS.<sup>1</sup>

The Henry Mountain rocks are of two principal classes, one hornblendic, the other angitic, with plagioclase as the predominant feldspar in both cases.

### HORNBLENDIC ROCKS.

**Macroscopical.**—The hornblendic varieties have as a class a much more recent appearance than the Mosquito Range porphyrites, with which they agree in composition and microscopical structure. This arises from the prevailing light-grayish tone of the groundmass and the glassy luster of the feldspars. Nearly all specimens show a decidedly porphyritic structure, although they vary greatly in the relative proportions of the groundmass to macroscopic elements. A white or glassy, colorless feldspar, in short, stout crystals, or less frequently in tablets, and a glistening dark hornblende are the only macroscopic minerals of prominence. A few rounded quartz grains are visible in some of the specimens, and pale-yellow, brilliant crystals of titanite can be detected in most of them; also, minute ore grains. The groundmass in which these minerals lie is gray or tinged with red when fresh, but is greenish or dull gray when attacked. Careful search with the lens shows the characteristic striation of triclinic feldspars on many individuals, but it is much less prominent than usual. The hornblende is subordinate both in size and number of its crystals, and seldom appears in the groundmass in sufficient quantity to give it a greenish tinge, as was common in the Mosquito Range porphyrites. Few feldspars reach a diameter greater than 1<sup>em</sup>, while the average is below 0.5<sup>em</sup>.

**Microscopical.**—No. 04 will be first described, as it corresponds so nearly to our Mosquito gulch type, and the mutual relations of the two rock groups can thus be made most easily apparent. The only minerals appearing in large crystals are feldspar and hornblende. No quartz grains fall in the section. Other minerals to be distinguished from those in the groundmass are zircon, apatite, magnetite, and possibly some titanite iron. An unknown pale-green mineral, polarizing strongly, is present in irregular grains in the groundmass (pyroxene?). It is not abundant.

The feldspar is clearly plagioclase in nearly all cases when seen in polarized light. Most crystals show distinct laminae running fully across them, but others con-

---

<sup>1</sup>These notes were prepared at the request of Mr. Emmons for purposes of comparison with the eruptive rocks of the Mosquito Range. The examinations were made upon small specimens and thick sections, comparatively few new sections having been made. As the material was in a measure incomplete and is no longer at hand for further study, the notes are presented without elaboration in substantially their original form. The references are to the notes of Capt. C. E. Dutton in G. K. Gilbert's report upon the Henry Mountains.

sist chiefly of one individual, in which a few thin wedges are inserted at one end, or on one side, in twinning position. These are, I presume, the crystals described by Captain Dutton as orthoclase at one end and plagioclase at the other. A zonal structure is often present, which is at times interrupted by the twinning. Inclusions in the plagioclase are not very abundant. There are sometimes minute dark inclusions, regular or irregular in shape and arrangement, which seem to be early inclusions of the groundmass or devitrified matter. Distinct glass and fluid inclusions were seldom found. Hornblende occasionally penetrates the feldspar, but inclusions of other minerals are rare.

The hornblende itself is well developed crystallographically. In this particular case (04) it shows an unusual tendency to an alteration, by which dark ore grains are formed on and adjoining the outer surface and on cleavage and other fissure planes. The appearance is, however, entirely different from that of andesitic hornblende. In one place hornblende is apparently forming from pale pyroxene. This is, however, an isolated case, as elsewhere the distinct outlines of the hornblende crystals prove them to be original as such. The hornblende is green and fibrous rather than compact and yellow.

*Titanite*, which appears in most of these rocks, does not seem to be present here in good crystals. *Apatite* is not abundant, but occurs in short, stout prisms. But little magnetite occurs in large grains.

The *groundmass* is granular throughout and has the same composition as in the Mosquito Range porphyrites; that is, it consists chiefly of quartz and orthoclase.

Of the other Henry Mountain rocks, Nos. 8, 9, 16, 18, 20, 23, 32, 35, 40, 44, 46, 47, and 50—thirteen in all—seem identical in all essential points with that described above. Other accessory minerals appear in some of these sections. *Biotite* appears as a subordinate constituent in No. 35, corresponding in this respect to our porphyrites, and being the sole case noticed.

Isolated grains of pink *garnet* occur in Nos. 23, 37, and 47. *Titanite* is present in nearly all and ilmenite in some of them. In 40 the latter seems to be producing titanite through its alteration. In 46 and 23 (new section) I find allanite corresponding exactly in appearance to that of the Mosquito rocks.

It can hardly be asserted that plagioclase predominates in all of the rocks, from the evidence of these sections alone, as some of them are very small; there can be no doubt, however, that all belong to the same rock type. I cannot convince myself that orthoclase exists in more than isolated crystals among the macroscopic elements.

Inclusions in feldspar are seldom more numerous or distinct than in the first case described. Occasionally, however, a crystal is filled with minute hornblende micro-lites and clear crystals of zircon, with other ill-defined matter.

The feldspars are usually quite fresh, but the hornblende is sometimes entirely decomposed. The common result is a mixture of chlorite, filmy calcite, and opaque particles. Epidote is often a further product. Granular calcite is visible in some cases and its origin doubtful. The minute ore grains of the groundmass are often hydrated, giving a dingy tinge to the rock.

In none of the above rocks can there be any question as to the thoroughly crystalline nature of the groundmass, but it varies in relation to the crystals and in com-

position. Plagioclase in thin plates may be seen to enter into its constitution and the quantity of quartz doubtless varies. It even seems probable that in extreme cases the groundmass may be entirely feldspathic.

In nine other rocks, 24, 31, 33, 56, 61, 62, 67, 68, and 69, the groundmass is extremely fine grained and acts but feebly on polarized light. The granular structure is preserved, and I can find no proof of the glassy or strictly microfelsitic base. The varying relative quantities of groundmass and crystals are particularly marked in these fine-grained rocks (see 31 and 33).

#### AUGITIC ROCKS.

The rocks included here are Nos. 28, 43, and one of those numbered 31. Hand specimens of 31 and 43 were among those sent.

**Macroscopical.**—Specimen 31 is distinctly porphyritic, the greater part is dull ashen-gray in color, and in this portion feldspar and groundmass are not clearly distinguishable throughout. There are a few fresh pink feldspars in tabular crystals, presumably orthoclase, reaching in one case nearly 2<sup>mm</sup> in length. Similar feldspars were not noticed in any of the hornblendic rocks.

The dark basic mineral is very black and occurs in short stout crystals, mostly small, which lack the luster of hornblende. A careful examination with the lens shows also that the section of the prism is octagonal, with alternate sides but slightly developed. This mineral is not so abundant as the hornblende in preceding rocks. Glistening ore particles and yellow titanite are distinct, though small.

**Microscopical.**—(Of No. 31.) It is rather difficult to determine the nature of the dominant feldspar in this rock. I think it is plagioclase, but cannot say that I can prove it from the microscopical examination alone. In the first place, this feldspar does not seem to polarize light so strongly as is common. Captain Dutton probably referred to this rock when he said that certain feldspars "had almost ceased to polarize." In the second place, those crystals determinable as plagioclase are apparently oligoclase of medium composition, for the direction of total extinction in the sections examined does not vary far from the line of the twinning plane. It is therefore often difficult to recognize the polysynthetic structure. By the aid of the quartz plate many are found to be distinctly triclinic, but still so many remain undeterminable that it is possible that orthoclase predominates in the rock as a whole. The feldspars resemble those in granitic rocks in their dirty appearance, the result of incipient decomposition proceeding from innumerable cleavage planes.

Inclusions of augite are rare. Glass inclusions were not noticed and fluid ones are indistinct and rare. The *augite* is unique in its optical behavior in that it appears as bright green by ordinary light and has a pleochroism as strong as is usually found in green hornblende, giving, too, almost exactly the same colors. In all other and more important respects this mineral shows the characteristics of augite. Contours of prism, cleavage, and maximal angle of extinction in prismatic zone (nearly 45°) all indicate augite. Titanite and magnetite often penetrate the augite.

The groundmass seems wholly crystalline, yet is unlike that common in the hornblendic rocks. It seems composed of feldspar and augite, with no visible quartz. The feldspar is chiefly present in tabular particles, and not in irregular grains. The pale-green microlites and grains, which are quite abundant, seem to be of augite, as

there is more or less of a gradation in size from the large ones to these in the groundmass. Very minute ore particles are present.

No. 43 is of quite different macroscopical structure. It appears almost macrocrystalline, the groundmass occupying simply the interstices between the small white tablets of feldspar, while the augite occurs in minute grains not recognizable by the naked eye.

*Microscopical.*—The feldspars have a duller appearance even than those in 31, and there is the same difficulty in determining which species predominates. The augite is the same in character, but does not appear in the groundmass as in 31.

In No. 28 (the slide alone examined) exists still another form of structure. The whole mass is here microcrystalline and consists chiefly of feldspar, concerning which the same doubts exist as before. The augite is very distinct. The groundmass is made up of small feldspars and nearly every one is determinable as feldspar. Quartz does not appear; the same accessory minerals are here as in others, titanite, magnetite, &c. Hornblende is exceedingly rare, if, indeed, it occurs at all in these three rocks. No. 29, however, shows both minerals. The hand specimen shows large, distinct hornblendes, but in the slide, among the few minute irregular grains (no large ones being present), augite appears fully as abundantly as hornblende. The remainder of the rock is entirely feldspathic, both orthoclase and plagioclase being recognizable.

But one rock remains, No. 57. This is the sanidine-trachyte of Dutton. Not having the hand specimen and with only one slide, but little can be made out of it. It seems like a tufa or fragmental rock of some kind. The minerals recognizable (plagioclase, orthoclase, quartz, and hornblende) are chiefly in irregular fragments of crystals and the groundmass, though cryptocrystalline for the most part, has some isotropic substance.

#### RÉSUMÉ.

The greater part by far of the Henry Mountain rocks correspond very closely in composition and structure to our Mosquito Range porphyrites, or in particular to those varieties in which biotite is rare or is wanting and in which the hornblende does not appear in the groundmass in large quantity. Both consist of plagioclase and hornblende, with a granular groundmass, composed essentially of quartz and orthoclase. They differ—

- a*, in outward appearance.
- b*, in almost total lack of biotite.
- c*, in frequent presence of titanite.
- d*, in that the grain of the groundmass sinks in certain cases to exceeding fineness.

None of these is weighty in comparison with the resemblances.

The outward difference seems due to the fact that the specimens were taken from the surface in a region essentially dry and arid.

---

GEOLOGY AND MINING INDUSTRY OF LEADVILLE.

PART II.

MINING INDUSTRY.

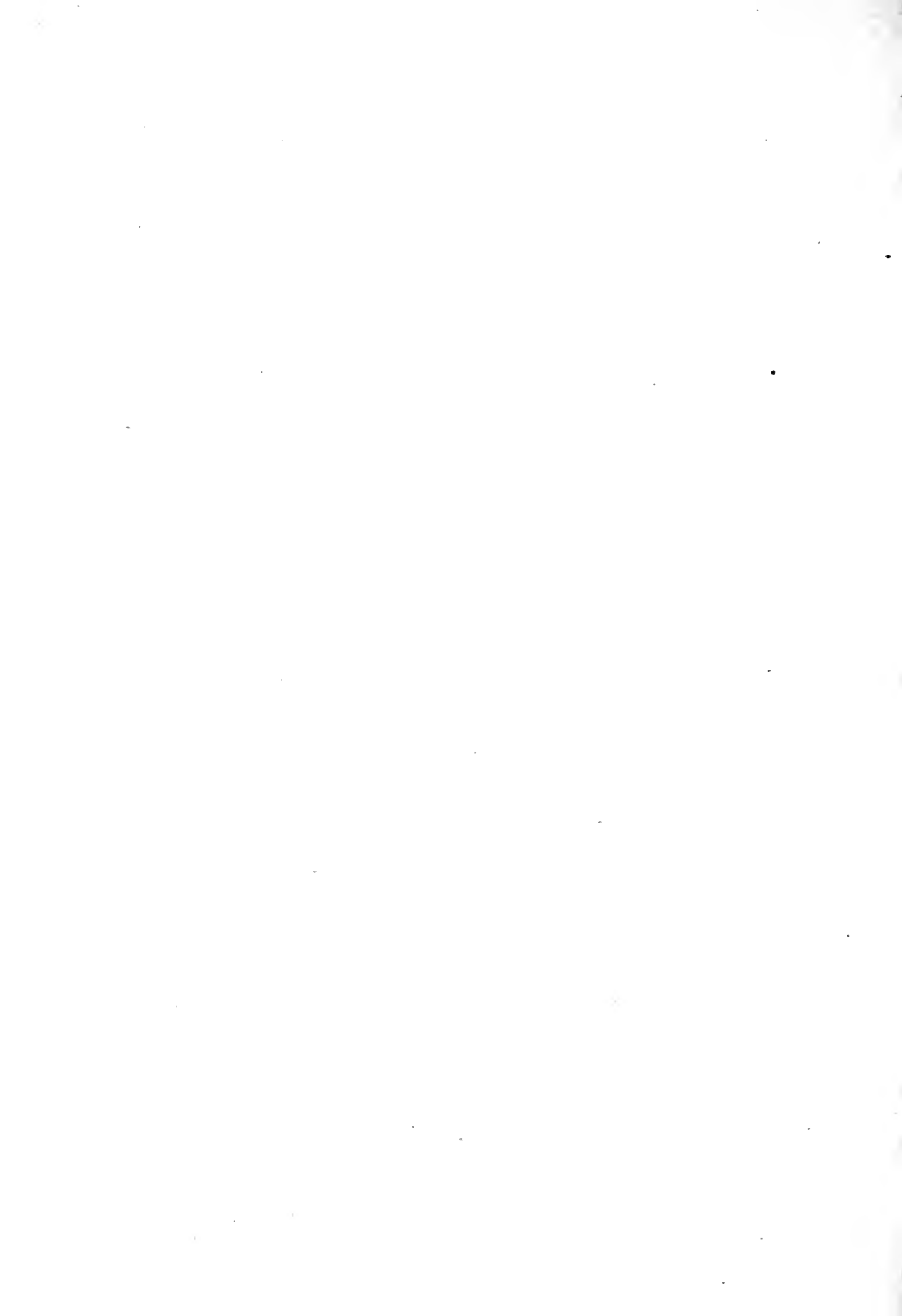



# CONTENTS.

## PART II.

### MINING INDUSTRY.

	Page.
CHAPTER I. Ore deposits .....	367
Classification of ore deposits in general .....	367
Leadville deposits .....	375
II. Iron Hill group of mines .....	380
Iron Hill .....	380
North Iron Hill .....	401
III. Carbonate Hill group of mines .....	409
General structure .....	409
Southern group of mines .....	414
Northern group of mines .....	429
IV. Fryer Hill group of mines .....	445
General description .....	445
Mine workings .....	455
Résumé .....	489
V. Other groups of mines .....	493
Mines and prospects in the Leadville region .....	493
Mines and prospects outside the Leadville district .....	519
VI. Genesis of Leadville deposits .....	539
Manner of occurrence .....	540
Composition of ores .....	543
Composition of vein materials .....	556
Ores deposited as sulphides .....	562
Mode of formation .....	565
Origin or source of the metallic minerals .....	569

### APPENDIX B, BY W. F. HILLEBRAND.

#### CHEMISTRY.

Tables of analyses and notes on methods employed .....	589
Eruptive rocks .....	589
Limestones .....	596
Ores and vein materials .....	599

### APPENDIX C, BY ANTONY GUYARD.

#### METALLURGY.

Argentiferous lead smelting at Leadville .....	613
Introduction .....	613
Preliminary conditions of smelting .....	614
Materials used in smelting .....	636
Plant and smelting operations .....	659
Products of smelting .....	692
Theoretical discussion .....	731
Metallurgical plates .....	749
General index .....	753

## LIST OF ILLUSTRATIONS.

	Page.
PLATE XXII. Vein phenomena, showing replacement action.....	420
FIG. 1. Evening Star Incline.	
2. Glass-Pendery mine.	
3. Carbonate Incline.	
4. Forsaken Incline.	
XXIII. Circular furnace, smelter A.....	749
XXIV. Reverberatory furnace and dust chamber, smelter A.....	749
XXV. Flue arrangement, smelter A.....	749
XXVI. Rectangular furnace, smelter B.....	749
XXVII. Circular furnace, smelter B.....	749
XXVIII. Bartlett smoke filter — McAllister charcoal kiln.....	749
XXIX. Rectangular furnace, smelter C.....	749
XXX. Dust chamber, smelter C.....	749
XXXI. Blast arrangement and elevation of works, smelter C.....	749
XXXII. Furnace and dust chamber, smelter D.....	749
XXXIII. Furnace and dust chambers, smelters F and M.....	749
XXXIV. Dust chamber, smelter F.....	749
XXXV. Square furnaces, smelter G.....	749
XXXVI. Zones of temperature — Elevation of smelter G.....	749
XXXVII. Circular furnace, smelter H.....	749
XXXVIII. Dust chamber, smelter H — Jolly's spring-balance.....	749
XXXIX. Assay furnace, smelter H.....	749
XL. Dust chamber, smelter J.....	749
XLI. Blake crushers.....	749
XLII. Blowers — Baker's and Root's.....	749
XLIII. Assay implements.....	749
XLIV. Smelter's implements.....	749
XLV. Alden crusher — Furnace and dust chamber, smelter I.....	749
FIG. 2. Highland Chief mine.....	501
3. Colorado Prince and Miner Boy mines.....	504
4. Florence mine, Printer Boy Hill.....	510
5. Taylor Hill.....	511
6. El Capitan mine.....	536

## CHAPTER I.

### ORE DEPOSITS.

The preceding chapters have been devoted almost exclusively to the consideration of the geological structure of the district. This subject has been treated at considerable length, not only because it presents many facts which seemed of sufficient interest to geologists in general to justify such treatment, but also because a thorough knowledge of the geological structure of a region is an essential and indispensable basis for the study of its ore deposits; a fact which is too often lost sight of by those practically engaged in mining. For a time the miner may develop his mine successfully by simply following the ore lead, guided by the empirical rules which experience has taught him, and without regard to the geological phenomena presented by the country rocks, their structural conditions, or the probable origin and manner of formation of the deposits; but the time is sure to come when without this knowledge he will be liable to make mistakes which may cost him more than he has gained by all his previous labors.

Before proceeding to a detailed description of the various ore deposits of the region studied in the course of this investigation, it may aid the reader to have a brief résumé of their principal characteristics and a concise statement of the conclusions which have been arrived at with regard to their origin and manner of formation.

#### CLASSIFICATION.

To a scientific description of natural objects the most valuable aid is a rational and universally accepted system of classification. The first obstacle one encounters in attempting the description of ore deposits is

the absence of such a classification. The object of a system of classification is not only to afford a means of avoiding long and repeated circumlocutions in descriptions, but also to furnish a comprehensive view of the mutual relations of the classes of phenomena to which it is applied. Such systems must necessarily change from time to time as the scientific studies of the phenomena progress and knowledge with regard to them becomes more accurate and thorough. The unsatisfactory state of existing classifications of ore deposits is due in large degree to an imperfect knowledge of the subject on the part of those who have made them, but in part also to their being made from a false standpoint.

As the study of geology sprang originally from the empirical observations of those engaged in mining for the useful metals, so the first systems of classification of ore deposits were based on distinctions and characteristics established by the miners themselves in their daily work, and, as in carrying on this work the outward form of the deposit was the most essential characteristic, this naturally formed the basis of their classifications. But while general geology has made relatively more rapid progress than the study of ore deposits, which, being a matter of practical and economic importance, has seemed to many to belong to a lower sphere of scientific investigation than purely theoretical questions, the prevalent classifications still hold largely to the original basis of the practical miner. The form of a deposit might well constitute the basis of a classification, if it constituted an essential characteristic thereof, and if there were certain regular forms that belonged exclusively to particular classes of deposits, which had a necessary connection with the sum of their other characteristics. This is so far from being the case, however, that not only is no one form confined to any particular class of deposit, but the same class of deposit, that is, one which has undoubtedly the same origin and manner of formation, may have a great variety of different forms, as is the case with those about to be described.

That the scientific study of ore deposits has not kept pace with the advance in other branches of geology is due in great part no doubt to the inherent difficulty of the subject, but also in a measure to a want of scien-

tific zeal or knowledge on the part of those who are practically engaged in mining. The phenomena to be investigated must be studied in the underground workings of mines, in which not only is a very small area open to observation as compared with the surface phenomena on which other geological reasonings are mainly based, but they are not in their nature as permanent as are the latter and soon become obscured by decay or entirely inaccessible. But, while the attainable facts are thus relatively meager, they have not all been made available to the student, for the reason that those practically engaged in mining are too often content with noting those alone which have an immediate practical bearing, and have neglected to put on record those of merely theoretical interest, which, nevertheless, if carefully observed, might afford a basis for scientific generalizations of great economic importance.

We can only hope to arrive at a satisfactory and rational classification, which shall be founded essentially on genetic principles, when our knowledge of ore deposits shall be vastly increased by the accumulation of a great number of scientific observations, based on correct geological studies, and towards this accumulation we must look to those practically conducting mines for a most essential contribution, since they alone have the opportunity of daily observation of the constantly changing phenomena which ore deposits present. Meanwhile it may be of use to review some of the more prominent systems of classification proposed by modern writers upon ore deposits, and to consider their relative applicability to the important class of deposits under consideration.

As the Germans were the first to write upon mines and ore deposits and the classifications adopted by other nations have been to a greater or less degree founded upon their work, the first place will be given to a mention of those most current in Germany at the present day. The original edition of B. von Cotta's treatise upon ore deposits appeared in 1853, and has not been essentially changed in the later edition here quoted. The next classification quoted is that of Dr. Joh. Grimm, professor of the School of Mines in Příbram, Bohemia. The third is that given in his course on mining at the School of Mines of Berlin, by Professor H. Lottner, and published by his

successor, Professor A. Serlo. The last, that of Dr. A. von Groddeck, of the School of Mines at Clausthal, in the Hartz.

Von Cotta. <sup>1</sup>	Grimm. <sup>2</sup>	Serlo-Lottner. <sup>3</sup>	Von Groddeck. <sup>4</sup>
<p><b>I. Deposits of regular form.</b></p> <p>1. <i>Beds.</i></p> <p>a. Beds of ore, coal, etc.</p> <p>b. Placer deposits.</p> <p>2. <i>Veins.</i></p> <p>a. Transverse or ordinary veins.</p> <p>b. Bedded veins.</p> <p>c. Contact veins.</p> <p>d. Lenticular veins.</p> <p><b>II. Deposits of irregular form.</b></p> <p>1. <i>Stocks</i> (sharply defined bodies.)</p> <p>a. Stock works.</p> <p>b. Contact stocks.</p> <p>c. Cave fillings.</p> <p>d. and e. Pockets, kidney-shaped deposits (Butzen, Rachelen, Tssehen, Nester, Rinner, Nieren).*</p> <p>2. <i>Impregnations</i> (bodies not sharply defined).</p> <p>a. Independent impregnations.</p> <p>b. Dependent impregnations (connected with other deposits).</p> <p>* Untranslatable miner's terms.</p>	<p><b>I. Disseminations or impregnations</b> (deposits forming an essential constituent of the country rock).</p> <p>1. <i>Original impregnations.</i></p> <p>2. <i>Secondary impregnations.</i></p> <p><b>II. Distinct ore deposits</b> (forming an accessory constituent of the country rock).</p> <p>1. <i>Sheet</i> (regular-shaped) masses.</p> <p>a. Bedded (sedimentary) deposits.</p> <p>b. Veins; crevice deposits; stringers (filling open fissures).</p> <p>c. Sheet-shaped segregations.</p> <p>2. <i>Stocks and irregularly shaped deposits.</i></p> <p>a. Bedded (sedimentary) deposits.</p> <p>b. Stocks (Butzen, Nester, etc.), filling pre-existing cavities.</p> <p>c. Stock works (reticulated veins).</p>	<p><b>I. Inclosed or underground deposits.</b></p> <p>1. <i>Sheet</i> (regular-shaped) deposits.</p> <p>a. Veins.</p> <p>b. Beds.</p> <p>2. <i>Mass</i> (irregular-shaped) deposits.</p> <p>a. Stocks.</p> <p>b. Stock works.</p> <p>3. <i>Other irregularly-shaped deposits</i> (pockets, kidneys, &amp;c.).</p> <p><b>II. Superficial deposits.</b></p> <p>4. <i>Deposits of debris</i> (placers).</p> <p>5. <i>Surface deposits in place</i> (bog-ore, &amp;c.).</p>	<p><b>I. Original or primary deposits.</b></p> <p><b>A. Contemporaneous with country rock.</b></p> <p>1. Deposits in stratified rocks.</p> <p>2. Deposits in eruptive rocks.</p> <p><b>B. Later than country rock.</b></p> <p>3. Deposits filling pre-existing cavities.</p> <p>a. Veins or lodes.</p> <p>b. Cave fillings.</p> <p>4. Metamorphic (or metasomatic) deposits.</p> <p><b>II. Secondary or detrital deposits.</b></p>

<sup>1</sup> Die Lehre von den Erzlagertätten. Freiberg, 1859.

<sup>2</sup> Die Lagerstätten der nutzbaren Mineralien. Prag, 1869.

<sup>3</sup> Bergbaukunde. Berlin, 1878.

<sup>4</sup> Die Lehre von den Lagerstätten der Erze. Leipzig, 1879.

Von Cotta's classification is founded exclusively on the form of the deposit and recognizes no genetic principle as a basis of classification. Thus, such essentially opposed deposits as coal beds and placer deposits, on the one hand, and mineral veins and contact deposits, on the other, are put under one general heading; while cave-fillings, pockets, etc., which may be merely offshoots from a vein or contact deposit, come under a distinct main head.

Grimm's classification is also mainly founded on the outward form of the deposit, but he admits a few minor genetical distinctions, such as sep-

arating bedded deposits of sedimentary origin from those which were formed later than the inclosing rocks. Lottner also bases his classification on outward form alone, but distinguishes secondary from original deposits. Von Groddeck lays much more stress on genetic distinctions, and not only brings in each of those recognized by the two previously named, but admits the existence of ore deposits of later formation than the country rock which do not necessarily fill pre-existing cavities or fissures.

F. Pošepný,<sup>1</sup> professor at Příbram, who has made an extensive study of ore deposits, including many of those of the United States, proposes an even more radically genetic subdivision of metalliferous deposits into (1) deposits in pre-existing cavities and (2) those formed by gradual replacement of the rock substances by the vein material or mineral, the first class being further subdivided into those filling cavities formed in a mechanical way, or *dislocation spaces*, and those formed by corrosive action in soluble rock, or *corrosive spaces*, which would correspond in general, though not necessarily in all cases, to the distinctions of Grimm and Groddeck of the fissure-fillings and cave-fillings.

In order that a classification should find general acceptance among mining men, it is essential, moreover, that it should be simple, concise, and of easy comprehension, qualifications which the first two of the above systems certainly do not possess. Thus, in this country, where mining geology has found its principal discussion in courts of law, in which Prime's translation of von Cotta has been generally accepted as authority, ore deposits of primary origin (leaving placers out of consideration) are practically divided into true fissure veins and deposits which are not true fissure veins, the latter class being somewhat loosely subdivided into contact deposits, blanket deposits, and rake, pipe, and gash veins.

The term "blanket deposit" is probably derived from the *manta* of the Spanish miners, a term which in Mexico and South America designates the richest and most productive ore bodies, but in the United States is apt to be applied in rather a derogatory sense to any horizontal sheet of ore. The last terms are derived from local usage in the lead regions of the north of

---

<sup>1</sup>Archiv für praktische Geologie, p. 600. Wien, 1880.

England, and their general application is of very doubtful advisability, since authorities differ as to their exact definition. The term "gash vein" is the only one recognized in the classifications given below, and is there applied to a fissure which is confined to a particular rock or bed and which does not extend into the adjoining rocks.

The English literature of ore deposits is even more meager than the German. Of general treatises on this subject, the more prominent in this country are J. D. Whitney's *Metallic Wealth of the United States*, published in 1854; an article by R. W. Raymond, in his *Mining Statistics for 1869*; and an admirable but little known paper on ore deposits, in Johnson's *Cyclopædia*, by R. Pumpelly. J. S. Newberry has also published an article on the origin and classification of ore deposits in the *School of Mines Quarterly* for March, 1880. In England, J. Arthur Phillips published in 1884 an extended treatise on ore deposits. Of the classifications proposed by the above authors, those of Newberry and Phillips are nearly identical with that of Whitney and Raymond's is avowedly an adaptation of Lottner, the differences in either case being unessential for the purposes of the present discussion. Those of Whitney and Pumpelly alone are therefore given here, and to them is added that given by A. Geikie in his *Text Book on Geology* (London, 1882), mainly because of the different standpoint from which it is made.<sup>1</sup>

---

<sup>1</sup> Prof. Joseph Le Conte has also published an article on the *Genesis of Ore Deposits*, in the *American Journal of Science* for July, 1883, in which a subdivision into (1) fissure veins, (2) incipient fissures, (3) brecciated veins, (4) substitution veins, (5) contact veins, (6) irregular ore deposits, is given.



J. D. Whitney.	R. Pumpelly.	A. Geikie.
I. <i>Superficial.</i>	I. <i>Surface deposits.</i>	I. <i>Contemporaneous ores of stratified rocks.</i>
II. <i>Stratified.</i>	1. Residuary deposits.	II. <i>Contemporaneous ores of crystalline rocks.</i>
<i>a. Constituting the mass of a bed or stratified deposit.</i>	2. Stream deposits.	III. <i>Subsequently introduced ores.</i>
<i>b. Disseminated through sedimentary beds.</i>	3. Lake and bog deposits.	1. Mineral veins or lodes.
<i>c. Originally deposited from aqueous solution, but since metamorphosed.</i>	II. <i>Forms due to the texture of the inclosing rock or to its mineral constitution, or to both.</i>	2. Stocks and stock works (including gash veins).
III. <i>Unstratified.</i>	1. <i>Disseminated concentrations.</i>	
<i>a. Masses of eruptive origin.</i>	<i>a. Impregnations.</i>	
<i>b. Disseminated in eruptive rocks.</i>	<i>b. Fahlbands.</i>	
<i>c. Stock work deposits.</i>	2. <i>Aggregated concentrations.</i>	
<i>d. Contact deposits.</i>	<i>a. Lenticular aggregations.</i>	
<i>e. Fahlbands.</i>	<i>b. Irregular masses (stocks)</i>	
<i>f. Segregated veins.</i>	<i>c. Reticulated veins (stock works).</i>	
<i>g. Gash veins.</i>	<i>d. Contact deposits.</i>	
<i>h. True or fissure veins.</i>	III. <i>Forms due chiefly to pre-existing cavities or open fissures.</i>	
	1. Cave deposits.	
	2. Gash veins.	
	3. Fissure veins.	

All of the above are an advance upon von Cotta in that form is not in all cases the exclusive basis of classification. Whitney's first two subdivisions are distinctly genetic, but the third, which embraces the majority of metaliferous deposits, is an unsystematic grouping of a variety of forms having only one common quality, that of not being stratified. Whitney recognizes a genetic quality in his division *a*, that of being of eruptive origin, but few geologists of the present day agree with his wide application of this quality—for instance, to the great deposits of magnetic iron of Missouri and Lake Superior. In his "segregated veins" he recognizes the possibility of an unstratified deposit which is not the filling of a pre-existing cavity, while no such recognition is found in Geikie's classification. Geikie's term "subsequently introduced ores," on the other hand, is to be preferred to "unstratified deposits," as being based on a more essential characteristic of the deposit. This would involve, however, a definite statement as to the age of Whitney's Classes III, *a* and *b*, which his general term avoids.

Pumpelly's classification ignores the division of stratified or contemporaneous ore deposits, and in his text he states his belief that the greater number of ore deposits have been formed later than the inclosing rock; he also says that all metalliferous aggregations are the result of a process or series of processes of concentration.

Pošepný states his opinion on contemporaneous deposits even more strongly in the following words:<sup>1</sup>

In the course of my nearly twenty-years studies of ore deposits I have yet met with no deposits (carrying sulphides) which answer to Werner's definition—that is, whose ores are contemporaneous with the country rock and which form a regular interstratified bed between other rock strata.

Like Pošepný, Pumpelly recognizes the importance of deposits which do not fill pre-existing cavities, devoting to these his subdivisions I and II. These he says fall under two heads, as regards the manner in which the space occupied by them was obtained: (1) by mechanical displacement of the inclosing material; (2) by a chemical replacement similar to that to which pseudomorphs owe their origin. His use of the form as a basis of subdivision for deposits filling pre-existing cavities seems more legitimate than in the case of those which his title seems to imply are merely concentrations of metallic minerals already existing in the rock, and the use of the word "concentration," as applied exclusively to the latter classes, seems unfortunate, as implying that the others are not concentrations also.

Geikie's classification has the merit of conciseness and his principal divisions are based on genetic principles, but his subdivisions, like those of von Cotta, recognize only differences of outward form.

In view of the difficulty, or even, in many cases, the apparent impossibility, of determining definitely the genesis of a given deposit, it may well be questioned how far it is advisable to adopt genetic relations as the basis of a classification, since it will frequently happen that an observer will be at a loss to determine under which subdivision the deposit he is studying should be placed. It seems to the writer, however, that in such a case, although his determination may not be final and may give rise to discussion and difference of opinion on the part of other observers in the same field,

---

<sup>1</sup> Op. cit., p. 423.

he will be led by this very fact to make a more thorough and searching examination than if he were only required to define the deposit in question according to its outward form.

As regards the applicability of the foregoing classifications to the Leadville deposits, it will be seen from a perusal of the following pages that no one of the subdivisions proposed would adequately define them; either they would apply only to a limited portion of the deposits or else they would include them under the same head with deposits of an essentially different character.

Of von Cotta's, Lottner's, and Whitney's subdivisions, several would be applicable; thus, a large part of the deposits are contact deposits; other parts, however, not being at the contact of two different rocks, would be stocks when large and pockets, chambers, etc., when small. The same remark would apply to Pumpelly's subdivision of his Class II, 2. On the other hand his definition of gash veins, as filling open fissures, would not apply to those of this region. The deposits would come under only a single head of Grimm's, Geikie's, and von Groddeck's classifications. By the two former they would be classed under the general head of stocks, which really defines nothing except that they are of irregular shape and large. Finally, von Groddeck's term "metamorphic," or "metasomatic," applies to all the Leadville deposits and defines one most essential characteristic; without some modification, however, it would apply equally well to a large portion of the Rocky Mountain deposits in Archean rocks, which have been previously considered to be "true fissure veins."

#### LEADVILLE DEPOSITS.

**Manner of occurrence.**—By far the most important of the ores of Leadville and vicinity, both in quantity and in quality, occur in the blue-gray dolomitic limestone of the Lower Carboniferous formation, hence known as the Blue or ore-bearing Limestone, and at or near its contact with the overlying sheet of porphyry, which is generally the White or Leadville Porphyry. They thus constitute a sort of contact sheet, whose upper surface, being formed by the base of the porphyry sheet, is comparatively regular and well defined, while the lower surface is ill-defined and irregular, there being a gradual transition from ore into unaltered limestone, the former

extending to varying depths from the surface, and even occupying at times the entire thickness of the Blue Limestone formation. This may be regarded as the typical form of the Leadville deposits; there are, however, variations from it, and also in the character of the inclosing rock, which do not necessarily involve any difference in origin or mode of formation. As variations in form, the ore sometimes occurs in irregularly-shaped bodies, or in transverse sheets not always directly connected with the upper or contact surface of the ore-bearing bed or rock; it also occurs at or near the contact of sheets of Gray or other porphyries with the Blue Limestone, and less frequently in sedimentary beds, both calcareous and silicious, and in porphyry bodies, sometimes on or near contact surfaces, sometimes along joint or fault planes.

**Composition.**—The prevailing and by far the most important ore, from an economical point of view, is argentiferous galena, with its secondary products, cerussite or carbonate of lead and cerargyrite or chloride of silver.

Lead is also found as anglesite or sulphate, as pyromorphite or chlorophosphate, and occasionally as oxide in the form of litharge or more rarely of minium.

Silver frequently occurs as chloro-bromide, less frequently as chloro-iodide, and very rarely in the native state. Chemical investigation has failed to detect sufficient regularity in the proportions of chlorine, bromine, and iodine, combined with the silver, to justify the determination of distinct mineral species.

A frequent alteration product of mixed pyrite and galena, which occurs in considerable quantity, associated with the ore bodies, is generally called "basic ferric sulphate." It is an ocherous-looking substance of somewhat uniform outward appearance, but of varying composition, being mainly a mixture of jarosite, or yellow vitriol, and hydrated basic ferric sulphate, with more or less anglesite and pyromorphite.

Gold occurs in the native state, generally in extremely small flakes or leaflets. It is also said to have been found in the filiform state in galena.

As accessory minerals are:

Zinc blende and silicate of zinc or calamine.

Arsenic, probably as sulphide, and as arseniate of iron.

Antimony, probably as sulphide.

Molybdenum, in the form of molybdate of lead or wulfenite.

Copper, as carbonate or silicate.

Bismuth, as sulphide and its secondary product, a sulpho-carbonate.

Vanadium, as dechenite or the vanadate of lead and zinc.

Tin, indium, and cadmium have been detected in furnace products.

Iron occurs as an ore, though in the Leadville deposits in general it constitutes an essential part of the gangue or matrix in which the valuable ore is found. In the former case it occurs in considerable bodies as pyrite or sulphide and as anhydrous oxide or red hematite, with a little magnetite.

**Gangue.**—The other components of the ore deposits, which may be considered as gangue, although this term is perhaps more strictly applicable to non-metallic minerals, are:

Silica, either as chert or as a granular cavernous quartz, and chemically or mechanically combined with hydrous oxides of iron and manganese.

A great variety of clays or hydrous silicates of alumina, generally very impure and charged with oxide of iron and manganese, the extreme of purity being white normal kaolin, containing at times sulphuric acid in appreciable amount.

Sulphate of baryta or heavy spar.

Carbonate of iron, pyrite, and sulphate of lime are comparatively rare in the deposits of Leadville itself.

The miner's term, Chinese talc, has been retained for a substance which is found with singular persistence along the main ore channel, or at the dividing plane between White Porphyry and underlying limestone or vein material, and also at times within the body of the deposit. It is composed of silicate and a varying amount of sulphate of alumina, to which no definite composition can be assigned. It is compact, semi-translucent, generally white, and so soft as to be easily cut by the finger-nail. It is very hygroscopic; hardens and becomes opaque on exposure to the air.

**Distribution.**—With regard to the distribution of the above ores the principal generalizations to be made are:

- I. *That the main mass of argentiferous lead ores is found in calcareo-magnesian beds.*
- II. *That ores containing gold and copper are more frequently found in silicious beds, in porphyries, or in crystalline rocks.*

These associations have already been remarked in other mining districts.

**Secondary alteration.**—Here, as elsewhere, the ores found near the surface are mostly oxidized or chloridized ores, and those farther removed from it, or comparatively unexposed to the direct action of surface waters, are mostly sulphides. It may be observed, moreover, that the zone of secondary deposition, or that in which oxidized ores predominate over sulphides, varies in the depth to which it extends with the relative altitude of the deposit; or that in higher altitudes, where surface waters are imprisoned by frost during a larger portion of the year, the proportion of secondary products is less.

There is a contrast in this respect, however, between the deposits of Leadville and those of the more arid regions of the Great Basin. In the latter the surface zone, or zone of oxidation, is generally more sharply defined and extends down to what is known as the water level. This contrast is more apparent than real, for the zone of oxidation is there dry, because of the limited atmospheric precipitation, and in Leadville generally wet, partly because of the relatively great precipitation and partly because of the peculiar geological position of the deposits, which renders them more accessible to surface waters. The alteration of the ore deposits is produced, not by the water alone, but by the atmospheric agents which it brings from the surface with it; whereas in the case of deposits below the water level the water which reaches them, not coming directly from the surface, but through a relatively long underground passage, has during that passage been deprived of these active agents of oxidation or neutralized.

**Mode of formation.**—From the present investigation it has been assumed, with regard to the mode of formation of these deposits:

- I. *That they were deposited from aqueous solutions.*
- II. *That they were originally deposited mainly in the form of sulphides.*
- III. *That the process of deposition was a metasomatic interchange with the material of the rock in which they were deposited.* That is, that the material of which they were composed was not a deposit in a pre-existing cavity in the rock, but that the solutions which carried them gradually dissolved out the original rock material and left the ore or vein material in its place.
- IV. *That the mineral solutions or ore currents concentrated along natural water channels and followed by preference the bedding planes at a certain geological horizon, but that they also penetrated the adjoining rocks through cross joints and cleavage planes.*

**Age of deposits.**—As regards the time of deposition of the original ore deposits, it is proved:

*That they were deposited not later than the Cretaceous period.*

That they are later than the inclosing rock is proved by their mode of occurrence; and since they have partaken of the dynamic movements to which these rocks were subjected, and were folded and faulted with them, they must have been formed earlier than these dynamic movements, which, as the geological considerations already presented show, occurred not later than the close of the Cretaceous period.

**Origin of the metallic contents.**—With regard to the immediate source from which the minerals forming these deposits were derived, the following conclusions have been arrived at:

- I. *That they came from above.*
- II. *That they were derived mainly from the neighboring eruptive rocks.*

By these statements it is not intended to deny the possibility that the material may originally have come from great depths, nor to maintain that they were necessarily derived entirely from eruptive rocks at present immediately in contact with the deposits.

The facts and reasons on which these conclusions are based will be given in the following chapters.

## CHAPTER II.

### IRON HILL GROUP.

#### IRON HILL.

**General description.**—Of the three principal groups of mines, that of Iron Hill presents the simplest type, both in geological structure and in the character of its ore deposits. It is that of a block of easterly-dipping beds, with a fault on its western side, by whose displacement these beds have been lifted in places about one thousand feet above their western continuation, and in which the ore deposition has taken place at the upper surface of the limestone bed, along its contact with the overlying porphyry, and extending down at times into the mass of the limestone. This simple type obtains only on the south end of Iron Hill, and even then in a somewhat modified form, the north presenting, as will be seen later, the extreme of complication.

The area represented on the Iron Hill and North Iron Hill maps forms topographically one continuous ridge. The map has been printed on two sheets, partly because of its otherwise cumbersome size and partly because the geological character of the opposite ends of the hill is very different.

The Iron Hill map includes all of Iron Hill except its northern portion, together with a part of Dome or Rock Hill, the spur which lies between California and Iowa gulches. It thus takes in all the mines belonging to the Iron Silver Mining Company, to the La Plata Mining and Smelting Company, and to the Silver Cord Combination, which represent the principal developments outside the Adelaide-Argentine group in this portion of the Leadville region.

Iron Hill and its companion, Carbonate Hill, are flat-topped bosses or shoulders, on the main spur of the Mosquito Range between California and Evans gulches, whose form was evidently due originally to the displace-



ment of Iron and Carbonate faults, though much modified by later erosion. The region, however, as distinguished from the other portions of Leadville, has been scarcely affected by glacial action, California gulch, in which erosion has been deepest, being, as has already been shown, essentially a valley of erosion. The slopes of the hills are steep, but extremely regular, and covered with an accumulation of "Slide," whose average depth may be considered to be from six to ten feet. This slide is distinguished from Wash by being not rounded, but angular and resulting from the disintegration of rock in place. It consists mainly of the débris of White Porphyry, which forms the top rock of either hill. The porphyry weathers into thin sherd-like fragments, which from their relative lightness are easily carried down by rain or snow, and therefore cover the greater part of the slopes of the hills, even where other rocks actually crop out. It is only along the steep slopes of the V-shaped valley of California gulch that actual outcrops of rock in place are found on either hill.

**Geological structure.**—The average strike of the formations on Iron Hill is a little west of north, and the beds dip east at an angle of about  $12^{\circ}$  to  $25^{\circ}$ , shallowing, however, to the eastward, and probably basining up toward the Mike fault. The south face of the hill has, by the erosion of the deep V-shaped valley of California gulch, been left so steep that its surface is but thinly covered by detrital material, and east of the Iron fault, whose line is marked by a slight depression down the slope, the outcrops of the succeeding sedimentary beds can be readily traced, in the numerous prospect holes, from the Lower Quartzite, immediately overlying the Archean, up to the main body of White Porphyry, which forms the summit of the hill.

The geological section represented on this slope is, then, in descending order:

1. White Porphyry capping, in which are included detached portions of the Weber Shales, represented in the Imes shaft by black shales and, along the outcrops on the Lime and Bull's Eye claims, by a greenish slate containing plentiful casts of *Lingula mytiloides*.

	Feet.
2. Blue Limestone .....	200
3. Parting Quartzite (outcrop obscure).....	20
4. White or Silurian Limestone .....	140
5. Lower or Cambrian Quartzite .....	160
6. Archean gneiss (not exposed).....	—

*Later intrusive sheets.*— Besides this normal series of beds, are two intrusive sheets of porphyry of later eruption than the White, and allied to, though not absolutely identical with, the Gray Porphyry. One of these is found at the top of the Blue Limestone, the other near its base. Their probable extent can be best seen by reference to the map and sections (Atlas Sheets XXIII, XXIV, XXV). The thicknesses there given are assumed from the position of outcrops, where they could be determined, and from other indirect evidence, and may differ considerably from the actual facts, as these porphyry sheets, especially the later ones, vary much in thickness in relatively short distances.

*Upper sheet.*— The rock of the former of these bodies is of a dark-gray color and consists of plates of altered mica and relatively large, opaque, white feldspars in a greenish-gray matrix. So far as seen it is in a too advanced state of decomposition to allow of a satisfactory determination of its original constituents. Externally, however, it resembles more closely the country rock of the Printer Boy mine than any other porphyry collected.

This sheet, while in general separating the White Porphyry from the Blue Limestone, does not always keep exactly the same horizon. In the bed of California Gulch, where the outcrops cross and where this porphyry seems to be thickest, it cuts into the Blue Limestone, leaving a portion of the latter above it, near the mouth of the La Plata tunnel. Farther west, on the hill slopes, it cuts up into the White Porphyry for a short distance, leaving a sheet of that rock between it and the Blue Limestone, and then again returns to the contact on the Lime claim, on Iron Hill, and west of the Dome fault, on Dome Hill. There is direct evidence that the sheet thins or wedges out from this crossing of California Gulch to the south, west, and north, but on the east no workings have yet reached a sufficient depth to cut it. It is not impossible that it may be an offshoot from some large body occupying a lower position in that direction—the Printer Boy body, for instance, which is at a lower geological horizon, though actually brought to a higher elevation by faulting.

*Lower sheet.*— The rock of the second body, as compared with that just described or with the normal Gray Porphyry, has in the hand specimen a

much finer grain, and its minute feldspar crystals are generally of a flesh color. When thoroughly bleached by decomposition it can be distinguished from the White Porphyry by its speckled or mottled appearance, whence the name of "mottled porphyry" that is not infrequently applied to it. It is probably also a variety of Gray Porphyry, though, like the preceding, not found in sufficiently fresh condition for exact determination.

As nearly as can be determined from the various prospect holes on the slope of the hill, this body has its maximum thickness near the line of the Iron fault and thins out to the southeast. It is best seen in a tunnel driven in near the fault, on its contact with an underlying limestone, which is supposed to be the lower portion of the Blue Limestone, though, as the Parting Quartzite was not actually exposed below it, this cannot be regarded as beyond a doubt. A certain amount of iron-stained material is found at the contact, and it had been supposed by some that this repetition of a contact of porphyry and underlying limestone below the regular outcrop was evidence of another fault, the different character of the two porphyries having escaped observation.

This porphyry sheet is probably of much wider extent than the one previously described, although its actual outcrop is much more limited; as will be seen later, it probably extends under the greater part of Carbonate Hill, and inasmuch as sheets of Gray Porphyry are found in considerable development on the north end of Iron Hill, though at somewhat lower horizon, it is fair to assume, as has been done in the sections (Atlas Sheet XXIV), that it extends under Iron Hill also, gradually lowering in horizon toward the north. It is probable that the small bodies of Gray Porphyry found crossing the limestone in various points of the hill are offshoots from this body.

*White Porphyry.*—The White Porphyry, which forms the summit of the hill, is the normal rock already described. From the quarry in California gulch, just above Graham gulch, was taken the specimen chosen for complete analysis (see Appendix B, Table I). In this quarry, which is but a short distance west of the Iron fault, the jointing planes are strongly marked, those parallel with the plane of the fault being the most prominent.

**Blue Limestone.**—The Blue Limestone, as shown by the map, has an unusually broad outcrop in California gulch, owing to erosion and to the low angle at which it stands. From the bed of the gulch the outcrops extend up along the hill slopes on either side, only obscured by slide or surface débris, until cut off by the Iron and Dome faults, respectively. On the Montgomery claim, a cliff exposure of a very considerable thickness of the lower beds is afforded by an open cut, where the limestone was formerly quarried as a flux for the smelters. There is also a small outcrop west of the Emmet fault, near the bed of the gulch, below the Columbia tunnel. From the upper beds in the Silver Wave ground were taken the specimens illustrated in Plate VI (p. 64) and whose composition is shown in Appendix B, Table V. The characteristic ribbed structure is here very well developed. The thickness of the formation, as calculated from these outcrops, is two hundred feet or more, which is greater than that deduced from measurements on Carbonate Hill.

**Silurian.**—The White Limestone is disclosed in numerous prospect holes, and some shafts on the south side of the gulch have cut the characteristic Red-cast beds. The Parting Quartzite could not be unmistakably recognized, owing to its close resemblance underground to decomposed porphyry. There is, however, no reason to assume that it is wanting.

**Cambrian.**—The Lower Quartzite is best shown in the Globe and Garden City shafts, each of which has cut through it into the underlying Archean. The quartzite is of the usual normal type and the Archean is a coarse-grained granitoid gneiss.

**Iron fault.**—The average direction of the line of the Iron fault is a little east of north, but its course is very crooked, as shown on the map. Although this irregularity may be somewhat increased by erosion, i. e., be greater than if the line given on the map were its intersection with a horizontal plane, still it cannot be considered abnormal, since from the bed of California gulch northward to the Codfish Balls shaft it has been actually proved in so many cases as to render its delineation unusually exact.

It has been cut by the workings of the Garden City shaft; by the L. M. shaft, which was sunk perpendicularly to the depth of two to three

hundred feet through White Porphyry, on the west side of the fault, into Lower Quartzite on the east side; by two shafts on the Lingula claim; and by numerous shafts and winzes in the claims of the Iron mine, some of the latter being sunk on the plane of the fault itself, and showing its average dip to be  $60^{\circ}$  to  $65^{\circ}$  to the westward, or nearly at right angles to the dip of the formation.

As the Blue Limestone has not yet been reached on the west side of the fault in the region represented on this map, its movement of displacement, or throw, cannot be accurately determined. Its maximum is probably not far from one thousand feet, since the City of Paris shaft, 1,200 feet north of the line of the map, was sunk to a depth of 800 feet without reaching the Blue Limestone. The dip of this bed carried back from the outcrop on Carbonate Hill, at the average angle, would reach at the line of the fault a much greater depth, probably not less than fifteen hundred feet; but there are good grounds for assuming that this dip shallows, and that the beds actually basin up, i. e., assume a westerly dip, before reaching the line of the fault. The movement of this fault may here be partly distributed among smaller parallel faults to the west, like the Carbonate fault, in which case the contact immediately adjoining the main fault may be found at a less depth than 1,000 feet. To the north, beyond the limits of this map, as has already been seen in the general description of the Leadville region, the movement of the Iron fault gradually decreases and it apparently passes into an anticlinal fold. As regards the continuation of the fault south of California gulch, however, no definite data have been obtained, since the great accumulation of Wash and Lake beds there have been a barrier to underground explorations. It has been assumed that it gradually passes into a synclinal fold, as indicated on the map of Leadville. The movement of displacement south of California gulch is, however, distributed among two faults, the Dome and the Emmet, with which the Iron fault is connected by a cross-fault (the California fault), which follows approximately the bed of California gulch.

*California fault.*—The plane of this fault has not been actually cut, but its existence is proved by the discrepancy of the beds on either side of the

gulch, the Blue Limestone outcropping near the Robert Emmet tunnel and opposite the Globe shaft, in which the Lower Quartzite is cut.<sup>1</sup>

**Dome fault.**—The Dome fault is in one sense the proper continuation of the Iron fault, since it forms the great break on Dome Hill, as Iron fault does on Iron Hill, and, like the latter, passes at its extremity into an anticlinal fold. Considered in this way, the Iron, California, and Dome faults would form a single fracture, somewhat irregular in direction, but having a general north-and-south trend, while the southern continuation of the Iron fault, as at present indicated, and the Emmet fault, would be simply branches, relieving the strain at the sudden bend of the fault in California gulch. To the east of this line of fracture are the principal outcrops of Blue Limestone and the main ore developments in this region, while to the west this horizon is more or less deeply buried beneath a covering of porphyry. The Dome fault proper has a general north-and-south direction. Its plane has been proved by underground workings only in the Vining tunnel, but the line as given on the map is tolerably closely determined by the developments of adjoining shafts and inclines, those on the west finding White Porphyry, underlaid by Gray Porphyry, on a level with Blue Limestone on the east, in the Rock and Dome workings.

**Emmet fault.**—This small fault, running in a southwest direction from the California fault, has a movement of displacement the reverse of the majority of the faults in this region — that is, the upthrow is to the west instead of to the east. Its plane has actually been proved by a drift running westward from a winze sunk in the Robert Emmet tunnel. It is further proved by the discrepancy in the position of the Blue Limestone and the overlying porphyries on either side of it, as shown in Section G, Atlas Sheet XXV. That it actually continues to its junction with the Iron fault to the south, as indicated on the Leadville map, is merely a matter of conjecture.

**Dome Hill.**—By reference to Atlas Sheet XXV, Sections E and F, it will be seen that the northern portion of the ridge of Dome Hill, adjoining Cal-

<sup>1</sup> Since the close of field-work, developments in the Garden City mine have definitely located the position of the western end of this fault. The lower shaft on this claim was sunk perpendicularly 100 feet through limestone and vein material, and then passed into the Lower Quartzite, crossing the fault diagonally. At 120 feet a drift to the southwest cut the fault at 5 feet from the shaft, showing that its dip is to the south. At 75 feet from the shaft the same drift cut the plane of the Iron fault and passed into the White Porphyry on the west side of this fault.

ifornia gulch, was originally part of the Iron and Carbonate Hill ridge and that their present separation by the valley of California gulch is due to erosion since the Glacial epoch. What is now the main crest of the ridge was once an arm or bay in the Arkansas lake, and the actual rock surface is buried to a great depth beneath the deposits formed in this lake and the later Wash. Except, therefore, on the northern edge of the ridge adjoining California gulch, which is the portion shown on the Iron Hill map, data with regard to the actual rock surface are extremely meager. Its geological structure above and to the east is similar to, and practically a continuation of, that of Iron Hill, namely, a series of easterly-dipping beds, capped by porphyry, in which the ore bodies have been developed by following the contact of the Blue Limestone with the overlying porphyry. The main difference lies in the development of the intrusive sheet of Gray Porphyry below the White Porphyry, which is not, however, absolutely parallel with the bedding, inasmuch as on the summit of Dome Hill a small sheet of White Porphyry is left between the Gray Porphyry and the limestone and in the La Plata ground the Gray Porphyry cuts down through the upper part of the Blue Limestone.

West of the Dome fault the relative position of these two sheets of porphyry affords most valuable evidence as to the underground structure, and actually proves a basining-up of the beds towards the Dome fault, as has been assumed to be the case in regard to the beds west of the Iron fault. At the Bank of France shaft the Gray Porphyry actually comes to the rock surface. The City Bank and Oro City, on the other hand, pass through the White Porphyry into the Gray, as does the Vining shaft higher up on the hill. The Sullivan, Ben Burb, and Keno shafts have reached the contact and limestone after passing through the White and then a comparatively thin body of Gray Porphyry. The Blue Limestone is thus shown to be at no great depth below the surface near the Dome fault. On the other hand, at the Coon Valley shaft, near the head of Georgia gulch, the Blue Limestone is over six hundred feet deep, showing a comparatively steep dip from the fault westward.<sup>1</sup>

---

<sup>1</sup> Since the completion of field-work the contact and even valuable bodies of ore have been proved in this region west of the Dome fault, notably in the Rosie, Sequin, and Vining claims. In the Sequin the contact was struck at 375 feet, in the Vining at 317 feet, in each case with a sharp dip to the westward.

The wedge-shaped block of ground between the Emmet and Iron faults may be considered a portion of the formation which, by compression between the adjoining blocks, has been lifted up relatively and compressed into an anticlinal fold. Actual outcrops of Blue Limestone are found near the bed of California gulch, opposite the Globe shaft. The Columbia tunnel was run in apparently on the very crest of the fold and developed considerable ore on the contact. From the line of the tunnel the formation dips gently to the eastward and very steeply to the westward, so that in the Crescentia shaft, a little west of it on the slopes of California gulch, at a depth of 335 feet the limestone had not yet been reached, but the shaft was in the Gray Porphyry beneath the White.<sup>1</sup> Section G, Atlas Sheet XXV, represents graphically the structure thus described.

**Ore deposits.**—The principal deposition of ore has taken place along the contact-plane between the Blue Limestone and overlying White Porphyry, and extended to greater or less depth into the mass of the limestone. In several instances large deposits have been formed within the body of the limestone, being probably on the line of some natural cleavage or joint plane which caused a deviation of the ore currents from their normal course.

The vein material or gangue consists of hydrated oxides of iron and manganese, silica, and clay. The iron varies from a hard, compact, more or less silicious brown hematite to a simple coloring matter of the clay. Manganese is found sometimes in fine, needle-like crystals of pyrolusite, but mainly occurs as a sort of wad, a black clayey mass known to the miners as "black iron." Silica occurs either as a blue-black chert or as a granular, somewhat porous mass, hardly distinguishable from quartzite. Clay is found in greatly varying degrees of impurity, from a white kaolin down, and is a product of the decomposition of porphyry. It occurs either in place or as an infiltrated mass. Besides this should be mentioned the Chinese tale of the miners, found mainly at the actual contact.

The ore is principally argentiferous galena and its secondary products are carbonate of lead, or cerussite, and chloride of silver. As accessory

---

<sup>1</sup> Late developments in the lower Garden City shaft show that the Blue Limestone is considerably mineralized and that the formation dips very steeply to the southwest.



minerals, or those of less frequent occurrence, are sulphate of lead or anglesite, pyromorphite, minium, zinc blende, and calamine. Native sulphur is found in one instance as the result of the decomposition of galena, and native silver formed by the reduction of chloride.

## MINE WORKINGS.

The principal mine workings in the area represented on the Iron Hill map may be divided into the following groups, commencing at the south:

1. The Rock and Dome.
2. The La Plata and Stone.
3. The Lime and Smuggler.
4. The Silver Wave and Silver Cord, including the South Bull's Eye.
5. The Iron mine proper, including the North Bull's Eye.

**Rock and Dome.**—These two claims are owned and worked by the Iron Silver Mining Company. The former is opened by a tunnel running southward on the strike, the latter by an incline running eastward on the dip. The ore bodies thus far developed in either mine are found near the surface of the hill and may belong to the same bonanza, if the same north-easterly direction of ore shoots prevails here as does on Iron Hill. On the hillside, at the present mouth of the Rock tunnel, was formerly an actual rock outcrop, consisting largely of hard carbonate, from which the mine derived its name and where the first ore in place was found in this region. From it were no doubt derived the heavy fragments which caused so much annoyance to the early gulch miners.

From this tunnel level the ore has been followed along the contact of limestone and porphyry a certain distance upward or toward the outcrop, but mainly eastward in the trough of a fold and then downward on the dip. The workings have also been pushed southward with the intention of making a connection with the Dome workings. Beyond the crest of the fold to the eastward the contact has thus far proved comparatively barren, but at the lower extremity of the Rock incline ore has been found which may be the precursor of a second ore shoot.

In the Dome the rich ore has thus far been found near the mouth of the incline, in very considerable thickness and with a remarkable develop-

ment of masses of Chinese talc in the ore body, at some distance from the contact. The incline has not yet reached a second ore shoot in depth, though there is every probability that one will eventually be found there.

The ore in both these mines is mainly a hard carbonate, very rich in lead, but of comparatively low grade in silver. It is very thoroughly oxidized, and in some cases a red oxide of lead has been found in it. It occurs in bodies sometimes of considerable thickness and always at or near the contact. At the contact the alteration of porphyry into the so-called Chinese talc is very persistent, and when found in the ore body, as in the Dome mine, shows that offshoots of the porphyry had probably penetrated the limestone previous to the replacement of the latter by vein material.

Sections E and G, Atlas Sheet XXV, which pass through the Rock workings, show the fold in the limestone, which affords a good illustration of the tendency of the ore currents to deposit their load immediately above any sharp bend in the stratification.

La Plata, Stone, and A. Y.—The La Plata claim is opened by a tunnel 800 feet long, running south from near the bed of the gulch. Its direction was intended no doubt to correspond with the strike of the formation, but in point of fact it diverges a little to the westward, so that while at the mouth it is at the actual contact of the White Porphyry and Blue Limestone, it departs from it more and more as it advances. At the extremity, however, the contact bends sharply down to the south, so that a winze has been sunk 70 feet to reach it. It is noticeable that this bend is on a line with the eastward continuation of the California fault.

Below the mouth of the tunnel and in the body of the limestone is found the Gray Porphyry sheet, which to the north and south is found above the Blue Limestone and separating it from the White Porphyry. The contact in this mine was not found very productive. A small body of ore was found east of the tunnel, near its mouth, and a prospecting drift running to the Gneisson shaft, and continued some distance beyond it, found the usual evidence of mineralizing action, but no pay ore; it showed, however, a steepening of the dip of the formation of  $35^{\circ}$ . This, with the sudden steepening at the end of the tunnel, shows how difficult it is to count on any regularity in the dip of the formation until it has been actually proved. The

main ore developments have been in the body of the limestone, extending as much as one hundred feet below its surface, and are opened by the Rustin shaft. These and the similar ones in the Silver Wave ground are interesting as showing that the ore deposits are by no means confined to the surface of the limestone, as was originally supposed. The bodies are irregular in shape, but have their greatest extent in a nearly vertical direction. The slickensides found on their walls give evidence of some movement, and they were evidently formed by ore currents percolating along cross-joints or planes of fracture in the limestone, having a general north and south direction. The ore is oxidized and does not differ essentially in character from that in the adjoining mines.

The Stone claim was ingeniously outlined to take in the curving outcrop of the Blue Limestone as it crosses the gulch. The developments on it are mainly on the north side of the gulch, and have as yet opened no considerable ore bodies, though the evidences of replacement action are abundant. Probably a search below the contact for bodies similar to those of the La Plata might prove remunerative.

The shaft of the A. Y. mine, above the Stone claim, has developed an extremely interesting occurrence of unoxidized ore, a mass of galena, pyrite, and zinc blende, which was the only one reached in the Leadville region, though unfortunately not accessible, at time of visit. The ore is of low grade in silver, and hence of little value in competition with the more easily reducible oxidized ores.

**Lime and Smuggler.** — Directly opposite the Rock workings, and at a corresponding elevation on the north slope of California gulch, are the workings of the Lime, Smuggler, and adjoining claims, which, though not very extensive, are sufficient to give evidence of another zone where the limestone has been largely replaced by vein material. The minor folds in the limestone are here very sharp, the rock masses near the surface sometimes broken, and the replacement has been somewhat irregular, so that the continuity of the ore bodies is not always evident. Here, as in the Dome claim, a small thickness of White Porphyry separates the intrusive sheet of Gray Porphyry from the contact, as shown in Sections E and F. From the south incline of the Lime to the South Bull's Eye but little ore has

yet been developed along the contact. On the extreme north end of the Lime claim, an incline, not indicated on the map, was driven in on the contact until cut off by a wall of Gray Porphyry, standing at an angle of  $65^{\circ}$  with a strike to the east and northeast. This would seem to be an offshoot from the intrusive sheet in the lower part of the Blue Limestone. The form of this offshoot, shown in Section E, must be understood to be, in the present state of developments, purely a matter of conjecture. That ore bodies have not been found at the contact here is, however, not necessarily a proof that they may not exist within the body of the limestone, as will be seen from the description of the next group. Thin beds of shales carrying *Lingula* are found at the contact in the Lime and Bull's Eye claims, near the outcrop.

South Bull's Eye, and Silver Cord Combination.—A considerable body of rich carbonate ore was found along the contact and near the outcrop at the south end of the Bull's Eye claim, which has been developed by the so-called South incline. It was extremely irregular in shape, extending in places fifteen or twenty feet below the contact; its probable continuation in the Silver Wave ground is apparently even thicker. As shown in Section D, this body, like that already described in the Rock mine, occurs just above and on the crest of a fold in the limestone, whose axis has a northeast direction parallel to that of the ore body. The ore was quite rich near the surface, but became poorer in depth. To the south it passes into black iron (wad), containing little or no silver. The incline, which runs diagonally across the body and follows approximately the contact plane, has at first an inclination of  $12^{\circ}$ , and after passing the crest of the fold steepens to an average angle of  $25^{\circ}$ , and for short distances reaches  $45^{\circ}$  or more; the contact is here barren, showing only iron-stained clay and a little Chinese tale. This body, like that of the Rock mine, was one of the earliest developments in the district.

In laying out the side lines of the Bull's Eye claim it was the intention of the original locators to include within them, as they did so successfully in the other claims of the Iron Silver Mining Company, the outcrop of the vein or of the upper surface of the Blue Limestone. As it happened, however, the limestone rises at this point over a secondary fold, and the line

of contact bends backward, or up the hill, instead of following its normal grade along the slope, so that for a considerable distance the line of outcrop passes east of the Bull's Eye line and within the ground of the adjoining Silver Wave claim. A most valuable piece of ground was thus lost by an accident, which only an actual stripping of the limestone outcrop over its entire extent could have prevented. During the time this investigation was carried on, owing to pending litigation, the Silver Wave claim, which has since been consolidated with the claims adjoining it on the east, in what is known as the Silver Cord Combination, was not open to public inspection; nor could permission be granted to take copies of the maps of underground workings, as was in general freely accorded by the Leadville mine owners. The workings and outlines of ore bodies in these claims, as given on the map, are hence necessarily incomplete, being made up from data obtained from outside surveyors and from notes gathered during a rather hasty personal inspection of the workings.

The mine is opened by two inclines from the surface in the northern part, and by shallow shafts from which inclined drifts follow the ore channels in a very irregular manner, in other portions of the claim.<sup>1</sup> The main or most northern incline runs at an angle of  $15^{\circ}$ , striking the contact at 10 feet from its mouth, and thereafter running in the body of the limestone at an ever-increasing depth below the contact. It thus passes beneath a drift run southward from the fifth level of the Iron mine, which follows a barren contact. On the contact little good ore has been developed, but very rich ore, and probably in very considerable quantity, said to have produced many hundreds of thousands of dollars, has been obtained from bodies in the mass of the limestone, and extending in some cases to a depth of one hundred feet below the contact. In those visited, the outlines of the body, although irregular as in most ore bodies in limestone, have in general a northeast direction and stand nearly vertical. At their upper limits can be generally distinguished a distinct crack or jointing plane in the limestone, extending up to the contact, as evidenced by the entrance of water through it. On the other hand, at the lower limits of these bodies no trace of any opening could be found through which the ore solutions might have come

---

<sup>1</sup> On the map, by error in proof-reading, the parallel linings used to denote *inclines* have been omitted in this mine.

from below. In general outline the bodies seem pear-shaped, with the taper toward the top. Similar bodies are found around the Silver Cord shaft, also having a northeast trend, and, as the map shows, in a direct line with those in the Silver Wave and Grand View claims. East of the Silver Cord shaft a steeper dip in the formation comes in, which may be a continuation of the fold already noticed in the South Bull's Eye. It seems, then, that before the dynamic movement in this region there was a certain amount of fracturing of the beds, not, however, accompanied by any considerable displacement, and that along these planes of fracture the ore currents have penetrated into the body of the limestone, the ore deposition or replacement acting from their walls outward.

In the Silver Wave claim was also seen a freshly opened cave, one of the few that are found in the Leadville mines, and which is of interest as bearing on the generally-advanced theory that ore bodies in limestone are necessarily deposits in *pre-existing* cavities. It was somewhat funnel-shaped toward the top, about twenty-five feet in horizontal diameter, and contained no ore. Its walls, which had the wavy surface common to water-worn limestone, were covered with a thin coating of fine reddish ooze or slime. An examination of the walls showed that these were in part of unaltered limestone and in part of ore and vein material, which could not be distinguished from each other until the coating had been removed. It was thus evident that the cave was of comparatively recent formation, made by the percolation of surface waters and carved out of limestone and ore body indifferently; hence, that it is entirely posterior to the deposition of the ore, which was formed before surface waters, as the term is generally understood, could have reached to this depth.

**Iron mine proper.**—The underground workings of the group of claims which are exploited from the various shafts and inclines of the Iron mine cover an area of about twenty-five acres, being the most considerable of any single mine in the district. They have been driven a distance of over fifteen hundred feet along the contact eastward from the outcrop, or rather from the fault line, since at the peculiar eastward bend of the fault plane in the Iron and Iron Hat claims the limestone does not actually come to the surface.

The Iron Hill map shows the principal underground drifts in this area, taken from the actual working maps of the mine, the level of different points in these drifts being given by figures which denote their respective elevations above the 10,000-foot curve. The outlines of the ore bodies are given in generalized form, as deduced from the same maps and from personal observations. As in the case of all the mine maps, both drifts and ore bodies are indicated in projection, that is, as if the ground over them were transparent, and in this respect they differ from and are independent of the geological colors, which indicate the formations constituting the rock surface.

The mine is opened by three principal inclines, the North, Main, and South, the last of which is no longer in use. The bulk of the ore is extracted through the middle or Main incline, which is carried down at an angle of  $12^{\circ}$  to  $13^{\circ}$  in approximate conformity with the surface of the limestone; it is provided with powerful hoisting engines and has a double track. In Atlas Sheet XXIV a section is given through each of these inclines, designated A, B, C, respectively, the line of the last running partly through the North incline of the Bull's Eye claim, which adjoins the line of the Iron claim.

In this area the contact has been and is productive over an unusually large surface, the main ore body extending diagonally through the claims in a northeast direction from the croppings, with an average width of 200 feet. This productive zone is separated from the zone of the adjoining Silver Cord Combination by comparatively barren ground; that is, barren as far as present explorations have gone, although it is not absolutely certain that ore may not still exist in the body of the limestone. The irregularity with which the replacement action of the ore currents has acted upon the limestone is well shown in the Main incline. Here, after the ore had been extracted along the actual contact from the first to the fifth level and it was supposed that pay ore in this area was quite exhausted, it was found in one place to extend considerably below what was supposed to be the floor of the ore body, often simply a layer of black chert, and a lower drift was run back from the fourth station in the direction of the fault, disclosing a very large body of vein material and rich ore, extending nearly to the fault plane,<sup>1</sup>

<sup>1</sup> Later developments have shown that this ore body extends actually to the fault plane: Several thousand tons of ore have been extracted from it through the new McKeon shaft, at about fifty feet below the contact.

and in places reaching a depth of 40 feet or more below the actual contact of limestone and porphyry.

In Section C, which passes through the North incline of the Bull's Eye, and a little south of the South incline of the Iron mine, the tendency of the rich ore to accumulate above a fold in the limestone, which has already been noticed in the Rock and South Bull's Eye, is quite apparent, the barren zone occurring on the steeper dip of the formation towards the Silver Cord claim.

In the section through the Main incline the folds are less prominent, but the same tendency always holds good, and it is one of the practical generalizations made by those working in the mine that rich ore bodies occur always in troughs of the limestone. The steeper dip of the formation beyond the accumulation of rich ore is quite evident. Just below the seventh level a small body of Gray Porphyry crosses the Main incline diagonally in a direction a little north of east. Here the incline is some distance below the contact, and it could not be definitely determined whether the porphyry extended up to the contact or not, though it has unintentionally been indicated as doing so in the section. To the westward, if it continues in that direction, it does not, as the contact has been explored on the line of its continuation without finding it. It is cut in the eighth level a short distance north of the Main incline, but in neither case is the limestone mineralized to any extent at its contact.

On the line of the North incline the general dip of the formation has become extremely shallow, as shown by the old drift, known as the Tueson incline, which followed the contact in all its curves and irregularities. This shallowing of the dip is probably due to a general basining-up of the formation to the northward, since on North Iron hill in the Adelaide and Argentine ground it curves in strike to the eastward and assumes a southerly dip. Thus at the Hynes shaft, which is on the same line of strike with the Tueson shaft, the contact stands about fifty feet higher than at the latter.

In this portion of the mine a second series of less important ore bodies occurs in a depression in the limestone to the west of the main bonanza and near the fault line. It has, like the latter, a general northeast trend.



Whether it will lead to more important developments in that direction explorations have not yet been sufficiently extensive to determine.

The main ore body on this line extends more or less continuously from a little above the fifth level eastward to the bottom of the Tucson shaft, being mainly concentrated between the fifth and eighth levels, where it extended at times to a depth of 30 feet or more below the contact. A very interesting feature of this remarkable ore body is the occurrence of a body of Gray Porphyry, cutting up into the limestone and at one point reaching the contact with the White Porphyry. It has no apparent connection with the body already mentioned in the Main incline. At the time of examination it was so little explored that but little could be ascertained as to its form or extent, and the representation given in Section A is almost entirely ideal. It is there drawn as extending across the contact into the White Porphyry, for the reason that Mr. Jacob found White Porphyry under it in the old Tucson drift, where it runs above the North incline. Both north and south of this line, however, it does not reach the contact, and ore and vein material are continuous over it. Later developments have shown that the ore extends to a considerable depth into the limestone along its contact and that its general direction is northwest and southeast.

It is probable that both these bodies of Gray Porphyry are irregular offshoots from the main intrusive sheet at the base of the Blue Limestone and differ from the ordinary dike. The fact that the one which crosses the general direction of the ore bodies is accompanied by a concentration of rich ore in its vicinity, while that which runs parallel with this direction is not, is in accordance with the conditions found in connection with such cross-cutting bodies of porphyry on Carbonate and Fryer Hills and with the theory that they are favorable to the concentration of ore when so situated, in that they would produce a retardation in the flow of the ore solutions and thus give them more time to deposit their load.

It was in one of the drifts running north from the North incline, at the sixth level, that a mass some two feet in diameter was found, composed mainly of native sulphur associated with a little carbonate of lead. As it

was comparatively free from iron oxide, it seems evident that it must have resulted from the reduction of galena, the lead having been removed in the state of carbonate.

In the body of the limestone, on the eighth level not far from the North incline, a natural jointing plane, forming one wall of the drift, was observed to be coated with fine, silky, white crystals, which chemical examination proved to be calamine or silicate of zinc. If the sulphureted ores, which will undoubtedly be found when the mine workings shall have reached the limits of the zone of oxidation, are as rich in blende as those which have been found in the A. Y. mine, it seems singular that little or no zinc has hitherto been found associated with the oxidized ore. This occurrence would seem to show that, owing probably to greater solubility, the alteration products of blende have been removed during secondary deposition to a greater distance from their original location than those of the other sulphurets.

In the lower levels of the mine there has been a notable increase in the proportion of unaltered galena in the ore, but as yet no pyrites or other sulphurets have been found. While specimens of galena are still found which average as high as 1,200 ounces of silver to the ton, the general tenor of the ore is lower than near the outcrops, and the evidence afforded by the records of assays, which were very systematically kept in this mine, shows that there has been a gradual but comparatively steady decrease in the average tenor of the ore in silver with the progress in depth. These records further show, and their evidence was confirmed by numerous tests made in the laboratory of the Survey, that no reliance can be placed on a relation assumed by some to exist between the coarseness or fineness of grain of a galena and its contents in silver.

Explorations to the eastward beyond the Tucson shaft and in the lower part of the Main incline have been carried on along the contact line thus far without very remunerative results. It would seem probable that ore might be found in this direction in the body of the limestone, and possibly in more or less direct connection with the cross-cutting sheet of Gray Porphyry, from which those above mentioned are offshoots and which may be assumed to be at a considerable depth below the contact in this eastern region.

*Relation of Iron fault to ore bodies.* — In the area under consideration the plane of the Iron fault has been cut in so many places as to render its tracing practically continuous at its intersection with the contact. Its continuation has also been traced through the porphyry above the contact to the surface. Winzes have been sunk just north of the Main incline to a depth of 100 feet on the fault fissure, and from the McDonald shaft 65 feet, as shown in Sections A and B. Examinations of these workings, and descriptions of them where they were no longer accessible, render it very evident that the faulting has been posterior not only to the intrusion of the porphyry, but also to the deposition of the ore.

It has been soberly maintained by some experts when testifying in lawsuits that the faulting was previous to the eruption of the porphyry and that the latter flowed down over the successive benches formed by the faults, following their surfaces. A consideration of the general geological structure of the region, where instances abound showing that porphyry bodies and sedimentary beds were both folded and faulted together, should be sufficient to show how untenable is such a theory; but a sufficient refutation is found at this very point in the fact that the fault plane can be traced up to the surface through the overlying porphyry.

That the ore was originally deposited previous to the faulting is less self-evident, since in places there is a certain amount of alteration of the limestone adjoining the fault plane and since ore has been actually found in the fault fissure, which often has a width of three feet or more and is filled with a dark clayey mass, bearing a certain resemblance to vein material. The alteration is only such as might have been expected from the action of surface waters passing across the ends of the contact adjoining the fault, and consists merely in a slight impregnation or replacement of the limestone by oxides of iron and manganese. This action extends at most only a few feet into the limestone and is confined to a region comparatively near the surface. Had the original ore-bearing currents actually followed the plane of the fault, ore deposition would have extended to a much greater distance into the body of the limestone from the fault plane than from its upper surface, inasmuch as far easier access to percolating waters would have been afforded by the numerous bedding planes.

As regards the question of ore found along the fault plane, it may readily be conceived that in the dragging movement of the edges of two immense bodies of rock, the one against the other, during the fault displacement, a very considerable amount of the adjoining rock could be broken off and carried along for some distance from its original position. The greater part of this material would be clay from the porphyry, but with it would be mixed a certain amount of limestone and ore. The circulation of waters from the contact plane on either side, and therefore carrying more or less mineral matter in solution, might occasion a secondary replacement of this limestone by ore. It is even conceivable that in contact with the inorganic matter, which must have been present, sulphates might have been reduced to sulphides and galena have been deposited, but, unless the mineral were found in the limestone outside of the attrition material of the fault fissure, it would not be a proof that it was an original deposit before the fault movement.<sup>1</sup>

<sup>1</sup>In the years that have elapsed since this was first prepared for the press, a new shaft has been sunk 110 feet south of the Main incline for the purpose of exploring the fault plane. The data obtained from this by personal observation and from information furnished by Mr. F. T. Freeland, engineer of the mine, and who was present during all the explorations, furnish a remarkable confirmation of the above views. The shaft was sunk to a vertical depth of 306 feet, but at an angle of 50°; drifts were run on the fault plane at four levels, that on the second level having a total length of 2,000 feet. In this level the sharp eastward bend of the fault plane has practically disappeared. On the first level, which corresponds to the third level of the Main incline, a considerable amount of ore was obtained from the lower ore body. Ore was also obtained at various depths on the fault fissure below this level. In regard to this ore, the following facts were observed: First, the ore was always found within the walls of the fault fissure; secondly, it occurred in masses rounded as if by attrition, and evidently foreign to the clayey filling of the fissure in which it was imbedded; thirdly, no ore was found outside of two vertical planes drawn through the intersection of the boundaries of the main Iron mine ore body with the fault plane. It is interesting to compare the actual section obtained in this shaft with that given in Section B, which was a theoretical deduction from data obtained at other points. The angle of the fault was found in depth to average 50°, instead of 65°, as had been deduced from observations near the surface.

Thickness of—	Section B.	McKeon shaft section.
	<i>Feet.</i>	<i>Feet.</i>
Slide and White Porphyry.....	40	45
Blue Limestone and vein material....	200	192
Parting Quartzite.....	24	10
Gray Porphyry .. .. .	48	72
Contact of White Limestone at .....	312	319

## NORTH IRON HILL.

Atlas Sheet XXVI shows the topography, geology, and principal mine developments of the northern end of Iron Hill, overlooking Stray Horse gulch, and forms, as aforesaid, really a portion of the main map of Iron Hill. In this region ore was first discovered on the Camp Bird claim in the autumn of 1876. At present the principal mine workings belong to two companies, the Argentine and the Adelaide, the former of which owns the Camp Bird and Pine claims, and the latter the Terrible and Adelaide claims; the latter overlaps those of the former company, a fact which has given rise to much litigation.

**General geological structure.**—As compared with Iron Hill proper, its geological structure is one of extreme complexity, and also difficult of exact determination, for the reason that underground workings are few and accessible in but a comparatively small portion of the area.

In the region west of the Iron fault the structure indicated on the map is deduced from data obtained outside of its area, and to that extent is theoretical. That the Blue Limestone basins up to the eastward as it approaches the fault is proved in the Devlin shaft, which reached it at a depth of 200 feet, and in the Highland Mary and other shafts, in Stray Horse gulch just north of the limits of the map, which found it still nearer the surface. The outcrop indicated in the northwest corner of the map is a portion of the Blue Limestone, split off from the main body, corresponding to that cut in the Agassiz and adjoining shafts, and forming the south end of the Little Stray Horse Park synclinal basin, as explained in Part I, Chapter V.

East of the Iron fault the formations rise slightly to the northward, so that their strike assumes a more easterly and westerly direction and dips to the south and east. By the erosion of Stray Horse gulch, on the lower part of the steep northern slope of Iron Hill, a succession of Paleozoic formations down to the Lower Quartzite are exposed, while by the movement of the Adelaide fault, which crosses the northeast corner of the area mapped, a still lower series of beds is exposed beyond it.

The most striking peculiarity of the structure is the cutting across of the Blue Limestone formation by the White Porphyry, this region being on the line already mentioned as extending from Fryer Hill to West Sheridan, where this cutting down of the White Porphyry sheet occurs. Its effect is graphically shown on Atlas Sheet XXVII, Section B. It will be observed that whereas at the south end of the section the White Porphyry occurs, as it generally does, above and parallel with the Blue Limestone, at the northern end, where exposed by the workings of the Argentine mine, it crosses the basset edges of the Blue Limestone, and at the outcrop it probably comes in contact with the underlying Parting Quartzite. As the remainder of the Blue Limestone, above the cross-cutting of the White Porphyry, has been removed by erosion, it is not possible to determine whether it was mineral-bearing or not. As far as determined by the present workings the deposition of the richer ore has gone on, not as is ordinarily the case at the contact of the White Porphyry with the Blue Limestone, but at its contact with the Parting Quartzite.

**Iron fault.**—In this area the Iron fault is struck in the Iron Hat shaft, and on the Codfish Balls claim by a shaft and tunnel. Beyond this claim to the northward its location is only approximate, though beyond the limits of the map it is determined very closely by adjoining shafts on either side. Its movement is the same as it was at the south, namely, an upthrow on the east, but the amount of that throw is constantly decreasing as one goes north.

**Adelaide fault.**—The location of this fault is also approximate, owing to the infrequency of shafts in its neighborhood, and also to the fact that it often has porphyry on either side. Its movement is a slight upthrow on the northeast. Its location is determined by the discrepancy of the formations disclosed by the Laura Lynn, Park, and adjoining shafts in Adelaide Park, and by the Double Decker group of shafts opposite the Argentine tunnel, on the one side, and by the workings of the Adelaide and Argentine mines on the other.

**Rock formations.**—The sedimentary formations disclosed in this area are the same succession of Paleozoic beds, from the Lower Quartzite up to the Blue Limestone, that outcrop on the southern end of Iron Hill. The por-

phyry masses are, however, much more varied and numerous. It may be safely assumed that they are mostly intrusive sheets, but the underground workings are not yet sufficiently extensive to determine whether they may all be considered so or not. As has already been noticed in the general description, Part I, Chapter V, there is reason to suppose that one body of Gray Porphyry, extending from Adelaide Park up the south slope of Yankee Hill, has cut up across the formations from below.

The different bodies of porphyry that have been thus far disclosed in this portion of the hill may be enumerated as follows, commencing with those which stand the highest in geological horizon: (1) The main body of White Porphyry overlying the Blue Limestone; (2) a second sheet, cutting across the basset edges of the limestone and connected with No. 1; (3) a small body of Gray Porphyry between No. 2 and the Parting Quartzite; (4) a thin sheet of White Porphyry, splitting the Parting Quartzite into two parts; (5) a heavy body of Gray Porphyry, with two smaller sheets, probably offshoots, above and below it, respectively, all three in the White Limestone; (6) a lower sheet of White Porphyry, also in the White Limestone. The distribution of these bodies and their probable extent can be best seen by reference to Atlas sheet XXVII.

Section A, drawn at an oblique angle to the strike, passes first through the Argentine ground and then through the Adelaide, showing the distribution of the ore bodies in the latter. At its southeastern extremity only White Porphyry is given as cut by it, as it is supposed to be in the strike of the cross-cutting body of this rock. In the entire want of any actual data this theoretical representation may not be absolutely correct. The Blue Limestone is split into two wedge-shaped and probably overlapping bodies. The upper or northeast portion has been eroded off in the Adelaide and Argentine ground. Whether it has also been removed here, as represented in the section, or whether a portion should be shown in the White Porphyry, can only be determined by actual developments. The lower wedge-shaped portion of the Blue Limestone, extending to the south and west in normal contact with the Parting Quartzite, is supposed to come in a short distance southwest of this line, as shown in Section C, whose eastern end is nearly in the plane of Section A.

Section B, drawn approximately through the line of the Argentine tunnel and at right angle to the line of strike, gives the best representation of the geological structure, the lines having been determined by careful measurement. Section C, on the other hand, is rather a theoretical representation of what may probably be found on this line, reasoning from what is observed on either side of it, there being no underground explorations on its plane.

**Ore deposits.**—Deposition of ore in this region has been extremely irregular, as might have been expected from the complicated nature of the different intrusive bodies which have traversed the sedimentary formations. The main body of rich ore thus far discovered has been, as already mentioned, at the contact of White Porphyry and Parting Quartzite. This is found mainly in the Camp Bird and Pine claims, coming actually to the surface as an outcrop. It is not improbable that this and the small bodies found in the Adelaide mine are the replacement of isolated portions of the Blue Limestone, detached from the main body by the intruding porphyry. There is evidence also of considerable replacement action all along the contact of the White Porphyry with the Blue Limestone, both on the basset edges and on the upper surface of the latter.

In the Adelaide mine, as shown by the developments of the Ward and Adelaide shafts, the ore occurrence is extremely irregular. Lenticular bodies or pockets of sand carbonate are found between the White and Gray Porphyry and at the contact of the latter with the Parting Quartzite. Moreover, at the bottom of the Ward shaft a considerable body of vein material is said to have been opened in the lower Gray Porphyry, from which some silicates of copper were obtained. At the time of visit these workings were abandoned and could not be examined. The ore in general is carbonate of lead, with the usual gangue of iron oxide, but here rather silicious, as might be expected from the country rock. The masses of sand carbonate found in the Adelaide mine are remarkably pure, and have the appearance at a little distance of a white quartz sand. They contain, however, but little silver. A complete analysis of a specimen of one of these may be found in Appendix B, Table VIII. It contains about 95 per cent. of carbonate of lead, with a slight admixture of pyromorphite or chloro-phosphate of lead.



## MINE WORKINGS.

The underground workings of this portion of Iron Hill are almost exclusively confined to the Argentine and Adelaide mines.

**Argentine.**—The Argentine mine is opened by the Camp Bird and Argentine tunnels and the Loker and Hynes shafts. The old workings on the Camp Bird claim are now mostly abandoned. The ore was found quite near the surface, resting on the Parting Quartzite, which is here 30 feet thick and contains no White Porphyry, as it does in the Argentine. This contact does not seem to have been followed in depth. Indeed, the geological relations of the ore bodies were so little understood in early times that no systematic exploration could be carried on.

In the Pine claim the main ore body was also found near the surface and above the level of the Argentine tunnel. It was afterwards traced down along the dip southward to a level 80 feet below the Argentine tunnel, then southeastward into the Adelaide claim, following nearly the line of the strike, but rising a little—that is, diverging to the eastward.

**Argentine tunnel.**—Ore is extracted through the Argentine tunnel, the Loker shaft being used simply for ventilation purposes. This tunnel is over twelve hundred feet long, running first a little east of south and then bending to the west of south. It crosses the Adelaide claim, on agreement with that company, in order to explore the ground beyond. The geological structure, as exposed by this tunnel, was for a long time a complete puzzle to those who were working the mine, owing to the difficulty of distinguishing the different rocks from one other when bleached and altered. Even now a chemical test is often necessary. After passing through surface Wash the tunnel crosses the upper part of a body of White Porphyry into White Limestone. About seventy-five feet from the mouth a small gash vein in the porphyry, carrying galena, is said to have been found, upon which a winze was sunk. In the White Limestone a narrow sheet of bluish-gray porphyry is found before the tunnel enters the main body of Gray Porphyry, which at the contact is quite bleached by decomposition. Some iron-stained vein material is also found on the contact. Beyond, the tunnel again passes through White Limestone for 150 feet, another small sheet of porphyry being cut about midway in this distance. Parting Quartzite and

White Porphyry are then crossed, these being likewise very difficult to distinguish from each other underground. At the Blue Limestone contact, which occurs at the bottom of the Loker shaft, no ore is found on the tunnel level. A drift runs off to the eastward about one hundred and twenty-five feet from the Loker shaft, through which the ore stopes both above and below are reached. From the Loker shaft the tunnel runs for about five hundred feet in the Blue Limestone, which has an average dip of  $15^{\circ}$  to  $20^{\circ}$  to the southeast. Wherever raises have been made to the porphyry above, barren vein material has been found. This also reaches the tunnel level at times, following bedding or joint planes in the limestone. In one case a drift and winze have followed a considerable mass of vein material in the limestone, but without finding pay ore. Near the end of the tunnel the normal contact between limestone and porphyry is crossed. The limestone is here of lighter color, seamed with white calcite, and somewhat brecciated.

At the bottom of the Hynes shaft, with which the tunnel is intended to connect, drifts have been run upon the contact, disclosing some vein material. The dip of the formation is here shallower and to the southward. Above the contact are found quartzite and shales, belonging to the Weber Shale formation, between it and the White Porphyry, as in the Bull's Eye and Lime claims.

While the pay ore in this mine has been found at the contact, not of the Blue Limestone, but of the Parting Quartzite, it does not, so far as known, extend between these two formations. This would readily be accounted for on the theory that these ore bodies are the replacement of a portion of Blue Limestone left between the Parting Quartzite and the White Porphyry at the time of the intrusion of the latter.

*Adelaide.*—The ore bodies in the Adelaide mine are much more disconnected and irregular than in the Argentine. The mine has been mainly worked by a number of isolated shafts, and owing to complexity of the geological structure the ore bodies have not been systematically followed, so that, as many drifts were closed at the time of visit, the geological data are less complete than could be desired. The main difference in the formation between this and the Argentine is the occurrence of a later intrusive sheet of Gray Porphyry between the White Porphyry and the Parting

Quartzite, which seems to be somewhat irregular in form and of limited extent. The ore occurs both above this body, between it and the White Porphyry, and below it, or at its contact with the Parting Quartzite. A fragment of unreplaced Blue Limestone is also found resting on the Parting Quartzite and separating it from the overlying White Porphyry. This would seem to indicate the possibility that many, if not all, of the ore bodies are the replacement of similar fragments of limestone left by the irregular cutting of the porphyry.

The so-called Adelaide Discovery is a tunnel about fifty feet east of the smelter, adjoining Stray Horse gulch. Here was an outcrop of three or four feet of hard carbonate ore, dipping  $15^{\circ}$  to  $20^{\circ}$  to the southeast and resting on Parting Quartzite. The tunnel, which starts in a little above the outcrop, ran into Blue Limestone, and a winze from its end is said to have struck the quartzite below.

The most important developments in the mine have been made in the Ward shaft. This was sunk first through 170 feet of White Porphyry, which was much decomposed and for a considerable distance stained a brilliant red, apparently by anhydrous oxide of iron. At this depth was a layer of carbonate of lead, below which were 20 feet of decomposed Gray Porphyry and a second layer of ore resting on coarse-grained Parting Quartzite 15 feet in thickness. Below the quartzite was 20 feet of White Porphyry, and again five to six feet of quartzite, representing the balance of the Parting Quartzite formation. Below the quartzite the shaft passed through 75 feet of a very hard, jaspery material, consisting mostly of silica, with only about 5 per cent. of oxide of iron, which is a replacement of the White Limestone. When this material was freshly taken out it contained in seams and cavities a reddish gelatinous substance that resembled gelatinous silica in the process of deposition, which would indicate that the replacement of limestone and deposition of silicious matter are still going on. Below this the Gray Porphyry, very much decomposed, was penetrated to a depth of 57 feet. Almost all the decomposed iron-stained material taken from the shaft would assay one to five ounces of silver to the ton. At a depth of 330 feet from the surface the porphyry was impregnated for some eight feet with silicate and carbonate of copper; some red oxide and a little native copper were also found. The ore pockets found occurring

above the Gray Porphyry consisted of remarkably pure white sand carbonate, free from admixture of clay and showing no galena. A complete analysis of a specimen taken from this horizon may be found in Appendix B. Those below the Gray Porphyry, whose connection with the ore body in the Argentine mine was afterwards traced, consisted of carbonate of lead, with iron-stained vein material, and in some cases, where the ore extended down into the quartzite, of unaltered galena.

The Adelaide No. 2 shaft found no ore at the contact of the White and Gray Porphyries. It was sunk through the lower ore body, the upper portion of the Parting Quartzite, the White Porphyry included in it, and into the lower body of Parting Quartzite.

The Terrible No. 2 shaft was sunk through Gray Porphyry, Parting Quartzite, White Porphyry, and Parting Quartzite again, into the White Limestone. No ore was found at the contact, and the White Limestone was not replaced, as in the Ward shaft, but was a crystalline rock with some decomposed iron-stained material at its upper surface, and with layers or lenticular bodies of white chalcedony throughout its mass, which are characteristic of this horizon.

The ore occurrence in these mines is distinguished from that of the majority of mines in this district by a total absence of manganese, a small amount of iron oxide, a relatively low tenor in silver, and a more frequent occurrence of gold, some of the fragments which occur in the quartzite being comparatively rich in this metal. The occurrence of copper ore in the Gray Porphyry is also exceptional, the nearest analogy being the body in the Little Johnnie and Uncle Sam, on Breece Hill, overlooking South Evans gulch.

**Double Decker.**—On the north side of Stray Horse gulch, opposite the Argentine, are the two shafts of the Double Decker mine, which have obtained from the Lower Quartzite a certain amount of gold ore. At this point all the overlying strata have been removed by erosion and the Lower Quartzite forms the rock surface. Both shafts have been sunk in this formation, and one of them has passed through it into the underlying crystalline rocks of the Archean. Neither was being worked at the time of examination, consequently no detailed information could be obtained, nor were any data as to amount or value of ore extracted available.

## CHAPTER III.

### CARBONATE HILL GROUP.

#### GENERAL STRUCTURE.

The geological structure of Carbonate Hill<sup>1</sup> is very similar to that of Iron Hill in that it is formed by a series of easterly-dipping beds broken on the west by a line of faulting or displacement. Outcrops are also exposed on its southern face by the erosion of California gulch, but in a less complete series, owing to its being shallower and proportionately wider, in consequence of which the bounding slopes are less steep and more thickly covered by surface débris. The fault is nearly parallel to that of Iron Hill, and, like it, merges into the axis of an anticlinal fold on the north. In the southern half of the hill, however, the movement of displacement is distributed in part to a second nearly parallel fault a short distance to the west. Of the southern continuation of these faults less satisfactory data are available, but they are supposed to merge together before crossing California gulch, and probably pass into an anticlinal fold under the Lake beds to the southwest, like the Dome fault, the normal continuation of the Iron fault. As on Iron Hill, there is also evidence of a basining-up of the beds of the relatively down-thrown mass on the west as they approach the fault; in other words, of a synclinal structure. Upon this evidence, which will be given later in full, depends the solution of the important question whether ore bodies exist under the present site of Leadville or not.

**Rock formations.**—The series of beds of which the hill is composed is essentially the same as that given in the Iron Hill section, but the distribution of the later intrusions of Gray or Mottled Porphyry differs somewhat in detail.

---

<sup>1</sup> See Atlas Sheets XXVIII, XXIX, and XXX.

Where these cross the beds, either as dikes or sheets, there is a noticeable enrichment of the ore bodies. One main sheet of Gray Porphyry is found at or near the base of the Blue Limestone, which apparently cuts up to a higher horizon in different portions of the hill. A second sheet is found in White Limestone in California gulch, as shown on the map; but as none of the underground workings has penetrated as yet to this depth, there is no evidence to show whether this is a distinct sheet or merely an offshoot from the main body.

**Carbonate fault.**—The movement of displacement by faults on Carbonate Hill is considerably less than on Iron Hill, though its total amount cannot be definitely determined. As in the case of the former, the movement decreases to the north and the fault gradually passes into an anticlinal fold. In the southern portion of the area represented on the map this movement is distributed between two faults, the Carbonate and the Pendery. The Carbonate fault here runs nearly on the dividing line between the Carbonate and Ætna claims, cutting across the extreme southwestern corner of the former and the northeastern corner of the latter. It is proved in the No. 5 shaft of the Ætna claim, and in the Meyer shaft, which has been sunk following its plane till the contact on the west side was reached. As here shown, it stands with an inclination of about  $60^{\circ}$  west, shallowing somewhat in depth and having a movement of displacement of only about two hundred and fifty feet. The hanging wall has smooth and clearly defined slickensides surfaces, while the limestone in the foot wall is somewhat altered. The plane of the fault is occupied by selvage material, which is slightly impregnated with chloride of silver and contains occasional fragments of ore. The plane of the Carbonate fault has also been cut in the lower shaft of the Yankee Doodle claim. Beyond that point to the northward it has not actually been proved, and is located simply by discrepancies of level between adjoining underground workings. There is some reason to assume that to the northward, in the Waterloo claim, the movement of the fault has become nil, or is even reversed, that is, that there is a slight downthrow to the east, as shown in the Henriett-Waterloo section, Atlas Sheet XXIX.

*Pendery fault.*—A short distance west of the Glass shaft, a second fault, apparently nearly parallel and having the same angle of inclination with the Carbonate fault, cuts off the limestone, no explorations west of this line having reached below the White Porphyry. Its probable continuation has been traced southward to a connection with the Carbonate fault, and northward through the Washburne and St. Mary workings, where it appears to be accompanied by minor faults and folds, into a probable anticlinal fold running north through the Niles-Augusta, and then northwestward, opposite the Half Way House claim.

*Morning Star fault.*—In the workings of the Morning Star mine a small fault is found (shown in Section C, Atlas Sheet XXIX), in which the downthrow is to the east. It is probably only local in character and corresponds to the sharp bend in the beds observed in the Evening Star and Catalpa. It was only observed at one point, and is not therefore indicated on the surface maps, as its direction would be purely hypothetical.

*Ore deposits.*—The materials composing the ore deposits of Carbonate Hill are essentially the same as those of Iron Hill; they may perhaps be said to be poorer in bases of iron and manganese and proportionately richer in silica; therefore less favorable for the smelter; but this characteristic is rather one to be confined to individual mines or parts of a mine than applied in a general way. Silica occurs less frequently as chert and more commonly as a very finely granular and somewhat porous quartz rock than on either Iron or Fryer Hill. The ore is either galena or its secondary products, carbonate of lead and chloride of silver. In one instance native silver has been found. Dechenite, or the vanadate of lead, has been detected in ore from the Evening Star and Morning Star mines by Dr. M. W. Iles.<sup>1</sup>

Exceptionally good opportunities are offered for observing the action of replacement and the gradual passage from dolomite into the earthy oxides of iron and manganese. The workings not yet having reached the great distance from the surface that they have on Iron Hill, no such definite evidence is found of decrease in the action of surface waters producing oxidation and chlorination of the original deposits. The limit of the zone of oxidation would, moreover, be expected to be farther from the surface on account of its lower altitude.

---

<sup>1</sup>American Journal of Science, May, 1882.

Southwest slope of Carbonate Hill.—The detailed map of Carbonate Hill (Atlas Sheet XXVIII), while including the principal mines, covers only the northern portion of the western slopes. For the geology of the southern portion, in which as yet no ore bodies of importance have been developed, reference must be had to the general map of Leadville (Atlas Sheet XIV), on which the limits of the detailed map are indicated. South of these limits the Prospect incline, the Rosebud and Deadbroke tunnels, on the north side, and the Jordan and Swamp Angel tunnels, on the south side of California gulch, follow the upper surface of the Blue Limestone. While this surface shows evidence of mineralization in the characteristic iron-stained material generally found at the contact and in the frequent occurrence of the so-called Chinese talc, supposed to be the product of the alteration of the porphyry by mineral solutions, it has thus far been found comparatively barren of rich ore bodies. In the Prospect incline, about three hundred and seventy-five feet from the mouth, the surface of the limestone, which had hitherto been wavy, as it is generally found, suddenly drops down almost perpendicularly for 125 feet; 60 feet farther on in the line of the incline, however, the limestone is found following its normal dip to the eastward. This is apparently a very sharp fold in the limestone, accompanied by a certain amount of faulting. It is approximately on the line with the sharp fold which will be described hereafter as running through the Carbonate and Yankee Doodle mines, but the accumulation of rich ore, which in these mines is found above the fold, is here wanting.

The only actual rock exposure in this region is that of the White Limestone in the quarry on the north side of California gulch. From a prospect hole sunk by placer miners in the bed of California gulch, above the flume, casts of a *Rhynconella*, in a sandy white limestone, are obtained.

Of the two porphyry sheets which are indicated here, the upper one, near the base of the Blue Limestone, has been traced from the Irish Giant shaft to the Silver Star, and from that, a little below the John Harlan, across the gulch to the Logan and Broadway shafts, on the south side. This is evidently the same sheet which to the north occurs near or at the base of the Blue Limestone and in the Henriett and Waterloo claims cuts up across it into the White Porphyry. The lower sheet of porphyry occurs in the



White Limestone and is best exposed in the bed of California gulch. It does not seem to extend far up on Carbonate Hill, as it was not struck in the O'Donovan Rossa shaft. Parting Quartzite, which forms the upper part of the Silurian limestone, is here very coarse-grained.

The evidence for determining the line of the Carbonate fault in this region is not very plentiful. A shaft and drill-hole have been sunk on the northern bank of California gulch, south of the Harrison smelter, to a depth of 200 feet in White Porphyry, and are thus evidently to the west of the fault. The Blind Tom shaft, on the road south of the California tunnel, which was sunk 130 feet in White Porphyry, is also west of the fault; while another shaft, 50 feet south of this, was sunk in Silurian limestone, and is hence east of the fault. The California tunnel (T-48) has been run into the hill about seven hundred feet in a direction E.  $15^{\circ}$  S., or magnetic east. The first 585 feet it is in White Porphyry, from which it passes suddenly into the Blue Limestone, across a clay selvage. This is supposed to be the line of the Pendery fault, although the average dip is only  $30^{\circ}$  to the westward, and it might possibly be supposed to be a folding of the limestone downward in that direction. Unfortunately, the bedding planes are not sufficiently distinct at this point to determine the question of a westerly dip. There seems to be little doubt, from the extensive slickenside surfaces, that, even if there be a westerly dip, there has also been considerable faulting movement. The tunnel runs for the rest of its extent in Blue Limestone, in which, toward the end, the bedding becomes quite distinct and the dip assumes the normal angle of  $20^{\circ}$  to the eastward. It is evident from its lower position relatively to the outcrops of the Blue Limestone on the hill above that this is a continuation to the south of the portion of that body in the Ætna claim which is west of the Carbonate fault and between it and the Pendery fault. The line of the Carbonate fault has therefore been drawn on the map according to this indication. It was observed that the timbers supporting the roof of the tunnel from its mouth to the limestone (which, owing to the soft and yielding character of the porphyry through which it runs, were placed exceptionally close together) had a slight and uniform inclination of  $5^{\circ}$  from the perpendicular to the west. It is not to be supposed that they were originally placed in this position, and the infer-

ence is therefore justifiable that the whole mass of rock above the tunnel has had a slight movement to the westward since the tunnel was run.

The underground workings of Carbonate Hill may, for convenience of description, be divided into two groups:

1. A southern, including the Carbonate, Little Giant, and Yankee Doodle claims, to the east of the main fault, and the *Ætna*, Glass-Pendery, and other claims, below or to the west of it.

2. A northern group, including the Crescent, Catalpa, Evening Star, Morning Star, Waterloo, Henriett, and adjoining claims.

#### SOUTHERN GROUP OF MINES.

The description of Carbonate, like that of Iron Hill, will commence with the southern end, reversing the order in which the sections are lettered, because the claims at this end were first opened and because the geological structure is more clearly and easily shown in their workings. In the Carbonate, Shamrock, Little Giant, and Yankee Doodle claims, east of the fault, the principal developments have been made on what is practically one ore body, running in a northeasterly direction from its outcrop on the Carbonate claim. A noticeable feature of the structure is that this ore body is bounded on the southeast by a prominent fold in the limestone, which bends down very sharply east and, rising again, forms a narrow trough. This is clearly shown in the Carbonate incline, Section I, Atlas Sheet XXX. The region to the southeast of this fold has thus far proved barren of rich ore, although explorations have hardly been carried out to a sufficient depth to warrant the conclusion that another bonanza may not exist in that direction. In the Yankee Doodle and Little Giant claims the ore body is narrow, but widens out as it approaches the surface in the Carbonate ground, with intermediate barren streaks which approximately correspond to minor folds more or less parallel with the main folds above mentioned. Practical evidence of the actual replacement of limestone by vein material is extremely common and well defined in the mines of Carbonate Hill. These, as will be shown in the detailed descriptions of mines which follow, are found in the sudden deepening of the ore bodies on the limestone side of the contact plane, which by the miners are often con-

founded with actual waves in the limestone itself. Careful examination in such cases discloses the fact that the contact line is either not curved at all or only to a comparatively limited extent, while the ore impregnation extends downward abruptly to a very considerable depth, sometimes sixty or seventy feet, into the body of the limestone, from which it is separated by a transition zone, barren in general of pay mineral and consisting of limestone more or less impregnated with oxides of iron and manganese.

The first ore discoveries on Carbonate Hill were made on the ground of the present Carbonate claim in the vicinity of the Old incline. The claim forms part of the property belonging to the Leadville Consolidated Mining Company, which owns as well the adjoining claims of the Shamrock and West Shamrock, and also, by a recent consolidation, the Little Giant. For purposes of description the adjoining claim of the Yankee Doodle will be considered as forming part of this group, as the workings of this mine are connected with the others and the ore bodies in all these different claims are practically continuous. They are situated on the western slope of Carbonate Hill, midway between its steeper southwestern and more gentle northwestern inclinations. In the southern portion of the Carbonate claim, as will be seen by reference to the map, by the divergence of the line of fault from the line of contact of the upper surface of the limestone and porphyry, a zone of limestone, widening to the southward, is exposed beneath the slide. The actual position of the main fault line has not been traced beyond the No. 5 shaft of the Ætna mine. Its exact position to the south of this point is therefore somewhat hypothetical, the general direction being given by the developments of prospect shafts on the south slope of the hill, beyond the limits of the map. The actual outcrop of the ore body along the southern line of the Carbonate claim is also somewhat difficult to define, there being here one of the slight flexures in the limestone, of which mention has already been made, whose axis is at an angle with the fault line, crossing it somewhere in the neighborhood of the new (Meyer) shaft of the Ætna and from that point diverging to the southward. In the workings of the Ætna mine, which were parallel with and contiguous to the side line of the Carbonate, the ore body is said to have been practically horizontal on an east-and-west line for a short distance, and even to have

had a slight inclination to the westward as it approached the fault. These workings, being now abandoned and partially filled up, could not be explored. Similar conditions are said to have been observed in the development of shaft No. 12, near the Carbonate line, while in the Carbonate ground itself, at the Combination incline, the outcrop of easterly-dipping beds comes practically to the surface at the mouth of the incline, and a drift, now closed up, running westward from the mouth of the incline, is said to have followed the ore body down on a westerly dip. The conditions of this outcrop have been thus fully described because it has been the cause of a long and expensive lawsuit between the Ætna and Carbonate mines. The owners of the Ætna claimed that they had the outcrop of the vein, or, in legal terms, "the apex," within their side lines. The owners of the Carbonate, on the other hand, maintained that theirs was the legal outcrop, inasmuch as the ore was found at a higher level within their side lines, and that they therefore possessed "the apex" of the vein, which is legally defined as that portion which is nearest the surface. The rulings of the judge were first favorable to the construction of the Carbonate, but were afterwards reversed when it was proved by actual measurement that ore was found within the Ætna claim one inch higher than at a corresponding point within the Carbonate.

**Carbonate workings.**—The southernmost workings on the Carbonate property consist, first, of the West Shamrock incline, which lies outside the limits of the map, commencing at a point near the southeast corner of the Carbonate claim, 240 feet south of the side line of the map, and running parallel with that side line 160 feet, inclining into the hill at an angle of  $18^{\circ}$ . This incline has developed no considerable amount of ore and is interesting only as showing the character of the formations along the contact line at this point. The mouth of the incline is opened in a pulverulent, blue limestone, with a floor of chert covered by a thin seam of iron-stained clay. The actual contact of the limestone with porphyry is probably above the line of the incline, which follows down on the chert floor for some distance, when it passes into solid blue limestone, more or less decomposed, or in which no bedding planes can be distinguished. Small seams, from one foot to two feet in thickness, of decomposed por-

phyry or clay material are found traversing the limestone, and half-inch seams of iron-stained clay on the cleavage planes. A shaft has been sunk on the hill above, which would connect it with the end of the incline, had both been continued a short distance farther. As an exploration for ore, therefore, the work done here is imperfect, inasmuch as, although no pay ore has been discovered, it does not definitely prove that it does not exist in the neighborhood. The occurrence of these bodies of black chert, which are rarely found on the northern portion of the hill, are not uncommon along the southern slopes. While by the miners in many parts of the district they are considered good indications of ore, this empirical test is by no means infallible, although an evidence of passage of silicious waters. One hundred and fifty feet below and west of the mouth of West Shamrock incline a perpendicular shaft (T-35) has been sunk to a very considerable depth on the Irish Giant claim, through Gray Porphyry into Blue and then into White Limestone, without developing any important ore bodies, though an impregnation of the limestone along the lower surface of the porphyry might not unreasonably be expected.

The next opening to the north is the Combination incline, just north of the mine offices. This incline has an average angle of  $21^{\circ}$ , flattening out a little in the upper ten feet. The limestone comes practically to the surface at the mouth of the incline, being covered with about nine feet of broken material or slide. The workings of the incline were abandoned at the time of visit, and apparently no considerable amount of ore had been extracted from them. Down to the first level, the section afforded by the incline itself, which cuts the contact between the limestone and the porphyry, shows a wavy outline of the latter. In the first drift north, the porphyry is considerably iron-stained and decomposed above the limestone, immediately adjoining which is the usual parting of Chinese talc. At 24 feet from the incline are old stopes, now filled up, in which the formation dips downward to the north. The first drift south cuts through the crest of short waves in the limestone and a body of iron from six to eight feet in thickness, while in the face the porphyry goes down with a steep dip to the east and south. Of the south drift, on the second level, the first 20 feet are in limestone, more or less replaced by iron oxide, which is succeeded by porphyry.

The north drift, on the second level, follows in its curves approximately the line of contact between limestone and porphyry, bending back to the westward nearly under the end of the drift on the first level, showing that a limestone ridge crosses the incline in a diagonal or southeast direction between the first and second levels. Below the second level the incline follows along the edge of the northern side of this limestone ridge for 25 feet, the north face of the incline being partially in limestone and clayey contact material, dipping sharply to the north, and the south face in solid limestone. Beyond, the limestone dips down to the east, and the rest of the incline is in porphyry, which is more or less iron-stained. At the end of the incline is a winze sunk 40 feet to the surface of the limestone, showing a rapid descent of the limestone to the northeast of the ridge, which has just been passed through, which is further evidenced by the appearance of bedding planes in the porphyry itself, which incline at an angle of  $45^{\circ}$  to the northeast. The drift running westward from the mouth of the Combination incline, which is said to have followed the contact on its slope to the westward, was not accessible at time of visit.

The Carbonate Old incline runs in 170 feet at an angle of  $19^{\circ}$  and presumably follows the contact, but it is now closed. Solid limestone is found eight feet from its mouth, covered by iron-stained vein material and broken porphyry. Between this and the mouth of the Main incline, under where the boarding-house now stands, was the ore body from which ore was first taken on this ground. The drifts are now filled up and abandoned, but it is evident that the body was of considerable size and very near the surface, lying in an approximately horizontal position, that is, near the crest of the fold already mentioned.

**Carbonate incline.**—The principal workings of the Carbonate mine are opened by the Main or Carbonate incline, which descends into the hill for a distance of 620 feet at an angle of  $21^{\circ} 30'$  and in a direction E.  $25^{\circ}$  S. It is one of the comparatively few inclines in the district which have been driven straight, instead of following the irregularities of the limestone surface, the only true system for an incline from which it is expected to extract any considerable quantity of ore, and one which is probably more economical in the long run, since, in spite of the irregularity of the limestone surface in limited distances, the average dip is tolerably constant.

The section afforded by this incline is extremely interesting, as showing the irregularities of the limestone surface caused by undulations or slight flexures in the formation, and these are best seen in the graphic illustration afforded on Atlas Sheet XXX, Section I, which has been very carefully constructed from actual measurement. It will be seen by reference to this section that the original surface of the limestone presents a general wavy outline with one prominent fold, which, contrary to the general rule prevalent in the major flexures in the region, has its steeper side to the east. The deciphering and reconstruction of the original folds in the formation is a matter of some little delicacy, since the ore currents have eaten irregularly into the mass of the limestone, and the porphyry itself is also somewhat altered and mineralized. It is evident, however, that the dividing line between ore and limestone is one which must be entirely rejected for this purpose. The parting between ore and porphyry, on the other hand, in spite of occasional incursions of ore material into the mass of the porphyry, is practically much more definite, and is that which has been used in determining the points in the original surface of contact. One prominent fact to be observed in this section, and one which seems capable of a certain amount of generalization, is that the main rich ore body is found adjoining the crest of the prominent wave or fold in the limestone. It would seem that along the line of this sharp fold, which may very possibly have been accompanied by a slight displacement, there was an interruption in the ore currents, as is further evidenced by the fact that beyond the fold on the east side for a very considerable distance, indeed, to the extent of the present developments, there has been no considerable deposition of pay ore, the mineralized zone consisting of a most irregular replacement of the limestone by what is known to the miners as black iron, a mixture of oxide of manganese with clayey material, which passes by almost imperceptible transition into coarsely-crystalline black limestone. In this lower part of the incline is one of the most striking evidences of the fact that the ore deposit is an actual replacement of a limestone in place, the walls of the incline showing the clayey, ferro-manganiferous material penetrating irregularly into the limestone, now in thin, sheet-like bodies, following a cleavage or fracture plane and terminating in a point, and now replacing the

whole mass for a distance of many feet. The line between the unaltered and replaced limestone has been accurately followed foot by foot, and a portion of the north wall of the incline is represented on a larger scale in Plate XXII, Fig. 3.

As well as can be seen through the timbers of the incline, its upper portion is practically in the porphyry and the limestone does not actually outcrop. Very probably this is the crest of a slight roll, and it is practically level at this point or may possibly have a very slight western inclination. The first limestone actually seen in place is about sixty feet from the surface, just above a drift which crosses under the floor of the incline. It is evident, however, that the limestone rises somewhat to the south, since it is said to have been found at six feet from the surface under the boarding-house. From this point downwards to the second level the incline is run practically in contact material or in decomposed iron-stained porphyry.

In the second level south, about fifty feet from the incline, a limestone floor is found rising rapidly to the eastward.

In the third level ore was found below the level of the incline, evidently in a depression of the contact line, but the workings are now closed.

The fourth level south, which is still open, runs at first in porphyry, a cross-cut to the left or eastward cutting the underlying limestone at a distance of 16 feet. This marks the point where the limestone rises towards the crest of the fold, shown on the incline section. While in this section the crest is comparatively narrow, it apparently widens out to the south in a broad, dome-shaped elevation. At about forty feet from the incline the fourth level cuts through a body of hard, compact iron, resting upon the limestone, and then bending to the eastward passes into the solid limestone. At a distance of one hundred and twenty-five or one hundred and thirty feet from the incline a streak of clayey matter was cut, carrying a little ore and running off to the southward, evidently a replacement body which followed a cleavage or fracture plane in the limestone. The drift then passes again into solid limestone, bending off to the south at its extremity, where it passes into porphyry, the limestone dipping sharply to the eastward at the bend. As will be seen by reference to the map, the drift at this point is nearly over the extremity of the south drift on the eighth level.



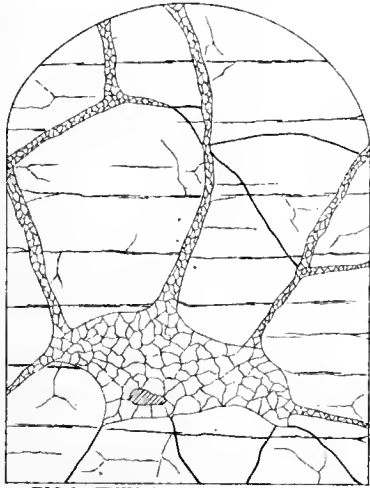

FIG. I. EVENING STAR INCLINE

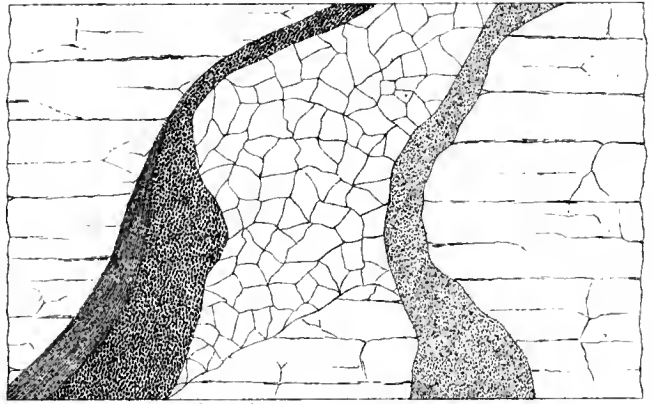

FIG. II. GLASS-PENDERY MINE

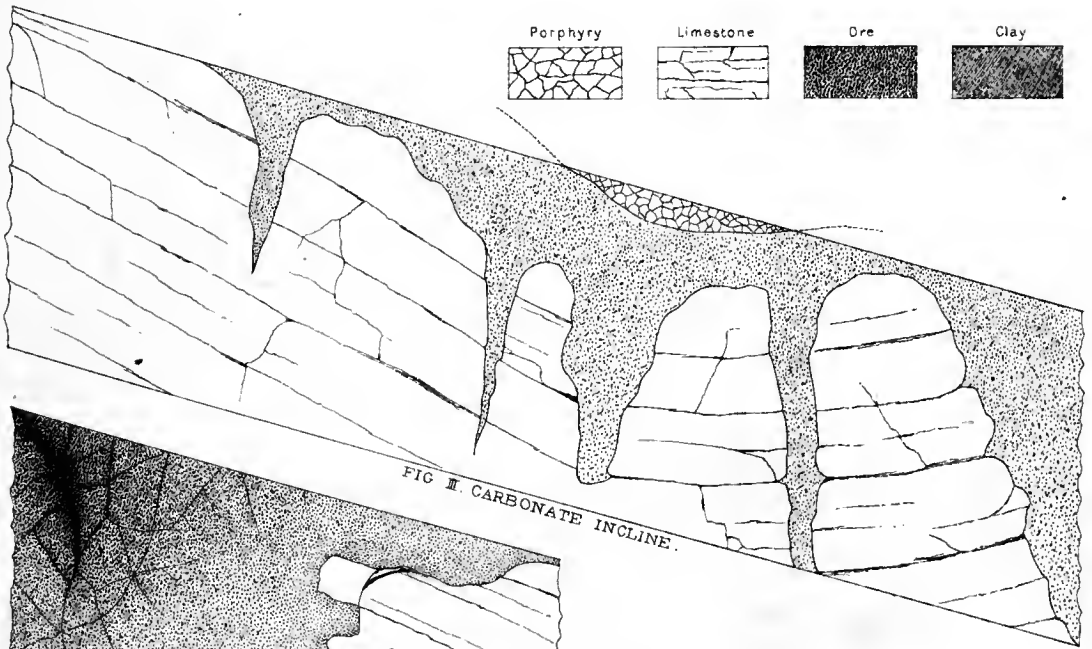

FIG. III. CARBONATE INCLINE.

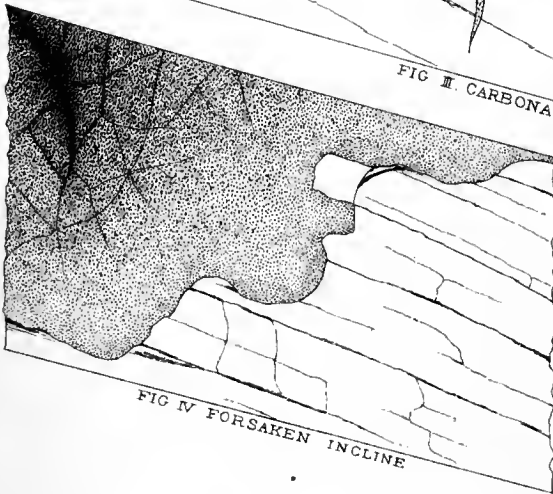
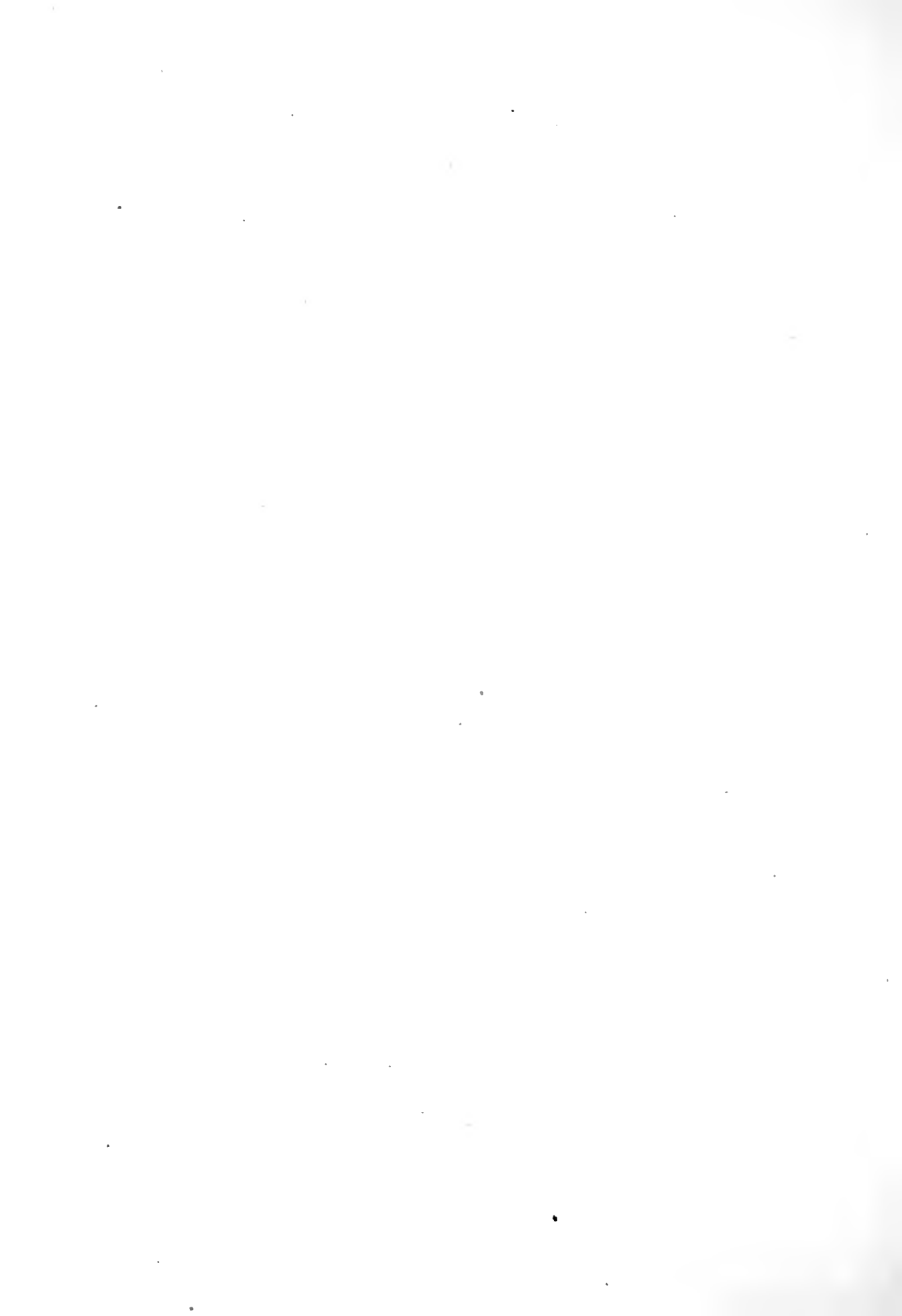

FIG. IV. FORSAKEN INCLINE





The fifth level south has only been driven about fifteen feet, being in the limestone, which extends at least that distance above its floor.

The sixth level south follows in its windings the contact of porphyry and limestone, which here dips steeply to the east and thus defines the eastern edge of the fold. The contact material consists of a thin streak of manganeseiferous clay and Chinese talc. At 30 feet from the end of this drift is an upraise on the right, 30 feet in height, following the almost perpendicular surface of the limestone, from the top of which a prospecting drift has been run out and is said to have been nearly connected with the drift on the fourth level; the drift beyond this point is in the body of the limestone.

On the seventh level no drift has been run to the southward, the incline being here entirely in porphyry.

The south drift on the eighth level has a general southwest course and is cut in a decomposed material which seems to result from the decomposition of the overlying porphyry and of the thin bed of quartzite which is frequently found between the porphyry and the limestone. It is a reddish clayey mass, having a gritty feel and containing fragments both of black chert and of quartzite. Within about twenty feet of the point where the drift forks the clay rises suddenly to the roof and the drift passes into a light-blue decomposed limestone of the pulverulent type, so common in the district, which crumbles between the fingers. The further continuations of these drifts are entirely in a body of fine-grained limestone of earthy texture, as distinguished from the crystalline, granular dolomite which is most frequently found. In the left-hand drift is a stope one set high and in the right-hand drift there is a large chamber from ten to fifteen feet in height and breadth and some twenty or thirty feet long, from which limestone has been quarried to be sold to the smelters as flux.

The south drift on the ninth level follows in its curves the contact between limestone and porphyry, having some black chert in the floor.

Of the workings on the north of the Carbonate incline those on the first and second levels are now mostly inaccessible. As well as can be ascertained, a thin sheet of ore extended from the incline, somewhat intermittently interrupted, as a rule, by limestone rising to the contact with the porphyry, whether caused by simple undulations in the limestone itself or

by narrowings of the ore body cannot be determined. Pay ore was mostly in the form of sand carbonates, slightly impregnated with iron oxides, and in comparatively thin sheets, having a maximum thickness of about two or three feet. Connection was made from the second level to the end of the Ætna incline, to prevent the owners of the latter mine from following their ore shoot farther into the Carbonate ground, but is now closed up. Between the second level and the third and fourth is a large piece of comparatively barren ground, as indicated by the outlines of the ore body given on the map. These outlines, it must be borne in mind, are, from the necessity of the case, considerably generalized, it being impracticable to obtain accurate data with regard to their definite limits in the present abandoned condition of the workings.

One of the richest ore bodies in the mine was found immediately adjoining the incline on the north, between the third and fifth levels, occupying a slight depression immediately adjoining the crest of the main fold in the limestone. This ore body was in places two sets high (some fifteen feet thick), gradually thinning as it approached the crest of the fold, and to the northeastward spreading out in a thin and comparatively continuous sheet of sand carbonates. In the drift on the fourth level north, a body of unaltered limestone rises up in the floor, cutting off the ore about twenty feet from the incline; beyond this point ore is only found in detached bodies to the west of the drift, while to the east it extends in practically continuous sheets to the lower levels, gradually taking a steep easterly dip. The northern extension of the drift, after passing through a considerable stretch of barren contact, cuts several small, unimportant ore bodies, which form a continuation of those developed in the lower levels, and at its extremity was being run at the time of visit in solid limestone.

The fifth level is cut for a short distance from the incline in the limestone of the fold, then passes through the clay contact, showing considerable slickensides. The contact here is somewhat typical, showing first a blackening of the limestone by a certain amount of impregnation by manganese and iron oxides; above this, iron-stained clayey matter, containing the usual development of Chinese talc; and still above, a thin irregular body of quartzite (Weber Shales), followed by normal White Porphyry. The

slickensides indicate a certain amount of movement or displacement along the steep eastern face of the ridge or fold. At about one hundred feet from the incline the drift bends under that of the next level above, and from here on follows in its sinuosities the line of contact, which has a steep dip to the eastward. From the point where the ore is struck in this drift almost to its northern extremity, the ore extends eastward to the two next lower levels and into the ground of the Little Giant claim, in a practically continuous body of iron-stained sand carbonates, generally one foot to two feet in thickness, only interrupted here and there by ridges of undecomposed limestone, reaching up to the porphyry contact. This ore sheet has a steep dip to the eastward, say on an average from  $25^{\circ}$  to  $30^{\circ}$ , and evidently stands on the eastern slope of the fold; it would seem, therefore, that the dome-shaped uplift in the limestone body between the fourth and sixth levels south of the incline has narrowed into a sharp ridge in the incline itself, and that it has then become a monoclinical fold to the north, the ore body extending over the line of its crest and partly down its eastern slope into the trough.

The sixth level north is run for fifty feet on a barren contact, following the curve of the limestone ridge, then passes into an ore body extending right and left with a steep dip to the eastward, while the end of the drift bends sharply to the eastward and runs into the overlying body, in which the eastward dip is shown in the rude bedding planes.

The seventh level north for the first hundred feet is run in White Porphyry, more or less iron-stained or decomposed and probably some distance above the contact; limestone then comes up into the floor, covered by a streak of black iron and white Chinese talc a foot in thickness. Immediately beyond, a body of ore three sets high has been stoped out, which evidently represents the ridge of limestone, now entirely replaced by ore. This ore ridge at its maximum height is only about twenty feet in width, having a roof of breccia material consisting of fragments of black chert and quartzite in a matrix of clay and decomposed porphyry. The limit of the pay-ore body is found at a comparatively short distance east of this drift, the developments on the eighth level showing only a barren contact.

The north drift on the eighth level follows in its right fork the eastern boundary of the trough east of the ridge, and is cut in a yellow ocherous

material, which occasionally passes into limestone, the roof being White Porphyry. The left-hand or west fork in the first half of its course is cut in White Porphyry and then passes into a decomposed, light-colored, and iron-stained limestone, which rises to the west. The drift, after a rise of 15 feet over a ridge of dark hard limestone, passes into soft clayey material, and then bending to the northward passes through two or three feet of quartzite into a body of Gray or Mottled Porphyry, in which it stops. This is the only point in which the Gray Porphyry has been discovered in this mine. No definite idea, therefore, can be formed as to the shape or origin of the body. It may be interesting to note in this connection, however, that farther in the hill, as shown by the developments of the Modoc shaft, there are several bodies of this Mottled Porphyry intercalated between the different beds of limestone. From this level, immediately adjoining the Main incline, an incline drift, following the contact, has been run westward to a point immediately under the fifth level. It is now mostly filled up, and is mainly interesting as proving the existence of the deep trough shown in the section.

From the eighth to the ninth level, a distance of over one hundred and twenty feet, no pay ore is found; but, as has already been mentioned, most interesting proof is afforded of the fact that the ore bodies are simply replacements of the limestone. The replaced material is largely a black, clayey matter, more or less iron-stained and in some cases passing into a red plastic clay, which would seem to have infiltrated into the mass from the porphyry above, while the limestone immediately adjoining this is itself more or less discolored by black oxide of manganese. A short distance below the intersection of the ninth level, which is in solid blue limestone, the limestone, with its contact seam of Chinese talc, dips steeply down to the eastward and the incline passes into porphyry. Just at the point where the limestone bends downward, a small ore body was discovered immediately over the roof of the incline.

**Little Giant.**—The workings of the Little Giant mine are practically an extension of those of the Carbonate along the continuation of the main ore sheet, where it has its steep dip to the eastward between the fourth and seventh levels. It is opened by a shaft 234 feet deep and is also connected

by narrow sinuous drifts with the fifth level of the Carbonate. The ore is iron-stained sand carbonates, occurring, as a rule, in thicker bodies than in the Carbonate claim and being rather more irregular in shape. The workings consist of a main incline, now being driven a little south of east from the bottom of the shaft, and of an incline running nearly due east at an angle of  $26^{\circ}$ , from which levels have been run off at intervals of about fifty feet. The richest ore bodies have been found immediately adjoining the Carbonate claim on one side and that of the Yankee Doodle on the other. The larger portion of the ground included in the Little Giant claim, which lies to the southwest of the Shamrock, has not been prospected at all, because it has been considered beyond the southeastern limit of the pay-ore streak, as indicated on the map. The ground is probably barren.

**Yankee Doodle.**—The Yankee Doodle mine, east of the Carbonate fault, is opened by two independent shafts, not yet connected underground, and the present developments are confined to the workings from the upper shaft. The ore found here is a northeastern continuation of the Carbonate body. The upper shaft of the Yankee Doodle is 303 feet deep, the first station being at a depth of 296 feet from the surface. Limestone is said to have been struck in this shaft at 230 feet. The main drift, running eastward from the station, is cut in solid black crystalline limestone, showing some replacement action; but no pay ore is found until the first cross-drift is reached, at a distance of 170 feet from the shaft.<sup>1</sup> Twenty-five feet beyond this first drift is a winze 30 feet deep, which goes down at an angle of  $70^{\circ}$  to the eastward, following a sudden bend in the limestone, which is evidently the same that has been traced through the Carbonate and Little Giant claims, though having a steeper angle. Some ore has been found beyond the bend on either side of the main drift, but none as yet below the winze. The principal ore developments have occurred along the boundary line between this claim and the Little Giant, where an incline is being sunk at an angle of  $30^{\circ}$ . Considerable ore was found extending upwards along the surface of the limestone near the boundary line. These developments show a somewhat discontinuous body of pay ore, consisting of sand carbonates

---

<sup>1</sup>By an oversight in the correction of proof the section (Section G G, Atlas Sheet XXX) shows White Porphyry, instead of vein material, below this drift from this point to the winze.

with a small proportion of unaltered galena. The ore sheet which extends from the Carbonate into this ground seems to be growing narrower and less continuous and may disappear entirely to the northeast. It is as yet, however, not safe to assume this as a fact, for the ground in the Yankee Doodle claim has not yet been thoroughly and systematically prospected; moreover, the shaft sunk on the Excelsior claim, which is nearly in the line of the probable continuation of this ore body, is said to have cut a large body of vein material, which, though not rich, is an evidence of mineralizing action.

From the middle shaft of the Yankee Doodle, which is about one hundred feet in depth, considerable ground has been explored by an incline, from which two sets of levels have been run off. Both incline and levels are very irregular, following the varying inclination of the contact between limestone and porphyry.

From the end of the first level north a winze was sunk, apparently in a considerable body of vein material, in a sudden steepening of the limestone. As it will be seen by reference to the map and sections that this point is on a line with a similar sharp bend in the limestone, at the southern extremity of the drift on the sixth level of the Crescent mine, where indications of a body of rich ore are found, it would seem advisable to have pushed explorations farther at this point, with the prospect of developing one of the smaller bodies of ore, such as are found to the west of the main Carbonate body, between it and the Ætna line. The south drift on this level follows a barren contact of the usual character, viz, showing blackened decomposed limestone, with the usual parting of Chinese tale separating it from the iron-stained porphyry above, which contains fragments of black chert and quartzite.

On the second level some thin seams of sand carbonate are found to the north of the incline, and at the southern extremity a considerable body of this ore has been stoped out. This also is evidently worthy of further exploration. It thus appears that the apparently barren zone between the two rich ore bodies or bonanzas of Carbonate Hill is only a region where the ore is less continuous than in the bonanzas themselves, and that several small ore bodies have been found there, and probably by a systematic



exploration of the ground many others might be found, especially if the search were not confined to the contact surface alone, but were also extended where indications of mineralized jointing planes seem to warrant it, into the body of the limestone below.

**Area on top of hill.**—In the area to the east of the claims of the southern group, on the top of Carbonate Hill, several prospecting shafts have been sunk in the White Porphyry, notably the Excelsior, William Wallace (300 feet), Tip Top (297 feet), Little Nell (440 feet), Thespian (400 feet), and the Modoc (600 feet). Of these, only the Excelsior and Modoc have reached the Blue Limestone. Neither was accessible at time of visit. The Excelsior is said to have found a heavy body of iron-stained vein material, but not sufficient pay ore to encourage further developments. The Modoc shaft had filled with water while awaiting better pumping machinery, but from data obtained from miners and from evidence afforded by the dump it appears that contact with a certain amount of vein material was struck at about five hundred feet. In the little drifting that was done no rich ore was found. The shaft was sunk 100 feet farther, passing through the Blue Limestone and two intrusive sheets of Gray Porphyry included within it, as ideally shown in Section I, Atlas Sheet XXX. It would thus appear that the sheet of Gray Porphyry, which on Iron Hill occurs near the base of the Blue Limestone, is here either cutting across this formation to a higher horizon or sending off offshoots, such as are found in some of the Iron Hill workings.

**Area west of Carbonate fault.**—In the Ætna and Glass-Pendery claims, which, with the exception of a small corner of the former, lie west of the Carbonate fault, little pay ore has been found on the contact; but the main ore bodies occur within the mass of the limestone, extending to a depth of fifty feet or sixty feet below its surface.

Ore was first discovered in a nearly vertical body, crossing the lower part of Glass No. 2 shaft in a southeast direction. The development of this body led to the discovery of other larger and more irregularly-shaped bodies extending beyond the Ætna line. These were worked by the Glass-Pendery owners, and much ore was taken from the Ætna ground before the owners of the latter were aware of its existence. It was on account of

the litigation arising from the claim of damages by the Ætna mine that admission to the Glass-Pendery mine was for a long time utterly refused, only a single hasty visit being finally conceded for the purposes of this work. This refusal was particularly unfortunate, as the information to be obtained here has a most direct bearing on the question of the existence of ore further west under the city of Leadville. The existence of the Pendery fault, on which an incline is sunk 100 feet below the main level, was, however, ascertained beyond a doubt, with the strong probability of a slight western dip in the limestone adjoining the Pendery fault. (See Sections H and I, Atlas Sheet XXX.) Had the incline on the Pendery fault been continued, there seems to be little doubt that the limestone would have been struck in it at no very great depth, and definite data could thus have been obtained in regard to the ore horizon under Leadville.

The ore body which passes through the Glass shaft seems to have been a fracture or fissure in the limestone, partly filled with White Porphyry from the main sheet above. A section of it where it crosses a drift northwest of the shaft is given in Fig. 2, Plate XXII, in which it is seen that replacement action has followed the walls of the fissure on either side of the porphyry, the rich ore being confined, however, to the hanging wall.

In the Ætna ground a small body of Gray Porphyry is found in the drift just west of the main shaft. To the southeast of this shaft the limestone is singularly bleached and disintegrated, but no ore is found. The main large ore chambers occur north of this shaft, not far from the Pendery line. They extend up in places nearly, if not quite, to the contact plane, and are wedge-shaped or tapering toward the bottom. The ore in these claims is said to have contained little or no lead.

The Meyer shaft was sunk 50 feet perpendicularly to the fault, then followed the fault plane to the contact, from which point a drift was driven to meet these large chambers. The fault plane, like that of the Iron fault, was found to contain a certain amount of pay ore, mixed with attrition or selvage material, but none was found outside its walls in the limestone. The fissure is quite regular in its inclination, which shallows somewhat in depth, and is from one foot to three feet in width. The evidence here, as

in the Iron fault, shows that the original ore deposition was prior to the faulting, and that whatever ore is found on its plane was brought there mechanically or is the result of secondary deposition.

North of the Pendery and Ætna workings it was difficult to obtain accurate information in regard to the underground structure of the lower slopes of the hill, west of Carbonate fault. Many prospecting shafts have been sunk, a few of which penetrated the porphyry to the underlying limestone, but they had mostly been abandoned. The St. Mary's was the only one which was accessible. From information obtained in this and by diligent questioning of persons who had visited the others, it appears that the limestone in this region probably falls off to the west in a series of irregular steps or benches, which may be actual faults or sharp flexures. The result is a probable dip to the westward, as indicated in a generalized form in Sections F and G, the only break or fold which could be actually located being that assumed as the northern continuation of the Pendery fault and which was actually seen in the St. Mary's workings. This fault is supposed to pass into an anticlinal fold in the northern half of the area mapped, as will be explained below.

In the lower part of the Yankee Doodle claim are several old prospecting shafts, now abandoned. That marked on the map as the lower shaft is said to have found limestone and ore at about fifteen feet, which was cut off to the westward by a sudden break. The break was followed by an incline seventy-five to one hundred feet farther, and work was then discontinued. This break is evidently the continuation of the Carbonate fault.

#### NORTHERN GROUP OF MINES.

In the northern half of the area shown on the Carbonate Hill map, another ore body parallel with that already described, but of much greater dimensions, has been developed east of the line of Carbonate fault, and a smaller, but very rich body, in somewhat peculiar relations, to the west of this line.

The first of these bodies extends northeastward from its outcrop in the Crescent claim through the Catalpa, Evening Star, Morning Star, and Waterloo claims, and probably beyond these into the ground of the Maid

of Erin and Brookland claims. It obtains its maximum breadth of about two hundred feet and a thickness of pay ore of over fifty feet in the Evening Star ground, vein material having here replaced apparently the entire thickness of the Blue Limestone, which, as a result of this action, has shrunk to about one hundred feet. As in the Carbonate body, there is a noticeable steepening in the dip of the formation beyond the eastern limits of the ore current, but the amount of replacement by oxidized material has been so great that the minor waves in the limestone are difficult to trace.

It were too long to enter into a detailed description of the workings in each mine, as has been done in the case of the Carbonate; and, since the map and sections represent, so far as their scale permits, the results of thorough examination of every drift, only the salient points and general features will be mentioned in what follows.

*Crescent mine.*—The Crescent, like the Carbonate mine, is worked through a long incline, following the dip of the stratification. In this case, however, the angle of the incline varies from point to point in an attempt to keep on the contact; but, owing to the irregularities of the limestone surface, it runs, like the former, now into the limestone foot-wall and again into the porphyry above. Its average angle is at first  $12^{\circ}$  to  $13^{\circ}$ , but 50 feet beyond the No. 3 shaft it becomes  $20^{\circ}$  to  $25^{\circ}$ , continuing on this average slope to a distance of 800 feet from the mouth. For the first 80 feet it runs in Wash, composed of clayey gravel inclosing rounded boulders of Sacramento Porphyry; above the contact are four feet of quartzite, supposed to belong to the Weber Shale horizon. This quartzite is very generally found below the porphyry in this and the adjoining mines to the north. It is ordinarily very thin and difficult to distinguish from the porous quartz which frequently constitutes the gangue or vein material. As in the Carbonate mine, the dip of the limestone is very shallow near the surface, and it is possible that it forms here as there the crest of a fold, but the explorations in this region were unfortunately too few to afford definite data on this point.

The main ore body is developed between the first and fourth levels and extends from the incline in a northeasterly direction to the Catalpa line. South of the incline, it was found only on the first level, extending

beyond the No. 1 or Blacksmith shaft, where the limestone is rising rapidly to the surface. It was generally found as a thin and somewhat irregular sheet of sand carbonate, averaging perhaps a foot in thickness. Toward the Catalpa line on the fourth level it thickened to two and a half feet and carried 100 to 500 ounces of silver to the ton. Between the upper part or southwestern end of the body and the Catalpa line is an area which has proved barren of pay ore, so far as explored, though vein material is practically continuous through it, carrying always a certain amount of silver.

On the line of the incline, as is shown in the section, there is a ridge of limestone between the third and fourth levels and another just beyond the fifth. To the north, towards the Catalpa line, these two ridges have come together, and the steep dip, which in the incline is beyond the fifth level, is here between the fourth and fifth, as the converging of these two drifts shows. East of this line the contact has been found practically barren, though showing considerable replacement material, consisting of oxides of iron and manganese which all assay a few ounces in silver. Between the eighth and ninth levels is a deep trough, produced by a fold and possibly accompanied by some displacement, similar to that in the Carbonate mine. A winze was sunk here, said to have been 80 to 100 feet deep, in vein material, but it was no longer open, and the information is somewhat uncertain. The south drift on the eighth level runs along the edge of this trough on the contact, which dips  $70^{\circ}$  to the eastward. The extremity of the south drift on the sixth level, which follows the curves of the contact, rises 20 feet over the ridge of limestone which crosses the incline below No. 3 shaft, and finds a small body of ore, which deserves further prospecting.

**Catalpa mine.**—Although the first discovery of ore on this ground was made in the gossan, or iron outcrop at the surface, the mine was opened through a shaft sunk high up on the hill, which reached the contact at a depth of 170 feet and near the eastern limits of the main ore body. From this explorations were carried upward to the west, and a second shaft, the New Discovery, has lately been sunk to develop the ore shoot extending up toward the surface, which has not yet been thoroughly explored.

As the surveys in this mine had been carried on without any systematic determination of level in the drifts, as is often the case in Leadville mines,

the outlines of ore bodies and contact may be less exact than in other mines. There seem to be two ridges in the formation, marked by sudden descent of the ore bodies to the east on the line of the section (E), but along the Evening Star line, above the general steepening of dip at the east limits of the bonanza, the inclination is more regular. The vein material in this ground extends to depths of thirty and forty feet below the contact, its total thickness not being in all cases ascertainable, as explorations are seldom extended in depth as far as the unaltered limestone. The rich ore bodies are generally found in its upper part, near the contact. The former is generally soft and clayey, sometimes, however, a hard silicious hematite, and in the vicinity of the ore bodies often a granular quartz, not unlike a quartzite in general appearance. In the Main shaft 40 feet of vein material was passed through before reaching unaltered limestone. This was barren, with the exception of a thin streak of galena, carrying 379 ounces of silver to the ton. The limestone below is of dark color, generally hard and crystalline, but sometimes soft and pulverulent, containing clay infiltrated through from above.

From the bottom of the New Discovery shaft the ore extends in a somewhat irregular body one to three feet in thickness to the northeastward, and along the Evening Star line is practically continuous eastward as far as the so-called "crib." In the direction of the Main shaft its continuity for a short distance is broken, but it comes in again in the northeast continuation of the Crescent body, increasing in thickness toward the "crib" on the Evening Star line, at the extremity of the drift running north from the Main shaft. At the "crib," so called from the structure, filled with waste, used to support the roof of the ore chamber, there is a sudden steepening of the ore body on both sides of the line between Catalpa and Evening Star. An almost solid mass of carbonate ore, 40 feet thick, was taken from this chamber. It was difficult to obtain definite data as to the bounding rocks, but it is evident that this deepening is due, not to a fold in the limestone, but to replacement action extending a little deeper, probably along some fissure or cleavage plane in the limestone. The general outline of the ore body here is shown in the longitudinal Section A, Atlas Sheet XXIX, whose line passes through this portion of the mines.

From the bottom of the Main shaft an incline is started in the limestone for the purpose of exploring the ground to the east; in it the bedding-planes of the limestone are very indistinct, but from data obtained at other points it is deduced that its dip must be nearly  $45^{\circ}$ .

In general it may be said of the ore bodies of the Catalpa mine that, while irregular and pocketey, they have been much richer than the thicker bodies to the north.

*Evening Star mine.*—This claim, located on a narrow strip of ground little more than half the normal width of a claim, left between the Catalpa and Morning Star, included by good luck the thickest and widest portion of the bonanza, and has probably proved more profitable to its owners, as a legitimate mining enterprise, than any other in the region.

It is opened by two vertical shafts, known as the Main and Upper shafts, between which the ore body stretches in an almost continuous sheet and beyond which in either direction but little ore has been found.

*Main shaft.*—The Main shaft, as shown in Section D, was sunk through the White Porphyry, across a great thickness of iron vein material and through an underlying sheet of Gray Porphyry, into a second body of vein material, at the base of which was found a thin bed of quartzite. This is probably a portion of the Parting Quartzite, and the second iron body is therefore the replacement of a portion of the Blue Limestone split off from the main body by the intrusion of the Gray Porphyry. The fact that this underlying sheet has been actually cut here is extremely important, since its existence in the southern portion of the hill, between this point and the outcrops on the slopes toward California gulch, has been only inferentially proved by isolated masses supposed to be offshoots from it.

A dike-like body of Gray Porphyry is also cut in the upper workings adjoining the shaft. As shown here, it is six feet in width, runs in a north-east direction, and has a dip of  $70^{\circ}$  to the northwest. In places, especially toward the center of the mass, it is in exceptionally fresh condition, its matrix being a semi-translucent hornstone-like mass, containing abundant crystals of limpid quartz with feldspar. By decomposition, which is often completed in a very short distance from the unaltered parts, the groundmass becomes perfectly opaque and white, and assumes a mottled appearance

from the prominence given to small crystals of feldspar and the oxidation of the contained iron, so that it is not to be distinguished from the average Mottled Porphyry. This body can be traced but for a short distance in either direction. It is probably an offshoot from the main underlying sheet, and its position suggests a possible connection, or at least common origin, with that found in the Morning Star ground, although the shape of the latter, as shown in Section C, is more that of a sheet than of a dike. It must be borne in mind, however, that none of these later intrusive and cross-cutting sheets has the regularity of the normal dike as it is generally represented in geological text-books, and further that, as in the mines they are seldom exposed in more than a few isolated points, their graphic representation on the section is almost entirely ideal and subject to correction whenever further explorations furnish more facts in regard to them. The White Porphyry in this shaft was found to be highly decomposed throughout and so stained by iron oxides near the contact that the line of the latter could not be accurately determined. In it, about fifteen feet above the contact, was found a small body of ore, consisting of pyromorphite and cerussite, with a little sulphide, filling the interstices of small blocks of country rock. The rock contained over 80 per cent. of silica and may have been an included fragment of impure quartzite belonging to the Weber Shales. This was probably a secondary deposit.

The occurrence of a second body of vein material below the Gray Porphyry is extremely interesting, as showing that replacement of the limestone has taken place, at times, below this porphyry, as it has normally below the White Porphyry. In this case the body is exceptionally rich in manganese, being mainly the black iron of the miners. The jointing planes are covered with a coating of fine crystals of pyrolusite.

*Upper shaft.*—This shaft was sunk 290 feet through White Porphyry before reaching the contact. Here the porphyry was hard and exceptionally fresh, being what is locally known as “block porphyry”; moreover, it contained minute crystals of pyrite, disseminated through its mass. The occurrence of undecomposed pyrites in the porphyry is noteworthy in connection with the fact that for a considerable distance to the east of the shaft there is a close contact—that is, little or no replacement on the surface of the



limestone. On the limestone surface only about eight to ten feet of vein material were found, which rapidly thinned out to the south and east.<sup>1</sup> Between these two shafts the rich ore body extends in a practically continuous sheet, reaching its greatest thickness of about forty feet toward the middle of the area. Its outlines are difficult to define, since the distinction between low-grade ore and high-grade vein material may vary at different times and since it could not be actually studied in every part; but where drifts were closed information had to be obtained from the miners. Its lower surface is very irregular, extending down into the vein material to depths which vary rapidly in a few feet; the upper limit, however, is more regular, being practically that of the contact, though every portion of this was not necessarily rich enough to be extracted. Toward the Morning Star mine it becomes thinner, but its lateral boundaries widen. East of the Main shaft, on the line of Section D, the contact is barren, but on the Morning Star line the ore extends to the line of steepening dip, as it does in the workings from the Morning Star Upper shaft. It is by no means certain that in this region the eastern limits of the ore body have been reached, and the outlines given on the map must be considered merely tentative. The diagram in Fig. 1, Plate XXII, is taken from the extremity of the incline running east from the Evening Star Upper shaft and shows a fragment of porphyry intruded into the body of the limestone, in this case unaltered; such an occurrence in a region of active replacement would account for the Chinese talc and clay which might be found entirely within an ore body.

*No. 5 shaft.*—Since the completion of field-work an exploring shaft has been sunk at the outcrop, which, after passing through a considerable thickness of vein material, is said to have found unaltered Blue Limestone. From this information the structure assumed in the section has been inferred, though, as will be shown in the discussion of the region west of the

---

<sup>1</sup> Since the completion of field-work this shaft has been sunk 100 feet deeper, cutting alternately through solid limestone and replacement zones parallel with the bedding and containing iron vein material. The first of these zones was 7 feet thick, occurring at 15 feet below the contact; the second was 45 feet thick, containing in the middle from 5 per cent. to 20 per cent. of lead and occasional nodules of galena. The limestone on either side of this zone was decomposed and pulverulent, in the condition known to the miners as "lime-sand," but the bedding planes were often still distinct. From these developments it appears that the replacement zone on Section D should have been continued farther east. The shaft was not carried down to the Gray Porphyry, to determine whether pay ore exists at its contact, as in the Waterloo.

fault, there is no certainty that there may not be a decided shallowing in the dip of the formation as it approaches the assumed fault line.<sup>1</sup> No explorations have been made between this and the Main shaft except the Old Discovery shaft, which was sunk for a few feet in vein material and has long since been filled up and obliterated.

The ore of the Evening Star mine consists largely of sand carbonate and hard carbonate, but contains also a considerable amount of unaltered galena. Although less rich than that of the Catalpa, its working results give a high average, which may be estimated at 60 to 70 ounces of silver a ton. As compared with the Morning Star ore it runs lower in lead, but as a rule contains less silica and more iron and manganese, and is, therefore, more easily smelted. The hard carbonate, which is the characteristic ore of the western half of the mine, is a granular silicious material of peculiar steely or adamantine luster, either compact or porous and full of cavities. An examination of the cavities with a lens shows that they are more or less completely filled with transparent crystals of cerussite and little flakes of chloro-bromide of silver of pale-green color. The sand carbonates occur in streaks and lenticular bodies, generally not more than one or two feet in thickness. Chinese talc is occasionally found, but cannot be traced so regularly as when the ore bodies are thinner and the actual contact consequently more readily defined.

Morning Star mine.—To this mine belong both the Morning Star and Waterloo claims, the ground of the latter above the fault being as yet but little explored. In this mine, as in the Catalpa, no systematic levels were run, and, as many of the old workings were inaccessible at the time of visit, the data obtained as to details of form and occurrence of ore are less accurate than in the case of the Evening Star mine. The ore body continues its

---

<sup>1</sup>According to Mr. Ricketts (*The Ores of Leadville*, Princeton, 1883) the data furnished by the sinking of this shaft through the Gray Porphyry and by a bore-hole drilled from its bottom as far as the Lower Quartzite show that the thickness given for the Gray Porphyry sheet in our ideal Section D is too great, its actual thickness being about fifty feet. He also states that he found no Parting Quartzite. As his information with regard to rocks passed through was obtained by examination of the dump, it might readily have escaped his observation. On the other hand, on the supposition that there was a nonconformity by erosion between Silurian and Carboniferous formations, it might have been eroded away at this point and be actually wanting; this would also account for a supposed less than normal thickness of the White Limestone.

normal northeast direction through this ground as far as explored, and apparently widens out to the northwest, the limits given to it in this direction on the map being merely those of explored areas, and not necessarily of the limits of ore deposition, as a great deal of ground is still unexamined. This body, which in the Evening Star ground had already commenced to shallow toward the boundary line, becomes very sensibly thinner throughout the Morning Star ground. From four to eight feet may be taken as the average thickness, though in places it deepens for a short distance to 20 or 30 feet. As a rule the ore runs much higher in lead than in the Evening Star, but is poorer in silver. It also contains more silica and less iron and manganese. Very white carbonate sands, consisting of almost pure cerussite, are found, especially along the contact. Here, as elsewhere, these seem to contain less silver than the more stained and impure carbonate ores. It may be that the latter have more silver in the form of sulphuret. As gangue the porous granular quartz is very prevalent, and often constitutes a good hard carbonate ore. Below the ore the ochreous yellow basic sulphate was frequently observed.<sup>1</sup>

The mine is principally worked through the Main shaft, from the bottom of which an incline follows the dip of the formation eastward, and levels are run southward to the Evening Star line and westward to connect with the old workings from the Lower shaft. From the incline levels are run at somewhat irregular distances, following the ore development, which has been mainly to the south in the upper part and in the lower to the north. A second shaft, known as the Upper shaft, has also been sunk to contact higher up on the hill, on the Waterloo ground, from which a level connects with the incline.

In this area the greatest east-and-west extent of the ore bodies has been along the Evening Star line, and its greatest thickness along the middle of the body, between the second and third levels. As far as could be ascertained, in one point only has unreplaced limestone been reached below the ore. This was at the southern extremity of the fourth level south, and it

---

<sup>1</sup> According to Mr. L. D. Ricketts, who made a careful and detailed study of the Morning Star and Evening Star mines during the summer of 1882, this basic sulphate forms a distinct and practically continuous sheet under the ore body in the Morning Star ground.

was considered by the miners a limestone boulder. Explorations generally stop in the iron body or barren vein material underlying the ore body. The steepening of dip to the east of the ore body is very marked at the present extremity of the incline, as well as near the bottom of the Upper shaft; its angle is here  $25^{\circ}$ . A fine body of carbonate ore is just being opened to the west of this point.

The old workings of the mine were reached from the Lower or Boarding-House shaft, and at time of examination were inaccessible. From information obtained it appears that a large mass of vein material was found here, and a layer of valuable ore at the contact, which reached the Evening Star line on the south, but was cut off at 125 feet east of the shaft by a break in the formation. This break was found, at the extremity of the west drift from the Main shaft, to consist of an actual displacement of 20 feet in the formation, bringing the basset edges of the limestone against a sheet of Gray Porphyry, which here overlies the contact. To the west of this there is a sharp rise in the contact, which was explored with some difficulty through drifts rendered dangerous by the plastic condition of the decomposed Gray Porphyry. This body was found in no other workings, and what could be determined of its outlines is shown in Section C. Where it comes up through the limestone, as it undoubtedly must, is not therefore known, but a possible manner of offshoot from the main sheet below is shown in Section A.<sup>1</sup>

The normal continuation of this great ore body would be between the Maid of Erin and Brookland shafts. In the former contact was struck at 385 feet and 15 feet of iron were passed through. To the north of the shaft, in a drift rising between Gray and White Porphyry, was found a small body of galena. The developments are as yet too limited to furnish an accurate idea of the shape of this body of Gray Porphyry, which is therefore merely indicated in the section (B), as shown by present developments, with no suggestion as to its probable continuation. Ore is also said to have been struck in the Brookland shaft. The Big Chief and Clontarf shafts have also reached the contact and found vein material and ore, but as yet

---

<sup>1</sup> Mr. Ricketts (*op. cit.*, p. 41) states that a dike, eight to ten feet wide, crossing the limestone, has since been cut by one of the drifts of the mine, which he regards as the feeder of this sheet of Gray Porphyry.

developments are not carried on regularly in any of these shafts, owing to great influx of water and nothing definite can be said as to the extent or conditions of the ore body in that direction.<sup>1</sup>

Area west of Carbonate fault.—The original rock surface of Carbonate Hill west of the line of Carbonate fault slopes off very rapidly, as shown by the sudden deepening of the Wash in the various sections. The line where the slide of the steeper slopes gives way to actual Wash, or rounded boulders and gravel of rearranged moraine material, marks a sort of beach-line in Glacial time, up to which the ice sheet must have extended in order to transport the boulders, some of which (at the mouth of the Crescent incline, for instance) must have been brought from near the crest of the range. The depth of this mass of detrital material probably reaches 150 to 200 feet along the western edge of the map, and there is some evidence to show that the underlying Lake beds extend up to the base of the steeper rock-surface slope, as shown in the sections. Under such a mass of clayey gravel, which, like a sponge, permits the passage of water through it and yet keeps constantly saturated, the rock surface disintegrates and its mineral constituents are decomposed more readily than elsewhere, and the porphyries especially lose rapidly their distinctive characters. With these conditions of actual surface and rock surface the determination of geological structure is naturally difficult, and this difficulty is enhanced by the fact that, except at the northern and southern ends of the area mapped in the lower Henriett-Waterloo and Ætna-Pendery claims, respectively, the little underground exploring that has been done was simply for prospecting purposes, irregular, without system, and the workings are as a rule no longer accessible. The structure of this region, as represented on the sections, is the embodiment of information obtained at the expense of infinitely more time and labor than the examination of a large mine would have required, and yet is far from satisfactory in its character. For this reason, while the structure of the lower portion of the hill, as shown in Sections B, H, and I, may be taken as

---

<sup>1</sup> Since the completion of field-work, at a depth of 633 feet contact has been reached in the Wolfe Tone shaft, which is a short distance east of the Brookland. Ore and vein material are said to have been about forty feet thick, the former occurring both as carbonate and as sulphuret. Below this a body of porphyry was found, which from description is apparently Gray Porphyry and may be the eastern continuation of the main sheet which has been developed in the Lower Waterloo workings.

essentially accurate, that given in the intermediate sections has a certain element of tentativeness and uncertainty. That in the *Ætna-Pendery* ground, represented by the two latter, has already been described.

*Lower Henriett and Waterloo.*—Section B shows the structure below the Carbonate fault on a line drawn between these two claims, whose lower workings are connected with each other. It is that of an anticlinal fold, whose axis corresponds very closely with the prolongation of the Carbonate fault line and whose crest has been planed off, with a sharp synclinal basin adjoining it on the west, along one side of which the lower sheet of Gray Porphyry cuts across the Blue Limestone up into the overlying White Porphyry, which has escaped erosion in the hollow of the basin. . On the under side of this sheet of Gray Porphyry, at its contact with the limestone, the latter is mineralized, and a most valuable body of carbonate ore has been developed, extending into the hill at a rather steeper angle than the average dip of the formation. The existence of this lower ore sheet was supposed at first to indicate merely a faulted-down portion of the regular ore horizon, as it does in the *Ætna-Pendery* ground, the difference of level between the outcrops of vein material on the surface and that of the lower body, prolonged in dip into the hill, being quite what would be expected if the movement of the fault was normal, with a slight decrease in amount toward the north. It was observed, however, that the *Half Way House* and *Henriett Lower* shafts had passed through normal White Porphyry over limestone, whereas a short distance east of the latter shaft the White Porphyry gave way to Gray Porphyry, which thereafter continued to form the hanging wall of the ore body, limestone being in all cases its foot-wall. The White Porphyry contact, for reasons which the general geological description must have made apparent, is necessarily the top of the Blue Limestone; but the continuation of the Gray Porphyry contact soon came directly beneath the regular outcrop of iron vein material, which here has more than double the width that it has farther south. Therefore it was evident that the Gray Porphyry, although itself having the regular eastern dip, was in reality cutting across the Blue Limestone. No direct evidence of the fold in-curving stratification lines has as yet been obtained, since where these would occur in mine workings the limestone

has been entirely replaced and structure lines are obliterated. In the lower workings of the Henriett mine, moreover, near the prolongation of the fault line, Parting Quartzite was found in the floor of a drift, which proves that at this point the ore body is near the base, whereas in the shafts it was near the top, of the Blue Limestone. The line of Section B is apparently the line of greatest depression of the Gray Porphyry sheet, since to the north what is apparently a slight fault brings the limestone up, cutting off the ore body, and on the south, towards the New Waterloo shaft, the contact rises. This shaft was sunk entirely through vein material and Gray Porphyry, and apparently found no White Porphyry. The faulting movement has here become a slight down-throw to the east, comparable in direction and amount to the Morning Star fault, and which might readily be mistaken for a simple monoclinical fold. It is assumed to be the continuation of the Carbonate fault, though there is no direct proof, nor could a connection actually be traced, since the throw of the latter would become nil between here and where it is actually demonstrable. On the same line to the north, in Little Stray Horse Ridge, there is a displacement, which passes into an anticline on Fryer Hill, in the Dunkin ground.

West of the Halfway House shaft the contact between limestone and White Porphyry has been explored for ore, and is found to be cut off by a sudden deepening of the Wash, which evidently represents the shore-line of Lake Arkansas mentioned above. In the Jolly shaft the Wash is 140 feet deep and an east drift from it finds vein material and limestone.

The map shows an eroded anticline west of the Jolly shaft, which is the southern continuation of the quaquaversal, shown on the Leadville map, between the west ends of Fryer and Carbonate Hills.

*Morning Star and Forsaken.* — On the line of Section C the underground data are less complete, and the structure, which is even more complicated, is consequently determined with less certainty. The rocks passed through by the Waterloo Lower, Forsaken, and Portland shafts could not be determined by actual observation, and the information obtained may not be in every case geologically accurate. In the Forsaken incline the limestone dips regularly eastward, and the action of replacement, acting from the surface downwards, is very clearly shown. Figure 4, Plate XXII, repre-

sents a sketch of the north wall of the incline, near its head, in which, however, the transition between unreplaced limestone and vein material is less gradual than it is in nature. Above the contact in this mine, between vein material and White Porphyry, is a varying thickness of white quartzite, scarcely to be distinguished from porphyry. This is assumed to be a portion of Weber Shales left above the Blue Limestone, as is so frequently the case on Carbonate and Iron Hills. South of the Forsaken shaft the ore body, which is a layer of sand carbonate at the contact, extends apparently into the ground of the lower Evening Star, though these workings were not accessible during time of examination. West of the south shaft of the Forsaken, drifts run up along a barren contact into the Wash, which deepens rapidly along the lower end line of the Evening Star claim.

From the Forsaken incline south toward the Waterloo line, the formation rises apparently, though the connecting drift, which has a southeast course, descends near this line on a steepening dip eastward. From this drift, between the boundary line and the Main (or lower) shaft of the Waterloo, an incline follows for a short distance a rich body of sand ore at an angle of  $25^{\circ}$  to the east. At the head of this incline, directly over the ore, is a thin sheet of White Porphyry, which is overlaid by Gray Porphyry. This Gray Porphyry body dips steeply north and east and comes in actual contact with the ore at the end of the incline. It is also cut in the bottom of the Main shaft, where it is underlaid by vein material carrying a little galena. This shaft is said to have passed through vein material and then limestone before reaching the porphyry. South of the shaft a drift intended to connect with the New Waterloo shaft is in limestone, which has an apparent dip north. From the observations above noted, it would seem that the Gray Porphyry is here cutting across the limestone up into the White Porphyry in a southwesterly direction, as it is in a westerly direction on the line of Section B. Also that a slight anticlinal ridge runs along the Waterloo-Forsaken line, from which, however, the White Porphyry has not been entirely eroded off, as it has on the line of Section B. This structure may be seen graphically by supposing Section B to represent a north-and-south section across the Waterloo-Forsaken ore body on a line just west of the New Waterloo shaft. There would be the same bowl shaped syncline,



though perhaps shallower, and a shorter anticline beyond it to the south, from which the White Porphyry had not been entirely eroded off. The conditions in the Waterloo Main shaft would be represented by those of the dotted lines, which on Section B denote the projection of the Harker shaft, and the Evening Star Lower shaft would occupy a corresponding position to the No. 3 Henriett. The ideal structure outlined here necessitates a very sudden rise in the original Blue Limestone surface to the northward, near the Waterloo-Forsaken line, as the movement of the Carbonate fault, which on the line of Section C is nearly 140 feet, would have become nothing and even be reversed before reaching the line of Section B.<sup>1</sup>

Niles-Augusta and Wild Cat. — South of the Forsaken the data to be obtained from workings west of the line of Carbonate fault were still more meager. The Evening Star Lower and Catalpa No. 2 shafts were both inaccessible; the former was said to have found a large body of vein material and ore, as shown in Section D. The latter was sunk 210 feet, and found the formation dipping nearly 45° east. From the dump it was evident that in its lower part it had passed through White Limestone and quartzite. It was assumed that it had passed across the fault line and reached the lower formations east of it.

From the Niles shaft three levels had been run. The upper drift ran east through White Porphyry and struck vein material at the Evening Star line. On the second level the drifts were mainly in limestone, with some vein material at the contact of overlying porphyry, necessitating a steep westward dip in the formation from the contact of the upper level. The lower level at 230 feet was entirely in limestone, whose stratification lines could not be distinguished. The limestone in this mine was of lighter color than is ordinary in the Blue Limestone.

---

<sup>1</sup>Mr. Ricketts (loc. cit., p. 13) supposes a much simpler structure through the lower Waterloo and Forsaken mines, namely: that the formations continue westward on their normal dip until they reach the surface, there being no displacement anywhere along the assumed line of the Carbonate fault. His opinion is of weight, since he had the advantage of later and more extended underground workings and could give months of time where we could only give days. His explanation, however, takes no account of the White Porphyry west of the Carbonate fault line. Assuming that he is right and that our determinations of the existence of White Porphyry are at fault, some structural explanation similar to the above is required to the south of this line before the unmistakable conditions existing in the Ætna-Pendery grounds are reached.

In the Wild Cat the bottom of the shaft was in the same light-colored limestone. At a depth of about one hundred feet a level ran east along a waving contact, with considerable though irregular development of contact vein material and the same white quartzite above it that was found in the Forsaken mine. A north drift from this level followed a similar barren contact, the Wash at one point coming down into the roof of the drift. A cross-cut west from the end of this drift passed over a ridge in the formation and stopped just as it commenced to dip sharply westward.

**Lower Crescent.**—The workings of the Crescent Lower shaft were platted from a compass survey, and, while not as accurate as those from actual surveys, are sufficiently so for the purposes of this work. The shaft, which is 145 feet deep, passed through Wash 22 feet, iron-stained clay 10 feet, White Porphyry (soft above and hard block porphyry at bottom) 113 feet. The drifts followed clayey iron-stained material, with some development of specular iron, but no unaltered limestone was found. The east drift at the end had a dip of  $45^{\circ}$  east. The west drift passed over a slight ridge and stopped in a gentle westerly dip. Here the calculated down-throw of the Carbonate fault is about one hundred and forty feet.

The deductions made from the observations in these workings are, first, that there is a probable western dip in the formation on the lower slopes of the hill and, second, that an anticlinal structure is developed just west of the line of Carbonate fault, which to the north gradually merges into the axis of the fault, without, however, becoming strictly identical with it. The sections show a single anticlinal structure south of the Henriett-Waterloo line and a double anticline with a sharp included syncline on that line. It is possible that the structure south of that line will not prove exact in its details when more extended explorations shall be made; but errors of detail are in a measure unimportant, the great object being to determine whether there be a western dip in the formation along the lower slopes of the hill, which seems reasonably probable.

## CHAPTER IV.

### FRYER HILL GROUP.

#### GENERAL DESCRIPTION.

Fryer Hill, which has become so famous in the mining world by the richness of its ore deposits, forms a comparatively insignificant feature in Leadville topography, being simply the extreme shoulder of a minor spur extending to the westward from Breece and Yankee Hills, between Little Stray Horse and Big Evans gulches; its extreme elevation above these gulches is only 200 feet. At one time the Big Evans glacier probably covered its surface, and the moraine material which it left behind during its retreat, though partially removed by later erosion, still covers the surface of the hill to an average depth of about one hundred feet. For this reason the study of its geological structure has been a very laborious work, and one which could hardly have been accomplished were it not for the extensive underground developments made by the numerous mines among which its surface is divided up. As contrasted with the already described groups of Iron and Carbonate Hills, Fryer Hill exhibits an extreme of mineral replacement. The Blue Limestone is represented mainly by occasional detached patches of lime sand or disintegrated dolomite and irregular accumulations of iron vein material, more or less impregnated with rich carbonates of lead and chlorides of silver. The beds, which were horizontal previous to the action of mineralization, have been, during the dynamic movements which followed, compressed into gentle folds, and their crests have since been planed off by the great Evans glacier. These folds consist of a main anticlinal fold, whose axis has a northeasterly direction and forms a continuation of the Carbonate fault line, with a synclinal fold nearly

parallel to it on the northwest. There is, moreover, a general dip of the folds and of the beds that compose them to the northeast. The structure is further complicated by minor crumplings, which are shown by the wavy outlines of the outcrops, but in which it is difficult to trace any regular law. In addition to all this the development of porphyry has been exceptionally great in this region. As already shown, the cross-cutting zone of White Porphyry passes through the southwestern edge of the hill, so that there is an underlying and an overlying body throughout the greater part of its area; and in the Amie ground the ore horizon is split up into three sheets, each bounded by White Porphyry. Gray Porphyry is found as an overlying sheet, as the continuation of the cross-cutting sheet of Carbonate Hill, in a dike-like body, and in several small and apparently detached sheets.

While on Iron and Carbonate Hills it is always possible to trace the limits of the original body of Blue Limestone, which shows but a moderate variation in thickness, on Fryer Hill it is difficult to explain the seemingly enormous contraction that this bed has suffered through the action of replacement. It is true that the intrusion of the porphyry mass has in many cases split the original body into several isolated sheets, whose originally irregular shape would account for a certain variation in the thickness of the present bodies of vein material. On the other hand, this explanation hardly seems adequate for certain extreme instances, such as that in the Little Chief mine, where within a distance of scarcely over one hundred feet the iron body varies from a thickness of six feet up to ninety feet. It would almost seem in such cases as if, in the plastic condition to which the presence of enormous quantities of surface waters had given rise, not only in the ore bodies but also in the surrounding porphyry, an alternating thickening and thinning of the body, perhaps already inaugurated by the shape of the original limestone, had been very much increased by subsequent compression within the mass. In other cases the finding of two bounding quartzites, that which represents the Weber Shales and that forming the Parting Quartzite, proves that there has been an absolute contraction due to replacement. The average thickness of the iron body on Fryer Hill will probably not exceed fifty feet, whereas, as has already been seen, the original Blue Limestone often reaches 200 feet in thickness.

Before proceeding to a detailed description of the individual mines, it may be well to mention briefly the locality and manner of occurrence of the main rock masses observed on Fryer Hill.

**Gray Porphyry.**—The bodies of this rock found on the hill have been indicated without any direct connection, simply from the fact that it has not been possible in the present state of development to trace each connection definitely, although it is very probable that many of the intrusive bodies may have a common origin. The principal body is that which is shown along the eastern and northern limits of the map, which is all that remains of the main sheet of Gray Porphyry, developed in such thickness in Little Stray Horse Park. It is the ordinary gray, somewhat decomposed rock, and has been proved in the Winnemuck shaft of the Little Pittsburgh, in several of the small shafts along the northern edge of the hill on the slopes of Big Evans gulch, and in all the shafts on the eastern edge of the map and immediately beyond it.

The second is a dike-like body, which extends probably from the Lee to the Chrysolite, although its continuity in a portion of this distance, between the Pittsburgh and the Amie claims, has not been definitely proved. This would seem to belong to the type of interrupted dikes, as it only reaches the surface in certain points, whereas in others the ore bodies extend continuously over it, but in depth it is doubtless continuous through its whole length. Where cut entirely through, it has an average thickness of forty-five to fifty feet. It is generally so decomposed that it is simply a soft, clayey mass, its only distinction from masses of White Porphyry in a similar condition being its mottled appearance, due to the forms of feldspar crystals and to iron stains resulting from the decomposition of hornblende and biotite. Occasionally, however, the characteristic large feldspars are distinctly visible, although the mass is so thoroughly altered that the pressure of the hand suffices to reduce it to a shapeless mass of plastic clay. In general this body seems to have a dip of about  $45^{\circ}$  to the northeast.

The third important mass of Gray Porphyry occurs within the lower White Porphyry, and has been cut in a drift connecting New Discovery No. 1 with New Discovery No. 5, and in the grounds of the Chrysolite between Vulture No. 1, Vulture No. 2, and Colorado Chief No. 2; in each

instance characterized by its mottled appearance and by its more thorough decomposition than the inclosing White Porphyry. This is probably part of the same sheet which crosses the White Limestone under Little Stray Horse gulch, and is cut in a shaft south of New Discovery No. 5, in the New Gambetta shaft, and in the Eudora shaft. New Discovery No. 6 cuts a similar sheet of Gray Porphyry in the Blue Limestone, which evidently is part of the cross-cutting sheet of the Waterloo-Henriett claims. There is little doubt that all these bodies form part of the same intrusive sheet which is gradually rising in geological horizon to the westward, as shown graphically on the map.

Besides these three principal bodies, small irregular sheets are found overlying the iron in the southern portion of the Little Chief claim and in the Robert E. Lee mine, apparently conformable with the formation. In the eastern portion of the latter mine also is a dike-like sheet, five or six feet thick, cutting through the ore body and extending from the northern drift on first level to the eastern drift on second level, or in a northwesterly direction, with a dip, however, to the eastward.

**White Porphyry.**—The upper sheet of White Porphyry is generally very much decomposed, and within fifteen or twenty feet of the ore bodies it is reduced to a mixture of clay and quartz grains. Over the main summit of the hill there is little of it left, probably on an average not more than fifteen or twenty feet. Its decomposed state is evidently due to the abundant action of surface waters, which have free access through the superincumbent Wash, there being no solid rock above it.

The lower White Porphyry is relatively much less decomposed, although the microscope shows that decomposition has already progressed to a considerable extent within its mass. In some places, however, notably in the lower drifts of the Dunkin and Climax, where it approaches the lower limestone, it has been reduced to a clay and is so full of oxide of iron that it is difficult to distinguish it from the iron mass which has replaced the limestone. It is also characterized by a laminated appearance which makes it closely resemble decomposed shale. Its thickness has been proved in a number of shafts to vary from sixty to one hundred and sixty feet, as follows: Climax No. 1, 115 feet; Climax leased shaft No. 1, 60 feet; Cli-

max No. 5, 115 feet; Dunkin No. 1, 110 feet; Montana shaft, 99 feet; Amie No. 2, 163 feet; Little Chief No. 1, 135 feet. It will be noticed on the map that this lower sheet of White Porphyry gradually passes up across the body of Blue Limestone to the southward towards Carbonate Hill, finally merging with the upper sheet.

**Weber quartzite.**—The overlying quartzite is coarse-grained and sometimes micaceous, as is common in the Weber formation. It occurs in detached patches at various points between the ore body and the overlying porphyry. Its most continuous body is in the Chrysolite ground, where it extends from the Roberts shaft towards Chrysolite No. 4, and varies in thickness from one foot to six feet. In the Roberts shaft, where its maximum thickness occurs, it is separated from the iron body by ten or fifteen feet of porphyry. In a drift from the Roberts shaft to Chrysolite No. 4 it is found sometimes resting directly on this iron, again separated by several feet of porphyry, and at other times split up into several bodies. Elsewhere on the hill it is generally found in more or less rounded fragments, included in the porphyry, directly above the iron.

**Blue Limestone.**—Small irregular bodies of palé-blue sand, generally near the surface of the ore, are frequently found in the vein material of Fryer Hill, especially in the Chrysolite ground. The occurrences of actual bodies of limestone in place are, however, extremely rare. Those observed are—

1. At the extreme western edge of Fryer Hill, as shown in the Colorado Chief and some of the adjoining prospect shafts, where it is struck directly beneath the Wash and apparently rests immediately upon the Parting Quartzite, with no intermediate body of White Porphyry. The outlines of this body could not, of necessity, be very definitely obtained, but it is probably of considerable extent and evidently represents the wedge-shaped portion separated by the cross-cutting sheet of White Porphyry. It is here a dark-blue, granular limestone, frequently somewhat impregnated with iron.

2. A large body of lime-sand occurs in the western portion of the Chrysolite, south of Vulture No. 2, adjoining the lower iron body.

3. A fragment of Blue Limestone is found below the main iron body, included in the porphyry, in the second western drift south of Vulture No. 3 shaft (see Section F, Atlas Sheet XXXIII).

4. A nearly continuous bed of lime-sand, in which are occasional portions of compact Blue Limestone, is found overlying the iron body, extending from near Vulture No. 3 over adjoining portions of the Vulture, Carboniferous, Chrysolite, New Discovery, and Little Chief claims.

5. In the Little Chief mine, about the middle of the claim and south of the Gray Porphyry dike, a body of limestone comes in suddenly, occupying the greater portion of the ore horizon for a considerable distance, an up-raise having been made through it; while below it has been proved to extend to the Parting Quartzite by a drift running along the contact of the two in an east-and-west direction. This limestone is partly disintegrated into sand and partly in a compact state. A little farther south the iron body is found resting directly on the Parting Quartzite, affording a direct proof that it is a replacement of the limestone. (See Section J, Atlas Sheet XXXIV.)

6. The most considerable body found is that cut at the northern end of the third level of the Dunkin mine. The drift runs through this body for a distance of about one hundred feet, the stratification lines showing at first a dip of  $45^{\circ}$  to the northward; the angle becomes shallower farther on, which may be due to a change in the strike. This body shows the characteristic ribbed structure of the Blue Limestone and contains imperfect casts of fossils. It has, moreover, every external appearance of a solid hard rock, but upon being broken down crumbles at once to fine sand.

The analyses of these lime-sands show no essential change in composition from the unaltered rock, as regards their contents in carbonate of lime and magnesia. The following are the proportions obtained:

	Carbonate of lime.	Carbonate of magnesia.
Dunkin lime-sand .....	55.14	44.29
Chrysolite lime-sand .....	54.09	43.79
Silver Wave limestone (type rock)....	54.98	44.39

The disintegration is probably due to the dissolving out of the cementing material, which held the grains together, by percolating waters, and from the above analyses it would seem that in these dolomites, as in quartzites, the cementing material was essentially of the same composition as the rock itself.



**Gangue.**—The material which replaces the limestone on Fryer Hill does not differ essentially from that already described on Iron and Carbonate Hills. It is mainly an impure mass of oxides of iron and manganese, with a greater or less admixture of silica and clayey materials. It differs somewhat in different portions of the hill, being relatively richer in alumina and iron in the main mass of the hill, and very silicious in the eastern portion, or in the Lee group of mines. The black or manganiferous iron, which forms a large portion of it, though very irregular in its distribution, is, as elsewhere, generally barren. In the main mass of the hill silicious replacements consist of black chert, often forming large, almost solid bodies and at other times being thoroughly shattered into angular fragments, the seams more or less filled with clay. Considerable amounts of sulphate of baryta in crystalline form are scattered irregularly through the ore deposits, and are generally considered a good indication of ore, inasmuch as they usually accompany rich masses of chloride. The oxide of iron is generally hydrated, though sometimes mixed with a certain amount of anhydrous oxide. Frequently it forms a comparatively pure iron ore and is valuable as a flux, notably that occurring in the Amie mine. From this, with varying proportions of iron and silica, it passes through jaspery iron with conchoidal fracture into almost pure silica. It is frequently cavernous, the cavities being lined with crystals of quartz, cerussite, and sometimes of pyrolusite. Black iron contains from 10 per cent. of manganese upwards, though never approaching a pure manganese mineral in any large quantity, except in the Dunkin and in the adjoining workings of the Climax No. 3. No pyrites, so far as known, have ever been found in the mines and carbonate of iron is extremely rare.

**Ore deposits.**—Ore occurs either in the form of galena or its decomposition products, carbonate and a little sulphate of lead, with a small amount of chloro-phosphate or pyromorphite; and silver, either inclosed in the galena or impregnating the vein materials in the form of chloride, chlorobromide, or iodide, or a mixture of the three. Galena occurs irregularly, generally in the center of a large mass of vein material, with its surface more or less oxidized and changed into carbonate. Besides this, considerable masses of sand carbonate with hard carbonates are found, which are

always more or less stained with iron. Actual pseudomorphs of carbonate of lead after cubical crystals of galena have been found, as have also small crystals of pyromorphite and molybdenite. The galena, as a rule, contains a proportionately larger amount of silver than the carbonate of lead, as might naturally be expected, since, in the oxidization of galena by percolating waters, silver is removed in the form of chloride and has frequently been redeposited at some distance from its original position. In this way the Lee group of mines evidently owe their ore entirely to the later mineralizing action, since they are practically free from lead and consist of chert and highly silicious red and yellow ochers, impregnated with chloride and chloro-bromide of silver, without any lead. The darker-colored sand carbonates are, as a rule, the richer; those found in the Amie mine, for instance have a dark-blue or greenish tinge and carry 300 ounces of silver to the ton, whereas the light-colored carbonates of the Morning Star mine only contain from forty to fifty ounces to the ton.

The extreme irregularity of the occurrence of the ore renders any generalization extremely difficult. It may be stated, however, that here, as in all the other hills, the rich ore is generally, though not invariably, found along the upper portion of the ore body. The main bonanzas or ore bodies, as will be seen by reference to the map, have a nearly east-and-west direction, parallel to the dike already noticed. It will also be noticed that the richest bodies have been found in comparative proximity to this dike and to the northeast of it, the main rich body to the southwest of this dike being that in the New Discovery, Little Chief, and Little Pittsburgh mines, opposite what seems to be a partial break in the continuity of the dike. The influence of this dike on the deposition of ore has evidently been to cause an interruption or stagnation in the ore currents, by which their contents were precipitated more richly in a sort of eddy immediately adjoining it. On the northern portion of the hill no large ore bodies have been found as yet, although the existence of a large body of iron has been proved in which there are found small irregular pockets of ore. Exploration in this direction has been comparatively neglected on account of the great inrush of water wherever shafts have been sunk to the ore horizon. Erosion must

have removed an enormous quantity of ore from the crest of the fold, and doubtless from the surface of many of the existing ore bodies. As a rule the lower iron bodies are comparatively barren. On the other hand, that very rich portion of the Lee body which extends into the Matchless and Hibernia grounds is immediately above the Parting Quartzite, or represents the very bottom of the Blue Limestone. A small body of ore was obtained from the lower bed of the Amie mine, which yielded seventy ounces to the ton, and from the workings of the Vulture No. 2 some pay ore was obtained in the same horizon.

The dip of the ore horizon is generally quite low, in the New Discovery not more than  $5^{\circ}$  and in the Little Pittsburgh and Little Chief the southern portion is quite horizontal. In the Chrysolite it dips from  $10^{\circ}$  to  $11^{\circ}$ , whereas in the Amie the dip is  $20^{\circ}$  to the northwest. On the east side of the antilinal fold the dip is uniformly steeper, so that from the Lee to the Denver City the outcrop is relatively narrower.

**Parting Quartzite.** — The Parting Quartzite, where observed, is not over ten to fifteen feet in thickness and, as contrasted with the upper quartzite, very much decomposed, being generally disintegrated to a fine white sand and in every case very much iron-stained; it also contains considerable mechanical admixture of clay from the porphyry, so that it is not always possible to distinguish it with certainty from a highly decomposed White Porphyry from which the earthy bases have been largely removed.

**White Limestone.** — The White Limestone has been cut by several shafts on Fryer Hill. In its most characteristic form it is found in the Amie No. 2, where it was struck at a depth of 273 feet and has its peculiar light-drab color, compact texture, and the characteristic segregations of white chalcidony or chert. It is also found in the lower levels of the Dunkin and Climax mines, at their southern extremities, and in the Eudora and Pittsburgh shafts, toward Little Stray Horse gulch, where it comes up to the Wash; likewise in Chrysolite No. 6.

**Lower Quartzite.** — This quartzite has been cut by various prospect shafts along the western borders of the hill; among others, by the Little Eva No. 5, and by the Lida shaft, near Cumming & Finn's smelter, where a small intru-

sive body of White Porphyry was found in it. In other portions it has not yet been actually cut, but its existence is readily deduced from the position of the formations above it.

**Fryer Hill map.**— Before proceeding to a description of the underground workings of the various Fryer Hill mines, it may be well to explain what is intended to be represented on the map of that region (Atlas Sheet XXXI) in somewhat greater detail than is given in the legend. It has been attempted here to show on a single sheet the actual surface of the ground, the rock-surface beneath the Wash (distinguishing the different formations which make up that rock-surface), and the underground workings of the various mines, with the outlines of the bonanzas or ore bodies, as far as could be determined at the time of examination. The attempt to delineate so much on a single sheet has resulted in a complication, which it will require the reader's closest attention to unravel. He must first bear in mind that the black contours indicate the actual surface of the ground, and the figures attached to them, their relative elevation above the 10,000-foot curve. Second, that the geological colors indicate the outcrops of the various rocks and formations as they would appear if the superincumbent Wash material (which, as shown by the sections, has a thickness of from thirty to one hundred feet over the whole surface) were entirely removed. Third, that the drifts of the various mines and the outlines of the ore bodies, as determined by the explorations of those drifts and shown in black dots, are projected on a plane surface, or, in other words, are represented as if the rock material above them were entirely transparent and without regard to its thickness. These drifts, while in the main following an approximately horizontal plane, are in many mines on two or even three different levels. Owing to their approximate horizontality it was impossible, without too great complication, to indicate these different levels by any series of colors or conventional signs, but figures have been placed within the drifts to show their elevation in feet above the 10,000-foot curve. The map thus furnishes the data from which a section may be constructed along any given line, and from it the various sections represented on Atlas Sheets XXXII, XXXIII, and XXXIV have been so constructed. In unexplored portions these sections are more or less ideal, and actual exploration may prove them to be not absolutely

correct. The intersections of the drifts with these sections show to what degree the plane of the section has been actually explored, but the outlines of the formations as indicated there are determined also from analogy and by deduction from observations made in the vicinity, but not actually on the section plane.

On the surface map the outlines of the various claims are indicated by broken lines. These are sometimes difficult to trace, owing to their coincidence with lines of drifts or with the blue lines representing the lines of the different sections. They are given as accurately as could be determined by the engineers who had been employed in surveying them; but, as invariably occurs in rich mining districts, there are many cases of contested boundaries between adjoining claims which have either been settled by compromise or are still in litigation, so that the lines here given cannot be assumed as officially and finally correct. The laying down upon an accurate topographical map of a mining district like this of finally correct side lines to the many claims that are there located, if not an absolute impossibility, would require an amount of time entirely incommensurate with the value of the result to be obtained, as can be readily understood by those familiar with the working of the land system of the United States as applied to mineral claims. In describing the various mine workings and ore bodies of this group, they will be taken up in geographical order, proceeding from west to east, without regard to priority of discovery.

#### MINE WORKINGS.

**Chrysolite mine.**—The property of the Chrysolite Mining Company consists of the following claims: Carboniferous, Chrysolite, Vulture, Little Eva, Colorado Chief, Pandora, Fair View, Kit Carson, and All Right. The greater part of the ore extracted from this property has been obtained from the first three claims. The area occupied by the others, as shown by the map, is mostly west and south of the outcrops of the main ore body, indicated in dark blue crossed in black; in other words, over this area the ore has been mainly removed by erosion. The Discovery shaft of the Chrysolite has, so far as known, discovered no ore. The first considerable ore body was opened by Vulture No. 1 shaft, near the northern end of this claim.

Soon after the discovery of this ore body, it was found by some clever persons that, as not unfrequently happens in the location of claims, a small triangular piece of ground in the immediate vicinity of this shaft, about thirty-six feet by sixty on the sides of the triangle, was left unclaimed. The shaft now called the Eaton shaft was at once sunk by these men and the continuation of the Vulture body there discovered. In self-defense the Chrysolite Company were obliged to buy out this little claim, generally known as the Triangle, at what at the time seemed a very high price, but which was repaid to them more than threefold by the ore which they extracted from the ground. A still smaller unoccupied piece of ground between the end lines of the Vulture and the Chrysolite, appropriately called the Sliver, was similarly taken up, and was bought out by the Chrysolite Company, but has thus far proved an unprofitable purchase. This can be distinguished upon the map by the two shafts, Sliver No. 1 and Sliver No. 2, which have been sunk upon it. The ore body at the Eaton and Vulture No. 1 shafts was near the outcrop of the upper iron body, and therefore its limits to the westward were soon reached. It was traced eastward, descending irregularly, but at a low angle, as far as the Carboniferous-Little Chief line. This ore body, though narrow, was extremely rich and yielded the greater part of the immense returns which were obtained from the mine in the earlier days of its working. Section B shows its outlines along an east-and-west line. From it were obtained large masses of chloride of silver, associated with cerussite, a single transparent mass of chloride which weighed several hundred pounds having been extracted.

A second ore body, parallel to this, was found about one hundred feet to the southward, which was traced in a southeasterly direction to the New Discovery-Vulture line, where it widened out and then disappeared. In the bottom of an east-and-west drift, a little south of this body, several masses of limestone were found below the main ore body, which in early days, before the character of the formation of the ore was understood, much puzzled those in charge of the mine. The extent of this unreplaced limestone was never determined, but it is now evident that it is simply a portion of the Blue Limestone, which existed wherever now the body of vein material is found, and which, for some reason or other, had not been replaced by vein

material. Along the Vulture-New Discovery line considerable unreplaced lime-sand was also found on top of the iron body, extending into the New Discovery ground.

The main ore body, which was opened by the Vulture No. 1 and Eaton shafts, was traced a little south of east to the extreme southeast corner of the Carboniferous claim, with an average width of about fifty feet and a thickness of twelve to twenty feet. In the eastern portion it is opened by Chrysolite No. 3 and Carboniferous No. 1<sup>1</sup> shafts. It ends quite abruptly, both on the north and south, though barren vein material is found on either side of it. Cross-cutting drifts soon pass through this vein material into overlying White Porphyry, showing that the ore body was on the crest of a minor ridge or corrugation in the vein material, on either side of which is a shallow basin. That to the south has proved barren for a considerable distance into the New Discovery ground. Its form is shown in Section F, where it is seen that the upper portion consists largely of unreplaced limestone. An ore shoot was also followed, descending in a northeasterly direction from the Triangle workings, which later developed a large body of ore in the neighborhood of Chrysolite No. 4 shaft. In these older workings the rich ore consisted mainly of carbonate of lead and chloride of silver, with a comparatively small amount of galena. In the vein material a blue-black chert is prominently found, occurring in bodies up to ten feet in thickness. From this impure silica it passes into silicious iron and then into a clayey limonite, more or less impregnated with oxide of manganese, the extreme form of which, known to miners as "black iron," is a sort of impure wad. These were the early workings of the mine, made in the upper ore horizon.

Explorations were also conducted westwardly by a drift running a short distance south from Vulture No. 1 and then west to Vulture No. 2. The workings of Vulture No. 2 shaft disclosed a considerable body of vein material, about twenty-five feet in thickness, immediately underlying the Wash, containing a little ore, and passing to the south into lime-sand. To the west of this is a coarse decomposed quartzite, which is assumed to represent Parting Quartzite at the base of Blue Limestone. The connect-

---

<sup>1</sup> Wrongly marked No. 7 on the map.

ing drift between Vulture No. 1 and Vulture No. 2 is mainly in very much decomposed Gray Porphyry, distinguishable by its mottled appearance and occasional large crystals of feldspar. White Porphyry separates this from the ore body of Vulture No. 2, and the contact between the two porphyries, which dips to the eastward, is slightly iron stained. The ore body of Vulture No. 2 evidently represents a small portion of the Blue Limestone, split off from the main body by the lower White Porphyry and by this intrusive sheet of Gray Porphyry, which is assumed to be the same found in New Discovery No. 5, which, extending across Little Stray Horse gulch, connects with the lower body on Carbonate Hill. The drift, in a southwesterly direction, from Vulture No. 1 to Colorado Chief No. 2, also crosses this body of Gray Porphyry. Midway between the two shafts the top of the drift cuts a body of fine conglomerate, resting immediately upon the porphyry and apparently belonging to the Lake bed formation. In the southeast corner of this drift a winze has been sunk to a depth of 86 feet, passing through the Gray Porphyry sheet into an underlying iron body, from which ore assaying 72 ounces to the ton was taken. The winze was abandoned on account of the difficulty of handling water; but its exploration proved sufficiently that the Gray Porphyry is a sheet dipping northeastward with the formation and that a second iron body occurs below it. A large outcrop of Blue Limestone, partially replaced on its upper surface and represented on the map in the Kit Carson, Fairview, Pandora, Colorado Chief, and New Discovery claims, belongs to this lower body, which is separated from the main upper ore body by the cross-cutting White and Gray Porphyries. The outlines given on the map are determined mainly by data derived from the dumps of a few abandoned shafts, and therefore are probably not absolutely correct. Its widest part is in the line of Section F, between Colorado Chief No. 1 and Pandora No. 3 shafts, the latter finding some vein material at its base.

The portions of the mine thus far described, and which are shown in the southern and western ends of Sections L, F, and B, respectively, were opened in the early days of ore development in the district, when it was supposed that the ore bodies would probably be found to take a downward direction towards the unknown sources below, from which they are gener-



ally supposed to come. Mining was, therefore, conducted without any definite system. Drifts were run here and there, up and down, wherever ore could be found, so that it was extremely difficult in traversing them to form a clear idea of the actual extent and form of the ore bodies or to know whether or not important ground still remained unprospected. When Mr. W. S. Keyes took charge of the mine a new and more rational system of development was adopted. A large three-compartment shaft, the Roberts shaft, was sunk in what it was supposed was the deepest part of the ore horizon, and from this shaft a system of horizontal drifts was run off at two or three different levels, with a regular system of rectangular cross-cuts at given distances. In this way it was possible to map out the shape of the ore bodies, and it soon became evident that the vein material occurred as an interstratified mass between two sheets of porphyry, somewhat irregular and corrugated, but basining up to the surface on the southwest and northwest. With the increased facilities for handling ore given by a large shaft and by level tramways leading from every part of the mine to it, the work of exploration could be pushed much more rapidly and the extraction of ore proportionately increased. The old workings of the mine were further explored and considerable ore was discovered where the bonanzas had been supposed to be exhausted. Entirely new bodies of ore were also found to the west and northwest of the shaft, continuing irregularly up to the outcrop as shown on Sections A, K, and L. None of these bodies was of so great continuous extent or so rich in silver as the main ore body extending eastward from Vulture No. 1. The most extensive and the richest was that developed near Chrysolite No. 4.

In the drifts running southward from the Roberts shaft to connect with the Chrysolite No. 1 workings a body of Gray Porphyry thirty to forty feet in thickness was cut, which has since been traced eastward as far as the Robert E. Lee mine. In the Chrysolite ground this body of porphyry has a dip of  $45^{\circ}$  to the northeast, but farther north it stands apparently nearly vertical, and is, therefore, assumed to be an interrupted dike. It extends much farther east and west than is shown on the map, being exposed by drifts from the lower levels where it is wanting in these directly above them, showing that it tapers upwards. In the north-

west portions of the workings a few feet of Weber quartzite are found above the ore body, sometimes in direct contact with it and again separated by a slight thickness of White Porphyry; and in the extreme northwest workings the Parting Quartzite is found beneath the ore body, between it and the underlying White Porphyry, showing that here the entire thickness of the original Blue Limestone horizon is represented, compressed to a thickness of sixty to eighty feet. At the bottom of the Roberts shaft 10 feet of quicksand were passed through, which probably represents the disintegrated Parting Quartzite. The main west drift from the Roberts shaft on the 284-foot level, which runs a little south of west, passes for the first hundred feet through iron vein material containing some pay ore, then for 150 feet through block (White) Porphyry, then into a second body of iron vein material, at the extremity of which is some lime sand, succeeded by Parting Quartzite, all dipping gently to the eastward.<sup>1</sup> This is evidently the continuation of the ore horizon developed in Vulture No. 2, but it is noticeable that the Gray Porphyry found between that shaft and Vulture No. 1 is here wanting, showing that its northern limit has been reached. The lower iron body does not extend much north of this drift either, since, as shown in Section A, the drift westward from Chrysolite No. 4 finds the Parting Quartzite directly under the main or upper iron body.

In this northwestern quarter of the Chrysolite ground the body of vein material has averaged from sixty to eighty feet in thickness from its outcrops eastward and southward. In this vein material the bodies of rich ore are necessarily difficult to define, as they are simply concentrations of lead and silver minerals. The whole mass contains more or less of these metals, of which a certain arbitrary percentage is required to constitute pay ore. The ore consists, as in other parts of the mine, mainly of carbonate of lead and chloride of silver. The discarded iron vein material, which is extracted from the mine and accumulates on the dumps, constitutes a low-grade ore which it will doubtless some day be found profitable to work.

---

<sup>1</sup> Since the completion of field-work this drift has been pushed farther westward than indicated on the map, and has passed through the White Limestone into the Lower Quartzite, showing that the outlines given on the map, though from somewhat meager data, are in the main correct and that the formations basin up to the westward. This drift has also discovered a westwardly dip in the Lower Quartzite, proving further the existence of the anticline which had been assumed to exist here.

To the northeast of the Roberts shaft pay ore is cut off by a body of black iron, into which it passes so abruptly that the latter often forms a wall 20 feet in height. Above the black iron is a body of blue lime-sand about one hundred feet in extent. Beyond the ore stopes in the vicinity of the shaft, exploring drifts on the lower (284-foot) level connect to the northward with Carboniferous No. 5 shaft, and from there to the westward with Chrysolite No. 5 shaft by an up-raise to the 316-foot level, all in barren vein material. From Carboniferous No. 5, the bottom of which is in disintegrated Parting Quartzite similar to that cut in the Roberts shaft, a drift runs due north through White (block) Porphyry and at 200 feet from the shaft cuts White Limestone, which is slightly iron-stained at the upper surface. Still farther north, beyond the limits of the Chrysolite claims, the Silver Wing shaft was sunk through White Porphyry into a body of iron vein material, which is evidently a replacement of the upper portion of the White Limestone. Explorations were conducted here under great difficulties, owing to the immense in-rush of water, and, so far as they went, did not disclose enough pay ore to justify the owners in pursuing them further.

The evidence of these northern workings is very conclusive as to the basining-up of the formation to the northwest, and this evidence is further confirmed by the several shafts to the east of the Silver Wing, the Buckeye, Hazzard, Hercules, Comique, and O. K., all of which have found a considerable body of iron vein material, either at the rock surface or under a thin covering of White Porphyry, which represents the outcrop in this direction of the Blue Limestone horizon. As in the Silver Wing, the great in-rush of water has proved a bar to extended explorations from these shafts.

The Gray Porphyry dike separates the two main ore shoots of the Chrysolite ground. Little can be determined about the form of this body in depth, as explorations have not proved it below the Blue Limestone horizon. It may be simply a transverse sheet, cutting diagonally across the formations and assuming a vertical position as it approaches the present rock surface. Still, its form, so far as traced, is sufficiently characteristic of the dike type to justify the assumption that it is rather a true dike than a transverse sheet, though the distinction, so far as the deposition of ore is concerned, is comparatively unimportant. It is distinctly later than the White

Porphyry, as are the transverse sheets of Gray Porphyry already noticed, and like them its influence has been favorable to the deposition of rich ore. It should not, however, be regarded as a dike cutting through the ore bodies, since it was evidently intruded before ore deposition commenced. Its exact relations to the original ore bodies are now difficult to define, for these were probably deposited in the form of sulphurets in a much larger proportion of unreplaced limestone than now exists, and the secondary action of oxidation, which has been going on ever since, has evidently increased the volume of vein material and reduced that of the unreplaced limestone. The probability is that, as in cutting across the formation this body probably interrupted some of the natural water channels along the contact planes of different rock formations, it caused a partial stagnation of the ore currents in its vicinity and thus favored precipitation and replacement action there.

The ore bodies are continuous around its western end from the Triangle workings to Chrysolite No. 4, and it is probable that its western limit is not far from that indicated by its outcrop on the map, as otherwise it would have been cut by some of the drifts in this portion of the mine, which, owing to the basining-up of the formation here, reach lower horizons than elsewhere. The ore bodies are also practically continuous across the line of the dike along the Carboniferous-Little Chief line, but here the dike is proved to exist under these ore bodies by drifts at lower levels, and the inference, therefore, is that, as the dike did not extend up to the upper surface of the Blue Limestone, ore deposition went on uninterruptedly across this break in its upper line. It was just to the north of the dike, in the Little Chief ground, that the thickest body of pay ore was found. The ore body in the extreme southeastern portion of the Carboniferous claim was also very thick; but, being among the earlier discoveries, the workings had caved at the time of visit and could not be examined; 12 feet of lime-sand and 24 feet of ore are said to have been cut by this shaft.

**New Discovery.**—The New Discovery claim adjoins the Carboniferous and Chrysolite on the south and the Vulture on the east, and geographically forms part of the ground just described, though it belongs to the Little Pittsburgh Mining Company, the claim of that name lying entirely to the

east of the Little Chief, which separates it from the above claims. This and the Little Pittsburgh were the first mines worked in this region, and at the time of examination the larger ore bodies had been stoped out and the stopes were filled up, so that but imperfect data could be obtained with regard to them. The ore body was nearly continuous on a north-and-south line from the Carboniferous ground to New Discovery No. 2 shaft. It consisted mainly of sand carbonate, with chloride of silver, and had an unusual amount of barite in the gangue. This ore occurred mainly in the upper part of the ore horizon, resting in general on chert, with barren iron and clay below. This same upper ore body also covered a considerable area northwest of No. 2 shaft, and was expected to prove continuous over the greater part of the claim in that direction. As it approached No. 4 shaft, however, it gradually gave way to a mass of chert, which sometimes occupied the whole horizon, and which along the Vulture line was overlaid by a considerable body of lime-sand and unreplaced dolomite. On this northwest line a few small, scattered bodies of rich ore were found, but just to the northeast of it is the barren zone, already noticed in the Chrysolite ground, which seems to occupy a trough in the formation, the ore horizon, represented by comparatively barren vein material, descending towards its axis from either side. These descents are sometimes so abrupt as to suggest a slight movement of displacement. To the southwest of this line the ore bodies, which are very irregularly distributed, extend up to the Wash. They follow two radiating lines from the main ore body, the one in the direction of No. 1 shaft, the other intermediate between that and the drifts running to No. 4. In either case the ore bodies descend to the southwest, which would at first seem a contradiction to the statement that the formation has a general dip northeast. The fact is, however, that the rock-surface, like the surface of the ground, descends here towards Little Stray Horse Creek, and these ore bodies, which are all that erosion has left, belong to the lower part of the ore horizon. It therefore suggests itself that, if this lower portion had been thoroughly prospected in other portions of the mine, other ore bodies might have been found. Owing to the imperfection or want of surveys, it is impossible to say whether this has been done or not.

New Discovery No. 1 shaft is that in which the original discovery of ore was made on the claim by George Fryer, at a depth of 60 feet. The iron body was only 20 feet thick, and this shaft then passed into the underlying White Porphyry. The small thickness of the iron body is here due to the fact that the upper portion of the ore horizon has been eroded off. In later times considerable exploration has been done from the shaft to determine whether the ground to the south is ore-bearing or not. Diamond-drill borings were made from an east drift at a depth of 165 feet below the top of the shaft, both eastward in a horizontal direction and vertically downwards. Neither found any ore bodies. The vertical drill penetrated to a depth of over one hundred and seventy-five feet, making a distance of 340 feet in all below the surface. It passed through the porphyry, finding a thin streak of iron vein material in its midst, into the Silurian formation, and apparently through that into the Lower Quartzite or Cambrian. Frequent assays of the cores were made by Mr. Rudolph Keck, and a slight trace of silver, amounting in some cases to ten ounces to the ton, was found in most of the material passed through, but no evidence of any ore bodies.

To the southward a drift was run, descending from 10,347 to 10,316 feet elevation, which passed through White and Gray Porphyries, finding a small streak of iron oxide at the contact of the two. In the Gray Porphyry body the drift turns abruptly east to connect with No. 5 shaft, which it does at 100 feet below the surface. This shaft was sunk to a depth of 185 feet, and, judging from the material on the dump, must have passed through the Gray and White Porphyry bodies and the Parting Quartzite into the White Limestone.

An exploring shaft (No. 6) was also sunk on the ridge south of Little Stray Horse gulch, at the southern extremity of the claim. It was driven somewhat intermittently, and could not therefore be closely followed. The rocks passed through were approximately as follows: Wash, 120 feet; Gray Porphyry, 40 feet; Blue Limestone, 60 feet; Parting Quartzite, 20 feet; White Limestone, 20 feet. This is on the south side of the shallow anticline assumed to exist under Little Stray Horse gulch. The structure, as well as could be deduced from the meager data obtainable in this part of the region, is shown on Sections C and K. The body of Gray Porphyry,

which is here in the Blue Limestone, is assumed to be the same sheet which occurs in the lower White Porphyry at No. 5 shaft, and which is gradually cutting up to a higher horizon as one goes south, reaching the upper White Porphyry in the Lower Henriett ground.

From the relative elevation of the Blue Limestone in this shaft and in the adjoining shafts to the southeast, the Pearson (S-14) shaft of the Gambetta claim, the Joe Bates (S-26) shaft of the Stray Horse claim, and the Vanderbilt (S-25) shaft, there is evidently a break or a sharp fold in the formation to the east of this shaft. On the section both are assumed to exist, and the fault to be the northern continuation of the Carbonate fault. It must be stated, however, that it has not yet been cut on this ridge, and in so far its existence is a matter of pure hypothesis. There is unquestionably an anticlinal fold here, however, which can be traced northeastward into the Dunkin ground.

**Little Chief.**—This claim is analogous to that of the Evening Star, on Carbonate Hill, in that, being a narrow piece of ground left between two adjoining claims, it included within its area an unusually large proportion of ore-bearing ground. Its width is only 250 feet, instead of the normal 300, and the title to part of this was contested by the overlapping of the south end of the Little Pittsburgh claim. The outlines of the full claim are given on the map, as well as the broken line which was adopted as a compromise boundary between the contesting claims. As in the ground previously described, there are two main ore bodies, a southern and a northern, separated by the porphyry dike and an area of barren ground. The porphyry dike does not, however, reach the rock surface, as far as known, and in the western portion of the claim the ore body is continuous over it, and forms a connection between the northern and southern bodies along the Carboniferous and New Discovery lines. Here also, the southern body, at its outcrop immediately beneath the Wash, was the first opened. The original workings were reached through the small shafts Nos. 1, 2, 5,<sup>1</sup> and 7, and were driven irregularly, following the ore shoots. No. 1 found the ore directly beneath the Wash, at a depth of fifty to sixty feet below the surface, in a thickness of ten to twelve feet. The shaft was afterwards

<sup>1</sup>No. 5, which is the southernmost shaft on the claim, is wrongly numbered on the map No. 3.

sunk through the underlying White Porphyry and reached the Silurian formation at a depth of 198 feet, finding 2 feet of iron<sup>1</sup> at the top and penetrating it 16 feet. No. 5 shaft, due south of this, after passing through 63 feet of Wash, struck the underlying White Porphyry, and reached the Silurian formation at a depth of 159 feet. The ore bodies reached from No. 1 shaft are at an elevation of about 10,400 feet, and lie directly beneath the Wash. Those opened by No. 7 shaft are about fifty feet lower, and are covered by White Porphyry and by a thin sheet of Gray Porphyry which is seen in a drift leading from No. 2 shaft. The ore body in this portion of the workings was nearly horizontal and from one to two and a half sets of timber in thickness (8 to 20 feet). North of No. 2 shaft, however, the formation dips rapidly to the northward, and on the line of Section J a considerable body of unreplaced Blue Limestone, occupying almost the whole thickness of the ore horizon and underlaid by Parting Quartzite, is developed by an up-raise from the 320-foot level; a little south of this up-raise iron is found to rest directly on the Parting Quartzite, thus affording a direct proof that it replaces the limestone. A drift runs east and west 150 feet, at the level of the bottom of the up-raise, in this body of unreplaced limestone. This body of limestone differs from the smaller masses of lime-sand hitherto observed, in that the ore deposition has gone on above rather than below it.

**Gray Porphyry dike.**—The dike lies immediately north of this body of unreplaced limestone. So far as observed it nowhere reaches the rock surface within this claim, but ends at the top in a rounded end, as shown in Section J. Shaft No. 3, near the Carboniferous line, is sunk through Wash into ore, and at its bottom is directly in the dike. By the outlines of the dike, shown on the sides of this shaft, it is seen that it here stands nearly vertical, dipping at a steep angle to the north. Drifts to the north and east from the bottom of the shaft pass out of the Gray Porphyry directly into the ore body, and cross-cuts south from the main eastern drift strike it again, in some cases stopping at the dike, in others passing through or over it to connect with the south workings. The ground along the Carboniferous-Little Chief line on the line of the dike was, at the time of visit, a mass of crushed

---

<sup>1</sup>The term "iron," as used in these descriptions, is the miner's abbreviation for vein material carrying more or less iron oxide.



timbers, filling old stopes which were completely inaccessible, so that its connection between observed points in Little Chief and Carboniferous ground could not be examined. For this reason, in Section B, which passes through this portion, the dike has not been represented at all, though the plane of the section would cross it diagonally, and it undoubtedly is cut by that plane in some point. It is said that it is only 4 feet in thickness at this point, and that ore existed both above and below it; this statement must, however, be accepted *cum grano salis*.

Immediately north of No. 3 shaft an exceptionally thick body of ore was found, composed almost entirely of sand carbonates, mixed with a certain amount of clay and iron oxide. It extended at its maximum development eight sets of timber above and two below the level from the bottom of that shaft, or about ninety feet vertically, connecting to the westward with the Carboniferous ore body.

The newer workings of the mine are opened by two large three-compartment shafts, the Daly shaft and No. 4 shaft, from which regular rectangular systems of drifts are run. The greatest and most continuous development of ore is along the northern flanks of the dike, but the great thickness of pay ore found near No. 3 shaft seems to be local in character, as at 120 feet north it has decreased to 10 feet in thickness, and at the bottom of No. 4 shaft it is only five or six feet thick. No very large bodies of ore have been found north of No. 4 shaft, but a number of small chambers and pockets have been found south and west of the Daly shaft. This shaft passed through 103 feet of Wash, 20 feet of decomposed White Porphyry, and 50 feet of silicious iron. To the north of it several small bodies of dark, coarsely-crystalline blue limestone were found in the vein material, but no considerable ore bodies. The formation, as shown on Section J, is horizontal, or rising a little to the north, but to the northeast, beyond the Daly shaft, it soon commences to dip at a considerable angle, and yields considerable water, which forms a serious impediment in prospecting. Except in the northeastern portion, the Little Chief ground may be considered to have been very thoroughly prospected, and, as shown by the map, little or no useless expense has been incurred in prospecting at the southern end of the claim, where the ore horizon has been removed by erosion. The ore itself differs in no essen-

tial point from that taken from the adjoining mines. In the commencement it was smelted in a furnace, belonging to the company, situated near the shafts, and built on a very uncertain foundation, as with large chambers opened so near the surface the ground was bound to settle. It was soon found impracticable, moreover, to smelt with the ore of a single mine, and the advantage gained in transportation for its own ore was more than counterbalanced by the cost of that brought from other mines. This scheme was, therefore, soon abandoned, and the slags were afterwards used as a low-grade ore.

**Little Pittsburgh.**— Besides the New Discovery claim, already described, the Little Pittsburgh Company owns also the Little Pittsburgh and Dives claims, which occupy the area between the Little Chief and Amie claims, and overlap each, so that a compromise boundary line has been adopted in either case between them. As in the ground previously described, there are two distinct ore bodies; the one at the outcrop, the other immediately north of the dike. The dike itself is here more clearly defined than before, and stands with a dip of  $70^{\circ}$  to the north. In the body of vein material are found several thin sheets or stringers of porphyry, probably offshoots from the sheets of White Porphyry, which in the adjoining ground of the Amie mine have split the Blue Limestone, now represented by sheets of vein material, into three distinct portions, as shown in Section H.

The first prospecting shaft sunk on Fryer Hill was the Little Pittsburgh No. 1 shaft, and by a singular coincidence not only is this the point where the overlying Wash has the least thickness over the entire surface of the hill, but it is where the rock surface is highest west of the Amie claim, and is in the midst of one of the most important ore bodies of the region. The shaft is 36 feet deep, of which depth 20 feet is in Wash and 16 feet in ore. Near the bottom of the shaft is a large bowlder of Sacramento Porphyry which has fallen from the Wash, and whose under surface is polished and striated, showing that in its passage from the head of Evans gulch it probably was fastened in the bottom of the Evans glacier. The ore body opened by No. 1 shaft is only the relic of a much larger mass that has been partially removed by erosion, as is shown graphically in Section I. It will, therefore, be understood that the description applies to this relic, not to the original body. To the south it thins out rapidly, having dimin-

ished to 4 feet at 40 feet and to 18 inches at 70 feet from the shaft. In the end of the south drift, underlying White Porphyry and overlying Wash are both visible. An east-and-west drift explores the whole width of the ore body, reaching continuously into Little Chief ground. The body is nearly level, and in the southern portion has a slight inclination to the south. Its greatest thickness is from sixteen to twenty feet. Wherever its upper surface has been reached, the Wash is found resting directly on it. West of No. 1 shaft the underlying White Porphyry comes up to the level of the east-and-west drift just south of that drift and dips gently to the northward on the other side of the drift. East of the No. 1 shaft, near the boundary of the claim, the ore horizon consists principally of chert. Following this boundary northward the chert passes into black iron, and contains thin sheets of White Porphyry from one foot to two feet in thickness. In the abandoned workings just south of No. 2 shaft a winze was sunk 120 feet, entirely through White Porphyry, which was finally abandoned on account of great influx of water.

At No 2 shaft the ore body was 17 feet thick, and lay immediately beneath the Wash. About thirty feet north of this shaft the first White Porphyry in place was found overlying the ore. North of this line the ore horizon, which hitherto has been very flat, dips rapidly to the north, the incline which follows it descending 20 feet in a distance of 50 feet. From the foot of this incline run connecting drifts to the northern body, which develop, on the ore horizon and immediately above the underlying porphyry, masses of mangiferous iron and compact reddish chert, coated frequently with crystals of pyrolusite. The chert which is developed in the ore horizon, and which is one of the normal replacement products of the Blue Limestone, though very similar, yet differs somewhat from the concretions of chert found in the unaltered limestone, and which are very commonly included in the White Porphyry immediately above the contact. The latter is always compact and homogeneous, while the former readily splits into angular fragments, and its joints are frequently coated with delicate crystals.

The connecting drifts from the foot of the incline pass through this barren vein material, or through the White Porphyry under it, and crossing the Gray Porphyry dike, reach the northern ore body beyond it.

The foot-wall of the dike is here not very distinct, but the hanging or northern wall has a smooth, well-defined face, standing at an angle of  $70^{\circ}$ . The porphyry of the dike is often very much iron-stained in this ground, for which reason on the foot-wall it is sometimes almost impossible to distinguish between vein material and dike. On the hanging wall, however, there is generally a sort of clay selvage, with polished surfaces. The outline of the dike is very irregular, as shown by the fact that the hanging wall in this ground varies in angle from  $75^{\circ}$  to  $45^{\circ}$ , though the steeper dip is the prevailing one.

In the northern body the rich ore comes directly up to contact with the dike. It consists mainly of hard carbonate. Near the No. 4 shaft it is very thick, averaging about thirty feet, and in one part reaching 45 feet. It is practically continuous eastward to the No. 3<sup>1</sup> shaft, where it is again 30 feet thick, and beyond that into the Amie ground. To the northward, however, the rich ore bodies are very irregularly distributed in the ore horizon, and the ore horizon itself is apparently rather irregular. It has a general steep dip to the northward, and in the eastern part of the mine a tendency to dip also to the northwest. The boundaries between the rich ore bodies and the black iron or chert are very abrupt also, and often confounded with those of the formation. As the drifts were mostly run with no other system than to follow these rich ore bodies, it was very difficult, in the absence of any systematic mapping of the underground workings, to form a clear conception of the ore horizon and all its dips and strike.

As an instance of the confusion brought about in the minds of those working the mines by this want of system, it may be mentioned that a drift was run back southward from near No. 4 shaft into the porphyry dike for 30 feet, and then a raise was put up in search of the ore bed, which was abandoned, after being driven up 35 feet, on account of the danger of caving as they approached the Wash. The manner in which explorations were carried on from No. 5 shaft, to the north of No. 3, further illustrated this. The bottom of the shaft was in chert, which here forms the upper part of the ore horizon. A drift run north passed out of this chert in a

---

<sup>1</sup>The number of this shaft has been omitted on the map. It can readily be distinguished, however, by its position near the eastern boundary line and a short distance north of the dike.

distance of 10 feet, and was then continued 70 feet in the overlying porphyry, at every foot increasing its distance from the ore horizon. The main level from this shaft running northeast also passed out of the chert into the overlying porphyry, and at about forty feet from the shaft a winze was started to search for the ore below; this was, however, abandoned after going 15 feet, and an up-raise was started which was persistently continued in the overlying White Porphyry to a height of 70 feet, when the Wash was reached.

Under these circumstances it is difficult to say how thoroughly the ground to the north has been prospected or whether the failure to find ore bodies there is to be taken as a conclusive proof that none exists. Owing to the steep dip of the formation a level was soon reached by exploring drifts, at which the influx of water was too great to be handled by the pumping appliances in use, and exploration became expensive and was easily discouraged when rich bodies were not readily found.

No. 6 shaft was sunk to a depth of over two hundred feet, passing through 93 feet of Wash, 75 feet of White Porphyry, and 42 feet of vein material with a porphyry streak in the middle, into Parting Quartzite, and then into the lower sheet of White Porphyry. Drifts to the northwest from this shaft find small masses of dark crystalline limestone in the vein material, similar to that found near the Daly shaft, in Little Chief ground. The two northern shafts, No. 8, on Dives ground, and Winnemuck shaft No. 7, had not reached the ore horizons at the time of examination, but had passed through a sheet of Gray Porphyry above the White Porphyry. This is probably a part of the main sheet of Gray Porphyry corresponding to that in Little Stray Horse Park, which once covered the whole of Fryer Hill, but has since been removed by erosion.

Beyond the limits of the Little Pittsburgh claim the Four Per Cent. shaft reached the ore horizon at a depth of about one hundred and sixty-five feet, finding vein material, but, so far as known, no considerable bodies of ore.

**Amie mine.**—The Amie claim is very nearly parallel and next east to the Little Pittsburgh, and the rich northern ore body of the latter, as well as the porphyry dike, can be traced continuously from one into the other.

The porphyry dike is, as before, well defined on the hanging-wall side, having a clay selvage and some appearance of slickensides; its angle of dip is no longer as steep, averaging from  $45^{\circ}$  to  $50^{\circ}$ , and its thickness is also very variable, at one point being only 18 feet, at others thirty to forty feet, and in one case a drift was run in it 70 feet, and a raise was then made up to the Wash. It must be borne in mind, however, that the portion of the dike exposed by the few mine drifts which cut it is very small, relative to the whole mass, and that the variation in dip may, in many cases, only represent irregularities in the form of the body, and not variations in the dip of the mass as a whole.

The stringers of porphyry seen in the Little Pittsburgh ground have here enlarged into extensive sheets, which split up the ore horizon into three portions. The upper portion represents the greater part of the Blue Limestone body and furnishes the main supply of ore, the second and third ore bodies being simply irregularly-shaped portions, which were separated at the time of the injection of the porphyry, and have since been changed to vein material by the action of the ore currents. As these lower bodies have yielded but little pay ore, they have not been as thoroughly explored as the upper one, and their outlines, as given on Sections A and H, are more or less hypothetical.

The ore of the Amie mine is, as a rule, much richer than those already described. Even the iron vein material often averages ten to twelve ounces per ton in silver, in large masses, and, being comparatively free from silica, has been profitably employed as a flux by the smelters, in place of the Breece Iron ore which they had hitherto been using, and which was relatively much more expensive. The rich ore, mostly dark sand carbonates, generally occurs at the top of the ore horizon, immediately under the overlying porphyry, a clayey, iron oxide, with more or less manganiferous or black iron, forming the base of the horizon. Chert is much less widely developed than in the previously-described mines. A considerable amount of so-called "Chinese tale" is found throughout the rich ore bodies, doubtless the product of alteration of stringers of porphyry in the original limestone. South of the dike no considerable quantity of rich ore had been found at the time of examination, as the map shows; explorations had,

however, by no means covered all the possible ground in which it might occur, so that the statement, that the southern ore body previously observed does not extend as far east as this, rests on rather negative evidence. In only one point in the southern workings had a raise been made which found the Wash resting directly on the ore horizon. Elsewhere the covering of White Porphyry still remained. The actual width of the outcrop of the ore horizon in this ground is deduced from observations in the adjoining mines.

The workings of the Amie mine have been intelligently and systematically conducted from the very commencement, so that it has had advantages in the cost of extraction of ore over other mines, and has been able to mine even the low-grade iron at a profit. Two compartment shafts, No. 1 and No. 2, each provided with cages, were sunk entirely through the first, and at that time the only known, ore horizon, near the east and west limits of the claim, respectively. These were connected by a main level, provided with a tramway, from which cross-drifts underrun the main ore body, so that in mining the ore requires but one handling, falling directly from the stopes, through ore shoots, into the mine cars in which it is taken to the surface. Shafts No. 3 and No. 4 were sunk later, to explore the ground to the north and south of the main ore body, respectively.

The thickness of different rock formations passed through by these shafts will serve to show their irregularities and part of the data on which the sections have been constructed. They are as follows:

	Wash.	White Porphyry.	Iron vein material.	White Porphyry.	Iron vein material.	White Porphyry.	Iron vein material.	White Porphyry.	Silurian formation.
	<i>Feet.</i>	<i>Feet.</i>	<i>Feet.</i>	<i>Feet.</i>	<i>Feet.</i>	<i>Feet.</i>	<i>Feet.</i>	<i>Feet.</i>	<i>Feet.</i>
No. 1 shaft ....	75	55	16	20	4	20	.....	.....	.....
No. 2 shaft ....	75	25	10	70	15	20	4	40	77
No. 3 shaft ....	125	25	5	40	25	.....	.....	.....	.....
No. 4 shaft ....	50	25	25	12	3	12	3	60	.....

The main level, which has an elevation of 10,365 feet, is 150 feet and 160 feet below the collars of No. 1 and No. 2 shafts, respectively, the collars of these shafts being placed about ten feet above the ground to allow space for the dump. No. 2 shaft, it will be observed, has been sunk to a considerable depth in the Silurian formation, in which it has developed the

White Limestone, with its characteristic white chert segregations, but no ore. It was intended at time of visit to continue it still farther, as soon as a Cornish pump could be put in to control the great influx of water, which is almost invariably found when a certain depth is reached. Although there is no geological impossibility of the occurrence of ore in depth, the facts of observation are so unanimously adverse to its probability that this may be said to be a misdirected expense of labor and money, and one which, if devoted to the exploration of the Blue Limestone horizon in any of its various subdivisions, would be far more likely to yield practical results.

The main ore horizon north of the dike has a general dip to the northeast, although, as defined by its general contact with the underlying porphyry, it inclines locally to the northwest near the Climax boundary. The main dip of the formation is, however, to the north, and, as in the previously described mines, this dip steepens rapidly in the northern part of the claim, though the gentle dip continues some distance north of the main body. The first lower sheet of porphyry, as developed by the drift driven from No. 1 shaft to connect with No. 3, is remarkably full of chert fragments, most of which appear to have been simply caught up in the porphyry flow; some, on the other hand, are apparently segregations in the mass of the porphyry since its consolidation.

The principal ore body occurs along the north flank of the dike, in some cases being seen to wedge out between this and the overlying White Porphyry. It is very variable in thickness; thus at No. 2 shaft the whole horizon is only 10 feet thick; at 70 feet to the southward it has thickened to nearly 50 feet, of which the upper 30 feet are in pay ore, mostly rich sand carbonates. A similar large body of sand carbonate, 20 feet in thickness, was found above the main level east of No. 1 shaft, which was 45 feet in length. As already mentioned, most of these bodies are in the upper part of the ore horizon; rich ore also occurs irregularly in different parts of the horizon and also in the lower ore sheets, though the latter contain as a rule a smaller proportion of pay ore. Explorations to the northward, as far as conducted, find a large proportion of barren ground in the ore horizon, and, as elsewhere, the influx of water as the formation descends renders exploration difficult and expensive. Several small ore bodies have,



however, been opened by No. 3 shaft, which are sufficient to prove that ore does exist in this direction and to justify further exploration.<sup>1</sup>

*Climax mine.*—The Climax claim is parallel to and adjoins the Amie on the east. The structural conditions are, however, somewhat different in the two claims. The ore horizon is still split up into several parts, but, owing to the erosion of the crest of the anticlinal fold, which runs northeastward along the east boundary of the Climax claim, a much greater proportion of the ore horizon has been eroded off the area of the claim, and the outcrop of what remains runs northeastward nearly parallel to its side lines.

The mine has been worked only intermittently and without much system, and, as a considerable portion of the workings were inaccessible at the time of visit, information in regard to them could only be obtained by word of mouth, and leaves much to be desired in point of completeness and reliability. The general outlines of the structure were, however, sufficiently well determined by the examination of those workings which were accessible, and the uncertainty exists mainly with regard to details of ore distribution.

The mine workings consist of two disconnected groups, a southern and a northern, the former of which followed the eastern extension of the Amie body, the latter the western extension of the Dunkin body. Between these are the contract or leased workings, which, as their name implies, were worked by other parties under leases, of which no plats could be found, and about which little information could be obtained.

The southern workings are opened by shafts No. 3 and No. 5, shafts No. 4 and No. 6 having been sunk independently to explore the ground further south and not connected with these workings. Of No. 6 it is only known that it was sunk through 160 feet of Wash and reached a body of iron vein material in the top of the White Limestone. Shaft No. 4 cut two bodies of vein material, which are probably part of the lower ore horizon of the Amie mine, before reaching the White Limestone. It would seem probable that the drifts from this shaft might have cut the porphyry dike. Unfortunately at that time miners made no distinction between White and Gray Porphyry, and no definite information on that point could be obtained.

---

<sup>1</sup> Since the close of field-work a considerable body of rich ore is said to have been opened by the Deer Lodge shaft, which is situated near the Climax line, not far from the Virginus shaft.

The first level from No. 3 shaft, at 100 feet below the surface, starts in the White Porphyry below the upper ore horizon, which pitches at 20° to 25° towards the Amie line. Drifts were run to the north and west and to the southwest on this level; the former passes at 20 feet from the shaft into the upper ore horizon, whose lower portion consists of soft red silicious iron, passing into soft black iron or into chert; turning westward it reaches the continuation of the sand carbonate ore body of the Amie, from which considerable rich ore was taken. The southwest drift runs mostly in the underlying porphyry, in which are several thin streaks of ore and of Chinese talc. To the west of this drift, near the Amie line, are old stopes, from which a peculiar white sand ore, lying at the top of the ore horizon, was taken. This ore is said to resemble a decomposed porphyry so much that at first it was supposed to be worthless, but on examination was proved to be extremely rich, assaying as high as 1,600 ounces of silver and giving mill runs of 300 ounces, but containing little or no lead. It is probably the result of a leaching of the original ore body, during or subsequent to the process of erosion.

No. 5 shaft was sunk later and passed through 125 feet of Wash, 5 feet of iron, and 110 feet of White Porphyry, stopping in the Parting Quartzite and White Limestone, which here dip gently northward. A drift to the northwest, on the 383-foot level, from this shaft, and a western branch from this drift in the direction of No. 3 shaft find a small body of iron in the porphyry, which may correspond to the second ore horizon of the Amie mine. A drift to the northward, on the other hand, finds quartzite in the midst of the porphyry, which is supposed to be a detached portion of the Parting Quartzite, as shown in Section G.

The northern workings are opened by No. 1 and No. 2<sup>1</sup> shafts, and also connect with the northern Contract shaft. The workings from the latter have developed little of importance; the shaft was sunk through 85 feet of Wash and 30 feet of iron vein material. Drifts to the south and west rise to the overlying Wash at their extremities, but develop no ore bodies. To the north the workings follow some thin streaks of pay ore standing nearly vertically in the iron vein material.

---

<sup>1</sup>The number of this shaft has been omitted on the map; it lies near the Dunkin line, about one hundred feet southwest of No. 1.

Climax No. 2 shaft is 138 feet deep, of which the upper 90 feet are in Wash and the rest in the body of vein material, which is here separated into two parts by a sheet of very compact White Porphyry, as shown in Section E. This dividing porphyry, which is only 18 inches thick in the northwestern part of the workings, dips to northeast, increasing in thickness as it goes down, reaching four feet at the Dunkin line, and at Dunkin No. 2 shaft merging into the main lower body of White Porphyry. The principal ore body, which is found directly above this dividing porphyry, has a thickness of about 8 feet, increasing to 16 feet along the line of the Dunkin claim. The vein material here consists largely of highly mangiferous iron, with clay and chert generally at the base. The workings northeast of No. 2 have been carried up to the Wash, which here consists of sand and rounded pebbles, without meeting clay or the influx of water which are almost invariable accompaniments of the Wash. At Climax No. 1 shaft the ore horizon was found directly below 100 feet of Wash, in a single body 38 feet thick. This shaft was sunk to a depth of 220 feet, reaching some iron vein material in the bottom, which is supposed to be at the top of the Silurian formation, as in Climax No. 6. The lower north-and-south drift from No. 2 shaft, which is mainly run in the White Porphyry below the ore horizon, also cuts White Limestone at its southern end.

*Virginus mine.*—The extreme southern end of the Virginus claim overlaps the northern end of the Climax ground, and along the south line of the former two shafts have been sunk to the ore horizon and connected by drifts and winzes, the workings descending in steps towards the west. The main, or No. 2 shaft, was sunk through 136 feet of Wash, 40 feet of porphyry, and forty to fifty feet of vein material, passing at the bottom into dolomite and sand, which were dipping northwest. The vein material here was impure, containing much manganese, with clayey and sandy streaks. North of the shaft a cave was found near the top of the iron body, ten to fifteen feet in length and four to five feet in height.

Drifts and stopes connect with the No. 3 shaft, near which a small body of ore was taken out, which ran about forty ounces of silver to the ton. The main body of vein material in this part of the mine carries from two up to ten or fifteen ounces of silver to the ton. The east drift from this

shaft was cut through the bottom of the ore horizon into underlying White Porphyry. Explorations have not been carried far to the northward on this ground, owing to the steep dip and great influx of water. Probably the yield of the ore did not seem to justify the expense that would be necessarily incurred in putting up a pumping plant capable of handling the water.

On Section G the continuation of the ore horizon to the north has been represented as unreplaced limestone, simply because it has not been proved to contain vein material, though it is impossible to say whether it does or not until it has been actually explored.

*Dunkin mine.*—The Dunkin claim lies next east to that of the Climax. From it a large amount of rich ore has been obtained, and exclusively from the continuation of the northern shoot, observed in the Climax ground. The eastern continuation of the main ore shoot of Fryer Hill, which lies on the north flank of the porphyry dike, has, as the map shows, been entirely eroded off the Dunkin ground and the claims to the south of it. Whether the outcrop of the porphyry dike is entirely wanting between the Amie and the northeast corner of the Big Pittsburgh claim, as represented on the map, is not known, since there are no underground explorations in this area from which data may be obtained. It is most probably continuous in depth, but has not been indicated as outcropping, on the principle of representing as far as possible only what is actually known. The great breadth of outcrop of the ore horizon on the Dunkin ground is due to the fact that it lies along the crest of an eroded anticline. There is some evidence to show that in some part of the area covered by this outcrop patches of White Porphyry still remain between the vein material and the Wash, but it is not sufficiently definite to locate or outline these patches, and their existence does not invalidate the general truth of the structure, as given by the outlines on the map.

The Dunkin mine is opened by three shafts, No. 1, at the south end; No. 2, in the middle; and No. 3, at the north, as shown in Section D. Besides these is an old No. 1 shaft, which, being in an area of barren vein material, is no longer used. The main working shaft is No. 2, near the center of the claim, as well as of ore developments. From this three sets of levels are run, at 10,425, 10,405, and 10,357 feet elevation, respectively. The Wash was here 90 feet and the ore horizon 40 feet thick, the first level

starting about fifteen feet below the Wash and the second near the base of the ore horizon. The third level is in the Parting Quartzite at the shaft. No. 1 shaft was sunk through the underlying White Porphyry to the White Limestone, and is connected with No. 2 only on the second and third levels. Old No. 1 shaft found twenty to thirty feet of vein material above the porphyry. No. 3 shaft found the vein material directly beneath the Wash, and was sunk through it into Parting Quartzite and underlying porphyry. Only the third level connects directly with this shaft.

The most important ore body occurs between the first and second levels, extending southeastward from No. 2 shaft into the Matchless ground. It averaged from ten to sixteen feet in thickness and perhaps forty feet in width. Both ore body and ore horizon dip to the eastward on this side of the shaft, at an angle of about  $15^{\circ}$ . The drifts from the first level pass, to the southeast, rapidly into a body of black iron above the ore body and, to the southwest, into black iron and reddish silicious iron. At the end of a drift to the south a coarse sand is found at the top of the ore horizon, which in some cases is found to be impregnated with silver, and constitutes a rich ore. The west drifts in the second level, after passing through comparatively barren vein material, cut diagonally across the parting sheet of White Porphyry, which has already been noticed in the Climax ground, and reach the eastern end of the Climax ore body, immediately underlying this sheet of White Porphyry. The ore here consists of galena and sand carbonates.

In addition to the ore bodies above mentioned, later explorations have discovered numerous small bodies or patches of ore in the upper part of the ore horizon, immediately under the Wash. An interesting occurrence here was a mass of angular fragments of White Porphyry, cemented together by galena. The rich white sand noticed in the Climax ground was also found here in places. The galena in this mine is generally coarse grained, and sometimes exceptionally rich in silver; as elsewhere its tenor in silver is usually higher than that of the carbonates. A mill run of galena from the upper workings yielded 500 ounces of silver to the ton.

On the third level no pay ore has been found, but the developments are interesting from a structural point of view. It runs northeasterly through

the middle of the claim from the bottom of No. 1 shaft to 160 feet beyond the bottom of No. 3 shaft. At No. 1 shaft, and for 40 feet north of it, it runs in White Limestone, dipping  $20^{\circ}$  northeast, which is more or less stained, and occasionally replaced by clayey iron oxide. It then runs into decomposed and iron-stained porphyry, which is in places so laminated that it might be mistaken for a shale. The Parting Quartzite, which is disintegrated and contains thin layers of bluish shale, comes in at 160 feet from No. 1 and continues for 100 feet, lying nearly horizontal, and probably represents a minor roll in the formation, as shown in Section D. Beyond No. 2 shaft the quartzite gives way to compact White Porphyry, in which a cross-cut to the east shows the iron body resting on it and dipping eastward. At the bottom of No. 3 shaft the Parting Quartzite is again cut, here being above the White Porphyry and immediately under the iron body or ore horizon. The drift then runs for 80 feet through the iron body and suddenly passes into decomposed Blue Limestone, which, on the sides of the drift, has all the appearance of the solid unaltered rock, showing the stratification planes dipping northeast at  $40^{\circ}$ , the characteristic ribbings of white spar, and an occasional fossil resembling a *Euomphalus*, but which when taken into the hand immediately crumbles into fine lime-sand. A partial analysis of this lime-sand is given in Appendix B, Table VI, which shows it to have the normal proportions of lime and magnesia contained in the unaltered rock. Toward the end of the drift the dip shallows, probably because it is becoming more nearly parallel with the strike of the beds. At the very end the roof of the drift has caved, showing decomposed White Porphyry immediately above the limestone and Wash a little distance above that. This point, it will be observed, is almost opposite the workings of the Virginius claim. Beyond it the ore horizon has not been explored, nor is it likely to be until powerful pumping machinery is introduced capable of controlling the great influx of water.

**Matchless.**—The Matchless ground, which lies next east of the Dunkin claim, has been relatively little explored, probably because in early days it was considered unpromising ground, since the few prospecting shafts that were sunk did not strike rich ore. The indications afforded by the map, which show the condition of explorations at the time of this examination,

show, however, that both the Dunkin or northern ore body and the Lee body, which is the main ore shoot of the hill, extend into it, and may be reasonably expected to join together on this ground. Moreover, it has a large extent of unexplored ground in the northeastern part of the claim, which, though less promising than the southern part, is certainly worth prospecting.

The Discovery shaft and the Main shaft were sunk, the one to the south, the other to the north of the continuation of the Dunkin ore shoot. The Main shaft was sunk through 110 feet of Wash, 20 feet of White Porphyry, 15 feet of chert, 30 feet of iron, and through the underlying White Porphyry to the Silurian formation, which it reached at a depth of about two hundred and fifty feet. (See Section E.) In a drift on the top of the iron body, several small layers of lime-sand were found immediately under the overlying White Porphyry, which was itself much decomposed and full of segregations of iron oxide. The ore horizon, where cut by this shaft, contained little or no pay ore, but where the Dunkin ore body was found to extend to the Matchless line it was followed into the ground of the latter. Here it has a width of about forty feet and is from eight to sixteen feet in thickness. It extends in a northeasterly direction and descends rapidly to the eastward. The vein material is a cherty or silicious iron, and the pay ore a reddish clayey mass of sand carbonate, yielding much lead and silver. At the time of visit no connection had been made between this ore body and those to the east and south.

The Leonard or southern shaft was sunk to strike the continuation of the Lee body, which had been found to extend across the wedge-shaped portion of the Hibernia claim, between this and the Lee ground. It was sunk through 95 feet of Wash, 10 feet of ore, 15 feet of chert, and 12 feet of quartzite to the underlying White Porphyry. As far as at present explored, the rich ore body is confined to a narrow strip of ground along the Hibernia and Big Pittsburgh lines. It lies upon the Parting Quartzite, either directly or separated by a floor of chert, and therefore occupies the very lowest portion of the Blue Limestone horizon. In the northeast corner of the claim it abuts directly against the Gray Porphyry dike, which still dips to the northward at a steep angle. Although narrow, the ore body is

very thick, reaching 30 feet in places, and is extremely rich. This ore differs from any hitherto observed on Fryer Hill in that it is almost entirely free from lead. Its silver exists as fine particles and films of chloride or chloro-bromide, disseminated through an ochreous sandy mass, and sometimes coating the cracks and cleavage faces of the chert. Another difference between this ore body and those of the portion of the hill already described is the small amount of manganese found, and the condition of the iron oxide, which is here more generally anhydrous, whereas in other parts of the region it is always hydrated or in the form of limonite.

**Hibernia and Big Pittsburgh.**—These two claims will be described together, as the only portion of them yet found productive is the extreme northern edge, where the western continuation of the Lee ore body extends a short distance across their lines. The Gray Porphyry dike is here about thirty feet wide and very well defined, cutting across the Blue Limestone horizon into the underlying White Porphyry; and pay ore has thus far been confined mainly to its northern flanks, though, as will be shown later, there is good evidence for assuming that the continuation of the southern ore shoot, as developed in the ground to the westward already described, once existed here also, and that it should be sought for further east, where the ore horizon has not been removed by erosion.

The Hibernia shaft, which was sunk just south of the dike, passed through 100 feet of Wash into soft black iron, with chert at the base and a little pay ore, having a total thickness of about twenty-five feet. Drifts run northward from the shaft across the dike to connect with the stopes in the little triangular or wedge-shaped point of the claim beyond. These stopes were five sets of timber high, and the little triangular area was an almost solid mass of rich ore: near the top was a layer of chert extending from the Lee ground, which was there supposed to be the top of the ore body; it was here broken through and the ore found to extend up to the Wash. The quartzite floor dips northward into the Matchless ground. Southward from the shaft a prospecting drift runs over two hundred feet in the underlying White Porphyry, striking the Parting Quartzite at the end. A cross-cut to the eastward from this drift finds barren iron resting on the White Porphyry, and a winze sunk in the floor of the drift is said to have found White Limestone.



Westward from the shaft, a drift runs through White Porphyry, which connects with the McCormick shaft of the Big Pittsburgh, on the dividing line between the two claims. This shaft was sunk by Mr. Tingley S. Wood, superintendent, after explorations in the southern portion of the claim had proved fruitless, with the idea that a portion of the Matchless body might be found within the Pittsburgh lines. His expectations were realized, and a narrow strip of very rich ore was found north of the dike, and directly under the Wash, being, as the map shows, the extreme southern or lower edge of the Blue Limestone outcrop. From this shaft two cross-cuts were run northward across the porphyry dike toward the north line of the claim, and an up-raise made along that line disclosed the ore body above the White Porphyry or Parting Quartzite, as the case might be. Up-raises were also made in the porphyry dike, which showed that it extended up to the Wash, or, in other words, outcropped. Owing to a surveyor's error the line drift was run on the Matchless side of the boundary line; but, the error being discovered, the Matchless was reimbursed for the ore taken from its ground. What is known about the balance of the ground owned by the Big Pittsburgh Company will be given below in the description of the southern portion of the map.

Robert E. Lee. — This claim, in spite of its small area, has been among the greatest silver producers in the district. It has been owned by different individuals, and for various reasons it has not been possible to obtain very trustworthy figures with regard to the actual value of its product. The ore has been remarkable for its high tenor in silver and its freedom from lead. It is also very silicious and contains a relatively small percentage of iron, for which reason it is by itself not so well adapted for smelting as the average ore of the district, and a great deal of the low-grade ore from the mine has been reduced by amalgamation. The ore horizon is here directly overlaid by a body of Gray Porphyry, whose thickness could not be ascertained. It is evidently of limited extent, as it was not cut by the shafts of the adjoining claims. It may be an offshoot from the dike, or, as indicated on the map, simply a small intrusive sheet. In the western portion of the claim this porphyry-covering, together with the normal sheet of White Porphyry and the main Gray Porphyry sheet above that, has

been eroded off and the ore body extends up to the Wash. A thin quartzite, evidently belonging to the Weber formation, is often found directly above the ore horizon. The main ore body was almost perfectly continuous, varying in thickness from a few inches up to twenty-five feet, and generally overlaid as well as underlaid by dark-blue chert. At the time of visit a layer of ore was being followed which consisted of barite thoroughly impregnated with chloride of silver. The rich ore is sometimes a red sandy or clayey mass, and sometimes consists of chert or silicious iron, whose cracks and joints are lined with chloride of silver. The ore in general, as it comes from the mine, is characterized by its bright-red color, due to the presence of anhydrous iron and absence of manganese oxide.

The principal working shaft of the mine at time of visit was the No. 2, from which two levels were run; the old No. 1 or Ladder shaft was no longer used for the extraction of ore, and the new shaft to the northeast of these, designed to open the ore body on the dip, was not yet working.

The main thickness and the richest portion of the ore body lay to the south of shafts No. 1 and No. 2, between these and the dike. Directly south of No. 2 is a small irregular sheet of Gray Porphyry, cut in the lower level in a thickness of four to six feet, which seems to run partly with the stratification and partly across it. Too little of this body was exposed to afford sufficient data for determining its extent or origin, but it evidently acted favorably on the concentration of ore in its vicinity, probably by arresting the flow of the ore-bearing solutions and giving them time to precipitate the minerals they held in solution. The drifts in the western part of the mine had been extended south until they reached the porphyry dike, but, singularly enough, in the eastern part of the mine they stop before going so far south, it seeming to have been taken for granted that the dike would cut off the ore indefinitely in that direction; whereas there is every reason to believe that at no great distance to the eastward it will continue south over or across the line of the dike. It is hardly necessary to say that the outlines of the eastern end of the dike, as given on the map, are consequently founded only on general probability, there having been no exploration to determine its exact limits. The ore horizon in the Lee ground has a relatively steep dip to the northeast, which may be taken as averaging

about 25°. Explorations on the dip to the northeast and northwest find the ore more irregularly distributed throughout the horizon and not so concentrated as in the older workings; nevertheless they indicate an extension of ore deposition in that direction sufficient to justify more extended explorations. In the early days no maps were made of the underground workings, the services of surveyors being only called upon from time to time to determine points for the connection of drifts and for the location of shafts on the surface. Those given on the map for this mine are the result of rough surveys made by us in the course of our examination, checked by measurements kindly given by the surveyors who had at various times been employed in the mine. They represent only the principal drifts which were in use at the time of examination, the intermediate ground being largely occupied by stopes and drifts no longer used.

The later workings are systematically conducted from two main levels, the 320 and the 350 foot, the station of the former being 192 feet below the collar of No. 2 shaft. The No. 4 shaft of the Lee claim, on the south side of Little Stray Horse gulch, finds the iron body directly under the Wash. As yet little attention has been given to this portion of the claim, although it certainly deserves it, as from analogy with other parts of the hill it would seem as likely that rich ore bodies should exist under the lee of the dike here as there, and they might extend still farther eastward.

**Little Sliver.** — On this claim, which lies next east of the Lee, a commencement of exploration of the ore body has been made, and very promising ore deposits are being found. The Sliver shaft was sunk through about one hundred and twenty-five feet of Wash to Gray Porphyry, and found the usual thin bed of shales and sandstones at the contact of this with the White Porphyry, which were here more or less replaced by iron vein material.

The Tip Top shaft, still further eastward, a little beyond the limits of the map, found these shales, with a certain amount of carbonaceous material, at a depth of 245 feet. In them were some small pockets of galena and carbonate ore.

**Southeast corner of region mapped.** — A considerable area still remains in the southeast part of the region represented on the map, from which the ore

horizon has not yet been eroded. It has as yet been but little explored, partly because of its deep covering of Wash and of the great influx of water due to its position on the western rim of the Little Stray Horse Park basin, and partly because the possibilities of the existence here of valuable bodies of ore have not been generally understood. The only actual developments thus far made have been by the Surprise shaft, on the May Queen claim, and by the Denver City shaft, on the claim of the same name. The former found vein material directly beneath the Wash, at a depth of 140 feet, consisting largely of chert and black iron at the base, with soft, clayey, low-grade ore above. An incline was run, following the pitch of the ore shoot to the southwest, although the dip of the formation is here to the eastward, as was soon shown by the western drifts, which cut the Parting Quartzite beneath the ore horizon. Some good chloride ore was afterwards found by up-raises which reached a higher portion of the horizon.<sup>1</sup>

The Denver City shaft, in the extreme southeastern corner of the map, is nearly on the crest of the moraine ridge which borders Stray Horse gulch on the north. The Wash was here 180 feet deep, beneath which the main sheet of Gray Porphyry was found in a thickness of about twenty feet. Under this was a thickness of some twelve feet of calcareous sandstone and shale, containing some low-grade ore, which was at first supposed to represent the ore horizon, though it is in reality only the irregular parting of Weber Shales left between the Gray and the White Porphyry. The true ore horizon was afterwards struck at a depth of 234 feet, and rich pockets of chloride ore were found in it. It was passed through by the shaft for about fifty feet, ending in a bed of chert, with White Porphyry, so full of chert fragments as to be called by the miners a conglomerate, below it.<sup>2</sup>

There is no question that a part of the Blue Limestone is already opened by the works of this mine, but the shaft is located so near the imaginary southeast-and-northwest line, where the lower White Porphyry cuts across the Blue Limestone, separating it into two wedge-shaped portions, that there is a possibility that a portion of this horizon may yet be left

---

<sup>1</sup> Since the close of field-work, large and rich bodies of ore are said to have been opened in the Forest City ground, to the east of this claim.

<sup>2</sup> These data were obtained from Mr. Robert Bansen, superintendent of the Denver City mine, since the completion of field-work, and are not the result of our own observations.

below the cross-cutting White Porphyry, since the Parting Quartzite, which defines the base of the Blue Limestone horizon, has not yet been reached. As it is a question of considerable economical importance for owners of property in this vicinity to know whether a second ore horizon is likely to be found beneath the second White Porphyry body, the evidence on which it has been indicated on Section C as probably not occurring beneath the Denver City shaft will be given in some detail.

The Denver City shaft is situated in strike between the Lee mine on the north and the Agassiz on the south, as may be seen by reference to the larger map of Leadville and vicinity. In the former and in the Surprise workings the whole Blue Limestone horizon is above the second White Porphyry, as evidenced by the occurrence of the Parting Quartzite at its base. The Agassiz mine, on the other hand, is near the south point of the wedge of Blue Limestone, while the greater part of this formation must be below the second White Porphyry, forming a continuous sheet, except when crossed by later intrusions of Gray Porphyry, from the outcrop on the west face of Carbonate Hill. This lower portion of Blue Limestone or ore horizon, on the other hand, must wedge out to the north and east, as the upper one does to the south and west, and the question to be decided is whether it has wedged out before the line of the Denver City shaft is reached or not. It is proved on Stray Horse Ridge, to the west of the Denver City and below the lower White Porphyry, by the Moyamensing, Joe Bates, Vanderbilt, Pierson, and other shafts, and in the valley of Little Stray Horse gulch by the Stonewall Jackson shaft. With regard to the latter, it is only known that a body of vein material has been found beneath the Wash. In the Pittsburgh shaft next north of this, however, White Limestone is found directly beneath the lower White Porphyry, showing that the wedging-out occurs between these two shafts and approximately as indicated on the map. The extension of the line of wedging-out to the southeast, which is the general direction of the cross-cutting porphyry, would pass to the west of the Denver City shaft, but in all probability not very far from it, so that there is a probability that no second ore horizon occurs there. On the other hand, as the porphyry sheets are necessarily somewhat irregular in shape, it cannot be said to be impossible that a thin sheet

of vein material may be found, especially as the thickness already developed of about fifty feet is less than that found in many places, even where the entire thickness of the horizon has been replaced by vein material.

*Little Stray Horse gulch.*—There still remains to be described the region bordering this valley, from which the Blue Limestone or ore horizon has been removed by erosion. The data with regard to it were mainly derived from dumps of abandoned prospect shafts and from testimony of miners who had sunk the shafts, and are given by the outlines on the map, in addition to which there is not much to say. It will be understood that the relative accuracy of these outlines is dependent upon the proximity of these shafts, since there are absolutely no rock outcrops.

The Little Diamond shaft, on the Dolphin claim, just south of the end line of the Dunkin, found a considerable body of vein material beneath the Wash, which is the base of the ore horizon, where it has a local dip to the southward, as shown in Section D, the lower body of White Porphyry being exposed on the crest of this fold just east of it. The two May Queen shafts, near the base of the Denver City hill, find only White Porphyry. The Pittsburgh shaft, as already mentioned, passes through Wash and White Porphyry into White Limestone. The Little Daisy and Eudora shafts find White Limestone outcropping beneath the Wash. The new Gambetta shaft is in Gray Porphyry, supposed to be the cross-cutting sheet seen in New Discovery ground and on Carbonate Hill. This porphyry sheet was also cut at different horizons by the Eudora shaft, by the Vanderbilt on Stray Horse Ridge, by the Magnolia shaft in Stray Horse gulch, and, as already mentioned, by New Discovery shafts No. 5 and No. 6. The old Gambetta and Monarch shafts find the White Limestone directly beneath the White Porphyry, for which reason it is assumed that a portion of the Parting Quartzite has here been caught up by the porphyry and is somewhere in it at a higher horizon.

For the lower part of the valley direct data as to the outcrops are wanting. On the ridge south of it the Ida Nyce and Ypsilanti shafts have found the Blue Limestone beneath the Wash and a small amount of vein material in it. As well as could be determined, the formation has a slight easterly dip, as shown in Section C; but on the south side of

the ridge in the main Stray Horse gulch there is some indication of a westerly dip beyond a slight anticlinal fold. It is unfortunate that no more exact information could be obtained with regard to it at this locality, as upon the verification of the westerly dip depends in large degree the probability of the occurrence of the ore horizon under the city of Leadville. Its existence at the west end of Fryer Hill is, however, definitely ascertained, and has been shown to be extremely probable along the west base of Carbonate Hill, which lends force to the supposition that it also occurs at this intermediate point.

## RÉSUMÉ.

From the above descriptions it is apparent that, in spite of the greater complications of structure, the series of rock formations on this hill is essentially the same as that on Carbonate and Iron Hills, and that the processes of ore deposition have been essentially the same, though the secondary alteration of the deposits, which may be mainly ascribed to the action of surface waters, has been carried much farther. The Cambrian, Silurian, and Lower Carboniferous horizons are found in their normal positions, the Parting Quartzite being here, as elsewhere, of somewhat variable thickness, and the Blue Limestone horizon, which is often split up into several portions and entirely replaced by vein material, being then defined by this quartzite below and by the micaceous sandstone or quartzite of the Weber Shales above.

The intrusions of porphyry are more extensive and more varied and irregular in form. Above the normal sheet of White Porphyry, which here as there overlies the ore horizon, with detached portions of the Weber Shales left between, is the main sheet of Gray Porphyry, in great measure eroded off, which does not occur on the other hills. In addition to this, there is the second or lower sheet of White Porphyry, occurring generally at the base of the Blue Limestone horizon, but in some places cutting up across its lower portion and in others cutting down below the Parting Quartzite; further, there are ramifying offshoots from this lower White Porphyry, which have locally divided the Blue Limestone horizon into several different portions. Of later Gray Porphyry intrusions, there is the larger

sheet, which, as on the other hills, is generally near the base of the Blue Limestone, but which does not conform strictly with the stratification planes, crossing them at low angles, and extending in geological horizon from the upper part of the White Limestone well up into the Blue Limestone, across the intermediate lower White Porphyry. Besides this are several smaller bodies of Gray Porphyry not found in the other hills, the most important of which seems to have the form of a transverse dike.

Of great faults like those on Carbonate and Iron Hills, there is no evidence, the force of compression having only produced gentle folds and some slight displacements of a few feet in extent, which are shown by sudden changes of level in the ore horizon; such a one has evidently occurred along the line of the north flank of the porphyry dike, which has slickensides surfaces, and shows in some cases a slight difference of level in the ore horizon on either side.

The process of ore deposition has been evidently the same metasomatic change or replacement of the limestone by ore and vein material, only it has been carried so much farther that, instead of a body of limestone with a little vein material extending irregularly from its surface downwards, there is found here only a mass of vein material with occasional irregularly-shaped residuary masses of unreplaced limestone or lime sand. Owing to the irregular distribution of the intrusive masses of porphyry, whose contact planes afforded channels by which the ore-bearing currents reached the limestone, the evidence is naturally less striking that these currents followed in general a downward course. Still it must be borne in mind that the greater mass of the present bodies of vein material are the result of secondary alteration by surface waters, and that this alteration having been much greater here, it is proportionately more difficult to trace the probable form or position of the original sulphuret deposit. In spite of this it may be observed that in the majority of cases the rich ore, which is presumably nearer its original position than the iron oxides, is found near the upper part of ore horizon. On the other hand, if the ore came directly from below, according to the idea which is generally advanced with regard to the source of ore deposits, the only channel which it could have followed would have been the walls of the porphyry dike. In this case we should expect to



find evidences of the passage of the ore currents along these walls; but wherever they have been examined these evidences are conspicuously wanting. On the south flank the dike is generally separated from the ore body by a barren zone, containing often, it is true, iron vein material, but evidently of secondary origin. On the north flank the ore body extends up to the dike, but it is strictly confined to the ore horizon; and does not extend below that, the most that is found being a slight staining by iron oxides, readily accounted for by the percolation of surface waters descending through the ore horizon and carrying down some of its material with it. It is unfortunate that a more conclusive test could not be afforded by the cutting of the dike at a considerable depth below the ore horizon, but as this has not been done, we must reason from the evidence that is at hand.

The apparently abnormal variation in the thickness of the ore horizon is less readily accounted for, as has already been stated on page 446; but it must be borne in mind that the data from which the outlines of formations have been reconstructed are very limited and irregularly distributed, being derived from drifts run for the sole object of following known ore bodies and without any purpose of elucidating the structural conditions of the various strata.

The singular absence of lead in the Lee ore body is another exceptional feature of this region. It seems hardly probable that, in a district whose silver is so universally derived from argentiferous galena or its decomposition products, in this little spot alone silver should have been deposited by itself. The more natural explanation would seem to be, that the deposit is entirely secondary, and the result of the leaching of a larger body, now eroded off, by surface waters, which carried away the lead and left the silver. The geological position of the ore body favors this idea; it rests immediately on the Parting Quartzite, and therefore at the very base of the ore horizon; it is on the lower rim of a synclinal basin, which is known to carry an immense amount of water that would naturally drain out over its edges. It may be also that the absence of manganese would tend to the formation of the more soluble sulphate of lead, rather than the carbonate, which is generally found as the alteration product of galena in this district.

The influence of cross-cutting sheets of porphyry in producing a concentration of rich ore by causing a stagnation of the ore currents is shown by the distribution of the ore shoots. Thus the northeastern body in the Climax, Dunkin, and Matchless ground lies under the lee of the cross-cutting sheet of White Porphyry; the main ore shoot in the Amie, Pittsburgh, Little Chief, and Chrysolite lies in a similar position relatively to the Gray Porphyry dike; and the southern body in the last three claims lies just north of the lower cross-cutting sheet of Gray Porphyry.

The greater secondary alteration on this hill is readily accounted for by the fact that it is everywhere covered by a great thickness of Wash. This Wash, which is a loosely aggregated and permeable boulder clay, acts like a wet sponge. It is constantly full of water at its contact with the rock surface on which it rests, which water is doubtless charged with air and decomposed vegetable matter, and thus acts more vigorously upon the rocks than would water flowing freely over the actual surface of the ground or that which percolates in minute channels through the solid rocks beneath the surface. This is shown by the fact that the upper sheet of White Porphyry, which lies immediately beneath the Wash, is generally reduced to a plastic mass, in which all trace of the original structure of the rocks is lost, while the lower sheet of the same rock is still a hard, compact rock, forming what the miners call block porphyry.

## CHAPTER V.

### OTHER GROUPS OF MINES.

#### MINES AND PROSPECTS IN THE LEADVILLE REGION.

It is from the mines included in the three groups already described that what may be considered the permanent ore supply of Leadville has been thus far derived, and it is in these mines alone that exploitation has been carried on so continuously and extensively as to afford an opportunity to study in detail the character and the form of the different ore bodies and their relations to the inclosing and neighboring rocks. For this reason they have been described with a detail that may, in the future, seem disproportionate to their relative importance, especially when, as is likely to be the case at no far distant day, the deposits of these limited areas shall have become nearly exhausted and the main supply is derived from what may now be considered outside areas. From the evidence obtained during this study it is fair to assume that a greater amount of as yet undiscovered ore exists outside these areas than has already been developed in the small groups already described, and that, while its exploitation will necessarily be more difficult, owing to greater depth and large influx of water, and its reduction will require more complicated processes, owing to a greater preponderance of sulphurets, these disadvantages will be offset by greater advantages of working, brought about by a more thorough knowledge of the geological relations of the ore deposits and by improvements introduced into the various processes of reduction.

With but few exceptions these outside mines have been hitherto but intermittently worked, and, owing to some minor differences in the character

of their deposits or of their inclosing rocks, their geological structure has been more imperfectly understood by those in charge, and the work of exploration been carried on with less system and sometimes in an utterly aimless manner. Although it has been impracticable for these reasons to determine with the same accuracy and detail the relations of the ore bodies in these outside mines as has been done for those of Iron, Fryer, and Carbonate Hills, an explanation of their general geological structure will be of value as a guide for future exploitation, and a consideration of the relative amount of replacement action in different portions of the Leadville region, as shown by the developments thus far made in them, will afford a basis for determining the probable extent and direction of the original ore currents, and in consequence what part of the ore horizon, which the geological outlines have already located, is most likely to contain valuable ore bodies.

An examination of the relative distribution of vein material shown by the outcrops, as delineated in cross-lining on the Leadville map, shows two lines or zones along which the evidence of replacement action is most apparent, one running east from Fryer Hill to Little Ellen Hill, the second taking more of a southeasterly course from the southern end of Carbonate Hill to Long and Derry Hill. In the area between these two zones the surface is formed by porphyry bodies which overlie the ore horizon, so that no outcrops of vein material show on the map, except a few thin lines along the edges of fault planes. Under these porphyry bodies in Carbonate and Iron Hills a very large proportion of the area is already proved to be occupied by valuable ore bodies, and it may, therefore, be reasonably expected that similar bodies exist under the porphyry sheets between these zones farther east, although, owing to the greater depth of the ore horizon, they have not yet been reached by mine workings. There is evidence of still another zone of replacement extending north from Fryer Hill under Prospect Mountain, but, as the ore horizon has been reached in few points and the vein material has, at these few points, proved comparatively poor, the chances of finding any considerable development of rich ore in that direction have necessarily a smaller basis of probability than to the eastward, though the general geological conditions favor it.

In the description which follows, the mines will be grouped according to the main features of geological structure already outlined in Part I, Chapter V.

## LITTLE STRAY HORSE SYNCLINE.

As shown in the previous chapter, the eastern portion of the area represented on the Fryer Hill map belongs structurally to the western rim of the Little Stray Horse basin, and the ore horizons of the Little Sliver, Forest City, and Denver City mines, if followed continuously eastward, would finally reach the bottom of the basin. The basin is bowl-shaped, its outlines being shown on the map by those of the Gray and White Porphyry bodies which fill its depression.

**Southern rim.**—Through its southern rim runs the zone of cross-cutting White Porphyry, in virtue of which the Blue Limestone along the southern and western rim is supposed to be split into two wedge-shaped sheets. Of these the lower one, which thickens to the south and constitutes the entire thickness of the horizon in the mines of Iron and Carbonate Hills, is buried under the whole overlying White Porphyry under the northern end of Graham Park, and its depth or condition of mineralization is not known. The points nearest to the axis of the basin at which it has been reached are in the Highland Mary (P-52), in Stray Horse gulch on the east, and in the Wolfstone (T-5) on the west.

The upper portion, which wedges out to the south, outcrops under the Wash as indicated on the map, commencing to thin out near the southern edge of the area of the Fryer Hill map, and reaching its thinnest point at the Mahala (T-2). It is proved in the following shafts: The Moyamensing (S-12) strikes iron vein material, which probably forms the outcrop of the Denver City ore body, below the Wash at 115 feet. In the Robert Emmet mine, in Stray Horse gulch, this portion of the Blue Limestone is represented by 50 feet of manganiferous iron, with White Porphyry above and below, the overlying porphyry showing traces of original pyrites which have been dissolved out. The main shaft reached the contact at 110 feet, finding a dip of 30° N. E. and being sunk afterwards 150 feet in underlying porphyry. The ore thus far extracted has been taken between this shaft and

the outcrop, which crosses Stray Horse gulch just below the tunnel (S-3). Farther south the Agassiz (T-3) finds the vein material and limestone 30 feet thick, at a depth of 45 feet, the Goneabroad (T-4) finds it at 80 feet, and the Cyclops (T-1), farther east, finds it at 148 feet below rock surface, with a thickness of 50 feet, and passes through it into underlying porphyry. In the Agassiz, as in the Robert Emmet, the vein material is manganiferous iron, with carbonate ore at its upper surface, sometimes five or six feet thick; about five feet of quartzite are found above the contact, as in Carbonate Hill. The dip is about  $30^{\circ}$  N. E. The Greenback shaft (O-53) found Lake beds, the northern continuation of the Graham Park area (see Atlas Sheet VI), beneath the Wash. The ore horizon consisted of 3 feet of iron and chert, 45 feet of limestone, and again 7 feet of iron. White Porphyry was penetrated 40 feet below this.

**Southeastern rim.**—On the eastern rim of the southern end of the basin the outcrops of the Blue Limestone are less continuously proved. The Indiana (P-53) finds limestone directly beneath the Wash, while the Highland Mary (P-52) reaches the lower body of Blue Limestone after passing through 122 feet of White Porphyry. The Rarus (P-61) passes through the edge of the Gray Porphyry sheet directly into limestone, showing that here the upper White Porphyry is wanting. It comes in again, however, in the Hunkidori (P-72) shaft, a little east, which penetrated it for 40 feet, after passing through 170 feet of Gray Porphyry and 5 feet of Weber Shales.

**Western rim.**—Along the western rim a number of shafts have been sunk in Gray Porphyry, in search of the continuation on the dip of the Lee and May Queen ore body, without having yet reached it, the influx of water making it difficult to sink their shafts. Some had penetrated the White Porphyry a short distance, and these had always found a portion of the Weber Shale, either as quartzite or as black carbonaceous shale impregnated with pyrites, at the contact of the two porphyries. All had found Wash from ninety to two hundred feet deep. In the Little Sliver (P-81) the White Porphyry was 41 feet thick; the Shamus O'Brien (P-73) had penetrated it 30 feet; the Tip Top (P-75), 38 feet; the Union Emma (P-79), 25 feet; and the Bangkok (P-77), 52 feet; while the Cora Bell (P-78), Forepaugh (P-76), Prince of Orleans (P-71), and Olive Branch (P-70) were still in the Gray

Porphyry and the Lickscumdidrix (P-68) bore-hole, in the middle of the basin, has gone through 400 feet without reaching its base.

Eastern rim.—East of the above shafts the El Paso (P-65) and Little Miami (P-58), at depths of 470 feet and 390 feet, respectively, were still in White Porphyry, after having passed through Gray Porphyry, and through varying thicknesses of Weber Shales both at the contact of the two porphyries and within the lower body. The Kennebec (P-55), Cullen (P-57), and Aztec (P-54) have reached the limestone after passing through the two porphyries, the former finding a second sheet of White Porphyry within the limestone. The same sheet is found in the Cordelia Edmondson (P-41), which is sunk in a large body of vein material, directly below the Wash. Several other shafts have struck the very considerable body of vein material which replaces the Blue Limestone on this rim of the basin, but as yet no important ore bodies have been found.

The most extensive workings are in the Chieftain and Scooper mines. The former is opened by a tunnel (P-43), which runs southeast through vein material, and then through limestone, compressed into gentle folds but apparently with a slight dip west, and, at a distance of 360 feet from the mouth, strikes granite which forms the foot-wall of the Iron fault. A decomposed porphyry, resembling White Porphyry, is found adjoining the fault. The limestone near the end of the tunnel is quite light colored; it may be the White Limestone, but the structure was not sufficiently shown to make this certain. The Scooper (P-44) shaft was sunk through 60 feet of Wash, 20 feet of Gray Porphyry, and 5 feet of White Porphyry, to iron and limestone. The contact with the porphyry is here very steep and runs in a direction a little east of south, being cut by several drifts; it was supposed to be the line of a fault. It is probably, however, simply an unusual steepening of the dip on this edge of the basin, as the Indiana (P-64) shaft, about 400 feet west of it, was still in Gray Porphyry at a depth of 330 feet. The limestone and vein material are crushed and folded even more than in the Chieftain, and probably from the same cause, viz, compression against the Iron fault. Considerable very silicious, hard carbonate ore, rich in chloride of silver, has been taken from this mine, but for some unexplained reason the developments have been very irregular and without system.

This basin has been described somewhat in detail to show how much fruitless labor has been expended in a region whose surroundings would lead one to suppose that it contains fine bodies of ore. Although so many shafts have been sunk to depths of 200 to 500 feet, the contact has been seldom reached, and even then but little explored. The main difficulty has been the great amount of water met in depth, which could not be controlled by the pumping apparatus in ordinary use. That such a basin should hold a large amount of water, especially when its outcrops are crossed by two such stream beds as those of Big Evans and Stray Horse gulches, is most natural, and it will probably be impracticable for any one mine to work in it alone. Work must be carried on by combination either of actual properties or else of working expenses, and powerful pumping apparatus must be established to drain the whole basin from its deepest point.

#### YANKEE HILL ANTICLINE.

On the western slope of Yankee Hill the J. B. Grant shaft found about eight feet of vein material between White Porphyry and White Limestone, which is only significant as showing that replacement action has gone on to a certain extent beneath the lower sheet of White Porphyry.

On the eastern side of Yankee Hill a large body of iron vein material has been found, extending from the Clara Dell and Little Champion northward through the Bevis and Boulder Nest mines, and thence eastward to the Andy Johnson, which reached it after passing through 200 feet of Gray and White Porphyries. This body consists of iron oxides and chert and is undoubtedly much more extensive than has been represented on the map; it contains some ore, but the data obtained with regard to it were too meager to do more than prove the same probability of the existence of valuable ore bodies in the synclinal basin to the eastward that exists in regard to Stray Horse Park. The Superior (K-61) and Mountain Boy (K-60) shafts struck a considerable body of limonite and chert on the southwestern edge of this basin, dipping at an angle of about  $30^{\circ}$  to the northeast. This body, which is some fifty feet thick, is supposed to be the replacement of a split-off portion of the Blue Limestone. This supposition accounts for the apparent want in the thickness of this horizon to the west on a line drawn through the Leavenworth shaft, as shown on the map



and explained in Part I, Chapter V. On the other hand, it is the Weber Shales that are ordinarily found between the Gray and White Porphyry sheets, and in the Theresa (K-57) shaft, a short distance to the northeast, highly pyritiferous shales were found in this horizon at a depth of 325 feet.

**Breece Iron mine.**—In a similar position occurs the deposit of the Breece Iron mine, situated on a spur of Breece Hill, overlooking Adelaide Park. This remarkable deposit of iron ore is found at the surface in two distinct bodies, shown in open cuts, the one a short distance above the other. The lower body has a maximum thickness of 20 to 25 feet and rests on White Porphyry, with a mottled porphyry on the hanging wall. The upper body is not so thick and is overlaid by the main sheet of Gray Porphyry; both dip eastward, and the shaft (K-39) higher up the hill has been sunk through 30 feet of iron without reaching the bottom of the body, from which it may be supposed that the two bodies have here come together. The Gray Porphyry has either the characteristic large crystals of orthoclase or the cavities which they once filled. The intermediate porphyry is, however, of finer grain, of a pinkish color, and is full of minute cavities having the form of crystals of pyrite. This may possibly represent a tongue of Pyritiferous Porphyry extending between the two iron bodies. The lower (K-36) shaft has been sunk 350 feet in the underlying White Porphyry, which, near the iron body, is also impregnated with pyrite. The iron bodies are rather irregular in shape and send offshoots or stringers into the surrounding rocks. The ore is, however, massive and compact and remarkably free from earthy gangue. It has been largely used as a flux in the smelting works, being supposed to carry several ounces of silver to the ton, and has also been used by the Colorado Coal and Iron Company in the manufacture of Bessemer steel. It is a very pure hematite, with a certain admixture of magnetite which seems to occur mainly near the outcrop. It carries about 66 per cent. of metallic iron. The complete analysis of an average specimen, by Mr. Guyard, will be found in Appendix C. Undecomposed pyrites are found in the ore from the upper shaft. It seems probable that this body, like the iron bodies in the various silver mines, is the result of the oxidation of pyrites, which were concentrated at the junction of the three bodies of porphyry. It differs in being anhydrous, while all the others are

hydrated; also, in the fact that it occurs high up on the hill and free from the ordinary covering of Wash, which, no doubt, promotes decomposition and the chemical combination of water in rocks that underlie it. From the staining of rocks eastward, along the outcrop of the contact, and from data obtained from shafts sunk higher up on the hill, it appears that an iron body extends, though not continuously, for some distance to the eastward

#### SYNCLINE EAST OF YANKEE HILL.

The geological structure of the area between Yankee Hill and Weston fault has been already explained in Part I, Chapter V, and is graphically shown in Sections C, D, and L. As yet no considerable ore bodies have been found at the ore horizon in this area; but it seems not to have received the attention it deserves, in view of the good indications afforded by the explorations already made. These may be briefly enumerated as follows:

The amount of vein material proved on its western rim has been mentioned above. On the south side, the Little Prince (K-32) shaft passed through 150 feet of Gray Porphyry and 80 feet of White Porphyry to the Blue Limestone horizon, which is here about one hundred and twenty feet thick and entirely replaced by a porous silicious material, not unlike the granular quartz gangue of the Morning Star mine. At first glance it somewhat resembles a decomposed porphyry, and in it small irregular bodies of sand carbonate, but no limestone, have been found. The Parting Quartzite was found below it. On the lower slopes of the hill the Nora (K-23), Bosco (K-28), Across the Ocean (K-31), and Great Hope (K-30) shafts were sunk through Gray Porphyry to the ore horizon, the first two without finding any intervening White Porphyry. In all more or less vein material was found replacing the limestone. The Onota, from which the typical Gray Porphyry was taken for analysis, also reached limestone near the middle of the basin. In the Great Hope quartzite was reached after passing through 60 feet of vein material. In the iron vein material some large layers of lime-sand were found, and at 105 feet from the surface a streak of galena five to six feet thick is said to have been passed through, but the main ore of the mine was taken from the quartzite, which, as well as the lower portion of the iron body, was impregnated with gold. The gold was very

coarse. Some four hundred to five hundred tons of quartzite gold ore, averaging one and a half ounces of gold and four ounces of silver to the ton, are said to have been taken from the mine, and one lot of 3,000 pounds is said to have yielded thirty-one ounces of gold to the ton. A dike of White Porphyry, cut in the eastern portion of the workings, may have influenced the concentration of ore at this point. The quartzite is probably Parting Quartzite, though the thickness of 60 feet given for the Blue Limestone horizon seems small, especially as it is said to have been over ninety-six feet thick in the adjoining Across the Ocean shaft. The vein material on the dump of the latter contained a great many quartz-lined cavities, and it is possible that what was taken for quartzite in the Great Hope was simply granular silicious gangue like that in the Little Prince.

## SOUTH EVANS ANTICLINE.

Highland Chief mine.—The vicinity of the South Evans anticline has evidently been a favorable locality for ore deposition, but the development of the ore bodies has been retarded by the difficulty of understanding the geological structure and the relative positions at which they occur. The Highland Chief mine has been the most important ore producer of this portion of the district. It is opened by a shaft on the brow of the hill overlooking South Evans gulch and by a tunnel run in to meet it part way down the slope. Fig. 2 represents an ideal section on a broken line drawn through the Highland Chief shaft (L-1), the tunnel (G-54), and the Eliza shaft (G-58).

FIG. 2.

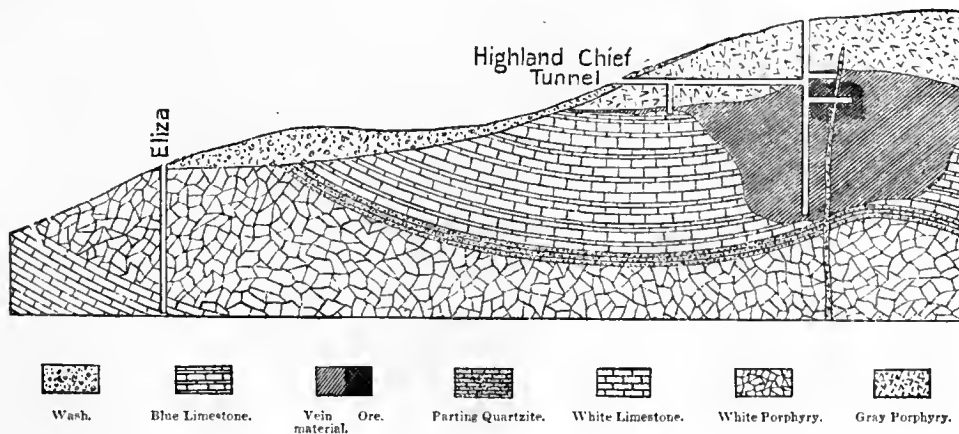

Both tunnel and shaft are driven through Gray Porphyry to the contact, the upper White Porphyry being here wanting. No limestone is struck in either, but a winze sunk a short distance from the mouth of the shaft found it, as did the Highland Mary (G-55) and Curran (G-56) shafts close by, which found some vein material, but no ore. Vein material rises rapidly in the floor of the tunnel as it approaches the shaft, and the latter is sunk in it 170 feet below the tunnel level. The lower surface of the porphyry sheet has a dip to the northeast, which is also seen in the eastern portion of the workings beyond the line of the section, while in the southwest workings there is a dip westward. In the Chemung (K-5) tunnel, which is driven 400 feet, along the contact of Gray and White Porphyries and then in Blue Limestone, in a southeasterly direction, from a point just below the road about seven hundred feet southwest of the mouth of the Highland Chief tunnel, the limestone at the end is found to be dipping westward. It thus appears that there is a slight ridge or lateral fold in the formation, which is shown on the map by the curve in the strike of the formations. The section, whose line is taken along the crest of this fold, shows at right angles to it a more pronounced folding, forming an anticlinal and synclinal structure parallel to the South Evans anticline, which is necessitated by the intersections of formation lines obtained in the Highland Chief and Eliza (G-58) shafts. The intermediate outcrops are obscured by the moraine material or Wash, left on the shoulder of the hill by the South Evans glacier. The section shows the rounded outlines of rock surface left under the Wash by this glacier and the abrupt slope below the Eliza shaft produced by later erosion. A dike of Gray Porphyry, running northeast and southwest, is cut in the south drifts from the second level of the Highland Chief mine, but does not seem to be continuous, as it is wanting in the southwest workings on the tunnel level. It has evidently the same irregular character that has been seen in similar transverse bodies on Carbonate and Iron Hills, and, like them, has evidently had a favorable influence on the concentration of ore. The vein material of this mine is very silicious and resembles the porous hard carbonate described in Carbonate Hill, but carries less iron; the cavities contain cerussite and chloride of silver. The ore is relatively rich, many lots averaging

from one hundred to two hundred ounces of silver to the ton, but it is generally low in lead, and therefore difficult to smelt. It frequently contains copper in the state of carbonate or silicate, which gives it a green color, associated with hydrous phosphates of alumina. As far as could be seen it is much more irregularly distributed throughout the vein material than in the carbonate mines generally. Copper ore similar to that of the Highland Chief is found in the Little Johnny (F-29) and Rattling Jack (F-28). The upper White Porphyry comes in again at these shafts, the intermediate ones, like the Uncle Sam (F-32 and F-33), having found vein material directly beneath the Gray Porphyry. From the thickness of lower White Porphyry shown in the Eliza shaft, it may be assumed that on the line of this section the entire mass of White Porphyry has gone below the Blue Limestone horizon.

**Colorado Prince group.**—The lower formations, which form a cliff face overlooking South Evans gulch between the Highland Chief mine and the Colorado Prince fault, have been exposed by numerous mine workings. These have been exploited in such an irregular and intermittent manner that it has been impossible to obtain satisfactory data as to the amount or quality of ore extracted from them. The geological structure shown by the various shafts and tunnels that were examined is, however, interesting, showing the rising of the beds over the South Evans anticline and the slight displacement caused by the Colorado Prince fault. Just above the Colorado Prince tunnel there is an actual rock outcrop of White Porphyry and overlying Lower Quartzite, forming a steep cliff; but, on the shoulder above, the rock surface is deeply buried under the Wash, a relic of the lateral moraine of the South Evans glacier. The following diagram shows an ideal section, drawn through the Colorado Prince tunnel (G-43) and shaft (G-47), and the shafts of the Miner Boy, No. 3 (G-48), No. 1 (G-50), and No. 2 (G-51). The Miner Boy or Kentucky tunnel (G-42), which is a little beyond the line of the section, is indicated in dotted lines.

FIG. 3.

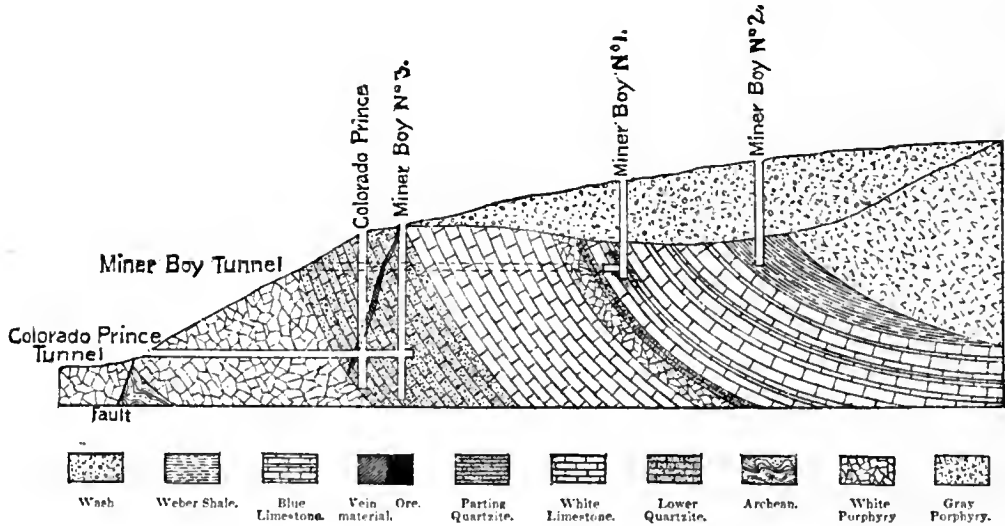

The most important mine of this group is the Colorado Prince, which has its own stamp mill for crushing and amalgamating its ore. According to the reports of experts who have examined it, it has a very large body of rich ore, but the practical results of work do not thus far seem to have justified their prognostications. The management of the mill has been so frequently changed that it was impossible to learn the actual working results of treatment over a long enough period to determine whether the apparent want of success was due to the quality of the ore itself or to faulty methods of reduction.

The deposit of the Colorado Prince and Miner Boy mines is somewhat in the nature of a gash vein in the Lower Quartzite. It stands at an average pitch of  $75^{\circ}$  to the east, varying between  $60^{\circ}$  and the vertical. Its strike is about N.  $15^{\circ}$  W. It varies in width from a few inches to five or six feet, and in the upper workings is said to have been stoped out on a width of 20 feet. It has no distinct walls or clay selvages, and the matrix of the ore is principally decomposed quartzite, more or less stained by iron oxides. Near the Miner Boy No. 3 shaft it splits into two branches, one following its general direction, the other being more nearly north and south. Following the vein is a thickness of one to three feet of light-colored decomposed rock, called by the miners trachyte and considered by one

expert to be a propylite dike. It is, however, only a fine grained conglomerate of rounded pebbles of quartz in a clay matrix. So far as explored, the vein is confined to the horizon of the Lower Quartzite, the upper 20 feet of which are calcareous. It may have extended up into the White Limestone, but it has not yet been followed into the White Porphyry below and shows a tendency to pinch in that direction. The ore is essentially a free-gold ore and is generally stained by oxide of iron and carbonate of copper. Galena occurs sparingly, having been only observed in a few spots. Carbonate of lead is said to have been found. The first and second class ores are generally sent to the smelting works at Argo, only the third class going to the stamp mill.

The vein seems to be the result of the action of percolating waters along a fracture plane in the formation, which was very probably formed at the time of the displacement of the Colorado Prince fault, with which it has a general parallelism. The ore is probably the result of the oxidation of pyrites, and whether it was originally concentrated in this form in its present position or brought in as a secondary deposition from the surrounding rocks it is difficult to say definitely.

The general dip of the formations in these workings is steeply to the south, sometimes varying a little to the west and again to the eastward. Its observed angle also varies from  $35^{\circ}$  to  $60^{\circ}$  in the Colorado Prince workings, the steeper dip occurring near the Miner Boy shaft. The intersections obtained in the Colorado Prince tunnel are shown on the section. The Kentucky or Miner Boy tunnel was run for the following distances through the successive formations: Lower Quartzite, 200 feet; White Limestone, 200 feet; White Porphyry, 40 feet; Parting Quartzite, 35 feet; Blue Limestone, 50 feet to the bottom of shaft No. 1. These figures, it must be remembered, are not actual thicknesses of the formations. The lower part of the Blue Limestone as exposed in Miner Boy No. 1 shaft is thoroughly impregnated with oxide of iron and is said to have yielded some very good assays. The No. 2 shaft of the Miner Boy found black shales of the Weber Shale formation directly beneath the Wash.

## LITTLE ELLEN HILL.

On Little Ellen Hill the Blue Limestone has been found to be replaced to a considerable extent and some argentiferous lead ore has been obtained from it; but present explorations cover only a small proportion of its area. The principal mines are the Virginus and Little Ellen. The Virginus (G-24) is opened by a tunnel run southwards along the strike of the formation from the north side of the hill, facing Big Evans gulch. The limestone is largely disintegrated and in the condition of lime-sand. The vein material, as usual an impure iron oxide, is very silicious. Galena is thickly scattered through it, but the ore is of rather low grade in silver. The tunnel is 250 feet long, and drifts from it have been driven eastward 150 feet on the dip. On the hill above, in the Cleveland (G-27), 15 feet of vein material, carrying galena, are found above the limestone, and at a depth of 30 feet in the limestone a cross-cutting body of Gray Porphyry, which is also cut in the Last Chance (G-31) shaft, immediately below the Wash. The other shaft (G-30) of the Last Chance finds Parting Quartzite below the Wash. The Australian (G-28) and Tenderfoot (G-26) also find vein material at the contact.

The Little Ellen mine, higher up and on the slope of the hill facing South Evans gulch, finds a very large body of low-grade lead ore at the same horizon, where the strike has changed to east and west. This contact is traced eastward through the Lulu, Gnome, and Alps workings, showing considerable replacement action, but as yet no large ore bodies.

## BREECE HILL.

In the large area lying between the regions above described and Iowa gulch there is an immense development of igneous rocks, and, on the theories deduced from the studies made in this region that there is a direct connection between igneous action and ore deposition, or rather that the latter is more abundant where the former has been most active, this area should contain large deposits of ore. Unfortunately there is little else than theory upon which to base this assumption. The ore horizon throughout the greater part of the area is so deeply buried beneath the surface that, in the uncertainty that exists as to how deep it may be necessary to sink a



shaft in order to reach it, no mine owner has yet had the enterprise to attempt its exploration. It is difficult to predicate the probable thickness of a sheet of porphyry from the width of its outcrops or even from an observed thickness at some point but little removed, since it is liable to change rapidly, both in thickness and in horizon, from causes which are not apparent at the surface. The depths given for the Blue Limestone horizon under the Pyritiferous Porphyry by the various sections which pass through this area cannot be expected to be so close an approximation to the actual facts as when the proportion of sedimentary beds is greater. They have, however, by no means been given at hap-hazard, but are the result of most careful weighing of probabilities, based on a study of the whole region.

The nearest approach to an actual development of ore in the Blue Limestone under Pyritiferous Porphyry is in the Mike mine, and the indications afforded by this favor the supposition that it will be found to be ore-bearing when reached farther east. Another favorable sign is found in the numerous evidences of mineral concentration in the porphyry itself. Scattered bodies of ore have also been found in the beds of the Weber horizon, which are sufficient to show considerable mineral action.

#### GREEN MOUNTAIN.

In the shales and sandstones of the Weber formation and in the adjoining Pyritiferous Porphyry bodies numerous small deposits of ore have been struck, but of somewhat different character from those developed at the Blue Limestone horizon. The most important of these have been found on Green Mountain, in regard to which the following information has been obtained.

The Ontario mine is opened by a tunnel 380 feet long and a shaft 70 feet deep, run through Pyritiferous Porphyry into micaceous sandstone and black shale. The deposit is found in a vein running north and south, and traceable from about one hundred feet from the mouth of the tunnel through the porphyry into the overlying sandstones. A body of coarse-grained galena 20 feet long by 3 feet in width was found in the porphyry, but in the sandstone the vein proved barren. A similar deposit in the porphyry is found in the adjoining Tiger (E-22) mine. It is a gash vein six to eight

inches wide, running northeast, with a dip of  $60^\circ$  to the southeast. The ore is a mixture of galena and pyrites, one lot of which yielded 22 ounces of silver and 22 per cent. of lead to the ton.

In the Green Mountain (E-12) mine the ore occurs in the sandstone, and is a free-gold ore, sometimes very coarse. It was not accessible at time of visit, and nothing certain could be learned of the form of the deposit, which is very probably also a gash vein.

#### LONG AND DERRY HILL.

**Ready Cash mine.**—On the steep south wall of Iowa gulch formed by Upper Long and Derry Hill is the Ready Cash mine, which is interesting on account of its occurrence in Archean rocks rather than from its importance as an ore-producer. Its country rock is a coarse-grained, reddish granite similar to that found at the heads of Iowa and Empire gulches. The ore occurs in two small veins from one foot to four feet in width, which come together at the surface. The one strikes N.  $25^\circ$  E. and dips  $50^\circ$  to the east; the other strikes N.  $45^\circ$  E. and has a still steeper dip. The mine is opened by tunnels which run into the hill in a southerly direction and cut the veins at about three hundred and twenty feet from the surface; in one of the upper tunnels a dike of quartz-porphry is cut between the two veins, in which are some gold-bearing seams. The vein filling consists principally of altered granite, carrying free gold and some chloride of silver, with relatively well defined walls. The deposit is evidently formed along fracture planes in the granite, filling any cavity that may have existed and replacing the constituents of the adjoining country rock.

**Long and Derry mines.**—The Long and Derry mines were among the first discovered in the Leadville region, and are still held by their original owners, a very exceptional circumstance. They have been worked very slowly and irregularly, and at the time of examination no maps had been made of the underground workings. Many of the drifts had become inaccessible, so that only a very general idea of the form of the deposits could be obtained. They occur as a replacement of the Blue Limestone, but, as contrasted with the deposits of Iron and Carbonate Hills, rather in the form of large chambers than along the contact with the overlying White Porphyry.

These chambers are irregularly distributed through the upper part of the Blue Limestone, and, as the latter has been more or less eroded, some of them formed actual outcrops of ore on the surface, and were thus easily discovered in the commencement. The mine is opened by both tunnels and shafts, but the ore is mainly extracted through the former. The Faint Hope (M-4) tunnel runs 180 feet through limestone and vein material and 360 feet in White Porphyry, to the bottom of the Porphyry (E-37) shaft. The latter passed through 98 feet of porphyry and was sunk 46 feet in vein material containing nodules of chert and low-grade ore. The Long and Derry (E-32) tunnel runs in a southerly direction from the hillside overlooking Iowa gulch, starting in White Porphyry and being expected to reach the contact at 500 feet. In the Dana (M-3) shaft were found many chert nodules in the porphyry, which carried casts of fossils, principally *Pleurophorus* and *Spirifera*. Such included chert nodules are frequently found not far from the contact plane and were evidently caught up in the mass of the porphyry as it forced its way along between the strata. The whole body of the limestone on Long and Derry Hill seems to be more or less impregnated with oxides of iron and manganese and with silicious material, as shown by the black outcrop at the Belcher (M-5) mine, near the base of the formation. In this outcrop the replacement evidently proceeded from above, as the ore wedges out at the bottom. The apparently broken character of the formation in the vicinity of the ore deposits may be due in a measure to its proximity to the surface and want of a protecting covering of Wash. In one portion of the mine was a large accumulation of angular blocks of porphyry in the limestone, which had probably fallen from above into a cave that had been dissolved out by surface waters.

The ore is carbonate of lead and chloride of silver near the surface and galena in depth, the latter, as usual, being generally richer in silver than the carbonate. Only small specks of pyrite have been found in it. The dike of Gray Porphyry, which crosses the hill in front of the Faint Hope tunnel, may be supposed to have been an important factor in the concentration of ore here by causing a stagnation in the mineral-bearing currents.

## PRINTER BOY HILL.

The existence of the three transverse dikes crossing the slopes of Printer Boy Hill and of the cross-cutting bodies of Pyritiferous Porphyry on its north side, in the upper part of California gulch, is an indication of probable mineral concentration in this region, and developments, so far as they have gone, tend to confirm this idea.

On the south slope the curving outcrop of the contact of Blue Limestone and White Porphyry has been very extensively prospected near the surface, and evidence of replacement action has been found at almost every point. Figure 4 shows an ideal section of the middle portion of the south slope and the relative amount of vein material, as far as can be determined by present workings.

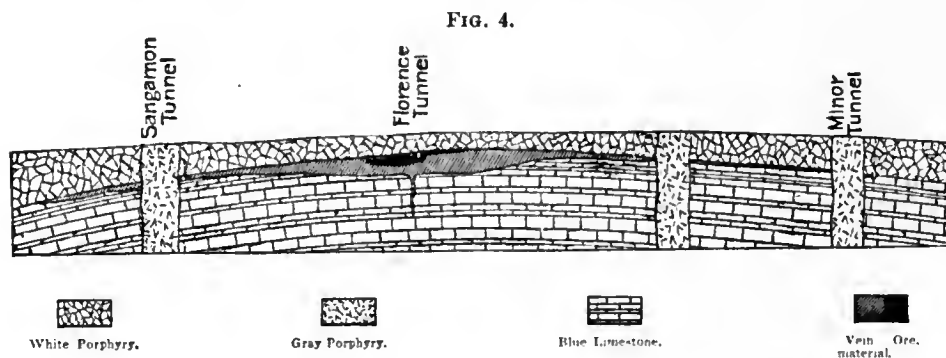

The principal development of ore has been thus far found in the Florence mine, which is at the crest of the fold. The vein material, which is the usual clayey matter, carrying oxides of iron and manganese, has here a maximum thickness of thirty to thirty-five feet, and seems to thin out to the east and west, respectively, but to the north or into the hill it has as yet been explored but a short distance. The ore occurs at the surface and rather irregularly through this vein material; besides the usual carbonate of lead and chloride of silver, it contains several minerals not common in the district, among which may be mentioned native gold, visible to the naked eye, and a sulfo-carbonate of bismuth. (See Appendix C.) In a tunnel directly below the main workings of the Florence a gash vein of galena in limestone several feet in thickness was found. Above, it connects.

with the ore body of the Florencê, but, as followed in depth by a winze, was found to pinch out entirely, furnishing one of many proofs that the ore entered the limestone from above and not from below.

The dikes of Gray Porphyry on either side of the Florence are thirty to fifty feet wide and can be traced along the hill for considerable distances. They have the characteristic large crystals of orthoclase porphyritically distributed through the mass.

East of the Florence the Minor tunnel has been run several hundred feet on the contact without finding ore, but good ore is said to have been obtained from the First National mine, still farther east. In the latter the limestone seems to be split into two parts by the cross-cutting zone of White Porphyry.

To the westward the contact has been developed by the Sangamon tunnel, the Wilson, Brian Boru, G. M. Favorite, and other mines, and some ore has been shipped, but no certain information was obtained in regard to its quantity or its quality.

Although some prospects showing ore may have escaped observation, the above descriptions suffice to show that on either side of Iowa gulch in the vicinity of the three dikes of Gray Porphyry the Blue Limestone contact is ore-bearing over a comparatively large proportion of its extent. It can, however, hardly be said to have been thoroughly explored as yet, nor are the ore developments as rich or extensive as the geological conditions would lead one to expect. It may, therefore, reasonably be assumed that future explorations in this area, if systematically conducted, will prove remunerative. The most promising direction for exploration would seem to be to the northward under Printer Boy Hill. Next to that, the easterly continuation of the contact in depth beyond the First National affords a promising field. It must be borne in mind, however, that in this direction the zone of cross-cutting White Porphyry will soon be reached, where the Blue Limestone will be found split into two wedge-shaped masses, and thus there will be two contacts between limestone and porphyry.

#### IOWA GULCH.

In Iowa gulch, to the westward, the contact is cut off by the Mike fault, after crossing the gulch just beyond the G. M. Favorite. A little farther

down the gulch, however, opposite the Rock and Dome workings, it comes to the surface again and is explored in the Nisi Prius and adjoining claims. In the Nisi Prius very large bodies of highly manganiferous vein material are found, which, though not rich themselves, are generally considered to indicate the proximity of a concentration of chloride of silver. The tunnel on this claim cut through a series of limestone ridges alternating with depressions filled by vein material. That the ridges in this case do not represent actual folds in the formation is proved by the fact that the stratification lines can be seen to run horizontally across them.

This is the westernmost point at which the contact has been reached in Iowa gulch, and, while it may be found at no very great depth immediately west of Dome fault, the probabilities are that beyond that, as shown by the cross-sections N, O, and P, it is too deeply buried beneath Wash and Lake beds to render its exploration advisable unless it were followed down continuously on its western dip. The thickness of superincumbent detrital material given in these sections is deduced from that found in the Coon Valley and Black Cat and is probably a pretty close approximation to the actual facts. The limits of the ore horizon to the westward, as indicated by the western outcrops of the Blue Limestone, are theoretical deductions, and may vary somewhat from the facts; but the limit of error here is not a very wide one, as actual outcrops of Archean on this strike-line are found at a very short distance south of the boundary of the map.

#### HEAD OF CALIFORNIA GULCH.

On the north side of Printer Boy Hill and in the upper part of California gulch the geological conditions are extremely complicated, owing to the number and variety of porphyry bodies and their rather unusual structural relations. The cross-cutting zone of White Porphyry passes through here, as shown by the fact that on the north side of the gulch it comes in contact with the Parting Quartzite and on the south with the Blue Limestone. A body of Pyritiferous Porphyry is also found cutting up across the formation, being in the White Limestone at the bottom of the gulch, and to the northward apparently joining the main body, which overlies both White Porphyry and Blue Limestone. In addition to these are several

bodies of Gray Porphyry, whose position and structural relations are very imperfectly known. For these reasons a considerable concentration of ore might naturally be looked for in this region, but it would probably be found more irregularly distributed and less easy to follow than in the normal groups of Carbonate and Iron Hill. The ore currents would no longer have been confined to one or two principal channels, but would have had a variety of contact planes which they might have followed, and whose position cannot be predicated beforehand. Unfortunately the small amount of exploration already made not only gives but an imperfect idea of the actual geological relations of the various bodies, whose representation on the map and sections may in consequence be somewhat imperfect, but the actual development of ore has been so slight as to afford no indication as to what particular contact is the more likely to contain ore. The normal contact of Blue Limestone and White Porphyry extends eastward from the Pilot fault along the north slope of Printer Boy Hill, until in the Eclipse the limestone commences to wedge out. Ore is found in considerable quantity in the Pilot tunnel, apparently along the very plane of the fault, and a certain amount of vein material occurs at the contact in the Lovejoy, Eclipse, and other shafts. On the other side of the gulch the same contact that carries ore in the Adelaide-Argentine, viz, Parting Quartzite and White Porphyry, is found in the Iron Duke and others and is apparently mineralized to a certain extent.

#### GOLD DEPOSITS.

Between Pilot and Mike faults, on the northwest slope of Printer Boy Hill, is a body of porphyry not identical with any other found in the region and which is notable for containing the Printer Boy and Five-Twenty gold-bearing lodes.

The Printer Boy lode was discovered before the existence of carbonate ores in this region was known, and produced a large amount of gold between 1866 and 1870, of which no record can be obtained. It is a practically vertical deposit along a jointing or fracture plane in the porphyry, having a direction a little east of north. It now consists of two claims, the Upper Printer Boy and Lower Printer Boy, each opened by vertical shafts.

Only the latter was accessible at time of visit, and here the vein is double, the two branches being separated by ten or twelve feet of decomposed porphyry. The gangue is nothing more than thoroughly decomposed porphyry, being a white, clayey material in which only the quartz grains of the original porphyry remain unaltered; scarcely any metallic contents are visible. In the old workings, where the ore was rich, free gold could be seen, and in the deeper workings considerable iron and copper pyrites and some galena and tennantite were found. Gold occurred in both pyrite and galena, and a piece of ore containing galena crystals, connected by a filament of wire gold, was one of the show specimens of the mine. Selected specimens are said to have contained 122 ounces of gold to the ton, and the average assay is given at three to four ounces. The vein has varied in thickness from one inch to four feet, with an assumed average of seven inches. On the west wall, from the surface down to a depth of 200 feet, were branches or stringers extending out into the porphyry, sometimes as much as three feet thick and containing ore of similar quality to the vein, though of different color and hardness. South drifts from the shaft of the Upper Printer Boy were said to be cut off, successively, at a distance of a few hundred feet, by a cement deposit, which, from the description given by those working the mine at that time, would seem to be a portion of Lake beds deposited in the bay that, as already shown, existed where now is the spur separating California from Iowa gulch.

In the Upper Printer Boy the normal Printer Boy Porphyry, which is a coarse-grained, greenish-gray rock with large feldspar crystals, was overlaid by a white, fine-grained porphyry, resembling decomposed Pyritiferous Porphyry from which the pyrite has been dissolved out. It is said that the former was only found at one hundred to two hundred feet below the surface, but this does not agree with observations which show the Printer Boy Porphyry in all the prospect holes around the Upper Printer Boy shaft. Both rocks occur in the Gray Eagle tunnel (M-53), west of Eureka gulch, and it is probable that part of the main body of Pyritiferous Porphyry originally covered this portion of the hill and that from the pyrite in it the waters derived the metallic contents which now are deposited in the veins. A number of other small gold-bearing veins are also found in the Printer Boy porphyry, the most important of which is the Five-Twenty, from which a



considerable amount of gold ore is said to have been taken. The tunnel by which it was opened also cut a body of carbonate ore, which at that time was not considered worth extracting.

These deposits, together with that of the Colorado Prince mine, would seem at first glance to be of different character, and perhaps of different origin and manner of formation, from the normal carbonate deposit of the Leadville region, and more in the nature of the ordinary fissure vein. The somewhat limited study which it has been possible to make of them tends to show, however, that the process of ore deposition was essentially the same in both cases. There is no evidence of any pre-existing cavity which was filled by foreign gangue material; but the ore currents, following in this case a fracture or jointing plane, instead of a stratification plane, deposited gradually their load of metallic sulphides by a chemical interchange with the material of the rock through which they passed. Gold seems to have been principally deposited in the more acidic or silicious rocks and silver in the calcareous or basic ones. This preference is not confined to the Leadville region, but is seen in other mining districts. Its reason, however, is not yet satisfactorily explained from a chemical standpoint.

As regards their relative age, the little evidence that can be obtained seems to indicate that the carbonate deposits are older than the gold veins under consideration, since the former must have been originally deposited before the folding and faulting took place; whereas, if the assumption that the latter occupy fault planes be correct, it is probable that they were formed subsequently to this period.

#### PLACER DEPOSITS.

It is worthy of note that California gulch has furnished almost all the placer gold which made this region known long before its wealth in silver was even suspected, while Iowa and Evans gulches, adjoining it on either side, which are carved out of the same series of rocks and are both larger and contain more detrital material, have thus far yielded little or no return to the placer miner. The question naturally arises, therefore, why should the smaller gulch contain, as it did, exceptionally rich gravels and its neighbors be practically barren? Although placer mining had been virtually abandoned before this investigation was undertaken and these deposits no

longer constituted an essential part of the mining industry of Leadville, nor could detailed studies be made of them, yet some suggestions are afforded by the consideration of the general geological conditions of the region that are not without value.

The richest portions of the California gulch diggings are said to have been, first, in the bend below Oro, at the mouth of Nugget gulch; next, in the bend at the La Plata mine; and then in that below Graham gulch. The first was exceptionally rich, and in the narrow bed of the gulch at Oro a gold-bearing cement, containing hydrated oxide of iron, was found below the gravel, which yielded one ounce of gold to the ton. The gulch gold was worth \$17 to \$19 per ounce, while that from the mines was worth only \$15. From its propinquity the Printer Boy Porphyry, known to contain actual gold veins, suggests itself as the source of these rich gravels, with the oxide of iron resulting from the decomposition of pyrite in the Pyritiferous Porphyry as a cementing material. Moreover, the Weber sandstones, at the head of the gulch, have been found to carry gold veins, and from their abrasion also gold-bearing gravels would have been carried down the gulch. These probable sources of gold seem, however, inadequate to account for the greater relative richness of California gulch over its neighbors, since both Evans and Iowa gulches contain gold-bearing veins and the amount of sandstone and porphyry débris that has been carried away through either of their beds must have been far greater than that swept through California gulch.

It seems very doubtful whether in general all, or even the greater part, of the gold contained in placer gravels is derived from the abrasion of actual gold veins. Traces of gold may be found in a very large proportion of the massive rocks which form the earth's crust. Gold veins are concentrations of this mineral in sufficient quantity to attract attention and yield a profit to the labor of man; but doubtless there are a vast amount of smaller concentrations which may escape his notice. As the rock disintegrates and is worn away by atmospheric agencies the gold from these smaller deposits, as well as from the larger, is set free from its inclosing rock and subjected to the concentrating action of mountain streams. Placer deposits are the results of nature's vast sluicing processes. To bring them into the condition

in which they may be made available by man requires not only the gold-bearing rock, which her agencies may grind up into sand and gravel, but the sifting power of rapid streams, which may carry down the lighter and coarser material, and a suitable channel, in which the heavier particles may lodge, as in the riffles of a sluice-box. All mountain gravels, all sands of rivers coming from the mountains, contain a certain amount of gold, but it is only under peculiarly favorable conditions that the gold is so concentrated as to render the gravel or sand remunerative to the labor of man. Among the most favorable of these conditions is a comparatively narrow channel, having a hard and compact bed-rock and ridges or bends in its course, which, by causing a partial arrest in the rapidity of the current, shall allow the heavier particles of gold to settle to the bottom and hold them there when once they have settled.

From this point of view there is a very evident reason why California gulch should have furnished rich placers and why the gold which may exist in Iowa and Evans gulches should not yet have been extracted, even though the detrital material which has been carried down either gulch should originally have been equally rich in gold. California gulch, as has already been explained, is a valley of erosion, formed entirely by the action of running water and since the Glacial period. It has, therefore, a bottom or bed of hard rock; its transverse section is V-shaped and therefore, like the Spitzkasten, favorable for the concentration of heavy particles at its bottom. When comparatively full of water, its numerous bends formed eddies in the down-flowing currents and allowed a longer time at these points for the settling of the suspended particles; and, as it cuts across many different formations in its course, its bed must have transverse ridges, which have caught some of the gold and prevented it from being carried farther down the stream. Evans and Iowa gulches, on the other hand are glacier-carved valleys; their courses are straight, their bottoms broad and comparatively smooth. The moraine material with which they are largely filled has not been subjected to the sifting or jiggling process, to which gravel is subjected in the bed of a stream. Moreover, as shown in Sections M, N, and O, the lower part of their present bed is cut, not out of rock, but out of the loose gravelly formation of the Lake beds. It is not probable that this later bed, along which the mate-

rial brought down by post-Glacial erosion has been carried, has a sufficiently hard and permanent bed-rock to allow of the concentration of gold on its surface; at any rate, such bed-rock has not yet been found. It is probable that the actual rock surface, which formed the bed of the Glacial valley, may be found gold-bearing if it is ever explored; but it could hardly be expected that in it gold will be found so concentrated as it was in California gulch, and its exploration will necessarily be attended with many mechanical difficulties, owing to its probable depth below the present surface.

The Lake bed deposits themselves undoubtedly contain a large amount of free gold, and it is probable that this may be sufficiently concentrated at some points on the bed-rock of the original lake to be worked with profit; but the form of this bed is as yet too little known to give any definite idea of where such points may be. Probably the valley of the east fork of the Arkansas would be the most favorable point for such an exploration, since its drainage area is the most extensive of any of the valleys tributary to this ancient lake; but it would be impossible to determine beforehand how far up this valley the ancient shore-line of the lake extended.

#### ORE PROSPECTS IN UNEXPLORED AREAS.

Besides the regions mentioned in the above description there are a few other unexplored areas in which the contact may be reasonably expected to be found productive which will be enumerated below in the order of their relative availability, or of the proximity to the surface or to known deposits at which the contact may be found.

On Dome Hill, as shown in Section H, Atlas Sheet XIX, the contact is near the surface on either side of Dome fault, and is practically unexplored south of the Dome workings on the one side and of the Ben Burb on the other. From the Dome mine southward to Iowa gulch, east of the fault and along the west side of the fault for a corresponding distance, there is good reason to assume that the contact will be found productive, and explorations should be conducted on the dip in either direction, though to the westward the assumed limit of probable mineralization will soon be reached, and on the lower part of Dome Ridge, beyond the Coon Valley, present indications do not promise any large ore bodies.

On Iron Hill the region west of Iron fault probably contains the continuation of the Iron mine bonanzas, but the depth at which it will be found may be such as to render its exploitation expensive; a shaft sunk to reach the contact opposite the Iron mine might have to go nearly a thousand feet. As there is some uncertainty as to the actual position of the bonanzas in this region, it might be more prudent to follow the contact downward from some point where its depth is known, say in the neighborhood of the Devlin shaft, where it is only 200 feet deep.

On Carbonate Hill the contact should be followed westward from the line of the Pendery fault. It has already been shown in Part I, Chapter V, that there is a good probability that on the northwestern slopes of the hill the formations dip westward, and that farther south in the Pendery ground, though broken by a fault, the displacement of the latter is probably not great. Were the contact followed westward from a shaft reaching the limestone anywhere along the lower slopes of the hill, it would not take long to determine whether it still exists under Leadville or had been removed by erosion previous to the deposition of the Lake beds. Should the latter prove to be the case it would avoid the great and, in this contingency, useless expense of sinking a deep shaft under Leadville itself, which otherwise will doubtless some day be undertaken.

#### MINES AND PROSPECTS OUTSIDE THE LEADVILLE DISTRICT.

The region outside the area covered by the map of Leadville and vicinity was examined primarily with the object of determining its general geological structure and studying the series of formations where they were less metamorphosed and better exposed than in that district, in order that by the experience thus gained it might be easier to unravel the complicated geological problem there presented. In the few short months that could be devoted to this work it was impossible to make a very complete or systematic study of the ore deposits opened by the various mines in this outside region, and only those that came within the line of work and were accessible at time of visit were examined. The following notes, the result of that examination, are offered, notwithstanding their incompleteness, mainly because of the information they afford with regard to the geological dis-

tribution of ore deposits in the area as a whole, which is sufficiently accurate, although the details of ore occurrence, especially in some of the larger mines, could not be ascertained, owing to their inaccessibility. Those mines whose names are followed by an (L) were not seen by the writer, but the information given has been obtained from the notes of Prof. Arthur Lakes, who assisted in the examination. The same general order of topographical description that was followed in Part I, Chapter IV, is preserved here.

#### NORTHEASTERN REGION.

**Monte Cristo mine.**—This mine is situated just beyond the northern limits of the map, on the steeper slope of the spur running eastward from Quandary Peak, just below timber line. Its ore is a low-grade argentiferous galena, occurring in a bed of quartzite of Cambrian age, with little or no accompaniment of vein material or of other minerals. The formation here dips eastward at an angle of  $35^{\circ}$ , which is approximately the slope of the steeper eastern flank of the spur. The quartzite stratum which carries the ore is the outcropping rock on this steeper part, so that it has only been necessary to strip off the thin surface accumulations of soil and débris to reach the mineral, which is thus exposed over an area of several acres. The galena is rather coarse-grained and crystalline, and is irregularly intergrown in the quartzite, occurring on its upper surface from a few inches to a foot in thickness, but in one case extending eight feet below the surface of the bed. It is evident at a glance that it could not have been deposited contemporaneously with the quartzite, and no evidence was seen of any pre-existing cavities; whence it is assumed that its deposition was a metasomatic change by percolating water, like the limestone deposits of the region. Although the ore, from its manner of occurrence, can be mined very cheaply, its tenor in silver is so low and it is so intimately mixed with the quartzite that it probably cannot be smelted profitably without previous concentration in ore-dressing works.

On North Peak ridge the North Star mine (L) is situated at the eastern end of its higher part, a short distance above and west of the saddle marked by the Blue Limestone outcrop. Evidence afforded by the dump shows that its shaft went through the Lower Quartzite cap of the ridge into the Archean gneiss below. At the foot of the steep slope below this mine

and just west of the saddle are several prospect holes in a bed of dark-green hornblendic rock, near the upper part of the formation, which is highly impregnated with pyrites. In the amphitheater north of the saddle copper pyrites are found in the Archean gneiss, in a gangue of quartz. On the saddle itself a shallow prospect hole called Sammy's Barrel shows a gash vein in the White Limestone a few inches in thickness, which carries galena in a gangue of calc spar. At the eastern end of Hoosier Ridge, at the extreme head of Beaver Creek, is the outcrop of a large deposit of iron ore in the upper Carboniferous or Triassic beds, which apparently follows the bedding, and from which specimens of chrome iron are said to have been obtained.

#### MOUNT LINCOLN.

The silver deposits on Mount Lincoln were first discovered in the summer of 1871. In spite of their great altitude, being nearly fourteen thousand feet above sea level, they were rapidly opened; a number of mining towns sprang up at the foot of the mountain; quartz-mills were built and smelting works erected. For a time they enjoyed great prosperity, but of late years have been in great measure abandoned, and the mining towns of Quartzville and Montgomery are now practically deserted. The deposits are principally in limestone. The cause of their abandonment may be found in part in the inherent difficulty of regular development of limestone deposits, owing to their frequent want of continuity and to the misconception on the part of the miners of the character of the deposits. In great part it is probably also due to the excitement attendant on the discovery of the rich deposits of Leadville, which drew away the fickle miners to new fields. Everything tends to show, however, that the region is one exceptionally rich in metallic deposits, and that under systematic development its prosperity may be revived at no very distant future.

The *Russia mine* (L) is situated about five hundred feet below the summit of the peak, in a direction south-southeast. The deposits of this mine are found in the Blue Limestone, which here forms the surface of the spur, the overlying sheet of Lincoln Porphyry having been eroded off. In places, yellowish quartzite and a bed of yellow, compact, argillaceous rock, called by the miners porphyry, is still found above the limestone. The ore is prin-

cipally galena, with some sulphates and carbonates of copper, associated with a gangue material of sulphate of baryta. The deposit, where found at the contact, averages about three feet in thickness, and frequently opens out into large irregular chambers extending down into the mass of the limestone. Some of these chambers are 25 feet high, the general average being about ten to fifteen feet. In working the mine a thin streak of mineral, carrying gypsum associated with galena or barite, was followed until it opened out into a chamber or pocket. The ore appears to be richer as it approaches the summit of the peak. About seventy-five feet from the entrance to the tunnel, a slide or fault was found, pitching  $45^{\circ}$ , with a down-throw to the east. Very little mineral was found on this faulted surface, but following it up from where it was struck in the tunnel it led to a great ore body 45 feet above.

On the extreme of the northeast spur of Lincoln, overlooking the town of Montgomery, are a number of abandoned openings in the Blue Limestone, showing a similar character of irregular deposits of galena, associated with barite, which have been worked principally by open cuts.

#### MOUNT BROSS.

**Moose mine.**—The principal mine on Mount Bross is the Moose mine, which was discovered in July, 1871, though the Dwight, which is supposed to be an extension of the same deposit, was first found in 1869. As the mine was closed to visitors at the time of examination, the data with regard to its workings have been obtained from former superintendents. It is situated on the northeast slope of Mount Bross, near the summit of the wall overlooking the Cameron amphitheater. Its ore is galena and copper pyrites, with their various oxidation products, carbonates and sulphates, and the gangue largely barite or heavy spar. It is found in the Blue Limestone, at or near the contact with the overlying Lincoln Porphyry. The ore has been very rich, yielding from two hundred to three hundred ounces of silver per ton. The formation here dips to the southeast. Besides the overlying Lincoln Porphyry, a dike of White Porphyry was observed, crossing the formation a little west of the mine, and doubtless an examination of the underground workings might have disclosed other bodies of porphyry. The tongue of Blue Lime-



stone, which forms the surface of the spur between the Cameron and Bross amphitheaters east of the Moose mine, is, like that of the corresponding spur of Mount Lincoln, honeycombed with open cuts, from which apparently considerable quantities of ore similar to that of the Moose mine have been taken. So far as observed, the silver deposits in this region have been principally confined to the Blue Limestone horizon.

Dolly Varden mine, on the eastern slope of Mount Bross, at a little lower level than the Moose mine, is also in the Blue Limestone. Its ore is generally more oxidized than that of the Moose, and occurs in the body of the limestone, near its contact with a nearly vertical dike of White Porphyry about forty feet thick. The main dike has a strike of between N. 15° E. and N. 30° E., and dips 60° to the northwest. The ore has been found along the southeast face of this dike in a vertical extent of 150 feet, and extending southeastward into the limestone with the dip of the formation to a distance of 100 feet. On the east of the main dike is a second porphyry dike, with a strike nearly east and west and a dip of 45° to the south, which may be simply a branch of the main dike. On the west side of the main dike as yet no considerable amount of ore has been discovered.

In the little valley on the southeast slope of Mount Bross, known as Mineral Park, is the tunnel of a company which was organized during the prosperous times of this region with the avowed intention of piercing the mountain to strike the source of the rich deposits of the Moose and other mines. It was not visited by the writer, hence an exact description of the rocks through which it has passed cannot be given, but it deserves mention, as illustrating the pernicious habit among western miners of spending large sums in running tunnels through the solid rock with no sounder basis of hope than the chance of striking some unknown rich deposit. This tunnel is said to start in quartzite and to have been driven about seven hundred feet. Whether it commences at the Parting Quartzite or at once in the Lower Quartzite is a matter of comparatively little importance. It starts, at all events, below the horizon of the Blue Limestone, and therefore can by no possibility strike any of the ore bodies contained in that stratum. As will readily be seen by reference to Section L of Atlas Sheet X, the tunnel will soon, if it has not already done so, reach the crystalline rocks of the

Archean formation. Its horizontal distance from the Moose mine is about two miles. The expense per foot of driving such a tunnel after the first few hundred feet, as any person familiar with mining can readily see, must be very great. The only ore bodies which it can strike will be those occurring at considerable depths in the Archean rocks. In this extent of two miles a valuable ore body might be struck, especially near some dike of eruptive rock, but the probabilities are against it. As far as present developments show, the veins discovered in the Archean in this region are generally small and of no great value. Even in the case of a well-defined vertical fissure, the advisability of running so long a tunnel to strike it in depth, unless it had been proved by actual exploration to be rich at the depth at which it would be reached by the tunnel, would be extremely doubtful.

#### BUCKSKIN CAÑON.

The neighborhood of Buckskin Cañon is a region of important developments of ore bodies, which are not confined to the horizon of the Blue Limestone, but occur also at lower horizons, some small bodies having even been discovered in the Archean rocks. The most important of these is the Phillips mine, which was discovered in 1860 by Joseph Higginbotham, commonly known as "Buckskin Joe," from whom the neighboring town received its name. The ore occurs in the Lower Quartzite, near the bottom of the valley, on the south side of the stream. Here an immense lenticular body of iron pyrites, with a little copper pyrites and a gangue of sulphate of baryta, follows the strike of the rocks up the gentle slope of the valley, rising from the stream bed to the foot of the cañon walls. Erosion having laid bare this body in a length of about two thousand feet, it was mined by the early settlers in an open trench from 20 to 30 feet wide and about fifteen to twenty feet deep. Being exceptionally exposed to the action of water and of the atmosphere, the upper part of the deposit was entirely oxidized. By a natural process of concentration this oxidized portion became very rich, so that in the early days, even with the rude processes then in use, consisting mainly in sluicing and grinding in arastras, it was worked at a profit, and from a quarter to a half million dollars are said to have been

taken from it. When the unoxidized portion was reached, the ore became poorer, yielding only about six dollars per ton in gold, and the difficulty of treating it in the ordinary stamp-mill was such that the mine was after a few years practically abandoned. The ore body, which at the surface had practically vertical walls, was found to split up in depth into smaller bodies, dipping eastward and following approximately the stratification planes of the quartzite. On the east side of the open cut a body of porphyry forms the wall of the ore body for a short distance, and is probably an offshoot from a larger body of Lincoln Porphyry which crops out in the stream bed a few hundred feet below the mine. Explorations on this ore body have been carried to a comparatively small distance below the surface, and it is not at all improbable that, if systematically exposed in depth, other large bodies might be developed, which, under present conditions, with smelting works within easy reach, might be mined at a profit.

*Criterion mine.*— On the north wall of Buckskin Cañon, a little above the town of Buckskin Joe and about half way up the cliff, is the now abandoned Criterion mine. Here, just above the junction of the Lower Quartzite with the underlying Archean, in a shallow ravine, is exposed a body of green porphyrite, impregnated with pyrites. A little above this, on the east side of the ravine, is an immense open chamber, about sixty feet in height by one hundred feet or more in length and ten to twenty feet wide, striking N. 35° E. It crosses the beds almost perpendicularly, and seems to have once contained a body of ore, which has been removed either by atmospheric agencies or possibly by some earlier miners of whom no trace is left. The white quartzite adjoining the body is stained with iron oxide and somewhat disintegrated. Nearly adjoining the upper part of this body on the northwest, an irregularly lenticular-shaped ore body has been developed by the tunnel of the Criterion mine. Its form is rather horizontal than vertical, but it connects with the upper part of the large cavity. The vein material is crumbly iron-stained quartz, evidently resulting from the decomposition of the quartzite. The irregular-shaped chamber from which the ore has been taken is in places twenty to twenty-five feet in height, and has been opened for a length of over one hundred feet. No chemical examination was made of the ore to ascertain its actual value, but it contains

carbonate of lead and probably silver. The evidence of extended mineralization at this point is so strong that it is well worthy of more thorough exploration. In all probability the ore was originally a sulphuret, though containing a smaller portion of pyrites than the Phillips deposit, but so far as examined it has been entirely oxidized. In the White Limestone above, apparently on the same vertical plane with the large cavity, an opening has been made on two small bodies of galena, following vertical jointing planes in the limestone. It seems probable that the ore which once filled the large cavities was originally deposited along a jointing plane or the plane of a small fault, and that the cavity has been enlarged by secondary alteration. A small fault with a movement of about twenty feet can be traced along the bed of the shallow ravine which indents the face of the cliff. It is worthy of note that all these planes have a common strike, northeast and southwest, which is also that of the fault on the north face of Loveland Hill; this may be observed on the opposite side of the cañon, about a mile above this point and on a line due southwest from here.

*Excelsior mine (L).*—A little west of the Criterion and higher up on the face of the cliff is the Excelsior mine, likewise abandoned, whose position is marked by the skeleton of an old building standing perched on the edge of the cliff, overlooking the precipice below. Here an irregular body of porphyry or porphyrite traverses the White Limestone, which is somewhat contorted at its contact. The mine is opened by a tunnel, on either side of which the eruptive mass crops. But little ore has been developed, but the rocks are deeply stained with iron, and at the contact of the limestone and porphyry is found a little free gold and silver, with copper and iron pyrites.

The spur of Mount Bross, above these mines, is covered with prospect-holes, the more recent of which are generally in the Blue Limestone. The older prospects, which were made at the time when only gold was sought for, are generally confined to the silicious beds below this horizon.

*Colorado Springs mine.*—In the Red amphitheater, higher up the cañon, on the south face of Mount Bross, is the Colorado Springs mine, which is still being worked, and obtains rich galena ore from the lower part of the Blue Limestone, at or near its contact with the Parting Quartzite. The ore body averages two or three feet in thickness. The lower portion of the Blue

Limestone is here, contrary to what its name would indicate, quite light-colored. The ore is extremely rich, but very irregularly distributed; it is evidently a replacement of the limestone, there being no evidence of pre-existing cavities.

**Dominion mine (L).**—In a prospect hole to the north of this, called the Dominion, ore is also found at the contact of the limestone and Parting Quartzite. The ore body averages two feet in thickness and is said to assay from \$68 to \$500 in silver per ton. It carries brittle silver, silver glance, sulphate and carbonate of copper, and some antimony.

**Sweet Home mine.**—On the face of the cliff, a little southeast of the Red amphitheater, in the gneiss below the Paleozoic rocks, is the Sweet Home mine. Its ore is found near a body of very much decomposed Lincoln Porphyry, whose surfaces are covered with a yellow coating of oxide of iron, containing arsenic and antimony. This mine is interesting from the varieties of mineral species thus far obtained from it. Among these are cuprite, fluorite (pink and blue), jamesonite, melanterite, rhodocrosite, and zinkenite.

From the Tanner Boy mine, on the southwest side of the gulch, said to be a fissure deposit in gneiss, are obtained remarkably fine crystals of deep red rhodocrosite, or carbonate of manganese, containing a little magnesia. It occurs in very well-defined rhombic crystals, isomorphous with calcite. As might be expected from the prevalence of eruptive bodies, ore is found in small veins in almost every part of the Archean rocks exposed in Buckskin Cañon. As yet, however, no large and important discoveries have been made, and a priori the conditions for concentration of large ore bodies would be less favorable here than in the overlying Paleozoic rocks.

On the south side of Buckskin gulch, at the eastern end of the cliff wall, shown in Plate XIII (p. 128), and formed by the lower Paleozoic beds sloping up toward the crest of Loveland Hill, small ore bodies have been opened up, following jointing planes in the White Limestone and the Lower Quartzite. These deposits are generally extremely thin and of limited extent. They frequently send out branches for a short distance into the adjoining rock, following the stratification planes. Their ore is galena, black sulphurets, and sometimes native silver. The direction of

these joints is, as at the Criterion mine, generally northeast and southwest. Their plane is practically at right angles to the stratification. A slight discordance is frequently observed in the beds on either side of the plane, showing a displacement of a few feet. Among those noticed is the Ernest, at the foot of the cliffs just back of the Phillips mine. Here may be seen a phenomenon not uncommon in unstratified rocks, the crumpling of a certain bed, which does not extend to the adjoining beds. This may be supposed to be the result of unequal plasticity, by which, as an effect of lateral compression, one bed has been crumpled or folded, when the others, being more plastic, have expanded sufficiently to allow for the longitudinal contraction. The Ernest is in the upper part of the White Limestone, as is the Rock Island, a little higher up the cañon. The Northern Light, which is shown in Plate XIII, is in the Lower Quartzite, and has a gangue of calc spar. Its vein material has a maximum thickness of 6 feet. Still to the west of this is the Rock Island, which is in the upper part of the White Limestone.

#### LOVELAND HILL.

In the Blue Limestone, which covers the surface of Loveland Hill, are a great number of prospect holes and small mines, which have opened irregular bodies of ore, principally argentiferous galena and its decomposition products.

**Fanny Barrett mine (L).**—The most important of these is the Fanny Barrett, which is situated not far from the edge of the cliff overlooking Buckskin gulch, and apparently near the line of fault noticed on the south wall of Buckskin gulch. It is about on the line of strike of the Criterion deposit. The ore fills a so-called fissure some four feet in width, containing galena and what is called by the miners "hard carbonate," i. e., a sulphate of lead, forming greenish-white concentric layers like agate, with some carbonate of copper. The gangue is a soft hydrated oxide of iron, with considerable oxide of manganese, which gives it a black color. In places the ore forms branching deposits and lenticular bodies of considerable size along the stratification planes. The fissure is supposed to have been traced quite across the crest of Loveland Hill to the cliffs facing Mosquito and Buckskin gulches on either side. On the Buckskin side, a little above the contact of the Archean with the Lower Quartzite, a body of ore has been opened in the

gneiss, at the junction of the porphyry and the white quartzite. A little below this a vertical fissure has been opened in the gneiss, about two feet in width, containing galena and spathic iron. From the description, this deposit is evidently of the same nature as the other limestone deposits in the region, in this case, however, following mainly a vertical jointing plane. It is hardly probable that such a plane would be found to be actually continuous for any great length, but very likely, from the persistence of its direction, these planes have been developed more frequently in the neighborhood of the line of the fault, and may have been accompanied by a slight displacement. This movement would naturally extend for some distance into the underlying Archean, and the ore currents would follow similar joints formed in these rocks. From analogy with other deposits in this district it is hardly probable that the so-called fissure veins in the gneiss have been filled from below.

Higher up on Loveland Hill, on the ridge which connects it with Buckskin Peak, ore is found in the White Limestone and in the Lower Quartzite. Among the prospects the La Salle ore body occurs between the limestone and the quartzite; Little Nell and Julia are on narrow vertical veins, also striking northeast, in the Lower Quartzite. On the very top of the hill, in a small patch of Lower Quartzite, are the Mountain Lion and Silver Exchange claims, whose ore is galena, with green carbonate of copper, carrying gold and silver. On the Mosquito side of the hill is the Kansas mine, at the junction of the White Limestone and Lower Quartzite, in proximity to the porphyrite body, below which is the Christian Aid.

On the southeastern end of Loveland Hill, towards Mosquito gulch, numerous bodies of ore have been opened in the Paleozoic rocks. Of these the most important is the Orphan Boy, which is abandoned and was not visited. Its ore is found in quartzite, which probably belongs to the Cambrian formation. The Jersey and other claims near Park City, in the bottom of the gulch, have struck galena in the White Limestone.

#### BETWEEN MOSQUITO AND HORSESHOE GULCHES.

South of Mosquito gulch, on Pennsylvania Hill, are many prospects in the Blue Limestone, and on Ball Mountain in the Weber Grits. In none of

these, so far as observed, have any ore bodies of value been found. The prospects in the Weber Grits are especially barren, and it is difficult to conceive what inducement has been offered to the miners to expend the amount of labor they have in this region. In general they seem to have been attracted by the darker beds, containing carbonaceous matter, whether sandstone or shale, which, in general, have a little pyrites in them and sometimes a trace of gold. Along the Sacramento gulches also, and as far as the ridge which divides them from Horseshoe, the labor of the miner seems to have been barren of practical results. This is the intermediate region between the Lincoln Porphyry intrusions around the Mount Lincoln massive and those of White Porphyry along the line of Horseshoe gulch.

**Sacramento mine.**—In the Blue Limestone of the ridge south of Little Sacramento gulch, and east of the London fault, is the Sacramento mine, which has been worked for a number of years and produced a good deal of rich ore. At the mine itself the Blue Limestone forms the surface, the overlying porphyry having been removed by erosion, so that it is impossible to say what proportion of the original ore body may have existed in the upper part of the limestone. The ore, which consists of galena and sand carbonate of high grade in silver, is found generally in irregular masses throughout the limestone beds. Some clayey iron oxide occurs as gangue, and considerable sulphate of baryta is found associated with the mineral. Several hollow caverns have been found by the explorations of the mine, in one of which remarkably beautiful stalactites of white fibrous arragonite occur. These caves have evidently been formed since the deposition of the ore and are connected with natural jointing planes in the limestone. Some of the caverns are partially filled with a clayey material, which runs four to five ounces per ton in silver, and is evidently an infiltration from the ore bodies, which continue on either side of the cave without bearing any relation in form to it. The limestone above the horizon of the ore is generally darker colored than that below, which is of a light-gray color and more crystalline structure; but the distribution of the ore bodies is too irregular to consider them a definite deposit along the dividing plane between these two varieties of limestone. The lighter limestone has the



ribbed structure, characteristic of the Blue Limestone horizon, very beautifully developed.

On the ridge between Spring Valley and Horseshoe gulch the Mudsill claim has found galena at the same horizon, forming a contact deposit between the darker and lighter limestones. To the east of this the Little Christine has developed small veins of galena in the porphyry overlying the limestone. On the eastern slopes of the range south of Horseshoe gulch, as well as on Sheep Mountain ridge, the contact of Blue Limestone and White Porphyry has been but little prospected, and, although no considerable ore bodies have yet been discovered in this portion, there is a fair probability that more systematic search will yet develop them, Sheep Mountain being a most especially promising locality.

#### CREST OF THE MOSQUITO RANGE.

A great deal of prospecting has been done along the very crest of the Mosquito range, the bare, precipitous, and often almost inaccessible slopes of high mountains seeming to offer especial attractions to the hardy prospector. This may be, in part at least, explained by the fact that in these elevated regions the rock surfaces are generally exposed and swept clean of obscuring soil and other surface accumulations, and therefore the "indications" which they follow, such as a staining of iron oxide or of carbonate or of silicate of copper, are more readily seen than in the lower country, where, when found, ore is likely to be more remunerative. It seems hardly necessary to say that the idea that prevails among some prospectors, and to which credence is given even by some educated persons, that rich ore bodies are more frequent near mountain-tops, has no basis of geological evidence to support it. But few mines have been actually worked at the crest of the range, and these only intermittently, which is hardly surprising when one considers that it is frozen up nine months in the year.

At the head of Mosquito gulch, and just west of the London fault, the New York mine is said to have developed considerable rich ore at the contact of the Blue Limestone with a small overlying sheet of White Porphyry of local occurrence.

London mine.—This is the most promising of these elevated deposits, and has been known for a long time; but, besides the natural difficulties of its position, apparent bad management and contested ownership have combined to retard its development. Fuel being expensive at such an altitude, the novel idea was adopted of using wind as a motive power, and a powerful and strongly constructed windmill was built near the mine; but it proved incapable of resisting the force of the fierce winter storms which sweep over Mosquito Pass, and was blown down the first winter after its erection.

The geological horizon of the deposits, as explained in Chapter IV (p. 142), is apparently near the junction of the White and Blue Limestones, at the contact with a sheet of White Porphyry lying parallel with the stratification. It is there shown that the strata are here turned up at a steep angle against the London fault on its west face, and that as their strike makes an acute angle with the plane of the fault, they are gradually cut off by it, successively higher horizons coming in contact with the fault line as one goes across London Mountain from north to south. This is shown in a general way on the map of the Mosquito Range; but it must be borne in mind that the line of fault could not be traced with absolute accuracy, owing to its covering of débris, and that, even if it could have been, the scale of the map is too small to represent the necessary details of structure. This is a point of great interest as regards both its geological structure and the light its exploration might throw upon the genesis of ore deposits, and it is to be regretted that the underground workings of the mine had not been sufficiently extended to afford more definite data on these points. In the single, somewhat hurried visit that could be made only a cursory view could be obtained of the ore deposits and their surroundings. They consist of two so-called veins, parallel and about forty feet apart, standing nearly vertical and striking about northwest and southeast. Of these, the southwestern has an average thickness of about four feet and is extremely well defined. It carries sulphurets of lead, copper, and iron, with some gold. The northeastern body is a free-gold ore, impregnating the country rock for about two feet in thickness. Both have been proved in a length and in a height above the tunnel level of several hundred feet, and the ore was said to average \$40 per ton and upwards, consisting in considerable proportion of free-milling ore.

The main working tunnel was run into the base of the mountain on a level with the mine buildings, a little west of south in direction, and cut the ore bodies at 510 and 590 feet from its mouth, respectively. From this drifts run along the veins in southeasterly direction, from which it was intended to carry stopes upwards toward the crest of the mountain, which, at its summit, is seven hundred to eight hundred feet above the tunnel level. The direction of these ore bodies converges towards the fault plane, and it was estimated that the latter would be cut by these drifts under the crest or a little south of that point, the distance at which it would be reached depending on the angle of dip of the fault plane, of which nothing definite could be ascertained. If this dip were very steep or near the vertical, the distance of intersection would be correspondingly greater. It was evident from what was seen during the examination that the ore bodies, in spite of their appearing at first glance to be vertical veins, are following, at least approximately, the stratification of the sedimentary beds, and in this respect resemble the majority of the deposits of the region. They were, therefore, probably formed before the folding and faulting took place; in which case they will end at the fault plane, their continuation beyond that plane having been carried up by the movement of the fault, and since eroded away. It is, of course, possible that the ore currents by which they were deposited came up along the fault plane itself, in which case the ore bodies would naturally be found to continue downwards on that plane. Should this be found to be the case it would be the first instance observed in all this region of original ore deposition on one of these great fault planes.<sup>1</sup>

*Peerless mine.*—At the head of Horseshoe gulch are a number of claims, two of which have developed a considerable amount of ore. Of these, the Badger Boy is in the Blue Limestone, which is exposed in the bed of the north fork of Four-Mile Creek. The Peerless mine is at the very crest of the ridge, just south of Peerless Mountain. Its ore is found about twenty feet below the top of the limestone in irregular lenticular bodies. The limestone is here very silicious, the upper part resembling quartzite, but it

---

<sup>1</sup> Since this visit a wealthy company has developed the mine, building a railway eight miles long for transporting ore and supplies and a mill for the reduction of the ore. The fault plane is said to have been cut by the drifts along the vein, but trustworthy accounts are wanting as to the results of developments bearing upon the above points.

is also very much iron stained, and it seems probable that this is merely a secondary deposition, resembling the gangue matter of some of the Leadville mines. The ore is galena and hard carbonates, with a little copper, generally in the form of carbonate.

#### WESTERN SLOPES OF MOSQUITO RANGE.

On the west side of the range, outside the limits of the Leadville map, are many prospect holes, both at the contact of the Blue Limestone and White Porphyry and in the underlying and overlying rocks indiscriminately. The former have generally developed a little ore, even as far south as Weston Pass, but the developments are extremely superficial and unsystematic. Here, as elsewhere, miners seem particularly attracted by the black layers which are common in the Weber Grits, and considerable labor has been fruitlessly expended in exploring the bed of black shales on Empire Hill, which contains fossils whose casts have been replaced by iron pyrites. In the region north of Leadville, on the west side of the range, owing to the fact that the surface is principally occupied by the Weber formation, the by no means inconsiderable labor expended by prospectors has been comparatively fruitless. Slight traces of ore are frequently found in contact with the numerous bodies of porphyry which traverse this formation, but as yet none worthy of any extended development. The teachings of this examination are that remunerative ore bodies are far more likely to be found in the calcareous than in the silicious beds, and for this reason prospectors would be wise to direct their labors principally to prospecting the outcrops of limestone strata. The actual ore contact between Blue Limestone and overlying porphyry occurs on the wooded slopes bordering Tennessee Park, and is so much obscured by surface accumulations that it is practically unprospected.

**El Capitan mine.**—This mine is situated just west of the extreme northwest corner of the Mosquito map, the location of its shaft being given in the margin. Greater importance attaches to it than the economical value of the ore bodies would otherwise warrant, because it is the first discovery of rich ore in Blue Limestone north of the Leadville district. No indications of ore were found upon the surface in this region, and it was simply

because it was recognized as the "Leadville contact" that the limestone was prospected. The general geological structure is shown in Figure 5, which represents an east-and-west section approximately along the northern boundary of the area mapped.

Figure 5.—Taylor Hill.

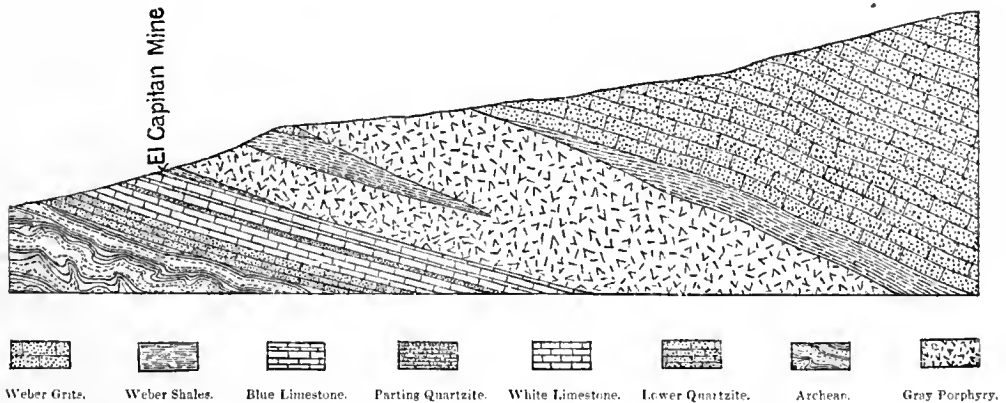

The Cambrian, Silurian, and Blue Limestone beds here outcrop along the base of the wooded hill slopes, dipping at about  $20^{\circ}$  to the eastward. Above these is the main sheet of Gray or Eagle River Porphyry in great thickness, the sandstones of the Weber Grits forming the upper part of Chicago ridge. The lower part of the Weber Grits, or the Weber Shales, which here consist mainly of quartzite, with only a few thin layers of shale, are split into two portions by the porphyry body and separated from the main body of Weber Grits above. A fragment of these, about forty feet thick at the outcrop, is left resting directly on the Blue Limestone below the porphyry body. The Blue Limestone has the ribbings of white calc spar, which characterize it at Leadville and at the Sacramento mine. No ore has been found at the actual porphyry contact, but it occurs at the upper surface of the Blue Limestone, extending downward to a depth of 15 to 20 feet, as shown in Figure 6, which is a section on a larger scale through the mine itself.

As at Leadville, the ore occurs as a replacement of the limestone, but yields free gold instead of lead and silver, the latter occurring only in small quantity, and lead as yet not having been found. The vein material con-

sists of iron-stained clay, with layers of light-colored banded chert, from a few inches to two or three feet in thickness, which pass into coarse silicious sandy material, resembling quartzite; this latter constitutes the richest gold ore. Impure kaolin and Chinese talc are also found in the vein material, and are generally gold-bearing. The deposit is thus in almost every respect a counterpart of those of Leadville, except that gold replaces silver and that lead is wanting. From this vicinity was obtained direct evidence that the iron oxide in these vein materials results from the decomposition of pyrites, in the kernel of undecomposed pyrite that sometimes is found in the center of a nodule of vein material.

Figure 6.—El Capitan Mine.

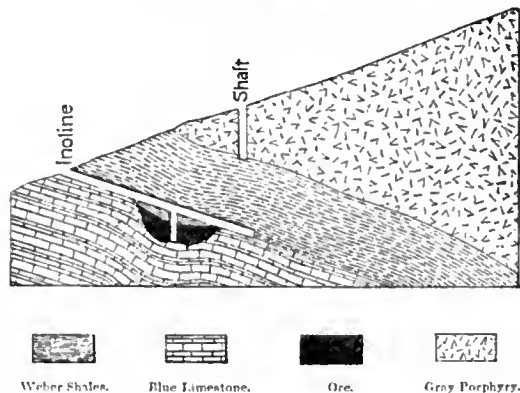

The following table shows the result of a chemical examination of one of these nodules from No Name gulch, to the south of the El Capitan mine. Analysis No. 1 is the pyrite kernel, No. 2 the dark zone next to it, and No. 3 the lighter-colored outer zone. From these it would seem that the process of change is not only an oxidation of the sulphide, but a gradual removal, first of the sulphuric acid and later of part of the hydrated oxide of iron, and a replacement of this by insoluble material, mainly silica. From the two analyses of rich ore (Nos. 4 and 5) in the same table, the richer of the two appears to be that in which this change has proceeded furthest, and which is called "silicious ore," although its contents in alumina would seem to indicate a mechanical as well as a chemical interchange.

	Substance.	Insoluble.	FeS <sub>2</sub>	Fe <sub>2</sub> O <sub>3</sub>	Al <sub>2</sub> O <sub>3</sub>	CaO } MgO }	Ignition.	Ag	Au	Total.
1	Pyrite kernel, No Name gulch .....	7.36	56.31	34.44	.....	Trace.	.....	.....	.....	98.11
2	Darker intermediate zone .....	16.36	.....	73.42	.....	0.09	10.13	.....	.....	100.00
3	Lighter outer zone..	54.28	.....	39.84	.....	0.06	5.82	.....	.....	100.00
4	"Silicious ore," El Capitan mine .....	<i>Silica</i> 82.40	<i>PbO</i> Trace	10.38	4.16	1.217	<i>Water</i> 1.83	0.002	0.011	100.00
5	"Gold ore," El Capitan mine .....	11.56	None	77.60	.....	0.609	10.23	0.0002	0.0004	99.9996

## TEN-MILE DISTRICT.

The ore deposits of this district, which lies north of the western half of the Mosquito map, will be made the subject of a separate monograph, and only a brief mention of their prominent characteristics need be made.

The larger and more prominent ore bodies of this district resemble the Leadville deposits in that they occur as a replacement of limestone strata, and generally along the upper surface of these strata. In this respect they are contact deposits, but the immediately overlying rock is generally a sandstone instead of a porphyry sheet. The development of eruptive rocks is even more remarkable than at Leadville, and they occur generally as intrusive sheets nearly parallel with the stratification, sometimes also in the form of transverse sheets and dikes. Thus, although the ore body may not be found in actual contact with an eruptive rock, it is never very far removed from one.

The ore bodies themselves are less completely oxidized than those of Leadville, probably because of the greater elevation above sea-level, in consequence of which surface waters are imprisoned by frost during a greater proportion of the year. The unoxidized portion of these larger ore bodies consists entirely of sulphides, mainly pyrite, zinc blende, and galena, while the oxidized portion, near the surface, consists of iron-stained, clayey vein material, carrying carbonate of lead and chloride of silver, scarcely to be distinguished from the average Leadville ore, though it is generally less rich in silver. The manner of occurrence of ore bodies

along the upper surface of the limestone, and extending irregularly from that surface downwards, gives evidence also that the ore currents acted from above downwards. Moreover, in the most important mine in the district, the Robinson mine, the actual crack, either fault or jointing plane, through which these currents may have reached the limestone can be traced in the roof of the main ore body and parallel with its longest dimension. Along this a certain amount of pyrite has been deposited in the micaceous sandstone which overlies the limestone.

The beds in which these deposits are found belong to the Upper Coal Measure formation, whose base has been arbitrarily taken at the Robinson Limestone, so called from the mine of that name in which it was first examined.

#### DEPOSITS IN THE ARCHEAN.

On the opposite side of Tennessee Park from the El Capitan mine, one of the prominent peaks of the Sawatch range is known as Homestake Peak, from the mine of that name, which occurs in the Archean rocks on its slopes. It was discovered before the carbonate deposits of Leadville, and is said to have produced considerable rich galena, carrying from 30 to 60 per cent. of lead and from 200 to 250 ounces of silver to the ton. In it has been found a small amount of an arsenical nickel mineral, supposed to be gersdorffite. As the mine was not visited, nothing further can be said as to the character of the deposit.

In the Buckskin and Arkansas amphitheaters are many prospects and a few small mines, on what are assumed by their owners to be true fissure veins. None of the mines were being worked at time of visit, and they were therefore mostly inaccessible. They were examined, however, whenever they came within the line of work, and it was found, so far as such examination extended, that they were invariably a simple mineralization of the country rock along some plane which admitted the percolation of water, whether a jointing plane or the plane of a fault, and that the mineral occurred as an impregnation or replacement of the country rock, the vein materials being simply an alteration product of this rock, and not foreign material filling pre-existing fissures, as is supposed to be the case in a true fissure vein.



## CHAPTER VI.

### GENESIS OF LEADVILLE DEPOSITS.

The ore deposits of the region having been described in the foregoing chapters, with as much detail as space allows, it remains to gather together briefly the evidence upon which the general conclusions with regard to their origin and manner of formation, given in Chapter I, have been arrived at.

Before entering upon the discussion of this evidence, however, I would state that I do not claim that these conclusions are absolute or final, nor do I wish to be considered as offering them as general theories applicable to all ore deposits. They are those that seem to best accord with the facts now at my command, and these facts have been presented carefully, conscientiously, and without bias in favor of any preconceived theory. Other facts may come to light which may lead to a modification of these conclusions, and I reserve the right to adopt such modifications wherever the evidence afforded by further developments in this or any other district which may come under my notice shall seem such as to require it. The study of the underground structure of a mining district necessarily presents many problems which cannot be definitively solved until the entire area has been explored; nevertheless, deductions may be made from observed facts, and from analogy with facts gathered in other carefully studied regions, which will justify a hypothetical forecast that may be of great practical service to those engaged in mining, even should that forecast be proved later to be incorrect in some of its details.

In studying the genesis of the ore deposits of Leadville, one main difficulty at the time that this work was carried on was their universally oxidized condition, resulting from secondary alteration by surface waters,

which rendered it difficult to arrive definitely at the original form in which they were laid down. When the mine workings shall have been extended to such depths that the mineral is found practically sheltered from the secondary action of surface waters the study will be rendered more easy and the results arrived at will be more certain.

In this discussion it will not always be possible to follow the exact order given in Chapter I, which was adopted rather for the purpose of presenting a concise and readily comprehensible statement than as the logical sequence of the processes actually involved in the ore deposition.

#### MANNER OF OCCURRENCE.

Perhaps the most suggestive fact in the manner of occurrence of the Leadville ores is their predominance in the beds of the Lower Carboniferous or Blue Limestone, and one is naturally led to seek a cause for this preference. It being admitted that the ores were deposited from aqueous solutions, it is readily apparent that the more soluble limestone beds would be more easily acted upon by these solutions than the other sedimentary beds of the region, which consist mainly of sandstones and argillaceous shales, and are much less susceptible to the action of percolating waters. This, however, does not explain why the Blue Limestone should have been chosen rather than any of the other calcareous beds of the region.

There was a theory at one time prevalent among mining men in the West that the great silver deposits in limestone were peculiar to a definite geological horizon, a conception that perhaps had its origin in the tendency of some geologists to generalize from the coincidence that certain classes of deposits have been found in different parts of the world at the same geological horizon. Indeed, some have gone so far as to base their determination of the horizon of certain beds, when other evidence was wanting, on the occurrence in them of this class of deposits. The great silver deposits in limestone of the western United States are, in point of fact, found throughout the whole range of the Paleozoic system, and the horizons of no two districts have as yet been proved to be absolutely identical. As a case in point, the vast deposits in the Ten-Mile district, only 16 miles from Leadville, occur in the Upper Carboniferous Limestones, and *not* in

the Blue or Lower Carboniferous Limestone. It is true that these deposits in the western United States are mainly confined to Paleozoic beds, but this is hardly to be wondered at when one considers that the other horizons are almost entirely silicious or argillaceous and contain as a rule a very limited development of limestone. It is evident that broad generalizations on the basis of geological horizon alone are not only unfounded but are misleading, and that it is more logical to seek for an explanation in the local conditions of each individual district.

The causes that may have influenced the concentration of ore in any particular bed of limestone may have been physical or chemical; that is, the structural or physical conditions of the region may have been such that the solutions were naturally directed to that particular bed, or the composition of that bed may have been such as to render it peculiarly susceptible to the action of waters reaching it from adjoining rocks or to cause the precipitation of the minerals held in solution by those waters.

The *physical* or structural conditions of this region have been shown by geological descriptions to be peculiarly favorable to the concentration of percolating waters in the Blue Limestone. The great intrusive sheets of porphyry are found to follow it most persistently, mainly along the upper surface, less frequently along its under surface, and also cutting transversely across it. These intrusive bodies are also found at other horizons, it is true, but at none so persistently and so uniformly as at this. Thus both ascending and descending currents would readily reach these beds, the latter trickling through the uniformly permeable eruptive rock, the former following up the walls of the channel through which it was erupted. Such waters, after passing through a medium of different composition, would be ready for a chemical interchange with the limestone, but in the case of ascending waters it does not appear evident why this interchange should have taken place along one wall of the channel rather than the other, while with descending waters this action would naturally commence on the upper surface of the limestone bed. Thus the physical conditions afford a reason for the predominant choice of this horizon.

As regards the *chemical* composition of the bed, the evidence is less conclusive. Some authors have been inclined to regard dolomitic limestone

as the peculiar habitat of lead and silver deposits, from the fact that many silver-bearing limestones have been found to be dolomitic, making thus a generalization out of a coincidence. But the evidence here fails to confirm any such coincidence. Not only are the other limestone beds of the region, which do not carry metals in quantity, equally dolomitic, but in the adjoining Ten-Mile district the ore occurs in non-dolomitic limestones, and in the Robinson mine is confined to the upper part of a limestone which is almost chemically pure carbonate of lime, while it does not extend into the lower part of the horizon, which carries nearly 7 per cent. of carbonate of magnesia.

A reason which might have been offered for the greater susceptibility of dolomite to the decomposing action of percolating waters, viz, the supposition that the carbonate of lime in a dolomite is first attacked, and that thus a disintegration of the rock is readily commenced, has been disproved in the case of the rocks of this region by the chemical experiments made, which show that the waters act simultaneously upon both carbonates, or rather upon the double carbonate and not upon either of its component parts.

As regards the minor differences in composition between the different dolomites of the region, the chemical investigations which it has been possible to make furnish little more than suggestions. The beds whose physical conditions are most similar to those of the Blue Limestone, and which are also most frequently found mineral-bearing after it, are those of the Silurian or White Limestone.

The first striking difference between the two is the darker color of the former, which is presumably due to organic matter and possibly in part to sulphide of iron, as suggested by Mr. Guyard. Chemical analysis confirms the indications given by outward appearances, showing an appreciable amount of organic matter in the Blue Limestone and none in the White. If the metals were brought in in the state of sulphates, the organic matter would promote their reduction to sulphide. On the other hand, the Robinson limestone, already cited, affords an instance opposed to this view, for there it is the light-colored limestone which carries the ore, while the darker limestone, which it may be assumed has more organic matter, is quite barren. A second difference between the Blue and the White Limestone is that the former contains no silica and the latter over 10 per cent. It may be

that owing to this difference in composition the former is more soluble, but this could only be satisfactorily determined by a practical experiment which should be carried on for a sufficiently long time to imitate in some degree the processes of nature. Before undertaking such an investigation, which would require several years for its proper conduct, it would be advisable to gather data from various districts to determine whether in point of fact the silicious limestones or dolomites are in general less frequently ore-bearing than those of normal composition.

From the above considerations it seems that in this district the main cause of concentration of ore in the Blue Limestone has been its physical or structural conditions, and that the influence of its peculiar composition has been at best of minor importance

## COMPOSITION OF ORES.

As at the time the materials for these investigations were gathered underground explorations had not yet penetrated to depths which were beyond the oxidizing influence of surface waters, a great part of the ores and vein materials collected were necessarily of secondary origin; their composition therefore affords only indirect evidence in regard to the composition and genesis of the original deposits by indicating the agencies and processes by which these alterations were effected.

Independently of this evidence, however, there exist good a priori grounds for the assumption that the original deposits were in the form of sulphides: first, in the fact that, in ore deposits in general, oxidized ores almost universally give place to sulphides in depth and beyond the reach of surface waters; and, second, in that in the analogous deposits of the adjoining Ten-Mile district oxidized ores similar to those of Leadville are seen to result directly from the alteration of a mixture of galena, pyrite, and zinc blende.

**Carbonate ores.**—In the following table are given the analyses of three specimens of carbonate ore, selected as being especially free from impurities, together with that of an average taken from a thousand specimens of carbonate ore as it is delivered by the mines to the smelters, and containing therefore a considerable admixture of what might be considered gangue.

No. 1, from the Adelaide mine, is an extremely pure white sand, made up of small crystals of cerussite, and in the mass looking not unlike a coarse white sandstone. These white sands are, as a rule, less rich in silver than the discolored and relatively impure ones, but this has exceptionally little silver. It does not occur in the Blue Limestone or in the immediate vicinity of it, but between the White and Gray Porphyries.

No. 2, from the Little Chief mine, is a rich sand-carbonate, discolored and appearing to contain more impurities than it really does.

No. 3, from the Waterloo mine, is also a discolored carbonate, less rich than the former, in which only the constituents of cerussite and pyromorphite were determined qualitatively.

No. 4 is the analysis of a mixture of ores made by Mr. Th. Fluegger, chemist of the Harrison Reduction Works. It was made for the purpose of showing the average proportions of the most common elements in the ore, and it may be assumed that neither did the laboratory facilities at his command admit of, nor his purpose demand, an equal standard of accuracy with the others in regard to the rarer elements and their combinations.

*Carbonate ores.*

	1. Adelaide.	2. Little Chief.	3. Waterloo.	4. Average ore.
PbO .....	80.352	75.408	77.980	24.77
Al <sub>2</sub> O <sub>3</sub> .....	0.444	1.415	.....	3.90
Fe <sub>2</sub> O <sub>3</sub> .....	0.467	1.940	.....	24.80
FeO .....	0.290	.....	.....	0.89
MnO .....	0.137	0.074	.....	4.03
MnO <sub>2</sub> .....	.....	1.386	.....	{ K <sub>2</sub> O } { Na <sub>2</sub> O } 0.98
CoO .....	Trace	Trace	.....	.....
ZnO .....	.....	0.095	.....	Trace
CaO .....	0.303	0.335	.....	2.30
MgO .....	0.068	0.056	.....	3.04
SiO <sub>2</sub> .....	0.651	1.972	.....	22.59
Sb <sub>2</sub> O <sub>3</sub> .....	.....	0.121	.....	Sb= 0.02
As <sub>2</sub> O <sub>3</sub> .....	Trace	Trace	.....	As= 0.01
P <sub>2</sub> O <sub>5</sub> .....	1.532	Trace	6.480	.....
SO <sub>2</sub> .....	Trace	0.486	.....	S= 0.90
CO <sub>2</sub> .....	14.700	14.251	10.180	5.58
Cl .....	0.255	0.288	0.840	0.09
H <sub>2</sub> O .....	0.395	1.140	.....	5.53
Ag .....	0.009	0.777	0.047	0.31
Au .....	Trace	Trace	.....	Trace
Total .....	99.012	99.744	95.527	99.95

In discussing the above analyses the combinations of different elements in the ores and the indications afforded as to the state in which they existed prior to alteration will first be considered, next the possible processes, and finally the agencies, by which this alteration may have been effected.

*Gold* exists in these ores only in traces; it has never, so far as known, formed any considerable value in the limestone ores, except in the Florence mine, where it has been observed in the native state. It is in this form without doubt wherever it occurs. It is generally supposed to be most commonly associated with pyrite in sulphuret deposits, and the assays of the Pyritiferous Porphyry given below (Table IV, Appendix B) confirm this hypothesis. They show, however, that it may be associated with galena, and it is said that from the Printer Boy mine a specimen of galena was obtained in which two crystals of this mineral were connected by a thread of gold. Most of the small amount of gold that is produced by Leadville mines comes from deposits in porphyry or sandstone, which sometimes carry a little copper also. The greater part of the gold in Leadville bullion comes from ore shipped to the smelting works from deposits in the Archean rocks of neighboring districts.

*Silver* exists in the oxidized ores invariably in the form of chloride, as far as can be judged by actual observation. With a strong lens, minute crystals and flakes of chloride can be detected on the crystals of cerussite, or coating cleavage surfaces and cracks in the various vein materials, even in comparatively poor ores. The above analyses confirm this observation. The first three show more than enough chlorine for combination with the silver they contain. In the mixture the amount of chlorine is 0.01 less than is required by the amount of silver; if it could be assumed that the determination of chlorine was absolutely accurate, a small portion of the silver might be assumed to be combined with the sulphur, antimony, and arsenic. Since there is a reasonable doubt on this point, the weight of evidence is still in favor of its probable combination with chlorine.

The association of minerals in the Leadville ore deposits generally furnishes a priori grounds for the assumption that in the original deposit silver was in the form either of simple sulphide or of some of the antimo-

nial or arsenical sulphides in which it commonly occurs in nature. As regards the probability of its having existed in the latter combinations, it is significant that in the Adelaide ore, which contains scarcely any silver, only a trace of arsenic and no antimony are found; whereas both are present and in appreciable quantities in the richer ores, 2 and 4. It will be seen later that these substances are generally detected in the vein materials, and are found in considerable quantities in the smelting products, antimony being in relatively larger proportions than arsenic. It will also be seen that all the vein materials and the country rocks adjoining the ore bodies contain a small but persistent percentage of silver.

*Lead* occurs mainly as carbonate, sometimes as sulphate, and quite often in the form of chloro-phosphate. In the Little Chief ore a little sulphate still exists, but no appreciable amount of pyromorphite. In the Adelaide ore, on the other hand, only a trace of sulphate is found, but a notable proportion of pyromorphite, while in the Waterloo ore this mineral amounts to 32.07 per cent., as against 61.78 per cent. of cerussite. Analysis 4 shows no pyromorphite, but the evidence of many tests of ores and vein materials besides those given above and the composition of smelting products, all show that this mineral is very common and widespread throughout the region. The amount of carbonic acid given in Analysis 4 is notably insufficient for the lime, magnesia, and oxide of lead. If it is assumed that the sulphur is all combined with the latter, the mixture contains only one part of anglesite to three parts of cerussite. Even this is, however, opposed to the evidence of observation, for anglesite can but rarely be seen in the ores, whereas cerussite is most common.

That the lead originally occurred in the form of galena is shown by the frequent occurrence of the unaltered mineral in the center of masses of carbonate. A chemical test of one of these galena nodules showed that between it and the carbonate was an extremely thin crust, made up mostly of sulphate. It is, therefore, probable that in the alteration it passed first into sulphate and then into carbonate, although the intermediate product is not always distinguishable.

In the Iron mine a considerable amount of native sulphur, associated with cerussite, was found as an alteration product of galena.



*Iron* and *manganese* might be more properly considered gangue materials. They are mainly in the form of hydrated sesquioxide and protoxide, respectively. A little protoxide of the former and peroxide of the latter ore was found. The former may be combined as basic sulphate, which, as will be seen later, sometimes forms considerable bodies. The latter is probably anhydrous, as pyrolusite is frequently distinguishable in actual crystals and sometimes forms considerable ore masses. Although no actual pyrite was observed in the Leadville deposits, there is little doubt that iron existed in this form in the original deposits. With regard to the original form of manganese there is more uncertainty, as the sulphides of this metal are relatively rare. It sometimes occurs as carbonate, in association with sulphides of other metals, losing its carbonic acid when they are oxidized. It is so common an associate of iron in oxidized ores and so seldom noticed in unaltered sulphides that it might be thought to have been in part brought in as oxide during secondary alteration. It is possible that some of the iron in the ores may be combined with silica as silicate and with arsenic as arseniate. These were not absolutely proved to exist, as it was not considered of sufficient importance to give the time necessary for the tests.

*Zinc* occurs in the above ores in very small proportion, and probably in the form of silicate (calamine), since this is the only mineral of zinc that has been observed in the Leadville deposits. It is rarely visible, and generally forms fine, needle-like, silky white crystals, lining drusy cavities and cracks or joints in the vein material and limestone. There is little doubt that it originally occurred as zinc blende, and, from analogy with the Ten-Mile deposits, it may be presumed that it formed a much larger proportion of the deposit in its original form than it does now. The much greater solubility of its sulphate than that of the other metals would account for its more thorough removal by surface waters.

Of other metals cobalt is the only one not already mentioned that is detected by the above analysis. In addition to this, copper, bismuth, molybdenum, and vanadium have been locally observed in mineral combination, and Mr. Guyard claims to have detected nickel, tin, indium, selenium, tellurium, and cadmium in the furnace products.

The *earthy bases*, alumina, lime, and magnesia, preserve a certain proportion between each other in the three analyses. This accords with the assumption that the deposits are a replacement of limestone, and the fact that the apparently pure cerussite from the porphyry in the Adelaide ground contains as much magnesia and lime as the Little Chief ore is in so far a confirmation of the assumption on structural grounds (see p. 407) that the ore bodies in the former mine are the replacement of fragments of Blue Limestone caught up by the porphyry intrusion.

*Silica* is in relatively higher proportion in the mixture (4) as compared with the earthy bases, but preserves a comparatively even relation to iron oxide, which would be expected from their association in the ores in general. It is a question whether the silica is in part in actual combination with iron or whether it all exists as free silica. Mr. Guyard suggests that some of the lead may exist as silicate, but this also is not definitely proved.

**Chloride ores.**—In the following table is given the proportional amounts of chlorine, bromine, and iodine, respectively, in three typical chloride ores relatively free from other minerals, tested for the purpose of determining whether sufficiently definite quantitative relations exist between these substances to justify the recognition of more than one mineral species. I and II were obtained from the pale-green mineral, and III from a colorless specimen.

*Chlorine, bromine, and iodine.*

	Mine.	Cl.	Br.	I.	Total.
I.	Robert E. Lee .....	13.78	85.63	0.59	100.000
II.	Amie .....	9.80	89.99	0.21	100.000
III.	Big Pittsburgh .....	99.925	.....	0.075	100.000

The results are somewhat negative, and, so far as they go, lead to the conclusion that the chloride ores are merely mixtures, in varying proportions, of chloride, bromide, and iodide of silver. The green chlorides, which are of very common occurrence, are generally called embolite, and this application of the term is justifiable if this mineral is considered simply an indefinite mixture. In the analyses of embolite given in Dana's Miner-

alogy the relations of bromine to chlorine vary from 1:0.33 to 1:5.67, but no iodine is given. In I and II, given above, the relations are 1:0.16 and 1:0.11, and all three contain a small amount of iodine.

According to Moesta,<sup>1</sup> in the mines of Chañarcillo, Chili, there is a regular gradation in these compounds according to depth, the pure chlorides being found in the upper levels down to a depth of 20 meters; below these come mixtures, containing proportions of bromide increasing with the depth; still lower iodide of silver is added to the mixture, and pure iodide of silver occurs at sixty to seventy meters in depth, directly over the deposits of galena and pyrite, in which the first sulphides of silver are found. It has not been possible to detect any regularity whatever in the distribution of these compounds in the Leadville deposits. The colorless and green chlorides are the prevailing varieties, but minute yellow crystals of iodide of silver have been observed in the deposits of the Chrysolite mine.

In Chañarcillo among secondary deposits about half the silver occurs in the native state, and of the other half the far greater proportion occurs as chloride or chloro-bromide, iodides being rare and the proportion of iodine in the mixture being very small. Thus, according to Moesta, from whose work all these statements are taken, the relative proportions of chlorine, bromine, and iodine are essentially the same in which they exist in sea-water. It may be added that the same relations exist in surface waters, and in rocks whenever these substances have been detected in them. Moesta's theory with regard to the chlorides, &c., of Chañarcillo, that they were formed by the action of sea-water (since there is evidence that the region has been covered by the ocean within comparatively recent times), would not apply to the Leadville deposits, for the reason that they have not been submerged since the upheaval and erosion that brought them within the reach of surface waters.

**Basic ferric sulphates.**—In the following table are given the analyses of three specimens, contributed by Mr. L. D. Ricketts, from material observed by him to frequently constitute a persistent bed under the rich ore bodies, especially on Carbonate Hill. This material is of ochreous-yellow color,

<sup>1</sup> Chlor-, Brom- und Jodverbindungen des Silbers in der Natur. Dr. Fr. A. Moesta. Marburg, 1870.

somewhat like a dry clay, and easily recognized by its external appearance, though, as will be seen, of very variable composition:

*Basic sulphates.*

	Mine.	SiO <sub>2</sub>	Fe <sub>2</sub> O <sub>3</sub>	Al <sub>2</sub> O <sub>3</sub>	CaO	MgO	K <sub>2</sub> O	Na <sub>2</sub> O	H <sub>2</sub> O	PbO	Bi <sub>2</sub> O <sub>3</sub>	As <sub>2</sub> O <sub>3</sub>	P <sub>2</sub> O <sub>5</sub>	SO <sub>3</sub>	Cl	Ag	Au	Totals.
I.	Maid of Erin.	None	46.70	None	0.06	0.06	5.33	1.68	10.54	4.27	0.06	0.46	0.05	30.53	0.02	0.0048	Trace	99.8148
II.	Morning Star.	0.30	42.98	0.20	0.64	None	6.31	0.83	10.12	8.27	None	0.42	1.58	27.81	0.26	0.0026	None	99.7236
III.	Lower Waterloo.	0.36	44.40	0.23	None	None	0.15	0.37	8.99	19.50	None	0.39	0.11	25.07	0.04	0.075	None	99.685

These substances are somewhat complex basic sulphates, and might be considered to be a mixture of jarosite with varying proportions of basic ferric sulphate. They are evidently an alteration product of pyrite and galena, although, while nodules of galena rich in silver are occasionally found in them, pyrite has not yet been detected. The absence of zinc in the specimens analyzed is noteworthy, and is in accordance with the observation already made, that it has been further removed from the original ore bodies than the other metals, presumably on account of the ready solubility of its sulphate. The persistent percentage of the alkalis, which were found in sensibly the same proportions in three other specimens tested, would suggest that the waters which produced this alteration reached the ore bodies after passing through decomposed porphyry. Their chief interest lies in the definite evidence they afford that they result from the oxidation of sulphides. Similar products have frequently been observed in old mine openings where large bodies of pyrite have been long leached by surface waters. Copperas first formed gradually loses a portion of its water on exposure to the air, and the protoxide of iron becomes sesquioxide. Further exposure leads to the formation of limonite.

Processes of alteration.—Assuming that the metals in the original deposits existed in the form of sulphides, it comes next in order to consider the possible processes by which the combinations noted above may have been derived from them.

By oxidation all the metallic sulphides may be transformed into sulphates,<sup>1</sup> and the relative solubility of the latter is in inverse proportion to the

<sup>1</sup> Percy's Metallurgy of Silver and Gold, Part I. London, 1880.

distance to which, at Leadville, the metals appear to have been removed during secondary alteration from the original locus of deposition.

According to J. Roth,<sup>1</sup> of such sulphates 100 parts of water dissolve, respectively:

At 11° C., 0.004383 parts	} sulphate of lead.
At 13° C., 0.003155 parts	
At 12° C., 21.300 parts	sulphate of iron.
At 41° C., 41.300 parts	sulphate of zinc.

The sulphate of silver is less soluble than either that of iron or of zinc, but probably more so than the sulphate of lead; and at 100° C. it is said to be soluble in 88 parts of water.

Sulphide of silver may be reduced to native silver by the action of water at 100° C., during which, according to Moesta, the water itself is decomposed and SO<sub>2</sub> and HS are formed. Native silver is slowly converted into chloride in waters containing alkaline chlorides.<sup>2</sup>

Sulphide of silver is converted directly into chloride of silver at ordinary temperatures when exposed to the action of sulphate of sesquioxide of iron, chloride of sodium, and water.<sup>2</sup> The presence of air is not necessary for this reaction, but if the sulphate of protoxide of iron is substituted for the basic sulphate, chloride of silver is not produced without the presence of air. This indicates that a salt of sesquioxide of iron must be formed before the sulphide of silver is decomposed.

Moesta's<sup>3</sup> experiments show that this reaction may take place with a solution of NaCl alone at 100° C., and even at 20° C., but that it is quickened by the presence of chloride of magnesium, and still more by powdered pyrite; also that the combination with iodine is more rapid than with chlorine.

Sulphate of lead is transformed at the ordinary temperature into carbonate by solutions of fixed alkaline carbonates, and also by those containing bicarbonate of lime and atmospheric air. Carbonate of lead (cerussite) is soluble in 7,144 parts of water saturated with carbonic acid.<sup>4</sup> In conversion 100 parts by weight of sulphide of lead become 126.78 of sulphate, and this in turn 111.71 parts of carbonate of lead.<sup>5</sup> The increase

<sup>1</sup>Allgemeine Geologie, p. 59. Berlin, 1879.

<sup>2</sup>Percy's Metallurgy of Silver and Gold, Part I. London, 1880.

<sup>3</sup>Chlor-, Brom- und Jodverbindungen des Silbers in der Natur, p. 40. Dr. Fr. A. Moesta. Marburg, 1870.

<sup>4</sup>Percy's Metallurgy of Lead, p. 40. London, 1870.

<sup>5</sup>J. Roth, op. cit., p. 243.

in volume from sulphide to carbonate is 28.13 per cent. Such changes of weight and volume might account for the prevailing sandy condition of the carbonate ores. It may be assumed that they were once comparatively solid masses of galena, and during these transformations occupied, first a larger, then a smaller space, thus leaving interstices between the minute crystals of cerussite of which the sand carbonate consists. In the presence of phosphoric acid and alkaline chlorides, sulphate of lead may be transformed into pyromorphite. Sulphate of zinc is readily transformed into carbonate, and, as a further stage of alteration, finally becomes a silicate.

Sulphate of protoxide of iron may become carbonate in the presence of earthy carbonates. Carbonate of protoxide by oxidation and hydration becomes hydrated sesquioxide or limonite, which on loss of its water becomes hematite; the latter in contact with organic matter may be reduced to the protoxide or magnetite.

The sulphate of the protoxide may by oxidation change directly to sulphate of sesquioxide or basic ferric sulphate, which in turn becomes limonite and hematite.

The fact that carbonate of iron is so rarely found in the Leadville deposits would suggest that their limonite might have been formed in the latter way, and that the basic ferric sulphates, of which analyses are given above, may have been formed directly from the sulphide.

*Agents of alteration.*—The alteration having taken place through the agency of waters coming from the surface, it remains to consider whence they may have derived the substances which would have facilitated the alteration of the sulphide. Surface waters in general are said to carry a certain amount of atmospheric oxygen, of organic matter, of chloride of sodium, and of phosphoric acid. An analysis of surface water at Leadville, taken from the reservoir in Big Evans gulch, was found by Mr. Hillebrand to contain, in a million parts,  $K_2O = 1.12$ ,  $Na_2O = 1.92$ ,  $SO_3 = 7.20$ , and  $Cl = 1.14$ .<sup>1</sup>

Of the rocks through which they may have passed, out of eight eruptive rocks analyzed, six were found to contain phosphoric acid and five

---

<sup>1</sup> The Delaware River at Trenton contains 1.20 and two glacier streams in the high Alps an average of 0.4 Cl in 1,000,000 parts.

chlorine. Traces of phosphoric acid were found in both of the limestones analyzed. In the Lingula shales, which directly overlie the Blue Limestone, 5.14 per cent. phosphoric acid was found in the portion containing casts of Lingula and 0.35 per cent. in that free from these casts. Chlorine was found in each of the sixteen specimens of dolomitic limestones, from different horizons and localities, that were tested for that substance. Bromine and traces of iodine have also been detected, but they exist here, as in sea-water, in far smaller proportions than chlorine. Organic matter is found abundantly in most of the rocks of the Carboniferous formations. The specimen of Blue Limestone analyzed gave only 0.03 per cent., but in the overlying Weber Grits not only are there frequent beds of carbonaceous shales, passing at times into actual coal, but the sandstones sometimes contain as high as 4 per cent. of carbonaceous matter.

*Relative richness of galena and cerussite.*—The greater richness in silver of galena over cerussite in this region is very noteworthy. Mr. L. D. Ricketts,<sup>1</sup> who made a detailed study of the ores of Carbonate Hill, states that the average tenor of cerussite in that locality is less than 40 ounces of silver to the ton, while galena averages 145 ounces of silver to the ton. He also states that assays of five galena nodules, and of the carbonate crusts on each, showed that in proportion to the amount of lead present there was six times as much silver in the galena as in the cerussite. Table XIV, Appendix B, which gives the assays of various specimens of ores, vein materials, and adjoining country rocks collected during the investigation, shows a similar relation in the silver contents of galena (No. 15) and of its cerussite crust (No. 16), 420 ounces and 28.6 ounces, which are in even greater contrast than in the cases cited above.

The fact that silver is found disseminated throughout the vein materials and adjoining country rocks, even where little or no lead is found, shows that during secondary alteration silver has been further removed from its original locus and more widely disseminated than lead. In fact, it may be assumed that the outlines of the present bodies of lead ore vary but little from those of the original deposits, but it would hardly be safe to make such an assumption in regard to silver ores. It is apparent that this

---

<sup>1</sup>Ores of Leadville, p. 87. Princeton, 1883.

relative distribution of the two metals was brought about by surface waters, and is therefore dependent on the relative solubility of the combinations of the respective metals formed during alteration.

Silver sulphate is probably more soluble than either the sulphate or the carbonate of lead, but, as it is not known to occur as a mineral, it cannot be assumed that silver necessarily passed through sulphate during its change from sulphide to chloride.

The chloride of silver is said to be insoluble in pure water at ordinary temperatures, but Vogel<sup>1</sup> and Hahn<sup>2</sup> have shown it to be soluble to a certain extent in the alkaline chlorides. According to Stas,<sup>3</sup> it is, in a measure, soluble in pure cold water, its solubility varying according to its physical condition and the temperature. Its solubility is greatest when in the flaky state, as precipitated in the cold from a sufficiently dilute solution of silver, and diminishes as the flakes shrink. It is precipitated from the solution by the addition of an alkaline chloride. Still further evidence of its solubility is afforded by the occurrence of the mineral Huantajayit, discovered by Raimondi in Peru,<sup>4</sup> which consists of 11 per cent. Ag Cl and 89 per cent. NaCl. According to Sandberger, this is readily soluble in a little water, but an excess of water produces a precipitation of the chloride of silver. It may therefore be assumed that chloride of silver is soluble in surface waters under certain conditions, but is very readily precipitated from its solution.

Although the statements given above as to the relative solubilities of lead and silver salts are not so definite as might be wished, the fact of the relatively greater richness of galena over cerussite in these deposits seems so well established as to justify inverse reasoning, namely, the deduction of an argument in favor of the greater insolubility of the lead salts. It might be assumed from Stas's experiments that freshly-formed chloride of silver (flaky) would be more soluble than carbonate of lead, but that after the lapse of sufficient time the latter might become more soluble than the chloride of silver, especially in water charged with carbonic acid.

Outcrop deposits richer than those in depth.—There is a fair foundation for the generalization that in the deposits, as developed at the time of this investigation, the ores were growing poorer in silver as exploration extended far-

<sup>1</sup> Wagner's Jahres-Ber. 1874, 22, p. 481.

<sup>2</sup> Trans. A. I. M. E., 1873-'74, p. 99.

<sup>3</sup> Compt.-rend., 1870-'73, p. 993.

<sup>4</sup> Neues Jahrb. f. Mineralogie, 1874, p. 174.



ther from the surface. In the case of the Iron mine the statement to this effect by those in charge of the mine was supported by actual figures; in other cases it was an opinion founded on general observation, which was still worthy of credence. Whether it will continue when the unoxidized deposits are reached remains to be proved.

A ready explanation for this condition of things may also be found in the relative solubility of the products of alteration and in the fact that the deposits near the present surface may be considered to be simply the relics of larger deposits, gradually removed by erosion as the alteration by surface waters went on. The original deposits may be assumed to have been a mixture of galena, pyrite, and blende in proportions which, while subject to a wide local variation, would bear a certain average relation throughout the region. Given a ton of this mixture, by the alterations which have been above noted it would probably decrease in weight, though its volume might remain sensibly the same; zinc and iron would be removed as soluble sulphates, the former in greater part, the latter in very appreciable amount, and their volume would be replaced in part by the increase in volume of the lead during its transformation into carbonate, in part also by silica and earthy bases brought in mechanically by the waters. Although silver salts have been assumed above to be, in this case, more soluble than those of lead, they are much less so than those of iron and zinc, and a relatively small proportion of the silver would have been removed from the given ton of ore. The space formerly occupied by this ton of ore would, therefore, be occupied by oxidized material weighing much less than the original ton, but which would contain, in proportion to that weight, more lead and silver and less zinc and iron. In accordance with this explanation, the proportion of lead to the ton of ore should also decrease in depth as a general average of the district.

Again, as by gradual erosion the deposits—say, for instance, those in the easterly-dipping beds of Carbonate and Iron Hills—approached the surface, actual surface waters running down along the dip would meet bodies composed mainly of carbonate of lead and chloride of silver. If carbonate of lead is soluble in water containing free carbonic acid, the portion thus dissolved would be carried away entirely, for in their continued passage through limestone it may be assumed that the waters would preserve their

excess of carbonic acid. The chloride of silver, on the other hand, might be assumed to have become insoluble in the long time that had elapsed since it was formed; or, if any were taken up, it would probably be thrown down again in a short distance by a slight change in the character of the descending solutions. Thus a gradual increase in the proportions of silver over lead would be taking place in the zone which was being brought by the erosion of overlying rocks nearer and nearer to the surface.<sup>1</sup>

#### COMPOSITION OF VEIN MATERIALS.

In the remaining vein materials, which constitute the relatively valueless portion of the deposits, iron and manganese, generally in the form of hydrated oxides, are the most prevalent metals. Carbonate of iron is very rarely found, and pyrite never among the oxidized ores. The comparative absence of zinc has already been remarked, yet this metal is quite uniformly detected in the products of smelting. Arsenic and antimony are

<sup>1</sup> In a paper read at the Chattanooga meeting of the American Institute of Mining Engineers in May, 1885, by Mr. F. T. Freeland, superintendent of the Iron Silver Mining Company, the following analyses are given of sulphide ore from the Minnie mine, situated on the southeast slope of Iron Hill, adjoining the Colonel Sellers, made by William R. Boggs, jr. They are interesting as showing the relative distribution of silver in the different components of the unoxidized ore:

	I.	II.	III.	IV.
	Galena.	Blende.	Pyrite.	Mixture.
Pb.....	72.65	6.71	2.21	50.80
Zn.....	5.66	55.08	14.24	12.86
Fe.....	1.60	4.00	35.40	0.30
S.....	15.66	32.44	44.76	24.50
Ag (ounces).....	(41.5)	(94.5)	(4.5)	(11.5)
Ag (per cent).....	0.14	0.324	0.014	0.039
Au.....	Trace	Trace	.....	Trace
Residue.....	4.12	0.92	2.70	1.88
Total.....	90.83	99.474	99.324	99.439

His mixture, calculated from the relative amounts of Pb, Zn, and Fe, in column IV, would consist of a little less than three parts of galena to one each of pyrite and blende. The tenor of silver given for this mixture is, however, only a little over a quarter of what would result from a mixture in these proportions of these three minerals, each having the tenor in silver given in its separate column. It seems doubtful, therefore, if these separate values can be taken as a fair representation of the average tenor of the different sulphides in the ore. That given for zinc blende is evidently abnormally high, as may be seen on comparison with the pyrite column. This pyrite contains an admixture of about one-fifth of its weight in zinc blende, and if this zinc blende ran as high in silver as that given in column II, this fifth alone would yield nearly 20 ounces of silver, whereas the whole mass is said to contain only 4½ ounces. The silver tenor of the galena, on the other hand, represents a fair average of the galenas found in the older mines, though these, as is shown by the assays in Appendix B, vary very much and may contain over ten times as much silver as this.

only accessory constituents in either ore or vein material. The composition of some of the typical forms of vein material, taken from Table X, Appendix B, is given below.

*Vein materials.*

No.	Name.	Locality.	Insoluble.	FeS <sub>2</sub>	Fe <sub>2</sub> O <sub>3</sub>	MnO <sub>2</sub>	ZnO	CaO	MgO	CO <sub>2</sub>	H <sub>2</sub> O and ignition.	Ag	Au	Total.
1	"Hard Carbonate."	Scooper mine.	80.06	.....	13.91	0.10	.....	.....	.....	.....	5.978	0.012	Trace	100.00
2	Siliceous hematite.	Chrysolite mine.	8.20	.....	54.14	22.36	2.56	.....	.....	.....	12.709	0.031	None.	100.00
3	"Iron ore" ...	Kenosha mine.	21.10	.....	7.70	65.98	1.00	.....	.....	.....	4.22	0.012	None.	100.00
4	Pyrite nucleus.	No Name gulch.	7.36	53.61	34.44	.....	.....	.....	Trace	.....	.....	.....	.....	.....
5	Dark intermediate zone.		16.36	.....	73.42	.....	.....	.....	0.09	*Trace	10.13	.....	.....	.....
6	Light outer zone.		54.28	.....	39.84	.....	.....	.....	0.06	*Trace	5.82	.....	.....	.....
7	Altered limestone	Garden City mine.	10.08	.....	0.81	0.39	.....	27.17	19.49	42.78	.....	.....	.....	100.72
8			dark	20.02	.....	0.97	1.56	.....	24.15	16.71	37.37	.....	.....	.....
9	Chert nodule.	El Paso mine.	96.3	3.06 per cent. soluble in solution of potassium hydrate, remainder chiefly Fe <sub>2</sub> O <sub>3</sub> and Al <sub>2</sub> O <sub>3</sub> .										
10	Chert under ore body.	Little Pittsburgh mine.	97.9											
11	Granular quartz under ore body.	Waterloo mine.	81.29	3.93 per cent. soluble in solution of potassium hydrate, remainder chiefly Pb, CO <sub>2</sub> , and Fe <sub>2</sub> O <sub>3</sub> .										
12	Porphyry breccia, with ore cement.	Evening Star mine.	84.2	Cement chiefly pyromorphite, with some cerussite and galena and a little calcite.										

\*SO<sub>3</sub>

<sup>b</sup>SiO<sub>2</sub>

No. 1 is a cavernous red rock, with slightly greasy luster, which, though containing only a trace of lead carbonate and too little silver to pay for working, is yet classed as "hard carbonate" from its outward appearance, this miner's term being quite elastic in its application. It is mainly silica, combined perhaps in part with oxide of iron. Rock from this same mine, of quite similar appearance, but with a few delicate crystals of cerussite and horn silver lining the cavities, constitutes a very rich ore.

No. 2 is a dark-colored "iron ore," intermediate between the black iron and the jaspery iron of the Fryer Hill mines. It contains a rather unusual percentage of zinc, and its silica contents are much lower than

its outward appearance would indicate. Both contain a little antimony, and the former a little  $PbO$ , which were not determined quantitatively. Both contain also a small percentage of silver, but not enough to constitute pay ore.

No. 3, though classed as an iron ore by the miner, is more properly an ore of manganese.

Nos. 4, 5, and 6 are given to illustrate the different stages in the alteration of pyrite, which would lead to the above vein materials. The specimen was obtained at some distance from Leadville, it not being possible to find any pyrite in the mines themselves; it occurs, however, at the Blue Limestone horizon and in analogous conditions to the Leadville ores, except that no rich silver-lead ores had yet been found at the locality. No. 4 is the comparatively unaltered pyrite nucleus; No. 5, the inner zone of alteration; and No. 6, the lighter-colored outer zone. Only traces of sulphuric acid are found in either. The percentage of metallic iron has slightly increased from No. 4 to No. 5, as has that of insoluble matter; sulphur alone has, therefore, been removed, probably as sulphate of lime. From No. 5 to No. 6 iron has disappeared rapidly and been replaced by insoluble material; it has presumably been carried away largely as hydrated oxide, which is probably commencing to replace the carbonates of lime and magnesia in the adjoining rock. The rapid increase in insoluble matter could not, it would seem, be entirely original matter, but must in part have been brought in by the decomposing waters. The conditions here may be contrasted with those which probably existed where the basic ferric sulphates above described were formed. In the latter case the decomposition probably took place within the mass of a large body of metallic sulphides; here it was a small amount of sulphide in direct contact with the country rock, and free oxygen would have been present in relatively greater proportion, so that the sulphide would have been more readily decomposed by the oxidation of the iron.

Nos. 7 and 8 represent the early action of waters coming from such a decomposition upon the country rock, in this case a fragment of Blue Limestone found on the south slope of Iron Hill, near the fault. No. 7 is the lighter portion, No. 8 the darker, in which the replacement has apparently

proceeded much farther. In the latter the oxides of iron and manganese have increased only slightly in amount, and the decrease in carbonates is mainly supplied by the increase in silica, an increase which, as in the former case, must be mainly accounted for as coming from an extraneous source; it was probably taken up by the waters in their passage through the porphyry.

Nos. 9, 10, and 11 represent the most silicious forms of vein material, comparatively free from bases. Nos. 9 and 10 are the black cherts so common in the ore bodies, and 11 the granular quartz which frequently replaces it, especially on Carbonate Hill. In each the silica is still partly soluble in a moderately strong solution of potash. Besides silica the two former contain iron and alumina and probably a little organic coloring matter. These cherts are thoroughly compact and generally form barren streaks or floors in the ore bodies; sometimes, however, chloride of silver is found coating their cleavage surfaces. The granular quartz, on the other hand, which is very porous, frequently contains crystalline cerussite partly filling the minute cavities and then constitutes an ore, though, as in the present case, it is liable to be mistaken in the hand specimen for a white quartzite.

No. 12 is the breccia of White Porphyry in the small ore-body which was found above the Blue Limestone horizon, just west of the small dike in the Evening Star ground. The percentage of silica is above the normal, showing that the ore-bearing waters have removed a portion of the bases. In the cementing material galena is altered partly to pyromorphite, partly to cerussite, and the calcite may indicate that the ore-bearing solutions reached here after passing along the limestone contact or may simply result from the decomposition of the porphyry.

The assays of vein material and limestones in Table XIV, Appendix B, show that all the specimens tested carry silver in appreciable amounts, though in the case of limestones which were gathered in the various mines, and in that of the Breece Iron ore, the tenor in silver is much less than is generally credited to those used as flux by the smelters. They are such amounts as might be expected to have been carried into them by the surface waters after leaving the ore bodies.

*Kaolin and Chinese talc.*—These names are given in the mines to certain substances, evidently alteration products of porphyry, occurring with great persistency along the contact of limestone and porphyry, where they sometimes form the only vein material, and also within the ore bodies, sometimes at quite a distance from the contact. In the latter case they probably result in most cases from small offshoots of the porphyry, such as have been mentioned as occurring in the Little Pittsburgh mine, and, as are shown in Fig. 1, Plate XXII, penetrating the as yet unaltered limestone. The characteristic Chinese talc is compact, with conchoidal fracture, somewhat translucent, with a sort of opalescent luster, and is easily cut by the fingernail when fresh, but becomes opaque and hardens on exposure to the air. White when pure, it is generally more or less discolored and veined by oxides of iron and manganese. The miners often carve it into pipes and figures. The so-called kaolin is white, opaque, and generally plastic, but also hardens on exposure. No true kaolin was found among the specimens collected. In the following table, I and II would be considered kaolins, and III, IV, and V, Chinese talcs. VI, VII, and VIII are specimens from the Lower Waterloo mine, contributed by Mr. L. D. Ricketts; in spite of their different composition, they are not to be distinguished in the hand specimen from the Chinese talcs.

*Kaolin and Chinese talc.*

Mine.	SiO <sub>2</sub>	Al <sub>2</sub> O <sub>3</sub>	Fe <sub>2</sub> O <sub>3</sub>	FeO	ZnO	CaO	MgO	K <sub>2</sub> O	Na <sub>2</sub> O	H <sub>2</sub> O	SO <sub>2</sub>	PrO <sub>2</sub>	Totals.
I. Amie .....	48.72	34.01	0.56	0.60	.....	.....	1.11	0.88	0.67	4.42	.....	.....	100.03
II. New Discovery .....	43.66	37.78	.....	.....	.....	0.22	0.30	Trace	Trace	17.05	Trace	.....	99.91
III. Big Pittsburgh .....	4.55	35.60	2.26	.....	.....	Trace	Trace	2.73	5.28	15.05	34.55	.....	100.02
IV. Morning Star .....	24.47	38.05	0.93	0.77	.....	0.23	0.30	2.72	1.30	16.07	15.48	0.23	101.15
V. Swamp Angel .....	27.89	33.79	.....	.....	.....	0.53	1.14	2.83	1.56	16.51	15.75	.....	100.00
VI. Lower Waterloo .....	35.33	10.38	.....	.....	33.05	1.62	0.71	.....	.....	19.06	.....	.....	100.15
VII. ....do.....	35.07	8.81	.....	.....	35.40	1.87	0.80	.....	.....	17.46	.....	.....	100.31
VIII. ....do.....	37.54	24.76	0.64	.....	18.43	0.63	0.71	0.66	0.36	10.37	.....	.....	100.10

The compositions given above show that these substances are mixtures of hydrated silicates of alumina, with more or less sulphate of alumina, which, in the case of the last three, is replaced by silicate of zinc. As is generally the case with such alteration products, it is difficult to consider them distinct minerals. The occurrence of zinc in the last three is some-

what unexpected. Of the others, III is perhaps the most abnormal. In the mine it was a pure white, extremely plastic mass, which could be molded like plaster or potter's clay, and became quite hard on exposure to the air. Sulphuric acid is a very common constituent of these substances, having been found qualitatively in each one of five other specimens taken from widely separated parts of the district. Where the substance occurs in the immediate vicinity of an ore body this acid may be readily conceived to have come from the oxidation of the metallic sulphides; but in the case of those occurring on barren contacts, far away from any known body of metallic minerals, as is the case with V, it would seem that their formation might date back to the passage of the sulphurous waters which brought in the original ore deposits.

**Lime and magnesia salts.**—Although lime and magnesia are found in small quantities in both ores and gangue materials, it is rather remarkable, when one reflects that the country rock is a dolomitic limestone, that their minerals are so uncommon. Calcite occurs as incrustation on crevices and lining cavities or druses in the iron, but never in any large amount. Gypsum is rarely found, although it seems evident that it must have been one of the most important products of alteration. It must therefore be assumed that, owing to its ready solubility, it has been entirely carried away.

**Barite.**—Barite, or heavy spar, is a not uncommon constituent of the gangue, but it is very irregularly distributed. It generally occurs in aggregations of tabular crystals, frequently concentrated in considerable masses, and more or less stained by iron oxide. Chloride of silver is generally found associated with it. This association of barite and chloride of silver is noteworthy. Among the miners the presence of the former mineral is considered a sure indication of rich chloride ore. In this connection it is interesting to recall Miller's experiments, mentioned by Sandberger,<sup>1</sup> showing that sulphide of barium dissolves pyrargyrite, or ruby silver, without decomposition. The frequent presence of antimony in the ores and vein materials renders it probable that a part of the silver may have originally existed as ruby silver. Moreover, although there are no experimental proofs, it is probable that waters containing sulphide of barium would dissolve the

<sup>1</sup> Neues Jahrbuch für Mineralogie, 1869, p. 309.

sulphide, or sulpho-salts, of silver under the conditions of time and supply which probably prevailed during the process of decomposition of the original ore deposits. From such a solution the chlorine in the limestone might have precipitated the silver at the same time that the sulphide of barium was transformed into sulphate.

**Manganese.**—Another empirical generalization of the miners in this region is that, where a large amount of manganese is found in the iron vein material, rich chloride deposits are likely to be found in the immediate vicinity. It is worthy of note in this connection that barium is a most frequent constituent of manganese ores. The fact that the oxides of manganese when treated by hydrochloric acid evolve chlorine is also suggestive. If it is assumed that silver in its passage from sulphide to chloride passes through sulphate, and that hydrochloric acid was formed in the surface waters, say, by the action of sulphuric acid formed in some of the reactions that may have taken place, the presence of manganese oxide would favor the liberation of chlorine, which, in turn, would form chloride of silver from the sulphate when the latter came in contact with carbonate of lime, and the lime be carried away as sulphate.

#### ORES DEPOSITED AS SULPHIDES.

That the ores were originally deposited as sulphides would legitimately be assumed, from the almost universal observation in nature that such oxidized ores pass into sulphides in depth. So generally is this accepted as a rule in ore deposits that it would require special demonstration to prove beyond a doubt that the native metals or their oxides and chlorides (except perhaps gold, tin, and the platinum group of metals) are in any particular case original, and not the result of secondary alteration from sulphides. Analogy with the deposits in the neighboring Ten-Mile district affords more direct evidence in favor of this assumption. Moreover, since the completion of the field work of this investigation, explorations on the dip in Carbonate and Iron Hill have proved that the oxidized ores actually do pass into sulphides. As yet no systematic description of these sulphide deposits has been published from which it may be learned whether the metals exist exclusively as sulphides, but in the absence of any statement to the contrary it seems fair to assume that such is the case.



It remains, then, to consider the possible reactions which may have brought about the deposition of ores under the circumstances and in the manner assumed above; and in considering these it must be borne in mind that it is not possible to reproduce in the laboratory all the conditions that may have prevailed at the depths within the earth's crust at which these deposits were formed, and that therefore reactions may have taken place and combinations may have been formed under these conditions which, from laboratory experience alone, might not be deemed possible.

The sulphides of the heavy metals may be precipitated, according to Roth,<sup>1</sup> from various solutions: first, where they exist as sulphides, by sulphides of the alkalis and alkaline earths; second, where they exist as carbonates and sulphates, when they come in contact with solutions containing the alkalis and alkaline earths or sulphureted hydrogen; third, where they exist as sulphates, which in contact with organic matter are reduced to sulphides. The metallic sulphides are soluble in waters containing alkaline sulphides or sulphureted hydrogen, and silica and the earthy bases in water containing alkaline carbonates. Solfataric waters (that is, hot waters charged with mineral matter arising from some unknown source below) are known to contain sulphureted hydrogen and the alkaline sulphides and carbonates. On the supposition that the metals of these deposits came up from the unknown source below or were derived from pyrite and galena in neighboring rocks, it might be assumed that the iron and lead at least were actually brought in as sulphides; in this case, however, it is somewhat difficult to conceive the reaction by which the sulphides should replace the carbonates of lime and magnesia, and, so far as laboratory experience teaches, it would seem necessary that the carbonates should have already been dissolved out and carried away before the sulphides were deposited. This apparently involves the pre-existing cavity theory. It is, however, conceivable that the dissolving out of the former so immediately preceded the deposition of the latter that the process was practically an interchange of substance for substance, or the commencement of a change from sulphide to sulphate may have taken place in presence of the carbonate, and

---

<sup>1</sup> Allgemeine Geologie, p. 563.

the sulphate have been immediately reduced to sulphide again by organic matter or other reducing agency.<sup>1</sup>

That the direct replacement of the dolomite by sulphides is not impossible, however, seems proved by the fact that galena, zinc blende, and pyrite are found in nature as pseudomorphs after calc spar,<sup>2</sup> and the last two, also, as pseudomorphs after dolomite.<sup>3</sup> The sulphates of the metals are more or less soluble in water, especially when it contains some free sulphuric acid. Their reduction to sulphide through the agency of organic matter is a matter of common observation.

The reactions by which the Leadville deposits might have been made from solutions carrying the metals as sulphates are more readily conceivable. In contact with dolomite containing organic matter the sulphates would be reduced to sulphides with the formation of carbonic acid. The waters thus charged with an excess of carbonic acid would dissolve and remove the carbonates of lime and magnesia, which would be replaced by the metallic sulphides. Any excess of sulphuric acid would form soluble sulphates of lime and magnesia, which would also be carried away. If these sulphates were reduced to sulphides they would render the waters more capable of dissolving out the dolomite.

The metals might have been taken up in the form of sulphates by waters percolating through rocks, where they might have been brought into this combination by the oxidation of sulphides or by the decomposition of silicates. It might also be conceived that during their passage these sulphates would be reduced to sulphides by contact with organic matter before they reached the locus of the deposit.

The most important objection to the hypothesis that the metals were brought in as sulphates is that the lead sulphate is so insoluble compared with that of iron or zinc; and yet the amount of galena in the ores was probably greater than that of zinc blende.

Sulphide of barium would be precipitated as sulphate of baryta in contact with the limestones, owing to its relatively greater insolubility than the sulphates of lime and magnesia.

---

<sup>1</sup>J. Roth, *Allg. Geologie*, p. 235.

<sup>2</sup>J. Roth, *op. cit.*, p. 171.

<sup>3</sup>J. Roth, *op. cit.*, p. 184.

Silica, when brought in by waters containing alkaline carbonates, in which it is notably soluble, might form silicates of the alkalies, the carbonic acid of the latter serving, as suggested in the case of sulphides, to render the waters capable of carrying away the earthy carbonates. Later the combined alkalies might be in part replaced by other bases, such as oxide of iron, and in part actually dissolved out, leaving free silica.

## MODE OF FORMATION.

It has been assumed that the ores of this region were originally deposited, first, from aqueous solutions; secondly, by a metasomatic interchange<sup>1</sup> with the country rock; and thirdly, in the form of sulphides. Direct evidences of processes which went on in former geological epochs at great depths below the surface are necessarily difficult to obtain, especially where, as in the present case, the field of observation was confined to material which has been more or less altered since those processes had ceased. It is therefore necessary in the commencement to assume the more probable among possible processes, and then to see to what extent the assumed process may be reconciled with observed facts.

The agencies by which mineral matter may be carried from one place to another within the earth's crust are heat and water, or a combination of the two. It was only in the very infancy of geology that heat alone was seriously admitted to be a possible agent for the formation of mineral deposits in depth. The nature of such deposits was soon found to be such as to preclude the possibility that they might have resulted from the consolidation of a fused mass. Sublimation, on the other hand, as a means of forming such mineral masses, involves a combination of heat, pressure, and water, and may therefore in one sense be considered to be a form of aqueous solution. Its practical demonstration, however, is confined to laboratory experiments, which can at best be but an imperfect imitation of the process of nature. The removal of the materials of which ore deposits are formed by the agency of water alone may be observed to be going on in nature at the present day. Hence this agency, to which, under the comparatively un-

---

<sup>1</sup> By metasomatic interchange is meant an interchange of substance, without necessarily involving, as does pseudomorphism, the preservation of the original form of the substance replaced or even of its original volume.

known conditions which prevailed where deeper-seated deposits were formed, a certain amount of heat may have been added, is the one adopted by the majority of students of vein phenomena to account for the removal of the vein materials from place to place within that portion of the earth's crust that comes under our observation.

That it was from aqueous solutions that the Leadville vein materials were deposited is a necessary corollary of the assumption that the deposition took place as a metasomatic interchange between them and the country rocks, since the various materials of which they consist could have been brought in and the dolomite and other rock substances have been removed only by the agency of water. A further necessary corollary of the metasomatic interchange is that the ores were not deposited in pre-existing cavities, as is generally assumed to be the case in ore deposits, particularly those in limestone. The three assumptions being thus interdependent, evidence in favor of either may be considered, in so far, a proof of the others, and it will not be necessary to consider them separately. Direct evidence that the original sulphides in the region were deposited in this manner is necessarily difficult to obtain, where secondary alteration has gone so far as it has in Leadville; but indirect and negative evidence is abundant. When the unoxidized deposits have been thoroughly opened by future explorations, so that it will be possible to study them in their unaltered and original condition, an opportunity will be offered for testing the correctness of the deductions here made.

*Indirect evidence.*—In their present condition there can be no doubt that the ore bodies are a replacement of the country rock. In the case of the limestone deposits they grade off gradually into the country rocks, the only regular outlines of the bodies being those which are formed by the contact of the limestone with the adjoining porphyry; the other outlines are irregular and ill-defined. Not only are fragments of unaltered limestone found entirely inclosed within the ore bodies, but the latter sometimes occupy the entire space between surrounding sheets of porphyry, which the geological structure shows must have been formerly occupied by the original limestone bed. The chemical analyses of the ores and vein materials given above show lime and magnesia to be constant constituents,

decreasing proportionally from the outer limits of the body toward its interior. When these substances are in sufficiently large proportion to be visible to the eye, they are seen to be, not in the crystalline condition in which they would be expected to be if they were brought into a pre-existing cavity and then deposited, but in the same granular condition in which they exist in the country rock. Although it may be said that the present outlines of the oxidized ore bodies are not necessarily the same as those of the original sulphide deposits, it is probable, from the study that has been made of the processes of alteration, that they preserve a general proportion and relation to those outlines, and do not vary from them sufficiently to invalidate the deduction that the original deposits could not have been made in open caves. The deposits in rocks other than limestone consist of metallic minerals and of altered portions of the country rock, in which the structure of the latter can sometimes be still traced, and are not the regular layers of matter foreign to the country rock, which results from the filling of a pre-existing fissure or cavity by materials brought in from a distance and deposited along the walls.

In the case of the still unaltered sulphide deposits of Ten-Mile district, which may reasonably be assumed to have been formed in an analogous way, the arrangement of the particles of the original rock can frequently be seen to be preserved in the metallic minerals, which maintain a certain parallelism with the original bedding planes in the lines defined by minute changes in these minerals.

Negative evidence is afforded by the absence of that condition of things which would naturally be expected to exist if the ore bodies had been deposited in pre-existing cavities, as has been assumed to be the case by those who have contented themselves with this a priori assumption founded on the theory generally given in text-books, without taking time to study the phenomena as they actually exist. The common character of caves which have been dissolved out of limestone is that their walls are coated with a layer of silt or clay, which has been left undissolved by the percolating waters, and that these walls, where undisturbed, have a peculiar surface of little cup-shaped irregularities. There is also almost invariably an accumulation at the bottom of the cave of irregular fragments of limestone, which have broken off from its sides or roof. Observation shows us, more-

over, that deposits of mineral matter made in pre-existing cavities are in more or less regular layers, parallel with the walls of the cavity, and that where this approaches a spherical shape, even in a slight degree, these layers are concentric. The most perfect type of this arrangement is seen in the agates which fill geodes.

Were the ore bodies of Leadville the filling of pre-existing cavities, not only would it be expected that a certain parallelism within the walls or an arrangement in layers of their various mineral constituents should have existed, but these walls would have been defined by a distinct clayey selvage, all of which could hardly have been entirely obliterated by the secondary alteration which has taken place. Further, an examination of the outlines of these ore bodies afforded by the maps and sections shows the physical impossibility of their having once been open cavities. What would have supported the roofs of such broad continuous openings as they would represent, or, in cases where they occupy sensibly the entire space between two sheets of porphyry, why did these sheets not close together? Again, how could such cavities have been formed at the depth at which these deposits were originally formed, which it has been shown must have been about 10,000 feet below the rock surface?

The caves which now exist in the limestones of this region are of extremely recent origin, and, as has been shown, cut through limestone and ore bodies indiscriminately. The action of the surface waters which formed them is therefore not only recent, but more recent than that which produced the greater part of the secondary alteration of the ore bodies. Those who maintain that the deposits in limestone have necessarily been deposited in pre-existing cavities do not in all cases,<sup>1</sup> it is true, distinctly state that these cavities must have been formed by surface waters; but it yet remains to be proved that any of the caves which are so commonly found in limestones have been formed at any great distance from the surface. The majority certainly have not, and, since it is generally admitted that the power of easily dissolving limestones is acquired by the waters

---

<sup>1</sup> Prof. J. S. Newberry (School of Mines Quarterly, March 1880) distinctly states that the western deposits in limestone have been deposited in caves which, like the Mammoth Cave, were formed by surface waters, and that probably these deposits will prove of limited extent in depth, since the excavation of limestones "must be confined to the zone traversed by surface drainage."

from the free carbonic acid and organic acids which they take up at the surface, it seems probable that these would have been neutralized and the solvent power largely lost long before they could have reached depths comparable with those at which these deposits were formed.

#### ORIGIN OR SOURCE OF THE METALLIC MINERALS.

*Ascension or lateral secretion.*—The origin of the metallic contents of ore deposits has been, from the very earliest days of geology, a most fruitful theme of speculation and theorizing, probably for the very reason that so little has been done toward obtaining data, founded upon actual observations or experiments, to support one theory or exclude another. In the days of the bitter contests between Neptunists and Plutonists the supporters of either school allowed only the extreme alternatives, that the vein materials were washed into the veins from the surface (descension theory) or that they were forced into them in a molten condition from below (ascension theory). Probably in either case, in the heat of the contest, they went beyond the real opinion of the originators of the school, for it does not appear from the writings of Werner,<sup>1</sup> the father of the Neptunist school, that he himself went further than to maintain that veins were filled by deposit from solutions reaching them from above, without attempting to indicate the source from which these solutions derived their metallic contents. The idea of the original ascensionists, or more properly, injectionists, that the mineral contents of ore deposits could have been injected into their present position in a fused state, is so opposed to all observed facts that it has long since been abandoned; and probably no one would maintain that original ore deposits are derived from waters at present flowing on the surface.

There still remains a tendency among writers to separate themselves into upholders of modifications of one or the other of these original theories, but an impartial examination of their views shows that, so far as their foundation in well-ascertained facts or on legitimate deductions from these facts goes, there is really no great essential difference between them. Thus the French geologists, who, by the prominence given to the synthetic experiments of Sénarmont, Daubrée, and others, may be considered to be the

---

<sup>1</sup> A. G. Werner, *Nene Theorie der Entstehung der Gänge*. 1791.

legitimate inheritors of the ascension or injection theory, now modified into the sublimation theory, themselves admit that it is practically an aqueous solution, even if in a gaseous form, from which they derive the metallic contents of their deposits.<sup>1</sup> And among those who professedly maintain that most ores are probably deposited by percolating waters, but who would distinguish lateral secretion from ascension or descension, there is fundamentally so much held in common that differences seem slight.<sup>2</sup>

That *some* ore deposits have necessarily been deposited from solution is admitted by all geologists who have made special studies of the subject, and that the *greater part* of them have been so formed is maintained by a large and ever-increasing class. Geological investigations have also shown that within the rocks forming the crust of the earth, so far as observation has yet reached, there is a constant circulation of waters carrying more or less mineral matter in solution, and that no rock is absolutely impermeable. There are therefore both upward and downward currents, it being generally assumed that the latter are surface waters sinking under the influence of gravity and the former the same waters rising under that of the internal heat of the earth. It will be readily apparent, however, that such movement is not necessarily vertical in either direction, but will take its immediate direction from the character of the rock mass through which it is passing; that there will be a tendency of waters, filling capillary passages and minute fissures, to seek larger channels on joint, fault, and stratification planes, along which their movement will be more free; further, that, in case of waters passing along such channels and carrying mineral matter in solution, this mineral matter will be deposited where the conditions of the inclosing rock are such as to favor a chemical precipitation or interchange, and that such precipitation will be most abundant where for any cause there is some

---

A. de Lapparent, *Traité de Géologie*, p. 1170. Paris, 1883.

<sup>2</sup> Thus Joseph Le Conte, in his article on the Genesis of Ore Deposits (*Amer. Jour. of Sci.*, May, 1883), while devoting much space to disproving the theory of Sandberger, as exposed in his recent *Researches on Ore Deposits*, is really of the same opinion as the latter on most essential points. The main point of difference between the two appears to be that, while Le Conte maintains that the phenomena of Steamboat Springs and Sulphur Bank, where deposits are actually going on at the present day, should be taken as a type of all deposits and may serve as a basis for a general theory, Sandberger considers them exceptional cases and their conditions not necessarily the same that prevailed with deposits formed at a great depth below the surface.



interruption in the regular flow of the current, as rapidly moving waters deposit much less readily than those whose movement is very slow.

Admitting the above conditions, it would seem, a priori, impossible to assign any general direction of movement to currents from which ores are deposited, and that each individual deposit must be studied by itself in order to determine, by its geological relations, from which direction the depositing solutions probably came. The admission that ore bodies have been deposited by currents of circulating waters logically involves the admission that they may have been upward, downward, or lateral currents, according as the conditions at time of deposition favored either direction of approach to the locus of deposit. While the determination of this direction in a special district is of the utmost importance from an economical point of view, since by it the explorations for the continuation of ore bodies must be largely guided, its theoretical importance as bearing upon the general question of the origin of ore deposits seems to have been hitherto much exaggerated.

**Source of metals.**—In speculations as to the source from which the metallic contents of ore deposits are derived, a distinction should also be made between the immediate and the ultimate source.

The ultimate source is as much a purely speculative matter as the nebular hypothesis. Since according to this hypothesis the earth in its present condition is the result of gradual cooling from an incandescent mass, and since moreover the specific gravity of the rocky crust which is exposed to observation is very much less than that of the whole mass of the earth, it is a legitimate conclusion that the heavy metals must be in much larger proportions in the interior of the earth than in the rocky crust. Although this view is generally admitted by geologists at the present day, it is evident that its basis is somewhat negative, since, like the nebular hypothesis upon which it is founded, it cannot be proved in the present state of science by actual experiment or observation. Volcanic emanations and thermal springs have been found to contain metallic minerals, as have also the waters of the ocean, but it cannot be stated definitely from what depth they have come in the former case, nor whether, in the latter case, they may not have been ultimately derived from the same indefinite, deep-seated

source. It would seem proper, therefore, in a practical treatise like the present, to leave out of consideration altogether the ultimate and purely speculative source and to confine the investigation to the more immediate source, about which it is possible to obtain some actual and demonstrable evidence.

As circulating waters must take up as well as throw down their metallic contents, it is evident that under varying conditions the same material may have been deposited more than once and in more than one form since it reached that part of the rocky crust of the earth which is open to actual observation. There may be, therefore, intermediate sources between the ultimate and the immediate, but which, like the ultimate, are removed from actual demonstration.

It is common practice to say of any ore deposit, not distinctly sedimentary, that it has *come from below*, and to rest content with this statement, which, even if not susceptible of direct proof, has the merit that in one sense it cannot be disproved. This practice evidently had its origin in the fact that early writers upon ore deposits used as the type deposit, upon which to found their theories, the nearly vertical fissure vein. This they assumed to be the filling of a pre-existing open crack, extending indefinitely toward the center of the earth, by heated solutions arising from great depths; as these solutions approached the surface of the earth and were consequently relieved of the great pressure to which they were subject in the depths, by reason of that relief they gradually deposited their contents on the walls of the fissure until it was completely filled. While under the theoretical conditions assumed this hypothesis might afford an adequate explanation of the manner of deposition in such a vein, it is by no means proved that such conditions exist in nature, and therefore the explanation, so readily given in most cases, is generally inadequate and not founded upon a sufficient study of the geological conditions.

In the case of the Leadville deposits the inadequacy and even falsity of this explanation, except as applied to the ultimate source from which the metals may have been derived, is readily apparent.

In the first place, the geological study of the district has shown that they must have been formed beneath a thickness of at least ten thousand

feet of superincumbent rocks and an unknown amount of sea water. If they had been deposited from hot ascending solutions, as the result of a relief of pressure, it would naturally be expected that the bulk of the deposit would have been found in the upper part of this mass of rocks, where the pressure was least, instead of at its base.

Secondly, as at the time of deposit the sedimentary beds in which they occur were horizontal and relatively undisturbed, if the deposit had been made from ascending currents it would naturally be expected that the process of deposition should have acted from the lower surface of the beds upwards, instead of from the upper surface downwards, as is shown to have been the case in the Blue Limestone, which carries the bulk of the ores.

Thirdly, as far as present investigations have extended, there is a noticeable absence, in the region of greatest ore development, of channels extending downwards, through which the ascending solutions might have come. The vast majority of eruptive bodies are in the form of nearly horizontal sheets, parallel with the stratification. The few approximately vertical bodies that have come under observation afford no evidence that their walls form part of a channel through which the ore currents came up from below.

The above considerations seem sufficiently conclusive evidence against adopting upward currents as the direct source of the ore deposits of Leadville. The principal water channel at the time of deposition was evidently the upper contact of the Blue Limestone with an overlying porphyry, and from this surface they penetrated downwards into the mass of the limestone. It may be assumed, therefore, that the currents were descending under the influence of gravity, rather than ascending under the influence of heat.

It is well known that percolating waters circulate freely in every direction through massive or eruptive rocks, owing to the effect which cooling and weathering have of splitting them into irregular blocks, while in sedimentary rocks, however permeable, the bedding-planes are naturally the easiest for them to follow. If, then, at the time of deposition the prevailing direction of the ore currents had been downwards, it is easy to conceive that they would have descended freely through the overlying porphyry

masses and would have been diverted temporarily from a vertical to a horizontal course along the stratification plane of the first sedimentary bed they reached, and that, when this was a comparatively soluble rock like the dolomitic limestone of Leadville, they would eat their way gradually into it, either from this surface or from cracks through which they were here and there able to penetrate its mass. A downward current seems, therefore, to best suit the facts thus far observed with regard to the Leadville deposits. It might be objected that a downward current would not necessarily be hot, but it has been found by experiment and observation that metallic minerals may be taken up by cold water, though not so rapidly as by hot. Moreover, it is probable that the intrusive bodies retained for a long time sufficient heat to sensibly raise the temperature of waters coming in contact with them.

In looking, then, for the immediate source whence the waters by which these ores were deposited derived their metallic contents, which source should be within a limited distance of the locus of the deposits, since it cannot be supposed that the waters would travel for a great distance through rocks of varying composition without suffering considerable change in the material they held in solution, it would seem natural to consider the rocks in the vicinity of these deposits, and especially those overlying them.

*Metallic contents of country rocks.*—It was resolved in the early stages of the work to make a careful chemical examination of all the rock varieties of the region, as far as circumstances would admit, selecting comparatively unaltered rocks, which might be supposed to retain most of their metallic contents, and those sufficiently removed from any known ore channels to be free from the suspicion of having received these contents from the waters exuding from such channels.

This investigation was undertaken solely for the purpose of obtaining facts which might explain the condition of things existing in the region, and was conducted without the bias of any preconceived general theory. Indeed, in the opinion of the writer, our knowledge of the ore deposits of the world is still too limited and superficial to admit of the formulating of any generally and universally applicable theory. On the other hand, the weight of what may be considered actual evidence, as distinguished from

pure speculation, seems to be in favor of the lateral-secretion theory in its broader acceptation. Geologists whose acknowledged ability and wide experience give weight to their opinion have already made the generalization that the majority of the ore deposits, whether in crystalline or in sedimentary rocks, are found, if not in actual contact with, at least in the immediate vicinity of, eruptive rocks. The experience of the writer would lead him to qualify this generalization by adding that it is with the older and generally intrusive rocks of eruptive origin that valuable ore bodies are most frequently associated, while they are rare in regions where these rocks only form surface flows or are outpourings of actual volcanic vents. As there is no ground for assuming that the latter rocks would be freer from heavy metals than the former, the reason for these associations would have to be found in the fact that the older rocks have been exposed longer to the action of percolating waters and the deeper rocks have been more accessible to the waters containing materials that would readily dissolve the metals.

As regards the derivation of ore materials from neighboring rocks, G. Bischof, who has rendered most important services to geology in removing it from a speculative to an inductive basis, first gave an authoritative and decided opinion in these words: <sup>1</sup>“As a general consequence of the relations between the matrices of lodes, the rocks adjoining them, and their condition, as well as those between different lodes, it may be inferred that all the substances contained in the lodes have been derived from the adjoining rocks.”

Both Breithaupt<sup>2</sup> and von Cotta<sup>3</sup> admit the probability of this derivation, provided the existence of the vein materials in the country rock can be proved. Bischof had already proved this for the gangue materials, but his investigations had not been carried further, and the existence of the heavy metals in the country rocks still remained to be demonstrated. To this task Dr. F. Sandberger has devoted himself, as he tells us,<sup>4</sup> since 1873. Up to that time he had been an advocate of the ascension theory, but after having by careful analysis detected all the vein materials of a certain dis-

<sup>1</sup> G. Bischof, *Chemical and Physical Geology*, III, p. 548.

<sup>2</sup> *Paragenesis der Mineralien*, p. 119. 1849.

<sup>3</sup> *Lagerstätten der Erze*. I, p. 177; II, pp. 297 et seq. 1859

<sup>4</sup> *Untersuchungen über Erzgänge*. Wiesbaden, 1882.

trict in the adjoining country rocks he was led to make extended investigations of the country rocks of ore deposits in general, not contenting himself with a simple lump analysis of the rock, but separating out its individual constituents and analyzing them separately. He now claims that he has thus been able to discover all the metals occurring in veins, and that they are mainly contained in the basic silicates of crystalline rocks, such as mica, hornblende, and augite. He has also analyzed the waters of many thermal springs, and concludes that the metals contained in these are not deposited in their channels, but only at the mouths, where they are practically in contact with the atmosphere, and, while he considers further similar investigations desirable, he holds that what he has already determined proves the general inapplicability of the thermal-spring origin for fissure veins, which have mostly been formed at depths where the influence of the atmosphere would not be felt. Whether Dr. Sandberger's conclusions be accepted in their entirety or not, the results of his investigations are certainly very suggestive. Both he and Bischof consider the silicates more probable sources of the metals than the disseminated pyrites so abundantly found in eruptive rocks, which they hold not to be original constituents thereof.

In the present investigation it was not feasible to follow Sandberger's method of analyzing the separate constituents of all the different rocks, which involves a great expenditure of time and the use of elaborate chemical apparatus. Moreover, the porphyries in the vicinity of Leadville contain no basic silicates in a sufficiently undecomposed state to be separated out. Lump analyses alone were then practicable, but by the employment of dry methods it was possible to make a greater number of tests and detect extremely minute traces of silver and gold, which by Sandberger's method could hardly have been found. Lead and barium were also sought for in the wet way. The other principal constituents of the ores, silica, iron, and manganese, are so universally disseminated that a special search was considered unnecessary. The methods pursued and the details of the results obtained are set forth in Appendix B. More than twice the number of assays there given for gold and silver were originally made, but after they had all been completed a possible source of error was discovered, which led to a repetition of the test in the case of all for which material remained.

The discrepancies in these were not such as to have affected the final conclusion, but it was considered best to publish only those whose positive results were beyond a doubt.<sup>1</sup> Comparatively few sedimentary rocks were tested, for the reason that in all cases where not evidently exposed to the influence of the ore currents they were found to be barren of all the essential vein materials.

**Baryta determinations.**—Baryta forms an essential constituent of one variety of feldspar (hyalophane), which contains from 9 to 20 per cent. of it, and it has also been found in small amounts in andesine, oligoclase, and orthoclase feldspars, where it is generally associated with strontia; probably both might have been found much more frequently if analysts had made a special search for them. As these substances are generally recognized as possible constituents of eruptive rocks, it was not considered necessary to make a great many tests in order to establish the possibility that the barite in the Leadville deposits might have been derived from the neighboring rocks. As strontium replaces barium to a certain extent in the Leadville mineral, its occurrence is also of significance. Neither of these substances was found in the sedimentary rocks analyzed, but from eruptive rocks were obtained as follows:

*Barium and strontium in eruptive rocks.*

Rock.	Locality.	BaO	SrO
White Porphyry .....	California gulch quarry .....	0.03	Trace
Pyritiferous Porphyry .....	White's Hill .....	0.098	.....
Do .....	do .....	Trace	.....
Do .....	White's Hill, Malvina tunnel .....	Trace	.....
Gray Porphyry .....	Near Onota, Johnson gulch .....	.....	0.08
Lincoln Porphyry .....	Summit of Mount Lincoln .....	.....	0.07
Porphyrite .....	North Moquito amphitheater .....	.....	Trace
Hypersthene-andesite .....	Buffalo Peaks .....	Trace	Trace

In one specimen each of Mount Zion Porphyry, porphyrite, and rhyolite, neither baryta nor strontia was found. Thus out of eleven specimens tested five contained baryta, five strontia, and in three neither was detected.

**Lead determinations.**—Lead has also been detected in feldspars, though less frequently than baryta.

<sup>1</sup>For this reason the averages vary slightly from those assumed at the time the abstract of this report was written.

Among the rocks tested during this investigation it was found in a single specimen only of sedimentary rock, a sandstone impregnated with pyrite, probably derived from the adjoining Pyritiferous Porphyry. As the quantitative results are given in full in Table III, Appendix B, they need only be presented in the following abbreviated form here:

*Lead in eruptive rocks.*

Rock.	Number of specimens tested for PbO.	Number containing PbO.	Number in which no PbO was found.
White Porphyry.....	2	2	0
Gray Porphyry.....	1	1	0
Lincoln Porphyry.....	3	2	1
Pyritiferous Porphyry...	8	8	0
Porphyrite.....	2	1	1
Granite.....	2	1	1
Total.....	18	15	3

Of the above specimens all except granite and porphyrite belong to a higher geological horizon than the Blue Limestone. The results given in Table III are those which were obtained from that portion of the rock soluble in strong acids. In only three cases was the insoluble part fused and subjected to further treatment. In these cases more lead was obtained from the insoluble part than from the soluble. It may therefore be assumed that had the same treatment been pursued in each case the results would have been even more conclusive as to the prevalence of lead in appreciable quantities in the igneous rocks of the region. The greater portion obtained in the second treatment existed undoubtedly in the form of silicate, since most of the sulphide contained in the rock, whether original or secondary, would have yielded to the acid treatment. But it does not necessarily follow that all the lead obtained by the first treatment was associated with the pyrite, for the analysis of pyrite from the Pyritiferous Porphyry treated separately gives only 0.0019 per cent. PbO, while the average of eight specimens of the rock gives 0.0020 in the soluble portion alone.

As a further illustration, Table III gives the result of an examination for zinc of two rocks from the Ten-Mile district, where the ores are highly



zinciferous. They are 0.008 and 0.0043 per cent. ZnO, respectively, with an appreciable amount of CoO as well. Of the granites, the one containing lead is of eruptive type, the other rather a granite gneiss.

Had time and laboratory facilities permitted, these results might have been greatly multiplied and the analyses made much more exhaustive; but, although the existence of lead in such connection inferentially implies that of gold or silver also, it was thought wiser to obtain direct proof of the occurrence of these metals as well.

Silver and gold determinations.—The quantitative results of these determinations, together with a statement of the methods employed, will be found in Appendix B. The following table presents the results given in Table IV in a condensed and more comprehensive form:

*Silver and gold in eruptive rocks.*

Rock.	Number of specimens tested.	Number containing silver.	Number containing gold.	Number in which neither was found.
White Porphyry.....	11	3	(?)	8
Gray Porphyry.....	3	3	1	0
Lincoln Porphyry.....	6	5	0	1
Pyritiferous Porphyry.....	10	9	3	1
Sacramento Porphyry.....	1	1	0	0
Green Porphyry.....	1	1	0	0
Diorite (augite).....	1	1	0	0
Porphyrite.....	6	6	0	0
Andesito (hornblende).....	1	1	0	0
Rhyolite.....	1	1	0	0
Trachyte.....	1	1	0	0
Granite.....	2	0	0	2
Total.....	44	32	4	12

In discussing the above results it is important to consider the present condition, position, and composition of the different rock masses. It must be borne in mind also that the negative results are not absolute, but mean merely that the specimen tested does not contain more than 0.0000068 per cent. of silver, or 0.002 ounce to the ton. Such quantities are, it is true, almost infinitely small; so also is the amount of time and water allowed for their leaching almost infinitely great.

The White Porphyry is the most universally decomposed rock in the region. Nowhere was it possible to obtain it in an absolutely fresh state,

but the rock of dikes was found to most nearly approach this condition. The three specimens which were found to contain silver came from dikes, while all the others came from the main sheet overlying the Blue Limestone. Considering this fact alone, it might be assumed that the metallic contents had already been leached out of this sheet. On the other hand, the rock in its unaltered, normal condition apparently contained a very small proportion of basic silicate; and of pyrite, if it existed as an original constituent, but little trace is left.

On the other hand, the Pyritiferous Porphyry, which stands at the opposite end of the scale as regards its contents in gold and silver, although generally decomposed at the surface, is less so than the White Porphyry, and its interior is less deeply exposed, either by erosion or by underground workings. It also contains a larger proportion of basic silicates. Its most striking feature is the enormous amount of pyrite that it contains, amounting, on an average, to about 4 per cent. of its mass. Part, at least, of this pyrite is original, as it is found included within the crystals of quartz. Both pyrite and galena are occasionally found, however, coating the jointing planes of the rock, in which case they are undoubtedly secondary.

From a consideration of the quantitative results given for this rock in Table IV, it is evident that, while the traces of gold in the rock might have been contained in the pyrite, all the silver could not thus be accounted for. The average assay of the ten specimens of Pyritiferous Porphyry is 0.2773 ounces Ag per ton; but one of these might be considered abnormal, since it alone contains more than the sum of the other nine. Rejecting this, the average of the other nine specimens is 0.0265 ounce Ag. The pyrite, separated and assayed alone, gave 0.390 ounce Ag, or 0.00134 per cent.; but in a rock containing 4 per cent. of such pyrite, which was the estimate obtained by a careful mechanical separation of this material from a Pyritiferous Porphyry of average composition, there would only be 0.0156 ounce Ag per ton, or less than three-fifths of the above average of nine specimens.

A mixture of galena and pyrite, also separated from the rock and assayed by itself, gave 2.4 ounces Ag to the ton, or 0.00823 per cent. From Table III it is found that the eight specimens of Pyritiferous Porphyry tested have an average of 0.002025 per cent PbO in the soluble portion, or

what may be assumed to have been in the form of sulphide. This would correspond to 0.002277 per cent. of impure galena, assuming impure galena to bear the relation to PbO of eight to nine. If this galena carries 0.00823 per cent. Ag, as above,  $0.002277 \times 0.00823 = 0.0000177$  per cent. Ag, or 0.0051 ounce to the ton, would be the amount it contributed to the total silver contents of the rock. If this be added to the amount to be derived from pyrite,  $0.0156 + 0.0051 = 0.0207$  ounce, it is still less than the average, 0.0265 ounce, given for the above average rock.

But the tests for lead show that a considerable portion is contained in the silicates (in the three specimens in which this test was made, about three-fifths of the whole amount); and, if the silver is assumed to be necessarily associated with the lead in the rock, this would amply account for the remaining 0.0058 ounce.

Of the other porphyries the most significant are the Lincoln and the Gray, which, as has already been shown, are practically the same type of rock. Both have a much larger proportion of basic silicates than the White Porphyry. Of the two the Gray is to outward appearance the more decomposed, but in the Lincoln Porphyry microscopical examination shows that alteration of the basic silicates has already set in, and it is probable that the more decomposed appearance of the Gray Porphyry is due to the action of surface waters on the other constituents, mainly the feldspars. It is noticeable that the Lincoln Porphyry from Clinton gulch, which contains the most silver, is the only one which contains pyrite; also, that the others are from a region where there has been a considerable concentration of metals in ore deposits, which is not the case, so far as known, in Clinton gulch.

With the exception of the Sacramento Porphyry the other rocks have no apparent association with important ore deposits. It is significant that the diorite given in Table IV contains augite, hornblende, and mica, whereas two other diorites assayed, and in which no silver was found, contained a very small proportion of basic silicates. In the recent eruptive rocks there is also an apparent relation between the amount of basic minerals and the contents in silver. In Nevadite, in which they are almost

entirely wanting, no silver was found, while the trachyte and andesite, which contain more of these minerals than the Black Hill rhyolite, also contain more silver.

Although the above facts are not sufficiently conclusive to afford absolute proof that the metallic contents of the deposits were entirely derived from the eruptive rocks, they certainly show the possibility and even probability that this source furnished a part at least of the vein materials.

The actual percentage of metals found may seem very small; on the other hand, it should be remembered that the amount of time and of water allowable for the leaching process may have been almost indefinitely large. The present porphyry bodies, moreover, are of enormous extent as compared with the actual size of the deposits, while the amount of porphyry that has been removed by erosion since the deposits were first made, though it cannot be accurately estimated, must have been even larger.

**Possible contents of porphyry bodies.**—In order to show that even with the small percentages given in the above table the possible contents of the porphyry bodies are amply adequate to account for the amount of ore thus far developed in the district, a hypothetical calculation will be made based on these percentages and on the probable bulk of one of the porphyry bodies, taking first the amount assumed to exist now and second a conservative estimate of the amount which existed at the time of original ore deposition, and before any of it had been removed by erosion. For this purpose the Pyritiferous Porphyry will be chosen, since a greater number of tests of this rock have been made than of any other.

The present area of outcrop of the Pyritiferous Porphyry may be taken, in round numbers, as  $5,000 \times 10,000$  feet = 50,000,000 square feet. If it is assumed that it originally extended westward to the foot of Carbonate Hill, north to the line of Yankee Hill, south to that of Printer Boy Hill, and but little beyond its present boundaries to the eastward, it would have covered a square area of  $10,000 \times 20,000 = 200,000,000$  square feet, or four times the assumed area of its present outcrop. The specific gravity of Pyritiferous Porphyry, obtained as an average of four specimens, is 2.608. Therefore one ton (2,000 pounds) of this rock would occupy 12.27 cubic feet; say  $12\frac{1}{2}$  for convenience of calculation.

This porphyry is assumed to contain 4 per cent. of pyrite ( $\text{FeS}_2=4.00$ ). From Table III, Appendix B, its contents of protoxide of lead, as an average of the eight specimens tested, is 0.002025 per cent. in the soluble portion; or, assuming, from the proportion found in the insoluble portion of the three specimens in which it was tested, that this represents only two-fifths of the entire lead contents, the average contents of the whole rock would be  $\text{PbO}=0.0050625$  per cent. From Table IV the average of ten specimens assayed for silver is found to be 0.2773 ounce per ton, or, rejecting the richest of these ten specimens as above the normal, the average of the remaining nine specimens is 0.0265 ounce silver per ton of Pyritiferous Porphyry.

The probable thickness of the porphyry sheets it is rather difficult to estimate. The sections as drawn give a maximum thickness of about fifteen hundred feet, and an unknown thickness has been eroded away. It may not be unreasonable to assume 1,000 feet as the average thickness of the original body. From the above-assumed data would be obtained, as the contents of the present and original areas of Pyritiferous Porphyry, respectively, and on the basis of the two different values for lead and silver given above, the following:

Contents of Pyritiferous Porphyry.	Designation.	In area of present outcrop.	In area of assumed original body.
Amount of porphyry .....	Tons .....	4,000,000,000	16,000,000,000
Amount of pyrite, at 4 per cent. ....	Tons .....	160,000,000	640,000,000
Amount of galena { at 0.002025 per cent. PbO. ....	Tons .....	8,675,000	34,700,000
{ at 0.0050625 per cent. PbO. ....	Tons .....	21,687,750	86,751,000
Amount of silver { at 0.0265 ounce per ton. ....	Ounces .....	106,000,000	424,000,000
{ at 0.2775 ounce per ton. ....	Ounces .....	1,109,000,000	4,436,000,000

To obtain an actual average of the metallic contents of this or any other body of porphyry would have required a systematic sampling of the rock and the taking of specimens at given and equal distances, not only on its surface but through its mass in depth, for the tests already made show that the metals are not evenly distributed, but vary in an apparently arbitrary manner. Such a sampling is manifestly not practicable, nor would the expenditure of labor and time required by it be advisable if it were, since in the present state of explorations in this region it is impossible to

trace with any degree of certainty the processes of original ore deposition. The most that could be hoped for was to indicate the possible methods by which the deposition might have taken place and to weigh the probabilities afforded by ascertained facts in favor of one or the other of these methods. The foregoing reasons seem to favor the probability that the ores may have been derived, in part at least, from one or more of the bodies of porphyry which occur in the region, and the above figures show that the small percentages of the metals still existing in these rocks might furnish an adequate amount of material to form the known ore bodies.

The most uncertain element in all these calculations and hypotheses is the form and extent of the porphyry bodies in depth beyond the limit of present explorations. The form given to these bodies in the sections is, as has already been stated, only hypothetical, though founded on deductions from many actual observations and in all probability correct in its main outlines. Still it is probable that there are more vents or channels from below through which the bodies have reached their present position than are shown there, but their number and position can only be determined by actual exploration. It is possible that in future years, when mine workings shall have been extended over areas where the ore horizon exists at considerable depths below the surface and other eruptive channels have been found and critically examined, evidence may be obtained that ore solutions have ascended along these channels from below. Such evidence will not, however, necessarily preclude the derivation of part of the metals from the country rocks, and at present that derivation is the only one which has the support of actual though somewhat indirect proof.

Another element of uncertainty, and one which renders it difficult to decide from what particular variety of porphyry the metals of the deposits were derived, is the impossibility of determining the form and character of the porphyry bodies, which have been removed by erosion, as they existed at the time of original ore deposition, and upon this point future exploration will throw little or no light.

---

---

APPENDIX B

---

CHEMISTRY

BY

W. F. HILLEBRAND

---

---

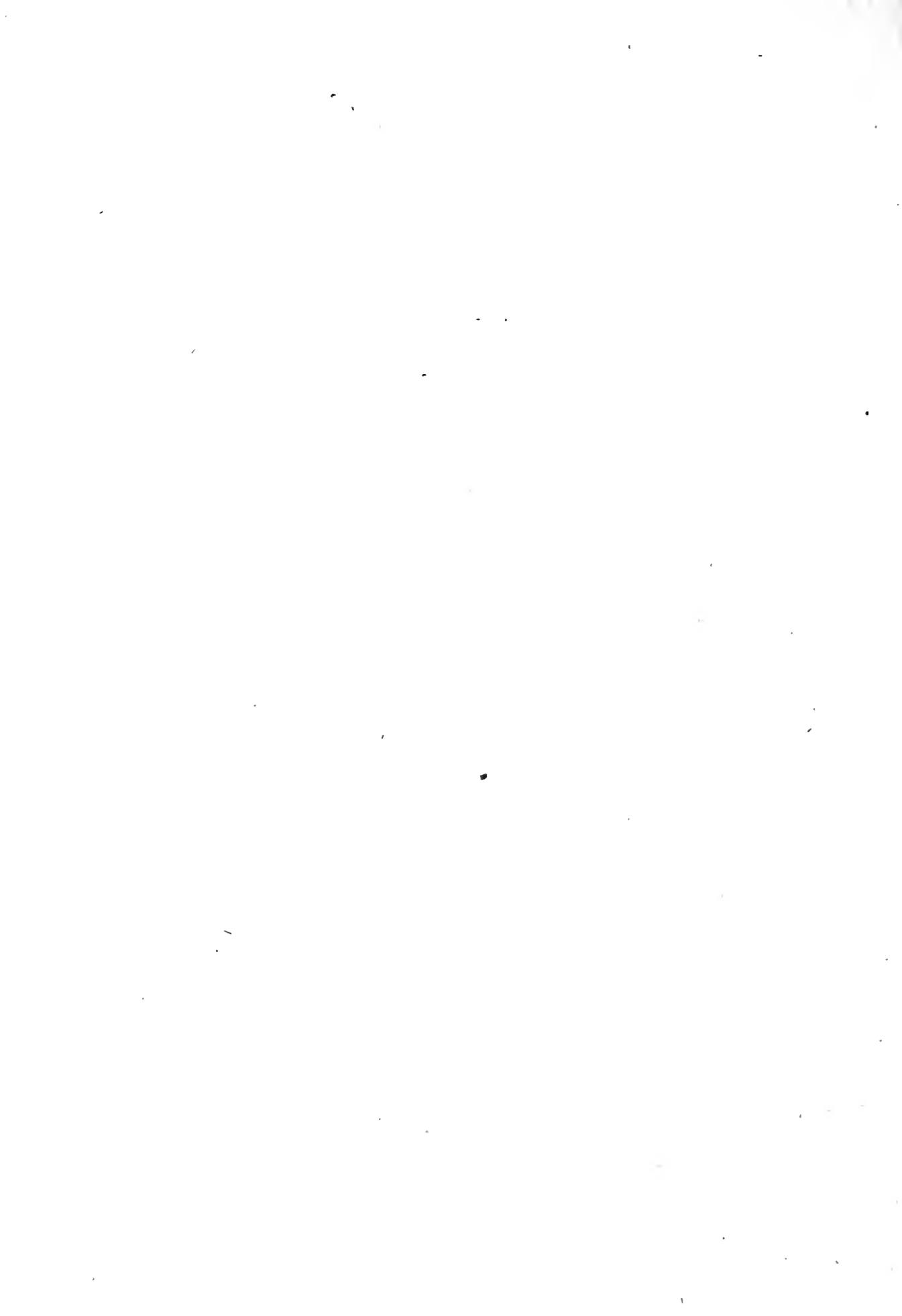



# CONTENTS.

## ERUPTIVE ROCKS.

	Page.
<b>TABLE I.</b> Complete analyses .....	589
II. Silica and alkali determinations .....	590
III. Lead, zinc, cobalt, and barium determinations .....	591
IV. Gold and silver determinations .....	594

## LIMESTONES.

<b>TABLE V.</b> Complete analyses .....	596
VI. Lime, magnesia, and chlorine determinations .....	598
VII. Serpentine and amphibole analyses .....	598

## ORES AND VEIN MATERIALS.

<b>TABLE VIII.</b> Sand carbonates .....	599
IX. Chloro-bromo-iodides .....	600
X. Various ores, vein materials, and country rocks .....	602
XI. Alteration products of porphyry .....	603
XII. Alteration products of galena and pyrite .....	606
XIII. Miscellaneous alteration products .....	607
XIV. Assays of ores, vein material, and country rocks for silver and gold .....	608



# TABLES OF ANALYSES AND NOTES ON METHODS EMPLOYED.

## ERUPTIVE ROCKS.

TABLE I.—*Complete analyses of eruptive rocks and constituent minerals.*

[The Coll. No. is the number given to the specimen in the collection of Leadville rocks deposited in the National Museum.]

	1	2	3	4	5	6	7	8	9	10	11	12	13	14
Sp. grav . . . . .	2.680	2.629	2.670	2.636	2.768	2.740	2.742	2.742	2.742	2.742	2.742	2.742	2.742	2.742
At temp. of . . . . .	16° C.	26° C.	16° C.	16° C.	16° C.	16° C.	16° C.	16° C.	16° C.	16° C.	16° C.	16° C.	16° C.	23° C.
SiO <sub>2</sub> . . . . .	70.74	45.03	73.50	66.45	63.10	62.22	56.62	64.81	74.45	65.04	56.10	51.70	51.10	50.04
TiO <sub>2</sub> . . . . .	0.10	0.07	0.10	0.07	0.10	0.07	0.08	0.08	0.08	0.08	0.08	0.08	0.08	0.08
Al <sub>2</sub> O <sub>3</sub> . . . . .	14.68	38.14	14.87	15.84	14.97	a20.33	16.74	15.73	14.72	b20.40	16.12	1.72	2.15	2.91
Fe <sub>2</sub> O <sub>3</sub> . . . . .	0.69	0.95	2.59	2.78	4.94	1.67	1.67	1.67	1.67	1.67	4.92	0.30	0.30	0.30
FeO . . . . .	0.58	0.42	1.43	1.10	3.27	2.91	2.91	2.91	2.91	2.91	4.43	18.00	c18.30	d17.81
MnO . . . . .	0.06	0.03	0.09	0.09	0.15	0.08	e0.28	0.08	e0.28	0.08	Trace	0.36	0.36	0.12
CaO . . . . .	4.12	Trace	2.14	2.90	3.04	2.95	7.39	4.22	0.83	0.79	0.09	2.67	3.81	0.70
BaO . . . . .	0.03	Trace	Trace	Trace	Trace	Trace	Trace	Trace	Trace	Trace	Trace	Trace	Trace	Trace
SrO . . . . .	Trace	Trace	Trace	Trace	Trace	Trace	Trace	Trace	Trace	Trace	Trace	Trace	Trace	Trace
MgO . . . . .	0.28	(f)	0.29	1.21	1.10	4.08	2.82	0.37	0.37	0.37	4.60	25.09	24.25	21.74
K <sub>2</sub> O . . . . .	2.59	9.44	3.50	2.89	2.93	8.31	1.97	1.43	4.53	9.74	2.37	(g)	(g)	0.27
Na <sub>2</sub> O . . . . .	2.29	0.71	3.46	3.92	3.46	3.45	3.50	3.98	3.97	4.11	2.96	(g)	(g)	0.27
Li <sub>2</sub> O . . . . .	(h)	Trace	Trace	Trace	Trace	(i)	{ FeS <sub>2</sub> } 0.90	Trace	Trace	Trace	(g)	(g)	(g)	(g)
H <sub>2</sub> O . . . . .	2.09	4.06	0.90	0.84	1.28	h1.90	0.92	0.62	0.66	0.29	1.03	(g)	(g)	0.27
CO <sub>2</sub> . . . . .	2.14	Trace	Trace	1.35	0.92	1.15	1.08	0.23	0.01	0.01	0.27	0.02	0.02	0.02
P <sub>2</sub> O <sub>5</sub> . . . . .	Trace	Trace	Trace	0.05	0.03	Trace	Trace	Trace	Trace	Trace	Trace	Trace	Trace	Trace
Cl . . . . .	Trace	Trace	Trace	Trace	Trace	Trace	Trace	Trace	Trace	Trace	Trace	Trace	Trace	Trace
Totals . . . . .	100.29	100.12	100.00	100.11	99.16	100.73	100.59	100.38	100.37	99.90	106.64	100.09	99.59	99.59

a Very little Fe<sub>2</sub>O<sub>3</sub> present; FeO not determined.

b Includes traces of Fe<sub>2</sub>O<sub>3</sub>.

c Includes any Fe<sub>2</sub>O<sub>3</sub> present.

d Calculated from the Fe<sub>2</sub>O<sub>3</sub> found.

e MnO<sub>2</sub>.

f A little MgO present.

g Water and alkalis not tested for.

h By ignition; want of material prevented a second determination.

1. White Porphyry. Coll. No. 27p. Quarry in California Gulch, southwest slope of Iron Hill, near Leadville. Composed chiefly of quartz orthoclase, and plagioclase; no biotite or hornblende; little magnetite; no apatite; feldspars attacked; muscovite and calcite secondary.

2. Muscovite crystals from White Porphyry. Sheet on south slope of Little Zion. Analysis only approximate, being made to prove the mica to be muscovite.

3. Mount Zion Porphyry. From Little Harry shaft, Prospect Mountain.

4. Lincoln Porphyry. Coll. No. 75. Summit of Mount Lincoln, Park County. Rock nearly fresh; contains quartz, orthoclase (large crystals), plagioclase, biotite; biotite partly changed to chlorite, containing rutile (?) needles; some magnetite and apatite; calcite.

5. Gray Porphyry. Coll. No. 59a. Near Onota claim, Johnson Gulch, Leadville. Rock nearly fresh; contains quartz orthoclase (large crystals), plagioclase, and biotite. Details same as for 4.

6. Large pink crystals of feldspar from Gray Porphyry (No. 5). Coll. No. 59b.

7. Porphyry. Coll. No. 120 (Type V of table, see Appendix A). Near the Northern Light mine, Lower Backskin gulch, Park County; intrusive sheet. Contains abundant plagioclase and hornblende, and little biotite; quartz and orthoclase (?) in groundmass. Magnetite and little apatite.

8. Porphyry. Coll. No. 260. Type VI of table (see Appendix A). Head of North Fork of Mosquito gulch, Park County. Dike in Archean. Fresh. Much biotite and plagioclase; some quartz in groundmass. Very little hornblende, magnetite, pyrite, apatite.

9. Nevadite. Coll. No. 397. Northeast point of Chalk Mountain, Ten-Mile district. Contains sanidino, plagioclase, and quartz in abundance; little biotite and magnetite.

10. Sanidino from Nevadite. Coll. No. 130. Southern edge of Chalk Mountain.

11. Hypersthene-andesite. Coll. No. 144. Buffalo Peaks, Park County. Very fresh. Plagioclase and hypersthene abundant; considerable augite, magnetite, apatite; glass base.

12. Hypersthene from hypersthene-andesite. Coll. No. 144 (see 11). The hypersthene for this and the two following analyses was separated from the other constituents of the rock by hydrofluoric acid, as recommended by Fouqué in Santorin et ses éruptions.

13. Same as 12, but of a different sample.

14. Hypersthene from hypersthene-andesite. Coll. No. 150. Buffalo Peaks, Park County. Particles of undecomposed feldspar were visible attached to the crystals and fragments of hypersthene analyzed.

TABLE II.—Silica and alkali determinations.

No.	Coll. No.	Rock.	Variety.	Locality.	SiO <sub>2</sub>	K <sub>2</sub> O	Na <sub>2</sub> O	Li <sub>2</sub> O
1		Porphyry	Mount Zion	Little Harry shaft, Prospect Mountain	73.50	3.56	3.40	None
a2	27p	do	White	Quarry, California gulch	70.74	2.50	2.29	
3	230	do	do	Above Blue Limestone, Dyer Mountain.	66.51			
a4	75	do	Lincoln	Summit of Mount Lincoln	66.45	2.89	3.91	Trace
5	78	do	do	Dike in eastern spur of Mount Lincoln.	64.16	2.42	3.15	
6	74	do	do	El Paso mine, Clinton gulch	69.00			
a7	59a	do	Gray	Near Onota Claim, Johnson gulch	68.10	2.93	3.45	None
b8		do	Pyritiferous	White's gulch		4.62	2.91	
9	103	do	Green	South head of Mosquito gulch	65.05			
10	08	do	do	Between Buckskin and Mosquito gulches.	63.85			
11	95a	do	Moaquito	North Mosquito amphitheater	68.01			
b12		do	do	North face of Mount Lincoln		4.36	4.26	
13	85a	do	Sacramento	North of East Leadville	65.03	2.57	3.55	
14	109a	do	Silverheels	Summit of eastern spur of Mount Silverheels.	60.42			
b15		do	do	Mount Silverheels		2.70	4.03	
a10	120	Porphyrite	Hornblende	South wall of Buckskin gulch	56.62	1.07	3.50	
17	131	do	do	Arkansas amphitheater	57.33			
18		do	Hornblende and biotite.	Ten-Mile amphitheater	57.76			
19	132	do	Hornblende	North Mosquito amphitheater	54.54			
20	121	do	do	Buckskin amphitheater	65.73			
a21	260	do	Biotite	North Mosquito amphitheater	64.80	1.43	3.98	None
22	130	do	do	Arkansas amphitheater	66.29			
23	129	do	do	do	59.26			
24	137	Rhyolite	Nevadite	Chalk Mountain, eastern edge	71.44			
a25	397	do	do	Northeast point of Chalk Mountain	74.45	4.53	3.97	Trace
26	140	do	Lipserite	Southern end of Black Hill	69.54			
27	268	do	do	South bank of Empire gulch	68.65	3.50	2.17	
28		do	do	Near Granite, Chaffee County	76.84			
29	269a	do	Showing quartz	Little Ellen shaft, McNulty gulch	65.75			
30	269a	do	Compact	do	65.21			
31		do	Tufa	Five miles below Salt Works, South Park.	70.30			
32	142	Trachyte	Quartziferous	Head of Little Union gulch	61.22			
33	143	Andesite	Hornblende	Buffalo Peaks, northwest Peak	57.00			
34	149	do	Dacite	Buffalo Peaks, central amphitheater	66.50	2.57	3.87	None
a35	144	do	Hypersthene	Buffalo Peaks, northeast spur	56.19	2.37	2.96	None
36	150	do	do	Buffalo Peaks, base of middle peak	60.36			

a Complete analysis in Table I.

b Analyzed by L. G. Eakins.

NOTE.—Blanks in the above table denote simply that no tests were made for the substance indicated.

TABLE III.—*Determinations of lead, zinc, cobalt, and barium, chiefly in eruptive rocks.*

No.	Coll. No.	Rock.	Variety.	Locality.	PbO in soluble portion.	PbO in insoluble portion.	ZnO	CoO	BaO
a1	27p	Porphyry...	White .....	Quarry, California gulch.....	0.0030	.....	.....	.....	0.08
2	54b	...do .....	...do .....	Dike in Dolly Varden mine, Mount Bross.	0.0028	.....	.....	.....	.....
a3	75	...do .....	Lincoln .....	Summit of Mount Lincoln .....	None.	.....	.....	.....	.....
4	59a	...do .....	Gray .....	Quota mine, Johnson gulch .....	0.0024	0.0034	.....	.....	.....
5	.....	...do .....	Eagle River.	From surface at El Capitan mine, Tennessee Pass.	Trace.	.....	.....	.....	.....
6	56	...do .....	...do .....	From shaft of El Capitan mine, Tennessee Pass.	Trace.	.....	.....	.....	.....
7	.....	Limestone ..	Blue .....	Twelve feet below ore body, El Capitan mine.	None.	.....	.....	.....	.....
8	130	Porphyrite	Biotite.....	Arkansas amphitheater.....	None.	.....	.....	.....	.....
9	124	...do .....	Hornblende and biotite.	Bartlett Mountain .....	0.0006	.....	.....	.....	.....
10	326	Porphyry ..	Eagle River.	Main fork of Eagle River.....	.....	.....	0.0080	0.0008	.....
11	269a	Rhyolite ..	.....	Little Ellen shaft, McNulty gulch ..	.....	.....	0.0043	0.0010	.....
12	90a	Porphyry...	Pyritiferous.	Hartford mine, Breece Hill .....	0.0053	.....	.....	.....	.....
13	90c	...do .....	...do .....	White's Hill, west of Pilot fault .....	0.0013	.....	.....	.....	.....
14	87	...do .....	...do .....	White's Hill, between Printer Girl and Golden Edge.	0.0013	0.0029	.....	.....	.....
15	.....	...do .....	...do .....	White's Hill .....	.....	.....	.....	.....	0.008
16	93a	...do .....	...do .....	.....	.....	.....	.....	.....	Trace
17	.....	...do .....	...do .....	White's Hill, Melvina tunnel .....	Trace.	.....	.....	.....	Trace
18	.....	...do .....	...do .....	Head of White's gulch .....	0.0030	0.0034	.....	.....	.....
19	.....	...do .....	...do .....	Printer Boy Hill .....	0.0006	.....	.....	.....	.....
20	94a	...do .....	...do .....	Rebel Warrior mine, Ball Mountain ..	0.0030	.....	.....	.....	.....
21	94	...do .....	...do .....	Wednesday tunnel, Ball Mountain .....	0.0017	.....	.....	.....	.....
22	288	Sandstone ..	...do .....	Snow Bird claim, head California gulch.	0.0026	.....	.....	.....	.....
23	120	Pyrite .....	From Pyritiferous Porphyry.	Lalla Rookh mine, Breece Hill .....	0.0019	.....	.....	.....	.....
24	17	Granite .....	Archean .....	Garden City shaft, California gulch.....	None.	.....	.....	.....	.....
25	217	...do .....	...do .....	Northwest slope of Mosquito Peak .....	0.0008	.....	.....	.....	.....

a Complete analysis in Table I.

N. B.—The blank spaces under the headings PbO, etc., do not indicate absence of the respective oxides: Where no results are given, no tests were made.

## REMARKS ON TABLES I, II, AND III.

Insoluble silicates were decomposed by fusing with alkaline carbonates for the determination of silica, titanate acid, and all bases except the alkalis.

Ferric oxide and alumina were separated either by pure potassium hydrate, or more generally by ammonium sulphide, after addition of tartaric acid and ammonia.

For the determination of ferrous oxide, treatment with sulphuric acid in sealed tubes at about 200° C. was employed in cases where complete decomposition of the silicates could thus be effected, and the solution titrated with potassium permanganate. For the decomposition of refractory silicates, pure hydrofluoric acid, distilled from a platinum retort, was employed, the solution being effected in platinum vessels with careful exclusion of air. The iron was then determined as above.

Barium and strontium were looked for in the precipitated calcium oxalate after ignition, and estimated by the method given by Bunsen in his treatise on Mineral Water Analyses; the purity of the resulting compounds of these elements was ascertained by means of the spectroscope.

When a rock was examined merely to ascertain the presence or absence of barium, a considerable portion (10 grams) was decomposed with hydrofluoric and sulphuric acids, the soluble salts were extracted with water after expulsion of the hydrofluoric and excess of sulphuric acids, the residue was fused with sodium carbonate, extracted with water, and the insoluble part collected on a filter. After solution in hydrochloric acid, the barium, if present, was thrown down with sulphuric acid, the precipitate ignited and weighed, and after decomposition with sodium carbonate, tested spectroscopically.<sup>1</sup>

For the estimation of the alkalis, decomposition was effected in the earlier analyses by hydrofluoric and sulphuric acids; in the later by heating in a platinum crucible with calcium carbonate and ammonium chloride. The potassium was thrown down, after weighing the mixed chlorides, as potassium-platinic chloride, and calculated from the weight of the latter, the sodium being found by difference. Lithium could never be detected spectroscopically in the potassium-platinic chloride, but occasionally in the sodium salt.

Chlorine was determined by fusing with alkaline carbonate, extracting with water, acidifying the filtrate with nitric acid, and precipitating with silver nitrate.

Phosphorus pentoxide was always determined in a separate portion of the powder, and water by ignition in a hard glass tube and absorption in a weighed calcium chloride tube. The loss in weight by treatment with acid in a suitable apparatus gave the carbon dioxide.

For the detection and estimation of lead, large quantities (30–50 grams) were employed. Pyrite and other soluble salts were first extracted with nitric or nitrohydrochloric acid; the filtrate, together with copious washings, evaporated nearly to dryness several times with nitric acid; the residue digested with dilute nitric acid, and the solution and undissolved matter separated by filtration. As the insoluble part might contain a trace of lead sulphate, a warm ammoniacal solution of ammonium tartrate was passed repeatedly through the filter, and to the filtrate ammonium sulphide added. Through the previous nitric acid solution a strong current of hydrogen sulphide gas was passed for a considerable length of time, the precipitate, mainly sulphur from reduction of iron salts, collected on a filter, well washed, dried, and ignited gently with the filter paper to volatilize the sulphur. A few drops of nitric acid were then added, and heat was applied to dissolve the lead, mostly reduced to the metallic state by the carbon of the filter paper. The solution was filtered onto a watch-glass, and to this was added the nitric-acid solution of any lead sulphide that might

<sup>1</sup> Later investigation by the writer seems to indicate that baryta may be a far more frequent constituent of eruptive rocks than has hitherto been supposed. The failure to detect it in the ignited calcium oxalate, where it is usually looked for, cannot be regarded as a proof of its absence from the eruptive rock examined. Experience in a number of cases has shown that where baryta and lime are in solution in as high a proportion as 1 of the former, to 4 or 5 of the latter, in presence of considerable ammonium chloride, an almost complete separation of the two is effected by double precipitation of the lime by ammonium oxalate. The solubility of barium oxalate appears to be increased by the presence of magnesium salts. An ordinary spectroscope repeatedly failed to show the faintest evidence of barium in the ignited calcium oxalate. This subject will be more fully investigated. (W. F. H.)

have appeared in the ammonium tartrate solution above mentioned. As a trace of lead sulphate might have been formed by the ignition of the precipitate by hydrogen sulphide and have escaped solution in the nitric acid added, the residue on the filter was exhausted with ammonium tartrate and tested with ammonium sulphide. The contents of the watch-glass were then evaporated with two or three drops of sulphuric acid, and finally gently heated to expel nitric acid. If lead was present it could now invariably be seen at the center as white powder. This was collected on the smallest possible filter, washed with alcohol, dried, ignited, and weighed as sulphate. The latter was then scraped as far as possible on charcoal, and carefully reduced with a very little soda. The yellow coating of lead oxide was invariably formed, and in the soda appeared minute metallic buttons, malleable and soluble in nitric acid. The solution, concentrated to a drop or two, showed a bluish-black precipitate with hydrogen sulphide.

The portion of the rock insoluble in nitric or nitrohydrochloric acids, composed of quartz and silicates, was decomposed with hydrofluoric and sulphuric acids purified by distillation from a platinum retort, and dissolved in slightly acidified water, after expulsion of the hydrofluoric and excess of sulphuric acids. Solution and possible residue were then treated as in the foregoing for the separation and estimation of lead.

For the estimation of zinc and cobalt, large quantities (30 grains) were taken and decomposition was effected by hydrofluoric acid. After evaporating with sulphuric acid and igniting to expel the excess of the latter, solution was effected in hot water slightly acidified; the solution saturated with hydrogen-sulphide; from the filtrate, after oxidation, alumina and iron thrown down by ammonia; the precipitate redissolved in hydrochloric acid after filtration, and reprecipitated. This being repeated once more, the combined filtrates were evaporated to a moderate volume; the alumina still in solution was thrown down while boiling by ammonia, and this precipitate redissolved and reprecipitated. To the again combined filtrates ammonium sulphide was added to throw down zinc, manganese, cobalt, and nickel, if present; the precipitate was treated on the filter with a mixture of one part hydrochloric acid of 1.12 sp. gr. and six parts solution of hydrogen sulphide. The zinc and manganese in solution were thrown down again by ammonium sulphide, the manganese (being present in very small quantity) extracted by dilute acetic acid, while the zinc sulphide on the filter was then brought into a weighed platinum crucible by means of hydrochloric acid, evaporated to dryness, and ignited with mercuric oxide in the manner recommended by Volhard. The oxide, after weighing, gave the characteristic green coloration on igniting with cobalt nitrate. The cobalt sulphide left on the filter after extraction of zinc and manganese was ignited with the filter, digested with nitrohydrochloric acid; the solution rendered alkaline with ammonia; ammonium carbonate added; the slight precipitate separated by filtration and the cobalt thrown down by potassium hydrate. The ignited oxide tested by the method of Jorissen showed no trace of nickel.

TABLE IV.—Gold and silver determinations.

No.	Coll. No.	Formation.	Locality.	Silver, percentage.	Silver, ounces per ton.	Gold, ounces per ton.
1	53	White Porphyry	Buckskin amphitheater, débris slope	0.000,024,0	0.007	None
2	44a	do	"Horseshoe," south wall		None	Do.
3	45a	do	South base of White Ridge		do	Do.
4	45b	do	Summit of White Ridge		do	Do.
5	do	do	Four-Mile gulch		do	Do.
6	44	do	Head Four-Mile gulch		do	Do.
7	46	do	West end of Lamb Mountain		do	Do.
8	do	do	Northwest slope of Sheep Mountain		do	Do.
9	47	do	do		do	Do.
10	54a	do	Dolly Varden mine, west dike	0.001,269	0.37	(1)
11	54b	do	Dolly Varden mine, east dike	0.000,481	0.14	(1)
12	72	Lincoln Porphyry	Arkansas Valley, east side, above Howland		None	None
13	74	do	Clinton gulch	0.000,155	0.045	Do.
14	75a	do	Mount Lincoln summit	0.000,034	0.01	Do.
15	75b	do	Mount Lincoln summit, different specimen from above.	0.000,024	0.007	Do.
16	78	do	Mount Lincoln, dike on south face	0.000,017,1	0.005	Do.
17	251a	do	East spur Mount Lincoln		Trace	Do.
18	59a	Gray Porphyry	Onota shaft, Johnson gulch	0.000,034,3	0.01	Do.
19	59b	do	North of Onota shaft	0.000,137	0.040	Trace
20	60c	do	Licksanddix bore-hole, Little Stray Horse Park.	0.000,137	0.040	None
21	84	Sacramento Porphyry.	Between Sacramento and Pennsylvania gulches.	0.000,034,3	0.01	Do.
22	98	Green Porphyry	Mosquito gulch, north wall	0.000,017,1	0.005	Do.
23	90h	Pyritiferous Porphyry	Shaft west of Tribune, Breece Hill	0.008,68	2.533	Do.
24	90e	do	Hartford shaft, Breece Hill	0.000,275	0.08	Trace
25	88	do	Mountain shaft, Breece Hill	0.000,045	0.013	Do.
26	do	Galena and pyrite	South of Ace of Hearts, Breece Hill	0.008,23	2.400	0.033
27	249	Pyrite	Shaft west of Ohio Bonanza, Breece Hill	0.001,34	0.390	0.130
28	do	Pyritiferous Porphyry	South fork of White's gulch	0.000,113	0.033	(1)
29	do	do	Comstock Tunnel, White's Hill	0.000,113	0.033	(1)
30	do	do	West of Pilot fault, White's Hill	0.000,103	0.030	Trace
31	90e	do	Head of White's gulch	None	None	None
32	do	do	Above Pilot mine, Printer Boy Hill	0.000,034,3	0.01	Do.
33	93b	do	Above Oro City, south side of California gulch	0.000,054,8	0.046	(1)
34	94a	do	Rebel Warrior shaft, Ball Mountain	0.000,079,1	0.023	None
35	118	Diorite	Red amphitheater, Buckskin gulch	0.000,013,7	0.004	Do.
36	124	Porphyrite	Bartlett Mountain, near summit	0.000,192,5	0.056	Do.
37	119b	do	Buckskin amphitheater, débris slope	0.000,048	0.014	Do.
38	121	do	do		Trace (1)	Do.
39	266	do	"Horseshoe" dike in limestone		do	Do.
40	129	do	Arkansas amphitheater	0.000,017,1	0.005	Do.
41	131	do	do	0.000,006,8	0.002	Do.
42	140	Rhyolite	Black Hill, South Park	0.000,068,7	0.020	Do.
43	142	Trachyte	Head of Union gulch	0.000,092,8	0.027	Do.
44	143	Herblende-andesite	West slope of Buffalo Peaks	0.000,103	0.030	Do.
45	do	Granite	Big Evans gulch		None	Do.
46	do	do	Yankee Hill, south of Logan shaft		do	Do.

<sup>a</sup> Complete analysis of this specimen in Table I.



## REMARKS ON TABLE IV.

For the estimation of such extremely small quantities of silver and gold as it was supposed some of the eruptive rocks from the Leadville region might contain, and even for their detection alone, a most extreme degree of care and precaution was imperative. It being necessary to operate upon large quantities of material, it was decided to make the determinations by crucible assay, this process combining the greatest accuracy with the least expenditure of time. It was found, however, after a number of tests, that none of the lead or litharge obtainable was sufficiently free from silver for the present purpose. The silver contained in the lead or litharge used for an assay was generally so largely in excess of that in the powdered rock mixed with it that the prills of silver obtained from the regular assay upon rock known to contain silver and from a check assay upon the lead or litharge alone frequently differed in weight only within the allowable limits of error. Recourse was then had to lead acetate, of which several lots were examined. These were all found much freer from silver than either of the substances previously tested, and one lot of commercial acetate from Mallinckrodt & Co., of Saint Louis, Mo., was used for all the assays tabulated above.

Preparatory to using, it was dehydrated by fusing in a large iron vessel till sudden swelling up and solidification of the whole mass took place, and then finely pulverized. This material, containing about 73 per cent. of lead by assay, was found by repeated tests, conducted, as given below, upon the same amounts as used for the rock assays, to carry 0.004 ounce silver per ton of 2,000 pounds, or 0.0000137 per cent., including a trace of gold far too small for estimation. The latter was left on solution of the silver in nitric acid as a minute black speck, indistinguishable without the aid of a lens. By collecting into one button the silver from 500 to 600 grams of dehydrated lead acetate, parting with great care, bringing the gold upon a sheet of white writing paper and flattening it out with a knife blade, the yellow reflection of gold could readily be observed by examination with a lens, and sometimes with the naked eye.

The process of assay was as follows: Four Hessian crucibles, of suitable size, were each charged with one assay ton (29,166 milligrams) of the sample to be assayed, two and one-half assay tons of the dehydrated lead acetate, and a proportionate amount of a flux consisting of soda, borax, and a little argol. After mixing well, a layer of salt was placed on top, and, if much pyrite was present, an iron nail inserted. The four charged crucibles were then placed covered in a wind furnace fired by coke, and left, with proper regulation and final strong increase of temperature, till fusion was complete. The contents were then poured into molds, the lead reguli, weighing each about 55 grams, reduced by scorification in a muffle to a smaller size, the reduced reguli united two and two and rescorified, and the two resulting therefrom again united and reduced by scorification to a single button of suitable size for cupellation. Toward the end of cupellation, which was always conducted with the greatest care and, as nearly as possible, under the same conditions of temperature for each assay, the button was poured from its cupel into another one immediately behind the first, in order that the cupellation might be finished upon a smooth bottom. If this precaution was neglected, the silver button was occasionally not to be found in the roughened surface of the cupel. After a little experience, no loss need be apprehended in pour-

ing from one cupel to the other. The silver was then weighed upon an Oertling assay balance, indicating a difference in weight of 0.02 milligram with great exactness and of 0.01 milligram with tolerable accuracy. After deducting from the weight of silver found that due to the lead acetate, which, where ten assay tons had been used, would be 0.04 milligram, division of the remainder, if any, by the number of assay tons of rock taken gave directly the contents in ounces and decimal fractions of an ounce troy per ton of 2,000 pounds avoirdupois, since 29,166.6 ounces troy make one ton of 2,000 pounds avoirdupois and an assay ton contains 29,166.6 milligrams. The silver was then dissolved in nitric acid, but the presence of a trace of gold, derived from the lead acetate, rendered the detection of gold from the rock impossible, unless its amount considerably exceeded that of the lead salt. An example will best show the degree of accuracy attainable. Suppose rock and lead acetate to have been taken in the usual amounts: Four assay tons (116.66 grams) of the former to ten assay tons (291.66 grams) of the latter, and the final silver button to weigh 0.06 milligram. From this is to be deducted 0.04 milligram, and the remainder divided by 4, the number of assay tons of rock tested, gives 0.005 ounce per ton as the accurate result. Had the weight been 0.05 milligram, the correctness of the result, 0.0025 ounce, might be more open to doubt, as the balance cannot be counted upon to indicate differences of only 0.01 milligram with certainty. Hence, for the above quantities of sample and lead acetate, 0.005 ounce per ton is about the limit of accuracy.

There will be noticed in the table occasional instances, notably in No. 41, where lower figures are given. In these cases the amount of rock assayed had been increased without at the same time increasing the lead acetate. In the case of No. 41 it was impossible to decide from 4 assay tons whether silver was present or not, though the weight seemed to slightly exceed 0.04 milligram. By doubling the amount of sample and using still only ten assay tons of lead acetate, the weight of the silver sensibly increased, thus showing beyond reasonable doubt that the rock was argentiferous. It did not appear advisable, however, as a rule, to reduce the proportion between the weights of sample and lead acetate much below 4:10 for fear the reduced lead might not be sufficient to extract and collect the silver entirely.

## LIMESTONES.

TABLE V.—Complete analyses. Dolomitic limestones.

	CaO	MgO	MnO	FeO	CO <sub>2</sub>	SiO <sub>2</sub>	Al <sub>2</sub> O <sub>3</sub>	Fe <sub>2</sub> O <sub>3</sub>	K <sub>2</sub> O	Na <sub>2</sub> O	H <sub>2</sub> O	SO <sub>3</sub>	P <sub>2</sub> O <sub>5</sub>	Cl	I	Org.	FeS <sub>2</sub>	Totals.	
I ...	26.60	17.41	.....	0.83	40.91	11.84	1.66	1.51	0.017	0.029	0.48	.....	Trace	0.05	Trace	α	.....	.....	100.436
II ...	30.79	21.14	Trace	0.24	46.84	0.21	0.27	0.21	0.030	0.062	0.22	Trace	Trace	0.10	.....	.....	0.03	Trace	100.142

α 0.000,022, 5 per cent.

I. Type of the Silurian or White Limestone. Coll. No. 164. From quarry in California gulch.

II. Type of the Lower Carboniferous or Blue Limestone. Coll. No. 170. Silver Wave claim, Iron Hill.

## REMARKS ON TABLE V.

The carbon dioxide and the water of the above analyses were estimated as in the case of the eruptive rocks; the one by loss in weight upon treatment with hydrochloric acid in a suitable apparatus, the other by absorption in a calcium chloride tube.

The organic matter of Analysis II was determined by an ordinary combustion analysis, after dissolving a considerable quantity of the rock in dilute hydrochloric acid and collecting and drying the insoluble matter upon an asbestos filter. The carbon dioxide formed was caught in potash bulbs and weighed. For 58 parts of carbon found, 100 parts of organic matter were assumed, as recommended by Fresenius.

The trace of iodine shown in Analysis I was detected and estimated by dissolving one pound of the dolomite in nitric acid, precipitating the chlorine and iodine as silver salts, reducing the latter by zinc and sulphuric acid, separating the iodine by addition of potassium nitrite, collecting it in carbon disulphide, and titrating with a dilute solution of sodium hyposulphite. Bromine could not be detected. The chlorine was determined on from five to ten grams of rock by precipitation with silver nitrate from a nitric acid solution.

The alkalis were estimated by igniting twenty grams of the finely powdered rock in small portions in a platinum crucible to expel carbon dioxide, extracting with water and proceeding as in ordinary alkali determinations. As the amounts of alkalis found did not exceed those required by the chlorine to form chlorides, but rather fell slightly below, due perhaps to partial volatilization during the preliminary calcination, it seems probable that the chlorine is combined with sodium and potassium, and possibly small quantities of calcium and magnesium.

It was found that by boiling the powder with water without previous calcination a portion of the chlorine and alkali could be extracted, and that the amount increased as the pulverization was more perfect. The total amount of chlorine thus capable of extraction never equaled that actually present in the rock, however. Microscopical examination showed the dolomites to be full of extremely minute fluid inclusions. If the chlorine was derived from these inclusions, where it might be held as sodium and potassium chlorides, a ready explanation is afforded for the incomplete extractibility of the chlorine by boiling water. By no mechanical pulverization could such a perfect subdivision of the particles be effected as to expose all the inclusions; a considerable proportion would still remain intact and retain a corresponding amount of chlorine.

TABLE VI.—Lime, magnesia, and chlorine determinations.

No.	Coll. No.	Horizon.	Locality.	CaCO <sub>3</sub>	αMgCO <sub>3</sub>	Cl
1	153	Cambrian	Below Excelsior mine, Buckskin gulch	25.43	4.03	Trace
2	153c	do	Monte Cristo Ridge, Quandary Peak	46.05	36.71	Do.
3	153a	Shurian	Dyer Mountain, marbled bed	53.16	43.43	Do.
b4	164	do	Quarry in California gulch	47.50	36.56	0.05
5	do	do	Below Dyer Mine, Dyer Mountain (light blue, compact).	36.27	21.73	Trace
6	do	do	Below Dyer mine, Dyer Mountain (pinkish, decomposed).	34.30	20.12	Do.
7	162	do	Red amphitheater, Buckskin gulch	49.30	32.49	Do.
b8	170	Blue Limestone	Silver Wave claim, Iron Hill	54.98	44.39	0.10
9	286	do	Dunkin mine, Fryer Hill (lime-sand)	55.14	44.29	Trace
10	285	do	Chrysolite mine, Fryer Hill (lime-sand)	54.09	43.79	Do.
11	170b	do	Empire Hill			Do.
12	170a	do	Ridge south of Sacramento mine	56.80	41.89	Do.
13	171b	do	Sacramento mine, Spring Valley	54.30	44.33	Do.
14	174	do	South slope of White Ridge, Horseshoe gulch	52.77	36.01	Do.
15	do	do	London mine, London Mountain	52.86	40.49	
16	291	Weber Grita	Ridge west of Mount Silverheels, Park County	54.34	43.82	Trace
17	197	do	East bank of Beaver Creek	54.32	43.24	Do.
18	292	do	Beaver Creek, west base of Mount Silverheels	53.91	43.73	
19	do	Upper Coal Measure	Robinson limestone, lower bed	87.87	6.03	
20	do	do	Robinson limestone, upper bed	97.11	Trace	
21	198	Trias	(Con. fracture) Silverheels, between Fairplay and Como	95.78	1.53	
22	198a	do	(Con. fracture) first ridge west of Crooked Creek	99.11	0.36	
23	416	do	(Con. fracture) Jacque Mountain, near summit	97.54	0.76	
24	do	Trias l.	Calcareous shale, near flume northeast of Fairplay	16.18	12.01	
25	do	do	do	34.84	26.35	
26	do	Lake beds	Marl from Greenback shaft, Graham Park	48.63	1.42	

α Includes (FeMn)CO<sub>3</sub>.

b Complete analysis in Table V.

N. B.—Blank spaces in above table denote that no tests were made.

## REMARKS ON TABLE VI.

The above figures for calcium and magnesium carbonates have been calculated from the lime and magnesia actually found. With exception of two numbers indicated by *b*, the chlorine was determined only qualitatively and noted as "trace," although generally present in quantity sufficient for estimation.

TABLE VII.—Serpentine and amphibole from dolomitic limestones.

No.	Coll. No.	SiO <sub>2</sub>	Al <sub>2</sub> O <sub>3</sub>	Fe <sub>2</sub> O <sub>3</sub>	FeO	MnO	CaO	MgO	K <sub>2</sub> O	Na <sub>2</sub> O	H <sub>2</sub> O	CO <sub>2</sub>	P <sub>2</sub> O <sub>5</sub>	Cl	Total
I	.....	40.15	0.93	1.28	1.05	.....	2.08	40.03	.....	.....	α12.88	1.60	Trace	.....	100.00
II	161	17.64	0.99	0.62	0.18	Trace	32.24	19.01	Trace	0.07	3.72	25.33	0.05	0.08	99.93
III	161a	55.21	2.02	0.38	3.19	0.20	13.50	23.20	.....	Trace	1.07	.....	.....	.....	98.97

α By difference.

I. A layer of pure serpentine on limestone from east side of Red Amphitheater, Buckskin gulch, Park County.

II. Limestone thoroughly impregnated with serpentine, producing a light-yellow rock. No pyroxene or amphibole visible under the microscope. Same locality.

III. Amphibole with some pyroxene from limestone containing serpentine. Same locality.

REMARKS ON TABLE VII.

In connection with the serpentine of Analysis I, it was found by treatment of the powdered rock with very dilute hydrochloric acid that the carbon dioxide was combined entirely with lime. That the rock is a true serpentine appears from a calculation of the oxygen ratios:

Oxygen percentages.	Oxygen ratios.
SiO <sub>2</sub> = 21.413	RO(FeOMgO) : SiO <sub>2</sub> : H <sub>2</sub> O 1 : 1.318 : 0.705 3 : 3.95 : 2.11 Required by theory 3 : 4 : 2
FeO = 0.233 } 16.245	
MgO = 16.012 }	
H <sub>2</sub> O = 11.449	

Analysis II, after deducting calcium carbonate, shows the residue to have a composition approximating to that of serpentine.

The mineral of which III is the analysis was obtained in an apparently pure state by treatment with dilute hydrochloric acid, whereby 16½ per cent. of the whole went into solution and was found to consist chiefly of calcium carbonate, with a little magnesia, ferrous oxide, and phosphorus pentoxide.

ORES AND VEIN MATERIALS.

TABLE VIII.—Sand carbonates.

	I.	II.	III.
	Adelaide.	Little Chief.	Waterloo.
PbO .....	80.352	75.408	77.980
Al <sub>2</sub> O <sub>3</sub> .....	0.444	1.415	.....
Fe <sub>2</sub> O <sub>3</sub> .....	0.467	1.940	.....
FeO .....	0.299	.....	.....
MnO .....	0.137	0.074	.....
MnO <sub>2</sub> .....	.....	1.386	.....
CoO .....	Trace	Trace	.....
ZnO .....	.....	0.095	.....
CaQ .....	0.303	0.335	.....
MgO .....	0.068	0.056	.....
SiO <sub>2</sub> .....	0.651	1.972	.....
Sb <sub>2</sub> O <sub>3</sub> .....	.....	0.121	.....
As <sub>2</sub> O <sub>3</sub> .....	Trace	Trace	.....
P <sub>2</sub> O <sub>5</sub> .....	1.532	Trace	6.480
SO <sub>3</sub> .....	Trace	0.480	.....
CO <sub>2</sub> .....	14.700	14.251	10.180
Cl .....	0.255	0.288	0.840
H <sub>2</sub> O .....	0.395	1.140	.....
Ag .....	0.009	0.777	0.047
Au .....	Trace	Trace	.....
Total .....	99.612	99.744	.....
Less O for Cl ..	0.057	.....	.....
	99.555	.....	.....

- I. Sand Carbonate, Ore Coll. No. 30, Adelaide mine, North Iron Hill.
- II. Sand Carbonate, Ore Coll. No. 33, Little Chief mine, Fryer Hill.
- III. Sand Carbonate, Waterloo mine, Carbonate Hill.

## REMARKS ON TABLE VIII.

Consideration of Analysis I shows that the carbon dioxide is insufficient for combination with all the lead oxide, and that the chlorine (entirely soluble in nitric acid) and the phosphorus pentoxide bear to one another the exact ratio of chlorine and phosphorus pentoxide in the mineral pyromorphite;  $3(3\text{PbO}, \text{P}_2\text{O}_5) + \text{PbCl}_2$ . Calculating from the chlorine there is found to be 9.75 per cent. of this mineral. The carbon dioxide is, then, somewhat more than sufficient for the remaining lead oxide, forming 86.60 per cent. of cerussite,  $\text{PbCO}_3$ .

The silver exists in the state of chloride, as shown by extracting it from a large amount of ore with ammonia.

A portion of the ferrous oxide is present as magnetite. The slight excess of carbon dioxide above that required for the lead is probably combined with ferrous, manganese, and calcium oxides.

Analysis II shows plainly that pyromorphite is practically absent from the specimen of ore from the Little Chief mine. The lead exists mainly as carbonate, with a little sulphate, and probably a small amount of antimoniate. A yellow substance left unattacked with the silica and silver chloride ore, on treating with nitric acid, gave reactions for lead and antimony. The silver exists altogether in the state of chloride and could be completely extracted by ammonia. The total chlorine, found by fusion with alkaline carbonates, extraction with water, and subsequent precipitation with silver nitrate, is slightly in excess of that required by the silver, but it was found that a few hundredths of 1 per cent. was present in a combination soluble in water.

Only the chief constituents from the ore in the Waterloo mine (Analysis III) were estimated. Starting from the chlorine, which represents that soluble in nitric acid alone, the ore is found by calculation to contain 32.07 per cent. of pyromorphite and 61.78 per cent. of cerussite, the carbon dioxide exactly sufficing for the lead oxide left after combining the elements of pyromorphite. An excess of 1.44 per cent. phosphorus pentoxide is probably combined with alumina, of which a considerable amount was found to be present.

TABLE IX.—*Chloro-bromo-iodides of silver.*

	I.	II.	III.	
Cl .....	13.78	0.80	99.925	I. Ore Coll. No. 39. Robert E Lee mine, Fryer Hill.
Br .....	85.63	89.99	.....	
I .....	0.59	0.21	0.075	
	100.00	100.00	100.000	II. Ore Coll. No. 30c. Anie mine, Fryer Hill.
AgCl .....	21.50	15.75	99.966	III. Ore Coll. No. 37. Big Pittsburgh mine, Fryer Hill.
AgBr .....	77.90	84.09	.....	
AgI .....	0.42	0.16	0.034	
	100.00	100.00	100.000	

## REMARKS ON TABLE IX.

The figures in the upper series represent the relative proportions of Cl, Br, and I; those in the second series, the percentages of the corresponding silver salts.

The ore specimens, having first been treated with nitric acid to extract any soluble chlorine salts, were then subjected to the reducing action of zinc and sulphuric acid, whereby the silver salts were entirely reduced. To the filtered solution, containing all the chlorine, bromine, and iodine, potassium nitrite was added, the liberated iodine collected in carbon disulphide, separated with the latter by filtration, and estimated by titration with dilute sodium hyposulphite solution. The chlorine and bromine were then thrown down by silver nitrate, the precipitate was washed thoroughly by decantation, brought entirely into a tared vessel, fused, and weighed. As sufficient material had been taken to insure several grams weight of mixed chloride and bromide, the estimation of the halogens by entire conversion into silver chloride in a current of chlorine gas was repeated on different portions with very closely agreeing results, of which the above are the mean. In Analysis III a qualitative test failed to indicate the presence of a trace of bromine, and the fused silver chloride, when heated in chlorine gas, showed no change whatever in weight. The silver in the ore, reduced by the action of zinc and sulphuric acid, was not estimated. The figures in the second horizontal series above are therefore obtained by calculation from the chlorine, bromine, and iodine found. In Analysis I the proportion of AgCl:AgBr is 4:11, while in Analysis II it is 1:4.

TABLE X.—Various ores and vein materials.

N. B.—With the exceptions noted, blanks in the table denote "no tests."

1. "Hard carbonate," Scooper mine, Yankee Hill.
2. "Silicious ore," El Capitan mine, Taylor Hill.
3. "Gold ore," Ore Coll. No. 60, El Capitan mine, Taylor Hill.
4. Silicious hematite, Ore Coll. No. 84, Chrysolite mine.
5. "Iron ore," Ore Coll. No. 90, Kenosha mine, Long and Derry Hill.
6. Altered limestone (light material), Garden City mine.
7. Altered limestone (dark material), Garden City mine.
- 8, 9, and 10. Specimen showing pyrite altering to a light ochreous mass. Ore Coll. No. 44, No Name gulch, Lake Co.
8. Nucleus of pyrite. 9. Dark zone. 10. Light outer zone.
11. White filling in chert nodule from porphyry, Ore Coll. No. 300b, Ben Burb shaft.
12. Chert nodule, Ore Coll. No. 299, El Paso shaft.
13. Breccia with ore cement, Ore Coll. No. 53, Evening Star mine.
14. Chert under ore body, Little Pittaburgh mine.
15. Granular quartz under ore, Ore Coll. No. 3a, Waterloo mine.

	1	2	3	4	5	6	7	8	9	10	11	12	13	14	15
Insoluble.	60.00	.....	.....	8.20	.....	.....	.....	7.36	16.36	54.28	.....	.....	.....	.....	.....
SiO <sub>2</sub> .....	.....	82.400	11.560	.....	.....	10.08	20.02	.....	.....	.....	a98.03	b96.3	c84.2	97.9	d81.29
PbO .....	.....	Trace	None	.....	.....	.....	.....	.....	.....	.....	.....	.....	.....	.....	.....
FeS <sub>2</sub> .....	.....	.....	.....	.....	.....	.....	.....	53.61	.....	.....	.....	.....	.....	.....	.....
Fe <sub>2</sub> O <sub>3</sub> .....	13.91	10.380	77.600	54.14	7.70	} 0.81	} 0.97	} 34.44	73.42	39.84	.....	.....	.....	.....	.....
Al <sub>2</sub> O <sub>3</sub> .....	.....	4.160	.....	.....	None						.....	.....	.....	.....	.....
MnO <sub>2</sub> .....	0.10	.....	.....	22.30	65.98	0.39	1.56	.....	.....	.....	.....	.....	.....	.....	.....
ZnO .....	.....	.....	.....	2.56	1.00	.....	.....	.....	.....	.....	.....	.....	.....	.....	.....
CaO .....	.....	} e1.217	e0.6094	} .....	} .....	27.17	24.15	.....	.....	.....	.....	.....	.....	.....	.....
MgO .....	.....					.....	.....	.....	.....	19.49	16.71	Trace	e0.09	e0.06	.....
CO <sub>2</sub> .....	.....	.....	.....	.....	.....	f12.78	f37.37	.....	.....	.....	.....	.....	.....	.....	.....
SO <sub>2</sub> .....	.....	.....	.....	.....	.....	.....	.....	.....	Trace	Trace	.....	.....	.....	.....	.....
H <sub>2</sub> O .....	g5.978	1.830	10.230	h12.709	4.22	.....	.....	.....	.....	.....	.....	.....	.....	.....	.....
Ignition .....	.....	.....	.....	.....	.....	.....	.....	.....	10.13	5.82	.....	.....	.....	.....	.....
Ag .....	0.012	0.002	0.0002	0.031	.....	.....	.....	.....	.....	.....	.....	.....	.....	.....	.....
Au .....	Trace	0.011	0.0004	None	.....	.....	.....	.....	.....	.....	.....	.....	.....	.....	.....
Totals..	100.000	100.000	100.000	100.000	i78.90	100.72	100.78	j95.41	100.00	100.00	.....	.....	.....	.....	.....

a Remainder Fe<sub>2</sub>O<sub>3</sub> and Al<sub>2</sub>O<sub>3</sub>, no water.b Remainder Fe<sub>2</sub>O<sub>3</sub> and Al<sub>2</sub>O<sub>3</sub>. Of the SiO<sub>2</sub> 3.06 per cent. was soluble in a moderately strong solution of potassium hydrate.

c Cementing material chiefly pyromorphite, with some galena and cerussite, also a little calcite.

d Remainder chiefly PbCO<sub>3</sub> and Fe<sub>2</sub>O<sub>3</sub>; of the silica 3.93 per cent. was soluble in a moderately strong solution of potassium hydrate.

e By difference.

f Calculated.

g By difference; includes some PbO and Sb<sub>2</sub>O<sub>3</sub>.h By difference; includes a little Sb<sub>2</sub>O<sub>3</sub>.i Remainder chiefly SiO<sub>2</sub>.j Remainder is SO<sub>2</sub> and H<sub>2</sub>O.

## REMARKS ON TABLE X.

The analyses of the above table were made without view to completeness, the object being in the majority of cases to ascertain merely the general nature of the ore or material under hand. As this appears at a glance from the tabulated results, further remarks are unnecessary except in the case of 8, 9, and 10. The specimen showed a nucleus of granular pyrite in process of decomposition, ferric oxide being observable throughout the mass. This very irregular nucleus was inclosed in an envelope of dark-



brown hydrated ferric oxide, the boundaries being in places rather sharply defined, in others indistinct. The dark zone was in turn surrounded by a zone of light-brown oxide, the line of demarcation being very regular and sharply defined. The dark oxide was compact and flinty; the light oxide also compact, but less hard.

TABLE XI.—*Alteration products of porphyry.*

No.	Ore Coll. No.	Local name.	SiO <sub>2</sub>	Al <sub>2</sub> O <sub>3</sub>	Fe <sub>2</sub> O <sub>3</sub>	FeO	ZnO	CaO	MgO	K <sub>2</sub> O	Na <sub>2</sub> O	H <sub>2</sub> O	SO <sub>3</sub>	Totals.
1	55b	Kaolin.....	48.72	34.01	0.56	0.66	.....	.....	1.11	9.88	0.67	4.42	.....	100.03
2	55a	Chinae talc	43.36	37.78	.....	.....	.....	0.22	0.30	Trace	.....	17.95	Trace	99.91
3	56c	Kaolin.....	4.55	35.60	2.26	.....	.....	Trace	Trace	2.73	5.28	15.05	34.55	100.00
4	56	Chinese talc	24.47	38.05	0.93	0.77	.....	0.23	0.30	2.72	1.30	16.67	15.48	101.15 <sup>a</sup>
5	56b	...do.....	27.89	33.79	.....	.....	.....	0.53	1.14	2.83	1.56	16.51	15.75	100.00
6	105a	...do.....	35.33	10.38	.....	.....	33.05	1.62	0.71	.....	.....	19.06	.....	100.15
7	105a	...do.....	35.97	8.81	.....	.....	35.40	1.87	0.80	.....	.....	17.46	.....	100.31
8	105b	...do.....	37.54	24.76	0.64	.....	18.43	0.63	0.71	0.66	0.36	10.37	.....	100.10

<sup>a</sup> Includes 0.23 P<sub>2</sub>O<sub>5</sub>.

<sup>b</sup> By difference.

<sup>c</sup> Present as a visible impurity.

1. Amic mine, in ore body. Ore Coll. No. 55b.
2. New Discovery mine. Ore Coll. No. 55a.
3. Big Pittsburg, contact of Gray Porphyry. Ore Coll. No. 56b.
4. Morning Star mine. Ore Coll. No. 50.
5. Swamp Angel tunnel, contact of White Porphyry. Ore Coll. No. 56b.
6. Lower Waterloo mine. Ore Coll. No. 105a.
7. Lower Waterloo mine. Ore Coll. No. 105a.
8. Lower Waterloo mine. Ore Coll. No. 105b.

REMARKS ON TABLE XI.

Owing to the indefinite nature of the greater part of the peculiar products of alteration represented by analysis in the above table, it is impossible to ascribe to them distinctive names. Notwithstanding the great external similarity of all but the first of the specimens examined, they have been found to differ most widely in composition, though, aside from the above exception, three distinct groups may be recognized, namely: First, simple hydrated aluminium silicates allied to kaolinite; second, mixed aluminium silicates and aluminium and alkali sulphates, likewise hydrated; and, third, certain hydrated aluminium and zinc silicates, also mixtures.

In the following are given the distinctive physical and chemical characteristics, accompanied by brief discussions of the analytical results:

No. 1, grayish white; compact, but of hardness considerably less than 1, rubbing off on the fingers; luster, pearly; insoluble in hydrochloric acid. Evidently derived directly from porphyry, since honeycombed remnants of feldspar crystals, and even large crystals, an inch in length, showing rough faces, occur imbedded in the mass. Under the microscope it appears to consist of crystalline scales without definite form.

In order to obtain material for analysis free from undecomposed feldspar, it was slightly crushed and stirred with water in a beaker, whereby it became thoroughly disintegrated, the fine matter floating and imparting to the water a beautiful satiny appearance similar to that frequently observable in streams receiving the tailings from

stamp mills, while the gritty particles fell to the bottom. By pouring off the suspended matter, allowing to settle, decanting the supernatant liquid, and drying the slimy deposit, an apparently pure matter was obtained, showing the pearly luster of the original mass, and containing, like that, when air-dried, about one-quarter of 1 per cent. of hygroscopic moisture. This is not included in the above analysis. No further loss occurred on prolonged heating until a temperature considerably above 100° C. was reached, while a strong red heat was requisite for complete expulsion of the water.

No altogether satisfactory formula can be deduced from the figures in the table. On dividing the molecular value by that for water, as being most accurately determined, the ratio is found to be

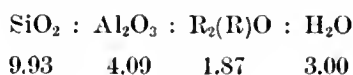

or, approximately,

$$10 : 4 : 2 : 3.$$

As no other specimens of a similar nature, from the Amie or other mines, have been observed, by analysis of which it could be ascertained whether the above ratio remains constant or not, it would be rash to affirm that the material analyzed represents a distinct mineral species, the final product of the alteration of the porphyry from which it is derived.

No. 2, pure white, veined with manganese dioxide; compact, hardness about 2, rubbing off on the fingers when dry. When fresh and moist, frequently greenish in color, opaline in appearance, and semi-transparent, especially on the thin edges, becoming opaque on exposure. Insoluble in hydrochloric acid. Portions free from  $\text{MnO}_2$  taken for analysis.

It was found that after two or three years' exposure to the air a large amount of water, 3.36 per cent. of that given in the analysis, was still retained in a very weak state of combination, apparently as hygroscopic moisture, since it escaped over sulphuric acid. No further loss occurred on heating at 100° C., nor below 160° C. to 170° C., although blackening took place, due to carbonization of organic matter. Dried over sulphuric acid or at 100° C., the powder was so extremely hygroscopic that it was deemed advisable to make the analysis upon air-dried material. The percentage of loosely combined or hygroscopic water was found to decrease slowly on long exposure of lumps to the air, so slowly as to be perceptible only at intervals of a month or more. Deducting all water driven off at 100° C., the molecular ratio  $\text{SiO}_2 : \text{Al}_2\text{O}_3 : \text{H}_2\text{O}$  is 1.98 : 1.00 : 2.20, thus showing the substance to be closely allied to kaolinite.<sup>1</sup>

Nos. 3, 4, and 5. In general appearance 4 and 5 differ little from the substance last described. Color, white, streaked frequently with iron and manganese oxides; hardness, after long exposure, in case of 5, about 2½. Practically insoluble in hydrochloric acid. No. 3 is pure white, and resembles 1; it contained no hygroscopic water. No. 4 contained but 1.23 per cent.; while No. 5 retained 4.58 per cent. of the same (included in the analysis), after long exposure to the air in the form of lumps.

<sup>1</sup>The same is found in the Morning Star consolidated group of mines according to L. D. Ricketts, one of whose published analyses (*The Ores of Leadville, Princeton, 1883*) shows a ratio  $\text{SiO}_2 : \text{Al}_2\text{O}_3 : \text{H}_2\text{O} = 2 : 1 : 3$ , probably including hygroscopic or weakly combined water.

The air-dried material of 4 and 5 was analyzed, since, when dried over sulphuric acid or at 100° C., the hygroscopicity was such as to render accurate weighing out of the question. In very few hours No. 5 reabsorbed, when exposed in the air, over half of the 4.58 per cent. of moisture lost at 100° C.

Consideration of the analyses, coupled with the observed insolubility in hydrochloric acid, shows beyond reasonable doubt that these bodies are mixtures of alunite,  $K_2SO_4 + (Al_2)S_3O_{12} + 2H_6(Al_2)O_6$ , corresponding in formula to the jarosite of the following table, or of an allied mineral, with different indefinite hydrated aluminium-calcium-magnesium silicates. If the supposed alunite is calculated on the basis of the sulphuric acid, the residual amounts of silica, alumina, lime, magnesia, alkalis, and water are found to have widely different and not very definite molecular ratios in each analysis.

From the fact of No. 3, which is mainly an aluminium-alkali sulphate, containing no weakly combined or hygroscopic water, the hygroscopicity appears to be a property of the hydrated aluminium silicates.

Nos. 6, 7, and 8. Similar in appearance to the simple hydrated aluminium silicates represented by analysis 2. Nos. 6 and 7 were taken by Mr. L. D. Ricketts from one locality in the mine, No. 8 from another. The first and second were not to be distinguished from each other by the eye, being brilliantly white (greenish under certain conditions of light), opaline and semi-transparent, while the third was veined with iron and manganese oxides and possessed in a less degree the pronounced conchoidal fracture of the others. On exposure they became opaque, and after some months possessed a hardness of about 3. Nos. 6 and 7 were entirely and readily decomposed by strong hydrochloric acid when finely pulverized, while upon 8 the action of the acid was not so marked, though still energetic. The hygroscopicity of these substances, especially of the first and second, is extraordinary. Over sulphuric acid No. 6 lost 11.64 per cent. of water, while No. 7 lost 10.26 and No. 8 but 5.30 per cent., these amounts being included in the tabulated results of analysis. Exposure to a temperature of 100° C., and even 150° C., occasioned no further loss in weight, but the presence of organic matter made itself manifest by the blackening of the powder. The dried material reabsorbed moisture with great rapidity. It was at first supposed that these were mixtures of calamine with some hydrated aluminium silicate. But if from the molecular values those for zinc oxide are eliminated and proportionate amounts for silica and water subtracted, on the supposition that calamine is present, the ratios between the remaining molecular values are not the same as should be the case if the mixture consisted in all these cases of calamine and one other definitely constituted mineral. Moreover, on decomposing with hydrochloric acid no gelatinization takes place, and *not even a trace* of silica goes into solution, an argument against the possibility of the presence of either calamine or willemite. The molecular values, considered altogether for each analysis, do not present relations sufficiently definite to allow of supposing any one of the specimens to represent a single mineral species.

TABLE XII.—*Alteration products of galena and pyrite.*

No.	Ore Coll. No.	SiO <sub>2</sub>	Fe <sub>2</sub> O <sub>3</sub>	Al <sub>2</sub> O <sub>3</sub>	CaO	MgO	K <sub>2</sub> O	Na <sub>2</sub> O	H <sub>2</sub> O	PbO	Bi <sub>2</sub> O <sub>3</sub>	As <sub>2</sub> O <sub>3</sub>	P <sub>2</sub> O <sub>5</sub>	SO <sub>3</sub>	Cl	Totals.
1	106a	None	46.70	None	0.06	0.06	5.33	1.68	10.54	4.27	0.08	0.46	0.08	30.53	0.02	99.81
2	106b	0.30	42.08	0.20	0.64	None	0.31	0.83	10.12	8.27	None	0.42	1.58	27.81	0.26	99.72
3	106c	0.36	44.40	0.23	None	None	0.15	0.37	8.99	19.50	None	0.30	0.11	25.07	0.04	99.1
4	106d	.....	.....	.....	.....	.....	2.12	0.57	.....	.....	.....	.....	.....	.....	.....	.....
5	106e	.....	.....	.....	.....	.....	0.36	0.77	.....	.....	.....	.....	.....	.....	.....	.....
6	106f	.....	.....	.....	.....	.....	1.90	0.18	.....	.....	.....	.....	.....	.....	.....	.....
7	106g	.....	.....	.....	.....	.....	4.04	0.57	.....	.....	.....	.....	.....	.....	.....	.....

1. From Maid of Erin mine, under White Porphyry. Contains 0.0048 Ag and trace of Au.
2. From Morning Star (Forsaken) mine, under Gray Porphyry. Contains 0.0036 Ag.
3. From Lower Waterloo mine, under Gray Porphyry. Contains 0.075 Ag.
4. From Morning Star (Forsaken), under Gray Porphyry.
5. From Morning Star (Forsaken), under Gray Porphyry.
6. From Morning Star (Forsaken), under Gray Porphyry.
7. From Silver Cord mine, under White Porphyry.

## REMARKS ON TABLE XII.

Notwithstanding the great similarity in appearance of all the specimens of which the above are analyses they are rather complex mixtures in very varying proportions of several mineral substances. They all show a similar chemical behavior. Heated in a closed tube, water is first evolved, the substance then changes from an ochreous, or sometimes brownish yellow, to dark brown, and later sulphuric and sulphurous acids escape. The same changes occur in an open tube. On charcoal with soda there appears sometimes a slight coating of arsenic trioxide, accompanied by a smell of arsenic and the reaction for lead. Entirely insoluble in boiling water. Nitric acid in the cold extracts part of the lead oxide; also, arsenic and phosphorus pentoxides and usually chlorine. Continued boiling with nitric acid seems to decompose the iron minerals completely. Warm hydrochloric acid effects complete decomposition, and no trace of a ferrous salt can be detected, even if solution has been effected in an atmosphere of carbon dioxide. Caustic alkalis also decompose them completely, all the sulphur trioxide and arsenic and phosphorus pentoxides going into solution, whereby the analysis is materially simplified. Various tests, combined with a consideration of the three complete analyses, show that the lead is present as anglesite and pyromorphite<sup>1</sup>: in No. 2 as the latter mineral alone, the lead oxide, phosphorus pentoxide, and chlorine being in the exact proportions required for the formula  $(3\text{PbO}, \text{P}_2\text{O}_5) + \text{PbCl}_2$ . The  $\text{As}_2\text{O}_3$  is not present in the corresponding chloro-arsenate of lead, as shown by the fact that the proportion of  $\text{P}_2\text{O}_5$  to that part of the Cl not combined with silver is always the same as in pyromorphite, and that there is insufficient lead for both phosphorus and arsenic pentoxides together, as in No. 2, where it exactly suffices for the phosphorus pentoxide. The arsenic pentoxide is therefore undoubtedly present as a hydrated ferric arseniate. By combining in the first place chlorine and phosphorus pentoxide with lead oxide and the remainder of the latter with sulphur trioxide, definite conclusions may be reached as to the composition of the remainder of the mixture. Analyses

<sup>1</sup>The pyromorphite is sometimes visible in bunches of small crystals.

1 and 2 (especially the latter) show that the chief constituent in these cases is probably *jarosite*,  $K_2SO_4 + (Fe_2)S_3O_{12} + 2H_6(Fe_2)O_6$ . As there remains a slight excess of  $SO_3$  and  $Fe_2O_3$  after combining the constituents of this mineral on the basis of the alkalis present, a basic ferric sulphate is to be assumed as a further constituent of the mixture.

Analysis 3 shows little pyromorphite, much anglesite, little jarosite, and much hydrated basic ferric sulphate, of which latter it is impossible to determine the formula definitely, since it is not known how much ferric oxide and water may be combined with the arsenic pentoxide.

The remaining partial analyses were made to ascertain whether or not the alkalis were constant constituents of this class of products of alteration of the original vein material. Qualitative tests showed that pyromorphite and anglesite were occasionally present in greater amount than shown in analyses 1, 2, and 3. Arsenic pentoxide was found in very considerable quantity in the material from the Silver Cord mine (7).

TABLE XIII.—Miscellaneous alteration products.

No.	Rock.	Locality.	SiO <sub>2</sub>	Fe <sub>2</sub> O <sub>3</sub> } Al <sub>2</sub> O <sub>3</sub> }	K <sub>2</sub> O	Na <sub>2</sub> O	Soluble in HCl.	Loss by ignition.	Totals.
1	Altered White Porphyry .....	London mine .....	71.2	14.5	3.3	0.7	a10.0	.....	99.7
2	.....do.....	.. do .....	72.8	.....	.....	.....	.....	.....	.....
3	.....do.....	New York mine ..	75.8	.....	.....	.....	.....	.....	.....
4	Altered White Limestone.....	Buffalo Peaks....	97.1	.....	.....	.....	.....	.....	.....
5	Altered Blue Limestone .....	.. do .....	97.7	.....	.....	.....	.....	.....	.....
6	.....do.....	.. do .....	78.9	.....	.....	.....	.....	.....	.....
7	Flint Kernel b .....	.. do .....	e98.16	.....	.....	.....	.....	1.84	100.00
8	Altered opaline coating d.....	.. do .....	e97.42	.....	.....	.....	.....	2.58	100.00

a Consists of calcium carbonate, with a little magnesium and less manganese carbonate.

b Specific gravity at 18½° C. = 2.570. Hardness, 6.

c Soluble in strong solution of potassium hydrate after four to five hours' digestion = 65.73 per cent.

d Specific gravity at 16½° C. = 2.023. Hardness 5.5.

e Soluble in strong solution of potassium hydrate after four to five hours' digestion = 97.42.

TABLE XIV.—Assays of ores, vein materials, and country rocks.

No.	Ore Coll. No.	Name.	Mine.	Remarks.	Ag.	An.
		<i>Ores.</i>				
					<i>Oz. per ton.</i>	<i>Oz. per ton.</i>
1		Sand carbonate	Matchless, near Hibernta	Crystals of cerussite	682.90	None
2	35b	do	Morning Star, fourth level north	Compact	10.00	Trace
3	35d	do	Morning Star, first level south	White sand	41.00	None
4	35c	do	Waterloo, on Forsaken line	Dark colored	13.80	Do.
5	35c	do	do	do	25.40	Trace
6	91	do	Long and Derry		22.10	None
7	40	Chloride	Evening Star, on Catalpa line, second level.	With cerussite	82.20	Trace
8	45	Hard carbonate	Dunkin, between first and second levels.		17.90	Do.
9	42a	do	Evening Star, on Morning Star line		33.80	None
10		do	Niles-Angusta		93.40	Do.
11		do	do	In limestone	81.00	Trace
12	41	do	Scooper, east drift	Very silicious	3.50	Do.
13	26a	Galena and cerussite	Dunkin, upper level		353.20	None
14	27	do	Henriett lower		516.40	Do.
15	27o	Galena	Waterloo, near Forsaken line		420.00	Trace
16	27e	Cerussite crust on No. 15.	do		28.60	None
17		Galena	Dunkin, above ore-body	Cementing porphyry breccia.	443.80	Do.
18	27b	Galena, blende, and pyrite.	A. Y. mine, 150 feet deep		9.80	Do.
19	28d	Galena and pyrite	Ontario, Breece Hill	Gash vein in porphyry.	20.00	Trace
20	51	Copper ore	Florence, winze on north drift		2.90	Strong tr
21	49	Gold ore	do		2.00	0.10
22	48	do	Lower Printer Boy, middle shaft, second station.		0.50	Strong tr
		<i>Vein materials.</i>				
23	13	Silicious hematite	Vanderbilt, at 120 feet		10.00	Trace
24	84	do	Chrysolite		9.10	None
25		Silicious iron	Amie, lower body	Hydrated	2.90	Do.
26		do	New Discovery	Jaspers	0.50	Do.
27		do	Across the Ocean	Cavernous	1.10	Do.
28		Black iron	Chrysolite-Vulture No. 1	Manganiferous	7.80	0.20
29		do	Climax, upper working	do	3.90	None
30		Hematite	Breece Iron, upper shaft	do	0.30	Do.
31		do	do	With pyrite	Trace	Do.
32		Pyrolusite	Crescent, lower shaft	Barren contact	4.00	Do.
		<i>Country rocks.</i>				
33		Blue Limestone	Catalpa, east incline, near bottom	Black and altered	0.50	Do.
34		do	do	Another specimen	0.30	Do.
35		White Limestone	Climax, lower level south	Altered contact	0.40	Do.
36		do	Amie No. 2, 273 feet deep	Altered	0.50	Trace
37		Lime-sand	Dunkin, north end third level	Altered Blue Limestone	0.70	None
38		do	Chrysolite, west of Vulture No. 1	Near rich ore body	85.70	Trace
39		do	Chrysolite, near Little Chief line	In ore body	0.70	Do.
40		do	Chrysolite, second level, northwest end.	In porphyry	0.40	None

---

APPENDIX C

---

METALLURGY

BY

ANTONY GUYARD

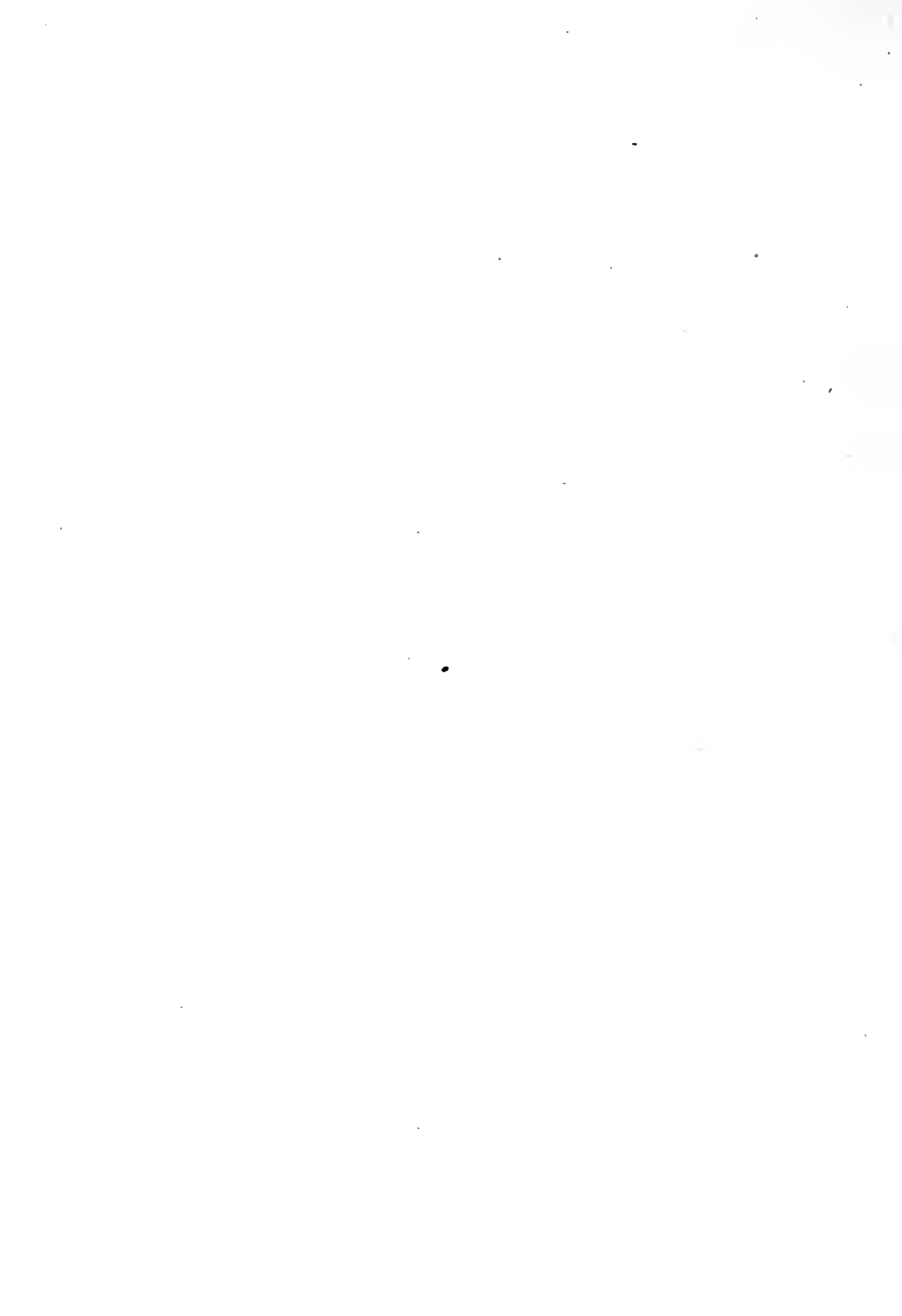



# CONTENTS.

	Page
Introduction .....	613
SECTION I. PRELIMINARY CONDITIONS OF SMELTING.	
Leadville .....	614
Mines .....	614
Ores .....	616
Composition of ores .....	617
Smelting works .....	625
Ore-buying .....	627
Sampling .....	628
Crushing .....	629
Assaying .....	632
SECTION II. MATERIALS USED IN SMELTING.	
General considerations .....	636
Statistics of Leadville smelters .....	637
Construction materials .....	641
Fuels and fluxes .....	641
Ore beds .....	648
Smelting charges .....	649
Résumé .....	659
SECTION III. PLANT AND SMELTING OPERATIONS.	
Smelting plant in general .....	659
Furnaces .....	659
Blast apparatus .....	661
Smelting operations in general .....	664
Costs and profits of smelting .....	668
Plant and operations of individual smelters .....	669
Smelter A .....	669
Smelter B .....	672
Smelter C .....	674
Smelter D .....	679
Smelter E .....	680
Smelter F .....	681
Smelter G .....	683
Smelter H .....	685
Smelter I .....	688
Smelter J .....	688
Smelter K .....	689
Smelter L .....	690

	Page.
Plant and operations of individual smelters—Continued.	
Smelter M .....	690
Smelter N .....	691
Smelter O .....	691
Smelter P .....	691

## SECTION IV. PRODUCTS OF SMELTING.

Bullion .....	692
Slag .....	698
Chamber dust .....	711
Speiss .....	719
Iron sows or salamanders .....	722
Mattes .....	723
Accretions .....	725

## SECTION V. THEORETICAL DISCUSSION.

Reactions in the blast-furnaces .....	731
Reactions of lead compounds .....	732
Reactions of silver compounds .....	735
Reactions of iron compounds .....	736
Chemical discussion of the Leadville furnaces .....	737
Conclusions .....	745
List of metallurgical plates .....	749
Index of letters used on plates .....	751

# ARGENTIFEROUS LEAD SMELTING AT LEADVILLE.<sup>1</sup>

## INTRODUCTION.

When Mr. S. F. Emmons intrusted me with the duty of reporting on the smelters of Leadville, he directed me to insist on the mechanical appliances offering a special interest, to lay special stress on the chemical phenomena of the blast furnaces, and to examine carefully the different furnace products of the smelting works. The fact that metals and other substances sparingly distributed throughout the mineral deposits of the Leadville mining camp are concentrated in these products gave a special interest in this study, which had a direct bearing upon the geology and mineralogy of the district under survey.

The fine analytical laboratory of the Survey in Denver made this study possible; and I trust that the numerous new facts and discoveries resulting from it will prove interesting and useful, not only to the metallurgist and miner, but also to the chemist and geologist.

In order to render as intelligible as possible the description of the plant, apparatus, and implements used in smelting in Leadville, I took the measurement of the most interesting portions, and made from them rough sketches, which were afterwards completed and corrected by Mr. W. H. Leffingwell, assistant topographer of the Survey. The disposition of the inside of inaccessible parts, such as the dust-chambers, was explained to me by the superintendents of the smelters. Some tracings of furnaces, blast apparatus, and dust-chambers were kindly given by Messrs. Billing and Eilers, owners of the Utah smelter; James Brierton, of the Harrison Reduction Works; August Werner, of the Elgin Smelter; and by Messrs. Fraser and Chalmers, of Chicago, manufacturers of a great number of the furnaces and smelting implements used in Leadville. The full description of the crushers and blowers was also kindly communicated to me by the respective manufacturers. The sketches accompanying this report, most of which are drawn to scale, have been prepared from these data by Mr. Morris Bien, assistant topographer, and engraved by Mr. Julius Bien, the well-known engraver.

---

<sup>1</sup>In consequence of the sudden death of Mr. Antony Guyard at Paris, France, on the 29th of March, 1884, it was impossible to have his aid in the final revision of this report for the press. In making this revision I have received most important assistance from Mr. W. F. Hillebrand, who was present in the laboratory at the time Mr. Guyard was making his analyses. We have confined our changes to obvious clerical errors in calculations, and to minor alterations of language which would render his meaning clearer, changes which in no way affect his conclusions. It is possible that could Mr. Guyard have been personally consulted he might have made other modifications in his report, but, in view of his great experience and reputation as a metallurgical chemist, I have not felt authorized to do more than offer a few suggestions in foot-notes, where his meaning seems obscure or liable to be misunderstood. (S. F. E.)

During my visits to the smelters, I was received everywhere with the greatest courtesy, both by miners and superintendents, supplied with all information, and allowed to inspect thoroughly every part of the works. I was at the same time requested not to publish the names of the smelters in connection with information which might betray their private interests. In compliance with this request, in the following report the principal smelters have been designated by letters in all cases where it seemed possible that the publishing of their names might be detrimental to their interests. All analyses, where not otherwise specifically designated, have been made by me in the laboratory of the Survey.

## SECTION I.

### PRELIMINARY CONDITIONS OF SMELTING.

#### LEADVILLE.

**Situation.**—The city of Leadville is situated 10,150 feet above the level of the sea, in the Rocky Mountains, valley of the Arkansas, California mining district, Lake County, State of Colorado. It is placed in direct communication with Denver, the capital of Colorado, and thence with the east, by means of the Denver and South Park Railroad and the Denver and Rio Grande Railroad, both lines running on the same track between Buena Vista and Leadville.

The young city of Leadville, which did not exist three years ago, is full of bustle, life, and excitement, and had a population at the last census (1880) of about 15,000 inhabitants, but which fluctuates a good deal. It is built on a mesa or terrace formed of rearranged moraine material brought down by large glaciers which once existed there, and is surrounded on all sides by hills and mountains rising from three to four thousand feet above its level. The most conspicuous points are: on the west side, Mount Elbert and Mount Massive; on the east side, Ball Mountain, the Mosquito Pass, and Mount Sheridan; and on the north side, Mount Zion, above the Arkansas River.

#### MINES.

Most of the lead and silver mines are situated to the eastward of Leadville (north-east, due east, and southeast), in the localities known as Fryer Hill, Carbonate Hill, Iron Hill, Printer Boy Hill, Long and Derry Hill, Little Ellen Hill, Stray Horse gulch, and Iowa gulch. As the names of the mines and of their ores recur frequently in this report, some information concerning them has been tabulated below.

The geological information was kindly communicated by Mr. E. Jacob, geological assistant to Mr. S. F. Emmons, and the output data were taken from the Leadville Weekly and Monthly Circular, which receives its information direct from the mine superintendents.

In Table I is given the daily output of the working mines, whose names are arranged alphabetically and grouped according to locality.

OUTPUT OF LEADVILLE MINES.

615

TABLE I.—Leadville mines.

Name of mine.	Chief rocks passed through by the shafts.	Daily output in tons.	Date of output.
<i>Fryer Hill.</i>			
Amie .....	Wash and White Porphyry ..	30	Aug. 21, 1880
Chrysolite .....	do .....	75	Aug. 21, 1880
Climax .....	do .....	20	Aug. 21, 1880
Dunkin .....	do .....	8	Aug. 21, 1880
Hibernia .....	do .....	12	July 15, 1880
Little Chief .....	do .....	110	Aug. 21, 1880
Little Pittsburgh .....	do .....	25	Aug. 21, 1880
Matchless .....	do .....	25	Dec. 4, 1880
Robert E. Lee .....	do .....	40	Aug. 21, 1880
Virginus .....	do .....	10	Aug. 24, 1880
<i>Carbonate Hill.</i>			
Agassiz .....	White Porphyry .....	5	Dec. 20, 1879
Carbonate .....	do .....	35	Dec. 20, 1879
Catalpa .....	do .....	10	Aug. 21, 1880
Crescent and Etna .....	do .....	10	Aug. 21, 1880
Evening Star .....	do .....	60	Dec. 4, 1880
Forsaken .....	do .....	20	Aug. 21, 1880
Half Way House .....	do .....	10	Dec. 20, 1879
Little Giant .....	do .....	5	Aug. 21, 1880
Morning Star .....	do .....	65	Aug. 21, 1880
Pendery and Glass .....	do .....	20	Aug. 21, 1880
Yankee Doodle .....	do .....	5	Dec. 20, 1879
<i>Stray Horse gulch.</i>			
Double Decker .....	Quartzite .....	2½	Dec. 20, 1879
<i>North Iron Hill.</i>			
Adelaide .....	White and Gray Porphyry ..	5	Dec. 20, 1879
Argentine and Camp Bird ..	White Porphyry .....	10	Dec. 20, 1879
<i>Iron Hill.</i>			
Iron mine .....	White Porphyry .....	150	Aug. 21, 1880
La Plata .....	do .....	20	Aug. 21, 1880
Silver Wave .....	do .....	18	Aug. 21, 1880
Smuggler .....	do .....	5	Dec. 20, 1879
Tucson .....	do .....	15	Dec. 20, 1879
<i>Dome Hill.</i>			
Rock and Dome .....	White Porphyry .....	25	Aug. 21, 1880
<i>Yankee Hill.</i>			
Chieftain .....	White Porphyry and limestone	8	Aug. 21, 1880
Scooper .....	Gray Porphyry and limestone.	10	Dec. 20, 1879
<i>Breece Hill.</i>			
Breece Iron .....	Quarry in Gray Porphyry ..		
Colorado Prince .....	Quartzite .....	25	Aug. 21, 1880
Highland Chief .....	Gray Porphyry .....	100	Aug. 21, 1880
Little Prince .....	do .....	5	Dec. 20, 1879
Miner Boy .....	Limestone .....	5	Dec. 20, 1879
<i>Little Ellen Hill.</i>			
Little Ellen .....	White Porphyry .....	10	Aug. 7, 1880
Virginia .....	Blue Limestone .....	5	Dec. 20, 1879
<i>Long and Derry Hill.</i>			
Belcher .....	Limestone .....	5	Dec. 20, 1879
Long and Derry .....	White Porphyry .....	5	Dec. 20, 1879

The aggregate daily output of the mines whose output has not been indicated in Table I reaches 30 tons, and the average daily output for all the mines may be said to reach from 700 to 800 tons during the year. It will be seen that the smelting capacity of the camp of Leadville is about 700 tons per 24 hours, so that the margin left for the shipment of ore is rather small.

#### ORES.

In Leadville the ore deposits are almost invariably found in limestone, which they apparently have replaced. Table I shows that the ore deposits are only reached through masses of various porphyries, and occasionally, at the outcrops, through limestone.

*Description.*—The ores of Leadville, composed chiefly of carbonate of lead or cerussite and of galena or sulphuret of lead, are divided into two great classes, the hard carbonates or lumps and the sand or soft carbonates, and each class is subdivided and designated by letters or numbers, according to the assay contents and value. In these ores silver exists chiefly in the state of chloride and of chloro-bromo-iodide. Some of the constituents of the ores have been found in an isolated state; pyromorphite, or chloro-phosphate of lead, and wulfenite, or molybdate of lead, in the Little Chief mine; anglesite, or sulphate of lead, in most mines; silicate of lead in small reddish crystals; an as yet unknown mineral in the Evening Star mine (this mineral was found by Mr. Emmons and examined by myself, but the quantity was not sufficient to make a complete examination);<sup>1</sup> cerargyrite, or chloride of silver, in the Chrysolite mine, and embolite, or chloro-bromide of silver, in most mines; shapbachite, or sulphuret of bismuth, lead, and silver, in the Florence mine; and bismuthiferous lanarkite, or sulfato-carbonate of lead and bismuth, in the same mine.

*Chief ores.*—The following description will show what are the chief ores in the principal mines:

*Adelaide.*—Large crystals of cerussite, cemented by coarse clay.

*Agassiz.*—Sand. Light-yellow ocher.

*Belcher.*—Hard. Compact masses of mixed oxides of iron and manganese, impregnated with small and indistinct crystals of galena and cerussite.

*Catalpa.*—Hard. Flinty-looking masses of even grain, impregnated with indistinct cerussite crystals. This is the typical "hard carbonate" of the camp.

*Chrysolite.*—Hard. Masses of indistinct crystals of cerussite, cemented by oxides of iron and manganese, both anhydrous and hydrated; color, brown, reddish, and yellow.

*Crescent.*—Sand. Pale-yellow ocher and pale-yellow and whitish masses.

*Dunkin.*—Hard. Fine crystalline galena, imbedded in a hard silicious cement; also distinct and indistinct crystals of galena in a kind of chert.

*Dunkin.*—Sand. Light-yellow ocher.

*Dyer.*—Hard. Flint, impregnated with galena.

*Evening Star.*—Hard. Hard carbonate.

*Florence.*—Sand. Masses with a dull-blackish tinge (bismuthiferous lanarkite), and also shapbachite, with a metallic luster similar to bismuthinite and stibnite.

*Great Hope.*—Hard. Hard carbonate.

<sup>1</sup> It is probably dechenite, which has since been found in determinable quantity by Dr. Iles.

*Highland Chief.*—Sand. Masses of indistinct crystals of cerussite, not cemented.

*Homestake.*—Hard. Masses of galena and pyrites in small crystals, cemented with dolomite and siderite.

*Hibernia.*—Sand. Soft clay, with indistinct cerargyrite, but no cerussite.

*Iron.*—Hard. Crystalline masses of distinct and indistinct crystals of cerussite, cemented with oxide of iron; part of the carbonate of lead colorless, part with a blackish tinge (in examining the lanarkite of the Florence mine it was found that this tinge is due to sulphuret of silver); also hard masses of pure galena in large crystals, cemented by small ones; also masses of large and small distinct crystals of cerussite, cemented by manganiferous oxide of iron; also masses of hematite and occasionally red and yellow ocher; also nodules of cerussite, cemented with ocher.

*La Plata.*—Sand. Bluish-black and yellow masses of small crystals of cerussite.

*Matchless.*—Sand. Soft silicious masses impregnated with cerussite.

*Morning Star.*—Hard. Hard carbonate.

*Rock.*—Hard. Masses of crystalline cerussite, with yellow spots of ocher and greenish spots of embolite; also most varieties previously described.

*Robert E. Lee.*—Sand. Chloride ore, ocherous yellow (a qualitative examination of this ore showed that the ocher contains a considerable quantity of antimoniate of iron); the silver exists in the state of embolite, containing a very small quantity of iodide of silver.

*Virginus.*—Hard. Uniform masses impregnated with cerussite.

It must be noticed that the principal varieties described here are to be found in most mines, although the bismuth ores are confined to the Florence mine, and those free from lead, or dry ores, are found mainly in the Lee and Hibernia mines. A glance at the assays of ores made at different smelters will give a correct idea of the relative contents of the ores in lead and silver, and also in gangue and iron, so that these assays have a mineralogical and geological signification, as well as a commercial one

#### COMPOSITION OF ORES.

A complete examination of the ores from every mine would have formed a most interesting chapter, but the field of investigation opened in Leadville was so vast that its accomplishment would have involved a far greater time than could be given to this study, which has therefore been perforce restricted to the most important points.

**Carbonate ores.**—The interesting observation was made that when cerussite is tinged with black this color is due to sulphuret of silver, so that to some extent the richness of the ore in silver can be ascertained by the eye. The following exhaustive analyses of the carbonate ore of two of the principal mines of Leadville were made by Dr. W. F. Hillebrand in the laboratory of the Survey at Denver:

*Analysis I.*—Adelaide ore. Sand in lumps, formed of masses of small crystals of colorless cerussite, cemented by cerussite, clay, and oxide of iron.

*Analysis II.*—Little Chief ore (sand in lumps). Formed of masses of distinct and indistinct small crystals of cerussite with a bluish-black tinge, full of whitish and yellowish spots and cavities.

ANALYSIS I.—*Adelaide ore.*

Oxide of lead.....	79.550
Chloride of lead.....	0.990
Peroxide of iron.....	0.467
Alumina.....	0.444
Protoxide of iron.....	0.299
Protoxide of manganese.....	0.137
Oxide of cobalt.....	Trace
Lime.....	0.303
Magnesia.....	0.068
Gold.....	Trace
Silver.....	0.009
Arsenic.....	Trace
Water.....	0.395
Phosphoric acid.....	1.532
Sulphuric acid.....	Trace
Silica.....	0.651
Carbonic acid.....	14.700
Total.....	99.545

(Hillebrand.)

Gold,  $\frac{1}{80}$  of an ounce to the ton.Silver,  $2\frac{1}{2}$  ounces to the ton.*Discussion.*—This analysis shows that the Adelaide ore is composed of:

Carbonate of lead (PbO, CO <sub>2</sub> ).....	85.605
Pyromorphite 3 (3PbO, P <sub>2</sub> O <sub>5</sub> ) + Pb Cl <sub>2</sub> .....	9.748
Carbonates, silicates, and oxides.....	4.647

100.000

All the constituents of these minerals, which are widely distributed in Leadville, will be traced later in the analytical study of the smelting process.

ANALYSIS II.—*Little Chief ore.*

Oxide of lead.....	75.408
Peroxide of iron.....	1.940
Alumina.....	1.415
Oxide of cobalt.....	Trace
Protoxide of manganese.....	0.074
Peroxide of manganese.....	1.386
Oxide of zinc.....	0.095
Lime.....	0.335
Magnesia.....	0.056
Silica.....	1.970
Arsenic acid.....	Trace
Antimonic acid.....	0.121
Water.....	1.140
Carbonic acid.....	14.251
Phosphoric acid.....	Trace
Sulphuric acid.....	0.486
Chlorine.....	0.288
Silver.....	0.777
Gold.....	Trace
Loss.....	0.258

Total..... 100.000

(Hillebrand.)

Silver, 226.69 ounces to the ton.



*Discussion.*—In this ore pyromorphite is replaced by anglesite, the sulphuric acid of which plays an important part in smelting. Some of the constituents of this ore—arsenates, sulphates, and antimonates—will be found in an almost unaltered condition in some of the furnace products (accretions). The presence of zinc gives a special interest to this analysis, for the reason that this metal is found in every furnace product—lead fumes, accretions, bullion, and slags. But, although the two preceding analyses are typical of the carbonate ores and contain their most important elements, they do not show the metals molybdenum, titanium, bismuth, nickel, cadmium, copper, and tin, which have also been found in the furnace products, and appear to be pretty widely distributed in the camp, though generally in very small quantities. It is, however, evident that certain substances are entirely wanting in some ores. For instance, a special examination of the Little Chief Smelter slag failed to detect more than traces of titanic acid, showing that this substance does not exist in the Little Chief ore, although it is to be found in most Leadville slags.

*Chloride ores.*—In Leadville the chlorides of silver have long been known as cerargyrite and embolite, of which they have the characteristic appearance. The writer made a special qualitative examination of the embolite found in the Robert E. Lee mine (old workings). This embolite is disseminated in the peculiar antimoniferous ocher already spoken of. One specimen gave chlorine and bromine, with a little iodine; another gave less iodine than the preceding, but more bromine. Dr. W. F. Hillebrand has made the following analyses of the chief chlorides of Leadville:

ANALYSIS III.—*Robert E. Lee (chloride ore).*

Chloride of silver .....	21.580
Bromide of silver .....	77.986
Iodide of silver .....	0.425
	100.000

ANALYSIS IV.—*Amie (chloride of silver contained in hard carbonate).*

Chloride of silver .....	15.755
Bromide of silver .....	84.091
Iodide of silver .....	0.154
	100.000

The formula of this chloride is  $4\text{AgBr} + \text{AgCl(I)}$ , a very small quantity of iodine replacing chlorine.

ANALYSIS V.—*Big Pittsburgh ore.*

Chloride of silver .....	99.965
Bromine of silver .....	None
Iodide of silver .....	0.035
	100.000

At the Chrysolite mine a magnificent block of very pure cerargyrite was found, weighing several hundred pounds.

In order to determine the relative proportions of chlorine, bromine, and iodine throughout the district, a mixture was made of lead fumes collected in the dust cham-

bers of eight smelters. The following figures, obtained by analysis of this mixture, may be taken to represent the relative proportions of chlorine, bromine, and iodine in the silver ores:

Chloride of silver .....	89.10, equivalent to chlorine .....	82.45
Bromide of silver .....	10.45, equivalent to bromine .....	16.83
Iodide of silver .....	0.45, equivalent to iodine .....	0.72
	<hr/>	<hr/>
	100.000	100.000

Special stress has been laid upon the composition of the chloride ores, for the reason that they play an important part in lead smelting in Leadville. To chlorine, bromine, and iodine is due a great part of the loss in lead, not only because chloro-bromo-iodide of lead is a very volatile compound, but also because chloro-bromo-iodophosphates and sulphurets of lead are found which are also remarkable for their great volatility.

*Average of ores.*—Mr. Th. Fluegger, assayer of the Harrison Reduction Works, in Leadville, has published in the *Engineering and Mining Journal* of March, 1880, an analysis of a sample from 1,000 tons, representing specimens from every producing mine in Leadville. This analysis, made with probably insufficient means in the laboratory of one of the smelters, has evidently no pretension to scientific accuracy, since some of the elements—sulphur, arsenic, antimony—are left uncombined and since all the rare elements are not indicated. It is given here, however, because upon it have been based the main features of the chemical discussion of the blast furnace.

If it is assumed that the quantity of silver reported in this analysis is correct, it represents an average quantity of silver of nearly 90.5 ounces to the ton. This figure appears exaggerated, for the reason that the proportion of silver to lead is one ounce to five pounds, while in practice mixtures aimed at contain one ounce of silver to six pounds of lead. But the average percentages of lead (23), iron (18), and silica (22.5) agree precisely with the general composition of the smelting charges in Leadville.

*ANALYSIS VI.—Average ore.*

Carbonic acid .....	5.58
Oxide of lead.....	24.77
Silica .....	22.59
Sulphur.....	0.90
Protoxide of iron.....	0.89
Peroxide of iron.....	24.86
Protoxide of manganese .....	4.03
Silver.....	0.31
Lime.....	2.36
Magnesia .....	3.04
Arsenic .....	0.01
Antimony .....	0.02
Potash and soda.....	0.98
Chlorine .....	0.09
Water .....	5.53
Alumina .....	3.99
Gold, copper, zinc.....	Trace
	<hr/>
	99.95

Silver, 90.5 ounces to the ton; lead, 23 per cent.; iron, 18 per cent.; silica, 22.59 per cent.

Assays of various ores.—The assays of the first division of the following table were made by the writer in June, 1880, for one of the smelters. The silver assays present a certain interest, since they were made in crucibles, whereas the ordinary method of silver assay at Leadville is that by scorification; the lead assays, however, are the ordinary fire assays usually made in the region.

The assays given in the rest of the table were made by the different assayers attached to the respective smelting works.

TABLE II.  
I.—ORE ASSAYS.

Name of mine.	Lead.	Silver to the ton.	Gold to the ton.
	<i>Per cent.</i>	<i>Ounces.</i>	<i>Ounces.</i>
Adelaide (sand).....	15.00	47.70	None
Do.....	15.00	30.00	0.85
Do.....	26.45	8.80	0.05
Do.....	54.90	12.60	0.10
Do.....	21.45	12.00	0.10
Do.....	9.45	34.15	0.05
Amie.....	45.80	23.30	.....
Do.....	0.50	36.00	.....
Do.....	11.30	78.00	.....
Amie (special lot).....	31.70	1,189.70	.....
Amie (black lumps).....	1.70	31.40	.....
Amie (lumps).....	1.50	31.20	.....
Amio.....	42.00	217.30	.....
Do.....	7.00	194.85	.....
Do.....	2.00	37.35	.....
Amie (lumps).....	5.80	213.80	.....
Amic.....	6.70	119.95	.....
Do.....	0.50	76.80	.....
Do.....	17.00	230.90	.....
Do.....	1.90	36.25	.....
Belcher.....	5.65	33.10	.....
Do.....	6.50	39.50	.....
Chrysolite.....	19.30	235.30	.....
Do.....	27.50	55.99	.....
Evening Star.....	44.35	99.05	.....
Hibernia (clayish).....	1.80	33.05	.....
Little Giant.....	28.00	41.10	.....
Do.....	40.00	62.90	.....
Do.....	54.00	87.70	.....
Virginus.....	25.20	8.10	.....
Do.....	34.50	22.50	.....

II.—ASSAYS MADE AT ELGIN SMELTER, AUGUST, 1880.

Amie.....	14.00	180.00	.....
Camp Bird.....	46.00	12.00	.....
Carbonato.....	30.00	197.00	.....
Catalpa.....	33.00	80.00	.....
Evening Star.....	37.50	55.00	.....
Iron.....	33.70	45.00	.....
Little Chief.....	35.00	65.00	.....
Loveland.....	46.50	85.00	.....
Morning Star.....	48.00	56.00	.....
Pine.....	28.00	12.00	.....
R. E. Lee.....	None	185.00	.....

TABLE II—Continued.

## III.—ASSAYS MADE AT MESSRS. CUMMING &amp; FINN'S SMELTER, JULY, 1880.

Name of mine.	Lead.	Silver to the ton.	Gold to the ton.
	<i>Per cent.</i>	<i>Ounces.</i>	<i>Ounces.</i>
Adelaide.....	22 to 44	12 to 20	0.5 to 0.75
Amie.....	2 to 10	20 to 1,100	
Chrysolite.....	27.00	40 to 80	
Evening Star.....	22.00	51.00	
Hibernia.....	.5 to 1	60 to 180	
Little Giant.....	12 to 40	14 to 80	
Morning Star.....	40 to 55	35 to 40	
Virgiolus.....	25 to 35	8 to 32	

## IV.—ASSAYS MADE AT CUMMING &amp; FINN'S SMELTER, AUGUST, 1880.

Amie (lumps).....	3.00	40.00	
Amie (screenings).....	None	100.00	
Hibernia (clayish).....	None	33.00	
Do.....	None	60.00	
Homestake.....	None	70.00	
Do.....	8.00	60.00	
Morning Star (sand).....	55.00	38.00	
Morning Star (hard).....	40.00	32.00	
Do.....	40.00	36.00	
Morning Star (sand).....	47.00	30.00	
Do.....	55.00	38.00	

## V.—ASSAYS MADE AT THE HARRISON REDUCTION WORKS, JULY, 1880.

Agassiz.....	14.00	49.60	
Alpine.....	45.00	141.00	0.50
Amie.....	23.50	105.00	
Camp Bird.....	48.70	12.00	
Carbonate.....	27.00	218.00	
Chieftain.....	7.00	76.00	
Chrysolite.....	20.00	97.50	
Colorado Prince.....	None	15.00	17.70
Double Decker.....	None	35.50	2.70
Dunkin.....	8.00	119.00	
Forsaken.....	13.50	62.00	
General Shields (Sawatch Range).....	None	53.50	0.10
Gold Cnp (Sawatch Range).....	None	110.00	
Gold Ore (Sawatch Range).....	None	6.70	4.10
Independence (Sawatch Range).....	None	8.60	5.76
Iron.....	40.50	79.00	
Long and Derry.....	16.00	73.00	
Little Chief.....	16.00	56.50	
Little Pittsburg.....	36.40	266.00	
Morning Star.....	65.00	61.00	
Nevada.....	23.70	16.00	2.20
Pine.....	31.00	12.00	
Ready Cash.....	3.70	125.00	9.20
Robert E. Lee.....	None	148.50	

At the smelters, silica, or rather that mixture of silica and refractory silicates insoluble in acids, and known as gangue, is determined, as well as the per cent. of iron.

ASSAYS OF LEADVILLE ORES.

The following will give an idea of their relative proportions :

TABLE II—Continued.

VI.—ASSAYS MADE AT THE CALIFORNIA SMELTER, JULY, 1880.

Name of mine.	Lead.	Silver to ton.	Iron.	Gangue.
	<i>Per cent.</i>	<i>Ounces.</i>	<i>Per cent.</i>	<i>Per cent.</i>
Amie .....	5.00	40.00	40.00	20.00
Brian Boru .....	40.00	40.00	6.00	12.00
Iron .....	24.00	30.00	24.00	46.00
Morning Star .....	55.00	40.00	5.00	16.80
Robert Emmet.....	10.00	12.00	49.00	12.00
Tucaon .....	50.00	30.00	10.00	10.00

VII.—ASSAYS MADE AT THE HARRISON REDUCTION WORKS, JULY, 1880.

Chrysolite .....	29.00	97.50	8.35	11.36
Climax .....	Not determined		37.10	30.80
Iron .....	40.00	79.00		19.40
Little Chief.....	16.00	56.50	21.00	17.30
Robert E. Lee.....	None	146.50	17.30	49.40
Reck .....			22.10	47.00

VIII.—ASSAYS MADE AT THE GRANT SMELTING WORKS, JULY, 1880.

Catalpa (hard) .....	33.60	79.00	4.25	41.30
Do.....	45.60	64.60	5.40	18.50
Catalpa (sand) .....	43.70	83.00	39.50	27.60
Chrysolite (B, hard) .....	21.90	47.75	25.30	16.40
Chrysolite (A, sand) .....	42.50	75.00	13.70	14.60
Dyer .....	1.00	80.00	3.70	58.50
Evening Star .....			7.00	49.00
Do.....	23.90	44.50	6.80	14.20
Henrietta.....	38.80	45.60	45.20	8.60
Hibernia.....	None	52.22	23.70	22.10
Highland Chief.....	15.40	144.00	2.50	13.10
Iron .....	33.70	20.90	11.70	12.60
Little Chief.....	20.00	55.00	22.40	17.00
Do.....	33.30	116.80	13.00	14.30
Little Chief (hard).....	10.00	25.00	29.75	12.50
Little Chief.....	18.80	99.00	14.40	33.60
Little Chief (sand).....	37.50	80.00	14.70	17.50
Little Chief.....	9.35	35.72	19.90	28.30
Little Chief (sand).....	27.50	100.00	15.75	27.50
Little Chief (galena).....	55.00	5.50	3.85	15.00
Little Pittsburgh .....			18.20	26.50
Morning Star .....	42.30	18.60	11.00	14.20
New Discovery .....			17.15	33.70
Silver Wave .....	7.15	35.36	40.30	17.70
Do.....	5.95	36.52	32.90	12.80

TABLE II—Continued.

IX.—ASSAYS MADE AT MESSRS. BILLING &amp; EILERS'S SMELTER, JULY, 1880.

Name of mine.	Lead.	Silver to ton.	Iron.	Gangue.
	<i>Per cent.</i>	<i>Ounces.</i>	<i>Per cent.</i>	<i>Per cent.</i>
Amie .....			25.00 to 45.00	12.00 to 25.00
Chrysolite (hard) .....	20.00 to 25.00	65.00	23.50	15.00
Dome .....			23.00	16.00
Dnnkin (sand) .....	1.00 to 13.00	50.00 to 100.00	34.00	32.50
Iron (hard) .....	50.00	80.00		
Rock (hard) .....	36.00	18.00	18.10	6.50
Rock (sand) .....			18.15	12.50
Average assays of all the ores smelted from June, 1879, to June, 1880 .....	30.27	62.58		

X.—ASSAYS OF VARIOUS ORES MADE AT MESSRS. CUMMING &amp; FINN'S SMELTER, JULY, 1880.

Adelaide (sand) .....	44.00	20.00	8.00	15.00
Amie (lumps) .....	3.00	40.00	35.00	13.00
Amie (first class) .....	8.50	300.00	33.50	24.00
Amie (second class) .....	4.50	30.00	35.00	18.00
Chrysolite (sand) .....	34.00	72.00	23.50	16.00
Chrysolite (hard) .....	16.00	45.00	26.00	18.00
Evening Star .....	22.00	51.00	5.00	52.00
Hibernia .....	None	33.00	28.00	29.00
Do .....	None	60.00	20.00	48.00
Homestake .....	5.00	70.00	9.00	57.00
Do .....	8.00	60.00	14.00	36.00
Little Giant (first class) .....	37.00	84.00	4.00	32.00
Little Giant (second class) .....	19.00	38.00	18.00	14.00
Little Giant (third class) .....	12.00	17.00	34.00	19.00
Morning Star (hard) .....	43.00	39.00	4.00	35.00
Morning Star (sand) .....	55.00	38.00	5.00	20.00
Morning Star .....	53.00	53.00	3.50	20.50
Morning Star (sand) .....	55.00	38.00	5.00	20.00
Morning Star .....	53.50	27.00	6.70	14.00
Morning Star (hard) .....	40.00	36.00	6.00	24.00
Morning Star .....	7.00	30.00	5.00	20.00
Virginus .....	34.00	22.00	15.00	22.00

XI.—ASSAYS FOR IRON AND GANGUE MADE AT MESSRS. CUMMING &amp; FINN'S SMELTER, JULY, 1880.

Name of mine.	Iron.	Gangue.	Name of mine.	Iron.	Gangue.
	<i>Per cent.</i>	<i>Per cent.</i>		<i>Per cent.</i>	<i>Per cent.</i>
Adelaide .....	17.00	14.00	Amie .....	38.10	25.10
Do .....	16.50	15.00	Do .....	37.50	24.00
Chrysolite .....	21.00	20.00	Evening Star .....	4.50	60.30
Do .....	19.80	11.00	Forsaken .....	25.00	32.00
Do .....	13.50	20.00	Hibernia .....	38.00	29.50
Do .....	26.30	23.50	Little Giant .....	14.20	34.60
Evening Star .....	13.70	45.00	Do .....	5.40	31.80
Do .....	12.70	32.00	Do .....	12.50	45.50
Do .....	5.45	42.50	Do .....	6.00	29.00

TABLE II—Continued.

XII.—ASSAYS OF LOTS AND MIXTURES OF ALL SORTS MADE AT THE LA PLATA SMELTER IN THE YEAR 1880.

Name of mine.	Iron.	Gangue.	Name of mine.	Iron.	Gangue.
	<i>Per cent.</i>	<i>Per cent.</i>		<i>Per cent.</i>	<i>Per cent.</i>
11 lots .....	23.90	20.30	7 lots .....	20.70	18.60
14 lots .....	23.30	19.40	11 lots .....	17.90	18.80
11 lots .....	23.70	32.00	Average of 64 lots .....	21.50	19.70
10 lots .....	20.40	19.60			

*Discussion.*—The preceding tables are valuable as furnishing, not only data for reference, but also proofs of the activity of mining and smelting in Leadville. It is also evident from their examination that there is no relation whatever between the lead and silver contents of the ores. This could scarcely be otherwise, if it is considered that lead exists in the state of carbonate or sulphide, and silver in the state of sulphide or chloro-bromo-iodide, compounds which have no common properties. A carbonate ore rich in lead may contain a large quantity of residual or untouched sulphide of silver, and be rich in silver, or its silver may have been carried away in the state of chloride and the ore be poor in silver. This chloride of silver carried away may be redeposited in any kind of mineral, in porous quartz or in clay, and the ore may be very rich in silver and contain no lead. In other cases both carbonate of lead and chloride of silver are carried away and deposited in the same gangue, giving ore rich in both lead and silver.

## SMELTING WORKS.

*Location.*—Since Leadville became an important mining camp sixteen distinct smelting works have been erected. Two smelters only are situated in Leadville proper, the Harrison Reduction Works and the Grant Smelting Works, which both stand on the northern bank of California gulch. In the outskirts of the city, and at the junction of the upper and the lower roads of this bank, stood the Leadville smelter, now pulled down. Then come in succession, but still on the northern bank of California gulch, the La Plata, the American, Billing & Eilers's, and the California Smelting Works. At the lower end of California gulch is situated the small town of Malta, near which were erected the Malta and Lizzie smelters. In Adelaide, on Iron Hill, stood the Adelaide smelter, which belonged to the Adelaide mine, but has long since ceased running. On Fryer Hill and immediately above the Little Chief mine stood the Little Chief smelter. This smelter has since been pulled down on account of the sinking of the ground upon which it was erected, and its furnace is now running at Messrs. Cumming & Finn's smelter. On the southwestern bank of Big Evans gulch are found in succession, going westward, the Ohio and Missouri, Cumming & Finn's, Gage, Hagaman & Co.'s, Raymond, Sherman & McKay's, and the Elgin Smelting Works.

At the time this report was made (August, 1880) several smelters had entirely ceased running, viz, the Adelaide, Little Chief, American, Malta, Lizzie, Leadville, Gage, Hagaman & Co.'s, and Raymond, Sherman & McKay's. Since that time the American and Malta have resumed work, the former successfully, its plant being in a perfect state of preservation; the latter rather unsuccessfully, mainly by reason of its imperfect plant and machinery.

The following are the names of the different smelting works, of the superintendents, and the dates at which they commenced smelting:

Smelting works.	Superintendent.	Date.
Harrison Reduction Works.....	James Brierton.....	Oct., 1878
Grout.....	J. B. Grout.....	Sept., 1878
Leadville.....	.....	—, 1877
La Plata.....	M. E. Smith.....	June, 1878
American.....	Carl Heinrich.....	May, 1879
Billing & Eilers's.....	Fritz Wolf.....	May, 1879
California.....	M. E. Smith.....	June, 1879
Malta.....	F. Fohr.....	—, 1875
Lizzio.....	.....	—, 1876
Little Chief.....	S. T. Tyson.....	Aug., 1879
Ohio and Missouri.....	N. R. Wilson.....	June, 1879
Camming & Finn's.....	Thomas MacFarlane.....	July, 1879
Gage, Hagaman & Co's.....	.....	June, 1879
Raymond, Sherman & McKay's.....	.....	June, 1879
Elgin.....	Aug. Werner.....	June, 1879
Adelaide.....	.....	—, 1879

Cost of plant.—From data obtained by the census investigation of the precious metals for 1880, carried on under the supervision of Mr. S. F. Emmons, it is found that the smelters of Leadville were erected at an aggregate cost of about \$800,000.

In the following table will be found the cost of plant of twelve of the principal smelters in arbitrary numerical order:

TABLE III.

Smelter	Cost of plant.
I.....	\$43,000
II.....	160,000
III.....	80,000
IV.....	25,000
V.....	37,000
VI.....	65,000
VII.....	95,000
VIII.....	60,000
IX.....	48,000
X.....	37,000
XI.....	30,000
XII.....	20,000

General disposition of smelting works.—The slope of the banks of gulches is particularly favorable to the construction of smelters, most of which are divided into several levels, which allow of a rational division of labor and economize constructions, hoisting machinery, and manual labor.

On California gulch most smelters have the following levels:

1. The furnace, slag-heap, and bullion level, connected by means of inclined ways with the main lower road of the gulch running at the foot of the slag-heap.
2. The feeding-floor level, which is also that for crushing, sampling, ore-beds, and ore-bins. This level is always provided with a wagon road, branch of the upper road, and communicates with the upper and lower levels by means of inclined ways.



3. First ore-bin level, with a wagon road between the rows of bins, allowing the discharge of ore-wagons into the lower row of ore-bins, and the wheeling away of the ore extracted in barrows from the upper row of ore-bins to the feeding and crushing level. This level communicates, like the preceding, with the upper and lower levels by means of inclined ways.

4. Second ore-bin level, with disposition similar to preceding.

5. Third ore-bin level, with disposition similar to preceding.

6. Charcoal and coke-bin level, with dispositions similar to preceding.

7. Ore-dumps, fluxes, charcoal, coke and wood reserves, or upper level. A glance at Figure 2, Plate XXXI, representing smelter C, will give an idea of the disposition of levels.

The general arrangement just described is that adopted at the most favorable points, but sometimes levels 3, 4, 5, and 6 are reduced to three, two, and even one level. This is particularly the case on Big Evans gulch, whose banks are far from being as high as those of California gulch. There the levels are reduced to two:

1. The furnace, slag-heap, and bullion level.

2. The feeding-floor level, used also for crushing, sampling, ore-beds, and ore-bins. The fuel-bins, ore-dumps, fluxes, and wood reserves are generally placed at the back of the ore-bins.

The works are always inclosed, from the furnace level to the back of the feeding floor, in a light wooden structure. Where there are several levels of ore-bins they are independent of the main building; but where there is only one upper level the ore-bins are placed in the building. The offices and laboratory always occupy a detached building. The office is always provided with large wagon scales, varying in capacity from 10 to 20 tons, and used for weighing the wagons loaded with ore or bullion and taring them after unloading.

The boilers, engines, and blowers are always placed on the furnace level, on one side of the furnaces, as are the smith's and mechanic's shops, which, however, often occupy a small detached building.<sup>1</sup>

#### ORE BUYING.

**Method.** — The manner in which ore is purchased by the smelters of Leadville is somewhat different from the method usually pursued in other camps. The ore is purchased outright for cash from the mines, a certain deduction being made for the loss of silver in smelting, and a certain amount being charged for what is called the cost of treatment.

In the following table is shown, as a sample, for a few of the principal mines —

1. The deduction for the loss of silver in smelting.

2. The cost of treatment.

3. The price given for the lead contained in the ores.

---

<sup>1</sup> At the time this report was made all the smelters in California gulch were connected by side tracks with the railroad, and preparations were made to connect the railroad with the smelters on Big Evans gulch.

Unless the ore contains more than a certain percentage (5 per cent. to 30 per cent.), the lead is not paid for at all.

Mine.	Deduction for loss of silver in smelting.	Cost of treatment per ton of ore.	Price paid for lead per unit of 20 pounds.
	<i>Per cent.</i>		
Amio .....	10	\$25	\$0. 25
Carbonate .....	7½	20	25
Chrysolite .....	5	20	25
Dunkin .....	5	22	25
Evening Star .....	7½	28	15
Iron Silver .....	5	18	30
Morning Star .....	5	15	30
Tueson .....	5	21	25

These rates are subject to constant fluctuation, according to—

1. The price of fluxes.
2. The amount of fluxes required in smelting.
3. The price of charcoal and coke.
4. The character of the ore: whether large lumps or sand; whether highly sulphureted or highly silicious; whether rich or poor in lead; whether rich in oxide of iron or without it.

The cost of treatment has varied during the year ending June 1, 1880, from \$15 to \$30 per ton of ore. The price paid for silver and lead in the ore varies naturally with the New York market. During the year ending June 1, 1880, the variation for silver has been from full New York quotations and no discount to a discount of 10 per cent., the average discount having been about 5 per cent. off silver quotations.

Lead is bought by the unit, i. e., 1 per cent., or 20 pounds in the ton; and its price has varied from 15 cents to 45 cents per unit during the year 1879-'80. The price per unit of lead depends on individual agreement, and also on the contents of the ore in lead. At some smelting works the cost of treatment will be \$16 to \$25, with a deduction of 5 per cent. off silver, and the price of lead 20 cents to 25 cents per unit when the ore contains above 30 per cent. At others, the cost of treatment will equal \$20, the deduction off silver 5 per cent., and the price for lead 15 cents per unit when the ore contains above 5 per cent.

Gold is paid for at the rate of \$18 per ounce, but only when its amount exceeds one tenth of an ounce per ton of ore.

Cost of transportation.—When the ore is bought direct from the mine, its transportation is paid for by the mine owners, and the cost of handling varies from \$1 to \$1.85 per ton of ore, according to distance; but when the ore is purchased at the sampling works, the smelters have to pay for its transportation to their bins at the above rates.

#### SAMPLING.

Method.—The general method of sampling carried on in the camp is the following: In shoveling the ore from the ore-wagon to the ore-bin, every tenth shovelful is thrown aside into a wheelbarrow. Thence the sample thus obtained is wheeled to the sampling-floor and passed through the crusher. It is then well mixed with the shovel,

laid in a thin layer on the floor, and quartered down very carefully until small enough to be dried easily. The amount of moisture is determined by desiccation of this sample, previously weighed. When dry it is passed through Cornish rolls set to one-eighth of an inch or through small mills. It is once more well mixed and quartered down until small enough to be ground on the buck-plate or in the mortar, and passed through fine sieves, about 70 meshes to the linear inch. This done, the sample is once more well mixed and divided into three parts, one of which is assayed by the smelter, the other at the mine, and the third by an independent assayer, or more generally kept in reserve for reference in case of dispute. Sometimes the bulk of the sample obtained from every tenth shovelful from the wagon is reduced by setting apart every fifth shovelful. This reduced sample is afterwards subjected to the treatment which has just been described in detail.

**Sampling works.**—Every smelter in Leadville possesses a sampling floor, with ore-beds, crushers, and ore-bins; but there are besides three large sampling works, which are independent of the smelters and where the buying, assaying, crushing, drying, sampling, and selling of ore only are carried on. These works belong to Messrs. A. R. Meyer & Co., Eddy & James, and Gillespie & Ballou.

The sampling works are provided with a large number of bins for the preparation and classification of ores of every grade and from every mine; and, as at the smelters, the machinery, crushers, Cornish rolls, and mills are driven by steam-power. Large open spaces are kept for the accumulation of ore-dumps and the preparation of ore-beds of a given composition. These are made by spreading layer upon layer of ores of known weight and contents in silver and lead. Drying is carried on on a large scale, the driers consisting of large parallelepipedic cuts in the ground, about six feet wide and twenty feet long, provided with a coal fire-place at one end, connected with a sheet-iron stack at the other, and covered over on a level with the ore floor with sheet-iron, upon which the ore to be dried is spread in layers.

The advantages offered by these works are twofold. The prospectors and small miners can always dispose of their small lots of ore, and the large ones of those ores which are in any way exceptional or out of the usual run. On the other hand, the smelters can always find their supplies of ores of a given composition ready for the furnace, or special ores to modify or complete the composition of their own ore-beds or mixtures.

#### CRUSHING.

Sand ores do not require crushing; in fact, they are already in dust or pieces too small for the furnace, and require mixing in convenient proportion with crushed ore in order to be fit for use. But hard ore and sand ore in lumps require crushing, as well as the limestone, iron-stone, and old slags which are used as fluxes. This is effected, both at smelters and at sampling works, by means of compact but powerful stonebreakers or crushers, always driven by steam-power.

**Machines used.**—The crushers mostly used in Leadville are Blake crushers manufactured by the Blake Crusher Company, New Haven, Conn., and by the Farrel Foundry and Machine Company, Ausonia, Conn. At the sampling works one or two Alden crushers manufactured by E. T. Copeland, New York, are also in use.

The table below gives the principal types used, their numbers, nominal horse-power required, and capacity.

Capacity numbers of the crushers.	Opening between jaws.	Revolutions of fly-wheel per minute.	Horse-power required.	Crushing capacity per hour.
	<i>Inches.</i>			<i>Tons.</i>
No. 1.....	10 by 4	300	4	4
No. 2.....	10 by 7	275	6	6½
No. 4.....	10 by 4	300	4	4
No. 5.....	15 by 9	275	9	9½
No. 0.....	10 by 4	300	4	4
No. A.....	10 by 4	300	4	4

*Blake crushers.*—The crushers manufactured by the Blake Crusher Company belong to two styles: (1) The older style or eccentric pattern and (2) the Challenge Rock-Breaker, or Sectional Cushioned Crusher. Of the eccentric pattern, a horizontal and vertical section will be found in Plate XLI, Figures 1 and 2; the drawing given is a copy of that furnished by the company for a No. 2. The circle *D* is a section of the fly-wheel shaft, which should make from 225 to 250 revolutions per minute. The dotted circle *E* is a section of the eccentric. *F* is a pitman or connecting-rod, which connects the eccentric with the toggles *G G*, whose bearings form an elbow or toggle-joint. *H* is the fixed jaw; this rests against the end of the frame *A*. *P P* are chilled iron plates, between which the rock is crushed. When worn at the lower end they can be inverted and thus present a new wearing surface. The cheeks *I I* fit in recesses on each side and hold the chilled plates *P P* in place. By changing the position of the cheeks from right to left when worn, both will have a new surface. *J* is the movable jaw. It is supported by the round bar of iron *K*, which passes freely through it and forms the pivot upon which it revolves. *L* is a spring of india-rubber, which is compressed by the forward movement of the jaw and assists its return. *M M* are bolt-holes. *B* is the fly-wheel. *C* is the driving-pulley. *Q Q Q Q* are oiling tubes; *R R R R*, steel bearings; *O*, the toggle-block; *N*, the wedge; *Y*, the wedge-nut; *S*, set-screws for tightening toggle-block; *T*, bush and key. The frame *A A* and supports *Z Z* are made of cast iron. This crusher is being gradually superseded by the Challenge Rock-Breaker, manufactured by the same firm, which has many points of superiority over the preceding, and is not quite so delicate in construction or so apt to get out of order.

The Challenge or sectional cushioned crusher is represented in perspective and vertical section in Plate XLI, Figures 3 and 4, which are copied from the company's drawing of a No. 5 crusher. Its crushing capacity per hour is 9 tons when the jaws are set 1½ inches apart and when its speed is 275 revolutions per minute. Flint, hard ores that break with a snap, dolomite, hematite, and old slags go through the crusher at that rate in the same conditions, but with sand or soft ore the capacity is sensibly diminished. The 9 horse-power indicated as being necessary to drive this crusher is purely nominal, and represents, so to speak, an average; in practice the driving engine should have greater power, in order to overcome irregular or unexpected resistance.

The Challenge crusher consists of a three-sided frame-work *F*, of cast iron, with a broad flanged base, holding the movable jaw in suspension, which forms the front part of the machine, between the upright convergent jaws of which the stone is crushed.

The jaw-shaft *K* is held in place by wrought-iron or steel clamps *C*, which serve to take part of the strain due to crushing in the upper part of the jaw space, and also serve as walls thereof. In the lower part of the three-sided frame, or front part of the crusher, and on each side of it are holes in the casting to receive the main tension rods *R*, which connect the front and rear part of the machine. The rear part *B* is called the main toggle block. It is also provided with holes to receive the main tension-rods *R R*, corresponding to those in the front casting. The tension-rods *R R* are provided with screw-threads and nuts *N N*, by means of which their length, and in consequence the opening between the jaws, are readily adjusted to crush coarse or fine.

The front and rear castings are supported on parallel timbers *G G*, to the under side of which are bolted the boxes carrying the main eccentric shaft, provided with fly-wheels and pulley. These timbers take the transverse strain, which comes upon the pitman connecting the main shaft and the toggle-joint, situated in the rear of the movable jaw, and between it and the main toggle-block. Between the broad flanged bases of the front and rear castings and the timbers on which they rest are placed flat rubber cushions *C' C'*, one-fourth to three-eighths of an inch thick. Every revolution of the shaft brings the toggles more nearly into line and throws the movable jaw forward. It is withdrawn by the rod provided with rubber spring *L*. In this way a short vibratory movement is communicated to the movable jaw. The pitman *R' H* is constructed so that it can be lengthened or shortened, and thus change the inclination of the toggles *O O*, and consequently the length of the movable jaw *J*.

The great advantage of this machine over the old style is that of possessing elastic parts, rigid enough to allow the performance of the work desired, but giving way under accidental strains, such as the introduction of a steel hammer between the jaws. The frame *A* is made of timber. The best method of setting up this stone-breaker is to place its frame on four timbers 15 by 15 inches, disposed as is shown at *X X'* and *Y*. These timbers are pinned or bolted together.

The following are the main parts of the machine and the letters used to indicate them in the drawing :

A, timber frame.	L, rubber spring.
B, main toggle-block.	L', spring rods.
C' C', rubber cushions.	M, pitman-rod nuts.
D, fly-wheel.	N N', main tension-rod nuts.
E, main pulley.	O, toggles.
F, main cast-iron frame.	P, jaw (chilled plates).
G, timber supports.	R, main tension rods.
H, pitman half-box.	R' H, pitman.
I, cheeks.	R', pitman-rods.
J, movable jaw.	S, main eccentric shaft.
K, jaw shaft.	T, toggle bearings.

The Farrel Foundry and Machine Company's Blake crusher is used a good deal in Leadville. It is constructed on very nearly the same principles as the Blake Crusher Company's eccentric pattern. It presents the same appearance, it requires the same amount of power to produce the same quantity of work in the same time, and a complete description of it would be superfluous, since it answers exactly to the description of the eccentric pattern. It differs from it, however, in one respect, namely the substitution of a crank shaft for the eccentric shaft.

*Alden crusher.*—The Alden crusher and pulverizer, is not in use at smelters, which, when they have any pulverizing to do, use Cornish rolls; but it is used at the sampling works, where a considerable amount of pulverizing is done. The jaws of this crusher differ essentially from those of the others in this respect—that their grooves are perpendicular to the length of the jaws, while in the others these grooves are parallel to the length.

Fig. 1, Plate XLV, gives a perspective view of the Alden crusher, in which portions of the jaws and jaw-faces are shown in section. The jaws are hung upon wrought-iron trunnions, the ends of which project through and are supported by the sides of the frame. Motion is imparted by links connected with the trunnion ends, and driven by studs projecting from a sliding yoke beneath. This yoke is connected with a crank-shaft by a pitman. The rotation of the crank moves the yoke to and fro on a nearly horizontal plane, alternately moving and pushing the movable ends of the two jaws, and imparting a rubbing motion, which is the main feature of the machine. The jaws may be adjusted at varying distances, so as to obtain a product of varying degrees of fineness.

The Cornish rolls, used by both the smelters and samplers for grinding their samples, consist of two steel cylinders, 12 inches long and 6 inches in diameter, connected by cog-wheels, driven by pulley and transmission belt, and fed by means of a thin sheet-iron funnel, having the shape of an inverted truncated pyramid. These rolls are usually set one-eighth of an inch apart.

#### ASSAYING.

In Leadville assaying is quite an important branch of the mining and smelting industries. In addition to the assayers attached to all the smelting and sampling works and to the principal mines, there are no less than twenty independent assayers residing in the city and having their own assay offices. Besides being employed as referees and experts in cases of dispute between mines and smelting works, the latter are patronized by the prospectors and small miners.

The chief assays made in the camp are silver, gold, lead, iron, and gangue assays, and at some smelters specific-gravity determinations of slags.

*Furnaces.*—The laboratories are generally provided with permanent erneible and muffle furnaces, made of common brick, lined with fire brick, and placed side by side, as is shown in Plate XXXIX; but very often the two furnaces are separate.

By means of the dampers D' and D' in the chimney, the assayer can regulate the draft and the intensity of heat in the furnaces. The apertures A B C D are closed by means of sheet-iron plates, easily removed by tongs. Occasionally, portable clay furnaces, of American and English manufacture, are used for cupellation.

*Pulverization.*—The ores and slags are, first of all, coarsely pounded in a cast-iron mortar (Fig. 12, Plate XLIII), a form of mortar that is not well adapted for this use, since it is too thin and very often breaks before the stone does. The coarsely pounded material is then ground on the buck-plate. This consists of a cast-iron plate (Figs. 9 and 10, Plate XLIII), about an inch thick, faced on one side, and provided or not with flanges on each side. It rests on a firm table or timber support. The ore is laid on the plate and ground with the bucker. The bucker (Fig. 11, Plate XLIII) is a mass of cast iron, with a cylindrical lower surface, faced on the plate side, and fixed to a

wooden handle. Grinding is performed by placing the left hand on the bucker, holding the handle in the right hand, and moving the bucker forwards and backwards, at the same time lifting and lowering the handle, and exerting a slight pressure with the left hand. While all this is going on the bucker is also moved from the left to the right side, and inversely, so as to increase the grinding surface. All this is much more easily performed than described.

The pulverized ore is then passed through sieves of 70 to 80 meshes to the linear inch, represented in Fig. 8, Plate XLIII, in elevation. The metallic cloth of the sieve is made of brass. It is adjusted to a tinned-iron circular frame, *b*, fitting in a circular tinned-iron box, or dust-receiver, *a*. This is a very convenient arrangement, the loss in dust is very small, and the mixing of the dust takes place at the same time as the sifting.

**Crucibles and scorifiers.**—Figs. 3, 4, and 5, Plate XLIII, represent the crucibles, scorifiers, and gold-annealing cups, which are manufactured by the Denver Fire Clay Company. The gold-annealing cups and scorifiers are similar to the European ones in appearance, but greatly inferior to them in quality. The assay crucibles, three-sixteenths of an inch thick, are probably the thinnest clay pots used in assaying in any country. They are very convenient for the reason that, with a low temperature in the furnace, the assay fluxes become easily fluid, but they never stand more than two runs in the crucible furnace.

**Cupels.**—Cupels are always made in the assay laboratories in brass molds, the process being too well known to demand description. Their form and size are shown in Fig. 6, Plate XLIII.

**Muffles.**—The muffles made by the Denver Fire Clay Company are good. They are generally large enough to hold from 12 to 16 scorifiers, enabling the assayer to assay three or four samples of ore at the same time.

**Tools.**—The scorifier tongs, cupel tongs, crucible tongs, raking rods, anvils, hammers, chisels, etc., are similar in every respect to those universally used in assaying.

**Slag molds.**—The molds into which are poured the crucible and scorifier slags are peculiar, and are represented in Figs. 1 and 2, Plate XLIII. They consist of a sheet of cast iron, divided into 12 conical molds. They are very convenient, the lead buttons and slags cooling rapidly on account of the thinness and large surface of the mold.

**Fuel.**—Coke is used in the crucible furnaces and charcoal in the muffle furnaces, but sometimes coke and charcoal are mixed in the muffle furnaces.

**Balances.**—Balances capable of weighing from four pounds to one-sixteenth of an ounce are used for the estimation of moisture in the ore; balances weighing from 100 grams to 1 milligram, for the weighing of scorifying and crucible assays; and those sensitive to the tenth of a milligram, for the weighing of silver prills and gold partings. These balances are generally manufactured by Becker & Sons, of New York. They offer no peculiarity in construction.

The *weights* used in assaying are gramme weights for lead, iron, and gangue assays, and silver prills, or gold partings; but the ore, slags, and bullion are weighed in assay tons, whose symbol is A. T., or its subdivisions. The weight boxes contain one-tenth of an assay ton, or  $\frac{1}{10}$  A. T.,  $\frac{2}{10}$  A. T.,  $\frac{5}{10}$  A. T., 1 A. T., 2 A. T. Some boxes contain besides  $\frac{1}{20}$  A. T. and 5 A. T. The system of assay-ton weights introduced by Prof. C. F. Chandler, of the School of Mines, Columbia College, New York, is as simple as it is ingenious. The ton of 2,000 pounds avoirdupois is equal to 32,000 ounces

avoirdupois, or to 29,166 ounces troy, or to 907,180,000 milligrams. The weight of the assay ton is 29,166 milligrams, consequently each milligram represents one ounce troy, and 29,166 milligrams represent one ton. When the material to be assayed for precious metals is weighed by the assay ton or its multiples, the weight of the precious metals in milligrams, or multiples of the milligram, corresponding to those of the assay ton, expresses in troy ounces the weight of gold or silver contained in one ton of ore or bullion. A few examples will illustrate this:

1. Twenty-nine thousand one hundred and sixty-six milligrams of bullion, or one assay ton, give after cupellation a button of silver weighing 205.5 milligrams. This shows that one ton of this bullion contains 205.5 ounces troy of silver.

2. One-half an assay ton of slags gives, after assaying, a button weighing  $1\frac{1}{2}$  milligrams; this shows that one ton of slag contains 3 ounces troy of silver.

3. One-tenth of an assay ton of ore contains 3 milligrams of silver; this shows that one ton of ore assays 30 ounces troy of silver.

The laboratories are provided also with sand-baths, flasks, beakers, dishes, burettes, and a few of the principal reagents used in assaying by the wet way. Iron and gangue assays are regularly made in the wet way, and occasionally the ore is assayed for sulphur and arsenic, the slags for lead, the ores and fluxes for lime and magnesia.

Silver assays.—The general process used by common consent in Leadville for ore assays is the scorification process, a rapid and accurate method. Some mines, however, require crucible assays. The scorification process is so well known and so fully described in text books that it will not be insisted upon. The assays of each sample are made in three or four scorifiers. One-tenth of an assay ton is weighed for each scorifier, and then mixed with ten times its weight, or one assay ton, of pure granulated lead, or rather with a granulated lead whose contents in silver are known and subsequently subtracted from the silver buttons obtained. The silver-prills are weighed to the tenth of a milligram, and each of these divisions corresponds to an ounce to the ton. A little borax is always used to scorify the oxide of iron and other bases. Slag, like ores, is assayed by scorification; but this process ought to be abandoned and the crucible process substituted for it, chiefly for the reason that in the crucible the assay may be made with one assay ton if necessary, this quantity not being excessive for the estimation of 1 or  $1\frac{1}{2}$  ounces of silver to the ton. The crucibles used in crucible assays are those drawn to scale in Figs. 3 and 5, Plate XLIII. A mixture of

Powdered ore .....	$\frac{1}{2}$ assay ton.
Litharge .....	1 assay ton.
Bicarbonate of soda .....	$\frac{1}{2}$ assay ton.
Borax .....	$\frac{1}{4}$ assay ton.
Argol .....	$\frac{1}{10}$ assay ton,

or some similar mixture, for each assayer has his favorite flux, is fused in them, in the presence of an iron nail or rod, which, however, some assayers dispense with altogether. The mixture is generally covered with a layer of borax or common salt.

Bullion assays.—The assays are generally made on a car-load sample, representing 10 tons. Two pieces of lead are detached from the top and bottom part of each bar of bullion forming the car-load (in general 400 bars); all these are melted together in a plumbago crucible, under a cover of live charcoal; the charcoal and scum are then removed; the sample, well mixed by stirring, is poured into an ingot mold (a bullion



one); the bar obtained is about one inch thick (Fig. 7, Plate XLV). Four pieces are detached from it with chisel and hammer, as shown in *a*, Fig. 7. One-half an assay ton is weighed from each piece, and cupelled, and the assay carried on as usual.

**Gold assays.**—Gold assays are made by dissolving the silver buttons in weak nitric acid, as usual.

**Lead assays.**—Ores and slags are assayed for lead in the crucible. Five grams of the pulverized ore or slag are mixed with 15 grams of a flux composed of

Borax .....	1 part.
Bicarbonate of soda .....	4 parts.
Argol .....	1 part.
Flour.....	$\frac{1}{2}$ part.

or some analogous flux. The mixture is fused, with or without the addition of an iron nail or rod, either in the crucible or the muffle-furnace. When the muffle is used, the crucibles, represented in Fig. 5, Plate XLIII, are placed in it, together with large pieces of charcoal, to produce a reducing atmosphere, and the front of the muffle is kept closed. In both crucible and scorification assays the lead buttons and slags, when taken out of the furnace, are rapidly poured into the molds, shown in Figs. 1 and 2, Plate XLIII. In lead assaying the button of lead, detached from the slag after cooling, is weighed in grams and its fractions, and the result, multiplied by 20, gives the percentage.

**Iron assays.**—The ores are assayed for iron by Marguerite's well-known burette process, with a standard solution of permanganate of potash.

**Estimation of gangue.**—Gangue is determined by dissolving the ore in strong hydrochloric acid, or aqua-regia, collecting the insoluble residue on a filter, washing well, calcining, and weighing. Some assayers evaporate the solution to dryness at 100° C. before filtering, in order to estimate both gangue and soluble silica.

**Estimation of moisture.**—Moisture is determined in the ores by desiccation of one pound of ore placed in a copper pan over the muffle-furnace, or over a sand-bath heated by a kerosene lamp.

**Specific gravity determinations.**—This operation is performed every day at a few smelters on the slags of each furnace. It seems an unnecessary operation, first, because superintendents ought to rely solely upon careful assays for lead and silver; second, because, with a little practical experience, the mere appearance of the slag is more reliable than its specific gravity; third, because those who determine daily the specific gravity of slags and their contents in lead and silver have never been able to find a relation between the three data. In the analytical study on the slags made specially for this report it will be seen that there is no relation whatever between the contents of lead and silver; and at the smelters it is admitted that the specific gravity of slag may be raised by other substances than lead—by iron, for instance.

The specific gravity determinations are carefully made by means of the Jolly specific gravity spring-balance, represented in Fig. 2, Plate XXXVIII. This instrument consists of a wooden gallows-frame, at the end of whose horizontal beam is suspended a delicate wire spring, provided with a small ivory index, *J*, and a small brass pan, *P*, suspended from the spring by three wires. On the face of the vertical beam, looking towards the spring, is a mirror, carefully graduated in millimeters. A beaker, three-fourths filled with distilled water, is placed on a stand, *S*, which is provided with a set-screw, and moves up and down the vertical beam.

To make a specific gravity determination the eye is placed in front of the mirror in such a position that the pupil of the eye, the upper part of the ivory index, the graduation on the mirror, and the image of the pupil in the mirror are brought into line. The number of divisions at this point is  $x$ . A small piece of slag is then placed in the pan  $P$ ; the division to which the ivory index is lowered is then carefully noted; let this be called  $x'$ ; then  $x'-x$  represents the weight of the slag in the air, expressed in divisions. The stand  $S$  is then raised until the slag dips into the water and the index rises. The number of divisions is once more carefully noted; let it be expressed by  $x''$ ;  $x'-x''$  represents the weight of the volume of the water displaced by the slag, consequently the specific gravity will be given by the formula  $\frac{x'-x}{x'-x''}$ . A little correction is necessary with this instrument;  $x''$  should in reality be  $x'' + x'''$ ;  $x'''$  being the number of divisions lost by the pan when immersed in water.

The writer has devised a little instrument, easy to carry, easy to construct, and self-correcting, for the determination of specific gravity. It consists of a test-tube ballasted with distilled water and floating in a proof-glass filled with distilled water (see Fig. 7, Plate XLII). The test-tube is carefully graduated; the level of the water  $x$ , outside of the tube, is noted, as well as the level of the water  $y$ , inside of the tube. A small piece of slag or mineral is introduced into the tube, which sinks a certain number of divisions  $x'$ ;  $x'$  represents its weight. The water is raised inside of the tube a certain number of divisions  $y'$ ;  $y'$  represents its volume;  $\frac{x'}{y'}$  gives its specific gravity corrected for temperature. One of the great advantages of this instrument is that specific gravity determinations can be made with almost as much accuracy with common water as with distilled, the weight and volume of water being self-correcting.

## SECTION II.

### MATERIALS USED IN SMELTING.

#### GENERAL CONSIDERATIONS.

Smelting is conducted on exactly the same principle by all the smelters throughout the camp. *Ab uno disce omnes*. The ore is invariably smelted in blast furnaces lined with fire-brick, and provided with water-jackets at the zones of agglomeration and fusion; dolomite, hematite, and old slag being used as fluxes, and a mixture of charcoal and coke as fuel. In one smelter only a little metallic iron (old horse-shoes) is used for the reduction of galena when present in certain proportions in the ore, but even at this smelter it is an accidental rather than a normal operation. The facilities afforded to the smelters by nature in the Leadville region are really very great; there smelting is practically reduced to its elementary principles. The ore is, so to speak, "roasted by nature," since cerussite is evidently in all cases the result of the oxidation of galena; it requires no preliminary preparation save crushing, and for about one-fifth of the ore, which comes out of the mine in the state of sand, this is, of course, dispensed with; the quantity of matte and speiss formed is small; a good quality of hematite is found on Breece Hill, though it is used but in

small quantity, owing to the fact that the ores themselves often contain the requisite quantity of iron to form slag, and to reduce arsenical, antimonial, and sulphuret compounds of lead. Dolomite, as will be seen later, forms as good a flux as carbonate of lime; its chief defect is that the slag formed is less fusible than pure lime-and-iron slag.

Before the railroads reached Leadville the smelters were compelled to use dolomite. Since that time it is said that a smelting firm has adopted the use of limestone with good results and that its use is likely to become general in the camp.

Smelting in Leadville at the present day is never badly performed, chiefly for the reason that all the furnaces are constructed on the same principles and are provided with the latest improvements. The imperfections in smelting are generally intentional, and are based on economical grounds which are in themselves unattackable and render criticism useless. Still, it must be stated that a few smelting firms have brought smelting in Leadville to actual practical perfection, and in their economic results these are the most successful.

STATISTICS OF LEADVILLE SMELTERS.

In Table IV will be found the following information, compiled from data gathered by special experts for Mining Statistics of the Tenth Census and by the writer, for the year ending June 1, 1880, each smelter being designated by a letter:

- I. Annual consumption of ore.
- II. Annual consumption of fluxes; their nature and cost.
- III. Annual consumption of fuels; their nature and cost.
- IV. Annual production of bullion; its contents, and cost of transportation.
- V. Relations between ore, fuel, fluxes, bullion, and silver.
- VI. Plant of each smelter.
- VII. Labor; amount, time employed, and cost.

TABLE IV.

I. ORE.

	A.	B.	C.	D.	E.	F.	G.	H.	I.
Tons...	10,236	38,000	18,590	4,200	8,411	5,793	25,464	12,000	(a)

a No data.

II. FLUXES.

- 1. Dolomite.
- 2. Hematite.
- 3. Average price of dolomite per ton.
- 4. Average price of hematite per ton.

		A.	B.	C.	D.	E.	F.	G.	II.	I.
1.	Tons ..	232	5,312	4,170	250	440	964	2,467	(a)	(a)
2.	do ....	280	143	1,774	292	587	1,162	2,968	(a)	(a)
3.	Dollars	2.80	4.00	3.50	4.00	3.50	3.50	b 1.25	3.50	(a)
4.	do ....	8.00	10.00	9.50	11.50	6 to 7	9.00	8.50	10.00	(a)

a No data.

b Cost of hauling.

## III. FUELS.

1. Charcoal, in bushels.
2. Charcoal, in tons.
3. Coke, in tons.
4. Proportion of charcoal to coke at each smelter.
5. Pine wood, for boilers, in cords.
6. Average weight of cord of pine wood used.
7. Cost of charcoal per bushel.
8. Average price of charcoal per ton.
9. Cost of coke per ton.
10. Cost of pine wood per cord.

	A.	B.	C.	D.	E.	F.	G.	H.	I.	Average.
1. Bushels	188,760	1,094,870	500,558	76,791	200,000	279,498	563,087	(a)	(a)	.....
2. Tons ...	1,342½	7,664	3,546	537½	1,400	1,956½	3,941½	(a)	(a)	.....
3. ...do ...	3,309	4,890	2,810	263	700	810	2,550	(a)	(a)	.....
4. ...do ...	6.4 : 1	1.5 : 1	1.2 : 1	2 : 1	2 : 1	2.4 : 1	1.5 : 1	(a)	(a)	1.33 : 1 b
5. Cords .	1,040	3,600	1,200	400	760	750	(c)	1,200	800	.....
6. Pords.	3,000	2,800	3,000	3,000	3,000 to 3,500	2,000 to 3,200	2,000 to 2,800	2,000 to 2,800	(a)	.....
7. Conta ..	10 to 15	10 to 17	10 to 15	12 to 18	10 to 18	10 to 18	13	10 to 12	(a)	.....
8. Dollars .	18.57	18.57	18.57	18.57	18.57	18.57	18.57	18.57	(a)	.....
9. ...do ....	28.60	25.58	30.45	30.56	28.60	25.60	25.56	27.50	(a)	.....
10. ...do ....	4.50	4.75	5.00	4.75	4.50	4.00	4.50	4.50	(a)	.....

a No data.

b Proportion for whole camp obtained from 2 and 3.

c Charcoal screenings, but little wood.

## IV. BULLION.

1. Tons of bullion produced.
2. Average tenor of bullion in silver (ounces per ton).
3. Average tenor of bullion in gold (ounces per ton).
4. Total amount of silver in ounces.
5. Freight to the East per ton of bullion.

	A.	B.	C.	D.	E.	F.	G.	H.	I.
1. Tons ....	1,752	6,200	4,436	503	1,240	1,321	4,012	5,000	(a)
2. Ounce ..	404.5	328.53	250	250	300	300	450	300	(a)
3. ...do .....	2.08	None	None	None	.15	None	None	.15	(a)
4. ...do .....	708,684	2,036,886	1,109,000	125,750	372,000	306,300	1,805,400	1,500,000	(a)
5. Dollars .	40 to 45	(b)	(b)	(b)	(b)	27 to 35	35.00	35.50	(b)

a No data.

b Paid by refiner.

V. PROPORTIONAL RELATIONS.

1. Parts of dolomite to 100 parts of ore.
2. Parts of hematite to 100 parts of ore.
3. Parts of fuel to 100 parts of ore.
4. Parts of fuel to 100 parts of smelting charges.
5. Bullion extracted to 100 parts of ore.
6. Percentage of lead extracted in smelting.
7. Percentage of silver extracted in smelting.
8. Charges for smelting per ton of ore, in dollars.
9. Cost of smelting per ton of ore, in dollars.
10. Average assay of slag, in ounces of silver per ton.
11. Average assay of flue-dust, in ounces of silver per ton.

	A.	B.	C.	D.	E.	F.	G.	H.	I.	Average.
1.....	2.27	13.98	22.43	5.95	5.23	16.64	9.69	No data	No data	a10.88
2.....	2.73	.37	9.54	6.95	6.98	20.06	11.65	No data	No data	a8.3
3.....	45.35	23.04	34.19	19.06	24.96	47.76	25.49	No data	No data	a32.83
4.....	36.25	23.33	22.60	15.33	19.33	32.50	19.00	No data	No data	a24.03
5.....	17.11	16.31	23.86	11.98	14.74	22.8	15.75	41.66	No data	a20.53
6.....	85 to 88	86 to 91	88	85 to 95	85 to 90	90 to 93	87	90	85 to 90	88
7.....	100	95 to 97	97	88 to 95	95	97	98.5	97.5	96	96.5
8.....	15 to 30	15 to 30	15 to 30	12 to 25	16 to 30	15 to 30	15 to 30	15 to 30	15 to 30	22.00
9.....	12 to 18	18 to 23	10 to 15	13 to 16	15 to 18	13.00	13.68	15.00	16 to 18	15.25
10.....	?	4	0.5	1.5	1.5	1.5	1.5	4	1.5	2
11.....	36	37	36	35	35	36	36	37	37	36

a These five averages were obtained by dividing by seven the sum of the respective proportions given for each smelter from which data were obtained. This gives a true average of the proportions for each smelter, but it might be considered that a truer average for the camp would be obtained directly from the totals of ore, fluxes, and fuel consumed during the year by these seven smelters. Calculated in this way, the average proportions are, respectively, dolomite to ore, 12.50; hematite to ore, 6.51; fuel to ore, 31.99; fuel to charge, 23.31; bullion to ore, 19.94.

VI. PLANT OF SMELTERS.

Smelter.	A.	B.	C.	D.	E.	F.	G.	H.	I.
<b>1. Furnaces:</b>									
(a) Number in use .....	2	6-3	2	2	2	2	4	3-1	2
(b) Shape .....	Round.	Round-square.	Square	Square.	Round.	Square.	Square.	Round-square.	Round.
(c) Working capacity: tons per 24 hours.	35 to 40	180	70	40	50	60	120	100	50
<b>2. Steam-engines:</b>									
(a) Number in use .....	1	2	1	1	1	1	2	1	1
(b) Horse power .....	40	160	50	40	40	50	70 and 50	100	60
(c) Average steam pressure, pounds.	60	70	60	65	70	65	60	80	70
<b>3. Stone-breakers:</b>									
(a) Number in use .....	2	3	3	1	2	2	2	1	1
(b) Capacity numbers ..	No. 5.	Nos. A, 2, and 5.	Nos. A, 2, and 5.	No. A.	Nos. 1 and 5.	Nos. 0 and 4.	Nos. 2 and 5.	No. 5.	No. A.
<b>4. Cornish rolls:</b>									
Number in use .....	None.	3	1	1	1	None.	2	1	None.
<b>5. Other crushers:</b>									
.....	3 stamp-battery.	Pulverizer.	None.	None.	None.	Small mill.	None.	None.	None.
<b>6. Blowers:</b>									
(a) Number in use .....	2	9	2	2	2	2	4	4	2
(b) Capacity numbers ..	No. 5.	Nos. 4, 4½, and 5.	No. 5½.	No. 5.	Nos. 4½ and 5½.	No. 5.	Nos. 4½, 5, 5½, and 6.	Nos. 5 and 5½.	No. 5½.
<b>7. Dust chambers:</b>									
(a) Number in use .....	1	2	2	1	1	2	4	1	2
(b) Construction material.	Bricks.	Sheet-iron.	Limestone.	Sheet-iron.	Bricks.	Sheet-iron.	Bricks.	Sheet-iron.	Sheet-iron.

## VII. LABOR.

## 1. Number of each class of employees per 24 hours, when works are in full blast.

	A.	B.	C.	D.	E.	F.	G.	H.	I.
Staff .....	4	9	7	4	6	5	5	5	5
General foreman .....							2		
Foremen .....		6	2	1			3	2	1
Head smelter .....	2	27	8	4	4	4	13	8	4
Slag wheelers .....		32			2	4	12	9	3
Feeders .....		27			4	4	13	8	4
Helpers .....	32	48	20	10		8	8	10	5
Engineers .....		7							
Fuel men .....					2				
Day laborers .....		81	60 to 70	10 to 15	12	20	20 to 25	10	20

## 2. Length of shift for employees (in hours).

General foreman .....							13		
Foreman .....	12	8	12	12	12	12	8	12	12
Head smelter .....	12	8	12	12	12	12	8	12	12
Slag wheeler .....	12	12	12	12	12	12	8	12	12
Feeders .....	12	8	12	12	12	12	8	12	12
Helpers .....	12	12	12	12	12	12	12	12	12
Day laborers .....	12	10	10	10	10	10	10	10	10
Engineers .....	12	8	12	12	12	12	8	12	12
Fuel men .....	12	8	12	12	12	12	8	12	12

## 3. Wages per shift of employees.

General foreman .....							\$5 00		
Head smelter .....	\$4 25	\$3 00	\$4 00	\$4 00	\$4 00	\$3 50	3 00	\$4 00	\$4 00
Foreman .....		4 00	4 to 6 00	5 00	5 00		3 00	4 00	4 50
Slag wheelers .....		3 00			4 00	3 00	2 50	3 00	3 00
Feeders .....		3 00		4 00	3 50	3 50	3 50	3 50	4 00
Helpers .....	2 50	3 00	3 00	3 00	3 00	3 00	3 00	3 00	3 00
Day laborers .....	2 50	2 50	2 50	2 50	2 50	2 50	2 50	2 50	2 50
Engineers .....		3 50							
Fuel men .....					3 00				

## 4. Aggregate salary of staff per month.

Aggregate .....	\$870	\$1,350	\$1,400	\$700	\$1,100	\$800	\$900	\$800	Nodata
-----------------	-------	---------	---------	-------	---------	-------	-------	-------	--------

## 5. Total salaries and wages per twenty-four hours.

Total .....	\$197 50	\$697 50	\$328 52	\$122 51	\$110 16	\$140 30	\$232 58	\$176 30	Nodata
-------------	----------	----------	----------	----------	----------	----------	----------	----------	--------

## CONSTRUCTION MATERIALS.

**Common brick.**—The bricks used in the construction of outer walls and dust-chambers are made from clays found in California and Big Evans gulches. They are made in a very simple way: Into a wooden mold (Figs. 9 and 10, Plate XLIV), divided into three compartments having the shape and dimensions of bricks, a lump of the clay, brought to the proper degree of consistency, is jammed at one blow without subsequent effort or pressure. The excess of clay, represented by *c* in Fig. 9, is cut off by means of an iron wire, both ends of which are fixed to a wooden handle (Fig. 11, Plate XLIV). The mold is then reversed and gently shaken. The detached bricks are dried as usual in long rows in the air. They are then piled up in large stacks and burned.

**Fire-brick.**—The fire-bricks used for the lining of furnaces are sent to Leadville chiefly from the manufactory of Messrs. Evans & Howard, St. Louis, Missouri, and also from the Cambria Fire-brick Company, Golden, Colo., and from the Denver Fire-clay Company, Denver, Colo.

**Tapping clay.**—Good plastic and refractory clay is needed for tympan-stones, tap-holes, tamping, and steep (brasque) used in the lining of furnace crucibles. The following analysis of tapping clay found in Big Evans gulch and used at the Grant smelter was made by Dr. M. W. Iles, of the Grant Smelting Works:

## ANALYSIS VII. TAPPING CLAY.

Silicate of alumina.....	74.5
Water .....	14.0
Oxide of iron.....	3.0
Magnesia.....	Trace
Carbonate of lime.....	6.8
Free silica.....	1.0
	99.3
	(M. W. Iles.)

**Other materials.**—When the smelting works are erected on the plans of superintendents, the smelting implements are derived from various sources. The castings, however, such as water-jackets, iron pillars, plates for supports and frames of crucibles, ingot-molds, slag-pots, etc., are generally made by Messrs. Hendey & Meyer, of Denver; while the boilers and engines are made by different foundries. In many cases smelters have found it more convenient and advantageous to obtain the whole of their smelting plant from Messrs. Fraser & Chalmers, of Chicago, Ill., who are prepared to furnish a complete smelting outfit, from the crushers and furnace down to ingot-molds and tamping-rods.

## FUELS AND FLUXES.

**Coke.**—Coke is made in El Moro, on the Rio Grande Railroad, from Cretaceous coals found there; it is known in Leadville as El Moro coke. It is also made in Como, on the South Park Railroad, from Como Cretaceous coals, and is then known in Lead-

ville as South Park coke. From Messrs. Billing & Eilers, prominent smelters of Leadville, the following information respecting coke has been obtained. The composition of the ash was determined in their laboratory.

ANALYSES VIII AND IX. COKES.

	VIII, El Morocoke.	IX, South Park coke.
Percentage of ash .....	22.0	9.5
Composition of ash :		
Silica .....	84.5	29.1
Peroxide of iron .....	7.1	47.8
Alumina, lime, etc .....	8.4	23.1
	100.0	100.0

The weight of coke per bushel is about 40 pounds, so that one ton of coke contains about 50 bushels. Detailed information respecting the consumption of coke, its price, and relation to charcoal has already been given in Table IV.

**Charcoal.**—This fuel is made from the spruce tree, which abounds in the vicinity of Leadville. The pine wood, cut in lengths of four feet, is converted into charcoal by the usual process of slow burning in pits or kilns. The pits consist of stacks of wood 40 feet long, 12 feet high, and 15 feet wide, entirely covered with earth. Apertures provided at the base of this rough kiln allow the slow combustion of wood to take place. When the operation is completed the apertures are stopped with earth and the whole mass is allowed to cool thoroughly. The charcoal made in this way is not of very good quality; that made in kilns is much better.

**Charcoal kilns.**—In the valley of the Arkansas, south of Malta, there are several establishments each provided with nine or eleven beehive-shaped kilns, erected especially for the purpose of supplying the smelters with charcoal. The oldest establishment of this kind is to be found in California gulch, in close proximity to the south bank and opposite to Messrs. Billing & Eilers's smelter; these kilns were erected by Mr. McAllister, who was the first to introduce them in the vicinity of Leadville, and from him was obtained the following information: His establishment consists of six kilns, similar in every respect, one of which, drawn to scale, is represented on Plate XXVIII, Figs. 3 and 4. The kilns are beehive-shaped; they are made of fire-brick cemented with lime-and-sand mortar, each kiln being made of 18,000 bricks. The greatest diameter is 22 feet, the height 21 feet. In front of the kiln is a charging and discharging opening, *A*, 5 feet 5 inches high and 5 feet wide, closed by a sheet-iron door, and at the back and upper part of the kiln is a feed-hole or door, *B*, similarly closed, 4½ feet high and the same in width. This feed-hole is placed at a height of 16 feet from the ground. It is connected by a tramway, running over a bridge, with the wood-stacks on the upper part of the bank of the gulch. This wood is already cut in lengths of four feet. At the base of the kiln are three rows of apertures 3 inches by 4 inches and two feet apart. The rows are 1 foot apart and contain from 22 to 25 apertures. These holes may be closed at will with bricks and clay.

The pine wood, cut in lengths of four feet, as has been previously stated, is first piled through the lower opening, *A* (large stacks of wood stand on this level), and afterwards through the upper door, *B*, and in this way the kiln is completely filled.



Both doors being left open to create a draft, a charcoal and dry-wood fire is kindled at the door A. Both doors are then closed and hermetically sealed with clay, and the combustion is regulated by means of the apertures *O*, which are left open or are closed, according to the intensity or direction of the wind. The air enters at the lower row and the smoke escapes at the upper.

For the complete transformation of wood into charcoal in these kilns it requires from four to eight days, according to whether the wood is dry or green. Dry wood produces a greater percentage of charcoal and of better quality than green wood. When the combustion is completed, all the apertures are hermetically sealed by means of bricks and clay and the kiln is allowed to cool thoroughly. The cooling requires about four days.

Each kiln holds from 25 to 27 cords of wood, or about 3,550 cubic feet; one cord of wood produces about 50 bushels of charcoal. In consequence, each kiln yields on an average 1,300 bushels of charcoal in 10 days. During each operation about two gallons of creosote tar runs out at the lower part of the ground door, but no use is made of it. The charcoal made in this way is of excellent quality and gives great satisfaction.

The weight of one bushel of charcoal is about 14 pounds; consequently there are about  $142\frac{1}{2}$  bushels of charcoal to the ton.

Composition of ash.—At the Leadville smelters charcoal is said to contain about 2.5 per cent. of ash. This figure is probably quite correct for pit-charcoal. A rough examination was made of a fine jet black piece of charcoal from McAllister's kilns, picked from the heap at Messrs. Billing & Eilers's smelter. This gave only 1.62 per cent. of ash, containing 0.42 per cent. of soluble salts (carbonate of potash and soda, with some chlorides) and 1.20 per cent. of alumina, silica, lime, phosphates, etc. A rough examination was also made of some charcoal ash found in the laboratory of the Cumming & Finn smelter; the proportion of soluble alkaline salts was about the same as in the preceding, but the insoluble residue was chiefly composed of alumina. In all probability the composition of charcoal ash varies according to the nature of the soil upon which the trees grew. In the discussion on smelting, 2.5 per cent. has been adopted as the average percentage of ash in charcoal.

Dolomites.—The dolomites are extracted chiefly from the Dugan and Montgomery quarries and from the Glass-Pendery and Carbonate mines. The consumption, price, and proportion of dolomite used, etc.; will be found in Table IV. The samples which were analyzed in the laboratory of the Survey were prepared by mixing equal weights of typical specimens picked up on the heap at various smelters.

Analysis X is that of the Dugan dolomite from the Dugan quarry, near Mount Zion, Arkansas Valley. This dolomite is in rather large, indistinct crystals, with a bluish-black tinge and with white, creamy-yellow, and red spots. The specimens were found at the Cumming & Finn and Elgin smelters.

Analysis XI is that of the Montgomery dolomite, from the Montgomery quarry, on Iron Hill, California gulch. This dolomite is in compact, homogeneous masses, with a fine crystalline structure and a bluish-black tinge. The specimens were collected at the American, California, Grant, Harrison, La Plata, and Billing & Eilers's smelters.

Analysis XII is that of dolomite from the Glass-Pendery mine, on Carbonate Hill. This dolomite has a very peculiar appearance. It is formed of homogeneous and very

friable masses, composed of indistinct and exceedingly small crystals, with a uniform grayish tinge. The specimen analyzed was found at Grant smelter, where a large quantity of it is used.

## ANALYSES X, XI, AND XII. DOLOMITES.

*Elementary.*

	Analysis X (Dugan).	Analysis XI (Montgomery).	Analysis XII (Glas-Peodery).
Carbonic acid .....	46.9262	43.7947	47.3922
Chlorine .....	0.1420	0.0618	0.0408
Sulphur .....	Trace	Trace	None
Sulphuric acid .....	None	Trace	None
Phosphoric acid .....	0.1224	0.0670	0.0328
Sodium .....	0.0697	0.0273	0.0119
Potassium .....	0.0386	0.0151	0.0110
Magnesium .....	Trace	Trace	Trace
Calcium .....	Trace	Trace	Trace
Lime .....	30.4297	27.2586	29.9671
Magnesia .....	20.7843	20.0455	21.5230
Protoxide of manganese .....	0.0533	0.0620	0.1998
Protoxide of iron .....	0.3827	0.5742	0.1275
Protoxide of lead .....	Trace	Faint trace	None
Peroxide of iron .....	0.1002	0.0974	0.2232
Silica .....	0.7064	7.7652	0.2748
Alumina .....	0.1673	0.1068	0.0400
Organic matter .....	0.0250	0.0676	0.0152
Water .....	0.0440	0.0550	0.0707
Loss .....	0.0013	0.0012	0.0700
Total .....	100.0000	100.0000	100.0000

*Rational.*

Carbonate of lime .....	54.0637	48.5353	53.4445
Carbonate of magnesia .....	43.6470	42.0955	45.1983
Carbonate of manganese .....	0.0662	0.1003	0.3232
Carbonate of iron .....	0.0165	0.9251	0.2054
Carbonate of lead .....	Trace	Faint trace	None
Sulphate of lime .....	None	Trace	None
Phosphate of lime .....	0.2652	0.1464	0.0710
Chloride of sodium .....	0.1774	0.0694	0.0456
Chloride of potassium .....	0.0738	0.0288	0.0181
Chlorides of magnesium and calcium .....	Traces	Traces	Traces
Sulphide of iron or calcium .....	Trace	Trace	None
Silica .....	0.7064	7.7652	0.2748
Alumina .....	0.1673	0.1068	0.0400
Peroxide of iron .....	0.1002	0.0974	0.2232
Organic matter .....	0.0250	0.0676	0.0152
Water .....	0.0440	0.0550	0.0707
Loss .....	0.0013	0.0072	0.0700
Total .....	100.0000	100.0000	100.0000

*Discussion.*—The dolomites used in smelting are true dolomites, in which small quantities of carbonate of lime and magnesia are replaced by carbonates of manganese and iron. The presence of chlorides was at first puzzling, for the reason that about half the total quantity of chloride was soluble in boiling water when the dolomites

were finely powdered, the other half insoluble. The insoluble chloride might have been contained in apatite crystals combined with calcium. A microscopical examination by Mr. Whitman Cross disclosed, however, no apatite, but a very great number of minute fluid inclusions. Both he and Dr. W. F. Hillebrand were led to believe that the chlorides were contained in the inclusions. Dr. Hillebrand partly proved it by levigating the dolomites and thereby extracting nearly three-fourths of the chlorides by treatment with water. Mr. Emmons directed me to make experiments on dolomites broken into small pieces, but not powdered. These were digested with water over a water-bath for 48 hours. The first solution contained only traces of chlorides, and the experiment being repeated a second time in the same conditions the second solution did not contain any chlorine, thus proving that the chlorides are not impregnating the mass of the rock, but are contained within the crystals of dolomite. The fact that the Glass-Pendery dolomite, which is half disintegrated, contains much less chloride than the dolomites in compact masses corroborates these views.

The Dugan and Montgomery dolomites have another point of interest, which should not be overlooked. These dolomites contain traces of sulphides, whether of iron or of calcium there was no time to determine. The fact is, however, that no sulphide of iron is visible in the microscopical section and that the dolomites treated by weak acids evolve unmistakable sulphureted hydrogen. Should the presence of sulphide of calcium eventually be proved beyond a doubt it would give a great practical value to the observation made by the writer, that carbonate of lime is extremely soluble in sulphide of calcium. This reaction is so striking that it seems probable that it plays a great part in nature and that carbonates of lime may be carried away in alkaline solutions as well as in acid ones and deposited from these. On the other hand, there seems to be a relation between the quantity of organic matter and the quantity of sulphides contained in the dolomites. The Glass-Pendery dolomite, which contains only traces of organic matter, has no sulphides, while the Montgomery dolomite, which contains the largest proportion of organic matter, contains also the largest amount of sulphides. These relations may, however, be purely accidental. The dolomites were examined for the precious metals, but no silver could be detected in either of them, although it is said in Leadville that the Glass-Pendery dolomite contains from one to two ounces and the Carbonate Mine dolomite from two to six ounces of silver to the ton.

To complete the discussion of dolomites a few analyses made at various Leadville smelters are given below. The average composition of dolomites, which has been adopted in the discussion on smelting, was derived from them.

*Analysis of a Glass-pendery dolomite once used at the California smelter, made at the time by the superintendent, Mr J. E. Hardman.*

ANALYSIS XIII. DOLOMITE.

Carbonate of lime .....	50.03
Carbonate of magnesia .....	35.16
Silica .....	1.14
Protoxide of iron .....	0.41
Alumina .....	2.62
Moisture .....	10.64
	100.00

*Analyses of dolomites made in the Grant Smelting Works by Dr. M. W. Iles.*

	XIV.	XV.	XVI.	XVII.	XVIII.	XIX.
Carbonate of lime .....	66.50	54.94	49.57	57.05	51.60	55.35
Carbonate of magnesia.....	25.10	41.93	37.08	39.65	39.77	39.35
Carbonate of iron.....	None	None	6.23	None	None	None
Silica .....	2.70	0.93	4.22	0.76	2.50	2.80
Alumina and peroxide of iron...	6.40	1.31	3.53	1.65	6.13	2.50
Organic matter .....	None	0.21	None	None	None	None
Total .....	100.70	99.32	100.63	100.01	100.00	100.00

NOTE.—Analyses XIV and XV, locality not given; XVI, Glass mine dolomite; XVII, Carbonate mine dolomite, said to contain from two to six ounces of silver to the ton; XVIII and XIX, Glass-Pendery dolomite, said to contain from one to two ounces of silver to the ton.

The superintendents in Leadville do not like dolomite as a flux. It is probable that before long limestone will be substituted for it. Already Messrs. Billing & Eilers have experimented at their smelter with perfectly pure arragonite from the Duncan quarry, Arkansas Valley, close to Leadville, and the results have been most satisfactory.

Limestone.—Should limestone be used instead of dolomite, it might be brought from Robinson, in the Ten-Mile District, 16 miles distant, or from Cañon City, about one hundred and thirty miles south of Leadville, on the Rio Grande Railroad. These limestones are similar in appearance to lithographic limestone. That from Robinson (Upper Carboniferous) contains 97.11 per cent. of carbonate of lime, as determined by Dr. W. F. Hillebrand. The following analysis of the Cañon City limestone (Cretaceous) was made by Dr. M. W. Iles.

ANALYSIS XX. CAÑON CITY LIMESTONE.

Carbonate of lime.....	83.90
Carbonate of magnesia .....	6.30
Silica .....	3.10
Alumina and oxide of iron.....	1.50
	99.80

Hematite.—The hematite used as a flux at the smelters is chiefly extracted from the Breece Iron mine, on Breece Hill, but at one smelter some Silver Wave mine iron ore is also much used as a flux. This ore was not, however, examined. The sample of Breece Hill hematite, which was examined in the laboratory of the Survey, was made from specimens collected on the hematite heaps of the following smelters: American, California, Elgin, Harrison, and Billing & Eilers.

The following is the description of the specimens and the color of their streaks:

1. Black, submetallic luster; red spots; reddish violet streak.
2. Red and yellow; silicious appearance; deep brick-colored streak.
3. Very compact; submetallic luster; magnetic; black streak.
4. Compact; dull luster; light brick-colored streak.
5. Black; submetallic luster; brownish streak.

In Analysis XXI the decimals are carried to six figures, in order to introduce both gold and silver.

## HEMATITES USED AS FLUXES.

647

## ANALYSIS XXI. BREECE IRON ORE.

*Elementary analysis.*

Iron .....	66.443392
Manganese .....	0.007280
Nickel and cobalt .....	Trace
Zinc .....	0.025201
Copper .....	0.022597
Gold .....	0.000102
Silver .....	0.000404
Arsenic .....	0.007174
Antimony .....	Trace
Oxygen .....	27.430173
Chlorine (traces calculated) .....	0.000132
Water .....	0.290000
Carbonic acid .....	2.444655
Phosphoric acid .....	0.100740
Titanic acid .....	0.052250
Silica .....	2.388500
Lime .....	0.121800
Magnesia .....	0.619900
Alumina .....	0.045000
Loss .....	0.000700
	<hr/>
	100.000000

Silver, 0.13 ounce to the ton.

Gold, 0.06 ounce to the ton.

*Rational analysis.*

Peroxide of iron .....	71.843540
Magnetic oxide of iron ( $Fe_3O_4$ ) .....	18.009740
Carbonate of iron .....	6.445000
Chloride of silver .....	0.000536
Gold .....	0.000102
Arsenic acid (combined with $Fe_2O_3$ ) .....	0.011000
Oxide of copper .....	0.028300
Oxide of zinc .....	0.031400
Peroxide of manganese .....	0.011500
Oxides of cobalt, nickel, and antimony .....	Trace
Phosphate of lime .....	0.218140
Titanic acid (in the state of titanate of iron) .....	0.052250
Silica .....	2.388500
Lime .....	0.004400
Magnesia .....	0.619900
Alumina .....	0.045000
Water .....	0.290000
Loss .....	0.000692
	<hr/>
	100.000000

*Discussion.*—The hematite was not examined either for bromine or iodine, with which silver is generally combined in Leadville. Chromium, tungsten, molybdenum, and vanadium were carefully sought for, but no traces of these metals could be detected.

Titanium could only be found by a method which was specially devised for its detection, and which is the following: The hydrochloric solution of hematite is reduced to the minimum of oxidation by sulphureted hydrogen and then boiled to expel the excess of this gas. The solution is then as nearly as possible neutralized with an

alkali and boiled with an excess of hyposulphite of soda, which precipitates titanio acid, alumina, and a little soluble silica. The precipitate collected on a filter, washed thoroughly and calcined, is treated in a platinum vessel with a mixture of sulphuric, hydrochloric, and hydrofluoric acids, and the whole is evaporated to dryness. The residue is fused with bisulphate of potash, and titanio acid is extracted, as usual, by boiling the dilute solution.

Although magnetic oxide of iron is reported in the analysis with the formula  $\text{Fe}_3\text{O}_4$ , this is not exact. The writer succeeded in isolating this oxide in a state of great purity by alternately extracting it with the magnet and rubbing it with the finger on filter paper until it no longer soiled the paper, to which the non-magnetic oxides remained attached. It was then analyzed, and its composition is represented by the formula  $\text{Fe}_{20}\text{O}_{27} = 6(\text{FeO}) + 7(\text{Fe}_2\text{O}_3)$ , instead of  $7(\text{FeO}) + 7(\text{Fe}_2\text{O}_3)$ , which would be equivalent to the formula  $\text{Fe}_3\text{O}_4$ . It is only quite natural that magnetic oxide formed in the midst of peroxide of iron should contain an excess of this oxide. The writer assumes that the force of adhesion was used for the first time in this instance for the mechanical separation of substances. It has been employed since in connection with the use of the magnet in investigations on the nature of different metallurgical products, and in each case it has led to interesting results.

#### ORE-BEDS.

Smelting charges consist of mixtures of ore with fluxes and fuel in definite but somewhat varying proportions, previously determined, so as to produce a desired chemical combination.

The ore entering into the smelting charge may be an unmixed ore of known composition, or a previously-prepared mixture of ores, called an ore-bed, or a combination of the two.

Ore-beds are prepared by superposing layers of different ores of known weight and composition in such proportion as to produce mixtures of known contents in lead, silver, iron, and silica.

Composition of ore-beds.—Ore-beds are generally made to contain equal parts of metallic iron, metallic lead, and silica or gangue, or from 20 per cent. to 25 per cent. of each. The relation between lead and silver is about six pounds of lead to one ounce of silver; but this relation often varies, as well as the percentage of lead, while, on the contrary, the percentage of iron and gangue remains pretty constant.

The great advantage derived from the preparation of ore-beds, besides giving mixtures of known composition, is that of drying the ore, an operation which if carried on in the furnace would absorb an enormous amount of heat.

In Table V will be found the following particulars in regard to seven different ore-beds:

1. Humid weight of each ore-bed in pounds.
2. Average percentage of moisture for each ore-bed.
3. Dry weight of each ore-bed in pounds.
4. Percentage of silica or gangue for each ore-bed.
5. Total weight of silica in pounds for each ore-bed.
6. Percentage of iron for each ore-bed.
7. Total weight of iron in pounds for each ore-bed.
8. Average tenor of silver in ounces to ton for each ore-bed.
9. Total weight of silver in ounces for each ore-bed.
10. Percentage of lead for each ore-bed.
11. Total weight of lead in pounds for each ore-bed.

TABLE V.—Composition of ore-beds.

Number of ore-bed.	Ore.			Silica.		Iron.		Silver.		Lead.	
	Humid weight.	Molst-ure.	Dry weight.	Per cent.	Total weight.	Per cent.	Total weight.	Ounces to the ton.	Total weight.	Per cent.	Total weight.
	<i>Lbs.</i>	<i>P. ct.</i>	<i>Lbs.</i>		<i>Lbs.</i>		<i>Lbs.</i>		<i>Ounces.</i>		<i>Lbs.</i>
1 .....	410,355	10.2	368,430	21.54	79,375	21.48	79,160	42.94	7,912	10.50	71,868
2 .....	340,915	10.8	304,099	26.50	80,840	23.20	70,779	39.12	5,946	19.60	59,875
3 .....	302,690	10.7	270,257	22.30	60,354	22.10	59,975	35.03	4,734	20.00	54,105
4 .....	283,000	9.4	256,358	22.00	56,475	26.40	67,876	61.62	7,898	21.00	54,135
5 .....	279,475	12.0	245,902	20.00	49,321	16.60	40,841	66.02	8,146	28.20	69,437
6 .....	330,805	10.2	296,920	25.40	75,556	21.86	64,696	65.03	0,690	19.00	56,267
7 .....	.....	.....	235,340	17.35	40,831	24.78	58,321	56.53	6,651.9	23.45	55,239
Totals and average..	.....	.....	1,977,306	22.40	442,752	22.30	441,648	51.56	50,977.9	21.30	420,926

No. 1 is made at Smelter H of ore from the Amie, Hibernia, Homestake, and Morning Star mines.  
 No. 2 is made at Smelter H of ore from the Amie, Chrysolite, Evening Star, Morning Star, and Virginus mines.  
 No. 3 is made at Smelter H of ore from the Amie, Evening Star, Hibernia, Homestake, Little Giant, Morning Star, etc.  
 No. 4 is made at Smelter H of ore from the Amie, and Evening Star.  
 No. 5 is made at Smelter H of ore from the Amie, Adelaide, and of fine-dust.  
 No. 6 is made at Smelter H of ore from the Amie, Morning Star, etc.  
 No. 7 is made at Smelter B of ore from the Catalpa, Evening Star, Henriett, Hibernia, Highland Chief, Morning Star, and Silver Wave mines.

A consideration of Table V shows—

1. That the ore beds vary a good deal in weight; in the examples given, from 117 to 189 tons.
2. That the mixtures contain on an average about the same quantity of silica, iron, and lead.
3. That on an average the relation of silver to lead by weight is as 1 to 120.4, or one ounce of silver to 84 pounds of lead.
4. That the amount of moisture is pretty constant.

SMELTING CHARGES.

By smelting charges will be designated the combined weights of ore, fluxes, and fuel thrown at the same time into the furnaces, and by charges, the weights of ore and fluxes entering into the composition of the smelting charges. The word ore embraces ore beds and unmixed ores, and the word fluxes, dolomite, hematite, and old slags. The weights of smelting charges differ a good deal, according to the capacity of the furnaces. The term fuel will always be used for the mixtures of coke and charcoal used in Leadville. Although the amount of fuel used in smelting will always be given in weight, it must be remembered that coke and charcoal are not weighed at all smelters, but are as often measured by the shovel or the barrow; the volume has been converted into weight for comparison.

SMELTER A.

The information obtained at this smelter is not very satisfactory. The smelting charges are made up of—

Ore, 150 pounds.		Flux, 50 pounds.		Fuel, 35 pounds.	
Ore-bed .....	100	Dolomite .....	10	Charcoal.....	15
Unmixed ore.....	50	Hematite .....	10	Coke.....	20
		Old slags .....	30		

Charge (ore and flux), 200 pounds. Smelting charge (ore, flux, and fuel), 235 pounds.

When coke is scarce the above fuel is used, but when coke is plentiful the fuel preferred is 35 pounds of a mixture of 60 per cent. coke and 40 per cent. charcoal.

The proportions are as follows:

Flux to ore .....	33½
Fuel to ore.....	23½
Fuel to charge .....	17½

This would form a very fair smelting charge; but, if we reconstruct an average charge from the consumption of ore, flux, and fuel, given for this smelter in Table IV, we find the following result:

Ore, 150 pounds.	Flux, 27.5 pounds.	Fuel, 68 pounds.
Ore ..... 150	Dolomite ..... 3.4	Charcoal..... 19.7
	Hematite ..... 4.1	Coke ..... 48.3
	Old slags ..... 30.0	

Charge (ore and flux), 187.5 pounds. Smelting charge (ore, flux, and fuel), 255.5 pounds.

The discussion of this average charge leads to the following results:

Proportion of flux to ore.....	25
Proportion of fuel to ore.....	45½
Proportion of fuel to charge .....	36¼

After inspecting these figures no one will be surprised to hear that the superintendent of this smelter complains bitterly of his furnace. The furnaces are undoubtedly very clumsy, but they are constructed on the same plan as all the other furnaces in the camp, and the fault lies chiefly in the fact that less hematite and dolomite is used at this smelter than at any other, that the slags are less fluid than any others in the camp, and that the enormous percentage of fuel exhausts itself uselessly on refractory charges. The number of smelting charges run through each furnace in twenty-four hours is equal to 300.

#### SMELTER B.

*Smelting charges made in August, 1880.*

##### No. 1.

Ore, 510 pounds.	Flux, 200 pounds.	Fuel, 140 pounds.
Ore-bed ..... 200	Dolomite ..... 50	Charcoal..... 80
Low-grade ore..... 100	Old slags ..... 150	Coke..... 60
Various rich ores .. 200		
Lead scraps ..... 10		

Charge (ore and flux), 710 pounds. Smelting charge (ore, flux, and fuel), 850 pounds.

##### No. 2.

Ore, 510 pounds.	Flux, 190 pounds.	Fuel, 140 pounds.
Ore-bed ..... 100	Dolomite .. ..... 40	Charcoal..... 80
Low-grade ore..... 100	Old slags ..... 150	Coke ..... 60
Various rich ores .. 300		
Lead scraps ..... 10		

Charge, 700 pounds. Smelting charge, 840 pounds.



SMELTER B.

Smelting charges made in August, 1880—Continued.

No. 3.

Ore, 510 pounds.	Flux, 190 pounds.	Fuel, 140 pounds.
Ore-bed..... 150	Dolomite ..... 40	Charcoal..... 80
Low-grade ores .... 100	Old slags ..... 150	Coke ..... 60
Various rich ores.. 250		
Lead scraps..... 10		

Charge, 700 pounds. Smelting charge, 840 pounds.

No. 4.

Ore, 500 pounds.	Flux, 150 pounds.	Fuel, 140 pounds.
Ore-bed..... 300	Dolomite ..... 50	Charcoal..... 70
Various rich ores .. 200	Old slags ..... 100	Coke ..... 70

Charge, 650 pounds. Smelting charge, 700 pounds

At Smelter B fuel is measured by the wheelbarrow. Eighty pounds of charcoal represent one charcoal barrow made of thin sheet-iron and holding about 5½ bushels. Sixty pounds of coke represent an ore barrow used also for coke. In Fig. 2, Plate XXXI (elevation of Smelter C), both kinds of barrows are indicated.

In the smelting charges Nos. 1, 2, 3, and 4, the average proportions are:

Flux to ore.....	36
Fuel to ore.....	27½
Fuel to charge.....	20¼

If we reconstruct an average smelting charge from data given in Table IV we find—

Ore, 500 pounds.	Flux, 206.7 pounds.	Fuel, 165.1 pounds.
Various ores..... 500	Dolomite ..... 69.85	Charcoal..... 100.8
	Hematite ..... 1.85	Coke ..... 64.3
	Old slags ..... 135	

Charge (ore and flux), 706.7 pounds. Smelting charge (ore, flux, and fuel), 871.8 pounds.

The figures represented here are normal; the great amount of old slags used at this smelter accounts for the relatively small proportion of hematite. The percentage of fuel is in excess of that given in the preceding examples, for the reason that part of the fuel at the smelters is used for assaying, heating, and various other purposes besides smelting.

The proportions in the average charge are as follows:

Flux to ore.....	41½
Fuel to ore.....	33
Fuel to charge.....	23½

SMELTER C.

*Smelting charges made in August, 1880.*

No. 1.

Ore, 306 pounds.		Flux, 157 pounds.		Fuel, 100 pounds.	
Ore-bed .....	123	Dolomite .....	00	Charcoal .....	50
Rock Mine ore ....	123	Hematite .....	7	Coke .....	50
Evening Star ore ..	19	Old slags .....	60		
Dunkin Mine ore ..	41				

Charge (ore and flux), 463 pounds. Smelting charge (ore, flux, and fuel), 563 pounds.

No. 2.

Ore, 315 pounds.		Flux, 148 pounds.		Fuel, 100 pounds.	
Ore-bed .....	100	Dolomite .....	84	Charcoal .....	50
Rock Mine ore ....	100	Hematite .....	4	Coke and screenings.	50
Evening Star ore ..	44	Old slags .....	60		
Rock Mine ore ....	71				

Charge, 463 pounds. Smelting charge, 563 pounds.

No. 3.

Ore, 332 pounds.		Flux, 127 pounds.		Fuel, 95 pounds.	
Ore-bed No. 1 .....	106	Dolomite .....	64	Charcoal .....	50
Ore-bed No. 2 .....	53	Hematite .....	3	Coke and screenings.	45
Dunkin Mine ore ..	40	Old slags .....	60		
Rock Mine ore .....	133				

Charge, 459 pounds. Smelting charge, 554 pounds.

At Smelter C the above charges are smelting charges according to our definition, but they are called semi-charges. The slags are not weighed, but measured by the ore-shovel; they are not mixed with the ore and flux, but with the fuel. Fuel is measured by the fuel-shovel in the proportion of two shovels of charcoal for one of coke. One shovel of charcoal (fuel-shovel) is equal to seven pounds, and one shovel of coke (fuel-shovel) to 14 pounds. One shovel of slags (ore-shovel) weighs about 15 pounds.

In smelting charges Nos. 1, 2, and 3, the average proportions are—

Flux to ore .....	45½
Fuel to ore .....	31
Fuel to charge .....	21½

At Smelter C the smelting charges are model ones, like everything else connected with this smelter. The slags obtained from the above smelting charges have the composition of single-silicates. They are very fluid at a relatively low temperature, and carry less lead and silver than any others in the camp; and the average charge representing the work done during a whole year will show with what regularity work is carried on at this smelter.

The average charge, deduced from data given in Table IV, is as follows:

Ore, 310 pounds.	Flux, 157.6 pounds.	Fuel, 105.9 pounds.
Ores ..... 310	Dolomite ..... 69.53 Hematite ..... 29.57 Old slags ..... 58.50	Charcoal ..... 59.10 Coke ..... 40.80

Charge (ore and flux), 467.6 pounds. Smelting charge (ore, flux, and fuel), 573.5 pounds.

In the average charge the proportions are—

Flux to ore .....	50½
Fuel to ore .....	34½
Fuel to charge .....	22¾

Being in possession of data obtained at Smelter C for the month of July, 1880, these data will be discussed, for in the opinion of the writer everything connected with Smelter C is worth recording.

	Tons.
Ore smelted in July, 1880.....	1,500
Dolomite smelted in July, 1880.....	525
Hematite smelted in July, 1880.....	85
Bullion produced in July, 1880.....	435½

The bullion produced in twenty-four hours is equal to 14 tons, assaying 136 ounces of silver to the ton.

The average charge for the month of July, 1880, is as follows:

Ore, 310 pounds.	Flux, 144 pounds.	Fuel, 105 pounds.
Ores ..... 310	Dolomite ..... 67 Hematite ..... 17 Old slags ..... 60	Fuel ..... 105

Charge (ore and flux), 454 pounds. Smelting charge (ore, flux, and fuel), 559 pounds.

In the preceding charge the average proportions are—

Flux to ore .....	46½
Fuel to ore .....	34
Fuel to charge .....	23

Production of bullion per charge, 90 pounds.

As has previously been stated, the mixture of ore, dolomite, and hematite, weighing about eight hundred pounds, is called the charge. It is made to contain about 20 per cent. of lead, of which about 88 per cent. is extracted in the state of bullion. Consequently each charge will contain 160 to 161 pounds of lead, of which 141 to 141.5 pounds are extracted in the state of bullion. This quantity of bullion requires 200 pounds of fuel for its extraction, showing that one part of bullion requires about one and one-half parts of fuel for its reduction.

As the quantity of material to be smelted in each charge weighs about 920 pounds, from which 141 pounds are extracted in the state of bullion, the remaining 779 pounds

constitute the slag, containing about 2 per cent. of lead, or 15 pounds, and the loss in fumes is equal to about four pounds of lead per charge. Each charge gives about 5.67 parts of slag for one part of bullion. The furnaces run about two hundred charges in 24 hours, yielding: Bullion, 16 tons; slag, 80 tons; and consuming: Rich ores, 63½ tons; fuel, 20 tons; charges, 143 tons.

## SMELTER D.

*Smelting charges made in August, 1880.*

Ore, 700 pounds.		Flux, 330 pounds.		Fuel, 160 pounds.	
Ore-beds.....	500	Dolomite.....	80	Charcoal.....	95
Various ores.....	200	Hematite.....	170	Coke.....	65
		Old slags.....	80		

Charge (ore and flux), 1,030 pounds. Smelting charge (ore, flux, and fuel), 1,190 pounds.

In the preceding smelting charges the proportions are—

Flux to ore.....	47
Fuel to ore.....	22½
Fuel to charge.....	15½

The composition of this smelting charge is a normal one. The composition of the average smelting charge, calculated from the data given in Table IV, is the following:

Ore, 700 pounds.		Flux, 170.3 pounds.		Fuel, 133.4 pounds.	
Various ores.....	700	Dolomite.....	41.65	Charcoal.....	89.6
		Hematite.....	48.65	Coke.....	43.8
		Old slags.....	80		

Charge (ore and flux), 870.3 pounds. Smelting charge (ore, flux, and fuel), 1,003.7 pounds.

In the average smelting charge the proportions are—

Flux to ore.....	24½
Fuel to ore.....	19
Fuel to charge.....	17½

The percentage of fuel is the smallest which has been yet observed, and this last smelting charge would prove the most perfect if it were not for the important element, *time*, which has been purposely neglected. The question will be discussed after exhausting the composition of smelting charges of the various smelters, and it will be seen whether it is advisable to aim at the lowest percentage of fuel in smelting charges.

## SMELTER E.

*Smelting charges made in August, 1880.*

Ore, 300 pounds.		Flux, 80 pounds.		Fuel, 73 pounds.	
Ore-bed.....	200	Dolomite.....	15	Charcoal.....	36.5
Various ores.....	100	Hematite.....	15	Coke.....	36.5
		Old slags.....	50		

Charge (ore and flux), 380 pounds. Smelting charge (ore, flux and fuel), 453 pounds.

In the preceding smelting charge the proportions are —

Flux to ore.....	26½
Fuel to ore.....	24½
Fuel to charge.....	19½

*Average charge deduced from data given in Table IV.*

Ore, 300 pounds.	Flux, 86.6 pounds.	Fuel, 74.9 pounds.
Various ores..... 300	Dolomite..... 15.69	Charcoal..... 49.9
	Hematite..... 20.91	Coke..... 25
	Old slags..... 50	

Charge (ore and flux), 386.6 pounds. Smelting charge (ore, flux, and fuel), 461.5 pounds.

In the average smelting charge the proportions are —

Flux to ore.....	29
Fuel to ore.....	25
Fuel to charge.....	19½

The general rule observed at this smelter is the following: The ore is made to contain 30 per cent. of gangue, 30 per cent. of iron, and 20 per cent. of lead, and the charges are smelted with 20 per cent. of fuel.

SMELTER F.

*Smelting charges made in August, 1880.*

Ore, 500 pounds.	Flux, 280 pounds.	Fuel, 150 pounds.
Ore-bed (very siliceous)..... 500	Dolomite..... 110	Charcoal..... 130
	Hematite..... 120	Coke..... 20
	Old slags..... 50	

Charge (ore and flux), 780 pounds. Smelting charge (ore, flux, and fuel), 930 pounds.

In the above smelting charge the proportions are —

Flux to ore.....	56
Fuel to ore.....	30
Fuel to charge.....	19½

*Average charge calculated from data given in Table IV.*

Ore, 500 pounds.	Flux, 233.4 pounds.	Fuel, 258.8 pounds.
Various ores..... 500	Dolomite..... 83.2	Fuel..... 238.8
	Hematite..... 100.2	
	Old slags..... 50	

Charge (ore and flux), 733.4 pounds. Smelting charge (ore, flux, and fuel), 972.2 pounds.

In the average charge the proportions are —

Flux to ore.....	46½
Fuel to ore.....	47½
Fuel to charge.....	32½

## SMELTER G.

*Smelting charges made in August, 1880.*

Ore, 645 pounds.	Flux, 142 pounds.	Fuel, 140 pounds.
Iron Mine ore..... 85	Dolomite ..... 62	Charcoal..... 80
Robert E. Lee ore.. 123	Old slags ..... 80	Coke ..... 60
Morning Star ore.. 185		
Robert E. Lee ore.. 77		
Evening Star ore.. 175		

Charge (ore and flux), 787 pounds. Smelting charge (ore, flux, and fuel), 927 pounds.

In the preceding charge the proportions are—

Flux to ore.....	22
Fuel to ore.....	21½
Fuel to charge.....	17½

*Average charge deduced from data given in Table IV.*

Ore, 600 pounds.	Flux, 203 pounds.	Fuel, 153 pounds.
Various ores..... 600	Dolomite ..... 58.1	Charcoal ... .. 92
	Hematite ..... 69.9	Coke ..... 61
	Old slags ..... 75	

Charge (ore and flux), 803 pounds. Smelting charge (ore, flux, and fuel), 956 pounds.

In the average charge the proportions are—

Flux to ore.....	33½
Fuel to ore.....	25½
Fuel charge.....	19

At this smelter the fuel is measured by the shovel.

## SMELTER H.

*Smelting charges made in August, 1880.***No. 1.**

Ore, 530 pounds.	Flux, 175 pounds.	Fuel, 130 pounds.
Ore-bed..... 560	Dolomite ..... 55	Charcoal..... 110
Adelaide ore..... 30	Old slags ..... 120	Coke ..... 20

Charge (ore and flux), 705 pounds. Smelting charge (ore, flux, and fuel), 835 pounds

**No. 2.**

Ore, 550 pounds.	Flux, 155 pounds.	Fuel, 130 pounds.
Ore-bed..... 500	Dolomite ..... 35	Charcoal ..... 110
Adelaide ore ..... 50	Old slags ..... 120	Coke..... 20

Charge, 705 pounds. Smelting charge, 835 pounds.

SMELTING CHARGES AT INDIVIDUAL SMELTERS.

657

No. 3.

Ore, 480 pounds.	Flux, 160 pounds.	Fuel, 120 pounds.
Ore-bed ..... 480	Dolomite ..... 60 Old slags ..... 100	Charcoal..... 100 Coko..... 20

Charge, 640 pounds. Smelting charge, 760 pounds.

No. 4.

Ore, 500 pounds.	Flux, 135 pounds.	Fuel, 120 pounds.
Ore-bed ..... 450 Adelaide ore..... 50	Dolomite ..... 35 Old slags ..... 100	Charcoal..... 100 Coke..... 20

Charge, 635 pounds. Smelting charge, 755 pounds.

In the preceding smelting charges the proportions are —

	No. 1.	No. 2.	No. 3.	No. 4.
Flux to ore .....	33	28½	33½	27
Fuel to ore .....	24½	23½	25	24
Fuel to charge.....	18½	18½	18½	19

Data relative to the consumption of ore, fluxes, and fuel not being obtainable at this smelter, one of the most important in the camp, the construction of an average smelting charge is impossible; but the general rule observed at the works in the composition of the smelting charges is the following: The ore-beds are made to contain equal parts of gangue and metallic iron, 20 to 25 per cent. of each, and from 16 to 25 per cent. of lead, about six pounds of lead for one ounce of silver. When the proportion of gangue and iron is equal in the ore-bed, the ore is mixed with 10 per cent. of dolomite; but when gangue is in excess hematite is added in sufficient quantity to make the balance. At this smelter the slags obtained are called acid slags. The fuel-shovels used at this and other smelters are drawn to scale in Figs. 1, 2, and 3, and the ore and slag shovels are shown in Figs. 4 and 5, Plate XLIV.

SMELTER I.

Smelting charges made in August, 1880.

[At this smelter the ore-bed was made with Morning Star, Duukin, Iron mine, and Agassiz ore.]

Ore, 526 pounds.	Flux, 273 pounds.	Fuel, 147.5 or 137 pounds.
Ore-bed..... 263	Dolomite ... 66	Charcoal.... 60.5 } or { 57
Virginus..... 156	Hematite ... 67	Coke..... 27 } or { 80
Chrysolite (sand). 107	Oldslags.... 140	

Charge (ore and flux), 799 pounds. Smelting charge (ore, flux, and fuel), 946.5 or 936 pounds.

In the preceding charges the proportions are —

Flux to ore .....	52
Fuel to ore .....	26 and 28
Fuel to charge .....	17½ and 18½

Charges made at California works in February, 1880. — Mr. J. E. Hardman had the kindness to communicate the following experimental charges, which he made at the California smelting works while superintendent, chiefly with a view to avoid the use of old slags.

	No. 1.	No. 2.	No. 3.	No. 4.	No. 5.	No. 6.
Ore-beds .....	500	400	250	425	450	500
Various ores .....			150			
Dolomite .....	45	40	50	50	65	55
Hematite .....	78	100	85	00	20	50
Old slags .....	18	18				
Charcoal .....	100	100	100	100	90	110
Coke .....	40	24	24	24	48	32
<i>Total weights:</i>						
Ore .....	500	400	400	425	450	500
Flux .....	141	158	135	140	85	105
Charges .....	641	553	535	565	535	605
Fuel .....	140	124	124	124	158	142
Smelting charges .....	781	682	659	689	673	747
Number of charges in 24 hours .....	80	...	100	00	00	54

In the preceding charges the proportions are —

	No. 1.	No. 2.	No. 3.	No. 4.	No. 5.	No. 6.
Flux to ore .....	28½	30½	33½	33	10	21
Fuel to ore .....	18	31	31	29½	30½	28½
Fuel to charges .....	21½	22½	23½	22	25½	23½

The following table will aid in the correct interpretation of these figures:

Tons per 24 hours of —	No. 1.	No. 3.	No. 4.	No. 5.	No. 6.
Ore consumed .....	20.0	21.2	19.1	14.8	13.5
Charge consumed .....	25.6	28.35	25.4	17.65	16.31
Fuel consumed .....	5.0	6.57	5.58	4.55	3.83
Slag formed .....	17.0	16.5	18.5	16.5	12.0
Bullion formed .....	2.0	2.5	3.0	5.25	2.25

It results from this table that for each ton of fuel burned the quantity of ore smelted is equal to: In No. 1, 3.5 tons; in No. 3, 3.2; in No. 4, 3.4; in No. 5, 3.2; and in No. 6, 3.5—showing that there is no advantage in using flux instead of old slag, and that there is a disadvantage in doing so, since fluxes are costly and are apt to carry away no inconsiderable quantities of lead and silver, while old slag costs nothing and is already saturated with lead and silver.



## RÉSUMÉ.

General discussion.—By comparing, in a tabulated form, the average data obtained in the preceding discussions relative to each smelter with the relation between the actual and the nominal capacity, it will be possible to some extent to realize the relation between the composition of smelting charge and the time.

	A.	B.	C.	D.	E.	F.	G.	H.
Proportion of flux to ore .....	25.0	41.3	50.8	24.3	29.0	46.6	33.8	30.4
Proportion of fuel to ore .....	45.3	33.0	34.2	19.0	25.0	47.7	25.5	24.3
Proportion of fuel to charge .....	30.2	23.3	22.6	15.3	19.3	32.5	19.0	18.6
Tons of ore per 24 hours (actual capacity) ..	28.0	104.0	51.0	11.5	23.0	15.9	69.7	32.9
Nominal capacity .....	35.0	180.0	70.0	40.0	50.0	60.0	120.0	100.0
Relation of actual to nominal capacity .....	0.80	0.57	0.72	0.29	0.46	0.26	0.57	0.32

NOTE.—The relations of actual and nominal capacity, as here given by Mr. Guyard, cannot be relied upon, as he has assumed that each smelter was running 365 days during the year, whereas in point of fact the running time must have been much less and must have varied widely in the cases of different smelters, none of which were probably running at their full capacity for any great length of time. (S. F. E.)

## SECTION III.

## PLANT AND SMELTING OPERATIONS

## SMELTING PLANT IN GENERAL.

Furnaces.—All the furnaces of Leadville are built on the same general principles and contain the same essential parts, but they belong to two distinct styles: the rectangular or square and the circular or round. The following description is made from furnaces of both styles used at Smelter B, but a glance at all the other furnaces sketched for this report, in which the same parts are designated by the same letters, will show that the differences are only in details.

*Square furnaces* (see Plate XXVI).—The general appearance of these furnaces is that represented in elevation, Fig. 1. The furnace is formed of two independent parts: (1) The masonry *C*, supported on a main cast-iron plate support, *O*, resting on cast-iron pillars, *P*. (2) The ercible *A* upon which rest the water-jackets *B*. The space between the water-jackets and the masonry is filled up with fire-brick, *b*. This arrangement, as it is easy to perceive, is most convenient for repairs of parts exposed to injury or destruction, and cannot be too highly commended. It is universally adopted in the camp. The masonry is firmly bound by braces *Q*, the system adopted for bracing varying with almost every furnace. Immediately above the feeding-floor, *P'*, are to be seen the feed-holes, *H*, provided with sliding doors, *S'*. The smelting charges are thrown into the furnace through these holes.

The different parts of the masonry are the following (see vertical section, Fig. 3): *C* is the shaft of the furnace. The portion of the shaft immediately below the feed-holes is called the throat. It is seen also in horizontal section in Fig. 4. *D* is the chimney. *E* is the stack. The stack can be closed or opened by means of the damper *G*. The stack is also connected with the dust-condensing chambers by means of the sheet-

iron flue *F'*. *C'* represents the walls of the furnace. The wall placed above the slag-gutter *U*, which is always considered as the front part of the furnace, is called the front wall. The opposite wall, at the rear, is the back wall; on each side are the side walls, in which apertures are provided for the feed-holes. A wooden hood, *W*, and chimney, *W'*, are placed in front of the furnace and above the slag-gutter to carry off the fumes from slags. The crucible *A* is formed of strong cast-iron plates, *a*, firmly screwed and bolted together, and it is covered with a cast-iron plate, *d* (see Figs. 3 and 5, Plate XXIX). The crucible is lined with fire-brick or steep (brasque). In front of the crucible projects the fore-hearth *X*, to which is adapted the slag-gutter *U*. On one side of the crucible is placed the lead-pot *L*, communicating with the hearth or crucible *A'* (Figs. 1, 2, and 3, by means of the siphon *L'*). This arrangement is called the siphon-tap or automatic tap. It constitutes one of the greatest improvements ever introduced in the construction of blast furnaces, for by its means lead keeps always at the same level and thus escapes as much as possible the oxidizing action of the blast. The lead pot is always inclosed in a cast or wrought iron box or frame, *a'*, projecting outside of the crucible. The portion of the hearth designated by *A''* (Fig. 3) is the dam. *X'* is the steep of which the hearth, fore-hearth, and lead-pot are made.

The water-jackets *B* constitute also one of the greatest improvements ever introduced in the construction of blast-furnaces. When properly cared for they never get injured; occasionally they may get shifted or spring a leak between the joints, but this rarely affects the jackets themselves. It is sufficient to state that smelting campaigns of thirteen months are known in the camp, to give an idea of the importance of this arrangement. The water-jackets *B* are hollow boxes, indicated in elevation, Fig. 1, and in section, Fig. 3. They are made of cast-iron, wrought-iron, or steel boiler-plates. In the furnace now under description they are made of cast iron. In the water-jackets water can circulate freely, so that the temperature of this portion of the furnace wall, where the most intense heat reigns in the interior, never exceeds 60° to 70° C. The water-jacket arrangement is always sectional, so as to afford every facility for the removal of the jackets when the furnaces need important repairs. The sectional disposition admits of the expansion and contraction of this portion of the furnace without altering the relative positions of the parts, and on this account must be highly commended.

In the furnace under description there are twelve jackets: two in front, called the front or breast jackets; two at the back; and four on each side. In horizontal section, Fig. 2, the manner in which they are formed is shown very clearly. The jackets are firmly screwed, bolted, and braced together. Each jacket is provided with one or more circular apertures for the introduction of the nozzles of the tuyeres. In Fig. 2 the arrangement and disposition of the tuyeres *N* is plainly seen. Each jacket is provided with a cast-iron feeder, *R*, forming an integral portion of the jacket and cast with it, for the introduction of water. The level of this feeder is higher than the upper part of the jacket, so as to fill it completely with water. Small pipes, *S*, screwed to the feeders, act as outlets for the hot water, which is carried away by the water-gutter *T*. Cold water is introduced in the feeders by means of the taps *Y* supplied from the main water-pipe, *M*. In Leadville the tuyeres are never provided with any special arrangement for cooling them by water, for the reason that the water-jackets act as perfect coolers of the tuyeres. The tuyeres are generally made of thin gal-

vanized sheet-iron, provided with sliding valves, *l*, used to observe the interior of the furnace, and also as safety-valves, for they are left partially opened. The front jackets are always provided with an open space, *V*, varying in shape and dimensions, and closed with a plug of tapping-clay. This plug is called the tympan-stone. The tap-hole *Z* is perforated through the tympan-stone for the exit of molten slag.

*Circular furnaces* (Plate XXVII).—The circular furnaces are constructed on the same principles as the square ones, differing only in that their masonry is always hidden from view by a wrought-iron casing or jacket, *J'*, painted black. This jacket is made of riveted wrought-iron plates about one-fourth inch thick. The round furnaces, like the square ones, are made of two independent parts; the masonry supported on a cast-iron plate, *O*, resting on cast-iron pillars, *P*; and the crucible or hearth *A*, upon which rest the circular water-jackets *B*, always made of wrought-iron plates riveted. The interval between the water-jackets and the masonry is also filled in with fire-brick, *b*. The main cast-iron plate support *O* is provided with a circular vertical flange, *O'*, and with four projecting horizontal flanges, *O''*, corresponding to the pillars. These horizontal flanges are supported by brackets *r*; they rest on the flanges (designated also by *O''*) of the capitals of the pillars, supported by brackets *t*. The masonry jacket *J'* (Fig. 3) is incased by the flange *O'* of the main cast-iron plate support *O*, and rests on this plate, as does the masonry *C'*. The wall *C'* is made of fire-bricks. The stack *E*, a continuation of the jacket *J'*, is not lined with fire-bricks. A wooden hood, *W*, and chimney, *W'*, are placed in front of the furnace, above the slag-gutters. The hexagonal induction blast-pipe *I* supplies the branch pipes *J* and the tuyeres *N* with the blast. *K* represents the canvas hose or wind-bags connecting the branch pipes *J* with the tuyeres *N*.

The hearth or crucible *A* and fore-hearth *X* are made of strong cast-iron plates, firmly bound together and covered with a cast-iron plate, *d*. The lead-pot, which projects from the crucible, is framed in a wrought-iron or cast-iron box. The fore-hearth is provided with two slag-gutters, *U*. The hearth *A'*, fore-hearth *X'*, and lead-pot *L* are made of steel. The lead-pot and crucible communicate, as in the case of square furnaces, by means of the siphon *L'*. The circular water-jackets are made of two sections, firmly bound together. Each section is provided with a water-supply pipe, *M*, at base, and an outlet, *M'*, at top, to carry off hot water. In these jackets no other feeders are used.

Holes in the jackets allow the introduction of the tuyeres. The horizontal section (Fig. 2) through the tuyeres shows the disposition of the blast apparatus in the furnace. The deflecting elbow or sheet-iron flue *F'* forms the connection between the chimney *D* and the dust-condensing chamber *D'*. The stack *E* is provided with a damper, *G*. The furnace has but one feed-hole, *H*, with its sliding door *S*.

*Blast apparatus.*—The blast apparatus in general use in Leadville consists of rotary positive blasts, driven by steam power; of galvanized-iron pipes, for the distribution of the blast; and of thin galvanized-iron tuyeres, connected with the branches of the blast-pipes by means of canvas hose or wind-bags. The blower mostly adopted is Baker's rotary forced-blast blower, but at one smelter Root's forced-blast blower is also in use. The average pressure of the blast introduced in the furnaces is one inch of mercury. The following table gives the character, capacity, etc., of the blowers used at each smelter:

TABLE VI.—*Blowers in use.*

At smelter.	Number in use.	Kind of blower.	Volume of blast per revolution.	Number of revolutions per minute.	Volume of blast per minute.	Extreme limits of pressure in inches of mercury.
			<i>Cubic feet.</i>		<i>Cubic feet.</i>	
A.....	2	Baker's, No. 5.....	25	80	2,000	1 to 1½
B.....	6	..... do .....	25	90	2,250	1 to 1½
B.....	2	Baker's, No. 4½.....	10½	90	1,485	1 to 1½
B.....	1	Baker's, No. 4.....	12	90	1,080	1 to 1½
C.....	2	Baker's, No. 5½.....	30	85	2,250	¾ to 1½
D.....	2	Baker's, No. 5.....	25	88	2,200	¾ to 1½
E.....	1	Baker's, No. 4½.....	10½	80	1,320	1
E.....	1	Baker's, No. 5½.....	30	80	2,400	1
F.....	2	Baker's, No. 5.....	25	80	2,000	¾ to 1½
G.....	1	Baker's, No. 4½.....	16½	108	1,782	¾ to 1½
G.....	1	Baker's, No. 5½.....	30	100	3,000	¾ to 1½
G.....	1	Baker's, No. 6.....	45	85	3,825	¾ to 1½
G.....	1	Root's, No. 5.....	23½	129	3,000	¾ to 1½
H.....	3	Baker's, No. 5.....	25	85	2,125	1
H.....	1	Baker's, No. 5½.....	30	100	3,000	1
I.....	2	..... do .....	30	80	2,400	1
J.....	2	Baker's, No. 5.....	25	80	2,000	1
K.....	1	Baker's, No. 4½.....	16½	80	1,320	1
L.....	1	Baker's, No. 5.....	25	85	2,125	1
M.....	1	Baker's, No. 4½.....	16½	80	1,320	1
N.....	1	Baker's, No. 4.....	12	90	1,080	1
O.....	2	Baker's, No. 5.....	25	80	2,000	1

The horse-power required to drive the blowers at a given rate is obtained by the following empirical formula:  $V$  being the volume of blast in cubic feet to be delivered in one minute;  $P$ , the pressure shown by the manometer in the blast-pipes, expressed in ounces per square inch;  $H$ , the horse power; and  $h$ , the power required to overcome friction, varying with the size of the blowers:

$$H = \frac{V \times P \times 0.003}{11} + h$$

The power required to run one of the blowers is proportionate to the pressure of the blast, volume delivered, and friction; blowers of different sizes require the same power when they deliver the same volume of blast.

**Baker's rotary forced-blast blower.**—These blowers are manufactured by Messrs. Wilbraham Brothers, of Philadelphia. They are compact and constructed on very simple principles. They deliver a positive blast, the volume of which is proportionate, for each size, to the number of revolutions. They hardly ever get out of order and give universal satisfaction in Leadville. (The sketches corresponding to the following description are those of a blower No. 5, taken from the maker's catalogue.) They consist of a cast-iron case,  $A$  (Figs. 1 and 2, Plate XLII), strongly ribbed and bolted, rectangular in plan and section, and of an arched top,  $B$ . Inside of this works a drum,  $D$ , carrying two tapering arms,  $C C'$ , which sweep round so close to the interior periphery that no air escapes. There are, besides, in the cast-iron case  $A$  two other drums,  $E$

and *F*, acting as valves; each is provided with a crescent-shaped abutment and recess, which allow the wings of the fan *C C'* to pass it. The three drums are connected by suitable gearing on the outside of the case, as is shown in Fig. 1, in such a manner that the revolutions of the drum-valves draw air isochronously with those of the fan-drum. By their combined operation air is drawn in at one side of the apparatus at the ordinary pressure and compressed at the other to the pressure required, this pressure being in direct proportion to the velocity of the drum, as indicated in Table VI.

The blower is placed on a brick chamber, *M* (Fig. 2), connected with a sheet-iron pipe, *N*, through which air is drawn. This is the best arrangement, for by its means accidents which might result from the introduction of dust are prevented, and meanwhile concussion of air is avoided, which renders the machine comparatively noiseless. But the sheet-iron pipe *N* is often dispensed with, and air is simply drawn through the grating *R R'*, placed in front of the blower (Fig. 1). The blower is connected at *O* with the general system of blast pipes by means of galvanized sheet-iron pipes, which must be air-tight. When the apparatus is in full blast, a slight and regular pulsation is felt at two or three small holes placed at the rear of the case. Such is, in all its simplicity, the Baker's rotary blower, the most perfect apparatus of the kind ever used in smelting.

**The Root positive-blast blower.**—The Root blower, manufactured by Messrs. P. H. & F. M. Root, of Connersville, Ind., is shown in perspective (Fig. 3, Plate XLII) and in vertical section (Fig. 4). These sketches are copied from the maker's engraving of a No. 5 blower, delivering  $23\frac{1}{4}$  cubic feet of blast per minute revolution. It is the Roots' new style of blower, formed entirely of metallic parts and less delicate in the details of its construction than the old style. This machine, like the Baker blower, is very simple and effective, and gives a positive blast in nearly every part of the case, proportionate to the number of revolutions. The external parts of the Root blower consist of two semicircular cast-iron cases, *A* and *B*, screwed and bolted to two cast-iron end plates, *S S'*, which serve also as supports to the whole machine and to the cast-iron blast-pipe *O* and air chamber *M*; of five cast-iron journals, *J*; five phosphor-bronze journal-boxes, *K*; two cut-gears, protected by the housing, *H*, and one driving pulley, *P*.

The internal-blast contrivance consists of two cast-iron revolvers, *C C'*, mounted on steel shafts, *I I'*. Each revolver acts as a fan-drum and drum-valve, with recess and abutments, forming the very simple and ingenious contrivance seen in Fig. 4. As with the Baker blower, the blast-pipe *O* is connected by means of an air-tight galvanized sheet-iron pipe with the general system of blast-pipes distributing the blast to the tuyeres of the furnaces.

**Blast-pipes.**—A glance at Table IV will show that at each smelter the number of blowers in use corresponds to the number of furnaces at work, and as a matter of course the capacity numbers of the blowers correspond to the smelting capacity of the furnaces. The furnaces of Leadville being always worked with several tuyeres, the blast is always distributed by branch pipes from an induction-pipe surrounding the furnace. A glance at any of the descriptive sketches of furnaces accompanying this report will show this arrangement, *I* always representing the induction pipes and *J* the branch pipes of the same. When the smelting works have only one furnace the induction-pipe is placed in direct communication with each blower by means of a

branch pipe, *T*, which in this case acts as a main. At Smelter I, working with two furnaces, each furnace induction-pipe is similarly placed in direct communication with each blower; but the general system adopted in the camp, at smelters working with two or more furnaces, is to connect all the blowers with a main pipe, *R*, from which the branch pipes *T* distribute the blast to the induction-pipes of each furnace. The whole system of blast-pipes, including the tuyeres, but with the exception of the canvas wind-bags, is made of galvanized sheet iron.

**Blast-pipe system.**—The most complete and perfect system of blast-pipes, from which this description will be made, is applied at Smelter C. At Smelter F the arrangement is similar in every respect; at the other smelters the arrangement is very nearly the same, and if there are slight modifications of the general system there are no improvements on it. Two blowers, *A* and *B* (Fig. 1, Plate XXXI), communicate with the main pipe, *R'*, by means of the pipes *E*, each of which is provided with dampers or sliding-valves, *F*, regulating the draft, and with safety-valves, *S*, regulating the pressure. The safety-valves are set to a pressure of about nine-eighths of an inch of mercury. The draught is regulated in the main pipe, *R'*, by means of dampers, *F*, or sliding valves worked by a lever, *h h'* (see Fig. 5, Plate XXIX). A similar damper, *F''* (Fig. 1, Plate XXXI), allows the excess of blast to escape from the main pipe. The branch pipes *T'*, provided with dampers *F*, worked like the preceding, allow the introduction of the proper amount of blast required by each furnace; each pipe, *T'*, communicates at *Z''* with a manometer. The general arrangement of the induction-pipe *I* and a branch pipe, *J*, is clearly shown in the same figure, and a glance at Fig. 5, Plate XXIX, indicates the connection of the branch pipes *J* with the tuyeres *N* by means of the canvas hose *K*. Thus by the preceding disposition an even pressure of blast is secured in a main pipe, from which the proper amount required for each furnace is taken at will. As far as the distribution of blast is concerned, the blast-pipe system just described is absolutely perfect; but it lacks an important element, which would render invaluable services in smelting, namely, the means of ascertaining the volume of blast blown into each furnace during a certain lapse of time. This could easily be determined by the use of a meter similar to those used for the measurement of illuminating gas in cubic feet. This meter should be placed between the damper *F* of the branch pipes *T'* and the induction-pipes of each furnace. In this way atmospheric air might be considered as one of the elements of the smelting charges, and by this means weighed or measured with as much accuracy as the fuel itself, with which it bears the closest relation. This important point will be insisted upon in the discussion of the smelting reactions.

#### SMEETING OPERATIONS IN GENERAL.

**Drying of the furnace.**—When the furnace is new or when an old furnace has been recently relined, it is first of all carefully dried by means of a slow charcoal or wood fire kept steadily burning and slowly increasing in temperature for several days, every precaution being taken to prevent the escaping moisture from loosening the masonry.

When heat is perceptible on the outside of the walls of the furnace the drying is completed. The fire is allowed to burn out and the furnace left to cool. This done, the crucible is immediately lined either with steep in every part or with tamping in

some parts only, viz, the dam, siphon, and siphon-tap. Steep or brasquo is a mixture of one part fire-clay and one part coke-dust, but more generally two parts fire-clay and one part coke-dust. Tamping is a simple lining of fire-clay. It is only used for certain parts of crucibles entirely lined with fire-bricks.

**Blowing-in or starting of the furnace.**—The furnace, being ready for work, is filled up from the hearth to the throat with charcoal, which is set on fire at the hearth zone. The tuyere-holes of the water-jackets are left open, as well as the tympan-stone and the damper of the stack, in order to create a draft. The charcoal gradually becomes incandescent to the very throat, and when this zone has attained a low red heat the blowing-in begins. The tuyere-holes of the water-jackets, with the exception of from two to four of the holes nearest to the front, and in which the respective tuyeres are inserted (the number of tuyeres set in depending on the capacity of the furnace), are sealed with plugs of fire-clay and the wind-bags of the corresponding tuyeres are tied up with strings. The tympan-stone is set in and the blast is then turned on at full pressure. A long flame issues from the siphon-tap, and this is kept on steadily until the lead-pot becomes red hot. The clay stoppers of the tuyere-holes in the water-jackets are then removed and all the tuyeres let in. The blast at this point is regulated to the normal pressure, and the furnace is ready for the filling of the crucible.

**Filling of the crucible.**—Bars of bullion always kept in reserve for this purpose, and in amount from four to twelve tons, according to the capacity of the crucible, are thrown in at the feed-holes with more fuel. This is done gradually in the proportion of three bars of bullion, or 300 pounds, to eight shovels of charcoal, or about 14 per cent. of fuel. According to the capacity of the furnaces, from one hundred to two hundred and fifty bushels of charcoal are consumed in the preliminary operation constituting the blowing-in. When molten lead makes its appearance at the top of the siphon-tap a few pieces of live charcoal are placed upon it to prevent it from cooling, and the furnace is ready for charging.

**Charging of the furnace.**—Old slags are first of all thrown in the furnace, as a kind of test of the temperature of the furnace, which is not ready so long as the slags are not perfectly fluid. The head smelter or his assistant opens from time to time the tap-hole in the tympan-stone to ascertain their degree of fluidity, and the regular charging begins only when they run quite freely. This point being attained the charges are disposed inside of the furnace next to the walls, a depression being left in the center for the charging of the fuel. This mode of charging is the one generally adopted, but there are variations in the mode of mixing the materials forming the smelting charges. At some smelters fuel is first thrown in, then old slags, over the slags the fluxes, and above the fluxes the ore. At others fuel is mixed with old slags and fluxes are mixed with the ore. Lastly, and this is the mode of proceeding mostly adopted, the slags, fluxes, and ore are mixed together and the fuel is kept separate. At the most successful smelters the mixing of fuel and old slags, on the one hand, and of the fluxes and ore, on the other, is prevalent. Whatever mode of mixing the materials of the smelting charges is used, the manner in which they are distributed in the furnace is the same; that is, fuel is always thrown in the center of the furnace and the charge distributed on the sides next to the walls. This seems scarcely a good plan, as it favors the growth of accretions in the lower part of the shaft of the furnace immediately above the water-jackets, in the very place where their removal offers the greatest difficulties. It would seem that, if in each alternate charge the process was reversed and the fuel alternately

distributed in the center and on the sides of the furnace, the lower part of the shaft would reach a higher temperature and prevent the formation of these accretions, which constitute the only real difficulty with which the smelters have to contend. The analyses which have been made of these products (see Section IV) show that they are formed of sublimated substances volatilized in the zones of higher temperature and deposited in the first cool zones which they encounter as they ascend in the form of vapor. Should the modification in the mode of charging which has been proposed prove practical, accretions would still be formed, but in the higher zones of the shaft, from which they could be detached oftener and with much more facility. In any case, they would interfere much less with the working of the furnace, which depends a great deal on the regularity with which the charges descend the shaft, and the dreaded hanging (i. e., the fall of the fuel to the tuyere-holes and suspension of the charge on the sides) would be in great part avoided.

**Barring-out or barring-down of the furnace.**—As it is, once per shift or once in 24 hours, as the case may be, or even once in two or three days, the furnace is barred out or down, i. e., the accretions are forcibly detached from the walls of the shaft by means of bars and sledges. The charges are allowed to descend to the level of the accretions, the blast is turned off, and long chisel-pointed bars a little shorter than the height of the shaft are introduced from the feed-holes between the accretions and the walls by means of the sledge, and the accretions thus removed are left in the charge, by which they are fluxed down. When this operation is over the blast is turned on again, the charging of the furnace continues, and smelting is resumed. (The chisel-pointed bars used in barring down the furnace are represented in Fig. 7, Plate XLIV.)

**Smelting of flue and chamber dusts.**—Flue and chamber dusts are mixed in general with lime, and the mixture, either molded into bricks or not, is spread over the ore-beds, so that a little flue-dust enters into the composition of the smelting charges. This is evidently the best way of disposing of this rather troublesome product, and in the discussion of chamber-dust it will be shown that the admixture of lime is the best plan that can be devised for its treatment.

**Running with dark top.**—In Leadville, furnaces are always made to run with a dark top, and this is one of the best indications that the furnace is running properly. By this is meant that the zone of the throat is perfectly dark; that no flame issues from it; that the top part of the charge shows no signs of incandescence; and that all that is seen is a thick, black smoke ascending the chimney.

**Tapping of slag.**—As soon as the furnace begins to work with regularity it becomes necessary to draw out periodically the molten slag from the furnace. This is done on an average every fifteen or twenty minutes. To effect this, slag-pots, mounted on wheels and made entirely of cast iron (see Plates XXIII and XXXVII for the two styles of slag-pots used in Leadville), are brought close to the fore-hearth of the furnace and placed under the slag-gutter. A tap-hole is perforated at the middle of the base of the tympan-stone by means of a pointed steel bar about an inch thick, which is forced into the clay by gentle strokes of a light hammer. This operation is generally performed by the head smelter's assistant. The slag runs over the steep or clay with which the fore-hearth is covered, then along the slag-gutter, and thence into the slag-pot. As soon as the slag-pot fills, the head-smelter dexterously plugs the tap-hole with a small lump of soft tapping-clay stuck to the end of the peculiar iron rod shown in Fig. 6, Plate XLIV, and called the tapping-rod. During this operation showers of



red-hot slag-sparks fly in every direction around the tap-hole. The tapping-pots or slag-pots are then wheeled away by the slag-wheelers to the slag-heap. The slag is either allowed to cool completely in the pot and the cake of slag thus formed is extracted bodily and broken up into fragments, or else the pot filled with molten slag is tipped over the edge of the slag-heap, where the slag runs down like lava.

**Taking specimens of slag for assay.**—Two or three times a day a specimen of slag is taken direct from the stream flowing from the furnace by means of a very small iron ladle provided with a long handle. The specimens thus obtained are forwarded to the assay office, where their specific gravity and their contents in lead and silver are determined. After every tapping some slag sticks to the fore-hearth and slag-gutter, from which it is easily detached by sprinkling a little cold water over it and knocking it off with an iron bar.

**Matte and speiss.**—In Leadville the little speiss and iron-and-lead matte formed during smelting are run into the slag-pots. At some works speiss, matte, and slag are thrown pell-mell over the slag-heap; at others the cakes of speiss or matte which have settled at the bottom of the slag-pot are knocked off the slag with the hammer. Speiss is kept in a separate heap, but no treatment has been found for it. The matte, separated from speiss and slag, is roasted in heaps and resmelted afterwards with the ore. In the study on mattes it will be seen that this roasting in heap appears to be a very bad operation.

**Ladling-out of melted bullion.**—From time to time bullion is ladled out of the lead-pot or siphon-tap by means of wrought-iron ladles, and poured into cast-iron molds placed in a row alongside the furnace on the lead-pot side. The molds bear in relief letters the name of the smelting firm, so that each bar of bullion is branded with it. When cold the bars are taken out on the slag-heap, or under a shed near the engine-rooms, and then weighed, marked, and two small pieces — one from top and one from bottom — are detached by means of hammer and chisel and carefully kept for assay. When a car-load has been thus weighed the assay bits, all mixed up together in a tin can or copper pan, are forwarded to the assay office.

**Watching the furnace.**—Every part of the furnace requires constant watching in order to apply at a moment's notice the proper remedy for any accident that may happen. The siphon-tap requires some attention and its siphon must be kept constantly clear; this is effected by the introduction, from time to time, of a curved iron bar about two inches thick, previously heated to redness at the curved end. This bar is represented in Fig. 8, Plate XLIV. The water-jackets form perhaps the least troublesome part of the furnace, and yet it is necessary to insure the running of the water into them at such a rate that the temperature of the water issuing from them should be as nearly as possible 50° to 60° C.

The pressure at the induction-pipe manometer must be constantly watched and the pressure kept steady or modified according to momentary requirements.

The tuyeres must be kept perfectly clear from any chilled slag by the introduction of iron bars into the sliding valve, and the temperature and condition of the zone of fusion observed through the tuyeres. When black rings round the tuyeres indicate a beginning of chilling, a little more fuel is added, or the charge is somewhat diminished, the fuel remaining the same. If the temperature proves too high, fuel is diminished or the charge is slightly increased. If semi-fluid slags or raw ore form hearth accretions which do not disappear by an increase of the temperature, the blast must be shut off,

the tym-p-stone removed, and the hearth cleared from accretions by means of bars and sledges; a little fuel is then thrown in the hearth, the tym-p-stone replaced, the blast turned on, and smelting resumed.

**Blowing out of the furnace.**—When a furnace needs repairing or when an accident interfering with a regular working of the furnace has occurred, the feeding is entirely suspended, but the blast is kept on until the contents of the furnace are entirely molten. The charge soon burns with a bright top and the furnace emits torrents of heavy white fumes. When the whole charge has reached the level of the tuyeres the furnace is emptied of its fluid contents, first at the tap-hole, then the breast is removed and the bullion taken out of the crucible.

**Length of runs.**—The length of runs or smelting campaigns is seldom less than three months, but often reaches six, eight, and even twelve and thirteen months. The lack of ore is one of the principal causes that shorten the smelting campaigns.

#### COST AND PROFITS OF SMELTING.

The discussion of profit and loss in smelting will be made for a smelter which stands in intermediate conditions between the smelters which produce most and those which produce least. This smelter works with two furnaces of a capacity of 35 to 40 tons each of ore per twenty-four hours. The discussion is based on data obtained at this smelter for the month of July, 1880, and which are to be found with the composition of smelting charges, the other data being all derived from Table IV. The cost of smelting per ton of ore, as estimated at each smelter, has been given also in the same table. The calculations are made on cost and profit per twenty-four hours and per ton of ore.

#### EXPENSES PER TWENTY-FOUR HOURS.

##### *Power.*

Cost of mechanical power per 24 hours, represented by  $3\frac{1}{2}$  cords of pine wood burned under the boilers and driving engines, blowers, pumps, &c., at \$4.75 per cord..... \$15 44

##### *Labor.*

Cost of manual labor per 24 hours:

2 foremen, at \$4 and \$6 .....	\$10 00
8 head smelters, at \$4 .....	32 00
26 helpers, at \$3 .....	78 00
65 laborers, at \$2.50 .....	162 50

232 50

Aggregate salary of staff per 24 hours..... 46 50

##### *Ore.*

Forty-eight tons ore smelted in 24 hours, contents 34 per cent. of lead, 41.5 ounces of silver to the ton, equivalent to 1,992 ounces, at \$1.15 per ounce (New York quotations June 21, 1880).....	2,290 80
32,640 pounds of lead, equal to 1,632 units, at 15 cents per unit of 20 pounds.....	244 80

2,535 60

Deducting 5 per cent. off price of silver .....

\$114 54

Deducting cost of treatment at \$20 per ton.....

960 00

1,074 54

1,461 06

*Flux.*

Price paid for fluxes used in 24 hours:	
17 tons of dolomite, at \$3.50 per ton.....	\$59 50
2½ tons of hematite, at \$9.50 .....	26 12
	\$85 62

*Fuel.*

Price paid for fuel used in 24 hours:	
9½ tons of charcoal, at \$18.57 per ton.....	171 77
7 tons of coke, at \$37.50 per ton.....	262 50
	434 27
General expenses .....	2,325 39
Wear and tear and repairs of implements, say 5 per cent. of general expenses.....	116 27
	2,441 66

## PROFITS PER TWENTY-FOUR HOURS.

Bullion obtained in 24 hours: 14 tons, assaying 136 ounces of silver to the ton, equivalent to 28,000 pounds, containing 1,904 ounces of silver, or 130.56 pounds (avoirdupois) of silver (New York quotations July 31, 1890):	
27,869.44 pounds of lead, at 4½ cents per pound.....	1,254 12
1,904 ounces of silver, at \$1.14½ per ounce.....	2,175 32
	3,429 44
Deducting refiner's charges, at \$14.50 per ton of bullion .....	203 00
Deducting total expenses .....	2,441 66
	2,644 66
Net profits per 24 hours.....	784 78
Total expenses per ton of ore.....	50 86
Cost of smelting per ton of ore .....	20 41
Profits per ton of ore .....	16 35

From the profits must be deducted a certain amount for the sinking fund of capital invested in plant and a certain amount for the interest on the working capital.

## PLANT AND OPERATIONS OF INDIVIDUAL SMELTERS.

## SMELTER A.

Disposition of works (see Plate XXV).—These works are erected on the northern bank of California gulch. Being one of the first smelters started in Leadville, its plant is somewhat antiquated, but, such as it is, it has rendered good service. The two furnaces *A A'* are the largest circular furnaces in the camp and are very clumsy. Their clumsiness is made more evident still when one hears that in spite of their large dimensions their smelting capacity is only equal to that of the smaller furnaces at present in use at the other smelters and when it is found, as has been pointed out in the composition of smelting charges, that they consume twice as much fuel as the smaller ones. On the furnace level there is a battery of three stamps. The weight of each stamp and stem is 400 pounds. These stamps are used chiefly for crushing the coke with which the steep of the furnaces is made. The furnace level communicates with the feeding-floor by means of a flight of steps, and also by means of an elevator, chiefly

used to carry up barrowfuls of old slag used as flux in smelting. The boiler, engine, and blast room is next to the furnace-room, on the right facing the furnaces. The boilers are worked at a pressure of 60 pounds per square inch. The engine is of 40 horse-power and the blast apparatus consists of two No. 5 Baker blowers.

The offices, assay offices, and laboratory occupy detached buildings on a level with the foot of the slag-heap. On the feeding-floor is a large wooden trough in which the roasted flue-dust (at this smelter flue-dust is roasted before resmelting) is mixed with about 20 per cent. of milk of lime. The mixture is then spread over the ore-beds placed on this floor. The crushing machinery, placed also on this floor, consists of two large No. 5 Blake crushers (opening between the jaws, 15 by 9 inches).

Immediately outside of the main building, on the feeding-floor level, are the flues connecting the stack of the furnaces with the dust-chamber; this arrangement is the only one of its kind in Leadville. The upper part of the stacks *E, E'*, (Plate XXV) of the furnaces *A, A'*, are connected by means of the sheet-iron flues *H, H'*, with a main sheet-iron flue, *F'*, which enters the brick-dust chambers *D'*. Each of the flues *H H'* is provided with one, and flue *F'* with three, sliding doors, placed on the upper part of the flues and parallel with them (these doors are not visible in the sketch), and used for clearing the dust which accumulates periodically in the flues. The flue *F'* rests about half way on a small flue-dust chamber, *N*, made of bricks and provided with a sliding door, *d*, for the extraction of the flue-dust. Immediately at the rear of the dust-chamber *D'* are long rows of ore-bins, and immediately behind them is a large roasting-furnace. The level immediately above and at rear of the roasting-furnace is the fuel level, which communicates with the blast-furnaces by means of an elevated platform, *R'*, provided with a track of rails. The fuel, charged in light sheet-iron mining barrows, is thrown down next to the feed-holes along the chutes, *S*. This arrangement is capital and saves much labor; two fuel men are sufficient to supply all the fuel needed in smelting, but its great inconvenience is that of filling the whole feeding-floor with an ever-floating cloud of impalpable charcoal dust, very disagreeable to breathe and which must prove after a while most injurious to the lungs of those who live constantly in such an atmosphere. When in full blast these works employ 66 workmen per twenty-four hours.

**Furnaces.**—The two blast-furnaces at Smelter A are circular and identical in shape, dimensions, and capacity. Both furnaces are seen in perspective, Plate XXV, and one of them is drawn to scale in Plate XXIII. They are constructed on exactly the same general principles as all the other furnaces in the camp, but in detail differ a good deal.

The crucible *A* is very little larger than the water-jackets; it is framed in strong cast-iron plates, *a*, forming segments of a circle, six in number and firmly bolted together at the joints. The frame of the fore-hearth *X* is also made of cast-iron plates, and the projection *X''* of the fore-hearth, which exists only in this furnace, is similarly framed. The crucible, siphon-tap, fore-hearth, and fore-hearth projection are entirely lined with steep, made of one part fire-clay and one part finely pulverized coke. The projection of the fore-hearth is provided with two slag-spouts, *U*. The frame of the lead-pot is made of strong sheet-iron, *a'*, bolted to the cast-iron plates of the crucible. The system of water-jackets consists of six jackets of equal dimensions; four of these are made of strongly riveted, wrought-iron boiler-plates and two are made

of cast iron. This principle is a bad one, owing to the unequal expansion and contraction of the two metals, and should be avoided; whenever this plan is adopted the water-jacket system frequently gets out of order. Each jacket is provided with a feeder, *R*, in which exists an outlet for the hot water, and a hole, *n*, for the introduction of the nozzle of a tuyere. Fig. 2 shows the disposition of the six tuyeres and of the jackets; the space between the water-jackets and the masonry above is filled as usual by fire-bricks, *b*. The pillars *P* have their capitals flange-shaped at *O''*. This flange rests on the pillars by means of brackets *t*. The main cast-iron plate-support *O* is also flanged at *o* (Fig. 4), and these flanges are connected with the circular and vertical flange *O'* of the plate by means of the brackets *r*. The masonry and stack are entirely surrounded by a wrought-iron casing or jacket, *J'*, surrounded at the base by the flange *O'*.

There is only one feed-hole, *H*, at the throat, but this feed-hole is twice as high as it is in most furnaces, and is divided into two sections by two hinged wrought-iron doors, *S' S''*. The upper door is only opened to bar out the furnace. The damper *G* of the stack is not single, as in all the other furnaces, but is made of two halves, *G G'*. The walls *C'* of this furnace are much thicker than the walls of most circular blast-furnaces.

The induction-pipe *I* is made, as usual, of galvanized sheet-iron. It has a peculiar shape; it forms a ring around the furnace, and this ring is square in vertical section, but the branch pipes *J* are cylindrical, as is always the case. Each furnace smelts from 17 to 20 tons in twenty-four hours; produces from 4 to 5 tons of bullion and from 13 to 25 tons of slag.<sup>1</sup> The length of run of these furnaces is about six months; they are barred out every twelve hours, at the beginning of each shift. The chief defect is that the diameter of the water-jackets at the tuyeres is rather too large. Contrary to the plan adopted at all the other smelters, periodical tapping of slag is not done here. The slag is allowed to flow in a constant stream, and the gutter in the steep of the fore-hearth and its projection are covered with live charcoal to prevent the chilling of the slag. The slag-pots used at these works are indicated by *B B'*; they are independent of the car *D'*, by means of which they are wheeled to the slag-heap.

The quantity of speiss resulting from the smelting of 10,241 tons of ore during the year ending June, 1880, was about 20 tons, assaying 49 ounces of silver to the ton and containing 980 ounces of silver; consequently the quantity of speiss formed amounts to about 0.2 of 1 per cent. of the ore.

Condensing chamber. — In Plate XXV the general disposition of the dust-chamber and its connection with the furnaces are seen in perspective. In Fig. 3, Plate XXIV, the same chamber is seen in horizontal section, divided into three parts by means of partition walls, *W'*, the arrows indicating the circulation of the fumes. Fig. 2, Plate XXIV, is a vertical section of the same chamber. Both sections are drawn to scale, and a glance at them is all that is necessary to understand its construction and its working. About 150 tons of dust were collected in this chamber in the space of six months.

Roasting-furnace. — This furnace is represented in elevation (Fig. 1, Plate XXIV), chiefly with a view of giving its dimensions, for it presents no peculiarity in construction. Its width (not indicated in the sketch) is 12 feet. The sketch shows the system of bracing by rails, the hinged cast-iron doors *d*, and the dotted lines indicate the in-

<sup>1</sup> The municipality of Leadville uses most of this slag to macadamize the roads.

ternal disposition of the furnace. This roasting-furnace is used at Smelter A for roasting the chamber-dust previous to resmelting. In the study of metallurgical products it will be seen that it is an expensive and useless operation, and that it were better, on the contrary, to use it for the roasting of mattes and speiss. The former, being roasted in heaps, lose a great deal of their silver, and the latter is not treated in Leadville. The only point of interest in the roasting-furnace of Smelter A is the flue *C*, in which a good deal of the products volatilized during the roasting is condensed; so that this furnace is admirably adapted for the treatment of matte, accretions, and speiss, all products containing a good deal of silver. *S* represents the stack of the furnace; *G*, the damper of the stack. The ash-pit of the furnace is not visible, but is placed at *h*.

#### SMELTER B.

Disposition of works.—These works, the largest and most important in or near Leadville, are situated in Leadville proper, on the northern bank of California gulch and facing the gulch. With their 118 men at work in a somewhat limited space they present an unusual amount of bustle and activity and smelt about one hundred tons of ore in 12 hours.

The old slag-beap, placed immediately in front of the furnaces, is being entirely dug up, in order to be resmelted. These slags were made formerly of singulo-silicates, but now the slags contain a little more silica, and are called acid slags. The old slag-beap is placed in direct communication with the feeding-floor by means of an inclined tramway supported by timber trestle-work, on which a mine-wagon is run by a wire rope which winds over a drum placed on the feeding-floor. The new slags made at these works are allowed to solidify in the pots; they are detached while hot, lifted by means of a small crane, placed on a small iron truck running on a tramway resting partly on the ground in front of the works, partly on a timber bridge projecting over the gulch, and being taken to the end of the bridge are dumped into the gulch. The main smelting building at smelter B is 212 feet by 94 feet. The ore-bins are placed on the feeding-floor within this building, where are also placed the ore-beds, crushers, Cornish rolls, etc. The coke-room, at the back of the main building, is 200 feet by 20 feet and the charcoal bins are 150 by 18 feet. Large heaps of dolomite, hematite, and large dumps of low-grade ore fill up the open space at the rear of the works. Large Fairbanks scales, of a capacity of 20 tons, occupy a detached office at the entrance of the works. The offices, assay offices, and laboratory occupy a detached building. In the well-fitted laboratory, besides the current assays made, the specific gravity of slags is determined from day to day. The slags are considered fit to be thrown away when their specific gravity is 3.6.

Nine Baker blowers, standing in a row under the feeding-floor and at the back of the furnaces, supply the blast. These, as well as three Blake crushers, three sets of Cornish rolls, one small pulverizer, the slag-hoisting machine, and the pumps supplying the tanks from which the water-jackets are fed, are worked by two engines, 14 by 24 inches, of 60 horse-power each. Each engine is connected with two boilers, 44 inches by 14 feet, worked at a pressure of 70 pounds to the square inch. Both engines and boilers were manufactured by Messrs. Fraser & Chalmers. The engine and boiler rooms stand on the left of the works (facing the furnaces), next to the furnaces and on a level with them.

**Furnaces.**—The smelting plant consists of three large square furnaces, made of brick. With the exception of the water-jackets they are exactly similar in shape, dimensions, and capacity. They are represented in elevation and in section on Plate XXVI. There are besides six circular furnaces, manufactured by Messrs. Fraser & Chalmers, of Chicago. These furnaces are represented in elevation and section on Plate XXVII.

A full description of both the square and the round furnaces at this smelter has already been given at the commencement of this section, to which the reader is referred for further details concerning their construction. The capacity of the square furnaces is 35 to 40 tons of ore per 24 hours, and that of the circular ones 20 to 22 of ore in the same time. The heat radiated in front of these nine furnaces, closely packed in a narrow space, is so great that the men are obliged to constantly water the ground in front of them. The crucibles of both square and round furnaces are made of steep, the mixture preferred at these works being two parts of fire-clay and one part of coke-dust. The length of runs is various and averages three months.

**Condensing chambers.**—The condensation of lead fumes at this smelter is of the poorest description. Four furnaces are totally without any condensing apparatus; three furnaces are connected with an oblong sheet-iron box, 50 feet long, 6 feet high, and 6 feet wide, placed on the feeding-floor; and one furnace communicates with a small chamber, 9-foot cube, placed on the same floor. Each chamber is provided with a stack made of sheet-iron. With such inadequate arrangements the works are perpetually enveloped in a thick atmosphere of smoke and lead fumes, and "leading" is of frequent occurrence.

**Bartlett filter.**—During the collection of notes for this report, a most interesting and valuable experiment was being made at these works with a view to the total condensation of lead fumes. This experiment was carried on at great expense with the elaborate apparatus known as the Bartlett smoke-catcher or filter. It was so successful and the results derived from it are so interesting that the whole deserves a full description. The arrangement adopted is shown in Fig. 1, Plate XXVIII. The stack *E* of one of the square furnaces *A* was connected by means of the sheet-iron flue *F* with a Sturtevant fan, *B*, drawing the fumes from the furnace and blowing them through the sheet-iron pipe *P*, about one hundred and fifty feet long, where they parted with their dust, as in an ordinary flue. The pipe *P* is connected by means of two sheet-iron branch pipes, *P'*, with two thin sheet-iron boxes, *aa'*. Each branch pipe *P'* is provided with a damper or valve, exactly similar to those used in common stove-pipes for the regulation of draft, so that the fumes can be distributed evenly in the boxes or shut off from one and allowed to enter only the other. Each box is formed of two parts, the dust-chamber *aa'* and the fireplace *N*. The dust-chamber is provided with sliding doors *O*, placed at each extremity, and the fireplace with doors *d*, placed in front, and sheet-iron pipes *L* at the back which communicate with a stack, *L'*. The chambers *aa'* are provided at the top with 28 apertures, to each of which is fastened a cloth bag, *b*, 30 feet high, suspended to the beams of the light wooden structure in which the apparatus is inclosed. This building *M* is provided with very large openings for ventilation. When the apparatus is at work the fumes, blown in through pipes *P P'*, distribute themselves in the dust-chambers *aa'* and ascend the cloth bags, through which they filter. The gases come out perfectly colorless and are entirely deprived of any lead dust or even soot. The wind, entering freely through the aper-

tures provided in the light building, shakes the bags, and the dust with which they are charged falls into the dust-chambers. When a sufficient quantity of this dust has accumulated there, the doors *O* are opened and a light wood fire is placed through doors *d* in the fireplace *N*. The soot of the dust soon catches fire, and the dust, which was quite black, like lampblack, becomes white; it becomes also denser by this operation and is more easily manipulated. When the smoke has thus been calcined it is shoveled out through doors *O*.

During a run of five days 3,030 pounds of this calcined dust was caught in the Bartlett filter from one furnace, but the experiment was not altogether satisfactory for the reason that the furnace was worked with an open feed-hole, as with an ordinary dust-chamber, and that the Sturtevant fan was drawing as much air as smoke, so that the damper *G* of the furnace had to be left half open and about half the smoke was lost. In the conditions in which the experiment was made this could not be avoided, but this is only an experimental defect, impairing in no way the value of the filter, which does its work to perfection; the writer estimates at 7,000 pounds the quantity of dust which would have been caught in five days had the experiment been made with closed feed-hole and damper, or say at 1,500 pounds per twenty-four hours. The calcined dust has been assayed by Dr. M. W. Iles, and found to contain 70 per cent. of lead and 6 ounces of silver to the ton; so that with a furnace of 35 to 40 tons of ore capacity per twenty-four hours one-half a ton of lead is lost in the air, as well as 4.5 ounces of silver, in twenty-four hours. The result of this is that the quantity of lead lost in the air is greater than the quantity of dust condensed in the dust-chambers. At smelter A, where the dust-chamber arrangement is of the best kind, 150 tons of dust were collected in 182 days, giving 1,648 pounds of dust per twenty-four hours for two furnaces whose joint smelting capacity in tons of ore is equal to that of the furnace connected with the Bartlett filter. This dust, assaying 35 per cent of lead, represents 577 pounds of lead, or a little over a quarter of a ton. These are indeed important results and are worth considering.

At smelter B, as at most smelters, chamber-dust is mixed with milk of lime; the mixture is spread over ore-beds and resmelted in this way. The composition of the dust caught in the Bartlett filter is extremely remarkable. It has been analyzed, such as it is previous to calcining, and the results will be found in the study of lead fumes, Analysis XXXVI.

#### SMELTER C.

Disposition of works.—These works, like all the other smelters situated in California gulch, are erected on the southern slope of the northern bank of the gulch, the gentle slope of this hill favoring singularly the construction of similar establishments. A glance at the vertical section through these works (Fig. 2, Plate XXXI) will show their general disposition. A deep cutting, *u y z*, in the bank is the only one needed for the erection of the furnaces *B* and dust-chamber *D'*. In front of the furnaces and extending some little distance is the slag-heap *X* upon which are seen piles of bullion in bars, *A*, ready for shipment. At the foot of the slag-heaps runs the lower road of California gulch. The furnace *B* is connected by means of the sheet-iron flue *f* with the dust-chamber *D'*. The water-jackets of the furnace are supplied with water from the main water-pipe *m*, connected with the tank *D*, placed on the feeding-floor *Y Z*, and constantly filled with water by means of pumps worked by machinery. The sheet-iron



stack *F*, communicating by a flue, *D''*, with the dust-chamber *D'*, carries off the smoke. On the feeding-floor, and in close proximity with the feed-holes of the furnaces, are disposed the fuel and old slag used as flux, as well as the mixtures of ore, dolomite, and hematite entering into the composition of smelting charges. On the portion *Z Y'* of the feeding floor are seen the crusher *G* and the ore-beds *H*, on the top of which are placed bricks of flue-dust and lime, specially molded in this form previous to resmelting with the ore. To the right and left of the ore-beds are rows of ore-bins, supplied from the wagon-road, *R*. The scales, *E*, placed on the feeding-floor, are used for weighing the different elements of the smelting charges, special ores and fluxes, which are classified and distributed right and left on each side of these scales. The portion of the works placed between *Y* and *Y'* is inclosed in a light timber construction, *V*, protecting the workman, the plant, and the works against rain, wind, and cold.<sup>1</sup>

*I* represents a second row of ore-bins supplied from the wagon-road *S*. These bins are made of light timber; they are opened in *d* for the removal of the ore, which is wheeled to the crushers in the wooden ore-barrows *P*. The bins are supplied from the ore-wagons *M* through the aperture *d'*, which can be closed by hinged wooden doors. *J* is the third row of ore-bins, exactly similar to the preceding. On road *T* is laid a railroad track, a siding of the Denver and Rio Grande Railway. *N*, represents a car. In *K* is a fourth row of ore-bins, similar to those previously described, and at *U* a wagon-road placed in direct communication with the upper level district road. At the extreme wings of the row of bins *K* are to be seen huge fuel-bins for both coke and charcoal. *L* represents a heap of charcoal placed on the upper level of the works; on this level are also ore-dumps and heaps of dolomite and hematite. Inclined ways run through the rows of ore-bins, connecting the different levels, which allow the wheeling down of ores, fluxes, and fuel. The charcoal-barrows, made of thin sheet iron, are represented in *O*; these barrows, in general use in the camp, hold about eight bushels of charcoal. The feeding-floor is connected with the furnace floor by means of a flight of steps placed outside the main building, and also by zig-zag inclined ways for the wheeling up of old slag to be resmelted.

Standing on the slag-heap and facing the furnace, but not shown in the sketch, are, on the left, the scales upon which the bars of bullion are weighed, and on the right, the boiler, engine, and blast-apparatus rooms. Farther on the right stands the shed in which flue-dust is mixed with lime, molded into bricks, and desiccated on driers artificially heated.

The offices, staff apartments, assay offices, and laboratory occupy a detached building situated a short distance from the works and on a level with the lower road of California gulch. A small office, provided with large Fairbanks scales, is placed at the entrance of the works at one of the upper branch roads. The assay offices and laboratory are well fitted up. The muffle furnace and crucible furnace are separate. In the assay of ores and slag for lead, iron rods are always inserted in the crucible. Experiments on the fusibility of mixtures of ores and fluxes are also made. The assays for silica are always evaporated in order to obtain the percentage both of gangue and of soluble silica.

<sup>1</sup> This building is not correctly represented in the drawing, the ridge-pole and ventilator being at the top of the furnace *B*, instead of at the stack *F*, as there shown. (S. F. E.)

**Furnaces.**—Smelter C has three furnaces of equal dimensions and capacities, constructed on the plan of Messrs. Keyes & Arent's patent. At the time this report was made, however, only two furnaces were running, and all that has been said or will be said of this smelter refers to the work done by the two furnaces.

They may be considered the model furnaces of Leadville, both as regards appearance and working qualities, and will therefore be described in considerable detail. One of them is represented on Plate XXIX, in elevation (Fig. 1), transverse and longitudinal sections (Figs. 2 and 3). The crucible *A* of this furnace differs essentially from nearly all the others used in Leadville in that the lead-well *L* does not project outside of the crucible frame, but, together with the crucible, is confined within the frame formed by the hearth-plates. A glance at this furnace and at any of the others, with exception of the furnace shown in Plate XXXII, will show the difference. Another peculiarity is that lead is not ladled out of the lead-well, as at other smelters, but a tap hole, *z'*, is made in its clay lining, and the bullion is drawn periodically into the cast-iron lead pot *T'*, mounted on a small cast-iron stove, in which a slow fire is placed in order to keep the bullion molten. The chimney *f* of this stove communicates under ground with the dust-chamber. The advantage of this disposition is twofold: the lead-well may remain constantly covered and its bullion be kept at a high temperature, thus assisting the clearing of the siphon when this is necessary. On the other hand, the bullion accumulating in the lead-pot, being kept molten, can be ladled rapidly into the molds, and the bars thus obtained are of a good shape and uniform composition. The entire hearth rests on a bed-plate of boiler-iron, with an angle-iron rim, which incloses the base of the hearth-walls or lining of the crucible. These walls *X* are entirely of fire-brick, but the dam of the crucible *A''* is protected by tamping or pressed fire-clay, as are the siphon *I'* and the lead-well *L*. The bottom of the crucible is formed by an inverted fire-brick arch, with quartz-brasque beneath, separating it from the bed-plate.

The hearth is inclosed on the sides by four cast-iron plates, *a*, each 1 inch thick, of which the front and back ones have each 2 inch flanges lapping over the ends of the side plates. These plates are firmly held together or inclosed by three rows of bars or rails, *Q'*, which are fastened at each corner by wrought-iron rings *p*. The top of the hearth is also covered by iron plates, *d*. To the front hearth-plate is screwed and bolted the slag gutter or spout *U*, and to the side plate the lead-gutter, *U'*, leading from the lead-tap *z*.

These are the only furnaces in which the fore-hearth does not project outside of the frame of the hearth. The crucible, though constructed on the same general principles as those of other furnaces in Leadville, differs essentially in the arrangement of details.

The water-jackets are thirteen in number, one in front, two at the back, and five on each side. They are screwed together and wedged at *q*, and braced by tie-rods; the tie-rods under the hot-water outlets *S* are not indicated on the drawing. The front water-jacket does not extend down to the hearth-plate, but rests on a fire-brick wall, in the middle of which is a small water-cooled cinder-block inclosing the slag-hole (see Fig. 2), instead of the ordinary tump-stone shown in Fig. 1, Plate XXXIII.

The water jackets are otherwise similar in construction and appearance to those already described. Cold water is brought by the pipe *M*, and passes through short

inlet pipes into the water-feeder *R* of each jacket. The heated water passes out through the outlet pipes *S* into the gutter *T* (wrongly indicated as *T'* in Figs. 3 and 5). The tuyere-holes *n* are placed at the junction of the water-jackets.

The shaft of the furnace from the water-jackets up to near the top of the feed-holes is lined with fire-brick. The rest of the masonry walls *O'* are made of common brick and rest on a cast-iron carrier plate, *O*, which in turn rests freely upon iron girders *G'*, three on each side of the furnace, which are firmly screwed and bolted to the capitals of the hollow cast-iron supporting pillars *P*. The plate *O* is in no way fastened to the girders, so that its expansion and contraction are absolutely free. The obvious advantage of this arrangement is to render the masonry absolutely independent of the pillars, so that both keep their relative position unaltered by any lateral motion of the main support. When the main cast-iron support is fixed to the pillars, as is the case in most furnaces, the pillars are not unfrequently cracked by the irresistible dilation of the main support. Upon the cast-iron plate *O*, an outer wall, *N'*, extending up to the charging-floor, is built of common bricks. It is strongly braced by five rows of rails, *Q*, inclosing flat vertical irons *e* and corner irons *c*. It is said that by the use of the outer wall, which naturally protects the hotter parts of the furnace against external radiation, a saving of 15 per cent. of fuel is effected; so that it must be considered as an important part of the furnace. Each side wall of the furnace is provided with two feed-holes, *H*; but, while in most furnaces these holes are placed in the middle of the wall and are directly opposite each other, here they are placed to the left of the middle on either side and thus are not directly opposite. This arrangement is necessitated by the large dimensions of the furnaces and enables the feeders to distribute properly the charge without effort. The feed-holes are provided, as usual, with sliding sheet-iron doors, *S'*, and have cast-iron door-frames. The chimney *D* is braced at *Q*, and provided with corner irons *c*. It is connected with the dust-chambers by means of the large sheet-iron flue *F'*, which fits into a circular brick ring in the furnace wall, where it is held in place by angle-iron rings. The damper *G* has riveted to it on its lower face an angle iron rim, which rests in grooves filled with sand in the top of the furnace wall, thus providing against any escape of fumes when it is closed.

The arrangement for ventilating or carrying off the smoke of the tap-holes and slags differs in these works from that ordinarily adopted. Instead of the hood *W* and chimney *W'* in front of each furnace (as has been by mistake indicated in the elevation, Fig. 2, Plate XXXI), the whole front part of the building in which the furnaces stand is made one big chimney by a partition wall, extending the length of the building, running up from the charging-floor on the line of the front of the furnace, and slanting a little backwards, so as to reach the middle of the ventilator at the ridge of the roof and where the top of the furnace projects above it. Excellent ventilation is accomplished by this simple method.

**Barring-down.**—The barring-down of these furnaces is effected in the following manner: To the upper end of the long, chisel-pointed bar (Fig. 7, Plate XLIV) is fastened a long and strong rope; the bar is then introduced through one of the feed-holes into the furnace, and the chisel point is forced by blows of a sledge-hammer between wall and accretions. The rope is then thrown across the furnace to the other feed-hole, and five or six men pull at the rope; voluminous masses of accretions are often detached in this manner and are left in the furnace, where they are subsequently

fluxed down without serious stoppings and blowings-out. Even the dreaded sows float on the lead bath, remaining constantly at the same level, exposed to the oxidizing influence of the blast and to the sulphurizing influence of mattes and unreduced sulphurets; they thus rather assist than hinder the completion and perfection of smelting, and very soon disappear, being fluxed down in this way.

**Sampling of bullion.**—The chisel used to detach pieces of bullion from each bar at smelter C is represented in Fig. 14, Plate XLIV. It is a hollow conical chisel or punch, provided with two apertures, *a* and *b*. Samples of lead or assay bits (Fig. 15, Plate XLIV) are obtained from the top and bottom of each bar by hammering the chisel perpendicularly to the bar. The punch being driven by the hammer into the surface of the bar, the cylinder of lead is forced in at *b* and out through *a*, being detached by striking the butt-end of the punch.

**Slags.**—A uniform treatment of slags has been adopted at smelter C, which presents two advantages. The slag is left in the pot until a solid crust about two inches thick is formed on the sides and surface of the mass. The upper crust is pierced by two holes, the slag-pot is reversed on the slope of the slag-heap and its molten contents poured out. The thin shells of slag thus obtained are broken up and kept for smelting. It will be seen in the assays of slag that the side shell is a little richer in silver than the portion of the slags poured out; but that the upper crust is poorer in silver than either the poured out portion or the side shell, so that this portion of the slag might be thrown away as useless.

**Bars of bullion.**—At smelter C the bars of bullion weigh about ninety-eight pounds. They have the shape and dimensions indicated in Figs. 3 and 4, Plate XLV.

**Length of run.**—The average length of run of the admirable furnaces above described is 12 months, and runs of even 13 months have been obtained. The remarkable length of these campaigns is due not only to the mechanical perfection of the apparatus, but also to the great care bestowed upon every detail of the smelting operations.

**Dust-chambers.**—The dust-chambers are built of small blocks of limestone (Leadville dolomite), cemented by a mortar of sand and lime. They were constructed at a time when limestone was less expensive than bricks. They form a parallelepipedic construction 75 feet long, 15 feet high, and 25 feet wide, with walls about one foot thick, and are placed immediately below the feeding-floor at the rear of the furnace. In Plate XXX are seen the vertical sections (Fig. 1) and the horizontal sections (Fig. 2) of these chambers. Figs. *b, c, d, e, f, g* represent elevations of the partition walls *W'*, showing the disposition of the apertures *a* through which the fumes circulate. At the time this report was made the chambers were connected with only two furnaces, although they are constructed to condense the fumes from three; this explains the unequal allowance of condensing space provided for each furnace. The first furnace is connected with a chamber divided into two sections, *A* and *B*, by a wall, *W'*, provided with an aperture, *a* (see also Fig. *g*); the fumes enter the chambers at *F'* and reach the sheet-iron stack through *C''*. The second furnace is connected by the flue *F''* with the chamber, divided into sections *C, D, E, G*. The fumes circulate alternately up and down and from right to left, until they reach the flue *C'*, which takes them to the stack *F*.

The whole arrangement is far from perfect, but the fumes are made to strike walls, and this seems to be one of the conditions essential to deprive them of their dust.

The lighter portions of the fumes are carried away into the air and fall back occasionally on the roof of the building, which is covered with an impalpable yellowish-white dust. In each section of the chambers is a door for the extraction of the dust, which is moistened with water before being wheeled away.

**Treatment of flue-dust.**—From four to five tons of flue-dust are collected weekly in the chambers just described. The dust is mixed with milk of lime and molded into bricks in the molds represented in Figs. 9 and 10, Plate XLIV, which are also used for common bricks. The bricks thus obtained are then dried under a shed and afterwards on driers; they are then laid on the ore-beds and resmelted.

One of these bricks was examined to determine the actual quantity of lime with which they are mixed. Their contents in lime and magnesia are: Lime, 6.9 per cent.; magnesia, 5.1 per cent., or 12 per cent. in all; but the original dust contained already 4 per cent. of a mixture of lime and magnesia, leaving 8 per cent. for the lime and magnesia thus introduced.

**Treatment of mattes and accretions.**—Mattes and accretions are placed in heaps in alternate layers with wood, and thus slowly roasted by slow combustion; but it will be seen in the study of mattes and accretions that this is a very imperfect mode of treatment, by which a great deal of silver is lost. Speiss is kept separate from other products at smelter C, but is not treated. It will be seen in the analytical study on speiss that this, as well as all the other speiss at the camp, contains a small quantity of molybdenum, which is entirely concentrated there.

**Steam-power.**—The boiler is worked at a pressure of 60 pounds to the square inch, and the engine is of 50 horse-power. The machinery driven by this engine consists of two No. 5½ Baker blowers, three Blake crushers, and the pumps feeding the water tanks.

The blast arrangement adopted at this smelter is the one chosen for the general description at the commencement of this section, to which the reader is referred. The normal pressure used is eight-eighths to nine-eighths inch of mercury. It will be seen in the discussion of the blast furnace that the weight of atmospheric air needed to work in the best conditions is about four-fifths the weight of the smelting charges; it will also be seen that the volume of blast in Leadville is much greater than at lower altitudes.

Smelter C, with two furnaces, smelts from 80 to 100 tons of ore per 24 hours.

#### SMELTER D.

Smelter D is a neat and compact little smelter situated on the northern bank of California gulch, and so like the similarly situated smelters just described, in its general arrangement, that its description will not be given in detail. The pressure of steam in the boilers is 65 pounds to the square inch; they supply a 40 horse-power engine, which drives two No. 5 Baker blowers, 1 Blake crusher, one set of Cornish rolls, and the pumps feeding the water-tank, which supplies the water-jackets of two furnaces. The diameter of the pipe supplying both is 2½ inches. The pressure of blast used at this smelter is the lowest in the camp and averages from four-eighths to six-eighths inch of mercury.

**Furnaces.**—The two furnaces used at this smelter, and which are equal in dimensions and capacity, are represented in elevation (Fig. 1) and in vertical section (Fig. 2,

Plate XXXII), and are connected with the dust-chamber represented in Fig. 4. A longitudinal or side elevation of the furnace, shown in front elevation in Fig. 1, is seen in Fig. 3. The hearth *A* is very similar to that of the furnaces at Smelter C, already described; it is lined with fire-brick, and the siphon-tap *L* is confined within the hearth-plates; but here the bullion is ladled out direct from the siphon-tap. The hearth-plates are braced by one row of braces, *Q'*. The hearth is also confined within the hearth-plates, as was the case at smelter C, and does not project out, as in other furnaces. The water-jackets *B* are made of riveted steel boiler-plates and are braced by tie-rods *Q*. There are only four jackets: one in front, one at back, and one large one on each side. The circulation of water in these jackets is similar to the one adopted with cast-iron jackets; the water is introduced by means of the pipe *M*, and the hot water comes out at the open outlets *R*, provided with outlet-pipes *S*. The back water-jacket is provided with two tuyere-holes, which are not used, and the side jackets with four holes, in each of which a tuyere is placed; so that each furnace is worked with eight tuyeres.

The pillars *P* do not rest on the ground, as is the case with all the furnaces thus far described, but on the lining of the crucible. Another peculiarity is that there are six of these pillars, instead of four as in most furnaces. The capitals are supported on the pillars by means of brackets *t*. The main cast-iron plate support is of unusual thickness, being four inches thick. The use of a plate of such unusual dimensions is necessitated by the fact that the masonry does not rest directly on the pillars, as in other furnaces.

The masonry consists of fire-bricks, as usual, but is entirely surrounded by a wrought iron jacket, *J'*. At the throat there are two feed-holes *H*, provided with sliding doors *S'*.

Dust-chamber.—The sheet iron stack of each furnace, which is a prolongation of the jacket, is connected by means of the flues *F' F''* with the sheet-iron dust-chamber, formed of a cylindrical portion *D'* and a conical portion *D''*. The fumes escape through the sheet-iron stack. The dust is withdrawn from this chamber by means of sliding valve *S*, and falls from the aperture *Z* into a wheelbarrow, *Y*. At smelter D flue-dust is not mixed with lime, as at most smelters, nor spread over ore-beds or mixed with smelting charges; it is simply moistened with water and thrown in the furnace in the proportion of one shovelful to every two smelting charges. The smelting capacity of each furnace is 24 tons of ore per 24 hours, or one ton per hour. The pressure in blast-pipe *I'* is regulated by a damper placed at its extremity. The length of runs at this smelter is about two months.

#### SMELTER E.

Disposition of works.—These works, situated on Big Evans gulch, are, like all the smelters erected on this gulch, divided into two levels only. This smelter is small, but well managed, and is one of the most successful of its size. The pressure of the steam in the boilers is 70 pounds to the square inch; they supply a 40 horse-power engine, which drives two Baker blowers, a set of Cornish rolls, two Blake crushers, and the pumps feeding the water tanks. The ore and fuel bins are inclosed in the main building, through which runs a wagon-road, and fuel reserves are placed at the back, outside of the works. The offices, provided with Fairbanks scales, and the laboratory are situated in a detached building a short distance back of the main building.

**Furnaces.**—The smelting capacity of these works is 40 to 50 tons of ore per 24 hours. Smelting is carried on in two blast furnaces of unequal capacity, constructed by Messrs. Fraser & Chalmers, of Chicago. The small furnace is circular and jacketed all over. Its smelting capacity is 15 tons of ore per 24 hours. The crucible is lined with steep, made of two parts fire-clay and one part coke dust. The distance between tuyere and feed-hole is 10 feet 9 inches. The depth of the crucible is 28 inches. The diameter of the riveted wrought-iron-plate water-jacket is 36 inches. This jacket is single. The furnace is worked with five tuyeres, each  $2\frac{1}{4}$  inches in diameter at the nozzle. The average pressure of blast used at smelter E is one inch of mercury. The large furnace presents the same general appearance as the small one, and is jacketed all over; but it is elliptical in section, the axes at the feed hole being 69 inches and 54 inches, respectively, and the axes of the riveted wrought-iron-plate water-jackets 52 inches and 34 inches. The water-jacket is made in four sections. The furnace is worked with seven tuyeres  $2\frac{1}{2}$  inches' diameter at the nozzle. The depth of the crucible is the same as that of the small furnace, namely, 28 inches and it is lined with the same kind of steep. The furnaces have projecting fore hearths and lead siphon-taps, and are constructed on identically the same principles as the circular furnaces at smelter B, made by the same firm. The furnaces are barred out every four days, and the length of run is about three months.

**Dust-chamber.**—Both furnaces are connected by means of sheet-iron flues with a brick chamber, flue-shaped and placed under the feeding-floor. This chamber is 75 feet long, 4 feet wide, and 6 feet high. It is provided, as usual, with a sheet-iron stack about 30 feet high, placed at the extreme end. The chamber is not divided into sections by internal walls, so that the condensation of fumes is rather imperfect; doors placed at short intervals allow the clearing away of the dust.

At smelter E flue-dust is mixed with lime in the proportion of one ton of dust for 300 pounds of lime (dolomitic), or about 15 per cent. The mixture, after moistening, is molded into bricks, which are then dried in the air and laid over ore-beds to be resmelted.

#### SMELTER F.

**Disposition of works.**—Smelter F is the model smelter of Big Evans gulch. The smelting building is capacious and well distributed, and everything in the construction of details of plant indicates extensive previous experience in smelting and no small amount of forethought. Like all the smelters in Big Evans gulch, smelter F is divided into two levels. The boiler, engine, and blast rooms are placed on the left of the furnace room (facing the furnaces) and on a level with them. There are two fine boilers, worked at a pressure of 65 pounds to the square inch, and the engine is of 50 horsepower. The machinery driven by this engine consists of two Baker blowers, two Blake crushers, a small grinding-mill, and the pumps feeding the water-tank. The system of blast-pipes is identical with the one used at smelter C. It is provided with safety-valves and dampers, and the excess of blast is ejected by means of a damper placed at the extreme end of the main pipe. Several rows of ore-bins and fuel-bins are placed on the feeding floor of the main building, and reserves of fuel stand at the back and outside the works. A broad wagon-road runs through the entire length of the works. The offices occupy a detached building placed near the entrance of the

works. The Fairbanks scales are placed immediately at the entrance of the main building and are connected with a small office. The laboratory occupies a detached construction distinct from the offices.

**Furnaces.**—There are two blast furnaces, of equal shape, dimensions, and capacity. The capacity of each furnace is 30 tons of ore per 24 hours. Fig 1, Plate XXXIII, represents the front elevation of one of these furnaces. They are square (8 by 7 feet outside measurement at feeding door, and 5 by 5 feet inside measurement of crucible), and their masonry is entirely made of bricks, braced at *Q*. They are provided with two feed-holes *H*, opened or closed by means of sliding doors *S'*. The masonry rests on a main cast-iron plate, *O*, supported on four cast-iron-pillars, *P*. The space *b* between the masonry and the water-jackets is filled with fire-brick.

The water-jackets, which are entirely made of cast iron, are similarly disposed in every respect to those of the same kind previously described. They consist of one jacket in front, one at the back, and two on each side. They are provided with feeders, outlet-pipes, and supply-pipes. The fire-brick breast *V*, placed between the hearth and front jacket, is seen in this furnace, and corresponds to a similar arrangement in all square furnaces in which the water-jackets are entirely made of cast iron. The water-jackets are provided with seven tuyere-holes, three on each side and one at the back, and the furnace is worked with seven tuyeres.

**Patent tuyeres.**—Fig. 1, Plate XXXIII, was specially drawn to show the system of tuyeres at this smelter, which differ in every respect from the thin sheet-iron galvanized tuyeres in general use in the camp. The tuyeres were patented December 6, 1875, by Mr. August Werner. They are made of cast iron, three fourths of an inch thick, and their internal diameter is  $2\frac{1}{2}$  inches. They are divided into two parts, the nozzle *N*, and the elbow *N'*. Both the nozzle and the elbow are flanged at *r*, the flanges being faced so as to fit closely and allow no escape of blast. The nozzle and elbow are hinged at *d*, and to the nozzle are fixed three small chains, *c*, hooked to the water-jackets. By means of these the direction of the tuyere can be changed at will so as to send the blast up and down or right and left. At this end the nozzle terminates in a wrought-iron spherical ring or ball, which works freely in a socket of the same metal, wedged in the tuyere-hole of the water-jacket. In other words, the tuyere works in a ball-and-socket joint. To stop the blast in any point of the furnace or to observe what is going on there, the elbow is lifted, as indicated in Fig. 1. The tuyeres are connected, as usual, with the blast-pipes by means of canvas wind-bags *K*. When the blast is turned off for the purpose of barring down the accretions of the furnace or clearing the hearth of accretions, a piece of paper is inserted between the flanges *r*, and should back flow of gases exert any pressure in the furnace the piece of paper would burst, the elbow of the tuyere be lifted, and the tuyere would thus act as a safety-valve. But this accident, so far as known, has never occurred in Leadville.

The normal pressure of blast used at these works is seven-eighths of an inch mercury. The crucible of the furnace is provided with a projecting fore-hearth and lead siphon-tap and is lined with fire-brick.

**Dust-chambers.**—The apparatus devised for the condensation of lead fumes at smelter F is the most elaborate of its kind used in Leadville, and is certainly the most efficient. Each furnace is connected with a separate condenser, placed above the feeding floor, and is identical with the one shown in side and front elevation, Plate XXXIV.



The chimney of the furnace *A* is connected by means of the angular sheet-iron flue *F' F''*, which projects above the roof *V* of the building, with the lozenge-shaped sheet-iron chamber *M*. The fumes strike against the sheet-iron apron *I*, hinged to the upper part of the chamber, which may be also used to regulate the draft by means of a chain which passes through the wall of the chamber. After leaving the chamber *M*, Fig. 1, the fumes circulate through the sheet-iron flue *O*, and then escape through the sheet-iron stack *F*.

In close proximity to the wall of the furnace, the flue *F'* is provided with a sheet-iron branch, *C*, through which the flue-dust falls into the wooden box *B*, from which it is extracted at the door *d*. Flues *F'*, *F''* are provided with sliding doors, not seen in the sketch, for clearing them of their dust. The chamber *M* has also a large sliding door, *D*. This chamber, as well as the horizontal flue *O* and the stack *F*, are cleared of their dust through the branches *C*, provided with sliding valves *t*. The principle of ascending flues is in itself excellent, and the smoke which comes out at the stack is remarkably free from lead fumes. About ten tons of flue-dust is collected monthly in each of these chambers. The dust is mixed with milk of lime, the mixture spread over ore-beds, and then resmelted.

Smelter F is the only one in Leadville where a little metallic iron (old horse-shoes) is added to the usual smelting charges when they contain more than a certain percentage of galena. The smelting campaigns have an average length of nine weeks. The furnaces are provided, as usual, with large hoods in front, above the slag-gutter.

#### SMELTER G.

Disposition of works. — This important smelter is situated on the northern bank of California gulch, and, like all the smelters situated on this gulch, is divided into several levels communicating with the upper and lower roads. One of the main features at these works is that the fuel storage, which is placed at the back of the works, is nearly on a level with the upper part of the stacks of the furnace and is connected with the furnaces by an elevated trestle-work having two branches, the one leading to the furnaces the other to the boiler-room. The fuel is transported in light sheet-iron mine cars, running on a light iron tramway, and dumped into chutes adjoining the feed-holes of the furnaces and the boiler. In the boiler-room a saving of 50 per cent. of the wood burned is effected by using the screenings of the fuel, which are usually wasted. A great saving of labor also results, since two fuel men are sufficient to supply all the fuel needed. In principle this arrangement is similar to the one adopted at smelter A. The charcoal sheds have an area of 30 by 325 feet and 35 by 100 feet, respectively, and hold about two hundred thousand bushels of charcoal. Coke is stored in sheds and bins of 500 tons capacity. The main smelting building is 360 by 110 feet, and the ore-room, placed on one side of the main building, is 60 by 210 feet. The storage capacity of this room, through which a wagou-road runs, is 7,000 tons of ore. The large dimensions of this room allow the preparation of numerous ore-beds, which insures great regularity in smelting. The offices, laboratory, Fairbanks scales, staff-houses, and 22 dwelling-houses for the workmen and their families, are distributed around the works. Particular attention is paid to the welfare of workmen, who are entitled to free medical attendance at the hospital, and for whom a bath-room and a reading and recreation room have been constructed.

Two boilers, 40 inches by 16 feet, worked at a pressure of 60 pounds to the square inch, supply a 70-horse power engine (cylinder 14 by 24 inches), and a second engine of 50 horse-power, with its boilers, is kept ready for use in case of need. This engine was the one formerly used at these works before they had attained their present smelting capacity.

The 70 horse-power engine drives three Baker blowers, one Root blower, two large Blake crushers, a set of Cornish rolls, and a slag-hoisting machine. The furnace-room is 120 by 40 feet, and contains four furnaces, smelting about one hundred and twenty tons of ore in twenty-four hours. The ventilation of this room will be shown in the description of the dust-chambers. The slag-heap is connected with the feeding-floor by an inclined-plane hoisting-machine, similar to the one used at smelter B, and used also to carry the slag up to be resmelted.

**Furnaces.** — Smelter G has three furnaces of equal shape and dimensions, similar to the one shown in front elevation (Fig. 1, Plate XXXV), and one larger furnace, shown in Fig. 2, Plate XXXV. Although built on the same general principles as the other furnaces of the camp, they offer a few interesting peculiarities in construction. The small furnaces are square (3 by 4 feet at the tuyeres), and their cast-iron pillars rest on the fire-brick lining of the crucible. The water-jackets *B* are made of riveted boiler-plates and are only four in number. Each side jacket is provided with two tuyere-holes and the back jacket with one; but the furnace is worked with the four side tuyeres only.

The main cast-iron plate support has a broad vertical flange, *O*, which confines the base of the outer walls *C'* of the furnace shaft, the shaft itself being, as usual, lined with fire-bricks; the outer wall is made of red brick, braced at *Q*.

These furnaces are fed through a single feed-hole placed at the back of each, and provided with sheet-iron sliding doors. The whole portion of the furnace comprised between the feeding-floor and the damper of the stack is surrounded by a sheet-iron jacket, *J'*.

The crucible of the furnace is framed in strong cast-iron plates, and the frame of the siphon-tap, lined with steep, is made of strong sheet iron. The smelting capacity of each of these furnaces is 26 to 28 tons of ore per twenty-four hours, and the length of runs is about 118 days.

The large furnace represented in Fig. 2 is the only one of its kind used in Leadville. The lead siphon tap *L* is placed in front of the furnace, and on each side of the furnace there are a fore-hearth, *X'*, and a slag-spout, *U*, alternately used for the tapping of slag. In *B'* are seen the slag-pots, mounted on wheels.

The water-jacket system is formed of four large water-jackets made of riveted boiler-plates. The front and back jackets are each provided with four tuyere-holes, but the furnace is worked with only six tuyeres. The dimensions at the tuyeres are 3 by 5 feet. The main cast iron plate support has a broad, vertical flange, *O*, incasing the base of the masonry.

The furnace is fed from two feed-holes, *H*, opened or closed by sheet-iron sliding doors. The feed-holes are placed in the side walls of this furnace, which correspond to the front and back walls of other furnaces. The pressure of blast used at smelter G varies from five-eighths of an inch to ten eighths of an inch of mercury. The capacity of the large Raschette furnace, which has just been described, is 38 to 40 tons of ore

per twenty-four hours. The manipulations of either furnace do not differ from those in use at other smelters. The shovels used are represented in Figs. 2 and 3, Plate XLIV, and the bars of bullion in Figs. 5 and 6, Plate XLV.

Dust-chambers and ventilation.—In Fig. 1, Plate XXXVI, is shown the general system of condensation of lead fumes and of ventilation of the furnace-room. The ventilators  $V$   $V''$   $V'''$  consist of large rectangular sheet-iron chimneys resting on the brick dust-chambers  $D'$   $D''$   $D'''$ . They are open at their base on the side towards the furnaces to allow hot air to escape through them. Besides the ventilators each furnace is provided with a hood and chimney in front of the furnace towards the slag-gutters.

Furnace  $A$  is connected by means of sheet-iron flue  $F'$  with chamber  $D'$ , divided into three sections,  $a$ ,  $b$ ,  $c$ , by means of partition walls  $x$ , and the smoke escapes through the sheet-iron stack  $S$ .

Furnace  $B$  is similarly connected through flue  $F''$  with chamber  $D''$ , divided into three sections,  $a'$ ,  $b'$ ,  $c'$ , by means of walls  $w'$ , the smoke escaping through sheet-iron stack  $S''$ .

Furnace  $C$  is connected by means of sheet-iron flue  $F'''$  with a brick chamber,  $d'$ , 8 feet high and 11 by 11 feet at base, resting on the feeding-floor  $P' P'$ . This chamber has an independent sheet-iron stack,  $S'$ .

Furnace  $D$  communicates by means of sheet-iron flue  $F''''$  with chamber  $D''''$ , divided into two sections  $a''$ ,  $b''$ , and the fumes circulate through the brick flue  $C''$ , 25 feet long, and then ascend the square brick stack  $S''''$ . Each section of the dust-chambers is provided with sliding doors  $d$ , for the extraction of the dust; those of sections  $c'$  and  $a''$  of chambers  $D''$  and  $D''''$  are in the arch-way  $O$ .

At smelter G fine-dust is mixed with argillaceous ores and resmelted.

Smelting charges.—The following figures show the smelting performed by the three small furnaces at smelter G from the 14th of June, 1879, to the 1st of January, 1880:

Ore smelted,	24,094,177 pounds = 12,047 tons,	assaying 73½ ounces silver;	lead, 22 per cent.
Dolomite,	1,521,085 pounds = 6.31 per cent.	of ore smelted.	
Hematite,	2,872,535 pounds = 11.92 per cent.	of ore smelted.	
Coke,	1,983,110 pounds = 8.25 per cent.	of ore smelted	} Fuel = 24.5 per cent. of ore smelted.
Chareoal,	3,916,287 pounds = 16.25 per cent.	of ore smelted	

The contents were: Silver, 885,454 ounces; lead, 5,300,719 pounds. The products amounted to: Silver, 866,666 ounces; lead, 4,469,823 pounds.

The loss in silver was 2.12 per cent. and in lead 15.67 per cent.

The average price paid per ton of ore was \$66.15.

The bullion produced each day, 12½ tons.

#### SMELTER H.

Disposition of works.—Smelter H is the most important smelter of Big Evans gulch. These works are in close proximity to the important mines of Fryer Hill, and the ores they receive comprise some of the richest in lead, gold, and silver. The bullion extracted there is also generally very rich in silver. The works are provided with a laboratory, in which the ores are assayed, chiefly by scorification, but some mines require also the crucible assay. The crucible assays of ore for silver and of ores and slags for lead are made only with reducing flux, and no iron rods are used for the reduction of sulphurets

and arseniurets. The assays for iron and gangue are made as usual, although the solutions of ores are not evaporated to recover soluble silica and the estimation of moisture is made in a very rough way.

The specific gravity of slag is taken from day to day for each furnace by means of the Jolly specific-gravity balance, already described, which is figured in Plate XXXVIII. This operation is of no more advantage at smelter H than at smelter B, and here, as there, the slags thrown away are the richest of the camp, both in lead and silver.

The ore-beds are made to contain equal parts of iron and gangue, and the slags thus formed are slightly acid. This plan, which is recommended in Leadville, and which is gaining the confidence of smelters, should be condemned theoretically, and practice proves that theory is correct. It results, from the examination of slags made in the laboratory of the Survey, that the so-called acid slags are richer in lead and silver than the more basic ones. But the chief defect of this plan is that an insufficient quantity of iron is reduced, and that very large quantities of sulphuret accretions and unreduced galena are formed, interfering seriously with the working of the furnace. In the opinion of the writer the center of gravity of smelting operations, so to speak, should be periodically displaced, and alternate acid and basic charges should be used, for the inconveniences inherent in the use of these mixtures are precisely of an opposite character and calculated to counterbalance or destroy each other. At smelters C and G, where smelting is conducted on scientific principles, the mixtures are carefully made to correspond to singulo-silicate slags, which might be called neutral, so that the final result is the same as the one proposed.

The quantity of matte formed at smelter H is about 20 pounds per ton of ore, or 1 per cent. These mattes are roasted in heaps and resmelted; but it will be seen that this mode of treatment is bad, and that much silver is lost during the roasting.

The method of bullion assay, which is the one in general use in Leadville, is as follows:

At smelter H two assay bits of lead (one from the top and one from the bottom of each bar) are detached from each bar composing a car-load by the chisel represented in Fig. 12, Plate XLIV. By hammering in different directions triangular bits of lead are detached, such as are represented in Fig. 13. All the bits representing the car-load are melted together under live charcoal in a plumbago pot. The charcoal is then removed and the lead is skimmed by means of a small perforated ladle, and then poured into a bar-mold. A bar about one inch thick is thus obtained (see Fig. 7, Plate XLV), from which three or four assay bits are detached at *a* by means of an ordinary chisel and hammer. Half an assay ton is weighed from each bit, and the assay is made, as usual, by cupellation.

The offices, laboratory, and Fairbanks scales occupy a detached building at the entrance and rear of the works, and fuel is placed on the same level in the open space at the back of the main smelting building. The ore-bins are all placed within the building on the feeding-floor level, through which runs a wagon-road for the distribution of ore from wagons.

On the left of the furnace-room (facing the furnace) is the engine and blast room. Two boilers, worked at a pressure of 80 pounds to the square inch, supply a powerful engine of 100 horse-power, which drives four Baker blowers, one Blake crusher, one

set of Cornish rolls, and the pump. The works are also provided with a small mechanics' shop. The slag-heap at this as well as at all the smelters on Big Evans gulch encroaches on the bed of the creek. The smelting capacity of the works is about sixty-five tons of ore per twenty-four hours.

**Furnaces.**—At smelter H there are three furnaces of the Piltz pattern, constructed by Messrs. Fraser & Chalmers, of Chicago. These furnaces, which have already been described in the general description of the furnaces, and which are also successfully at work at smelter B, are represented in perspective view, Fig. 1, Plate XXXVII. This sketch was drawn for the purpose of giving a correct idea of the general appearance of these furnaces, which cannot be obtained at a glance from the elevation and section alone. In this sketch the crucible *A*, with its frame of cast-iron plates, as well as the frame of the lead siphon-tap *L* and of the fore-hearth *X'*, is clearly seen. The cast-iron pillars *P*, with their capitals and brackets and the two slag-gutters *U*, are visible. Likewise the riveted wrought-iron boiler-plate water-jackets *B*, the fire-brick breast *V*, and the tym-stone and tap-hole *Z*. The main cast-iron support *O*, with its vertical flange *O'*, supported by the brackets *r*, the induction-pipe *I*, and the wrought-iron casing *J'* around the masonry, are also visible.

The same furnaces are represented in vertical section in Fig. 2, Plate XXXVII, showing the steep-lining of the hearth and fore-hearth *X'*, the siphon *L'*, the space *b*, between the water-jackets and the masonry, filled with fire-brick, and the fire-brick lining *C'* of the furnace.

Fig. 2 shows also the arrangement adopted at smelter H for the tapping of slag. The slag runs into a cast-iron slag-pot, *V'*, provided with a spout, *U'*, and live charcoal in large pieces is kept over the molten slag to prevent it from cooling. Any bullion mechanically carried away falls at the bottom of the pot *V'*, which is cleared of its contents from time to time. The slag thus freed from bullion runs into the ordinary slag-pot *B'*, mounted on wheels.

This arrangement is evidently excellent, but is only necessitated by some defect in the lining of the dam, for in well-lined furnaces no bullion can escape, thus rendering the use of an intermediate slag-pot unnecessary; this is proved by the fact that slags never contain any metallic grains, no matter from what part of the cake the specimen is taken.

Fig. 2 shows also the connection, by means of the sheet-iron flue *F'* of the chimney *E*, of the furnace with the sheet-iron chamber *D'*, resting on the feeding-floor *P'*, used to catch lead-dust. At *d'* is seen one of the doors of this chamber, through which the dust is extracted. The small furnaces which have just been described are worked with six tuyeres,  $2\frac{1}{2}$  inches at the nozzle, and their smelting capacity is 16 to 18 tons of ore per twenty-four hours for each furnace.

Besides the three Piltz furnaces, smelter H has a large Raschette furnace, which was formerly run at smelter L. The smelting capacity of this furnace is 25 tons of ore in twenty-four hours. The internal dimensions of the crucible are 5 by 3 feet. The hearth is lined with steep and the furnace is supported on four cast-iron pillars, like the square furnaces of similar construction already described. The water-jacket system is rather complicated and is formed of one front and one back jacket, made of wrought-iron riveted boiler-plates, with five cast-iron water-jackets on each side. This plan, as has been observed before, is not good, and at the time this report was made the water-jacket system was under repair. The difference of dilation of the two metals is always

a source of trouble and the plan should be condemned altogether. The furnace is worked with nine tuyeres, 3 inches in diameter at the nozzle, inserted, as usual, in the water-jackets; one of the tuyeres is placed in the back jacket and four on each side.

Each jacket is not only provided with inlet and outlet pipes for the circulation of water, but a general circulation has been established between all the jackets by means of pipes screwed into them at the base and communicating with one another.

Dust-chambers. —The system of condensation of lead fumes adopted at this smelter is poor, and "leading" is consequently of frequent occurrence. The four furnaces are connected by means of the sheet-iron flues  $F^i$   $F^{ii}$   $F^{iii}$   $F^{iv}$  with the sheet-iron chamber  $M$ , connected by means of the brick flue  $N$  with the stack  $F$  (in Fig. 1, Plate XXXVIII). The sheet-iron chamber has already been seen in transverse elevation (Fig. 2, Plate XXXVII). Neither chamber  $M$  nor  $N$  is divided into sections, so that the condensation of fumes is very imperfect. Both chambers are provided, as usual, with sliding doors  $d$  for the extraction of the dust.

At smelter H, flue-dust is mixed with Hibernia ore (an argillaceous ore containing no lead) and introduced afterwards into the composition of ore-beds.

#### SMELTER I.

Smelter I is erected on the northern bank of California gulch, in a situation so similar to that of smelter C that the general description of the latter applies word for word to these works. The only peculiarity at Smelter I is that the furnace and feeding-floor levels are connected by a vertical elevator used for hoisting slags to be resmelted. This elevator is placed in the main building. The boilers are worked at a pressure of 70 pounds to the square inch. The machinery consists of a 60 horse-power engine, two Baker blowers, one Blake crusher, and the pump.

The slag-pots are independent of the cars and are identical with those which have been described at smelter A. The smelting plant consists of two Piltz furnaces, identical in capacity, shape, and dimensions, and constructed by Messrs. Fraser & Chalmers. These furnaces are similar to furnaces of the same pattern used at smelters B and H, but have only one slag-spout. The water-jackets  $B$  also are made in but two sections, and the frame of the crucible of four cast-iron plates, segments of a circle. One of these furnaces is shown in elevation in Fig. 2, Plate XLV. It may be seen that each Baker blower,  $W$ , is in direct communication with the induction-pipe  $I$ , the general system of connecting all the blowers with a main blast-pipe not being in use here.

The system of condensation of lead fumes consists of a sheet-iron box,  $D'$ , 8 by 8 feet, and 10 feet high, provided with a sheet-iron stack,  $F$ . Each furnace is connected by means of a sheet-iron flue,  $F'$ , with a similar chamber, from which the dust is extracted through hinged doors  $d'$ . The amount of flue-dust caught in both chambers is about 5 tons per week. The dust is mixed with milk of lime, the mixture is dried and then resmelted gradually with the smelting charge.

The smelting capacity of the works is about 40 tons per twenty-four hours.

#### SMELTER J.

Smelter J is a well-constructed smelter standing on the southwestern bank of Big Evans gulch, and is disposed exactly like smelter H, with this difference, that the offices and laboratory stand on one side of the main smelting building instead of being

placed in the rear of the works. The works had ceased running at the time this report was made, but they deserve a description chiefly on account of the well-constructed brick dust-chamber with which the furnaces are connected.

The smelting plant consists of one Piltz furnace, worked with six tuyeres, and constructed by Messrs. Fraser & Chalmers. The diameter at the base of the water-jacket is 40 inches, and the furnace is similar in every respect to the Piltz furnaces used at other smelters. Besides the Piltz furnace there is a Raschette furnace, charged through two feed-holes, and almost identical in proportion and capacity with the Raschette furnace used at smelter H. The water-jackets, all made of cast iron, are thirteen in number: one in front, two at the back, and five on each side. The internal dimensions at the tuyeres are 5 by 3 feet and the furnace is worked with nine tuyeres.

Both furnaces are connected with a dust-chamber placed immediately below the feeding-floor. This chamber is built entirely of red brick.

The plan of this chamber is given in Fig. 2, Plate XL, showing the brick chamber *D'*, the brick flues *NN'*, communicating with the sheet-iron stack *F*. In this plan *A* represents the Piltz furnace and *B* the Raschette furnace. The same chamber is represented in elevation in Fig. 1. The two sliding doors through which dust is cleared away are placed at *d*. The capacity of the works is 40 tons per twenty-four hours. The machinery consists of a 50 horse-power engine, two Baker blowers, one Blake crusher, and one set of Cornish rolls. The charges are weighed, as at all the other smelters, on scales placed on the feeding floor. The slag-pots used are mounted on wheels.

SMELTER K.

Smelter K is the smallest smelter of Big Evans gulch, and has only one furnace, which was not running at the time this report was made. These works are, on a miniature scale, disposed exactly like smelters H and J, and they have this point in common with smelter H, that intermediate slag-pots are used for catching any bullion mechanically carried away. The furnace is a Piltz pattern furnace 40 inches in diameter at the base of the water-jackets, and worked with six tuyeres, 2¼ inches in diameter at the nozzle. The capacity of the works is 18 to 20 tons per twenty-four hours. This smelter affords an opportunity for showing the plant and manual labor required to work one furnace. At these works the manual labor was represented by—

	Pay per diem.	Length of shift.
		<i>Hours.</i>
1 foreman.....	\$5 00	12
2 head smelters.....	4 00	12
2 feeders.....	3 00	12
2 helpers.....	3 00	12
2 engineers.....	3 00	12
8 day laborers.....	2 50	10
4 staff officers.....		

The plant, supplied by Messrs. Fraser & Chalmers, of Chicago, consists of—  
One Piltz furnace, 40 inches diameter at the water-jackets.

One tubular steam-boiler, 48 inches in diameter and 14 feet long. (This boiler is sufficient for two furnaces.)

One stationary steam engine (cylinder 12 by 18 inches).

One No. 5 Baker blower, with mercury gauge.

One complete set of blast and induction pipes, with hose and tuyeres

One Blake crusher (opening between the jaws, 10 by 7 inches).

One set of Cornish rolls, 16 by 10 inches.

Eight slag-pots, mounted on wheels or on independent cars.

Six lead-ladles.

Eighteen lead-molds, with name of smelting firm at bottom, for branding bullion.

Two No. 4½ sheet-iron mining-barrows for fuel.

Thirty-five steel furnace-bars, from ¾ inch to 1½ inches.

To this must be added either a sheet-iron dust-chamber, 8 by 8 by 10 feet, constructed by Messrs. Fraser & Chalmers, or else a convenient brick chamber placed under the feeding floor; a 10-ton Fairbanks platform scale, and several ore-barrows, shovels, etc., and a water-tank for feeding the water-jackets of the furnace.

#### SMELTER L.

Smelter L is the Little Chief smelter which stood on Fryer Hill, above the Little Chief mine, and which has been pulled down, owing to the sinking of the ground upon which it was erected. The Little Chief smelter ran only on Little Chief ore, and its ore-room was connected with the shaft of the mine by a railroad track, upon which the loaded mine-cars were run.

The capacity of smelter L in tons of ore per twenty-four hours was 35 tons, which were smelted with dolomite and hematite in the Raschette furnace now at work at smelter H. More sows were found at this smelter than at any other, showing that the slags were basic.

During the year ending June 1, 1880, 5,500 tons of ore were smelted, producing 760 tons of bullion. The plant consisted of a 40 horse-power engine (cylinder, 16 by 24 inches) and a boiler, 48 inches by 14 feet, constructed by Messrs. Fraser & Chalmers; one No. 5 Baker blower; one Blake crusher, 15 by 9 inches between the jaws; and the furnace previously described. The slags at this smelter are remarkable for the absence of titanite acid.

#### SMELTER M.

These works, the first that were erected in Leadville, were being pulled down at the time this report was made. They were situated immediately outside of the city of Leadville, at the junction of the upper and lower district roads of California gulch. The allotted space for the slag-heap between the works and the lower road was soon filled up, and the slags had to be wheeled up at the back of the works on a level with the feeding-floor. These slags are unlike any other produced in or near Leadville. They are coarse-grained, with a dull fracture, extremely dense, and contain an enormous quantity of lead and silver.

An opportunity was afforded of assaying a few of the ores which were in the bins after this smelter ceased running. Their contents in lead and silver were as follows:

Lead....per cent..	13.9	8.7	0.9	20.8
Silver.....ounces..	34.9	60.25	70.4	45.5



Smelter M had but one square furnace, of the Raschette pattern, entirely sheathed in an iron jacket. The water-jacket system was formed of four wrought-iron riveted-plate jackets, provided with seven tuyere-holes. The lining of the crucible was made of steep. The dimensions at the tuyere were 5 by 2 feet. In Fig. 2, Plate XXXIII, is seen the peculiar dust-chamber which was used at this smelter. The stack *E* of the furnace was connected by means of the sheet-iron flue *F* with the cylindrical sheet-iron chamber *D'*, placed high above the feeding-floor and outside of the main building. This chamber was provided with a stack *E*, and the fumes were compelled to circulate by means of the two sheet-iron cones *u y z*, suspended to the stack *F* by means of a chain *a y*. The chamber was provided with a sliding valve *S*, for the extraction of the dust, which fell through the pipe *z* into a wooden box, placed on a level with the feeding-floor.

The smelting capacity of the works was 30 tons of ore per twenty-four hours.

#### SMELTER N.

Smelter N, situated in Malta, at the end of California gulch, was the first smelter erected in Lake County, and was built in 1875. This smelter, which was not running at the time this report was made, has been started anew. The works are divided into several levels. The well from which the water was pumped into the water-jackets of the furnace stands in the furnace-room. The furnace, the only one used at these works, has the same shape and capacity as the furnace described at smelter M, and is also entirely sheathed in an iron jacket.

The engine is of 30 horse-power, driving one No. 4 Baker blower, one Blake crusher (10 by 7 feet), and tie pumps.

Eighteen men and four officers are in charge of the works.

Smelter N is placed a few yards from the Denver and Rio Grande Railroad track, and is connected with it by a siding.

#### SMELTER O.

This smelter is also situated in Malta, at the end of California gulch, and a short distance south of smelter N.

Smelter O has two furnaces of the Piltz pattern, oval in shape and similar to the oval furnace used at smelter E. These works have long since ceased running.

#### SMELTER P.

Smelter P is the Adelaide smelter, which was situated near the mine in Stray Horse gulch, at the north end of Iron Hill. It also ceased running long ago for want of ore. Its furnace has since been purchased and removed, and is now running at one of the smelters in Big Evans gulch.

## SECTION IV.

## PRODUCTS OF SMELTING.

## BULLION.

Sale of bullion.—In Leadville bullion is generally sold to agents of Eastern refineries, who pay for its transportation from the camp to the East. The cost of transportation varies, according to distance, from \$27 to \$35 per ton.

The price of lead in bullion at Leadville has varied during the year ending June 1, 1880, from \$30 to \$78 per ton. The average price has been from \$60 to \$72 per ton.

Sometimes bullion is paid for at New York quotations, with a deduction of 3 cents per ounce of silver and of \$14 to \$15 per ton of bullion for the refining charges. In other cases, the refiners' charges are 3 ounces of silver and 5 per cent., or 100 pounds of lead per ton of bullion.

When the smelting works of Leadville are branch establishments of large eastern refineries, private arrangements are made between the main works and its branch.

When bullion is shipped to refineries to be desilverized for account of the smelting firm, the smelters pay for the transportation of bullion from the camp to the refinery. In this instance the agreement between smelters and refiners is shown in the following model of bullion invoice.

NAME OF SMELTING FIRM.			
<i>Leadville, Colorado.</i>			
Invoice of bullion, No.....			
Car lot ..... bars ..... weighing ..... lbs. shipped .....	182—		
Assay per ton (2,000 lbs.).....	.....ozs. silver.	New York quotations .....	day shipped.
Total ozs. silver, .....	less .....	ozs. per ton in refining, .....	ozs., @ .....
Total lbs. load, .....	less .....	per cent. lost in refining, .....	lbs., @ .....
		Value of lead and silver .....	\$ .....
Deduct freight to .....	\$ .....	cost of refining per ton, \$.....	\$ .....
		Net value of shipment.....	\$ .....
Deduct .....	10% of net value .....		\$ .....
		Amount for which draft may be made .....	\$ .....

When the price of bullion is low it is frequently kept in reserve in Leadville, in the expectation of a rise in the New York price. During the month of August, 1880, one of the smelters presented the imposing sight of reserve piles of 14,625 bars of bullion, amounting to 1,453,250 pounds, or 716½ tons.

The bars of bullion in the camp belong to two principal types, shown in Figs. 3 and 4 and Figs. 5 and 6, Plate XLV. Their average weight is 100 pounds, so that car-loads weighing on an average 20,000 pounds, or 10 tons, are formed of 200 bars. In

Table VII will be found the weekly production of the different smelters, their weekly or monthly shipments, with the weight and average assay of bullion for the dates indicated.

TABLE VII.—*Shipment of bullion.*

Smelter.	Weekly production.		Weekly or monthly shipments.					For month of—
	Tons.	For week ending—	Number of bars.	Average weight of bars.	Total weight of bars.	Average tenor in silver.	For week ending—	
				<i>Pounds.</i>	<i>Tons.</i>	<i>Ozs. to ton.</i>		
Harrison Reduction Works.....	24	Dec. 18, 1879	6, 125	85	260	324	.....	July, 1880
Grant .....	145	Jan. 8, 1880	17, 160	100	558	326	.....	Do.
Leadville .....	21	Dec. 4, 1879	420	100	21	205	Dec. 4, 1879	
La Plata.....	89	Jan. 8, 1880	3, 990	100	199½	178	.....	Do.
American.....	15	...do	569	100	28½	258	Dec. 25, 1879	
Billing & Eilers.....	90	...do	5, 300	98	259	136	.....	Do.
California .....	20	...do	1, 075	100	53¾	218	.....	Do.
Malta.....	14	Dec. 18, 1879	218	102	11½	314	Dec. 29, 1879	
Lizite .....	22	Jan. 8, 1880	335	103	17½	338	...do	
Little Chief .....	25	...do	1, 045	100	52½	370	...do	
Ohio and Masonri.....	20	...do	2, 836	100	141½	443	.....	Do.
Cumming & Finn .....	50	...do	3, 600	100	180	314	.....	Do.
Gage, Hagaman & Co.....	30	...do	475	100	31	445	Dec. 29, 1879	
Raymond, Sherman & McKay....	23	Dec. 18, 1879	470	100	23½	250	...do	
Elgin .....	40	Jan. 8, 1880	2, 330	100	111½	297	.....	Do.
Total and averages .....	628	.....	.....	99. 20	.....	294. 4	.....	

Composition of bullion.—The quality of bullion differs a good deal from smelter to smelter, and from day to day at each smelter, but the former difference is more sensible than the latter. At some works bullion is soft, with a clear surface; at others, more or less hard, with a scummy surface. The difference in the quality of bullion is due less to the difference in composition of the ores, which are sensibly the same, than to the care with which smelting is carried on. The same furnaces and the same ores will yield coarse or partly refined bullion, according to the rapidity with which the furnaces run, but chiefly according to the quantity of iron reduced during the operation, this metal being an excellent refining agent.

The charges for refining bullion being greater for coarse than for soft metal, it is quite evident that the smelters have a direct interest in obtaining from their furnaces a metal as refined as possible. The best smelting works of Leadville obtain a bullion of very fair quality.

Analyses.—The writer has made in the laboratory of the Survey the two following analyses of bullion :

*Analysis XXII.*—Specimen of bullion taken from the furnace at the La Plata smelter. This bullion is soft, with a clean surface.

*Analysis XXIII.*—Mixture of equal parts of bullion from the following smelters :

Names of smelters.	Remarks.
Billing & Eilers.....	Sample from one car-load, weighing about 11 tons; soft, with a clean surface.
Cumming & Finn.....	Sample from one car-load, weighing about 10 tons; somewhat hard, with clean surface.
California.....	One specimen from one furnace.
Elgin.....	One specimen from one furnace.
Grant.....	Two specimens from two furnaces.
Gage, Hagaman & Co.....	Sample from one car load shipped in December, 1879.
Harrison.....	One specimen from one furnace.
La Plata.....	One specimen from one furnace.
Ohio and Missouri.....	One specimen from one furnace.

ANALYSES XXII AND XXIII. BULLION.

	XXII.	XXIII.
Lead (by difference) .....	99. 0798240	98. 492379
Silver.....	0. 0112445	0. 793417
Gold.....	0. 0000888	0. 000691
Copper.....	0. 0479100	0. 071450
Tin.....	Faint trace	0. 000897
Bismuth.....	Faint trace	0. 011791
Arsenic.....	0. 0291365	0. 219528
Antimony.....	0. 2138949	0. 347881
Iron.....	0. 0063000	0. 012600
Zinc.....	0. 0016052	0. 000232
Cadmium.....	Faint trace	Faint trace
Sulphur.....	None	0. 048924
	100. 0000000	100. 000000
Ounces of silver to the ton .....	178. 275	231. 408
Ounces of gold to the ton.....	0. 026	0. 260

Discussion.—Analysis XXIII enabled the writer to detect the presence of a great number of metals, some of which, like tin, were not even suspected to exist in Leadville, inasmuch as the sample analyzed represents ores from nearly every mine in the region. While investigating this sample of bullion it was observed that part of the silver exists there in the state of sulphide. Some of the lead, as might be anticipated, is also in the state of sulphide. This is very easily demonstrated in the following manner: The bullion is dissolved in weak nitric acid; the unattacked residue is both yellow and black. The yellow portion is sulphur from sulphide of lead, which is easily attacked by weak nitric acid with separation of sulphur; the black portion is formed of sulphide of silver, which is not touched by weak nitric acid. Neither the relative proportion of silver existing in bullion in the metallic state, nor the amount of lead as sulphide, was determined, because this kind of research would have led too far; but it would seem to be sufficient to call the attention of smelters and refiners to the fact.

COMPOSITION OF BULLION.

Assays of bullion.—The following assays show the varying proportions of gold and silver in the bullion. The specimens assayed are those which had been mixed for analyses :

Location.	Smelter.	Bullion.	
		Silver.	Gold.
		<i>Ounces to ton.</i>	<i>Ounces to ton.</i>
California gulch .....	Billing & Eilers .....	87.2817	0.1423
	California .....	216.2267	0.0233
	Grant .....	325.1550	Faint trace
	Grant .....	368.5000	Faint trace
	Harrison .....	132.9417	0.3993
	La Plata .....	178.2750	0.0260
Average .....		218.0633	0.081
Big Evans gulch ..	Cumming & Finu .....	366.8787	1.1223
	Elgin .....	245.9750	0.1500
	Gage, Hagaman & Co. ..	127.2517	0.0833
	Ohio and Missouri .....	265.5984	0.6566
	Average .....		251.4256

Thus it will be noticed that the bullion produced in Big Evans gulch is generally richer in gold than that of California gulch.

*Assays of bullion made at Messrs. Cumming & Finn's smelter in August, 1880.*

[Each assay represents a car-load of 10 tons of bullion.]

	Silver.	Gold.
	<i>Ounces to ton.</i>	<i>Ounces to ton.</i>
No. 1 .....	327.9	0.0415
No. 2 .....	301.5	None
No. 3 .....	338.25	None

(Hadelberg.)

*Daily assays of bullion made at one of the smelters in Leadville*

[Each assay represents the bullion extracted in 24 hours.]

Date.	Silver.	Gold.
	<i>Ounces to ton.</i>	<i>Ounces to ton.</i>
1880.		
May 30 .....	314.25	1.1
May 31 .....	289.70	1.3
June 1 .....	281.57	1.75
June 2 .....	266.675	1.325
June 3 .....	260.22	1.10
June 4 .....	275.60	0.65
June 6 .....	357.175	0.50
June 7 .....	414.46	0.20
June 8 .....	443.85	0.15
June 9 .....	318.90	0.10
June 10 .....	322.4625	0.0375
June 11 .....	284.5	None
June 12 .....	278.0	None

**Skimmings.**—The following is an analysis of skimmings collected in the siphon-tap or lead-pot of one of the furnaces at the Grant smelter ; it is interesting because it contains, in concentrated form, the metals which exist only in small quantity in the bullion, and thus more certainly proves their existence:

## ANALYSIS XXIV. SKIMMINGS.

Lead .....	97.9172
Silver .....	0.8657
Copper .....	0.0359
Bismuth .....	0.0160
Iron .....	0.4249
Cobalt .....	0.0087
Nickel .....	Faint trace
Zinc .....	0.0158
Arsenic .....	1.1875
Antimony .....	0.1147
Tin .....	0.0095
Sulphur .....	3.3400
Oxygen and loss (by difference) .....	1.0641
	100.0000

Silver, 252.5 ounces to the ton. Gold, not a trace.

**Discussion.**—In the skimmings, as in the bullion itself, part of the silver and some lead exist in the state of sulphides; in fact, the skimmings are peculiar alloys of metals, sulphides, and oxides. Although it was known from the analyses of the ores by Dr. W. F. Hillebrand, and of the hematites by the writer, that cobalt was present in the smelting charge, the writer was extremely surprised not to find this metal concentrated in the speiss or in any of the other furnace products, mattes, accretions, etc. The preceding analyses show that it is in the skimmings that it must be looked for. This curious fact illustrates a most interesting case of separation of nickel from cobalt by the dry way, and by a method hitherto unknown and unsuspected. Nickel, as will be seen, is concentrated in the speiss, and cobalt accompanies the bullion, from which it can easily be separated by the simple process of skimming. There would seem to be no reason why this simple process should not be used in the metallurgy of nickel and cobalt; for no cobalt is found either in speiss or bullion. When the skimmings are cupelled, the presence of cobalt is revealed by the formation of blue specks of phosphate of zinc and cobalt. This phenomenon is so rarely seen that it should not pass unnoticed here.

The skimmings are covered with a crystalline, yellowish-black scum, from which they cannot be separated. When they are broken to pieces, the pieces are crystalline, with a white metallic luster, similar to lead. These pieces flatten under the hammer, but the flattened portions are very brittle, with a crystalline structure and a blackish color, due to small but very distinct crystals of galena.

Losses.—The loss of lead and silver in smelting is thus estimated at the different smelters:

	A.	B.	C.	D.	E.	F.	G.	H.
	<i>Per cent.</i>	<i>Per cent.</i>	<i>Per cent.</i>	<i>Per cent.</i>	<i>Per cent.</i>	<i>Per cent.</i>	<i>Per cent.</i>	<i>Per cent.</i>
Loss of lead.....	10 to 15	10 to 15	5 to 15	13	7 to 10	12 to 15	12	9 to 14
Loss of silver.....	2.5 to 5	5	5 to 12	1.5	3	None	3	3 to 5

The average loss is: Lead, 11.68 per cent.; silver, 3.59 per cent.

Part of the loss in both lead and silver is recovered in the smelting of the lead fumes.

Bullion capacity of smelters.—The charges contain on an average 20 per cent. of lead, of which 88 per cent. is extracted in the state of bullion; hence it is easy to calculate the bullion capacity of each smelter, as is done in the following table:

TABLE VIII.—*Bullion capacity of smelters.*

Smelter.	No. of furnaces running.	No. of charges each per twenty-four hours.	Total No. of charges per twenty-four hours.	Weight of each charge.	Total weight of charges run in twenty-four hours.	Lead in charges (20 per cent. of whole).	Lead in bullion (88 per cent. of lead goes into bullion.)	
				<i>Pounds.</i>	<i>Pounds.</i>	<i>Pounds.</i>	<i>Pounds.</i>	<i>Tons.</i>
A.....	2	300	600	200	120,000	24,000	21,120	10½
B.....	{	6	88	528	700	369,600		
		3	150	450	700	315,000		
Total.....			978		684,600	136,920	120,489	60¼
C.....	2	109	200	920	184,000	36,800	32,384	16½
D.....	2	60	120	1,000	120,000	24,000	21,120	10½
E.....	{	1	100	100	380	38,000		
		1	175	175	380	66,500		
Total.....			275		104,500	20,900	18,392	9½
F.....	2	65	130	780	101,400	20,280	17,846	8¾
G.....	{	1	96	96	790	75,840		
		2	76	152	790	120,080		
		1	70	70	790	55,300		
Total.....			318		251,220	50,244	44,215	22¼
H.....	{	3	02	186	700	130,200		
		1	100	100	700	70,000		
Total.....			286		200,200	40,040	35,235	17¾

*Tons.*

Total amount of bullion extracted during twenty-four hours (weight of silver and other impurities being neglected)... 155¼  
 It has already been seen (Table IV) that the smelting capacity of the smelters in tons of ore is..... 700  
 Also, that the daily output of the mines is from 700 to 800 tons of ore, giving on an average..... 750

Bullion production.— In Table IX are given the amount and value of gold, silver, and lead produced at the different smelters in the month of December 1880; also, in the last column, the value of the total product for the year 1880.

TABLE IX.—*Bullion production.*

Smelter.	Bullion shipments for December, 1880.	Silver contents.			Gold contents.			Lead contents.	Total value of product.	
		No. of ounces per ton.	Total weight.	Value.	No. of ounces per ton.	Total weight.	Value.	Value.	For December.	For year 1880.
	<i>Pounds.</i>	<i>Ounces.</i>	<i>Ounces.</i>		<i>Ounces.</i>	<i>Ounces.</i>				
American .....	380,000	125	23,750	\$26,720			\$17,033	\$43,753	\$299,126	
Billing & Eilers.....	1,024,000	130	105,560	118,755			72,093	191,448	2,105,701	
California .....	441,720	197.5	43,738	49,208			15,255	64,463	702,826	
Cumming & Finn....	553,500	367.5	101,808	114,534			24,021	139,155	1,324,213	
Elgin .....	187,575	175	16,407	18,458			8,395	20,853	462,439	
Gage, Hagaman & Co..	None	None	None	None			None		213,697	
Grant .....	1,180,000	242	142,780	160,628			52,098	213,326	4,018,290	
Harrison .....	322,263	156	25,116	28,280	0.40	64.5	\$1,280	14,431	43,991	917,304
La Plata .....	895,920	162.5	73,010	78,761			40,120	118,861	2,316,310	
Leadville .....	None	None	None	None			None		14,218	
Little Chief .....	None	None	None	None			None		109,072	
Lizzie .....	None	None	None	None			None		63,601	
Malta .....	127,316	83.7	5,320	5,985	1.46	93.0	1,800	5,715	13,500	24,362
Onto and Missouri....	157,057	327.5	25,700	28,910			6,095	35,905	822,656	
Totals and averages.	5,669,351	101.86	563,189	630,239		157.5	3,080	257,956	891,275	13,493,905

## SLAG.

*Fire assays of slag, made by J. E. Hardman in March, 1880.*

Smelter.	Lead.	Silver.	Smelter.	Lead.	Silver.
	<i>Percentage.</i>	<i>Oz. to ton.</i>		<i>Percentage.</i>	<i>Oz. to ton.</i>
La Plata .....	1.8	3	Leadville .....	11.5	10
Do .....	4.0	8	Billing & Eilers....	2.5	3
Do .....	11.8	9	Do .....	3.3	3
California .....	0.5	4.5	American .....	1.1	1
Grant .....	13.2	5	Do .....	0.75	0

*Fire assays made at the California smelter on California smelter slag from February to May, 1880, by J. E. Hardman.*

Lead, percentage ...	1.6	2.5	0.8	1.6	2.8	0.7	1.5	0.2	1.4	2.2
Silver, ounces .....	1.0	0.5	0.5	0.5	0.75	0.5	1.0	0.5	1.25	0.5
Lead, percentage ...	2.3	1.0	1.3	0.7	3.0	1.0	1.6	2.0	0.5	1.5
Silver, ounces .....	0.75	0.5	0.5	0.5	1.0	0.0	0.5	0.5	0.5	1.0

*Silver assays of Malta smelter slag, made by Robert Bunsen.*

Silver, from 10 to 17 ounces to the ton.



ASSAYS OF SLAG.

*Fire assays of slag, by Dr. M. W. Iles, made at Grant smelter.*

Smelter.	Lead.	Silver.
	<i>Percentage.</i>	<i>Oz. to ton.</i>
Grant.....	4.58	3.00
Billing & Eilers.....	3.75	3.50
Cumming & Finn..	2.00	4.75

The following table is of assays of slag and of corresponding bullion, made daily by the writer at one of the Leadville smelters, and represents the work done in each furnace in twenty-four hours.

TABLE X.—Daily slag assays.

	Furnace No.	Lead.	Silver.	Silver contents of bullion.
		<i>Percentage.</i>	<i>Oz. per ton.</i>	<i>Oz. per ton.</i>
May 30, 1880.....	1	6.7	0.0	
	2	3.7	4.5	
	3	3.7	4.0	
Square furnace ...	4	4.9	3.5	
Average .....		4.7	4.5	314.25
May 31, 1880.....	1	5.0	6.0	
	2	2.0	3.5	
	3	3.0	4.0	
	4	3.8	3.0	
Average .....		3.7	4.1	289.70
June 1, 1880.....	1	0.7	6.0	
	2	3.7	3.5	
	3	3.7	4.0	
	4	4.9	3.0	
Average .....		4.7	4.1	281.57
June 2, 1880.....	1	5.6	6.0	
	2	2.0	3.5	
	3	3.6	4.0	
	4	3.8	3.0	
Average .....		3.7	4.1	266.67
June 3, 1880.....	1	5.2	4.5	
	2	2.0	3.0	
	3	3.0	3.0	
	4	1.0	1.5	
Average .....		2.8	3.0	260.22
June 4, 1880.....	1	4.0	3.5	
	2	2.0	3.5	
	3	2.5	3.5	
	4	2.5	3.0	
Average .....		2.7	3.4	275.60

TABLE X.—Daily slag assays—Continued.

	Furnace No.	Lead.	Silver.	Silver contents of bullion.
		Percentage.	Oz. per ton.	Oz. per ton.
June 5, 1880.....	1	2.1	2.7	
	2	2.5	1.9	
	3	2.9	3.3	
	4	3.0	3.3	
	Average .....		2.6	2.8
June 8, 1880.....	1	3.5	3.2	
	2	2.5	2.8	
	3	2.7	2.5	
	4	3.1	2.8	
	Average .....		2.95	2.8
June 9, 1880.....	1	3.4	2.9	
	2	4.2	3.5	
	3	3.1	2.8	
	4	2.8	2.2	
	Average .....		3.37	2.8
June 10, 1880.....	1	3.5	6.1	
	2	2.5	3.85	
	4	2.5	3.85	
	Average .....		2.8	4.6
June 11, 1880.....	4	3.5	6.1	284.5
June 12, 1880.....	1	3.8	3.3	
	2	2.5	3.0	
	4	4.7	4.1	
	Average .....		3.7	3.5

The above figures show the influence of the numerous elements with which the smelter has to contend. The influence of the head smelter and of the furnace is indicated by the fact that Furnace No. 1 gives nearly always the slag richest in lead and silver. The influence of the silver contents of the bullion is clearly seen in the cases in which the richest slags correspond to the richest bullion. The overpowering influence of the composition of smelting charges is forcibly indicated in the cases in which poorer slags correspond to a richer bullion.

Specific gravity of slag.—At Messrs Cumming & Finn's smelter the specific gravity of slag from each furnace is determined daily. It results from a very great number of determinations made by the superintendent, Mr. MacFarlane, by means of the Jolly specific-gravity spring-balance, described in Section I, that the average specific gravity of slag varies between 3.7 and 3.8.

Dr. M. W. Hes has obtained an average of 3.691 from a hundred determinations made on unusually fine runs at the Grant smelter.

## ANALYSES XXV-XXIX.—Analyses of Leadville slag.

	XXV. <i>a</i>	XXVI. <i>a</i>	XXVII. <i>a</i>	XXVIII. <i>a</i>	XXIX. <i>b</i>
Silica .....	28.50	26.45	39.100	30.200	28.20
Protoxide of iron .....	42.20	37.11	39.085	36.186	47.07
Peroxide of iron .....	9.50	7.88			
Protoxide of manganese .....	5.21	5.20	5.023	3.813	7.13
Alumina .....	0.62	4.29	0.849	4.293	0.89
Lime .....	4.50	8.38	8.300	22.800	7.10
Magnesia .....	3.06	3.23	3.800	0.144	3.46
Oxide of lead .....	6.51	6.19	2.649	2.355	5.25
Sulphur .....	0.82	0.55	1.194	0.618	0.90
	100.92	99.28	100.000	100.409	100.00
Lead by fire assay, per cent	4.5			1.25	
Silver, ounces to the ton	3.0			1.00	
Specific gravity	3.8			3.58	

*a* Iles.*b* Hardman.

Analyses Nos. XXV and XXVI, made by Dr. M. W. Iles, are of Grant's old slags of the singulo-silicate type.

Analysis No. XXVII, made by Dr. M. W. Iles, is of a slag now made at the Grant smelter. It belongs to the acid type.

Analysis No. XXVIII, made by Dr. M. W. Iles, is that of a slag of the singulo-silicate type, made at Messrs. Billing & Eilers's smelter, with pure arragonite instead of dolomite. It is remarkable for its large percentage of lime.

Analysis No. XXIX is of a slag of the singulo-silicate type, made at the California works, and analyzed by Mr. J. E. Hardman.

From the preceding figures it will be seen that the composition of slags is well understood in Leadville, although some obscure points, such as their magnetic properties and the state in which sulphur exists in them, need elucidation, and although some metals always present in slags, such as zinc, and substances such as phosphoric and titanio acids, are not reported.

Special researches on slags made in the laboratory of the Survey.—The word *slag* seems appropriate to designate the strange products which flow from the blast furnaces during the process of lead smelting. These products are sometimes masses of large intersected crystals, brittle, with a vitreous luster; sometimes fine-grained tough masses, with a dull fracture, but always dark colored and opaque. On the other hand, the word *scoria* ought to be adopted for translucent or transparent slags. Scoria are accidentally formed in the blast furnaces, having been found by the writer in the cavities of iron sows. There is no doubt that they are regularly formed during the process of smelting, but are soon transformed into slag, so that only slag flows from the furnaces.

A rough qualitative examination was made of the scoria found intimately mixed with iron sows; the color was that of pure blende; they were translucent—almost transparent—contained no sulphur, and consisted almost exclusively of silicate of protoxide of iron and manganese, with traces only of lime and magnesia. This accidental product, which probably no one else has ever perceived in Leadville, affords a means of studying the nature of the reactions which take place in the blast furnace, and which such accidents alone can reveal.

Slags are not scorïæ. They do not belong to the type of glasses, since they are opaque<sup>1</sup> and crystalline. They are not artificial minerals, since they contain large quantities of sulphurets. Instead of belonging to some well-known type, they form one. It is only after a careful study of their nature and properties that it will be possible to attempt to give a satisfactory definition of these products.

Properties of slag.—1. Pulverized slag treated with the magnet almost always shows the presence of a magnetic portion which adheres strongly to the magnet. A slag beautifully crystallized in detached rhomboidal laminæ, with a steel-gray color and an almost metallic luster, from the La Plata smelter, could be separated by the magnet into two portions.

	Parts.
A strongly magnetic portion, amounting to.....	38
A feebly magnetic portion, amounting to.....	62
	100

But a rough examination, both quantitative and qualitative, of these two portions showed no great difference in the composition, and the investigation was carried no further in this direction.

2. The same slag finely pulverized<sup>2</sup> and treated by weak sulphuric acid (acid 1, water 4) is rapidly attacked. Sulphureted hydrogen is evolved, showing the presence of sulphides easily attacked by weak acids. The slag is, moreover, thoroughly disintegrated after a few hours. A large proportion of silica, iron, lime, magnesia, manganese, and zinc is dissolved. An unattacked residue is left; it is treated with weak nitric acid, which dissolves some sulphide of lead, formed evidently during the reaction, for it has the aspect of artificial sulphide of lead formed in the wet way. The residue is then boiled with carbonate of soda, which dissolves some gelatinous silica. A residue is still left; it is attacked a second time by weak sulphuric acid, weak nitric acid, and carbonate of soda. It is interesting to observe that after each successive treatment sulphureted hydrogen is evolved, showing that the sulphides are undoubtedly combined with silica or with silicates. After each treatment, silica, iron, lime, etc., are dissolved. These treatments are repeated until the residue consists of intensely black, fine, brilliant crystals. It is formed of pure magnetic oxide of iron, which is resolved into octahedra under the microscope. This oxide was analyzed; it contained—

Protoxide of iron.....	40.3
Peroxide of iron.....	59.7
	100.00

Its formula is  $\text{Fe}_7\text{O}_9=3\text{FeO}, 2\text{Fe}_2\text{O}_3$ , instead of  $\text{Fe}_6\text{O}_8=2\text{FeO}, 2\text{Fe}_2\text{O}_3=2\text{Fe}_3\text{O}_4$ , the formula of ordinary magnetite. It contains one equivalent of protoxide of iron more than normal magnetite. In hematite has been seen a magnetite containing an excess of peroxide of iron; here is found a magnetite formed in the midst of protoxide of iron and containing an excess of this oxide.

<sup>1</sup> The opacity of some slags is such that thin sections, prepared by Mr. Whitman Cross for microscopical examination, proved totally opaque, even under the microscope.

<sup>2</sup> Sifted slag is also very easily attacked by weak acids.

One problem is solved—the slags are magnetic, because they contain free magnetite disseminated throughout their mass; the magnetite is not combined, since it can be thus isolated in a state of purity, and it is evidently to this substance that the intense black color of slags is chiefly due. To this substance also they partially owe their opacity.

Magnetite can be isolated by a process much more simple and more rapid than the one previously described. Sifted slag is attacked in a platinum vessel by a mixture of weak nitric and hydrofluoric acids; the solution is decanted, the residue is treated with a boiling solution of caustic potash, and this residue is washed with water and weak hydrochloric acid. In a few minutes pure magnetite is isolated.

3. The pulverized slag is treated by a boiling solution of caustic potash; after a few minutes ebullition the potash is charged with sulphide of potassium, and in a few minutes more it takes the rich yellow color of persulphide of potassium. Only one among the sulphides that can possibly exist in the slags is capable of producing this reaction; it is sulphide of calcium. The existence of this sulphide, which has long been suspected and often reported, is demonstrated here beyond a doubt. Whether all the sulphur of slag exists in the state of sulphide of calcium is another question. That most of the sulphur is in that condition there is no doubt, but from the general behavior of slag, the writer is almost inclined to think that small quantities of sulphides of iron, manganese, zinc, and even lead exist there also. A great number of experiments were made to ascertain this, but in every case the presence of metallic sulphides might be attributed to secondary reactions, so they will not be described.

4. The pulverized slag is treated by a strong solution of cold potash. A considerable quantity of oxide of lead is dissolved; consequently there can be no doubt as to the state in which lead exists in slags. It is in the state of silicate of oxide.

5. Slags contain always a little chlorine, whose quantity is proportionate to the quantity of silver found; hence there is little doubt that silver exists in the slag in the state of chloride which has escaped decomposition. This fact is important because it explains why there is no relation between the quantities of lead and silver found in slag. The slag in indistinct but large crystals behaves with reagents exactly like the distinctly crystalline one; magnetite can be extracted by the processes previously described, but this oxide, instead of being crystalline to the eye, forms an apparently amorphous powder. The non-crystalline, fine-grained slags possess the same properties as the former. They are more easily attacked under the same circumstances and yield only traces of magnetite; yet they contain almost as much peroxide of iron as the former, but in this case peroxide of iron exists in the state of silicate.

Most slags in Leadville belong to the two types just described: the lustrous crystalline slag known as acid slag, which may be defined as a silicate of sulphides and oxides, colored by magnetite, and the fine-grained, non-crystalline known as basic slag, and which may be termed a silicate of sulphides and oxides, colored by sulphide of iron.

Complete analyses of slags.—The writer made the following analyses of slags, which reveal a few points which had not been observed before, such as the presence of small quantities of carbonate of lime and of carbon:

## ANALYSES XXX, XXXI, AND XXXII. SLAGS.

*Elementary.*

	XXX.	XXXI.	XXXII.
Silica .....	29. 0123	33. 845650	31. 10656
Titanic acid .....	0. 5285	0. 820000	0. 57300
Sulphuric acid.....	None	Faint trace	Trace
Carbonic acid.....	None	Trace	Trace
Phosphoric acid .....	0. 6788	0. 657828	0. 32204
Arsenious acid .....	Trace	0. 024147	Trace
Chlorine and traces Br and I (calculated)	0. 0031	0. 004686	0. 00184
Sulphur .....	1. 0110	0. 914418	1. 27277
Calcium (in the state of sulphide) .....	2. 3687	1. 143022	1. 59096
Silver .....	0. 0096	0. 014266	0. 00562
Gold .....	Marked trace	Trace	Trace
Protoxide of iron .....	44. 5226	36. 789600	34. 40836
Peroxide of iron.....	(a)	(a)	2. 71000
Magnetic oxide of iron (Fe <sub>3</sub> O <sub>4</sub> ) .....	2. 9500	3. 419000	(b)
Oxide of lead .....	6. 3138	4. 326576	3. 81746
Oxide of antimony.....	0. 0140	Trace	Trace
Oxide of zinc .....	1. 8040	2. 353500	1. 04100
Protoxide of manganese .....	2. 8606	4. 259378	1. 15720
Suboxide of copper .....	None	None	0. 04950
Lime .....	1. 9618	6. 539400	10. 28020
Magnesia .....	2. 9814	3. 671935	9. 75340
Alumina .....	1. 8427	1. 182000	2. 33500
Alkalies .....	Trace	Trace	Trace
Carbon .....	0. 0195	0. 034500	0. 07500
Total .....	100. 0024	99. 999906	99. 99991

<sup>a</sup>In magnetic oxide.

<sup>b</sup>Reported with FeO and Fe<sub>2</sub>O<sub>3</sub>.

COMPOSITION OF SLAGS.

705

ANALYSES XXX, XXXI, AND XXXII. SLAGS — Continued.

*Rational.*

	XXX.	XXXI.	XXXII.
Silica .....	29.0123	33.845650	31.10656
Titanic acid .....	0.5285	0.820000	0.57300
Protoxide of iron .....	44.5226	36.789060	34.40836
Peroxide of iron .....	None	None	2.71000
Alumina .....	1.8427	1.182000	2.33500
Lime .....	0.9221	5.761125	9.89919
Magnesia .....	2.9814	3.671935	9.75340
Alkalies .....	Trace	Trace	Trace
Oxide of zinc .....	1.8040	2.353500	1.04100
Protoxide of manganese .....	2.8606	4.259378	1.15720
Suboxide of copper .....	None	None	0.04950
Oxide of lead .....	6.3138	4.326576	3.31740
Arsenous acid .....	Trace	0.024147	Trace
Antimonious acid .....	0.0140	Trace	Trace
Phosphate of lime .....	1.0185	1.436103	0.70305
Sulphide of calcium .....	4.2997	2.057440	2.86373
Sulphate of lime .....	None	Faint trace	Trace
Carbonate of lime .....	None	Trace	Marked trace
Chloride of silver, with traces AgBr, AgI ..	0.0127	0.018952	0.00746
Gold .....	Marked trace	Trace	Trace
Magnetic oxide of iron (Fe <sub>3</sub> O <sub>4</sub> ) .....	2.9500	3.419000	(a)
Carbon .....	0.0195	0.034500	0.07500
Total .....	100.0024	99.999906	99.90991
Percentage of lead .....	5.85	4.000	3.07
Silver (ounces to the ton) .....	2.80	4.161	1.639
Gold (ounces to the ton) about .....	0.005	0.0005	0.0005

*a* Reported with FeO and Fe<sub>2</sub>O<sub>3</sub>.

No. XXX is the slag, in distinct detached crystals, from the La Plata smelter, which has already been described in the reactions of slags. No. XXXI is a sample of so-called acid slag from Cumming & Finn's smelter. This sample was made of 124 pieces of slag, each piece representing the day's work of one furnace and specimens from four furnaces being mixed together.

No. XXXII is a slag of the singulo-silicate type, taken from the heap at Messrs. Billing & Eilers's smelter. These three specimens have already been described in the investigation on the properties of slags.

Discussion.—A glance at the analyses shows:

1. That the quantity of lead is in an inverse ratio to the quantity of lime and magnesia existing in the state of silicates.
2. That there is no relation whatever between the quantities of lead and of silver left in the slag. This was shown also in the assays of slags from various sources already given. It is rendered very apparent in an assay of another slag from Billing & Eilers's smelter exactly similar to No. XXXII, which was examined very carefully by the wet way for lead and assayed for silver. It contained 2.95 per cent. of lead and 0.5833 ounce of silver, while No. XXXII contains lead, 3.07 per cent.; silver, 1.639 ounces.

This can scarcely be otherwise since lead exists in the slag in the state of combination and silver in the state of mixture.

None of the slags analyzed contains any baryta, but, as this substance has been found in some of the lead fumes condensed in the dust-chambers, it must be inferred that some of the Leadville slags contain baryta.

The slags were examined for chromium, tungsten, and vanadium, but the presence of these metals could not be detected.

Titanic acid could not be detected by the classical methods. The process used with success for its detection and estimation was the following: The slag is dissolved in a mixture of hydrofluoric, hydrochloric, and sulphuric acids, in a platinum vessel, and the whole evaporated until sulphuric acid goes off in fumes (this to expel silica). The product, dissolved in water, is treated by an excess of sulphureted hydrogen to precipitate any lead which might remain in solution. The solution is filtered and then boiled for the expulsion of sulphureted hydrogen, and then brought as nearly as possible to the neutral point by an alkali. Alumina and titanac acid are then precipitated by hyposulphite of soda, and separated and estimated as usual. With the exception of the preliminary operation needed for the preparation of the solution, the process is the same as the one which has been recommended in the analysis of hematite. The quantity of titanac acid in the hematite is insufficient to account for the relatively large proportion of this acid in the slags. In all probability the oxide of iron of the lead ore contains this substance, but some small quantities of titanate of lead may also exist in the ore, although this mineral is not known to exist. As has previously been stated, the slags from the Little Chief smelter were examined very carefully and only doubtful traces of titanac acid were detected.

Careful experiments revealed the presence of carbon in the slag, but it is not known yet in what state it occurs there. Two hypotheses are acceptable: either carbon exists in the state of graphite, a very easily mixed substance, and one which combines, so to speak, crystallographically, as in cast iron, for instance, or else in the state



of carburet of iron; it is possibly part of the carburet of iron of the iron reduced in the furnace at a certain stage of the smelting operation, and subsequently fluxed down by sulphur, arsenic, and silica. That carbon is thus liberated there is no doubt, for the writer has been able to isolate graphite blown off with the lead fumes in the chamber-dust.

Strange as it may appear, there is no doubt whatever about the presence of small quantities of carbonate of lime in the slag. This quantity is undoubtedly proportionate to the rapidity with which the furnace is run.

The large proportion of phosphate of lime in the slag, derived from the pyromorphite of the ore, is one of the causes of its opacity, it being well known that phosphate-of-lime glasses are opaque. The presence of large quantities of sulphide of calcium in the crystalline portions of the slags is another very clear indication that sulphide of calcium is really combined with the silicates, either chemically in the state of sulpho-silicate, or possibly crystallographically.

Although we are in possession of a good many facts relative to slags, it seems necessary to postpone an attempt at a rational definition of these products until we have examined the mattes of Leadville. (See observations on mattes, and final definition of slag.)

Assays of slags made in the laboratory of the Survey.—In Table XI is given the following information concerning the slags collected in Leadville and assayed in the laboratory of the Survey:

1. Reference numbers for discussion.
2. Names of the smelters.
3. Character of the slag.
4. Color of the powdered slag.
5. Remarks as to whether the slags are normal or accidental.
6. Number of specimens mixed for assay.
7. Places where the slags were collected.
8. Portions of the cakes from which the specimens were taken.
9. Assays of the slag in silver, ounces to the ton.
10. Assays of the slag in gold, ounces to the ton.

TABLE XI.—*Assays of slag.*

Where from.			Character of specimens.
Name of smelter.	Part of works.	Part of slag-cake, &c.	General composition.
1 American	Slag-heap	Core of cake	Normal.
2 do	do	Slag-cake	Accidental.
3 do	do	do	Normal accident.
4 California	do	Core of cake	Normal.
5 do	do	Detached piece	Accidental.
6 Cumming & Finn	do	Core of cake	Normal.
7 do	Laboratory	do	Do.
8 Elgin	Given by superintendent		Normal accident.
9 do	Slag-heap	Core of cake	Normal.
10 Gage, Hagaman & Co	do	do	Do.
11 Grant	New slag-heap	Cakes	Normal; new slag.
12 do	do	do	Do.
13 do	Large square furnace, running too fast.	Tap-hole	Do.
14 do	Small round furnace, running well.	do	Do.
15 do	Old slag-heap	Cakes	Normal; old slag.
16 do	Slag-pot	Shell of cake	Normal; new slag.
17 do	Same slag-pot	Interior of cake	Do.
18 Harrison	Slag-heap	Core of cake	Normal.
19 La Plata	do	Cakes	Normal accident.
20 do	do	do	Normal.
21 Leadville	do	do	Do.
22 Little Chief	do	do	Do.
23 do	do	Detached pieces	Accidental.
24 Malta	do	Cakes	Normal; old slag.
25 Ohio and Missouri	do	do	Normal.
26 do	Large furnace	Tap-hole	Do.
27 Raymond, Sherman & McKay.	Slag-heap	Core of cake	Do.
28 Billing & Eilers	do	Shell of cake	Normal, dolomitic old slag.
29 do	Smelting charge	do	Do.
30 do	Slag-heap	Core of cake	Do.
31 do	Furnace	Tap-hole	Normal.
32 do	Given by A. Eilers	Shell of cake	Normal, calcitic new slag.
33 do	do	Interior of cake	Do.
34 do	Slag-pot	Top of cake	Do.
35 do	Same slag-pot	Interior of cake	Do.

COMPOSITION OF SLAGS.

TABLE XI.—*Assays of slag*—Continued.

Character of specimens.		Assays.			
External appearance.	Color of powder.	No. of specimens mixed.	Ozs. to ton.		
			Silver.	Gold.	
Compact; fine-grained, with dull fracture.....	Grayish.....	3	1.8569	Faint trace.	1
Minute prismatic crystals.....	Yellow-white.....	1	0.95	Do.	2
Large lamellar crystals.....	Yellow-gray.....	1	0.73	None.	3
Fine, compact, and indistinctly crystalline.....	Gray-black.....	2	0.670818	Faint trace.	4
Acicular.....	Yellow-gray.....	1	0.76	None.	5
Vitreous; large indistinct crystals.....	do.....	1	6.17347	Trace.	6
Vitreous; crystalline; also compact.....	Gray-black.....	124	4.161	Do.	7
Large distinct lamellæ.....	Gray-yellow.....	1	0.6	Faint trace.	8
Compact; fine-grained.....	Blackish.....	2	4.919332	Do.	9
Vitreous; compact and indistinctly crystalline.....	Grayish.....	3	2.24	Do.	10
Vitreous; large indistinct crystals.....	Gray-yellow.....	1	5.024606	Do.	11
Vitreous; distinct crystals.....	do.....	1	4.2	None.	12
Vitreous; indistinct crystals.....	Gray-black.....	1	4.6	Do.	13
do.....	do.....	1	2.87	Do.	14
Vitreous; compact.....	Grayish.....	2	3.87	Faint trace.	15
Vitreous; indistinct crystals.....	Gray-black.....	1	2.615	Trace.	16
do.....	do.....	1	2.515	Do.	17
Vitreous; compact and indistinctly crystalline.....	Yellow-gray.....	2	1.85	Do.	18
Distinct lamellar crystals.....	do.....	2	2.8	0.005	19
Indistinctly crystalline and compact.....	do.....	2	1.4	Trace.	20
Very dense, mottled, dull, non-crystalline.....	do.....	1	10.05	Do.	21
Vitreous; indistinct crystals.....	do.....	1	3.99	None.	22
Crystalline; looks like hornblende.....	do.....	1	4.44	Do.	23
Vitreous; large, indistinct crystals.....	do.....	2	6.22	Trace.	24
Vitreous; indistinctly crystalline and compact.....	do.....	3	2.78	Do.	25
Compact; vitreous.....	Brilliant black.....	1	1.72	None.	26
Vitreous; indistinct crystals.....	Yellow-gray.....	1	4.52	Trace.	27
Compact; fine-grained; dull fracture.....	Grayish.....	1	0.554154	Faint trace.	28
do.....	do.....	1	6.5833	None.	29
do.....	Yellow-gray.....	1	1.639	Faint trace.	30
do.....	Gray-black.....	1	0.92	None.	31
Lustrous; indistinct crystals.....	do.....	9	1.47	Do.	32
Distinct prismatic crystals.....	Gray-white.....	8	0.60	Do.	33
Lustrous; indistinct crystals.....	Gray.....	1	0.15	Do.	34
do.....	do.....	1	0.36	Do.	35

NOTE.—Specimens 16 and 17 were specially prepared by Dr. M. W. Iles, and specimens 34 and 35 by Mr. A. Eilers. The slag represented by numbers 32, 33, 34, and 35 has been analyzed by Dr. Iles (see Analysis XXVIII).

*Discussion.*—Smelting is conducted so methodically in Leadville that when the writer collected the specimens of slag it was done at random, since he felt convinced that the examination which he was about to make would only furnish additional proof of the admirable method employed; but the preceding table shows that he was greatly mistaken in this anticipation. Laying aside accidental slags, and discussing only the normal ones found by thousands of tons on the refuse-slag heap, it is found that at the Grant smelter, for instance, the composition of smelting charges has been altered from the singulo-silicate type to the acid type, and with what results? The old slag-heap and the new slag-heap are several hundred feet apart—the first immediately in front of the furnaces and the second outside of the works at the bottom of California gulch—so that a mistake on the writer's part in the collection of the specimens was impossible. Now, Table XI shows that the new slag, No. 11, contains 5.1 ounces of silver, while the old slag, No. 15, contains only 3.8 ounces; and at these works it is the poorest slag that is resmelted, while the richest is carried away to an almost inaccessible spot. At Messrs. Billing & Eilers's smelter the same is remarked. It is the poorest slag, No. 29, containing only 0.5 ounce of silver, that is resmelted, while the richest, No. 30, containing more than three times as much silver, or 1.6 ounce, remains on the slag heap. The compact, fine-grained slags, which represent slags of the singulo-silicate type, are conspicuous throughout Table XI for their low contents in silver, and yet we see two of the largest smelters, those of Messrs. Cumming & Finn and Grant, adopting slags of the acid type, containing four and six ounces of silver, like Nos. 7 and 6, and four and five ounces, like Nos. 12 and 11.

The blame for this belongs somewhere, and it is probable that the superintendents are constantly misled and misguided by the assayers, chiefly for the reason that the scorification process is not to be depended upon in the assay of slag and that the crucible process ought to be substituted for it. The clearest result of an inspection of Table XI is that there is no relation whatever between either the appearance or even the composition of slag and its contents in silver, and that smelters ought to give special attention to the assay of these products.

The process of shelling out the slag, which has been described in smelter C, induced the writer to make a few experiments on the distribution of silver in the cakes of slag, and specimens 16 and 17 were prepared specially for this purpose from the same slag-pot by Dr. M. W. Hes. The shell, No. 16, contains 2.6 ounces of silver, and the poured-out portion 2.5, showing a difference of one-tenth of an ounce in favor of the shell. The difference is much larger between the top shell and the poured-out portion, as is shown by specimens 34 and 35, prepared specially from the same slag-pot by Mr. A. Eilers. The top shell contains 0.15 ounce silver and the poured-out portion 0.36 of an ounce. These two experiments seem to indicate that during the process of cooling the chloride of silver, which is only mechanically mixed in the slag, settles, in virtue of its higher specific gravity, by means of a sort of liquation. Specimens 32 and 33 point out the same results. The outer portion of the cakes of slag, in indefinite crystals, assays 1.47 ounces, and the distinct crystals, forming the inner portion or core of the cakes, 0.6. There can be no doubt about these results, since the crystals were detached from the outer portions immediately before assaying; nor can the differences be attributed to the presence of traces of bullion, for in no case did the slag contain even a trace of metallic grains. These results were not sus-

pected by the smelters, who were under the impression that there was no difference between the different parts of the same cake of slag, and who used the ingenious process of shelling out as a convenient way of breaking up the slag in small pieces before resmelting.

A comparison between specimens 28, 29, 30, and 31, or dolomitic slags, and specimens 32, 33, 34, and 35, or calcitic slags, shows that both kinds of slag contain sensibly the same amount of silver.

## CHAMBER-DUST.

The flue and chamber dust of Leadville is always in the form of a coarse reddish or blackish powder and full of very small particles of charcoal and coke.

Very little has been done in Leadville with regard to a thorough examination of these products, and all the information which could be obtained bears on the estimation of lead and silver, and occasionally of silica and iron. In the following table is condensed such information as could be obtained:

TABLE XII.—*Assays of chamber-dust.*

Smelter.	Lead.	Silver.	Silica.	Iron.	Assayer.
	<i>Per cent.</i>	<i>Oz. to ton.</i>	<i>Per cent.</i>	<i>Per cent.</i>	
California .....	30-35	20-25	.....	.....	J. E. Hardman.
Cumming & Finn .....	35	30	20	14	Hadelberg.
Elgin .....	40-60	50-150	.....	.....	
Grant .....	28	34.7	14.3	8.65	M. W. Hes.
Grant .....	20-28	34-44	.....	.....	Do.
Harrison .....	40-50	35-40	.....	.....	Th. Fluegger.
La Plata .....	30-40	40	.....	.....	.
Little Chief .....	20	44.5	16.1	11.56	M. W. Hes.
Ohio and Missouri .....	30	40	.....	.....	
Utah .....	15-35	10-25	.....	.....	

In the description of each smelter the amount of flue-dust caught and the methods of treatment of flue and chamber dust have already been given.

*Analysis.*—An examination of the flue and chamber dust of the blast furnaces of Leadville afforded such a fine opportunity for detecting most of the substances disseminated in the camp that the writer carried on quite exhaustive researches on these products, and in order not to let anything escape he treated the dust with boiling water and made a careful analysis of the soluble portion, then a careful examination of the portion soluble in acids, and lastly a complete analysis of the portion insoluble in acids. The results thus obtained are extremely complicated and present an unnatural appearance, but such as they are they give a clearer idea of the form under which the different compounds exist in the fumes, and of the reactions to which they owe their origin, and no attempt was made to simplify the reports.

The labor expended on the examination of the lead fumes was rewarded by the discovery of a new metal which appears to be distributed widely, though sparingly, throughout the camp. In the elementary analyses the earthy and alkaline metals in combination with metalloids other than oxygen have been reported in the metallic state.

Analysis No. XXXIII is that of a sample of chamber and flue dust from the Ohio and Missouri smelter. This dust had a reddish-brown tinge, due to peroxide of iron.

Analysis No. XXXIV is that of a mixture of equal parts of flue and chamber dust from the American, California, Cumming & Finn, Grant, La Plata, and Billing & Eilers smelters. The sample thus formed had a blackish color, due chiefly to fine charcoal dust.

## ANALYSES XXXIII AND XXXIV. CHAMBER DUST.

*Elementary.*

	XXXIII.	XXXIV.		XXXIII.	XXXIV.
Lead .....	25.535772	38.620520	Carbonic acid .....	1.993000	3.175120
Silver .....	0.130233	0.121200	Phosphoric acid .....	0.185484	0.487400
Gold .....	0.000100	0.000066	Titanic acid .....	0.008000	0.035000
Bismuth .....	0.013460	0.006640	Silica (from slag and silicate of lead) ..	15.128553	9.704500
Copper .....	0.003902	0.009000	Silica (from quartz and refractory		
Cadmium .....	0.017500	0.012200	silicates) .....	2.407000	3.780000
Iron .....	16.065365	13.340060	Oxygen .....	8.972380	7.019895
Manganese .....	1.478780	0.598045	Sulphur .....	0.444300	1.174000
Zinc .....	3.311400	1.303740	Selenium and tellurium .....	Traces	Marked
Arsenic .....	0.176715	0.000010			traces
Antimony .....	0.083560	0.087740	Chlorine .....	1.321600	1.200490
Tin .....	0.001180	0.001180	Bromine .....	0.244530	0.242330
Aluminium .....	0.011300	0.003000	Iodine .....	0.012660	0.012080
Calcium .....	0.235420	0.224700	Carbon (coke, charcoal, graphite) ..	9.240000	5.063000
Magnesium .....	0.022000	0.020900	Indium, thallium, new metal. ....	Traces	Traces
Potassium .....	0.026000	0.071000	Baryta .....		0.215000
Sodium .....	0.175000	0.114000	Potash .....		0.035000
Alumina .....	1.955000	2.627000	Soda .....		0.025000
Lime .....	4.107800	3.214880	Graphite .....		0.665000
Magnesia .....	0.835119	2.275000	Loss .....	0.150700	
Al <sub>2</sub> O <sub>3</sub> , Fe <sub>2</sub> O <sub>3</sub> , PbO, ZnO, CaO, MgO, K <sub>2</sub> O, Na <sub>2</sub> O (combined with SiO <sub>2</sub> ).	2.391447		Total .....	100.000000	100.003516
Water .....	0.585000	0.912500	Silver .....	37.984	35.849
Sulphuric acid .....	2.641850	2.440820	Gold .....	0.03	0.01925
			..... ounces to ton ..		
			..... do .....		

COMPOSITION OF CHAMBER DUST.

713

ANALYSES XXXIII AND XXXIV. CHAMBER DUST—Continued.

Rational.

	XXXIII.	XXXIV.		XXXIII.	XXXIV.
<i>Portion soluble in water.</i>			<i>Portion soluble in acids—Cont'd.</i>		
Protosulphate of iron .....	0.086500	0.014700	Oxide of tin .....	0.001500	0.001500
Sulphate of manganese .....	0.145000	0.158020	Selenious and tellurous acids.....	Trace	Marked trace
Sulphate of zinc .....	0.020200		Oxide of copper .....	0.005000	0.012400
Oxychloride of lead.....	0.255850	0.206310	Titanic acid .....	0.008000	0.034000
Oxybromide of lead.....	0.055000	0.045400	Alumina .....	1.955000	1.620000
Oxyiodide of lead.....	0.003000	0.002990	Carbonate of lime .....	4.529600	5.473000
Chloride of calcium.....	0.553000	0.523390	Lime .....	1.661024	
Bromide of calcium.....	0.175000	0.174660	Magnesia .....	0.835119	1.303000
Iodide of calcium .....	0.009000	0.008510	Carbonate of magnesia .....		1.464000
Chloride of zinc.....	0.120000	0.118500	Total.....	87.699450	74.677938
Chloride of aluminium.....	0.055500	0.010700	<i>Portion insoluble in acids.<sup>1</sup></i>		
Chloride of magnesium .....	0.090000	0.082900	Silica (from slag and silicate of lead)	15.126553	9.704500
Caustic magnesia.....	0.150000	0.195000	Silica (from quartz and refractory silicates) .....	2.407000	3.780000
Chloride of potassium .....	0.050000	0.140000	Al <sub>2</sub> O <sub>3</sub> , Fe <sub>2</sub> O <sub>3</sub> , PbO, ZnO, MgO, CaO, K <sub>2</sub> O, Na <sub>2</sub> O (combined with SiO <sub>2</sub> ).	2.391447	
Chloride of sodium.....	0.450000	0.290000	Carbon (from charconl, coke, and graphite) .....	9.240000	5.063000
Water .....	0.585000	0.912500	Oxide of lead.....		0.907000
Total.....	2.803050	2.883580	Oxide of zinc.....		0.100000
<i>Portion soluble in acids.</i>			Arsenious acid and oxide of anti-mony.....		Traces
Oxide of lead .....	17.816601	22.451750	Baryta .....		0.215000
Sulphate of lead .....	7.954000	8.898730	Sulphate of baryta .....		Trace
Phosphate of lead .....	1.050348	2.783600	Lime .....		0.150000
Sulphide of lead .....	1.255000	8.215000	Magnesia .....		0.080000
Chloride of lead .....	1.726700	1.725620	Alumina .....		1.007000
Bromide of lead .....	0.185790	0.185080	Peroxide of iron .....		0.600400
Iodide of lead.....	0.004900	0.004880	Oxide of manganese.....		Trace
Chloride of silver.....	0.142712	0.132730	Titanic acid .....		0.001000
Bromide of silver.....	0.037670	0.035040	Potash .....		0.035000
Iodide of silver .....	0.002580	0.002540	Soda .....		0.025000
Gold.....	0.000100	0.000066	Graphite .....		0.665000
Protosulphidic of iron.....	0.400000	0.200000	Total.....	29.165000	22.332900
Protoxide of iron .....	7.855290	6.100000	Portion soluble in water.....	2.803150	2.883580
Peroxide of iron .....	13.814050	11.491000	Portion soluble in acids.....	67.699450	74.677938
Oxide of bismuth.....	0.015000	0.101000	Portion insoluble in acids .....	29.165000	22.332900
Oxides of indium, thallium, new metal.....	Traces	Traces	Loss .....	0.332500	0.105584
Oxide of zinc .....	3.795270	1.454000	Total.....	100.000000	100.000000
Oxide of cadmium .....	0.020000	0.014000	<i>Portion soluble in water.</i>		
Sulphide of manganese .....	0.082380	Trace	<i>Portion soluble in acids.</i>		
Sulphide of zinc .....	0.300000	Trace	<i>Portion insoluble in acids.</i>		
Oxide of manganese (Mn <sub>2</sub> O <sub>3</sub> ).....	1.903500	0.750000	<i>Loss .....</i>		
Arsenious acid .....	0.233256	0.120000	<i>Total.....</i>		
Oxide of antimony .....	0.100000	0.105000			

<sup>1</sup>The quantitative analysis of the insoluble portion of Analysis XXXIII was only roughly made, but the qualitative analysis of this portion was done carefully. The bases combined with silica are the same as those combined with silica in the insoluble residue of Analysis XXXIV.

*Discussion.*—Both samples of chamber-dust were examined very carefully for fluorine. If this substance existed in the camp it is here that it would be concentrated; but no trace even was detected. Some estimations were made of both selenium and tellurium, but the results were considered as too high, and traces only are reported. The estimation of both these substances in such mixtures as those of the flue-dust is too complicated, when traces only are in question, to devote much time to it. However, both selenium and tellurium have been handled in small quantities, and the writer feels perfectly sure of their existence. He also feels assured that both exist in the state of selenious and tellurous acids. It is a somewhat singular fact that baryta was carried in the fumes in the state of silicate of baryta, a trace only of sulphate of baryta being found. One is almost tempted to come to the conclusion that certain silicates are volatile.

The sulphides of iron, zinc, and manganese were estimated by means of the quantity of sulphureted hydrogen evolved when the dust is treated by weak acids. No molybdenum could be detected, although it will be seen that it is constantly present in the blast furnaces. Cadmium could not be estimated by the classical methods, and it was in examining the zinc obtained in the course of the analysis that this metal was found. The formula of the oxychloride of lead found in the portion of the dust soluble in water is  $3PbO, PbCl_2$ , the oxybromide and iodide having the same formula.

In all probability the chloro-bromo-iodide of lead found in the portion of the fumes insoluble in water and soluble in acids exists in combination with a very large excess of oxide of lead, and also in combination with phosphate and sulphide of lead. The fumes were not examined spectroscopically for indium and thallium, so that there is some doubt about the presence of these metals. However, the writer is almost certain that he has perceived the characteristic oxysulphide of indium and observed in several instances the green flame of thallium.

The new metal which the writer was fortunate enough to observe and to trace out in all the fumes has only been seen in such minute quantities that further investigation on quite a large scale is absolutely necessary, in order to isolate it, to study its properties, and to place its existence beyond doubt. It has been possible, however, to find already three characteristic properties:

1. The oxide of the new metal gives a beautiful blue color to a bead of borax placed in the ordinary flame of the blow-pipe, and the bead becomes perfectly colorless in the reduction flame.

2. The sulphide of the new metal is slightly soluble in sulphide of ammonium, and the solution takes a characteristic blue tinge.

3. The iodide of the new metal has a fine rich pink color when in solution.

It may also be added that in one instance the sulphide of the new metal was obtained in a state of great purity, and that this sulphide was very fusible and had a deep brown color.

Although a great many substances are carried away physically in virtue of their volatility, and others mechanically by the force of the blast, it seems pretty clear from the inspection of the analyses that some very complicated reactions take place in the furnace, by means of which some substances are carried away in the state of volatile compounds and deposited in the dust in their original non-volatile form. In all probability copper, titanite acid, tin, aluminium, magnesium, and silicium are carried away



in the state of chloro-bromo-iodides and sulphides formed by the action of chloro-bromo-iodide of lead and silver, and of sulphide of lead in presence of carbon, on the non-volatile oxides. The volatile chlorides and sulphides thus formed are afterwards decomposed by water, when the steam which accompanies the fumes condenses. These reactions, which might appear doubtful from the examination of the chamber-dust alone, are forcibly demonstrated by the analysis of that portion of the fumes which is not condensed and which escapes into the atmosphere. (See Analysis XXXVI.)

Roasted dust. — At one smelter the fine and chamber dusts are roasted, previous to resmelting, in the roasting furnace, which is spoken of in the description of this smelter. This operation is probably carried on with a view to getting rid of the large proportion of arsenic which is erroneously supposed to exist in the dust. Whatever may have been the object of the superintendent of this smelter in performing this costly operation, if the composition of the chamber-dust of this smelter is comparable to that of the others, the influence of roasting on chamber-dust can be easily seen by comparing Analysis XXXV of the roasted dust with Analyses XXXIII and XXXIV.

The sample analyzed in XXXV is chiefly formed of roasted dust, but it contains also a little unroasted dust, which had been spread over the roasted dust taken out of the roasting furnace. The specimens mixed for analysis were in friable whitish and reddish masses, containing scarcely any charcoal or coke dust. The elementary analysis was made like those of the chamber-dust, and the different portions analyzed are in the following proportions:

Portion soluble in water .....	1.16583
Portion soluble in acids .....	85.48129
Portion insoluble in acids .....	13.29600
Loss .....	0.05683
<b>Total .....</b>	<b>100.00000</b>

ANALYSIS XXXV. ROASTED CHAMBER DUST.

*Elementary.*

Lead .....	53.130100	Oxygen .....	8.242172
Silver .....	0.112000	Selenium and tellurium .....	Trace
Gold .....	0.000200	Sulphur .....	0.490000
Bismuth .....	0.051420	Chlorine .....	0.094840
Zinc .....	1.479920	Potassium .....	0.054590
Cadmium .....	0.004800	Sodium .....	0.051300
Iron .....	8.891900	Alumina .....	1.144400
Manganese .....	0.551270	Lime .....	0.760240
Copper .....	0.115600	Magnesia .....	0.512200
Arsenic .....	0.210000	Potash .....	0.025000
Antimony .....	0.092940	Bromine .....	0.142420
Tin .....	0.003478	Iodine .....	0.007780
Soda .....	0.015000	Carbon (from charcoal and coke) .....	1.505000
Hygroscopic water .....	0.225000	Graphite .....	0.290000
Sulphuric acid .....	10.929000	Indium, thallium, new metal .....	Traces
Phosphoric acid .....	0.319800	Loss .....	0.056833
Carbonic acid .....	Trace	<b>Total .....</b>	<b>100.00000</b>
Titanic acid .....	0.055800	Silver .....	32.666
Silica (from slag and silicate of lead) .....	8.332000	Gold .....	0.058333
Silica (from quartz and refractory silicates) .....	1.500000		

## ANALYSIS XXXV. ROASTED CHAMBER DUST — Continued,

*Rational.*

<i>Portion soluble in water.</i>		<i>Portion soluble in acids—Continued.</i>	
Oxychloride of lead.....	0. 105970	Bromide of silver .....	0. 032270
Oxybromide of lead.....	0. 023270	Iodide of silver .....	0. 002390
Oxyiodide of lead.....	0. 001620	Oxide of cadmium .....	0. 005500
Sulphate of zinc .....	0. 016000	Gold.....	0. 000200
Sulphate of manganese .....	0. 036100	Arsenious acid.....	0. 277000
Sulphate of lime .....	0. 447440	Peroxide of iron .....	12. 026000
Sulphate of magnesia .....	0. 049050	Oxide of manganese (Mn <sub>2</sub> O <sub>4</sub> ) .....	0. 746000
Caustic magnesia.....	0. 013650	Alumina .....	1. 044000
Chloride of potassium .....	0. 083080	Carbonate of lime.....	Trace
Bromide of potassium .....	0. 032870	Selenious and tellurous acids .....	Traces
Iodide of potassium.....	0. 001370	Oxide of indium, thallium, new metal.....	Traces
Chloride of sodium .....	0. 136460	Total .....	85. 481290
Hygroscopic water .....	0. 225000		
Total .....	1. 165880	<i>Portion insoluble in acids.</i>	
<i>Portion soluble in acids.</i>		Silica (combined) .....	8. 332000
Oxide of lead .....	22. 092080	Silica (quartz) .....	1. 500000
Phosphate of lead .....	1. 826460	Oxide of lead .....	0. 690000
Sulphate of lead .....	37. 443000	Arsenious acid.....	0. 000200
Sulphide of lead .....	3. 676220	Oxide of antimony .....	0. 000300
Chloride of lead.....	2. 105760	Oxide of tin.....	0. 000100
Bromide of lead.....	0. 236140	Titanic acid .....	0. 018000
Iodide of lead.....	0. 009230	Peroxide of iron .....	0. 687000
Oxide of antimony .....	0. 117000	Alumina .....	0. 100400
Oxide of tin.....	0. 004300	Lime .....	0. 072000
Oxide of copper.....	0. 144500	Magnesia .....	0. 035000
Oxide of zinc .....	1. 810600	Oxide of zinc .....	0. 026000
Sulphate of lime .....	1. 224000	Oxide of magnesia.....	Trace
Caustic magnesia.....	0. 447200	Potash.....	0. 025000
Titanic acid .....	0. 037500	Soda .....	0. 015000
Oxide of bismuth .....	0. 057300	Carbon (from charcoal and coke) .....	1. 505000
Chloride of silver.....	0. 122640	Graphite .....	0. 290000
		Total .....	13. 296000

*Discussion.*—Everything indicates that the dust was roasted at a very high temperature, and this is proved beyond doubt by the fact that traces only of carbonic acid are detected.

On comparing this analysis with the average analysis (XXXIV) of unroasted chamber-dust, it is found that the percentage of lead is considerably increased, but that a considerable quantity of silver is lost. One notices also that the quantity of chlorine, bromine, and iodine is about half what it was in the average sample of dust. Coupling this with the loss of silver, it may justly be inferred that silver is lost in the state of chloro-bromo-iodide, and that some lead is also lost in the same form. The quantity of phosphate of lead has also diminished instead of increasing, showing that lead is also lost in this form. The percentage of arsenic and antimony is lower than in the unroasted dust, but this appears to be the only advantage gained by roasting, and a very slight one it is in these cases. Sulphur, instead of being driven off by roasting, is concentrated in the form of sulphate of lead, amounting to 37 per cent., and representing 5 per cent. of sulphur instead of 2 per cent., as in the chamber-dust. Lastly, about 9 per cent. of carbon is driven off at great expense. This carbon is so intimately mixed with the original dust that by simple heating in the blast furnace there would be more than enough of it to reduce all the lead of the fumes. In fact, everything in-

dicates that roasting chamber-dust in Leadville is a useless and a ruinous operation, by which nothing is gained and by which many valuable substances, lead, silver, fuel, etc., are lost, at great expense. It is only fair to state once more that roasting of chamber dust has only been done at one smelter. The analyses show that the mischievous substances of chamber-dust are not arsenic and antimony, but chlorine, bromine, iodine, and phosphoric acid. Analysis XXXVI, of the portion of lead fumes lost in the atmosphere, will further demonstrate this statement. *A priori*, the best way of treating lead dust and fumes is to resmelt them with an excess of lime, in order to fix the volatile constituents by combination with calcium and lime. This is precisely what is done in practice at most of the smelters, the only improvement that might be suggested being the use of pure lime instead of the magnesian lime of Leadville; but the writer thinks the general use of caustic lime instead of limestone would be of great advantage to smelting at Leadville, since the chloro-bromo-iodo-phosphates of lead are driven off in the state of fumes in the furnace, before limestone, by the loss of carbonic acid, has become caustic and thus acquired the power of acting chemically on the fumes with which it comes in contact.

Lead lost in fumes. — At the time the writer was collecting notes and specimens for this report, it happened fortunately that experiments were being made with the Bartlett smoke-filter (described on page 673), at the Grant smelter, for the purpose of condensing that portion of the lead fumes which escapes with the smoke into the atmosphere. A fine opportunity was thus had of making a thorough investigation of that part of the smelting products which is always lost at all the smelters. The analysis of these fumes proves to be the most interesting by far of all those made on lead dusts, since they are not only richer in lead than any of the others and contain more silver than the average Leadville slag, but they show also other remarkable peculiarities, as an inspection of the following analysis will show. They have exactly the appearance of soot or lampblack.

## ANALYSIS XXXVI. FUMES FROM BARTLETT FILTER.

*Elementary.*

Lead .....	60.370150	Potassium .....	0.141300
Silver .....	0.014750	Sodium .....	0.167600
Gold .....	Faint trace	Arsenic .....	1.113672
Zinc .....	4.038410	Antimony .....	0.208900
Cadmium .....	0.001310	Tin .....	0.160370
Iron .....	1.227660	Lime .....	2.756990
Manganese .....	0.311420	Magnesia .....	1.856690
Aluminium .....	0.060600	Alumina .....	0.421000
Calcium .....	0.124000	Potash .....	0.007000
Magnesium .....	0.174600	Chlorine .....	3.953590
Soda .....	0.013000	Bromine .....	0.798230
Water .....	0.912500	Iodine .....	0.043630
Carbonic acid .....	3.057510	Carbon (soot) <sup>a</sup> .....	3.305000
Phosphoric acid .....	2.038100	Indium, thallium, new metal .....	Traces
Sulphuric acid .....	0.060000	Loss .....	0.009200
Titanic acid .....	0.000500	Total .....	100.000000
Silica .....	3.279300		
Oxygen .....	3.393178	Silver .....	4.30 <sup>2</sup>
Sulphur .....	5.320540	Gold .....	Trace only
Selenium and tellurium .....	Traces		

<sup>a</sup> The soot contains also a trace of graphite.

## ANALYSIS XXXVI. FUMES FROM BARTLETT FILTER—Continued.

*Rational.*

<i>Portion soluble in water.</i>		<i>Portion soluble in acids—Continued.</i>	
Oxychloride of lead .....	3. 203400	Protosulphide of iron .....	1. 406680
Oxybromide of lead .....	0. 704600	Sulphide of zinc .....	6. 357000
Oxyiodide of lead .....	0. 348340	Sulphide of manganese .....	0. 491960
Protosulphate of iron .....	0. 057000	Sulphide of cadmium .....	0. 001500
Protochloride of iron .....	0. 537200	Arsenious acid .....	1. 470000
Protobromide of iron .....	0. 184300	Protoxide of antimony .....	0. 250000
Protoiodide of iron .....	0. 012400	Oxide of tin (SnO <sub>2</sub> ) .....	0. 203850
Sulphate of zinc .....	0. 060300	Selenious and tellurous acids .....	Traces
Chloride of zinc .....	0. 623200	Alumina .....	0. 220200
Bromide of zinc .....	0. 170000	Carbonate of lime .....	4. 853200
Iodide of zinc .....	0. 007600	Carbonate of magnesia .....	1. 760300
Sulphate of manganese .....	Trace	Canatic magnesia .....	1. 008400
Sulphate of alumina .....	Trace	Indium, thallium, new metal .....	Traces
Chloride of aluminium .....	0. 446600	Total .....	83. 884750
Chloride of calcium .....	0. 286380	<i>Portion insoluble in acids.</i>	
Bromide of calcium .....	0. 104000	Silica .....	3. 279300
Chloride of magnesium .....	0. 680670	Titanic acid .....	0. 000500
Bromide of magnesium .....	0. 020240	Oxide of lead .....	0. 142800
Chloride of potassium .....	0. 269930	Oxide of zinc .....	0. 064800
Chloride of sodium .....	0. 423930	Peroxide of iron .....	0. 034000
Water .....	0. 912500	Alumina .....	0. 200800
Total .....	9. 058650	Lime .....	0. 039200
<i>Portion soluble in acids.</i>		Magnesia .....	0. 010000
Oxide of lead .....	28. 176900	Potash .....	0. 067000
Phosphate of lead .....	11. 641800	Soda .....	0. 013000
Sulphide of lead .....	18. 899100	MnO <sub>2</sub> , AsO <sub>2</sub> , SnO <sub>2</sub> , Sb <sub>2</sub> O <sub>4</sub> .....	Traces
Chloride of lead .....	6. 341150	Carbon (soot) .....	3. 365000
Bromide of lead .....	0. 750000	Total .....	7. 096400
Iodide of lead .....	0. 032400	Portion soluble in water .....	9. 058650
Chloride of silver .....	0. 017800	Portion soluble in acids .....	83. 884750
Bromide of silver .....	0. 002060	Portion insoluble in acids .....	7. 096400
Iodide of silver .....	0. 000150	Total .....	100. 039800
Gold .....	Faint trace		

*Discussion.*—The combinations in which lead exists in these fumes and their volatility is most remarkable. To appreciate this fully one must remember that the fumes were filtered at a distance of nearly 200 feet from the blast furnace. The above analysis shows, besides 9 per cent. of chloro-bromo-iodide of lead, 18 per cent. of sulphides in combination with the chloro bromo-iodides, and 11 to 12 per cent. of phosphate of lead, proving a most surprising volatility for the two latter combinations. The percentage of lead as oxide is relatively low as compared with other dusts. It is most worthy of remark that the iron, manganese, zinc, and cadmium must be in the state of sulphides and also have an unusual degree of volatility. That these fumes should be richer in arsenious acid than the ordinary chamber dust might have been expected, but that they should have carried off tin and titanic acid is most remarkable. Silica being combined with the lead as silicate of lead shows that this combination is also volatile.

The low barometric pressure at Leadville, which is, on an average, nine inches to ten inches of mercury less than that at sea level, explains in a great measure the extraordinary volatilization of so many products; but the fact that non-volatile substances are carried away in the state of volatile compounds, and, so to speak, reprecipitated in a non-volatile form, is abundantly proved by the fact that this smoke contains chloro-bromo-iodides of calcium, magnesium, and aluminium, and still more by the fact that it contains more tin than any other. Most surprising of all is the small percentage of oxygen and the large percentage of sulphur, as compared with the amounts of both substances in flue and chamber dusts.

## SPEISS.

The speiss formed in the blast furnaces of Leadville belongs to three types: 1. The white metallic-looking speiss, in large lamellar crystals, studded all over with very small, indistinct crystals. 2. The grayish sub-metallic looking speiss, in fine crystalline grains. 3. The vesicular speiss.

It will be seen that iron sows belong also to the speiss family, being, so to speak, embryonic speiss.

A specimen of type No. 1, taken from a cake at Messrs. Billing & Eilers's smelter and made from dolomitic smelting charges, contained only a few grains of metallic lead and none of metallic iron. The lead grains were separated by the sieve, and the speiss powder being analysed gave the composition reported in Analysis XXXVII. This speiss has such a characteristic appearance that it may be assumed that similar speiss found at the other smelters possesses the same composition.

No. XXXVIII is the analysis of a sample representing type No. 2, composed of equal parts of specimens taken from different smelters, as indicated below:

Smelter.	No. of specimens for analysis.
American .....	3
Cumming & Finn .....	1
Elgin .....	1
Grant .....	1
La Plata .....	1
Little Chief .....	1
Ohio and Missouri .....	2
Billing & Eilers .....	1
Total number of specimens mixed for analysis...	11

By sifting, the speiss was separated into—

Speiss powder .....	98.21
Lead grains .....	1.22
Iron grains .....	0.57
Total .....	100.00

The non-combined iron grains did not contain any arsenic and were very tough; the lead was also very pure. The speiss powder only was analysed.

The sample of vesicular speiss was made up of equal parts of nine specimens, collected, three at the American smelter, two at the Harrison, four at the Ohio and Missouri.

By sifting, it was separated into—

Speiss powder.....	90.17
Iron grains.....	9.83
Lead grains.....	Trace
Total .....	100.00

The iron grains are also perfectly free from arsenic and very tough. The speiss powder of this sample was not analyzed, as in all probability its composition is the same as that of type No. 2; but it was assayed for gold and silver. (See speiss assay No. 5.)

*Conclusions.*—The sieve examination of speiss shows: 1. That speiss type No. 1 contains no free iron and is a non-saturated speiss. 2. That speiss type No. 2 contains just enough iron in excess to indicate that it is saturated with iron. 3. Lastly, vesicular speiss type No. 3 contains a very large excess of free iron. It is a supersaturated speiss, whose fusion has been prevented by this excess of infusible iron.

The writer made three comparative experiments on the fusibility of the three kinds of speiss. In each case the pulverized speiss was mixed with borax in a porcelain crucible, heated over the blast-lamp, properly regulated to operate as nearly as possible in the same conditions. Speiss types No. 1 and No. 2 melted easily, and no appreciable difference could be detected in their melting point. Speiss type No. 3 was melted with more difficulty than the preceding and formed a vesicular button, showing incomplete fusion.

ANALYSES XXXVII AND XXXVIII. SPEISS.

	XXXVII.	XXXVIII.
Sulphur .....	5.8101	4.4695
Arsenic.....	81.4725	21.8903
Antimony .....	Trace	0.1450
Iron .....	60.5780	70.4780
Zinc .....	Faint trace	Trace
Silver.....	0.0085	0.0301
Gold.....	Faint trace	0.0009
Lead.....	1.4935	2.5030
Copper .....	0.3628	0.2566
Nickel.....	0.0876	0.0961
Molybdenum .....	0.2110	0.2155
Loss .....		0.0030
Total .....	100.0330	100.0000
Silver..... ounces to ton..	2.48	8.7822
Gold..... do.....	Trace	0.26

*Discussion.*—The formula of the large crystalline speiss analyzed in XXXVII is  $(\text{FeM})_6\text{AsS}$ , M designating the small quantities of metals accompanying iron, and the rational formula is probably represented by  $\text{Fe}_6\text{As}(\text{FeM})\text{S}$ .

The fine-grained speiss analyzed in XXXVIII is represented by the formula  $(\text{FeM})_9\text{AsS}$ , and probably by the rational formula  $\text{Fe}_9\text{As}(\text{FeM})\text{S}$ .

The powder of the vesicular speiss was not analyzed, as has been stated before, but it is probable that its composition and formula are the same as that of the preceding, since both are saturated speiss and contain an excess of non-combined iron. However, both cannot be considered as mere mixtures of definite arsenio-sulphurets of iron and iron, for both the iron and the arsenio-sulphuret are crystalline, and they are in all probability crystallographic compounds.<sup>1</sup> It has been seen that slags were similarly crystallographic compounds. It will be seen that mattes also are crystallographic compounds. A few remarks will be made with regard to slag-mattes, which form the highest expression of this class of substances, so that in almost every stage of the smelting operations crystallographic compounds are the regular products of the blast furnaces.

The speisses analyzed are remarkable on account of—

1. The presence of antimony in such very small quantities, whilst it exists in the smelting charges, and is formed in no inconsiderable quantity in the bullion, the fumes, etc.

2. The presence of molybdenum in each and sensibly in the same amount, showing how widely and evenly distributed this metal is in the camp. In the writer's opinion it is the first time molybdenum has been pointed out in speiss. It is so thoroughly concentrated in this product that it was not possible to detect it in either bullion, slag, or fumes.

3. The total absence of cobalt, which, as has been observed, is concentrated in the skimmings of the lead of the siphon-tap, and thus thoroughly separated from nickel, which, as the preceding analyses show, remains in the speiss.

Assays of speiss for gold and silver.—In order to complete the study of the Leadville speiss, the following assays were made of speiss belonging to the three different types in the Survey laboratory:

TABLE XIII.—*Assays of speiss.*

No.	Smelters.	Nature of speiss.	No. of specimens mixed for assay.	Silver <i>Oz. to ton.</i>	Gold. <i>Oz. to ton.</i>	
1	Billing & Eilers.....	Type No. 1.	1	2.48	Trace	
2	do.....		3	11.95	Trace	
3	Cumming & Finn.....		3	15.25	0.066	
	Elgin.....		3			
	La Plata.....		3			
Average assay of type, No. 1.....				9.803	0.022	
4	Little Chief.....		Type No. 2..	1	8.7822	0.26
	La Plata.....	1				
	Grant.....	1				
	American.....	3				
	Billing & Eilers.....	1				
	Cumming & Finn.....	1				
5	Elgin.....	Type No. 3..	1	40.655	0.0479	
	Ohio and Missouri.....		2			
	American.....		3			
	Harrison.....		2			
	Ohio and Missouri.....	4				

<sup>1</sup> Exactly what Mr. Guyard means by the term *crystallographic compounds* I am not able to state. (S. F. E.)

To complete this examination the powder and metallic grains of vesicular speiss No. 5 were tried separately, with the following results:

	Silver.	Gold.
	<i>Oz. to ton.</i>	<i>Oz. to ton.</i>
Speiss powder . . .	43.705	0.045
Metallic grains . . .	12.675	0.075

*Discussion.*—It has been seen that types No. 1 and No. 2 contain sensibly the same amount of precious metals, but why type No. 3 should contain such a large quantity of silver as 40 ounces the writer is not prepared to explain. The fact that the silver is contained, not in the metallic grains, as might have been supposed, but in the speiss itself, renders the explanation more difficult yet.

Speiss No. 2 (type No. 1), from Messrs. Billing & Eilers's smelter, was made in connection with dolomitic slag. The difference in the contents of silver is very large, and is probably due to a corresponding difference in the assay of the bullion extracted at the same time.

#### IRON SOWS OR SALAMANDERS.

The sows, or small masses of reduced metallic iron, which are formed occasionally in the blast-furnaces, on being analyzed prove to be a variety of speiss. The writer expected some important results from their examination, for the reason that metallic iron reduced in the blast-furnaces becomes the center of the most important chemical reactions, and that here was an opportunity of observing the various components of the smelting charges in the very act of combination.

The sample submitted to analysis was prepared from a great variety of specimens—two from the Little Chief, three from Gage, Hagaman & Co., and four from the California smelter.

The specimens from the California smelter were taken from three sows of very tough metal, and measuring 1 foot 6 inches by 10 inches by 1 foot, and also 1 foot 6 inches by 10 inches by 5 inches. One of these sows was impregnated with the peculiar slag which has been described under the name of scoria. One of the specimens of reduced iron was extracted in small bits from the very midst of a slag, where it was found side by side with small bits of speiss, which were perfectly fused, but which had not had time to collect together. A similar specimen was extracted from a slag found at the Little Chief smelter. All the specimens of sows were full of large cavities, filled with charcoal, coke, slag, scoria, and regular speiss. The sample analyzed was prepared by pounding bits detached from the sows until no dust could be obtained, so that it is the toughest portion of the sows that has been analyzed. The metal forming the sows is sometimes rather brittle, but is also often very tough. Tough or brittle, however, when broken it exhibits a decidedly crystalline structure, the crystals being almost large enough to be measured, and the metal itself is perfectly white and bright.



## ANALYSIS XXXIX. IRON SOW.

Iron .....	72.82830	Silver .....	0.11492
Lead .....	18.79340	Gold .....	0.00003
Arsenic .....	5.06330	Phosphorus .....	0.10905
Nickel .....	0.04500	Graphite .....	0.75000
Cobalt .....	Faintest trace	Combined carbon .....	0.55000
Manganese .....	0.01500	Silicium, slag, loss .....	0.90000
Antimony .....	Faint trace	Total .....	100.00000
Copper .....	Faint trace	Silver .....	33.51750
Zinc .....	Faintest trace	Gold .....	0.00875
Molybdenum .....	0.16100		
Sulphur .....	0.65000		

<sup>a</sup>In order to obtain a fair average assay of silver and gold the assay was made on 200 grams, which explains why gold is given to the  $\frac{1}{100000}$  of an ounce to the ton.

Analysis XXXIX shows that the sows are an alloy of iron and lead combined with a quantity of arsenic sufficient to class them with speiss. Like the latter, sows contain nickel, molybdenum, and sulphur. Their graphite is liberated when their iron enters into combination with larger quantities of sulphur and arsenic, and is blown away with the lead dust where it has been found. Like supersaturated speiss, sows are very rich in silver. The fact that they contain traces of cobalt, which cannot be detected in speiss, shows that this metal is forcibly taken away by virtue of a reaction which is not yet understood, although one is inclined to presume that sulphide of cobalt is formed, and that it combines more readily with sulphide of lead than with arsenide of iron.

## MATTES.

The examination of the mattes of Leadville proved so surprising to the writer that he accumulated all possible proofs in order to have no doubts as to their nature. It will be seen that they are formed of sulphides of iron and lead and magnetic oxide of iron. It was in order to demonstrate the presence of this oxide that experiments and reactions were varied in every possible way, which were discarded afterwards, and became useless when the magnetic oxide of iron was successfully isolated in the pure crystalline state. Thus mattes are formed of sulphides and oxides, and, like most furnace products, they are *crystallographic combinations of chemical compounds*.

A careful examination was made of the two typical kinds of mattes of Leadville. The so-called iron matte, with a fine crystalline structure and a brown luster, was collected at Messrs. Cumming & Finn's smelter (Analysis XI). The so-called lead matte, blackish gray, with a decided crystalline structure, was found at the Elgin smelter (Analysis XII). Both specimens were slightly swollen and split by a beginning of oxidation. Both yield strongly magnetic particles to the magnet, which were at first mistaken for magnetic sulphides. By rubbing the magnetic portion on filter paper, isolating with the magnet, repeating the operation several times, and finally treating it with nitric acid, in order to destroy some sulphides which adhere to it, the pure magnetic oxide is obtained. Whether the adhering sulphides are magnetic or not could not be decided. The pure magnetic oxide was not analyzed, but there is but little doubt that its formula is the same as that of the oxide isolated from slags, namely,  $Fe_3O_4$ .

## ANALYSES XL AND XLI. MATTES.

*Elementary.*

	XL.	XLI.		XL.	XLI.
<i>Portion soluble in water.</i>			<i>Portion soluble in acids.—Cont'd.</i>		
Sulphuric acid .....	0.037895	0.030	Gold .....	Faint trace	Faint trace
Protoxide of iron .....	0.034105	0.028	Zinc .....	1.143700	0.220
Water .....	Trace	Trace	Copper .....	0.278277	0.855
<i>Portion soluble in acids.</i>			Arsenic .....	0.219906	0.131
Sulphur .....	24.257340	19.350	Antimony .....	Trace	0.270
Oxygen .....	4.500000	6.230	<i>Portion insoluble in acids.</i>		
Iron .....	48.906300	40.430	Slag .....	0.137000	0.140
Nickel .....	None	0.067	Loss .....	0.093811	0.030
Lead .....	20.100000	31.970	<b>Total</b> .....	<b>100.000000</b>	<b>100.000</b>
Silver .....	0.291666	0.240	Silver.....ounces to ton..	85.067	69.9084

*Rational.*

	XL.	XLI.		XL.	XLI.
<i>Portion soluble in water.</i>			<i>Portion soluble in acids.—Cont'd.</i>		
Protosulphate of iron .....	0.072000	0.058	Sulphide of antimony .....	Trace	0.376
<i>Portion soluble in acids.</i>			Sulphide of silver .....	0.334875	0.275
Protosulphide of iron .....	56.151956	37.440	Sulphide of gold .....	Trace	Trace
Sulphide of lead .....	23.192307	36.912	Iron (combined with FeS <sub>2</sub> ) .....	1.360730	Trace
Magnetic oxide of iron .....	10.312500	22.826	<i>Portion insoluble in acids.</i>		
Sulphide of zinc .....	1.706700	0.330	Slag .....	0.137000	0.140
Sulphide of nickel .....	None	0.102	Loss .....	0.093811	0.030
Sulphide of copper .....	0.347846	1.282	<b>Total</b> .....	<b>100.000000</b>	<b>100.000</b>
Sulphide of arsenic .....	0.290275	0.214			

The writer has described in the Bulletin de la Société Chimique de Paris a peculiar mineral formed of arsenic sulphuret of nickel and chrome-iron oxide, which certainly presents a great analogy with the mattes.

Lead and iron mattes are not the only ones which form in the furnace. A third one, which is much more interesting, may be called the calcium matte. This matte is formed, like its congeners, of a sulphide, sulphide of calcium, and of magnetic oxide of iron, crystallographically combined. This matte has not been found in an isolated state, but it exists in combination with scoriæ, and the product thus formed is precisely the slag of Leadville. So that the best definition of slags that can be given is the following: Slags are compounds of scoriæ or silicates and of calcium mattes, and, like most of the furnace products, they are formed of chemical compounds crystallographically combined.<sup>1</sup>

<sup>1</sup> Although Mr. Guyard's definition may perhaps seem somewhat obscure to the reader, I do not feel sufficiently certain of his meaning to attempt to modify it, and therefore leave it in his own words. (S. F. E.)

Assays of mattes. — Crude mattes generally contain variable quantities of metallic grains, so that whenever it was thought advisable the crude matte was assayed, as well as the powder and metallic grains separated by the sieve. The following assays were made in the laboratory of the Survey.

TABLE XIV. ASSAYS OF MATTES.

Matte.	No. 1.	No. 2.	No. 3.	No. 4.
Separates into—				
Powder .....	51.37	98.62	79.32	97.5
Metallic grains .....	48.63	1.38	20.68	2.5
	100.00	100.00	100.00	100.00
<i>Silver contents.</i>				
Crude matte ... ounces per ton.	102.7344	Not assayed	09.0256	Not assayed
Powder .....	45.47	74.35	86.63	66.25
Metallic grains .....	163.22	Not assayed	146.6	Not assayed
<i>Gold contents.</i>				
Crude matte ... ounces per ton.	0.02743	Not assayed	0.03	Not assayed
Powder .....	0.025	Faint trace	0.03	Trace
Metallic grains .....	0.030	Not assayed	0.03	Not assayed

No. 1. American smelter, lead matte.

No. 2. Billing & Eilers's smelter, lead matte, blackish gray.

No. 3. Cumming & Finn's smelter, lead and iron matte.

No. 4. Elgin smelter, lead matte, grayish.

*Discussion.* — It has been seen (Analysis XL) that the normal iron matte contains 85 ounces of silver, and that (assay of mattes No. 3) the powder of a similar matte from the same smelter contains 86½ ounces. The normal lead matte (Analysis XL1) contains 70 ounces of silver, and the powder from similar mattes at the same and at other smelters contains 66.25 ounces of silver (No. 4), 45.5 ounces (No. 1), 74.35 ounces (No. 2).

The relation between the contents of bullion (represented by the metallic grains) in silver and the contents of the mattes in silver is rather peculiar. In No. 1, the richest bullion, 163 ounces, corresponds to the poorest matte; and in No. 3, the poorest bullion, 146½ ounces, accompanies the richest matte, 86 ounces. Evidently there is an antagonism between matte and bullion, in which the latter has not always the advantage.

#### ACCRETIONS.

There are two kinds of accretions formed in the blast furnace which have nothing in common: the hearth accretions and the shaft accretions.

Hearth accretions. — Hearth accretions are, in general, very similar to mattes, but sometimes they look more like slags. From a very rough examination of these products, it results that they are chiefly formed of slag, and lead- and iron-matte, and it is thought that the word *slag-matte* is the most appropriate to designate them. They are formed of variable quantities of slag and matte, but often contain nearly equal parts of both, and represent in the highest degree those singular compounds, crystallographically combined, which have been described so often in this report.

The writer has not pursued further the investigations of these hearth accretions for the reason that the elements which constitute them have already been fully examined and discussed. The following assays were made however, in the same manner as those of the mattes:

TABLE XV. ASSAYS OF HEARTH ACCRETIONS FROM GRANT SMELTER.

Accretions.	No. 1.	No. 2.
Separates into—		
Slag-matte powder .....	77.51	63.06
Metallic grains .....	22.49	36.94
	100.00	100.00
<i>Silver contents.</i>		
Crude hearth accretion ..... ounces per ton.	47.6916	81.6473
Slag-matte powder ..... do .....	28.8	16.125
Metallic grains ..... do .....	112.8	103.56
<i>Gold contents.</i>		
Crude hearth accretion ..... ounces per ton.	Trace	Trace
Slag-matte powder ..... do .....	Trace	Trace
Metallic grains ..... do .....	Trace	Trace

*Discussion.*—The assay of silver in the slag-matte indicates to some extent the relative proportion of slag and matte in the hearth accretion, it being evident that No. 1 contains more matte than No. 2. The fact that the poorest bullion, No. 1, corresponds to the richest accretion, and the richest bullion, No. 2, to the poorest accretion, confirms the similar observation made on the mattes, and seems to indicate that bullion is deprived of its silver by the matte.

*Shaft accretions.*—As has already been stated, the shaft accretions have nothing in common with hearth accretions. Shaft accretions generally result from the condensation of sublimated products. They form thick incrustations against the lower parts of the walls of the shaft of blast-furnaces, and occasionally line the whole of the shaft. At Gage, Hagaman & Co.'s the writer has seen a small round furnace entirely lined, from the top of the water-jackets to within six inches of the feed-hole, with accretions a foot thick. A very complete collection of those products was made, as it was expected that in them would be found a great concentration of the metals which occur in minute quantities in the ores.

Before describing normal accretions the writer would say a few words concerning some pretty yellowish semi-translucid crystals of chloro-bromide of lead found by Dr. M. W. Iles in one of the furnaces at Grant smelter, between the main cast-iron plate support of the furnace and the masonry. These crystals were analyzed by Dr. Iles and found to contain—

Chlorine .....	10.345
Bromine .....	25.321
Lead .....	63.927
	<hr/>
	99.593

A small quantity of the crystals were kindly forwarded to the writer by Dr. Iles, and were examined qualitatively; in these were found, besides chloride and bro-

mide of lead, a small quantity of iodide of lead. They appeared, moreover, to have the same composition as the chloro-bromo-iodide of lead which was found by the writer in the lead dust; in which case they would contain more chlorine than bromine and more bromine than iodine; but being crystallized it is very possible that they have the composition assigned to them by Dr. M. W. Iles and the formula  $Pb Br Cl$ . These crystals form quite an accidental accretion, and are found only in very small quantity.

The normal accretion, the one found in every smelter and in every furnace, is a light crystalline fibrous and porous mass with a luster like galena and full of cavities, spotted with a whitish-yellow and reddish crust. The fibrous portion is formed of alternate layers of galena-like and of yellowish-white crystals. No metallic grains can be seen in the mass of the accretion, even when broken into very small bits; but, while some parts are quite brittle, others have a toughness which is due to the presence of metallic lead. A similar accretion, collected at Messrs. Billing & Eilers's smelter, was separated by the sieve into powder, 81.25; lead grains, 18.75.

The whole accretion, powder and grains, was analyzed in the above proportion and found to contain, among other substances, an enormous quantity of metallic lead; more than twice as much as the quantity represented by the lead grains. This lead is evidently condensed vapor of this metal or sublimated lead, so intimately mixed with the sulphides that it passes through the sieve.

Another point of interest is the large percentage of sulphide of zinc found, which forms the yellowish white crust and layers visible in the accretion already mentioned.

The following is the analysis of a typical shaft accretion collected at Messrs. Billing & Eilers's smelter.

## ANALYSIS XLII. SHAFT ACCRETION.

*Portion soluble in acids*

Elementary analysis.		Rational analysis.	
	<i>Per cent.</i>		<i>Per cent.</i>
Sulphur .....	8.2012730	Sulphide of lead .....	7.20498.0
Lead .....	47.4912340	Sulphide of bismuth .....	Trace
Bismuth .....	Trace	Sulphide of silver .....	0.0860238
Silver .....	0.0754498	Sulphide of gold .....	Trace
Gold .....	Trace only	Sulphide of copper .....	Trace
Copper .....	Trace	Sulphide of zinc .....	10.4124000
Zinc .....	6.9774000	Sulphide of cadmium .....	Marked trace
Cadmium .....	Marked trace	Protosulphide of iron .....	10.6129000
Iron .....	6.7536000	Sulphide of arsenic .....	0.0644000
Arsenic .....	0.0392689	Sulphide of antimony .....	Trace
Antimony .....	Trace	Metallic lead .....	41.2469180
Sulphuric acid .....	0.9653590	Sulphate of lime .....	1.6411163
Phosphoric acid .....	2.1663252	Phosphate of lime .....	4.6937046
Carbonic acid .....	Trace	Carbonate of lime .....	Trace
Lime .....	4.2016000	Caustic lime .....	1.0584693
Magnesia .....	3.2021540	Caustic magnesia .....	3.2021540
Oxide of manganese .....	2.8871860	Oxide of manganese .....	2.8871860
Alumina .....	0.0720000	Alumina .....	0.0720000

## ANALYSIS XLII. SHAFT ACCRETION — Continued.

*Portion insoluble in acids.*

Elementary analysis.		Rational analysis.	
	<i>Per cent.</i>		<i>Per cent.</i>
Silica .....	10.1000000	Silica .....	10.1000000
Oxide of lead .....	0.4050000	Oxide of lead .....	0.4050000
Oxide of zinc .....	0.3000000	Oxide of zinc .....	0.3000000
Oxide of iron .....	1.1000000	Oxide of iron .....	1.1000000
Oxide of manganese .....	Trace	Oxide of manganese .....	Trace
Alumina .....	1.6000000	Alumina .....	1.6000000
Lime .....	2.1000000	Lime .....	2.1000000
Magnesia .....	1.0950000	Magnesia .....	1.0950000
Loss .....	0.1171501	Loss .....	0.1171501
Total .....	100.0000000	Total .....	100.0000000

Silver, 22 ounces to the ton; gold, trace only.

*Discussion.*—The points of interest in this analysis are the concentration of phosphoric acid in the form of phosphate of lime, the presence of caustic lime, and the presence of 22.3 per cent. of metallic lead in an impalpable form. A glance at the whole analysis shows the close resemblance between accretions and chamber-dust, the former representing products of sublimation, the latter products of volatilization.

*Assays of normal accretions.*—The writer prepared a sample of accretions identical in appearance with the one reported above and made up of twelve specimens from the following smelters:

Cumming & Finn .....	7
Grant .....	1
Harrison .....	1
Gage, Hagaman & Co .....	3
Total number of specimens mixed for assay .....	12

The powder and grains in this mixture were separated, as usual, by the sieve.

The whole accretion assayed 21.1092 ounces of silver to the ton. The specimen analyzed assayed 22 ounces, showing a remarkable uniformity in the composition of these products from various sources. The accretion powder assayed 21 ounces and the accretion grains 23.6 ounces of silver to the ton. This last figure is very interesting, as showing the contents in silver of volatilized bullion. There can be no doubt about this, since the accretions assayed come precisely from smelters which run the richest and the poorest bullion; besides, if we consult the assays of lead grains found in other products (the mattes and hearth accretions, for instance), we find that in no instance do lead grains contain so little as 23 ounces of silver.

In connection with the normal accretions just described will be given the assay of common accretions, which differ entirely from the preceding. Instead of being light and porous, they are very heavy and compact, and consist either of galena which has escaped reduction or of artificial galena formed in the furnace by the reduction of

sulphate of lead. Whatever their origin, they are formed of galena. The sample assayed was prepared from five specimens from the following smelters:

Cumming & Finn .....	2
Grant .....	2
Raymond, Sherman & McKay .....	1
Total .....	<u>5</u>

The whole accretion assayed 45 ounces of silver to the ton. It was separated by the sieve into—

Powder .....	91.25
Metallic lead grains .....	8.75
Total .....	<u>100.00</u>

The powder assayed 35 ounces and the grains 148.5 ounces to the ton.

When mattes and accretions are not thrown away pell-mell with the slags, they are always roasted in heaps in Leadville. A mixture of such roasted mattes and accretions from Billing & Eilers's smelter was assayed; it consisted of two fine specimens, yellowish-white and reddish on the surface, full of large cavities, and having a blackish fracture; free sulphur was visible throughout the mass. It was separated by the sieve into—

Powder .....	97.96
Grains .....	2.04
Total .....	<u>100.00</u>

The powder assayed 8.25 ounces of silver to the ton.<sup>1</sup>

If we consider that the products roasted assayed 22.45 ounces (accretions), 102, 74.5, 99, and 66 ounces (mattes), respectively, we may well ask, what becomes of the silver in this ruinous operation of roasting in heaps performed at several smelters? A definite answer is difficult, since if silver is volatilized it is not known in what form; but it seems probable that, since the roasting takes place in the open on the slag-heap and the roasting heap is periodically leached by rain, silver may be carried away in the state of sulphate.

Peculiar accretions.—The following analysis has been made of a very peculiar accretion found at Messrs. Cumming & Finn's smelter. This accretion is half black and half yellow and looks like a mixture of galena and orpiment. It was separated by the sieve into—

Powder .....	75.54
Lead grains .....	24.46
Total .....	<u>100.00</u>

The whole accretion, powder and grain, was analyzed (see Analysis XLIII), and more interesting results than those obtained could scarcely have been anticipated. The bright-yellow portion proved to be a peculiar Naples yellow formed of arsenio-antimonio-stannate of lead; and the whole of the constituents of that portion were in the state of oxides. Here we find a most remarkable instance of concentration, that of tin, which apparently exists only in traces throughout the camp, and that of anti-

<sup>1</sup> All the assays of accretions were made in the laboratory of the Survey.

mony and arsenic, which exist only in small quantities in the ores. This accretion contains tin, 5.6 per cent.; antimony, 2.7 per cent.; and arsenic, 5 per cent.

The behavior of this accretion with reagents is noteworthy: treated by weak nitric acid the metallic grains and sulphides, as well as the excess of the oxide of lead, are dissolved and the yellowish compound is left untouched. This residue, treated by strong nitric acid, yields arsenite of lead, which dissolves in the state of arseniate. The residue, which is still yellow, is decomposed by sulphide of ammonium, which dissolves tin. The residue, treated by weak nitric acid, in order to dissolve the sulphide of lead formed, leaves behind a yellow powder, which proves to be antimoniate of lead. The separations in this instance are so remarkable that the relative proportions of arsenite, antimoniate, and stannate of lead forming the yellow compound could in this way be roughly estimated.

## ANALYSIS XLIII. PECULIAR ACCRETION.

Elementary analysis.		Rational analysis.	
Lead .....	70.63110	<b>Metallic grains:</b>	
Silver .....	0.20700	Lead .....	23.72921
Gold .....	0.00075	Silver .....	0.19800
Arsenic .....	5.00925	Arsenic .....	0.02500
Antimony .....	2.09686	Antimony .....	0.05500
Tin .....	5.50341	Tin .....	0.23100
Iron .....	0.02800	Sulphide of lead .....	0.21913
Zinc .....	Trace	<b>Sulphides—</b>	
Sulphur .....	2.00067	Sulphide of iron .....	0.04400
Oxygen .....	6.25617	Sulphide of silver .....	0.11300
Peroxide of iron .....	3.45000	Sulphide of lead .....	18.90927
Alumina .....	0.60600	<b>Oxide of lead compounds—</b>	
Silica .....	2.83000	Oxide of lead .....	32.02459
Loss .....	0.00067	Oxide of zinc .....	Trace
<b>Total .....</b>	<b>100.00000</b>	Arsenious acid .....	6.57900
Silver .....	86.623	Antimonious acid .....	3.50800
Gold .....	0.21875	Stannic acid .....	6.81006
		Oxide of gold .....	0.00075
		Silicic acid .....	2.83000
		Alumina .....	0.60000
		Peroxide of iron .....	3.45000
		Loss .....	0.00067
		<b>Total .....</b>	<b>100.00000</b>

*Discussion.*—The rational report may be expressed under the simple form:

Metallic grains .....	24.45734
Metallic sulphides .....	19.12693
Oxide of lead compounds .....	56.41506
Loss .....	0.00067
<b>Total .....</b>	<b>100.00000</b>

The writer has found that silicic acid, alumina, and peroxide of iron were combined with oxide of lead in the state of silicate, aluminate, and ferrite; as for gold, it is a well-known fact that this metal is oxidized by oxide of tin and combines with it.



Peculiar accretion found at Gage, Hagaman & Co.'s smelter.—This accretion was a thin, compact, yellowish-green mass of alternate layers of sulphide of lead and yellowish-green oxides; it contained only a very few grains of lead in fine particles. This accretion is remarkable on account of the enormous quantity of zinc concentrated in it (53 per cent.), chiefly in the state of oxide (65.5 per cent.). It is also the only accretion in which were found traces of chlorine, bromine, and iodine. The rational report of the analysis has been arranged so as to show as clearly as possible how the different substances are mixed or combined. Sulphide of zinc was estimated by means of the sulphureted hydrogen evolved on treating the accretion with weak sulphuric acid. No iron was present in the solution.

Traces of the silver reported as chloride exist in the state of sulphide.

ANALYSIS XLIV. PECULIAR ACCRETIONS.

Elementary analysis.		Rational analysis.	
	<i>Per cent.</i>		<i>Per cent.</i>
Lead .....	25.9530	Sulphide of lead.....	17.8005
Zinc.....	53.3294	Sulphide of zinc.....	1.0670
Silver .....	0.0044	Mixture—	
Chlorine with traces Br, I.....	0.0350	Oxide of zinc.....	65.5550
Sulphuric acid.....	0.2866	Sulphate of lead.....	1.0891
Arsenious acid.....	0.0715	Oxide of lead.....	10.5341
Antimonious acid.....	0.0565	Arsenious acid .. } in combination.....	0.0715
Oxygen.....	13.7513	Antimonious acid }.....	0.0565
Sulphur.....	2.7254	Chloride of lead, with traces PbBr, PbI.....	Traces
Peroxide of iron.....	1.3815	Chloride of silver, with traces AgBr, AgI.....	0.1294
Alumina.....	0.3285	Peroxide of iron (mixed, not combined).....	1.3815
Lime.....	0.2007	Alumina.....	0.3285
Magnesia.....	0.1588	Lime.....	0.2007
Silica.....	1.5770	Magnesia.....	0.1588
Loss.....	0.0504	Silica.....	1.5770
Total.....	100.0000	Loss.....	0.0504
Silver..... ounces to ton..	27.5327	Total.....	100.0000
Gold.....	Trace only		

SECTION V.

THEORETICAL DISCUSSION.

REACTIONS IN THE BLAST-FURNACES.

To form a correct conception of the metallurgical reactions in the blast-furnaces of Leadville we must take into consideration—

(1) The great altitude at which the smelting operations take place, which modifies to a considerable extent the volume of the blast and the volatility of volatile compounds.

(2) The manner in which the smelting charges are disposed in the furnace. It has been seen already that the ores and fluxes are placed between two layers of fuel, so that in all the zones of the furnace above those of agglomeration and fusion the reactions take place by actions of gases upon solid substances, and that in a very limited space only reactions by contact of solid matter can take place.

- (3) The elements of the blast: Oxygen, nitrogen, moisture, and carbonic acid.
- (4) The elements of the fuel: In coke, carbon, moisture, a little sulphide of iron, and a considerable quantity of ash, formed of silica, alumina, lime, and oxide of iron; in charcoal, carbon, moisture, and a little ash, composed of alumina and alkaline carbonates.
- (5) The elements of dolomites: Carbonic acid, lime, magnesia, with small quantities of iron and other substances.
- (6) The elements of hematite: Peroxide of iron, protoxide of iron, carbonate of iron, with small quantities of other substances.
- (7) The elements of the ores: Carbonate of lead, sulphide of lead, sulphate of lead, pyrite, oxides of iron and manganese, chlorophosphate of lead, chloro-bromiodide of silver, gold, zinc, titanite and molybdic acids, and arsenic and antimonite acids, with small quantities of cobalt, nickel, and other substances.

The examination of the furnace products, which has already been made, affords means of pointing out with precision what becomes of the elements introduced in the furnace. The analyses of slag, bullion, speiss, dust, and mattes are fair representatives of the complete or normal reactions of the furnace, and those of hearth and shaft accretions, of incomplete or accidental reactions. But before entering into these considerations it is necessary to pass in review the principal reactions of lead, silver, and iron compounds, and to study their action upon each other and upon the chief ingredients either used in smelting or produced by smelting. At the same time stress will be laid upon the reactions that are represented by specimens found in the furnaces of Leadville and kept for reference in the collections of the Geological Survey, and also upon the reactions which were revealed by analysis.

#### REACTIONS OF LEAD COMPOUNDS.

No. 1. Reactions of carbonate of lead.—Carbonate of lead loses its carbonic acid between 170° C. and 200° C. (J. A. Phillips),<sup>1</sup> and is converted into protoxide of lead.

No. 2. Reactions of protoxide of lead.—Oxide of lead combines in the dry way with stannic acid, arsenious and arsenic acids, antimonious and antimonite acids, and with peroxide of iron and oxide of zinc (Berthier)<sup>2</sup> These reactions take place in the furnaces as is shown by analyses XLIII and XLIV of peculiar accretions.

No. 3.—Oxide of lead is partially reduced to the metallic state by magnetic oxide of iron with formation of peroxide of iron:  $3\text{Fe}_3\text{O}_4 + 2\text{PbO} = \text{Fe}_3\text{O}_4 + 3\text{Fe}_2\text{O}_3 + \text{PbO} + \text{Pb}$  (Berthier). The fact that some slags (see analyses of slags) contain peroxide of iron in the state of silicate seems to indicate that this reaction takes place.

No. 4.—Oxide of lead in excess is reduced to the metallic state by sulphur with formation of sulphurous acid:  $2\text{PbO} + \text{S} = 2\text{Pb} + \text{SO}_2$  (Berthier). This reaction undoubtedly occurs when the charges contain pyrites.

No. 5.—Oxide of lead is reduced by arsenic with formation of lead and arsenite of lead:  $4\text{PbO} + \text{As} = \text{PbO} + \text{As}_2\text{O}_3 + 3\text{Pb}$  (Berthier).

No. 6.—Conversely, metallic lead reduces arsenite of lead with formation of basic arsenite of lead and arseniuret of lead:  $2(\text{PbO}, \text{As}_2\text{O}_3) + 4\text{Pb} = 5\text{PbO} + \text{As}_2\text{O}_3 + \text{PbAs}$

<sup>1</sup> Liebig and Kopp's Jahresb., 1851, p. 357.

<sup>2</sup> All the quotations from Berthier are taken from his *Traité des essais par la voie sèche*, Paris, 1834, and may also be found in Percy's *Metallurgy of Lead*, London, 1870.

(Berthier). The presence of arsenite of lead in all the oxide of lead compounds of the furnace and the presence of arsenic in bullion show that reactions 5 and 6 are of frequent occurrence.

No. 7.—Antimony acts on oxide of lead, and lead on oxide of antimony, in the same way as with arsenic (Berthier). The presence of antimonious acid in oxide of lead compounds and of antimony in bullion shows that these reactions are constantly taking place in the furnace.

No. 8.—Protoxide of lead is reduced to the metallic state by iron with formation of magnetic oxide of iron:  $4\text{PbO} + \text{Fe}_3 = \text{Fe}_3\text{O}_4 + \text{Pb}$  (Berthier). To this reaction is undoubtedly due part of the magnetic oxide of iron found in slags and other furnace products.

No. 9. Protoxide of lead and silica combine easily at the temperature at which the oxide of lead becomes pasty. The silicate  $3\text{PbO}, \text{SiO}_2$  is very fusible and very fluid. The silicate  $2\text{PbO}, \text{SiO}_2$  is pasty (Percy-Beck).<sup>1</sup> The presence of silicate of lead in all the slags shows that this substance is formed in the furnace.

No. 10. Oxide of lead and galena.—In this well-known reaction sulphurous acid is evolved and lead is reduced to the metallic state (Berthier, Percy-Smith):  $\text{PbS} + 2\text{PbO} = 3\text{Pb} + \text{SO}_2$ . This is one of the fundamental reactions of blast-furnaces which has been proved too often to need demonstration.

No. 11.—Oxide of lead is completely reduced to the metallic state by charcoal, coke, oxide of carbon, hydrogen with formation of carbonic oxide, carbonic acid and water (Berthier, Percy, and others).

No. 12.—Oxide of lead is reduced by zinc to the metallic state by formation of oxide of zinc:  $\text{PbO} + \text{Zn} = \text{Pb} + \text{ZnO}$  (Berthier). The oxide of zinc deposited in accretions and fumes is undoubtedly produced in this way by zinc reduced in the zone of agglomeration.

No. 13. Reactions of silicate of lead.—Silicate of lead behaves almost exactly like protoxide of lead in its reactions upon sulphur, iron scales, iron, carbon, carbonic oxide, galena, etc. (Percy-Beck).

No. 14.—Silicate of lead is completely reduced to the metallic state by mixtures of oxide of iron and carbon (Percy-Beck). This is undoubtedly one of the chief reactions of the furnace at the zones of agglomeration; but reactions No. 13 take place in most of the zones of the furnace.

No. 15. Reactions of sulphate of lead.—Sulphate of lead is decomposed by silica with evolution of sulphurous acid and oxygen and formation of silicate of lead (Berthier, Percy).

No. 16.—Sulphate of lead is reduced by lead to the state of oxide with evolution of sulphurous acid:  $\text{PbO}, \text{SO}_3 + \text{Pb} = 2\text{PbO} + \text{SO}_2$  (Berthier, Percy-Smith).

No. 17.—Sulphate of lead is reduced by iron to the metallic state with formation of magnetite oxide of iron and sulphide of iron:  $\text{PbO}, \text{SO}_3 + 4\text{Fe} = \text{Fe}_3\text{O}_4 + \text{FeS} + \text{Pb}$ . There is but little doubt that the mattes of Leadville owe their origin in great part to this reduction.

---

<sup>1</sup>The quotations from Percy and his assistants, whose names follow Percy's, are taken from Percy's Metallurgy of Lead, London, 1870.

No. 18.—Sulphate of lead is reduced by carbon to the state of sulphide:  $\text{PbO}, \text{SO}_3 + \text{C} = \text{PbS} + 2\text{CO}_2$  (Gay-Lussac),<sup>1</sup> and also by carbonic oxide (Rodwell).<sup>2</sup> The sulphide of lead of the mattes is produced partly by these reactions.

No. 19.—Sulphate of lead is decomposed by lime with formation of sulphate of lime and oxide of lead; sulphate of lime has been pointed out in the analyses of some furnace products.

No. 20. Reactions of sulphide of lead.—Sulphide of lead is somewhat volatile; it is sublimated at high temperatures (Berthier, Percy). This sublimated galena in fine distinct irised crystals is one of the constituents of normal shaft accretions.

No. 21.—Sulphide and oxide of lead react upon each other with formation of metallic lead and sulphurous acid (see reaction No. 10).

No. 22.—Sulphide of lead and metallic lead combine together and form subsulphides and alloys. The analyses of bullion and skimmings prove this reaction. Moreover, the metallurgical collection of the Survey contains specimens of alloys highly charged with sulphide of lead.

No. 23.—Sulphide of lead is reduced by zinc:  $\text{PbS} + \text{Zn} = \text{Pb} + \text{ZnS}$  (Percy-Smith). The sulphide of zinc found in normal accretions and also in lead fumes is certainly deposited in virtue of this reaction.

No. 24.—Sulphide of lead and sulphate of lead react upon each other with formation of metallic lead and sulphurous acid:  $\text{PbS} + \text{PbO}, \text{SO}_3 = 2\text{Pb} + 2\text{SO}_2$  (Berthier, Percy).

No. 25.—Sulphide of lead and iron produce one of the most important reactions of the blast furnace; lead is completely reduced to the metallic state and sulphide of iron is formed:  $\text{PbS} + \text{Fe} = \text{Pb} + \text{FeS}$  (Berthier). Most of the sulphide of iron in mattes is produced in this way.

No. 26.—Sulphide of lead and oxide of carbon act slightly upon each other with formation of sulphide of carbon (Rodwell).<sup>3</sup> In all probability some of the silica found in that portion of the fumes which escapes in the air is volatilized in the state of sulphide of silicon by the sulphide of carbon thus produced.

No. 27.—Sulphide of lead mixed with lime and carbon is partly reduced with formation of sulphide of calcium and carbonic oxide:  $2\text{PbS} + \text{CaO} + \text{C} = \text{Pb} + \text{PbS}, \text{CaS} + \text{CO}$  (Berthier). This important reaction, which undoubtedly takes place in the zone of agglomeration of the furnace, accounts for the sulphide of calcium in the slags.

No. 28.—Sulphide of lead, heated with oxide of iron and carbon, produces metallic lead and sulphide of iron:  $4\text{PbS} + 2\text{Fe}_2\text{O}_3 + 3\text{C} = 4\text{Pb} + 4\text{FeS} + 3\text{CO}_2$ .<sup>4</sup> This reaction is interesting as indicative of what actually takes place in the furnace.

No. 29.—Sulphide of lead and basic silicate of protoxide of iron react upon each other with formation of metallic lead, and iron and lead matte:  $2(3\text{FeO}, \text{SiO}_3) + 5\text{PbS} = 2(2\text{FeO}, \text{SiO}_3) + 2(\text{PbS}, \text{FeS}) + \text{SO}_2 + \text{Pb}_3$  (Percy-Cloud). This important reaction is illustrated by the specimens of hearth accretions or slag-mattes in the collection of the Survey.

<sup>1</sup> Ann. de Chim. et de Phys., 1836, 73, p. 435.

<sup>2</sup> Journal of the Chemical Society, new series, 1863, p. 42.

<sup>3</sup> Journal of the Chem. Soc., antea cit., p. 43.

<sup>4</sup> Jordan, Erdmann's Journal, 1831, 11, p. 324.

No. 30. Reactions of phosphate of lead.—Phosphate of lead forms, with chloride, bromide, and iodide of lead, very volatile compounds (A. Guyard). This is proved by the analysis of roasted chamber-dust and by that of the smoke caught in the Bartlett filter.

No. 31.—Phosphate of lead is reduced by carbon and iron to the metallic state, like oxide of lead (Percy-Cloud). Part of the phosphoric acid found in the slags comes from this reaction.

No. 32. Reactions of chloride of lead.—It is a well-known fact that chloride, bromide, and iodide of lead are volatile compounds; hence their constant presence in lead fumes of every kind in Leadville.

No. 33. Chloride of lead with lime and carbon.—Chloride of lead is reduced to the metallic state with formation of chloride of calcium and carbonic acid (Berthier):  $2\text{PbCl}_2 + 2\text{CaO} + \text{C} = \text{Pb}_2 + 2\text{CaCl}_2 + \text{CO}_2$ . The analyses of slags show that this reaction does not take place in Leadville. It is chiefly due to the fact that chloride of lead is volatilized before carbonate of lime is decomposed, and it indicates that there would be an advantage in using caustic lime instead of raw limestone.

No. 34. Chloride of lead and galena.—These two substances form a very volatile chloro-sulphide of lead similar to galena (Berthier). This product has been found in the portion of the lead fumes lost in the air.

No. 35. Reactions of metallic lead.—Lead is somewhat volatile (all authors). It has been seen that normal accretions are chiefly formed of sublimated lead, and the contents of this sublimated lead in silver were also given.

## REACTIONS OF SILVER COMPOUNDS.

No. 36. Reactions of metallic silver.—Silver is somewhat volatile (all authors). The assay of sublimated bullion found in normal shaft accretions gives an idea of the relative proportion of lead and silver volatilized and sublimated in the blast furnace.

No. 37. Reactions of sulphide of silver.—Sulphide of silver combines with metallic silver and with sulphides of lead and iron. The analyses of bullion, skimmings, and mattes show that these reactions take place in Leadville.

No. 38.—Sulphide of silver heated with oxide of lead is reduced to the metallic state, with formation of an alloy of lead and silver and sulphurous acid:  $\text{Ag}_2\text{S} + 2\text{PbO} = 2(\text{PbAg}) + \text{SO}_2$  (Percy-Smith).<sup>1</sup>

No. 39.—Sulphide of silver is not completely reduced to the metallic state by metallic lead in excess (Percy).

No. 40.—Sulphide of silver is completely reduced to the metallic state by iron, with formation of sulphide of iron (Berthier, Percy, and others).

No. 41.—Sulphide of silver is not completely reduced by iron in presence of an excess of sulphide of iron (A. Guyard): The matte analyzed in XL, and which yielded 85.067 ounces of silver to the ton by scorification, gave only 80.16 ounces when it was treated directly with flux, litharge, and iron. This experiment throws light on many furnace reactions.

Reactions of chloride of silver —What is said for chloride of silver is true for bromide and iodide.

<sup>1</sup> Quotations from Percy and his assistants are taken from Percy's Metallurgy of Silver and Gold. Part 1. London, 1880.

No. 42.—It is a well-known fact that this compound is volatile; hence its presence in large quantities in the lead dust and even in the lost fumes.

No. 43.—Chloride of silver is reduced in the dry way by metallic lead and also by metallic iron. It is owing to these important reactions that so much chloro-bromide of lead is formed and that so much silver is reduced in the bullion.

REACTIONS OF IRON COMPOUNDS.

No. 44. Reactions of carbonate of iron.—Carbonate of iron is reduced at red heat to the state of magnetic oxide of iron with formation of carbonic oxide (l. Lowthian Bell),<sup>1</sup> with formation of peculiar magnetic oxide of iron, containing an excess of protoxide of iron (Percy).<sup>2</sup> The writer has found a similar magnetic oxide of iron in slags and mattes.

No. 45. Reactions of peroxide of iron.—Under the influence of carbonic oxide, peroxide of iron begins to lose oxygen at the temperature of 200° C., protoxide of iron being formed as well as carbonic acid. The decomposition increases rapidly with the temperature until it reaches 417° C. The loss in oxygen is greater in the same lapse of time in a rapid current of carbonic oxide. At 410° C. peroxide of iron loses 36 per cent. of its oxygen in a slow current of carbonic oxide and 56 per cent. in a rapid current of the same gas (Bell). In the blast furnaces of Leadville the conditions are those of a rapid current. To form magnetic oxide, peroxide of iron must lose 11.1 per cent. of its oxygen, and to form protoxide of iron 33.3 per cent. Consequently at the temperature of 410°—i. e., below red heat—and in a rapid current of carbonic oxide, peroxide of iron losing more than 50 per cent. of its oxygen, some metallic iron is produced. This is an important fact, but one which is profoundly modified in the furnace, where carbonic oxide is diluted with nitrogen and carbonic acid.

No. 46.—At the temperature of 417° C.—that is, at the temperature at which metallic iron makes its appearance—it is rapidly attacked by carbonic acid, with formation of oxide of iron and oxide of carbon (Bell).

No. 47.—At the same temperature of 417° C. a mixture of equal volumes of carbonic acid and carbonic oxide exerts no action upon metallic iron, but at full red heat the carbonic acid of the mixture is rapidly decomposed and converted into carbonic oxide (Bell).

No. 48.—Mixtures of carbonic acid and oxide reduce peroxide of iron, but only to the state of protoxide, at the temperature of 417° C., with formation of carbonic acid (Bell).

No. 49.—A mixture of carbonic acid with an excess of oxide of carbon (CO<sub>2</sub> 9 volumes, CO 100 volumes) oxidizes spongy iron, and carbon is deposited from reduced oxide of carbon, oxide of iron being formed. Pure spongy iron thus treated has for composition Fe=91.42, C=0.33, O=8.25 (Bell). In pure oxide of carbon spongy iron takes up as much as 23 per cent. of carbon (Bell).

The above considerations, which are purely theoretical, are interesting as showing the mechanism of the formation of cast iron in the blast furnaces, such as those of Leadville, in which the phenomena of lead and silver smelting take place jointly

<sup>1</sup> All quotations from I. L. Bell are from his *Chemical Phenomena of Iron Smelting*. London, 1872.

<sup>2</sup> Percy's *Metallurgy of Iron and Steel*. London, 1864.

with those of iron smelting; but the following experiments, made by I. L. Bell in the iron blast furnaces in the presence of the gases actually produced in smelting, show with more accuracy the real process of the reduction of iron:

(a) Furnace working with raw limestone; pieces of calcined Cleveland ore or artificial hematite kept for two hours in the zone of the furnace below red point. Composition of gases: CO=100 volumes; CO<sub>2</sub>=25 volumes; N=190 volumes. The ore loses 11.85 per cent. of its oxygen (mean of two experiments).

(b) Same experiment as in *a*, but in cherry-red zone. Composition of gases: CO=100 volumes; CO<sub>2</sub>=8½ volumes; N=172½ volumes. The ore loses 76.2 per cent. of its oxygen, showing great reduction of iron.

(c) Same experiment as in *a* and *b*, but in bright-red zone. Composition of gases: CO=100 volumes; CO<sub>2</sub>=3½ volumes; N=169½ volumes. The ore loses 73.8 per cent. of its oxygen.

(d) Same experiment as preceding, but in very bright-red zone. Composition of gases: CO=100 volumes; CO<sub>2</sub>=3 volumes; N=183½ volumes. The ore loses 80 per cent. of its oxygen.

(e) Same experiment as preceding, but in intensely bright-red zone near tuyeres. Composition of gases: CO=100 volumes; CO<sub>2</sub>=5 volumes; N=172½ volumes. The ore loses 71 per cent. of its oxygen.

To interpret correctly these experiments we must take into consideration that the ore does not remain exposed two hours to the influence of the gases of the same zone in the furnaces of Leadville, and that although the reducing power of the corresponding zones is sensibly the same the quantity of ore reduced is greatly diminished.

Reactions of sulphides of iron.—Pyrites existing in some ores and sulphide of iron being formed in the furnace, the following reactions are interesting:

No. 50.—Protosulphide of iron and peroxide of iron act upon each other with formation of magnetic oxide of iron and sulphurous acid:  $\text{FeS} + 10\text{Fe}_2\text{O}_3 = 7\text{Fe}_3\text{O}_4 + \text{SO}_2$  (Percy-Hochstätter). To this reaction is probably due in part the magnetic oxide of mattes.

No. 51.—Iron pyrites and oxide of lead react upon each other, give off sulphurous acid, and form a magnetic mixture of sulphides and oxides of lead and iron (Percy). In this instance the origin of mattes is clearly indicated.

#### CHEMICAL DISCUSSION OF THE LEADVILLE FURNACES.

The object of this discussion is to illustrate the chemical and metallurgical reactions of the blast furnace, and it is based as much as possible on general averages obtained during the preparation of this report.

It has already been seen (Table IV):

- (1) That the average proportion of fuel to ore is 32.83 per cent.
- (2) That the average proportion of fuel to charge is 24.03 per cent.
- (3) That the average composition of the fuel used in the camp is: charcoal, 57 per cent.; coke 43 per cent. = 100 per cent.
- (4) That the average proportion of ash in coke is 22 per cent. and in charcoal 2.5 per cent., giving for the fuel under consideration an average of 10.88 per cent. of

ash. We will assume from the nature of this fuel that its average proportion of moisture is equal to 5 per cent. and of gases 3 per cent.

Raw materials.—The average composition of ore, hematite, dolomite, fuel, ash in fuel, and atmospheric air which will be adopted in this discussion is the following:

Component parts.	Ore.	Hematite.	Dolomite.	Fuel.	Ash in fuel.	Atmospheric air.
Carbon .....				80.82		
Gases in fuel.....				3.00		
Nitrogen.....						77.50
Oxygen.....	9.53	22.50				21.41
Carbonic acid.....	5.58		45.83		3.50	6.04
Moisture.....	5.53	1.92	6.10	5.00		1.05
Lead.....	23.00					
Silver.....	0.31					
Metallic iron.....	18.10	52.50				
Alumina.....	3.99	0.50				
Peroxide of iron <i>a</i> .....			0.66		22.20	
Peroxide of manganese.....	4.03	0.42				
Lime.....	2.36	0.37	30.88		4.00	
Magnesia.....	3.04	0.63	19.57		0.50	
Alkalies.....	0.98				2.00	
Silica.....	22.59	16.30	2.40		50.80	
Ash.....				10.88		
Other constituents <i>b</i> .....	0.96	4.86	0.56	0.30	11.00	
Totals.....	100.00	100.00	100.00	100.00	100.00	100.00

*a* It will be assumed that this peroxide of iron escapes reduction.

*b* Sulphur, arsenic, antimony, chlorine, phosphoric acid, &c., are neglected in subsequent calculations.

The composition of old slags is not given here, it being unnecessary for this discussion.

Of the above chemical constituents the following proportional quantities enter into the smelting charge, calculated on the basis of averages given in Section V of Table IV:

Constituents of smelting charges.	From ore.	From hematite.	From dolomite.	From fuel.	From ash in fuel.
Carbon .....				26.533	
Gases in fuel.....				0.985	
Oxygen.....	9.53	1.867			
Carbonic acid.....	5.58		4.986		0.125
Moisture.....	5.53	0.159	0.011	1.641	
Lead.....	23.00				
Silver.....	0.31				
Metallic iron.....	18.10	4.357			
Alumina.....	3.99	0.041			
Peroxide of iron.....			0.072		0.793
Peroxide of manganese.....	4.03	0.025			
Lime.....	2.36	0.031	3.360		0.143
Magnesia.....	3.04	0.052	2.129		0.018
Alkalies.....	0.98				0.071
Silica.....	22.59	1.353	0.201		2.029



The above figures may be conveniently combined as follows:

<i>Volatile portion.</i>	
Carbon from fuel .....	26.533
Gases from fuel .....	0.985
Carbonic acid from ore, dolomite, and ash .....	10.691
Oxygen from Fe <sub>2</sub> O <sub>3</sub> in ore and hematite, escaping as CO <sub>2</sub> .....	3.208
Oxygen from MnO <sub>2</sub> in ore and hematite, escaping as CO <sub>2</sub> .....	0.747
Oxygen from PbO escaping as CO <sub>2</sub> .....	1.640
Moisture from whole charge .....	7.341
Dust and fumes carried away .....	<div style="display: flex; align-items: center; justify-content: flex-end;"> <div style="margin-right: 10px;"> <math>\left\{ \begin{array}{l} \text{Pb}=1.040 \\ \text{Ag}=0.011 \\ \text{Dust}=0.890 \end{array} \right.</math> </div> <div style="text-align: right;">                     1.941                 </div> </div>
<b>Total .....</b>	<b>53.086</b>
<i>Slag.</i>	
Silica .....	26.202
Alkalies .....	1.051
Magnesia .....	5.230
Lime .....	5.894
Alumina .....	4.031
Protoxide of iron .....	28.873
Peroxide of iron .....	0.865
Protoxide of manganese .....	3.318
Protoxide of lead .....	1.860
Old slag .....	17.441
<b>Total .....</b>	<b>94.774</b>
Less dust .....	0.890
<b>Total slag produced .....</b>	<b>93.884</b>
<i>Bullion.</i>	
Lead .....	20.240
Silver .....	0.299
<b>Total .....</b>	<b>20.539</b>
<b>Total of volatile portion, slag, and bullion .....</b>	<b>167.509</b>

In these calculations speiss and matte have been purposely neglected. Besides the descending charge of solid matter thrown in the furnace at the feed-hole, there is the ascending charge of blast forced in at the tuyeres. The weight of the gaseous charge will be calculated after the weights of charges filling the furnace have been determined.

This discussion is carried on for the blast furnace of smelter C, which is shown in Fig. 2, Plate XXXVI, divided into zones of charges and temperatures in accordance with the working of this furnace. These zones will be designated hereafter by their temperatures. The zone 900° of the crucible is charged with 12 tons of bullion.<sup>1</sup>

It is assumed that the furnace is in full blast; that the weight of smelting charges, including fuel, is equal to 502.527 pounds, or three times the weight of the charge cal-

<sup>1</sup>Temperatures are theoretical, not observed.

culated for 100 pounds of ore. This figure is calculated from the capacity of the furnace, and represents very nearly a semi-charge of smelter C, but as a great many furnaces run charges of this weight it will be adopted in this discussion. The furnace is capable of smelting this charge in about seven minutes, giving a cake of slag weighing 281.652 pounds, and it is assumed that at the time of the experiment the furnace is properly filled with eleven similar charges, each charge being divided into two layers, a layer of fuel and old slag and a layer of flux and ore, all these suppositions and all the figures adopted being in perfect accordance with the practical working of the furnace.

The composition in pounds of the charge in zone 150°, the zone in which it is thrown into the furnace, will be as follows:

Carbon .....	79.599
Gases from fuel .....	2.955
Carbonic acid (C=8.747) .....	32.073
Oxygen .....	33.792
Moisture .....	22.023
Lead (total CO <sub>2</sub> combined with PbO=14.667; PbO=65.774; O=4.934) ..	63.840
Silver .....	0.930
Metallie iron (Fe <sub>2</sub> O <sub>3</sub> =93.036; FeO=86.620; Fe <sub>2</sub> O <sub>3</sub> =96.244).....	67.371
Oxide of lead in slag .....	5.580
Alumina .....	12.093
Peroxide of iron .....	2.595
Peroxide of manganese (MnO=9.952; O=2.243) .....	12.195
Silica .....	78.606
Lime .....	} (total CO <sub>2</sub> in combination=17.406) .....
Magnesia .....	
Alkalies .....	3.153
Old slag .....	52.323
Total .....	502.527

Weight of blast.—It will be seen in the discussion of losses in each zone of the furnace that of the 79.599 pounds of carbon thrown in the furnace with each charge only 32.1257 pounds reach the zone of combustion. It is this quantity of carbon which will enable us to calculate the quantity of air necessary to convert it into carbonic acid in seven minutes, an excess of air being injurious and calculated to cool the furnace. As 32.1257 pounds of carbon require 85.6685 pounds of oxygen for their combustion into carbonic acid, it is deduced from the composition of air given previously that the air blown in the furnace in seven minutes will be composed of—

Oxygen .....	85.6685
Moisture .....	4.2023
Carbonic acid .....	0.1600
Nitrogen .....	310.1031
Total .....	400.1339

In other words, the weight of air strictly necessary to burn the carbon left in the smelting charge at the tuyeres is about four-fifths of the weight of the charge thrown in at the feed-hole. At sea-level the volume of air corresponding to the weight of 400.1339 would be 5,356 cubic feet (1 cubic foot=538.569 grains). In Leadville, at the normal pressure of 21 inches of mercury, the volume of the same weight of air is represented by 7,906.2 cubic feet.

It has been seen that the normal volume of blast delivered by the blower connected with this furnace is 2,550 cubic feet per minute, or 17,850 cubic feet in seven minutes, at the rate of 80 revolutions per minute; consequently, 9,943.8 cubic feet of blast must be shut out during the seven minutes. This is done, as before shown, by leaving open the damper placed at the extreme end of the main blast-pipe. However, there is hardly any doubt that in practice an excess of air passes through to the furnace, and it is to avoid this that the adoption of a meter to be placed at the induction pipe has been recommended.

Loss of weight of charges.—The data are now prepared which are necessary for the discussion of the loss of weight of smelting charges in every zone of the furnace in seven minutes, and for giving an idea of the chief reactions that take place in each. As the element of time is all-important in these discussions, the reactions have been described in zones of temperature higher than those indicated by theory; but, if there are a few errors of judgment in the position assigned to them, the final results remain unaltered.

The weight of gases<sup>1</sup> which pass through the uppermost zone in seven minutes is as follows:

<i>Zone of gases 150° C.</i>	
Carbonic acid .....	27.455
Oxide of carbon .....	188.771
Vapor of water .....	26.225
Nitrogen.....	310.103
Gases from fuel .....	2.955
Dust and lead fumes.....	5.823
Total.....	561.322
<i>Zone of desiccation 150° C.</i>	
Weight of charge entering zone .....	502.5270
It loses one-fourth of its moisture (chiefly from the ore), or.....	5.5038
It loses one-eleventh of total loss in dust and fumes .....	0.5294
	6.0352
<i>Zone of desiccation 255° C.</i>	
Weight of charge entering zone .....	490.4918
It loses one-fourth of its moisture (chiefly from the ore) .....	5.5058
It loses one-eleventh of total loss in dust and fumes .....	0.5294
	6.0352
<i>Zone of desiccation 360° C.</i>	
Weight of charge entering zone .....	490.4566
It loses one-fourth of its moisture (from ore and fuel) .....	5.5057
It loses one-eleventh of total loss in dust and fumes .....	0.5294
	6.0351
<i>Zone of desiccation 465° C.</i>	
Weight of charge entering zone .....	484.4215
It loses the remaining one-fourth of its moisture (chiefly from fuel) .....	5.5057
It loses one-eleventh of total loss in dust and fumes .....	0.5294
	6.0351
	478.3864

<sup>1</sup> As no analyses were made of the gases passing through the different zones of the furnaces at Leadville, the figures given by Mr. Guyard in the following tables cannot be assumed to represent their actual composition. In point of fact, their composition must be very different from that assumed by him, owing to the excess of blast used. His idea is evidently to represent what the theoretical conditions in the furnace should be when employing the least amount of blast for the given amount of fuel. (S. F. E.)

*Zone of decomposition 570° C.*

Weight of charge entering zone .....		478.3864
It loses:		
One-eleventh of the total loss in dust and fumes .....	0.5294	
One-half of the gases from fuel .....	1.4775	
One-half of the CO <sub>2</sub> from PbO, CO <sub>2</sub> <sup>a</sup> .....	7.3333	
C oxidized by $\frac{1}{2}$ CO <sub>2</sub> formed in zone 780° C. (2.2614 pounds CO <sub>2</sub> ) .....	0.6167	
C oxidized by $\frac{1}{2}$ CO <sub>2</sub> formed in zone 885° C. (5.4436 pounds CO <sub>2</sub> ) .....	1.4846	
C oxidized by $\frac{1}{2}$ CO <sub>2</sub> formed in zone 990° C. (3.5288 pounds CO <sub>2</sub> ) .....	0.9624	
C oxidized by $\frac{1}{2}$ CO <sub>2</sub> formed in zone 1,095° C. (0.8822 pounds CO <sub>2</sub> ) .....	0.2406	
C oxidized by $\frac{1}{6}$ CO <sub>2</sub> formed in zone 1,200° C. (10.7086 pounds CO <sub>2</sub> ) .....	2.9205	
C oxidized by $\frac{1}{2}$ CO <sub>2</sub> expelled from PbO, CO <sub>2</sub> in zone 075° C. (2.4444 pounds CO <sub>2</sub> ) .....	0.6067	
C oxidized by $\frac{1}{2}$ CO <sub>2</sub> expelled from carbonates in zone 990° C. (1.1604 pounds CO <sub>2</sub> ) .....	0.3164	
C oxidized by $\frac{1}{2}$ CO <sub>2</sub> expelled from carbonates in zone 1,095° C. (0.9670 pounds CO <sub>2</sub> ) .....	0.2637	
C oxidized by $\frac{1}{2}$ CO <sub>2</sub> expelled from carbonates in zone 1,200° C. (0.8288 pounds CO <sub>2</sub> ) .....	0.2260	
		17.0378
Total C oxidized in zone 570° C. ....	7.6976	
Total CO formed in same zone .....	35.9221	

*Zone of reaction 675° C.*

Weight of charge entering zone .....		461.3486
It loses:		
One-eleventh of the total loss in dust and fumes .....	0.5294	
The remaining $\frac{1}{2}$ of gases from fuel .....	1.4775	
The remaining $\frac{1}{2}$ of CO <sub>2</sub> from PbO, CO <sub>2</sub> <sup>b</sup> .....	7.3334	
C oxidized by $\frac{1}{2}$ CO <sub>2</sub> formed in zone 780° C. (2.2614 pounds CO <sub>2</sub> ) .....	0.6168	
C oxidized by $\frac{1}{2}$ CO <sub>2</sub> formed in zone 885° C. (5.4436 pounds CO <sub>2</sub> ) .....	1.4846	
C oxidized by $\frac{1}{2}$ CO <sub>2</sub> formed in zone 990° C. (3.5288 pounds CO <sub>2</sub> ) .....	0.9624	
C oxidized by $\frac{1}{2}$ CO <sub>2</sub> formed in zone 1,095° C. (0.8822 pounds CO <sub>2</sub> ) .....	0.2406	
C oxidized by $\frac{1}{6}$ CO <sub>2</sub> formed in zone 1,200° C. (10.7086 pounds CO <sub>2</sub> ) .....	2.9205	
C oxidized by $\frac{1}{2}$ CO <sub>2</sub> expelled from carbonates in zone 990° C. (1.1604 pounds CO <sub>2</sub> ) .....	0.3165	
C oxidized by $\frac{1}{2}$ CO <sub>2</sub> expelled from carbonates in zone 1,095° C. (0.9670 pounds CO <sub>2</sub> ) .....	0.2637	
C oxidized by $\frac{1}{2}$ CO <sub>2</sub> expelled from carbonates in zone 1,200° C. (0.8288 pounds CO <sub>2</sub> ) .....	0.2260	
		16.3714
Total C oxidized in zone 675° C. ....	7.0311	
Total CO formed in same zone .....	32.8118	

*Zone of reduction 780° C.*

Weight of charge entering zone .....		444.9772
It loses:		
One-eleventh of the total loss in dust and fumes .....	0.5294	
One-half of the oxygen from total PbO reduced (this forms with CO 6.78425 pounds CO <sub>2</sub> , of which $\frac{1}{2}$ is reduced in zones 570° and 675°, while $\frac{1}{2}$ escapes) ..	2.4670	
C oxidized by $\frac{1}{2}$ CO <sub>2</sub> formed in zone 885° C. (5.4437 pounds CO <sub>2</sub> ) .....	1.4847	
C oxidized by $\frac{1}{2}$ CO <sub>2</sub> formed in zone 990° C. (3.5288 pounds CO <sub>2</sub> ) .....	0.9624	
C oxidized by $\frac{1}{2}$ CO <sub>2</sub> formed in zone 1,095° C. (0.8822 pounds CO <sub>2</sub> ) .....	0.2406	
C oxidized by $\frac{1}{6}$ CO <sub>2</sub> formed in zone 1,200° C. (10.7086 pounds CO <sub>2</sub> ) .....	2.9205	
C oxidized by $\frac{1}{2}$ CO <sub>2</sub> expelled from carbonates in zone 990° C. (1.1604 pounds CO <sub>2</sub> ) .....	0.3165	

<sup>a</sup> It will be assumed that, owing to the velocity of blast, the admixture of inert gases from zones below, and the low temperatures of zones above, this CO<sub>2</sub> escapes reduction to CO.

<sup>b</sup> It will be assumed, for the reasons stated under zone 570°, that only  $\frac{1}{2}$  of the CO<sub>2</sub> driven off here is reduced to CO in upper zone 570°.

REACTIONS IN BLAST FURNACES.

743

C oxidized by $\frac{1}{3}$ CO <sub>2</sub> expelled from carbonates in zone 1,095° C. (0.9670 pounds CO <sub>2</sub> ) .....	0.2637	
C oxidized by $\frac{1}{3}$ CO <sub>2</sub> expelled from carbonates in zone 1,200° C. (0.8288 pounds CO <sub>2</sub> ) .....	0.2260	
		0.41
Total C oxidized in zone 780° C. ....	6.4144	
Total CO formed in same zone .....	29.9339	
Of this latter there is used for reduction of ore .....	4.3172	
		<hr/>
Leaving for escaping CO .....	25.6167	

*Zone of reduction 885° C.*

Weight of charge entering zone .....		435,5664
It loses:		
One-eleventh of the total loss in dust and fumes .....	0.5293	
The remaining $\frac{1}{3}$ of oxygen from total PbO reduced .....	2.4670	
Oxygen from MnO <sub>2</sub> reduced to MnO .....	2.2430	
Oxygen from Fe <sub>2</sub> O <sub>3</sub> reduced to Fe <sub>3</sub> O <sub>4</sub> .....	3.2080	
(Total oxygen 7.9180. This forms with CO 21,7745 pounds CO <sub>2</sub> , of which $\frac{1}{3}$ is reduced in upper zones, while $\frac{2}{3}$ escapes.)		
C oxidized by $\frac{1}{3}$ CO <sub>2</sub> formed in zone 990° C. (3.5288 pounds CO <sub>2</sub> ) .....	0.9624	
C oxidized by $\frac{1}{3}$ CO <sub>2</sub> formed in zone 1,095° C. (0.8223 pounds CO <sub>2</sub> ) .....	0.2406	
C oxidized by $\frac{1}{3}$ CO <sub>2</sub> formed in zone 1,200° C. (21.4171 pounds CO <sub>2</sub> ) .....	5.8410	
C oxidized by $\frac{1}{3}$ CO <sub>2</sub> expelled from carbonates in zone 990° C. (1.1604 pounds CO <sub>2</sub> ) .....	0.3165	
C oxidized by $\frac{1}{3}$ CO <sub>2</sub> expelled from carbonates in zone 1,095° C. (0.9670 pounds CO <sub>2</sub> ) .....	0.2637	
C oxidized by $\frac{1}{3}$ CO <sub>2</sub> expelled from carbonates in zone 1,200° C. (0.8289 pounds CO <sub>2</sub> ) .....	0.2261	
		16.2976
Total C oxidized in zone 885° C. ....	7.8503	
Total CO formed in same zone .....	36.6347	
Of this latter there is used for reduction of ore .....	13.8565	
		<hr/>
Leaving for escaping CO .....	22.7782	

*Zone of semi-agglomeration 990° C.*

Weight of charge entering zone .....		419.2688
It loses:		
One-eleventh of total loss in dust and fumes .....	0.5293	
One-third of CO <sub>2</sub> from carbonates .....	5.8020	
(Of this $\frac{1}{3}$ is reduced in upper zones, while $\frac{2}{3}$ escapes.)		
Oxygen from Fe <sub>2</sub> O <sub>3</sub> reduced to FeO .....	6.4160	
(This forms with CO 17.6440 pounds CO <sub>2</sub> , of which $\frac{1}{3}$ is reduced in upper zones, while $\frac{2}{3}$ escapes.)		
C oxidized by $\frac{1}{3}$ CO <sub>2</sub> formed in zone 1,095° C. (0.8223 pounds CO <sub>2</sub> ) .....	0.2407	
C oxidized by $\frac{1}{3}$ CO <sub>2</sub> formed in zone 1,200° C. (32.1256 pounds CO <sub>2</sub> ) .....	8.7616	
C oxidized by $\frac{1}{3}$ CO <sub>2</sub> expelled from carbonates in zone 1,095° C. (0.9670 pounds CO <sub>2</sub> ) .....	0.2637	
C oxidized by $\frac{1}{3}$ CO <sub>2</sub> expelled from carbonates in zone 1,200° C. (0.8289 pounds CO <sub>2</sub> ) .....	0.2261	
		22.2905
Total C oxidized in zone 990° C. ....	9.4921	
Total CO formed in same zone .....	44.2965	
Of this latter there is used for reduction of ore .....	11.2280	
		<hr/>
Leaving for escaping CO .....	33.0685	

*Zone of agglomeration 1,095° C.*

Weight of charge entering zone .....	397, 0293
It loses:	
One-eleventh of the total loss in dust and fumes.....	0. 5293
One-third of the CO <sub>2</sub> from carbonates.....	5. 8020
(Of this $\frac{2}{3}$ is reduced in upper zones, while $\frac{1}{3}$ escapes.)	
Oxygen from $\frac{1}{10}$ FeO reduced to Fe.....	1. 9249
(This forms with CO 5.2935 pounds CO <sub>2</sub> , of which $\frac{2}{3}$ is reduced above, while $\frac{1}{3}$ escapes.)	
C oxidized by $\frac{1}{2}$ CO <sub>2</sub> expelled from carbonates in zone 1,200° C. (0.8259 pounds CO <sub>2</sub> ).....	0. 2261
C oxidized by $\frac{1}{3}$ CO <sub>2</sub> formed in zone 1,200° C. (32.1256 pounds CO <sub>2</sub> ).....	8. 7610
	17. 2439
Total C oxidized in zone 1,095° C.....	8. 0877
Total CO formed in same zone.....	41. 9426
Of this latter there is used for reduction of ore.....	3. 3680
	38. 5740

*Zone of combustion and reaction by contact of solid matter, 1,200° C.*

Weight of charge entering zone .....	370. 7854
It loses:	
One-eleventh of the total loss in dust and fumes.....	0. 5293
One-third of the CO <sub>2</sub> from carbonates.....	5. 8020
(Of this $\frac{2}{3}$ is reduced in upper zones, while $\frac{1}{3}$ escapes.)	
C oxidized to CO <sub>2</sub> .....	32. 1257
	38. 4580
Remaining in furnace.....	341. 3274 <sup>a</sup>
Weight of bullion reaching zone of crucible.....	61. 6170
Weight of slag produced.....	281. 6520
	343. 2690

Chemical reactions of the different zones.—Some important reactions begin to take place in zone 570° C. and are continued in zone 675° C. Oxide of lead acts on galena, sulphide of silver, and pyrites, and some sulphurous acid is evolved. Mattes begin to form. Oxide of lead acts on silica, and some silicate of lead is formed. In practice dolomites lose here a portion of their carbonic acid, but the discussion has been carried on as if dolomite behaved like carbonate of lime, in order to get at extreme results.

In zone 780° C., the important reaction of reduction of lead taking place, several more reactions are produced in consequence. Metallic lead acts on arseniate and antimoniate of lead, forming arseniuret and antimoniuret of lead, with regeneration of oxide of lead. Metallic lead acts also on sulphate of lead, with regeneration of oxide and evolution of sulphurous acid; all the reactions which have escaped completion in the upper zones are completed here. Metallic lead acts on galena, and subsulphides are formed. Sulphide of lead acts on sulphate and oxide of lead, with evolution of sulphurous acid and reduction of lead. Sulphide of lead acts on silicate of lead, and mattes are produced. Metallic lead acts on chloro-bromo-iodide of silver and forms

<sup>a</sup> The discrepancy between this number and that next below, representing the sum of bullion and slag, is mainly due to the fact that while Mr. Guyard expressly says (p. 739) he has neglected consideration of speiss and matte in this discussion, he nevertheless allows for the reduction of  $\frac{1}{10}$  FeO in zone 1,095° C. Calculations carried out with a view to correcting the above discrepancy give 32.7272 as the amount of carbon burnt in zone 1,200°. Such correction involves, naturally, slight alterations in some of the figures, representing loss in all except the four highest of the other zones, and also alters the data relative to the amount of blast theoretically required. A second cause of difference between the above numbers is found in the fact that the figures for composition of charge (p. 740) are accurate in some cases only to the second decimal figure. The slight inaccuracies in the values of the third decimal necessarily involve errors in calculations carried to four decimal places. (S. F. E.)

chloro-bromo-iodide of lead, which is volatilized with the chlorophosphate of lead of the ore, and reduced silver alloys with lead, forming bullion. Sulphide of silver is partly acted upon by lead also, and some galena is regenerated. Chloro-bromo-iodide of lead acts on galena and volatilizes a portion of this substance.

Zone 885° C. is one of the most important with regard to reactions. Silicate of lead acts partly on the magnetic oxide of iron formed, reoxidizes it, and some peroxide of iron combines with silica. All the constituents of the charge are in a semi-fluid condition, and all possible compounds are formed here, some of which will be destroyed by thorough fusion in lower zones. Sulphate of lead is acted on energetically by silica; all the reactions of zone 780° C. are produced here also with even more energy. Sulphide of carbon is formed and produces sulphides of silicium and magnesium. Some volatile chlorides of non-volatile metals are also formed. All the reactions which generate mattes are to be observed in this zone. In this zone also the quantities of carbonic oxide and carbonic acid are nearly equal. Hematite loses completely the carbonic acid of its carbonate of iron. Zinc, reduced in zones below, acts on galena, and sulphide of zinc is formed.

Zone 990° C. is one of very important reactions. Lime and magnesia being set free act energetically on sulphide of lead and pyrites, forming the sulphide of calcium found in the slag. Silica combines with lime, magnesia, and protoxide of iron, and slag is formed. Oxide of lead is expelled from its silicate. Phosphate of lead which has escaped volatilization forms the phosphate of lime found in slags and accretions.

In zone 1,095° C., iron reduces arseniuret of lead, forming speiss, and sulphide of lead, forming matte. It acts also on oxide of lead expelled from silicate, forming magnetic oxide of iron, which enters the slag and the matte. This zone is the zone of refining of bullion. It is here also that molybdic oxide is reduced and that iron and speiss combine with it.

The preceding chemical discussion was carried on also with a view to ascertain the zones of absorption and of production of heat in the furnace, and it was the writer's intention to develop a complete thermic discussion of the different zones; but neither the time nor the means of determining with accuracy a few important data peculiar to the blast-furnaces in which lead is smelted could be had, and a discussion based on hypotheses would have lost all scientific or practical value.

#### CONCLUSIONS.

The chief conclusions arrived at in the preceding pages are:

1. That smelting in Leadville is a profitable operation, but that the aggregate smelting capacity of the working smelters is about equal to the present mining product of the camp.
2. That lead smelting in Leadville has, on the whole, been brought to a state of great perfection with regard both to the plant adopted, which is constructed on the most approved principles, and to the manner in which fuel, fluxes, and ores are mixed for smelting, giving slags which are remarkable for their fluidity and not too highly charged with either silver or lead (especially when it is remarked that the bullion produced is very rich), and from which by-products, such as speiss and matte, are easily detached.
3. That the quantity of by-products, other than lead fumes, resulting from smelting in Leadville amounts to but little.

4. That the camp is provided with the necessary plant to work profitably such by-products as are generally rich in silver and either completely neglected, or treated imperfectly and with a considerable loss of silver.

5. That the mode adopted at a great many smelters of mixing and resmelting with caustic lime the chamber-dust, formed in considerable quantity, is the best that could have been devised, and that it would be advisable to substitute pure lime for the dolomitic lime used in Leadville for this operation.

6. That the numerous imperfections noticeable at various smelters are mostly intentional and based on economical grounds, and not on ignorance, for smelting is conducted in Leadville by very clever superintendents and smelters.

7. That the smelting of lead ores in the presence of iron-stone has here been brought to a state of great practical perfection, and is carried on most successfully from one year's end to the other with the greatest regularity at a dozen smelters, and that superintendents of smelters do not hesitate to introduce in the charges sometimes very large quantities of galena, which are reduced with the greatest facility.

8. That, owing to the peculiar nature of the Leadville ores and to the great altitude at which smelting is performed, which increases the volatility of lead compounds, attempts ought to be made to substitute caustic lime free from magnesia for the raw dolomite used in Leadville, in order to avoid as much as possible the formation of volatile lead compounds.

9. That, *cæteris paribus*, dolomite forms as good a flux as calcitic limestone, so far as the actual working of the blast-furnaces is concerned, and that the fluidity of the slag thus formed is not only irreproachable but quite remarkable.

10. That, besides the substances existing in large quantities in the camp, such as silica, sulphur, carbonic acid, lime, magnesia, alumina, oxides of iron and manganese, lead, silver, chlorine, and phosphoric acid, the following substances exist in small quantities: Sulphuric acid, titanitic acid, bromine, iodine, zinc, baryta, gold, nickel, molybdenum, arsenic, antimony, and copper; and that traces of the following substances may be detected: Tin, bismuth, cobalt, indium, selenium, tellurium, cadmium, and a new metal, which has been imperfectly studied as yet, and which appears to be intermediate between the metals of the iron group and those of the lead group.

11. That the ores of Leadville are either rich in lead and poor in silver, rich in silver and poor in lead, or equally rich in both silver and lead, and very variable in composition; but that, by judicious admixtures of various ores, ore-beds of sensibly the same composition are made at the smelters, which are needed to insure regularity in the smelting operations.

12. That the quantity of lead completely lost in the atmosphere is sensibly twice as large as the quantity of lead caught in the dust-chambers generally used.

13. That the crude bullion extracted in the blast-furnaces of Leadville by the process referred to in section 7 is of very fair quality, and that a little of its silver and some of its lead exist there in the state of sulphides.

14. That mattes (both iron and lead mattes), which had hitherto been considered as entirely formed of sulphides, are crystallographic compounds of sulphides of iron and lead and crystallized magnetic oxide of iron. (This last observation, however, interferes in no way with the fact that in various smelting operations mattes entirely formed of sulphides are produced.)



15. That slags cannot very well be compared with minerals, from which they differ essentially; that they contain minute quantities of carbonates which have escaped destruction, and small quantities of carbon or carburets, two products which hitherto had not been generally known to exist. That slags are formed of crystallographic compounds of silicates of iron, manganese, zinc, lead, lime, and magnesia on the one hand, and on the other of a peculiar matte which is designated by the name of calcium matte, and which, like its congeners, is formed of a sulphide (sulphide of calcium) and of magnetic oxide of iron, which can be isolated in the pure crystalline state.

16. That at least three distinct metallurgical kinds of speiss, containing two distinct chemical arsenio-sulphurets of iron, are formed in lead smelting; and that they always contain small quantities of nickel and molybdenum entirely concentrated in them, showing that the metallurgy of molybdenum could be conducted jointly with that of lead with ores containing only traces of molybdenum.

17. That a very curious and a hitherto unsuspected reaction takes place in the blast-furnaces of Leadville, by means of which cobalt is completely separated from nickel (nickel being concentrated in speiss and cobalt in the skimmings of the lead-pots of blast furnaces), and showing that the metallurgy of both metals and their separation could be effected in lead furnaces by operating under conditions similar to those observed in Leadville.

18. That iron sows are a variety of speiss and present a great analogy with the latter products.

19. That lead fumes are very complicated products, characterized in Leadville by the presence of no inconsiderable amount of chloro-bromo-iodide of lead and phosphate of lead, and that they contain, contrary to the opinion formed in Leadville, but small quantities of arsenic and antimony.

20. That the practice of roasting the dust in order to free it from arsenic and antimony, as adopted at one smelter, is a useless and costly one, which ought not to be generalized in Leadville.

21. That accretions are products of sublimation, and that these products, which line the shafts of the furnaces and interfere seriously with a regular run, might be to some extent avoided, or made less troublesome, by a slight modification of the manner of charging the furnaces and by the adoption of caustic lime instead of raw limestone in smelting.

22. That some accretions are characterized by the concentration, sometimes in large quantities, of metals such as tin, arsenic, antimony, and zinc, which exist but in small quantities in the ores.

23. That the charcoal used in smelting is of very good and the coke of bad quality; but that the fuel obtained by mixing them contains 10 per cent. of ash, and that it requires a maximum amount of 32 to 33 parts of this fuel for 100 parts of ore, and 24 parts for 100 parts of charges, to effect smelting; but that at several smelters these percentages are considerably lowered.

24. That for every 100 parts of carbon thrown in the furnaces with the smelting charges, only 40.36<sup>1</sup> parts reach the zone of combustion at the tuyeres, the balance being oxidized in the upper zones to carbonic oxide, chiefly by the carbonic acid formed in the zone of combustion, involving, as is well known, an absorption of heat.

---

<sup>1</sup>This figure differs from that given in the abstract of this report published in the Second Annual report of the Director of the United States Geological Survey (1880-'81), several clerical errors in Mr. Guyard's calculations having been discovered since that appeared. (S. F. E.)

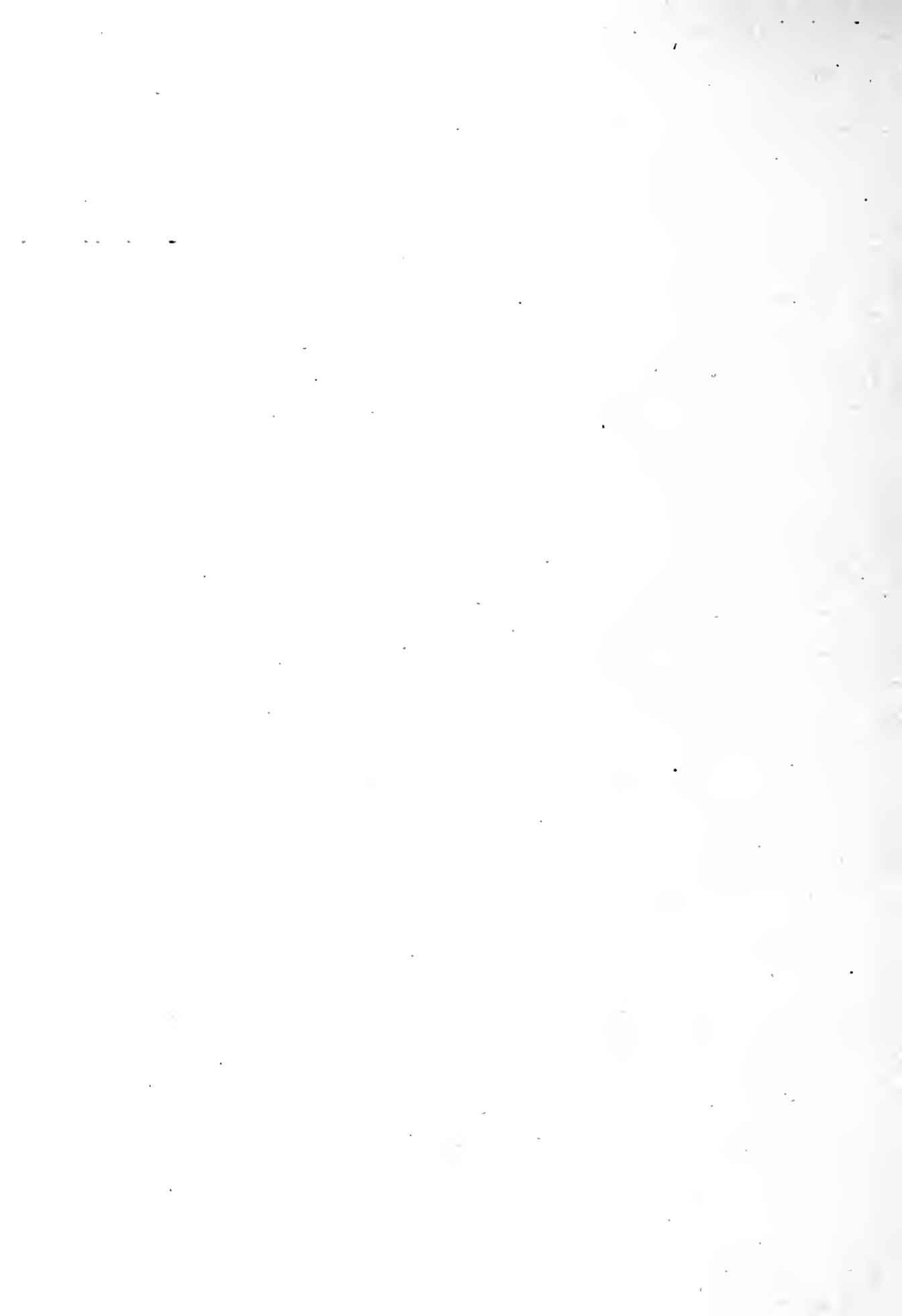

## LIST OF METALLURGICAL PLATES.

- PLATE XXIII.—Circular furnace. Smelter A.  
Fig. 1. Elevation.  
Fig. 2. Horizontal section at tuyeres.  
Fig. 3. Vertical section through lead-pot.  
Fig. 4. Horizontal section above water-jackets.
- XXIV.—Reverberatory furnace and dust-chamber. Smelter A.  
Fig. 1. Reverberatory furnace in side elevation.  
Fig. 2. Dust-chamber, vertical section.  
Fig. 3. Dust chamber, horizontal section.
- XXV.—Flue arrangement. Smelter A.  
Perspective view of furnaces and dust-chambers.
- XXVI.—Rectangular furnace. Smelter B.  
Fig. 1. Elevation.  
Fig. 2. Horizontal section at tuyeres.  
Fig. 3. Vertical section through slag-gutter.  
Fig. 4. Horizontal section at charging-floor.
- XXVII.—Circular furnace. Smelter B.  
Fig. 1. Elevation.  
Fig. 2. Horizontal section at tuyeres.  
Fig. 3. Vertical section through lead-pot.
- XXVIII.—Bartlett smoke-filter. Smelter B.  
Fig. 1. Elevation of furnace and filter, with connecting pipe.  
Fig. 2. Side elevation of filter.
- McAllister charcoalkiln.  
Fig. 3. Vertical section through charging-door.  
Fig. 4. Elevation.
- XXIX.—Rectangular furnace. Smelter C.  
Fig. 1. Elevation.  
Fig. 2. Horizontal section at tuyeres.  
Fig. 3. Vertical section on shorter diameter.  
Fig. 4. Horizontal section at crucible.  
Fig. 5. Vertical section on longer diameter.
- XXX.—Brick dust-chamber. Smelter C.  
Fig. 1. Vertical longitudinal section.  
Fig. 2. Horizontal longitudinal section.  
Figs. *b, c, d, e, f, g*, partition walls between compartments.
- XXXI.—Fig. 1. Blast arrangement at Smelter C.  
Fig. 2. Elevation showing disposition of plant at Smelter C.
- XXXII.—Furnace and dust-chamber. Smelter D.  
Fig. 1. Front elevation.  
Fig. 2. Vertical section on shorter diameter.  
Fig. 3. Side elevation.  
Fig. 4. Elevation of dust-chamber.

PLATE XXXIII.—Furnace and dust-chamber. Smelters F and M.

Fig. 1. Elevation of rectangular furnace at Smelter F, showing patent tuyeres.

Fig. 2. Iron dust-chamber at Smelter M.

XXXIV.—Iron dust-chamber. Smelter F.

Fig. 1. Side elevation of dust-chamber.

Fig. 2. Elevation, showing connection with furnace.

XXXV.—Square furnaces. Smelter G.

Fig. 1. Smaller furnace, side elevation.

Fig. 2. Larger furnace, front elevation.

XXXVI.—Smelter G.

Fig. 1. General elevation of furnaces, showing dust-chambers, flues, and stack.

Fig. 2. Section of furnace at Smelter C, showing zones of temperature.

XXXVII.—Circular furnace. Smelter H.

Fig. 1. Perspective view.

Fig. 2. Vertical section through furnace and dust-chamber.

XXXVIII.—Fig. 1. Dust-chamber at Smelter H.

Fig. 2. Jolly's specific-gravity spring-balance.

XXXIX.—Assay furnace at Smelter H, in isometric projection.

XL.—Dust-chamber at Smelter J.

Fig. 1. Side elevation showing round furnace.

Fig. 2. Plan of furnaces and dust chamber.

XLI.—Blake crushers.

Fig. 1. Horizontal projection } of Eccentric crusher.

Fig. 2. Vertical section

Fig. 3. Perspective view } of Challenge crusher.

Fig. 4. Vertical section

XLII.—Blowers.

Fig. 1. Perspective view

Fig. 2. Transverse vertical section } Blake's rotary blower.

Fig. 3. Perspective view

Fig. 4. Transverse vertical section } Root's positive-blast blower.

XLIII.—Assay implements.

Figs. 1 and 2. Slag mold.

Figs. 3 and 5. Crucibles.

Fig. 4. Scorifier.

Fig. 6. Cupel.

Fig. 7. Guyard's specific-gravity apparatus.

Fig. 8. Sieve for pulverized ore.

Figs. 9 and 10. Bucking-plate.

Fig. 11. Bucker.

Fig. 12. Iron pestle and mortar.

XLIV.—Smelter's implements.

Figs. 1, 2, and 3. Fuel shovels.

Figs. 4 and 5. Ore shovels.

Fig. 6. Tapping-rod.

Fig. 7. Bar used for detaching accretions.

Fig. 8. Curved bar for cleaning siphon-tap.

Figs. 9 and 10. Brick-mold.

Fig. 11. Wire used in cutting clay in molds.

Fig. 12. Chisel or punch for taking assay bits from bullion.

Fig. 13. Form of assay bit-taken.

Fig. 14. Another form of chisel.

Fig. 15. Assay bit taken by latter.

XLV.—Fig. 1. Alden ore-crusher, in perspective.

Fig. 2. Disposition of furnace, dust-chamber, and blower. Smelter I.

Figs. 3 to 7. Forms of bullion molds.

## INDEX OF LETTERS USED ON PLATES.

*A*, crucible.  
*A'*, interior of crucible.  
*A''*, dam of crucible.  
*a*, sheathing of crucible.  
*a'*, sheathing of lead-pot.  
*B*, water-jackets.  
*B'*, slag-pot.  
*b*, fire-brick above water-jacket.  
*C*, masonry of shaft of furnace.  
*C'*, walls of shaft of furnace.  
*D*, chimney.  
*D'*, dust-chamber.  
*d*, sheathing on top of crucible.  
*E*, stack.  
*F*, stack to dust-chamber.  
*F'*, flue to dust-chamber.  
*G* (*G'*), damper.  
*H*, feed-holes.  
*I*, induction blast-pipe.  
*J*, branch blast-pipe from *I*.  
*J*, iron jacket to furnace.  
*K*, wind-bags.  
*L*, lead-pot.  
*L'*, siphon.  
*l*, sliding valve of tuyere.  
*M*, cold-water conduits.  
*M'*, hot-water outlet.

*N*, tuyere.  
*n*, tuyere-holes.  
*O*, cast-iron bed-plate.  
*O'*, vertical flange of bed-plate.  
*O''*, projecting horizontal flange on *O* (in circular furnaces).  
*P*, cast iron pillars.  
*P'*, feeding-floor.  
*Q*, braces on *C*.  
*q*, water-jacket clamps.  
*R*, water-jacket feeder.  
*R'*, main blast-pipe, feed of *T'*.  
*r*, brackets on *O'*.  
*S'* (*S''*), sliding-doors of feed-openings.  
*s*, outlet-pipes of *R*.  
*T*, water-gutter.  
*T'*, blast-pipe, feed of *I*.  
*t*, brackets of pillars.  
*U*, slag-gutter.  
*V*, slag-outlet in water-jacket.  
*W*, hood.  
*W'*, chimney of hood.  
*X*, fore-hearth.  
*X'*, hearth.  
*Y*, cold-water faucets.  
*Z*, tap-hole in *V*.



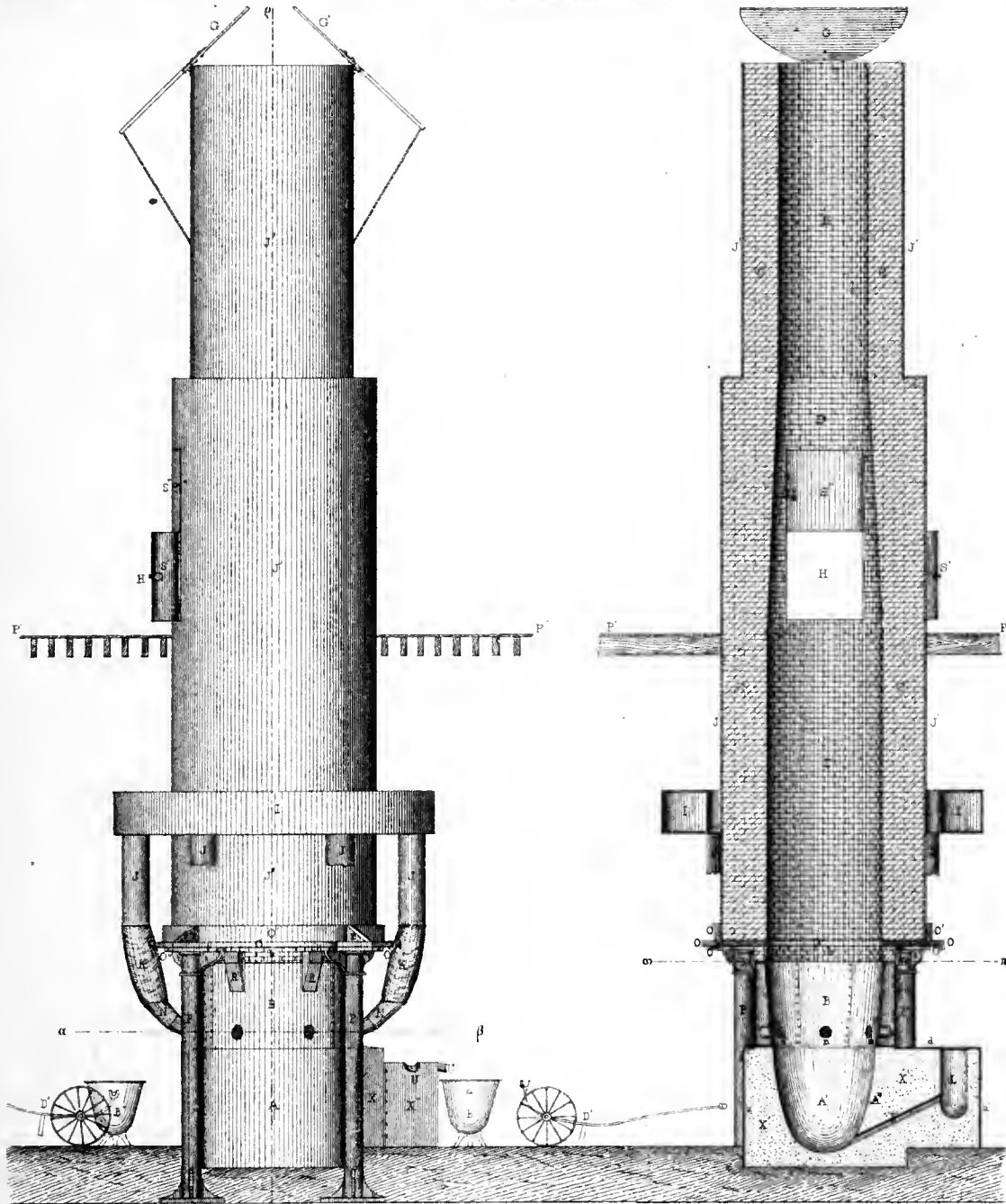

Fig. 1 ELEVATION

Fig. 3 SECTION ON ρσ

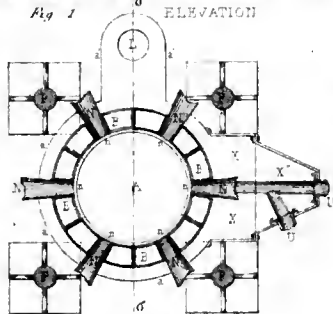

Fig. 2 SECTION ON αβ

Cast Iron	Wrought Iron
Fire Brick	Steep

Scale 1 inch to 6 feet  
or 1/32

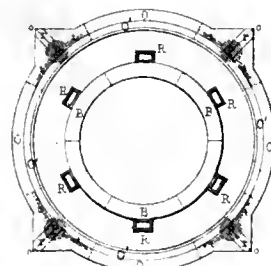
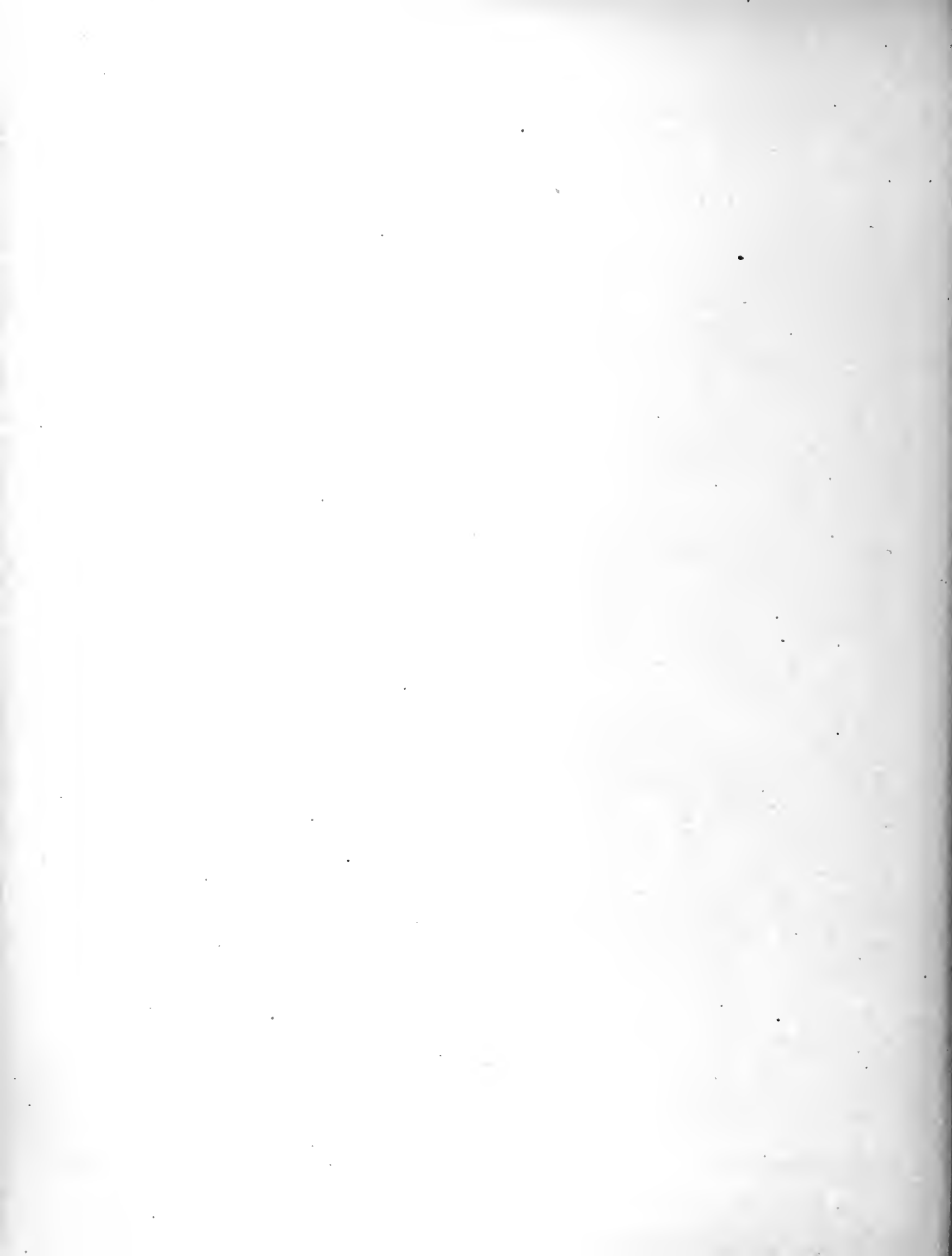

Fig. 4 SECTION ON ωπ

M. E. 4-1





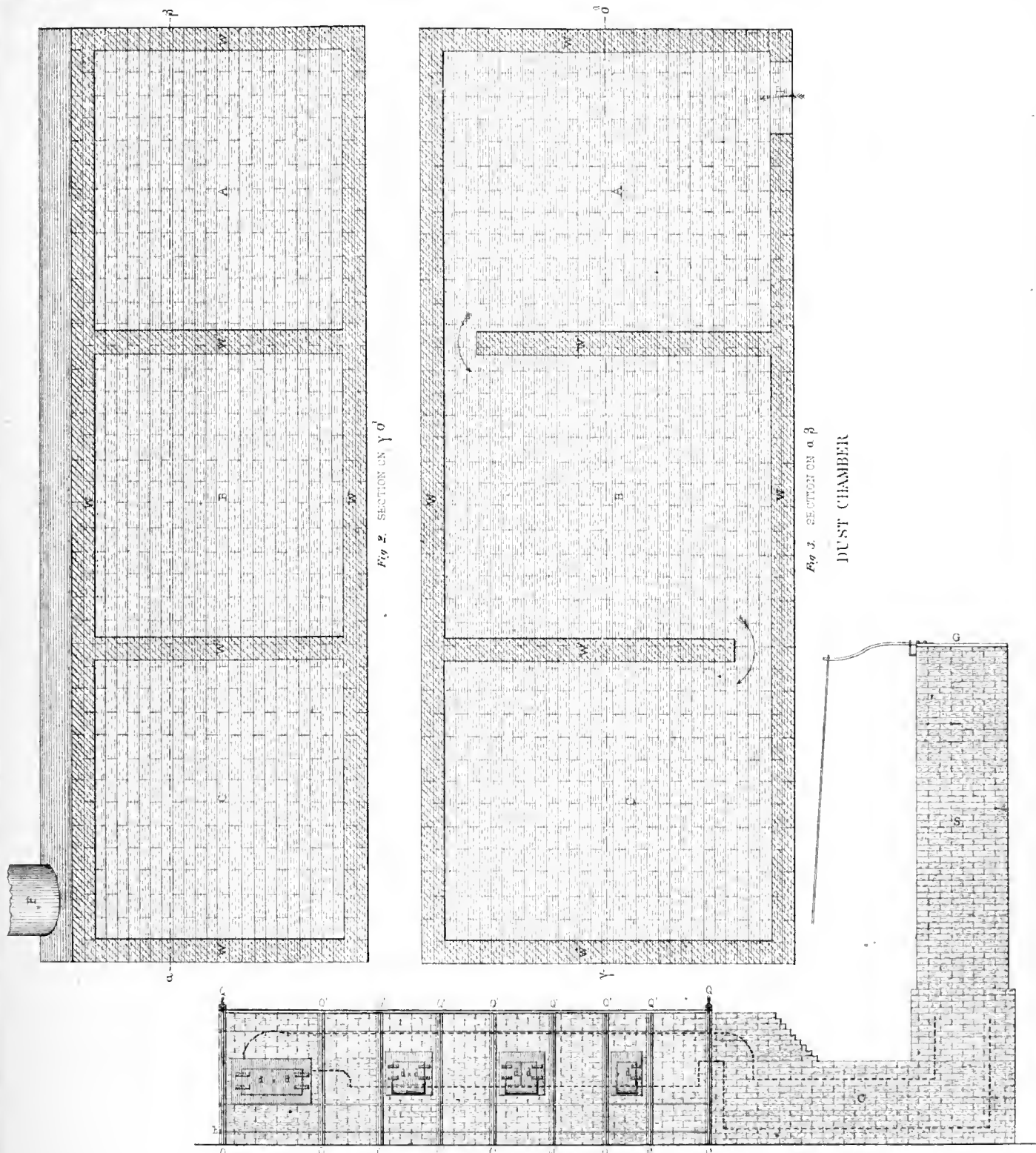

Fig. 1. REVERBERATORY FURNACE

Scale 1 inch to 6 feet, or 1.52

FEET

METERS

M. Brien co.

REVERBERATORY FURNACE AND DUST CHAMBER SMELTER A.

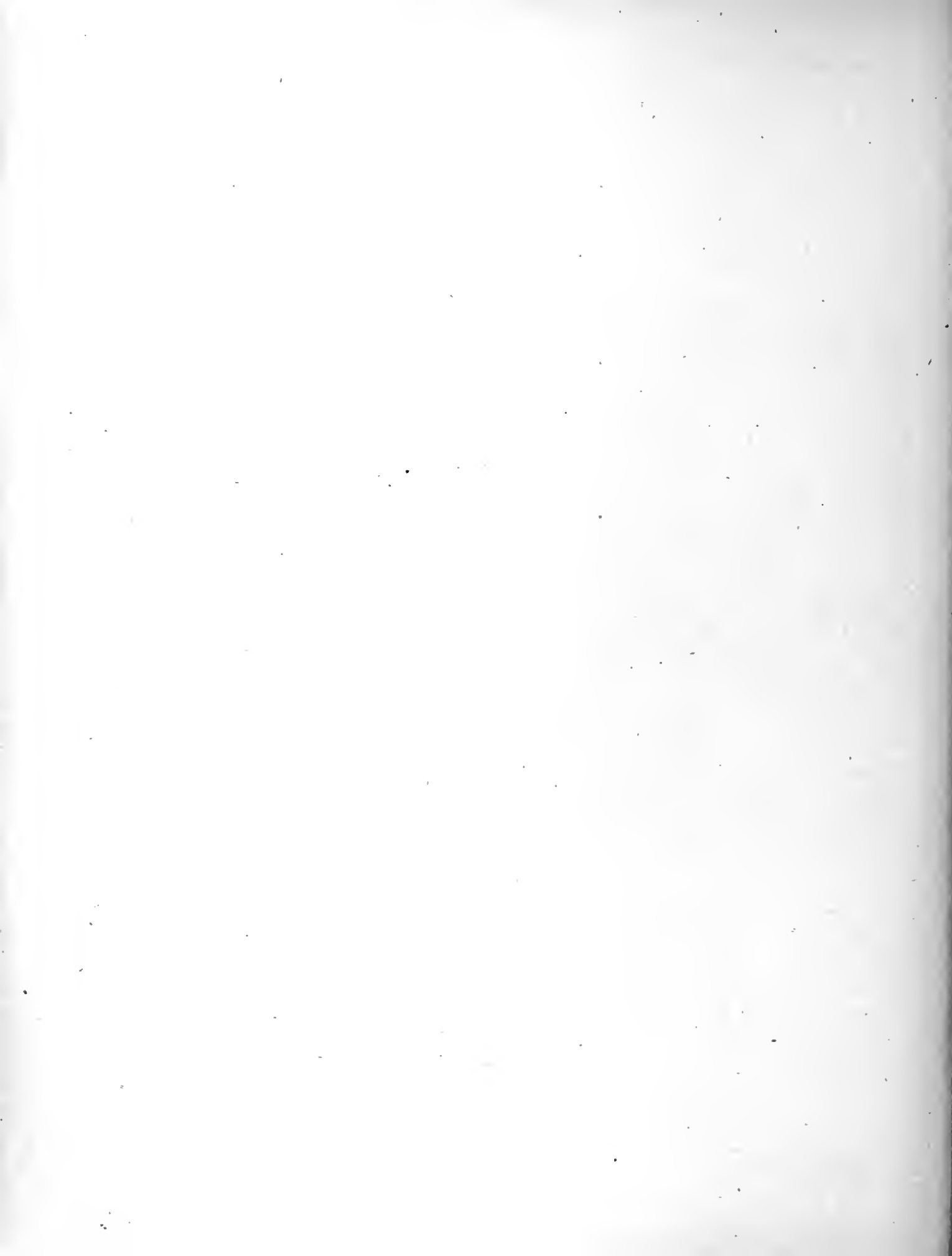



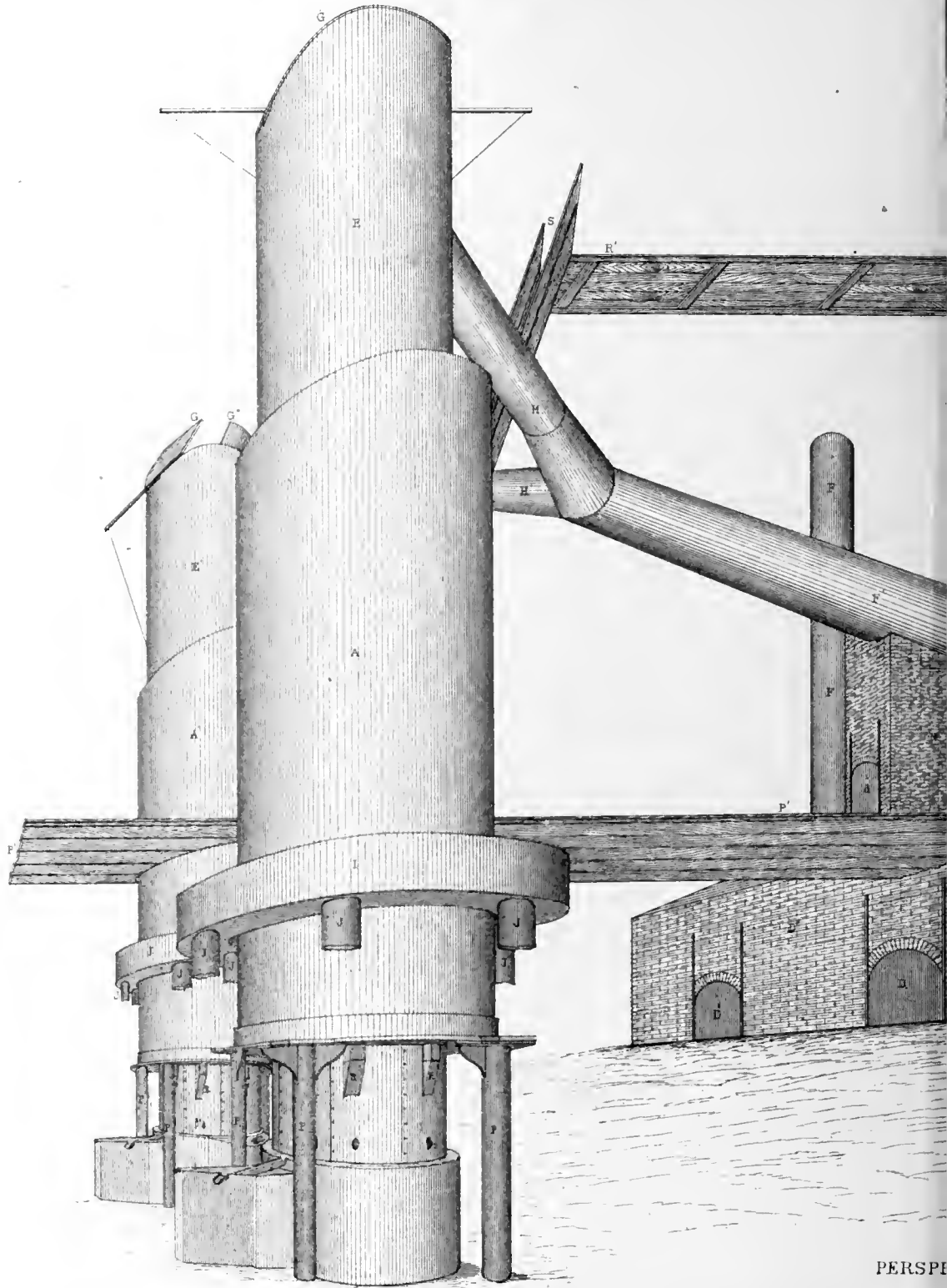

PERSPE

A. Guyard, Metallurgist.

Julius B.  
FLUE AR  
SM

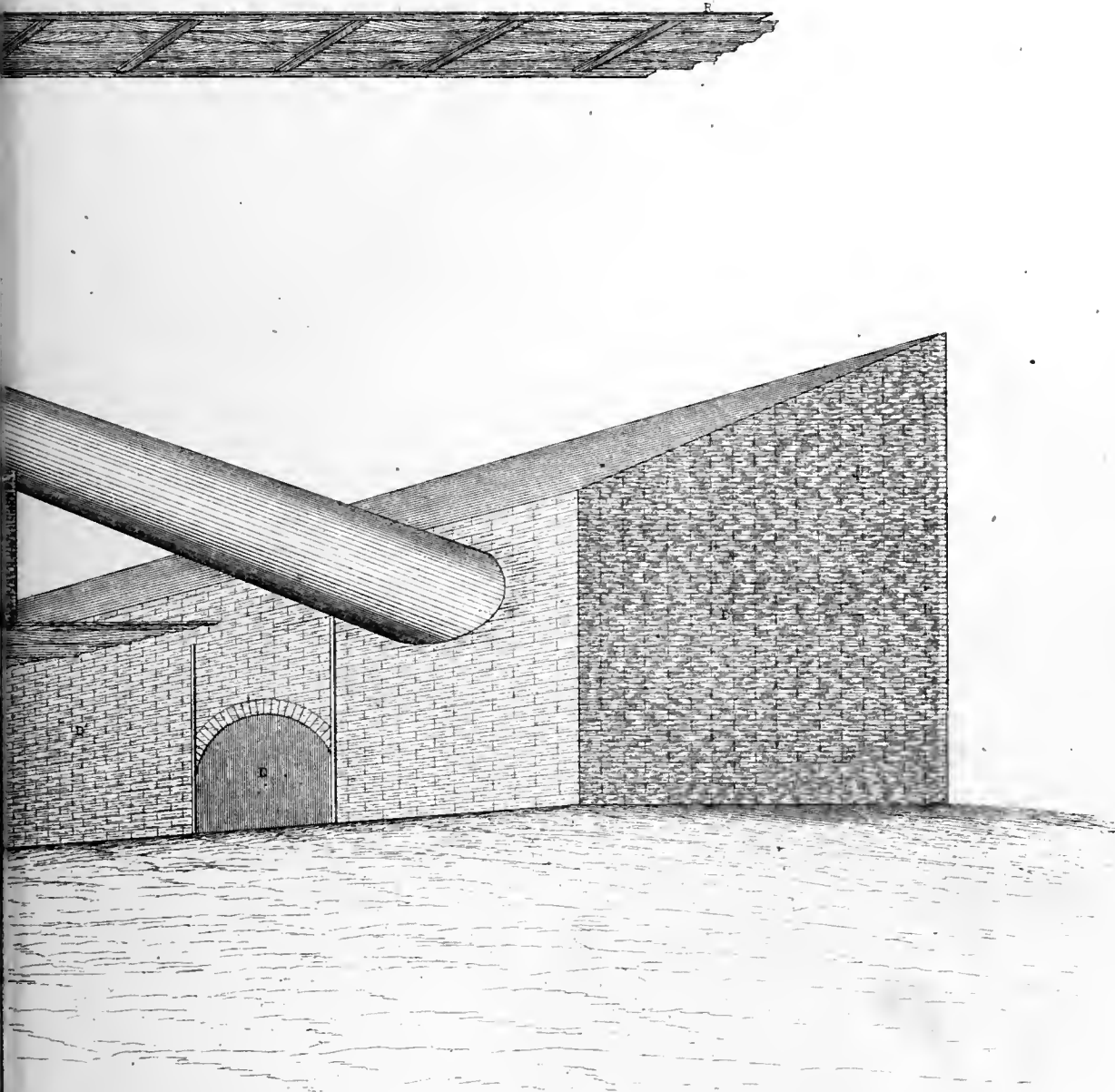

IVE VIEW

olith.  
GEMENT  
ER A.

S.F. Emmons, Geologist-in-Charge



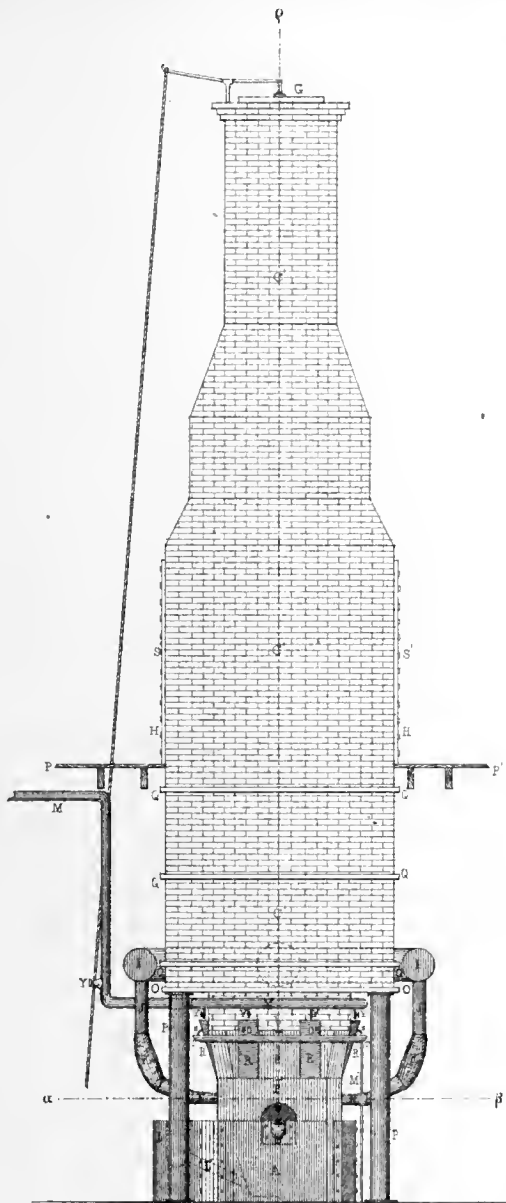

Fig. 1. ELEVATION

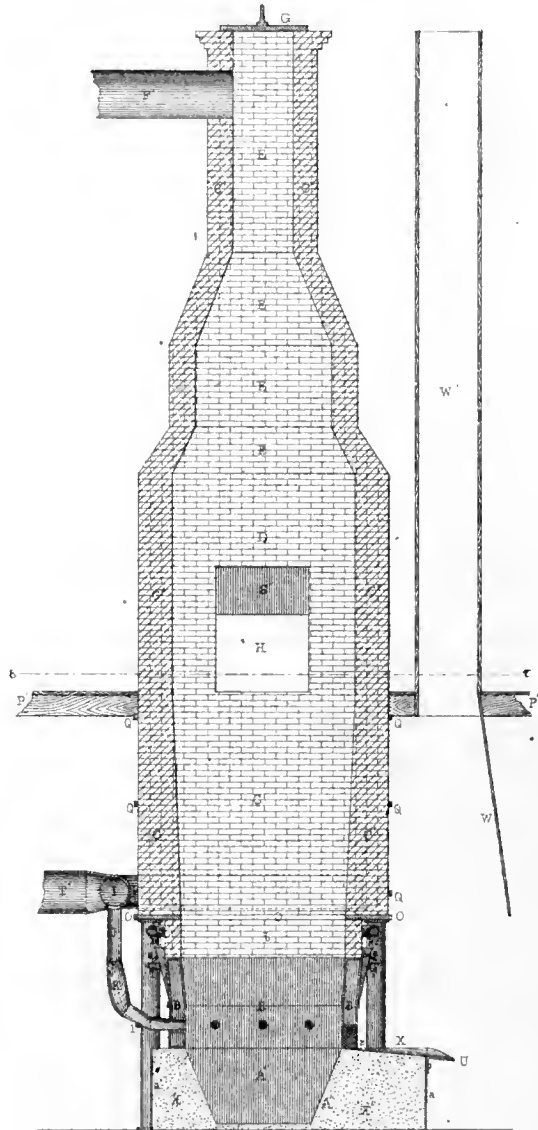

Fig. 3. SECTION ON Qσ

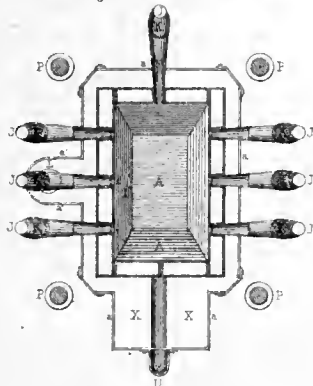

Fig. 2. SECTION ON αβ

Cast Iron	Wrought Iron
Fire Brick	Steep

Scale 1 inch to 6 feet  
or 3/4"

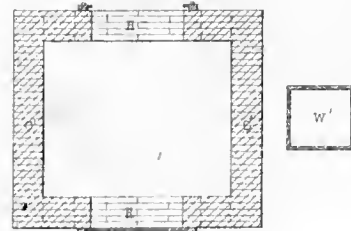

Fig. 4. SECTION ON ετ

M. Bien des.





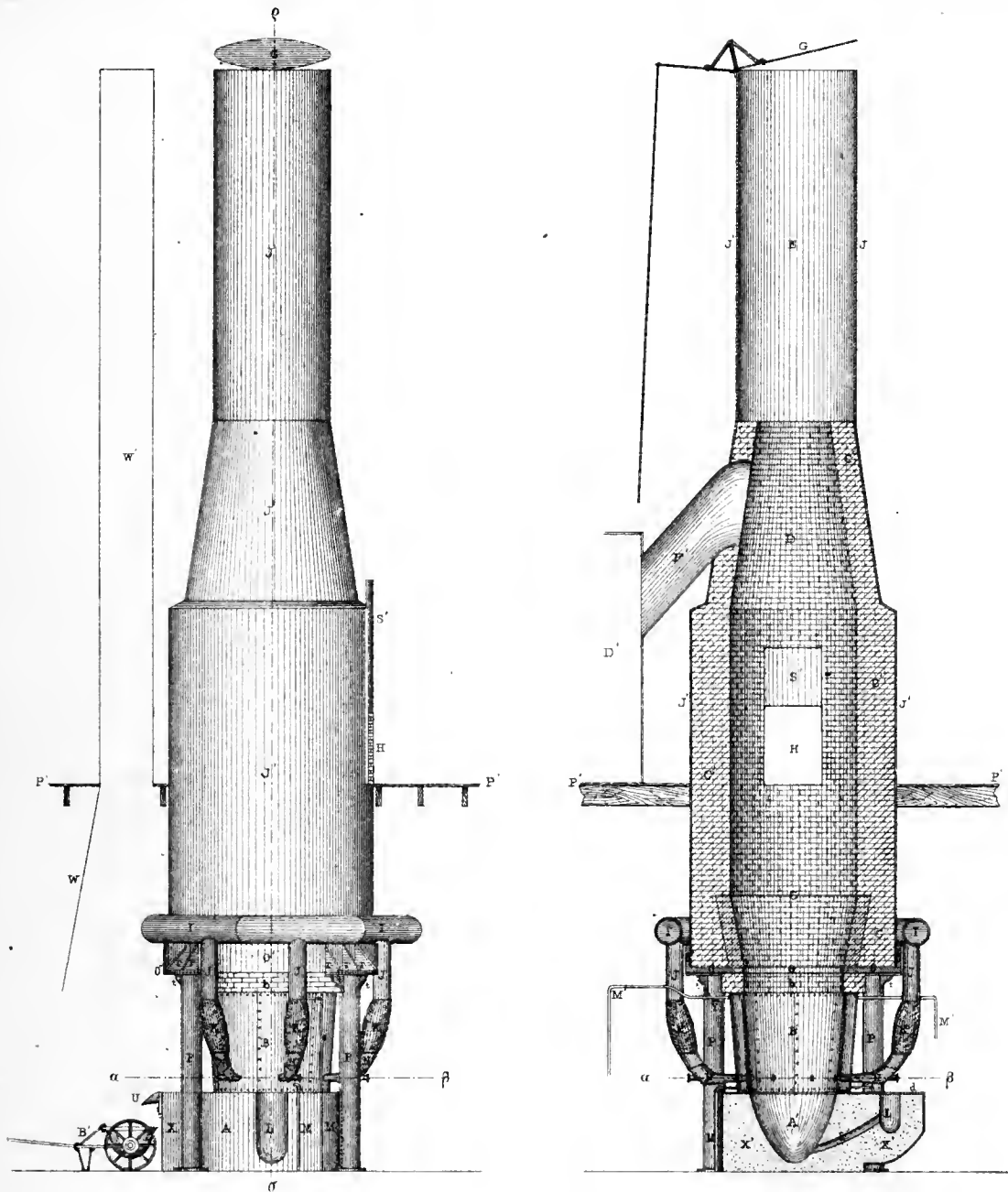

Fig 1 ELEVATION

Fig 3 SECTION ON q-s

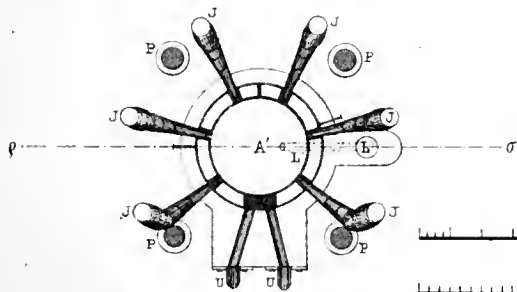
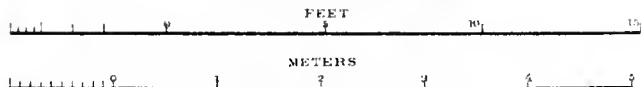

Fig 2 SECTION ON alpha-beta

Cast Iron	Wrought Iron	Clay	Steep

Scale 1 inch to 6 feet or 1.72



M. Dean del.



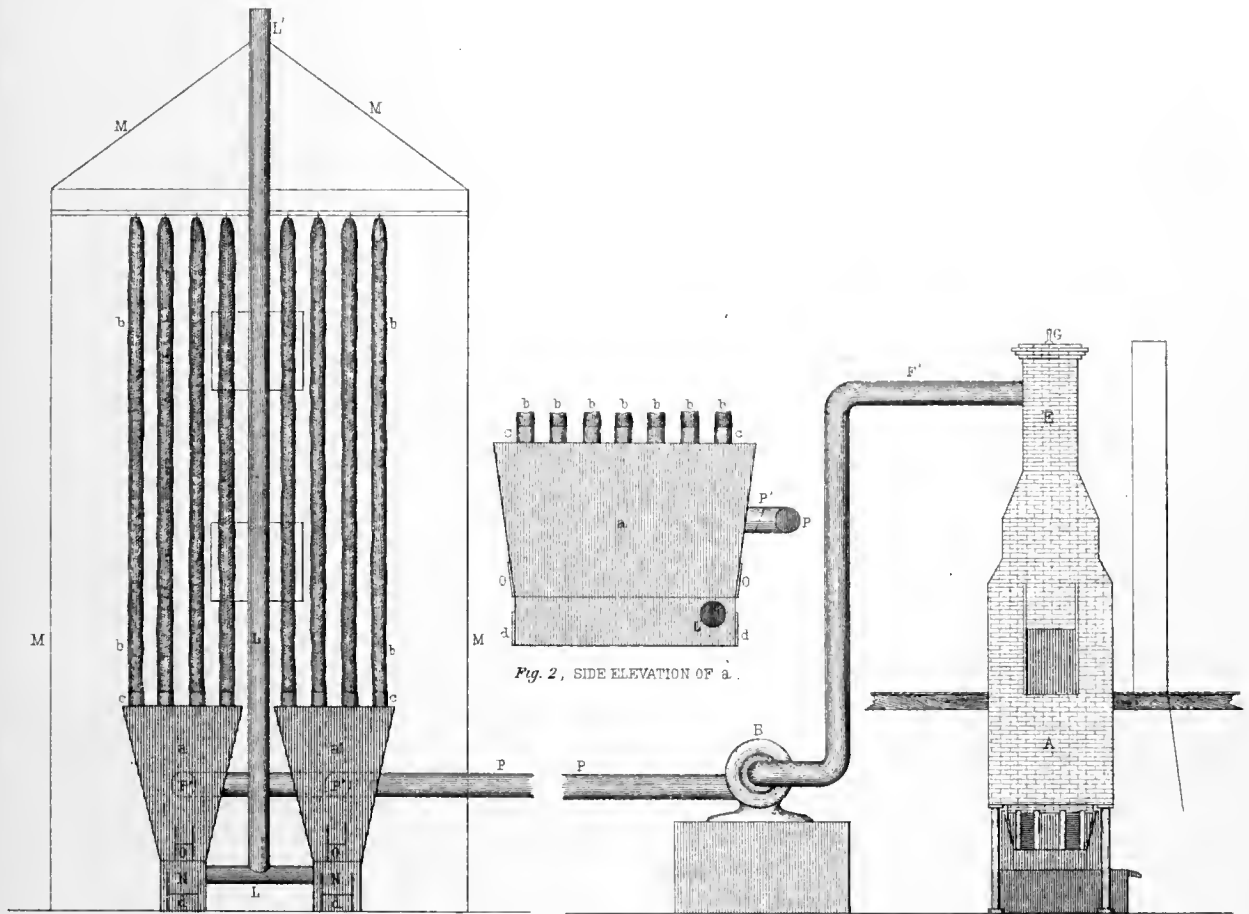

Fig. 2, SIDE ELEVATION OF a.

Fig. 1, ELEVATION.

BARTLETT'S SMOKE FILTER, SMELTER B.

Scale: 12 ft. = 1 in.



Fig. 3, SECTION ON q b.

Fig. 4, ELEVATION.

Mc ALLISTER CHARCOAL KILN.

Scale: 12 ft. = 1 in.

M Bien del.

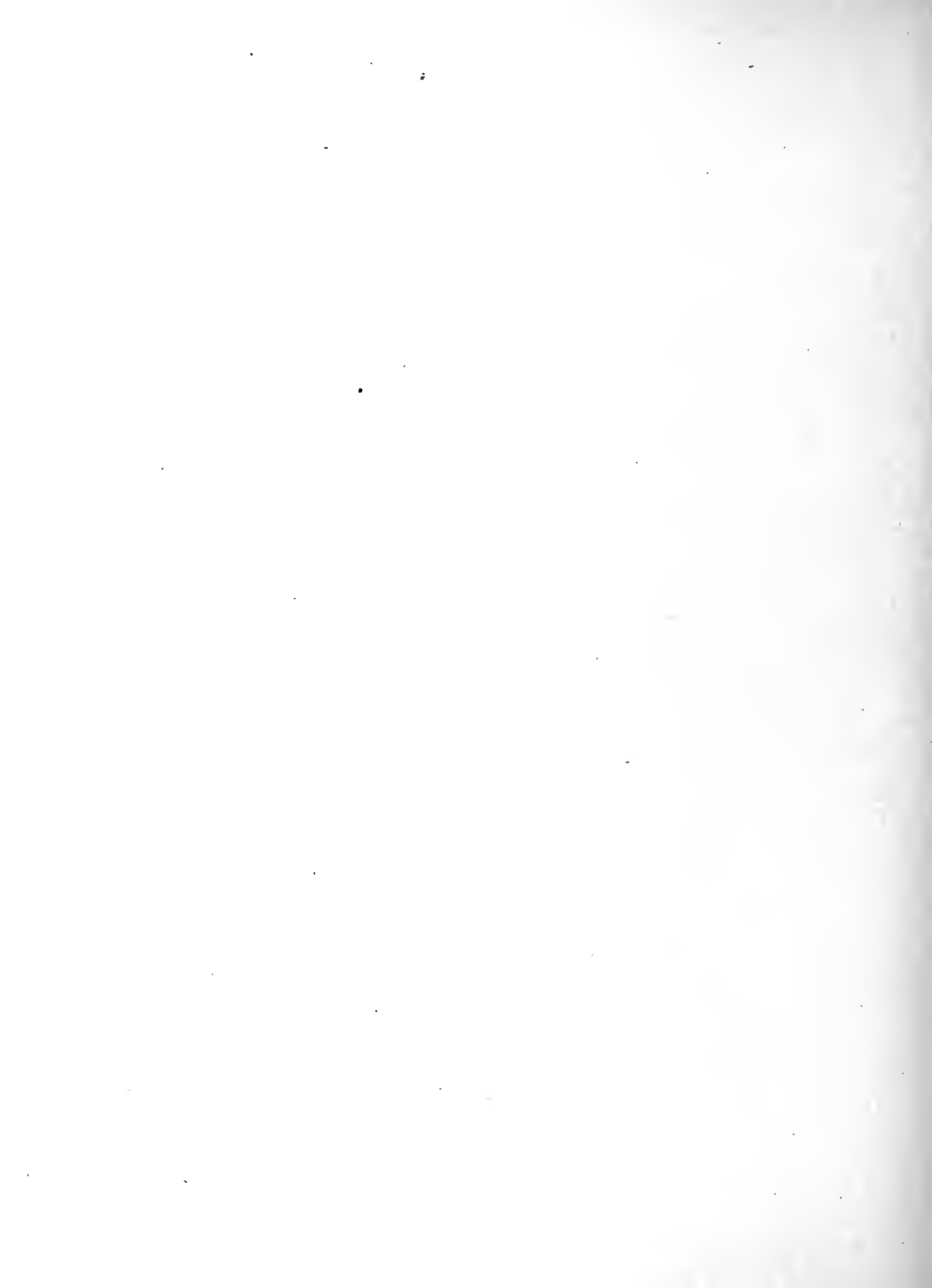

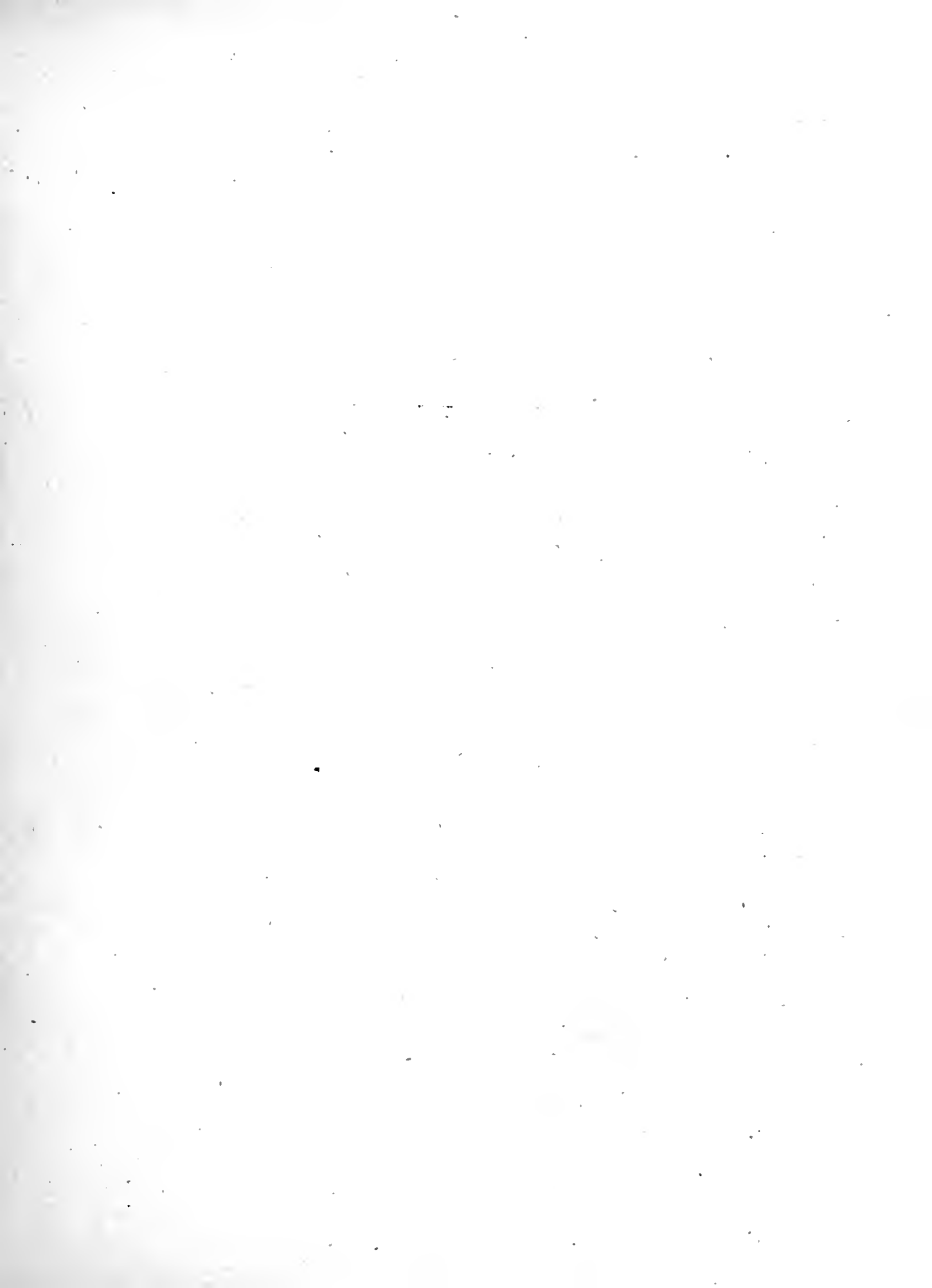

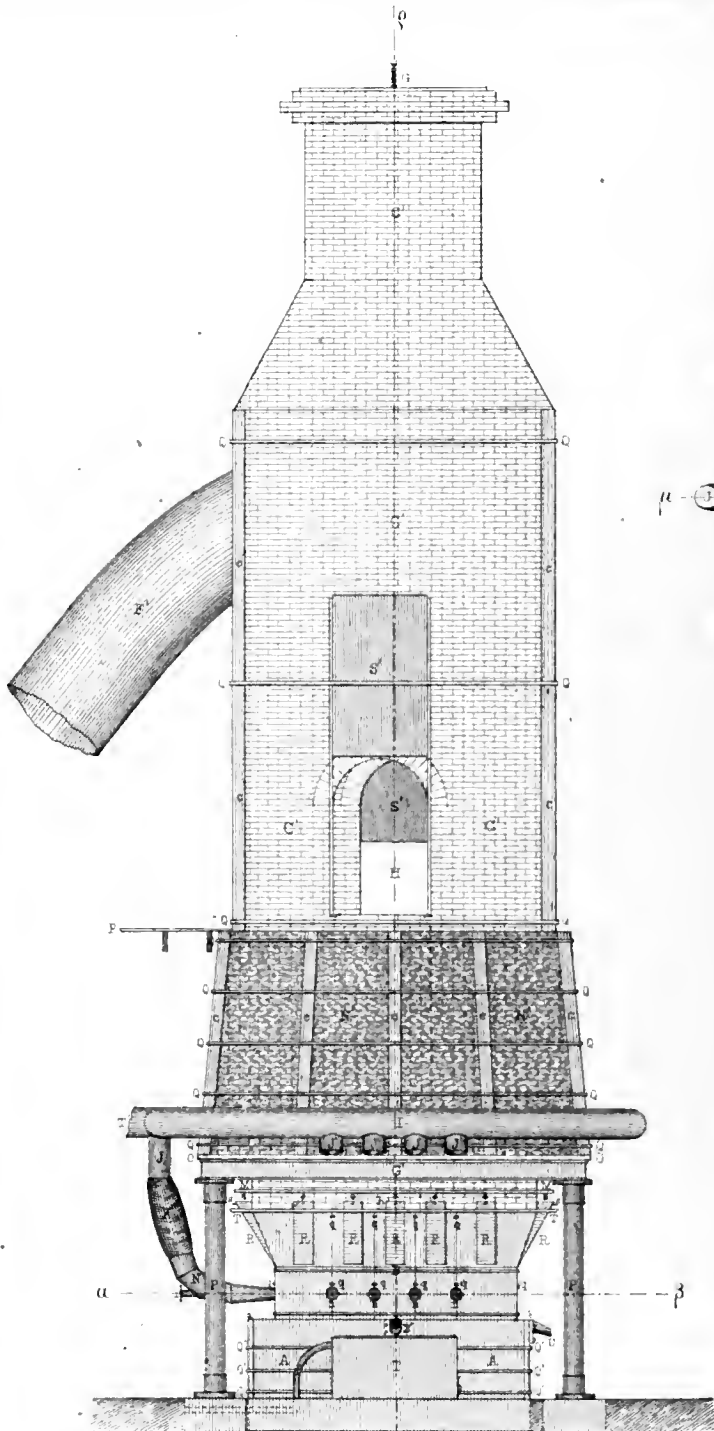

Fig. 1 ELEVATION

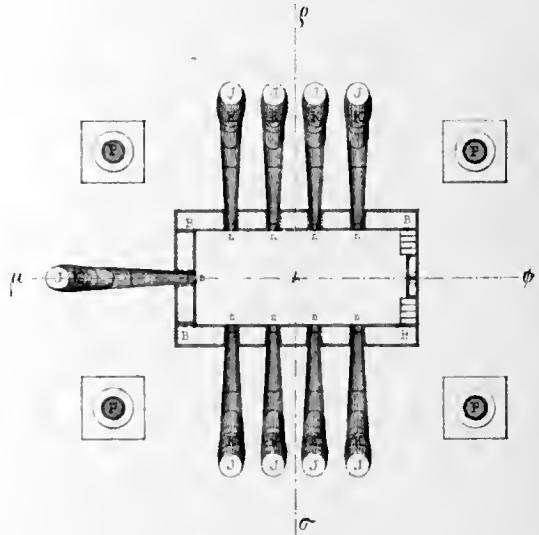
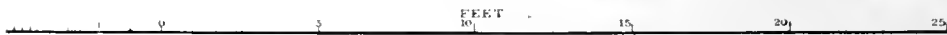

Fig. 2 SECTION ON a beta



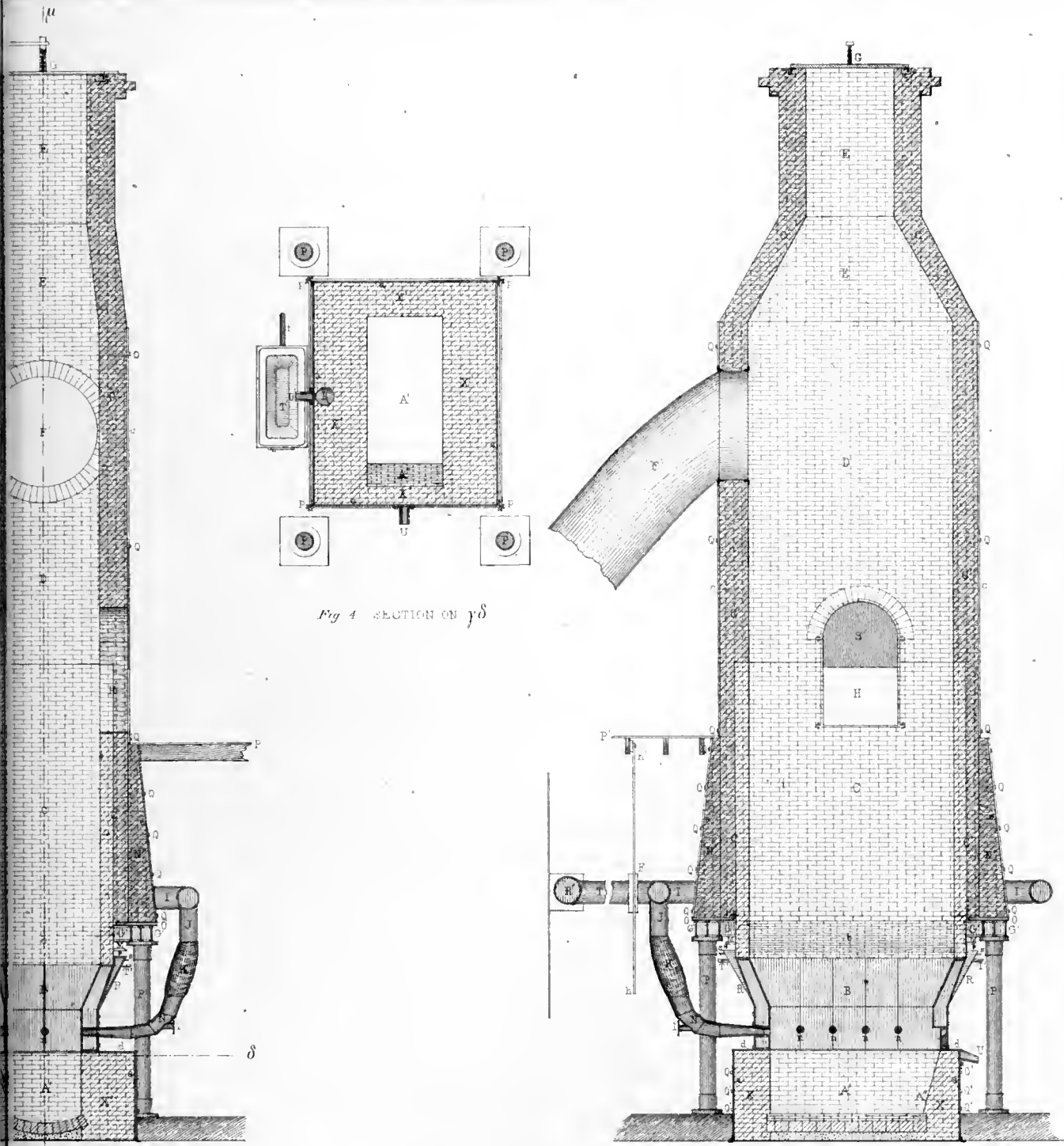

Fig. 4 SECTION ON  $\gamma\delta$

Fig. 5 SECTION ON  $\mu\phi$

Steep      Wrought Iron      Cast Iron

METERS

SECTION ON  $\rho\sigma$

feet or 3-72

FURNACE  
R. C.

S. F. Emmons, Geologist-in-Charge.

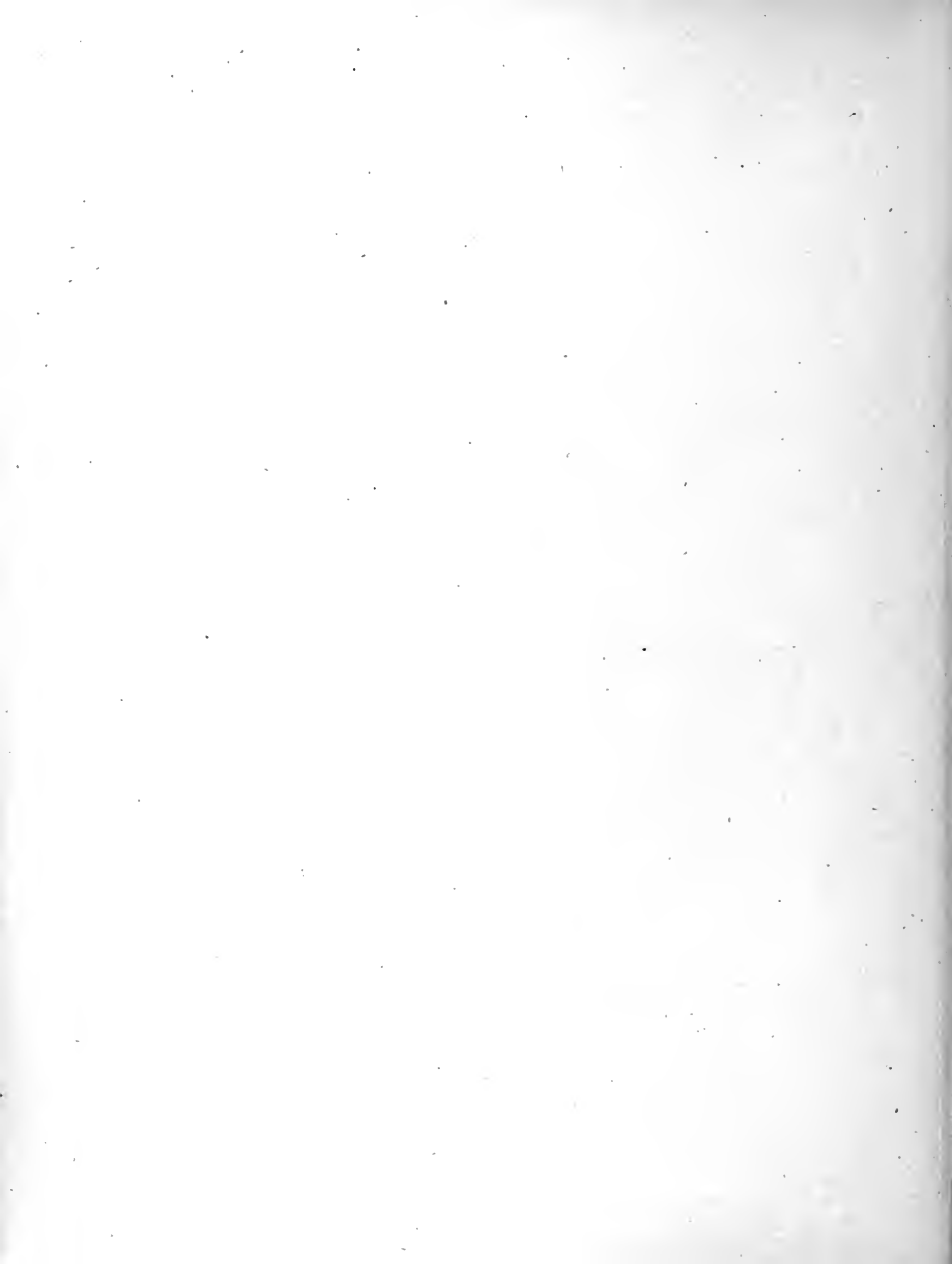



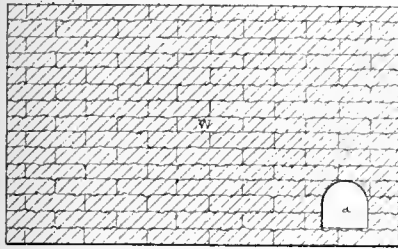

Fig. b SECTION ON 1-2

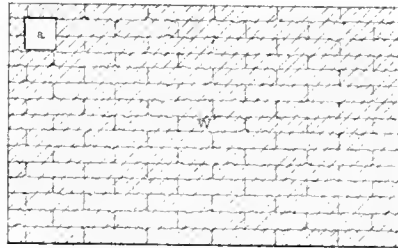

Fig. c SECTION ON 3-4

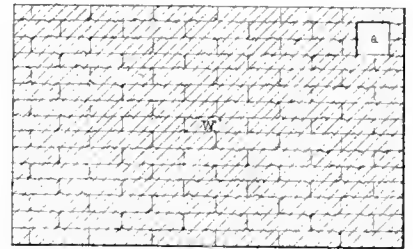

Fig. d SECTION ON 5-6

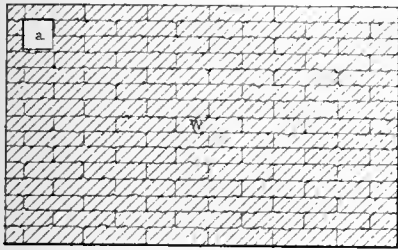

Fig. e SECTION ON 7-8

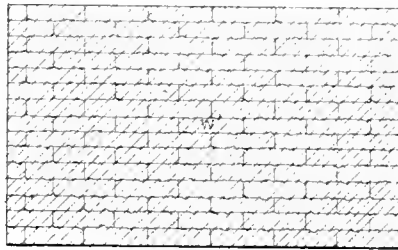

Fig. f SECTION ON 9-10

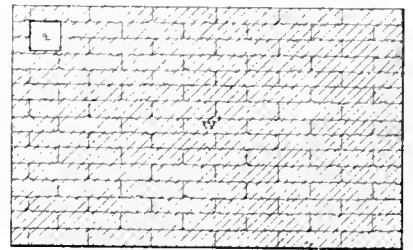

Fig. g SECTION ON 11-12

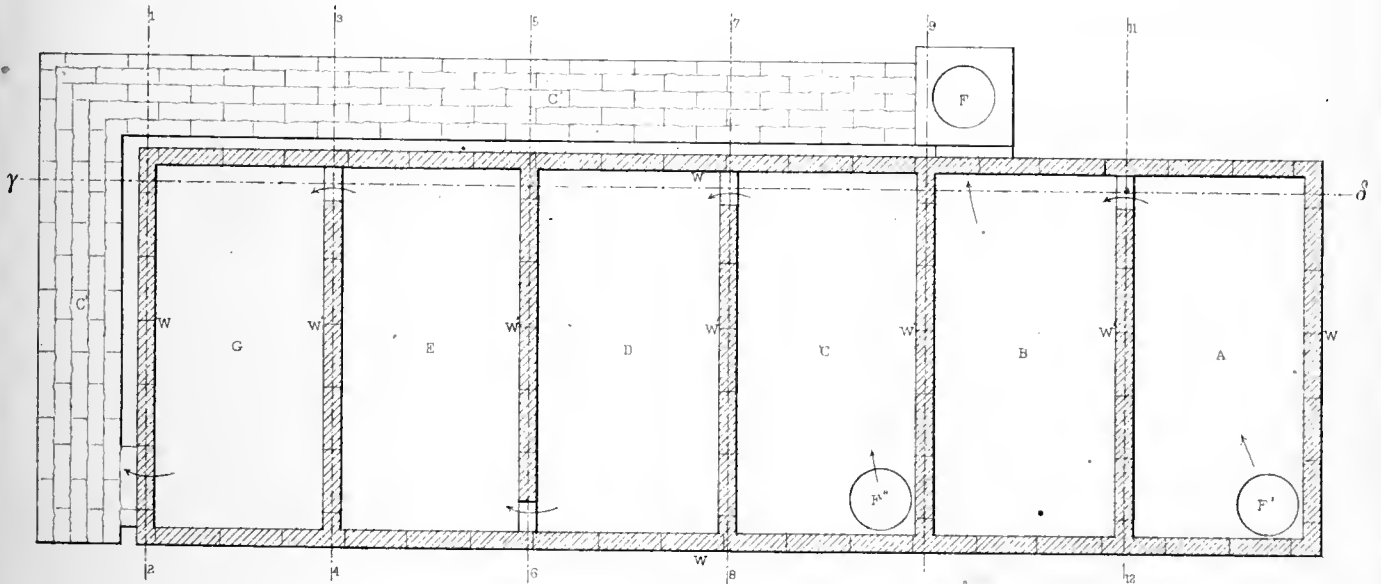

Fig. 2 SECTION ON alpha beta

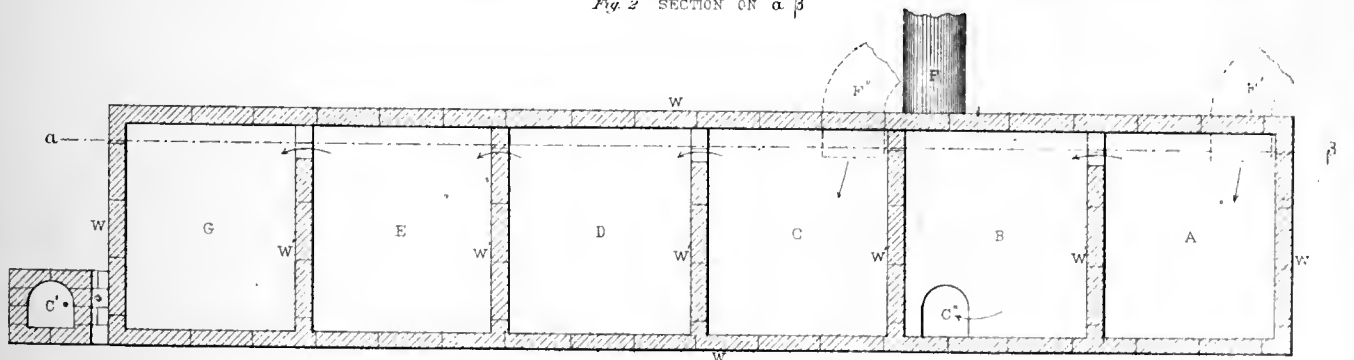

Fig. 1 SECTION ON gamma delta

Scale 1 inch to 12 feet or 1/444.

M. Bien



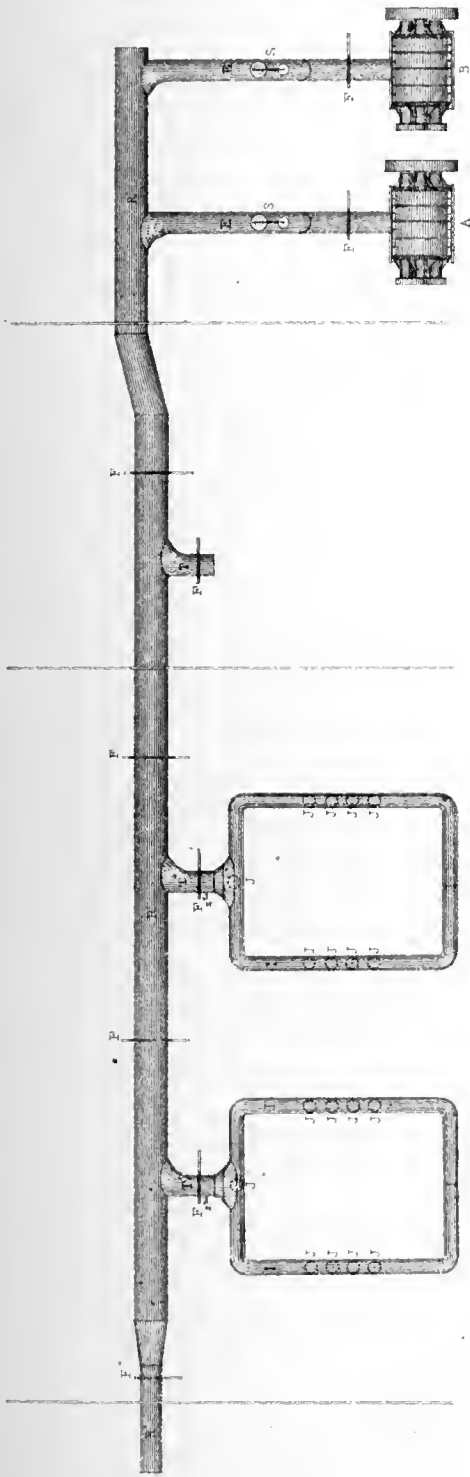

Fig. 1. BLAST ARRANGEMENT

Scale 1 inch to 12 feet. 07'3,144

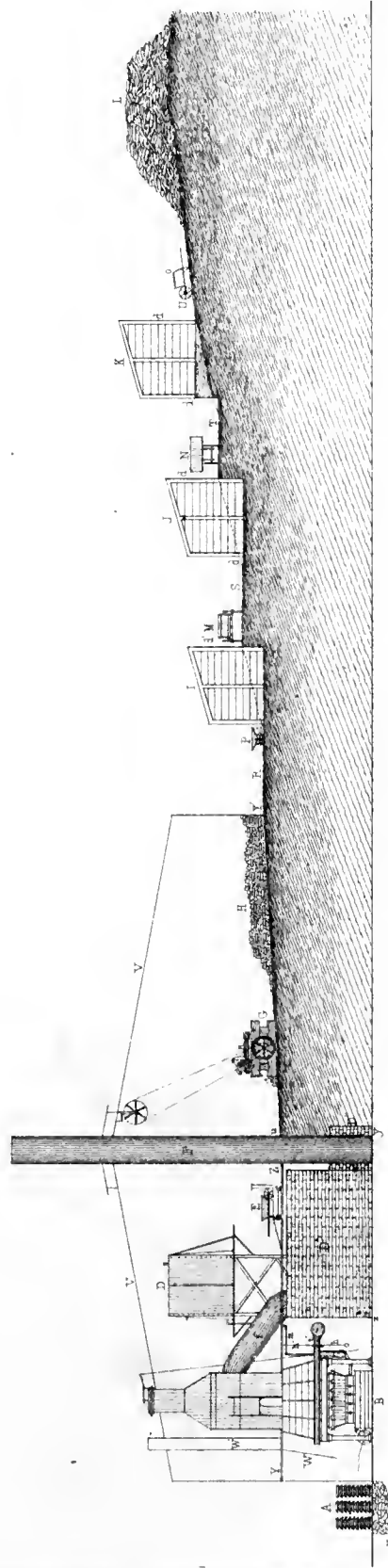

Fig. 2. ELEVATION OF WORKS

Scale 1 inch to 30 feet. 07'3,590

M Bendel

S. F. Emmons, Geologist-in-Charge

Julius Bien & Co. Bib

SMEILER C.

A. Guyard, Metallurgist.



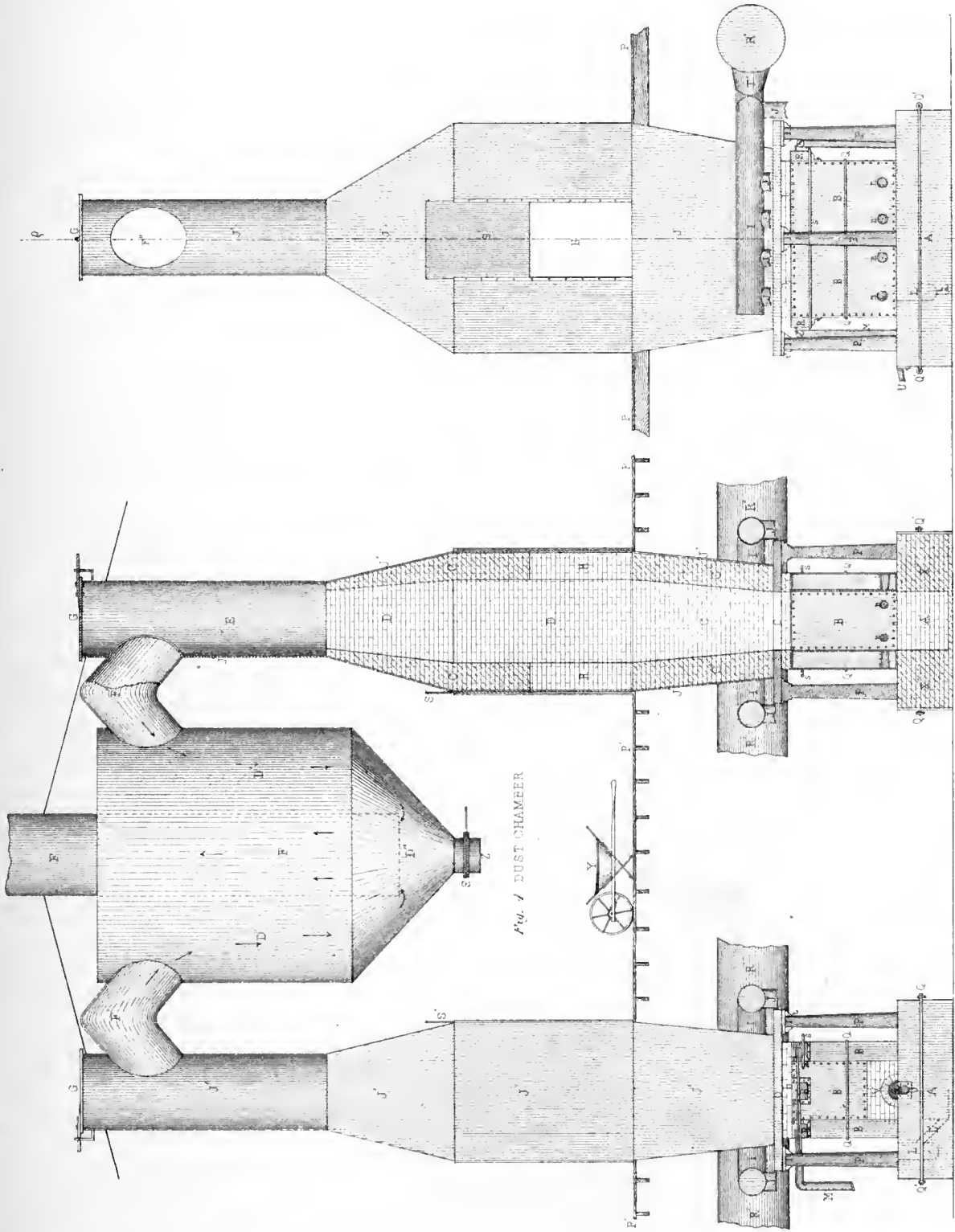

Scale 1 inch to 6 feet, or 1/2  
 Fig. 1 FRONT ELEVATION  
 Fig. 2 SECTION ON G-G  
 Fig. 3 SIDE ELEVATION  
 Cast Iron  
 Wrought Iron  
 Fire-Brick  
 Clay  
 M. Bar. 1/4

A. Guyard, Metallurgist.  
 Julius Haas & Co. Bldg.  
 FURNACE AND DUST CHAMBER  
 SMELTER D.  
 S. F. Emmons, Geologist-in-Charge



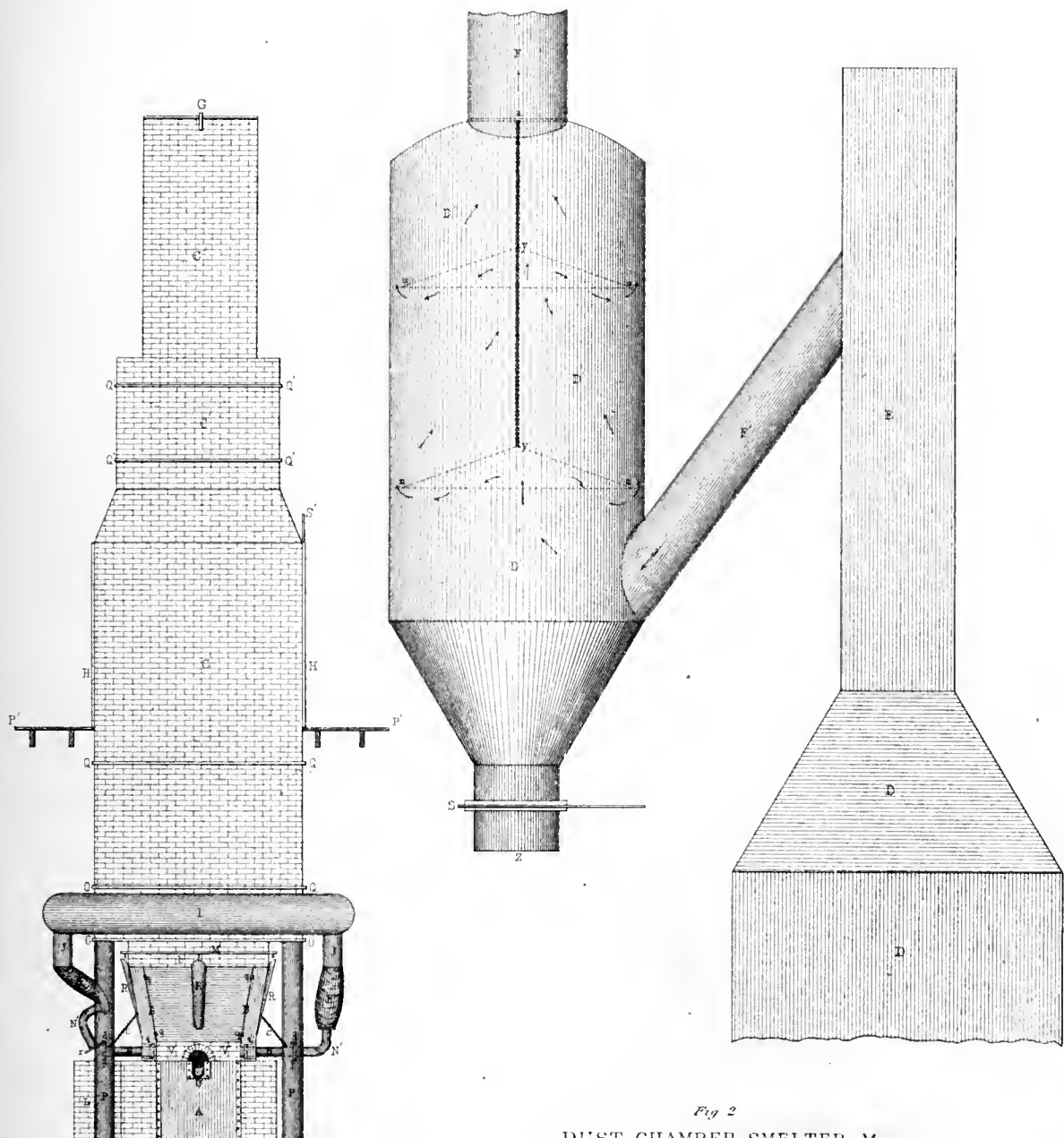
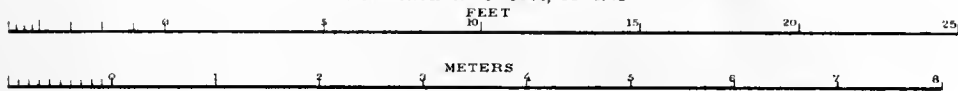

Fig. 1 ELEVATION  
FURNACE SMELTER F

Fig. 2  
DUST CHAMBER SMELTER M

Scale 1 inch to 6 feet, or 1:72







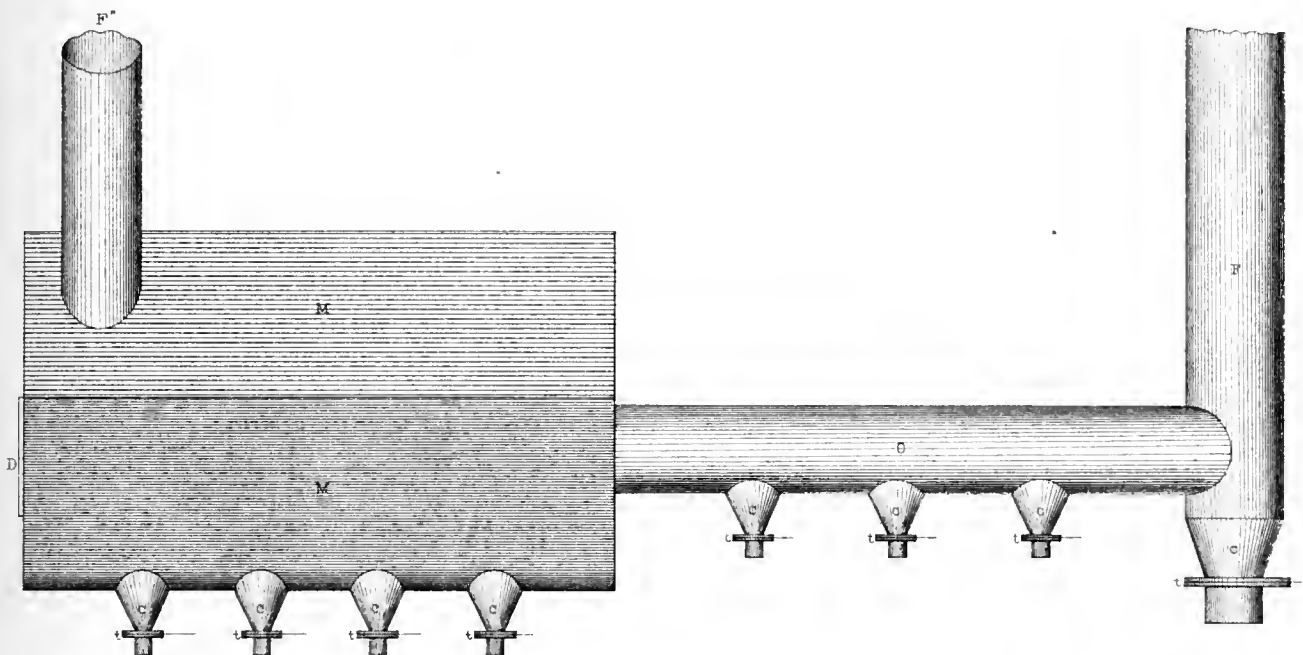

Fig. 1, SIDE ELEVATION

Scale 1 inch to 6 feet, or  $\frac{1}{2}$ "

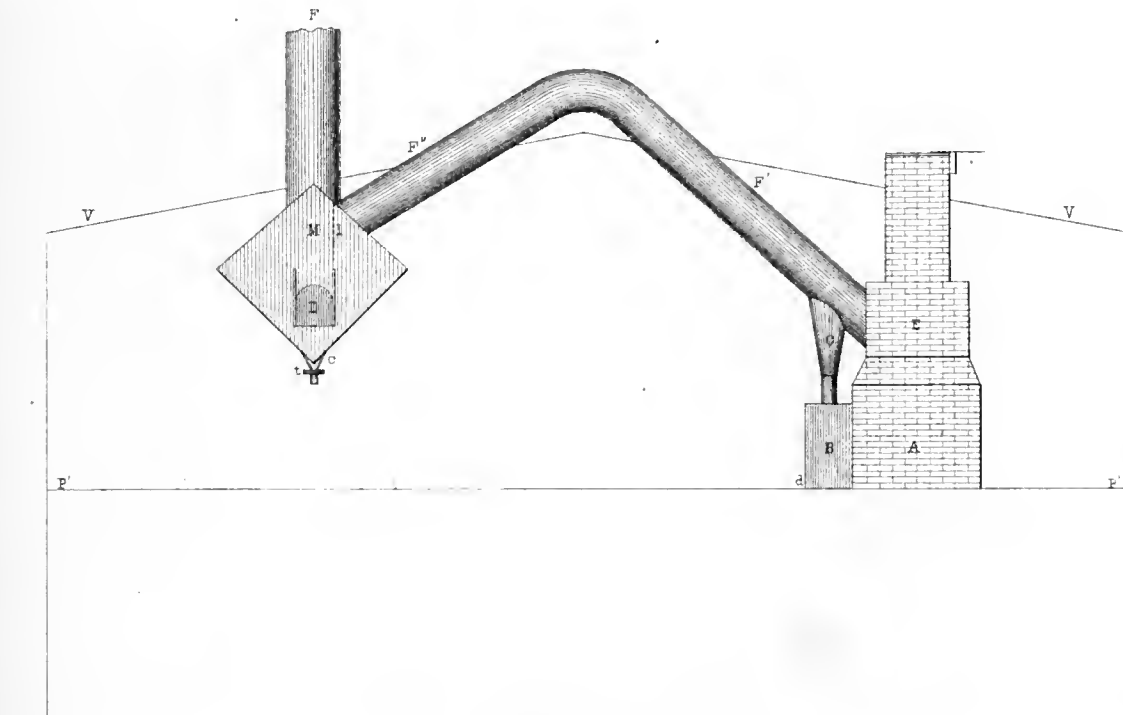

Fig. 2, FRONT ELEVATION.

Scale 1 inch to 12 feet, or  $\frac{1}{4}$ "

M Bier del



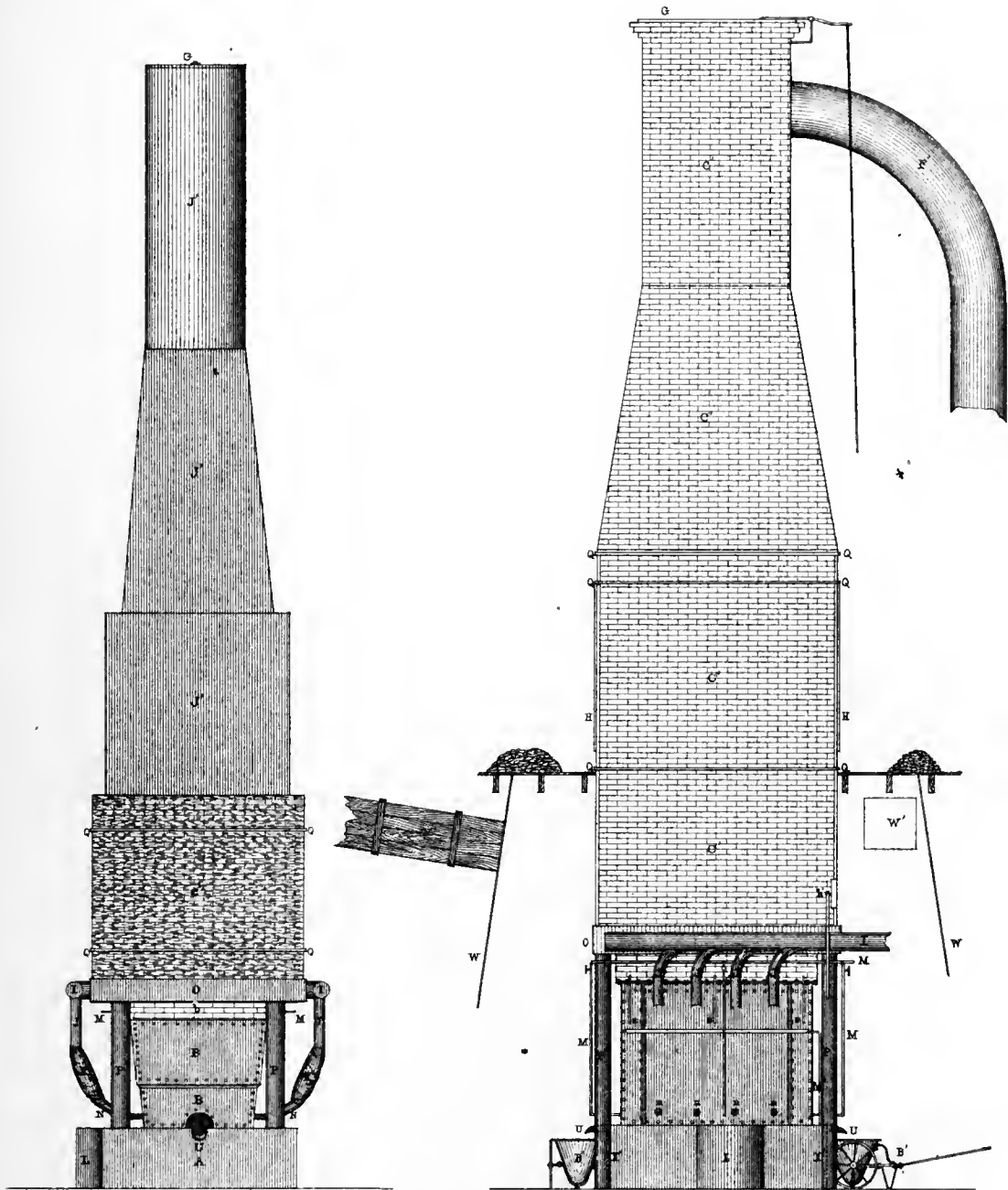

Fig. 1 SMALLER FURNACE ELEVATION

Fig. 2 LARGER FURNACE ELEVATION

Red Brick      Fire Brick      Clay

Scale. 1 inch to 6 feet or 1:72

FEET 0 10 20 25

METERS 0 1 2 3 4 5 6 7 8

M. Don. del.



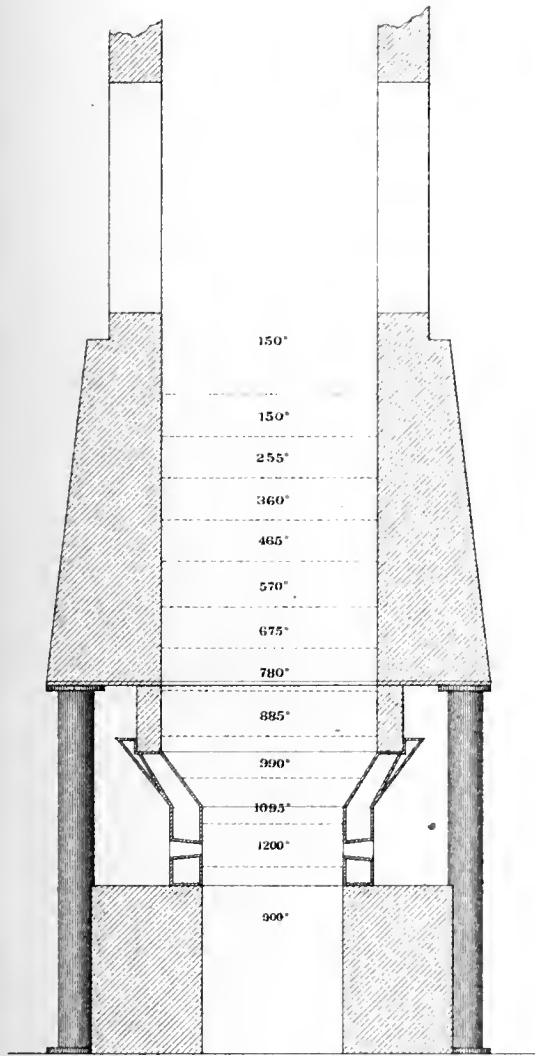
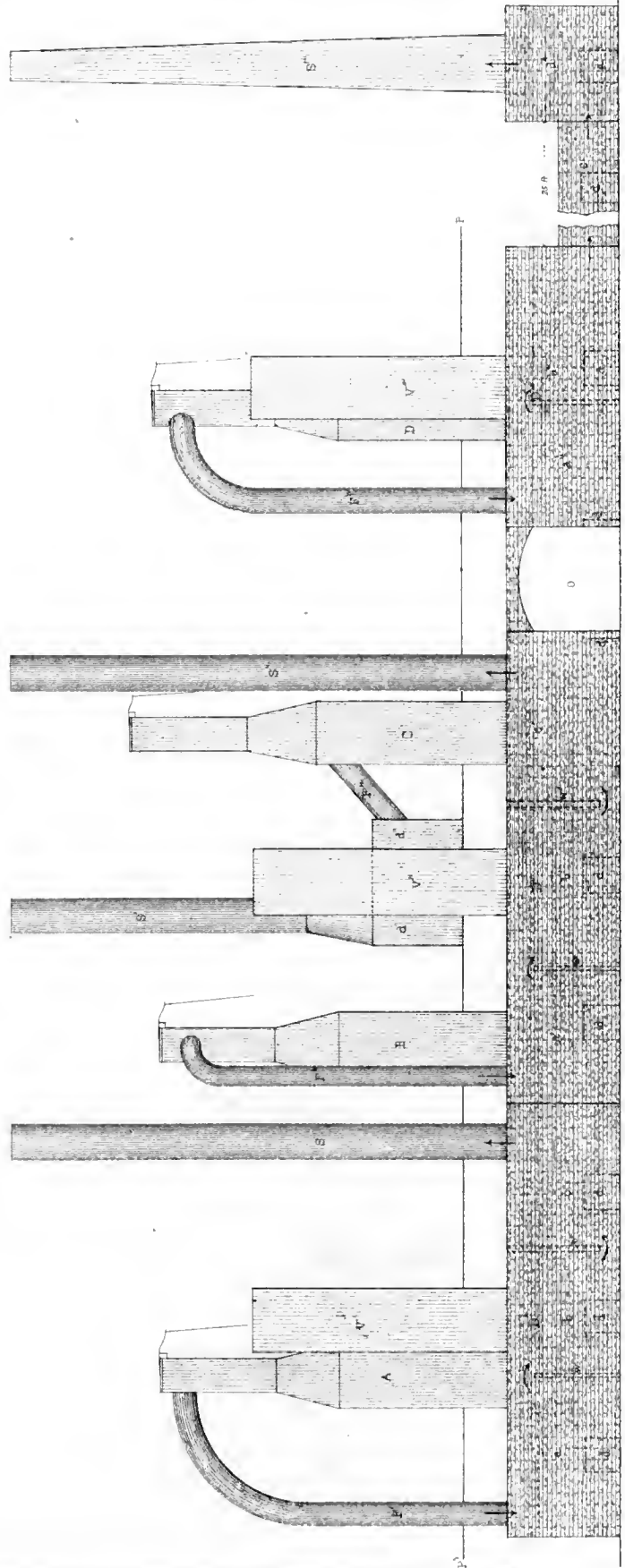

Fig 2

Scale 1 inch to 4 feet, or 1/4 in.

SECTION OF FURNACE SHOWING ZONES OF TEMPERATURE

M. Bien del.



Julius Bien & Co lith.

S. F. Emmons Geologist-in-Charge

SMEETER G.

A. Guyard, Metallurgist.

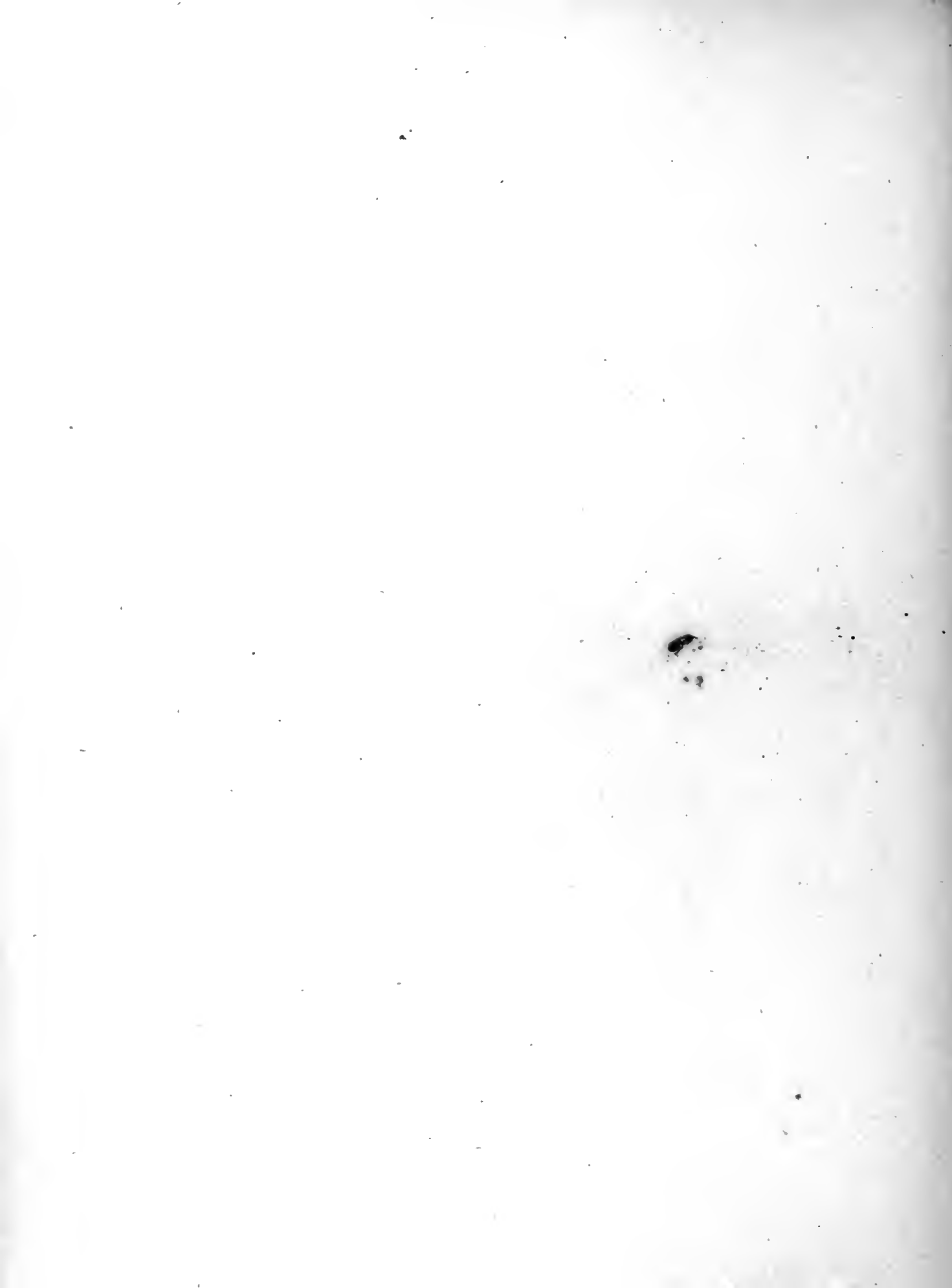

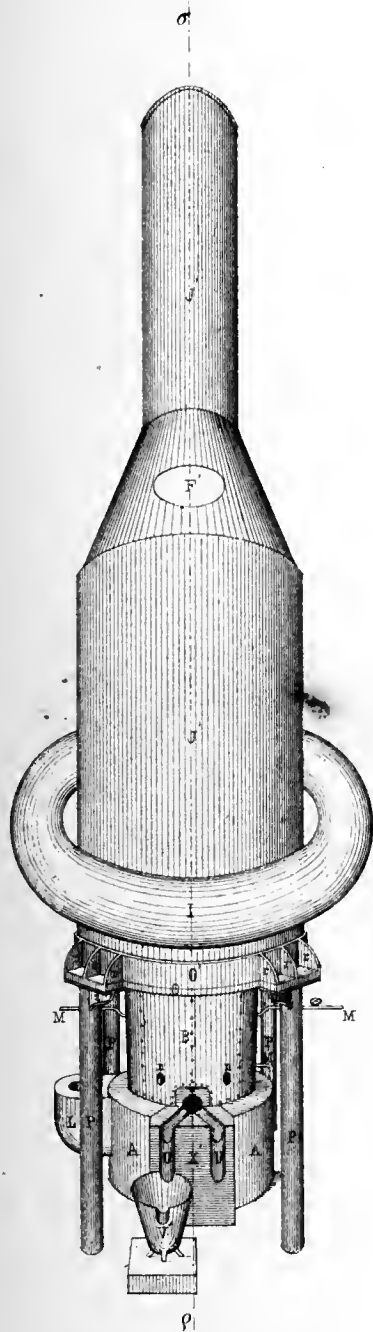

Fig. 1 PERSPECTIVE VIEW

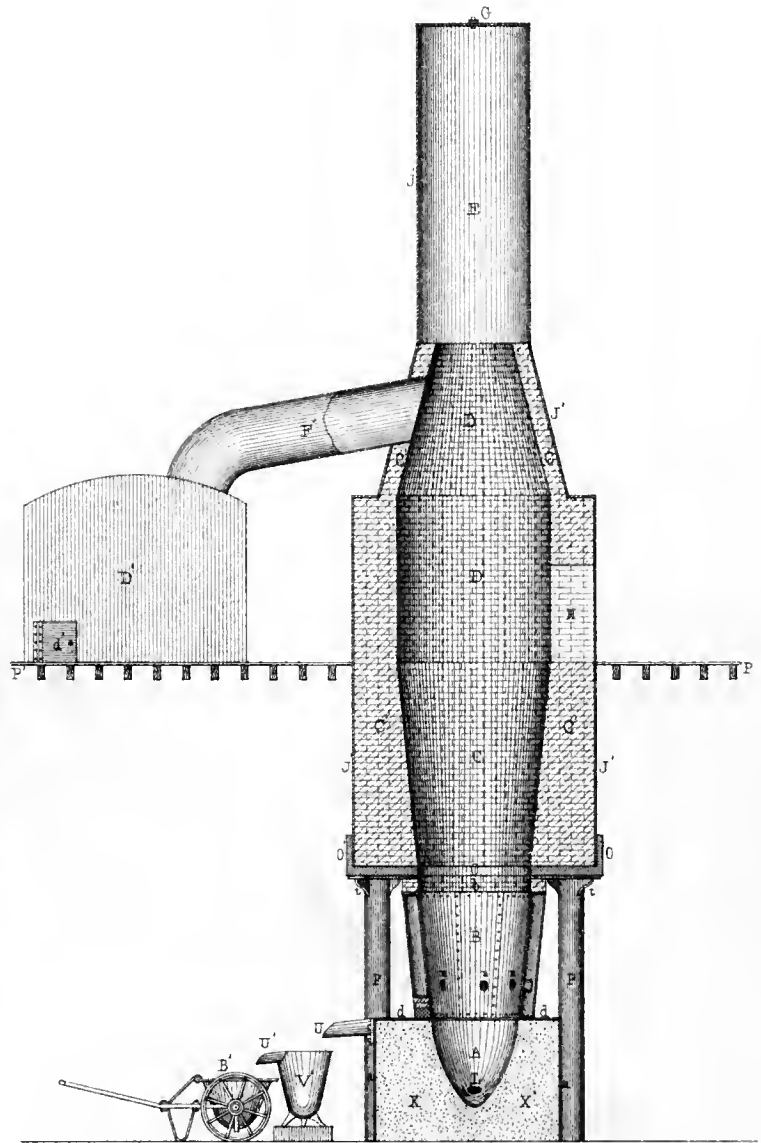

Fig. 2 SECTION ON d-b



Cast Iron



Wrought Iron



Fire Brick



Clay



Steep

Scale. 1 inch to 6 feet or 1:72

FEET

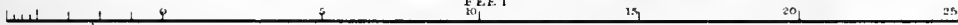

METERS

M. Eben del.

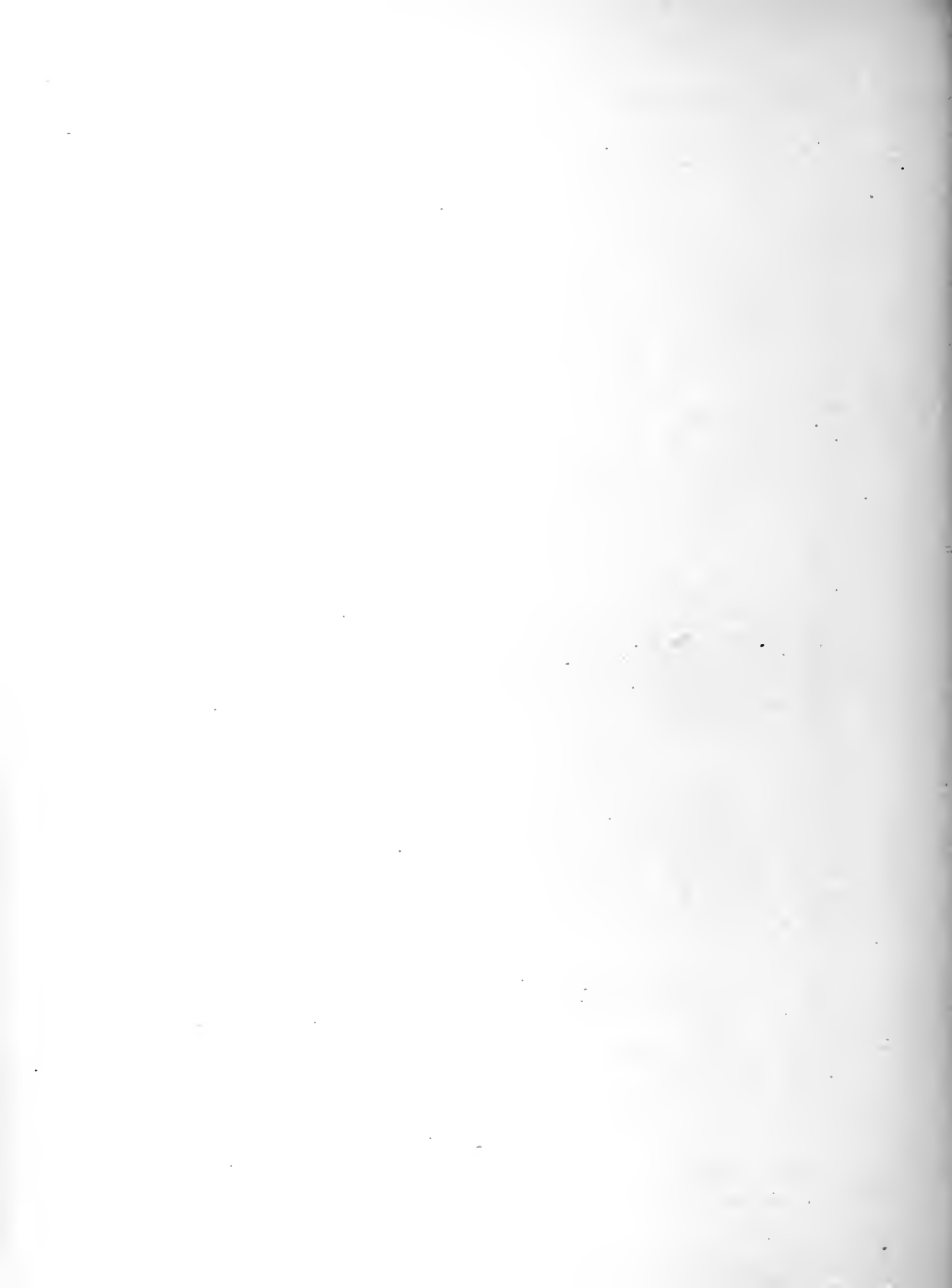



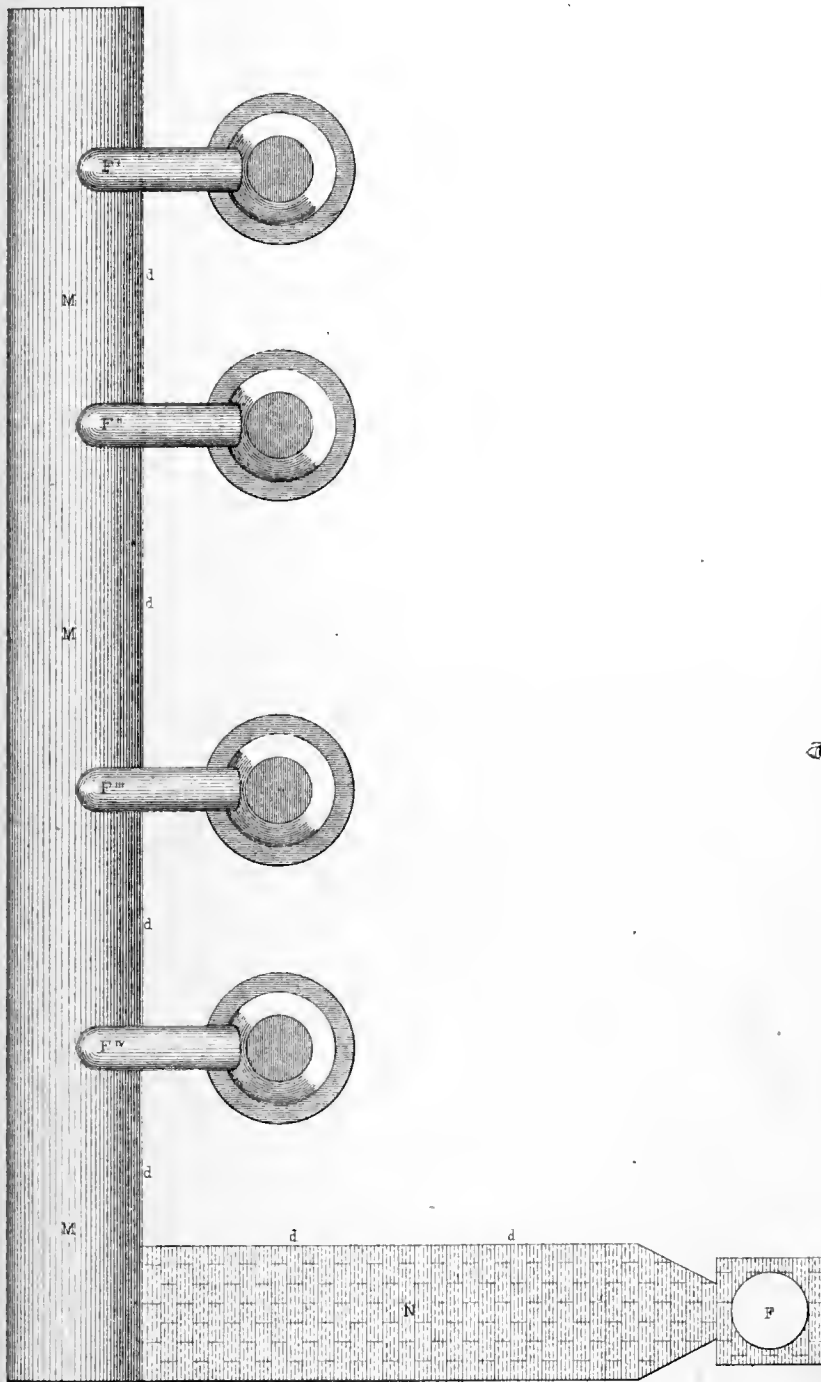

Fig. 1 DUST CHAMBER SMELTER H  
Scale 10 ft - 1 in

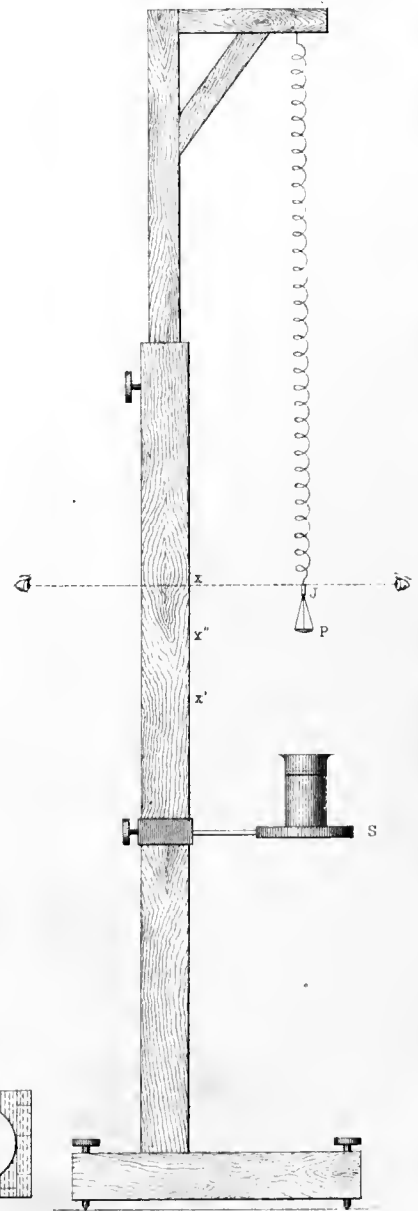
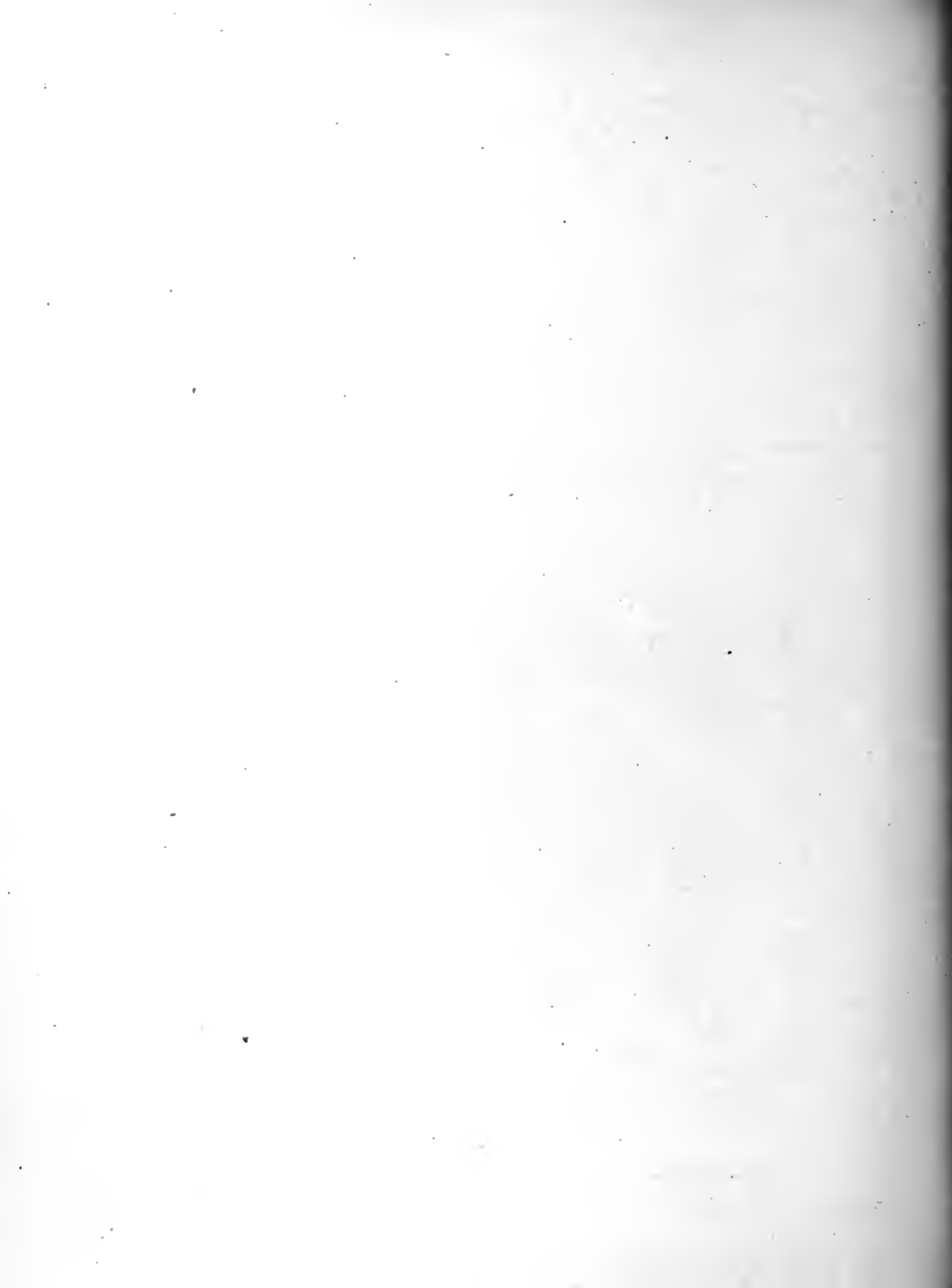
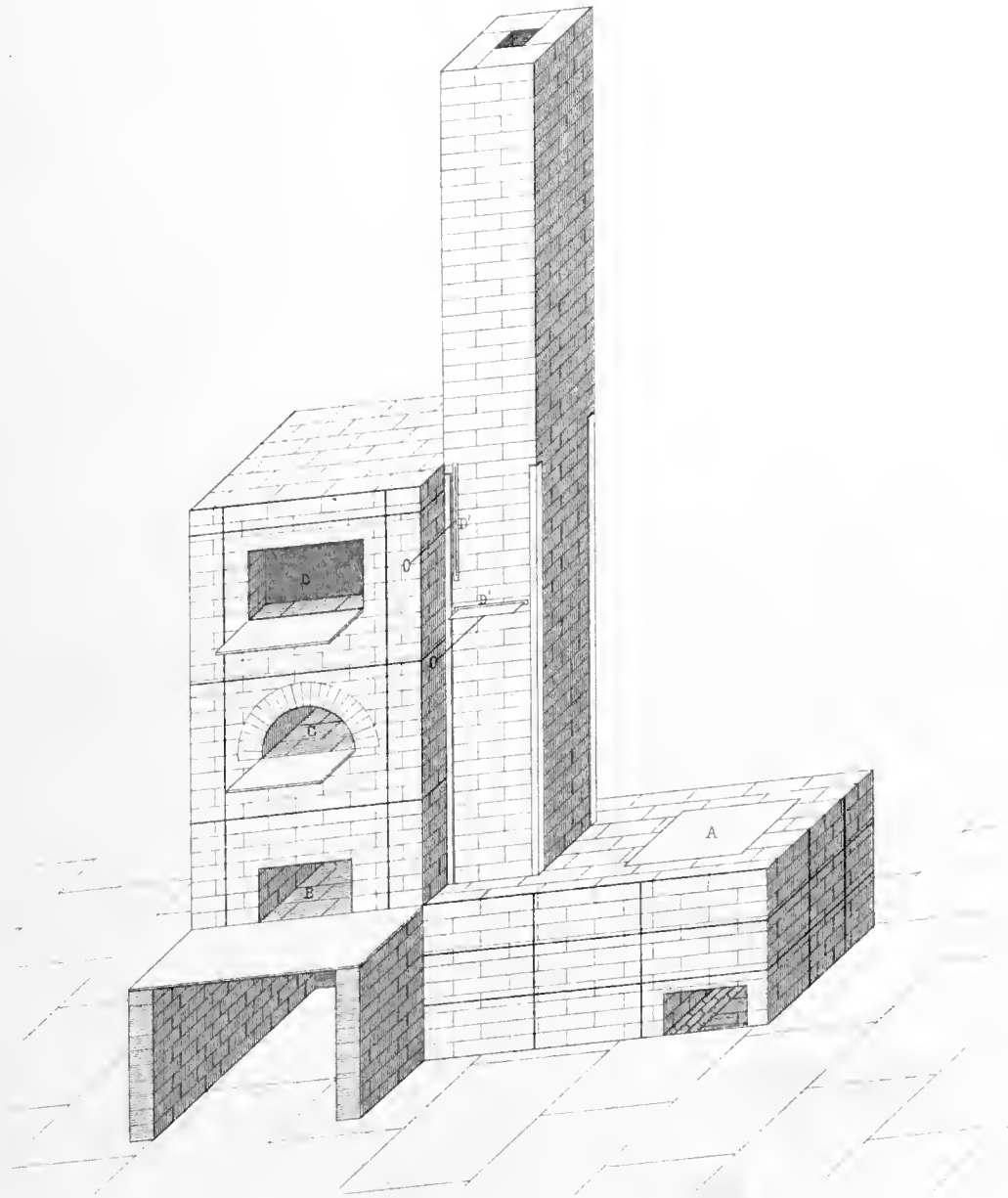

Fig. 2 JOLLY'S SPECIFIC GRAVITY SPRING BALANCE  
Scale: 1/8 ft - 1 in





ISOMETRIC PROJECTION

Scale on vertical lines, 2 ft. to lin or  $\frac{1}{2}$ "

M. Bien del.



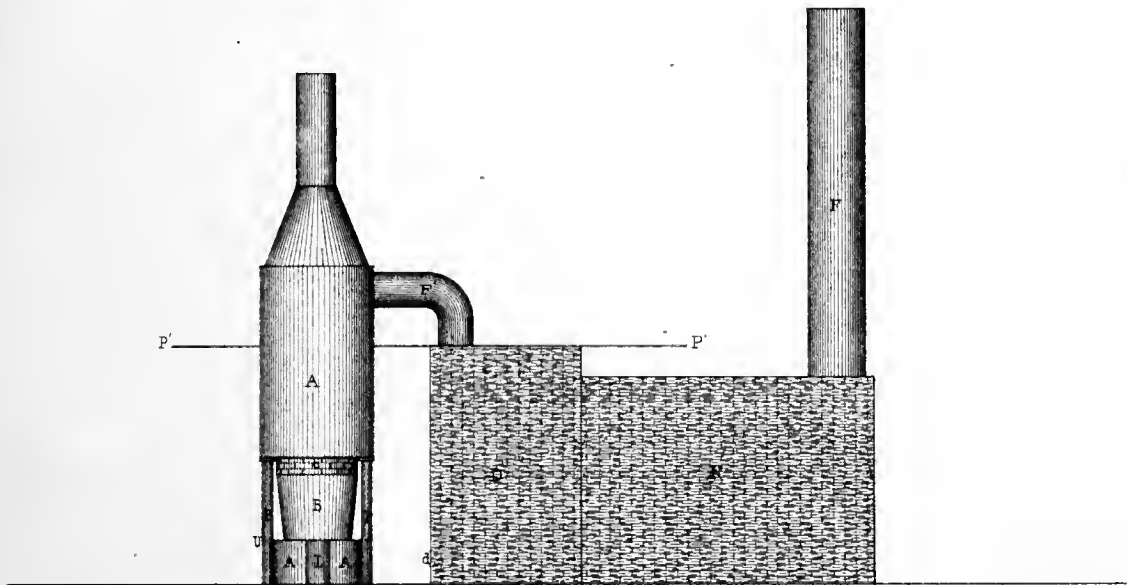

Fig. 1 SIDE ELEVATION

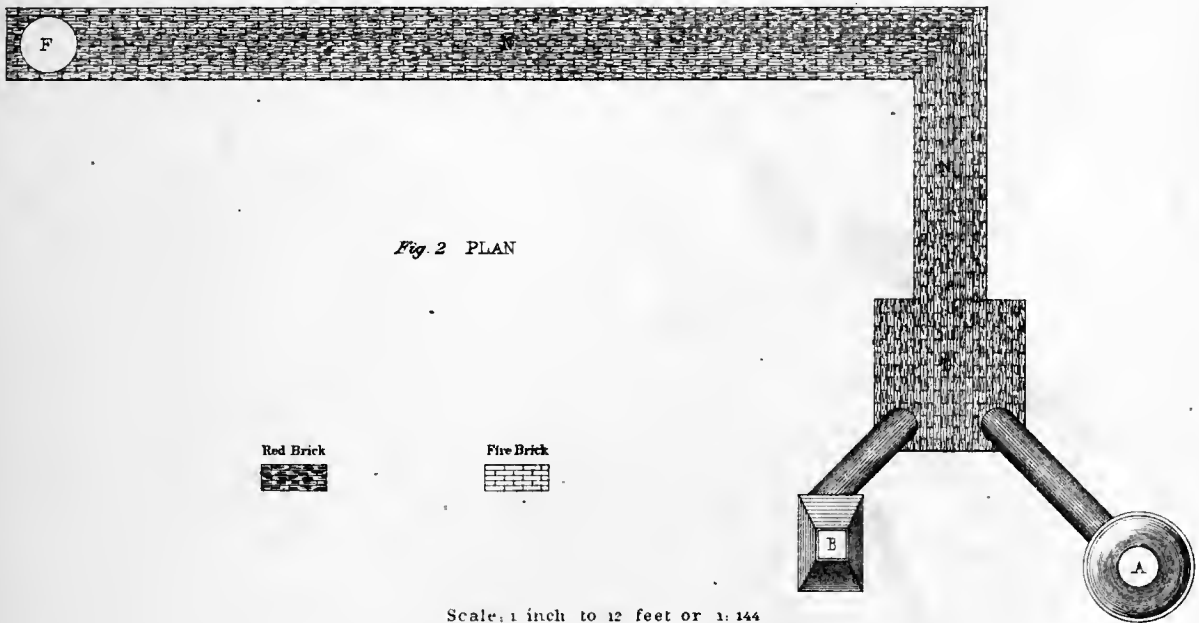

Fig. 2 PLAN

Red Brick



Fire Brick



Scale, 1 inch to 12 feet or 1:144



M. Ben del



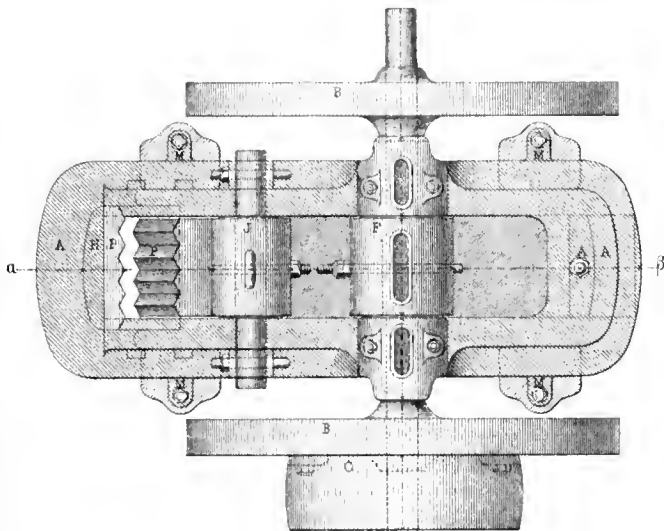

Fig. 1, HORIZONTAL PROJECTION

ECCENTRIC CRUSHER

Scale 3/8 in. = 1 ft.

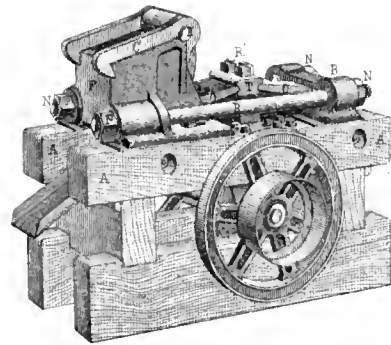

Fig. 3, PERSPECTIVE VIEW

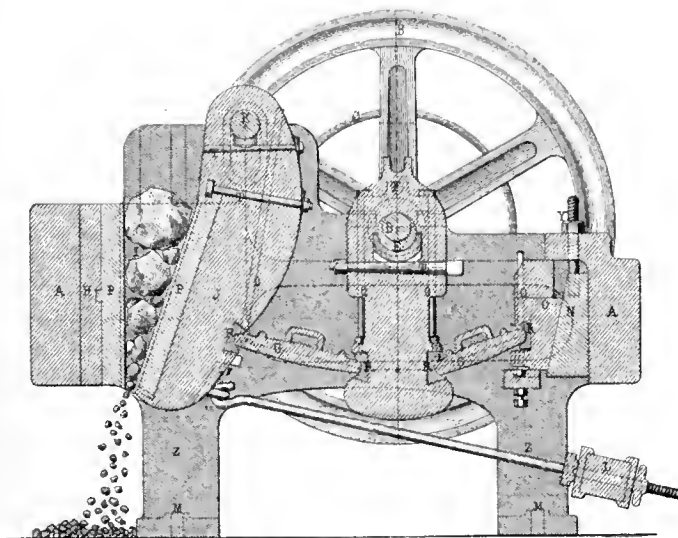

Fig. 2, SECTION ON αβ

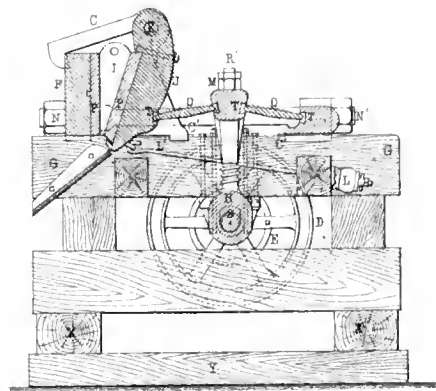
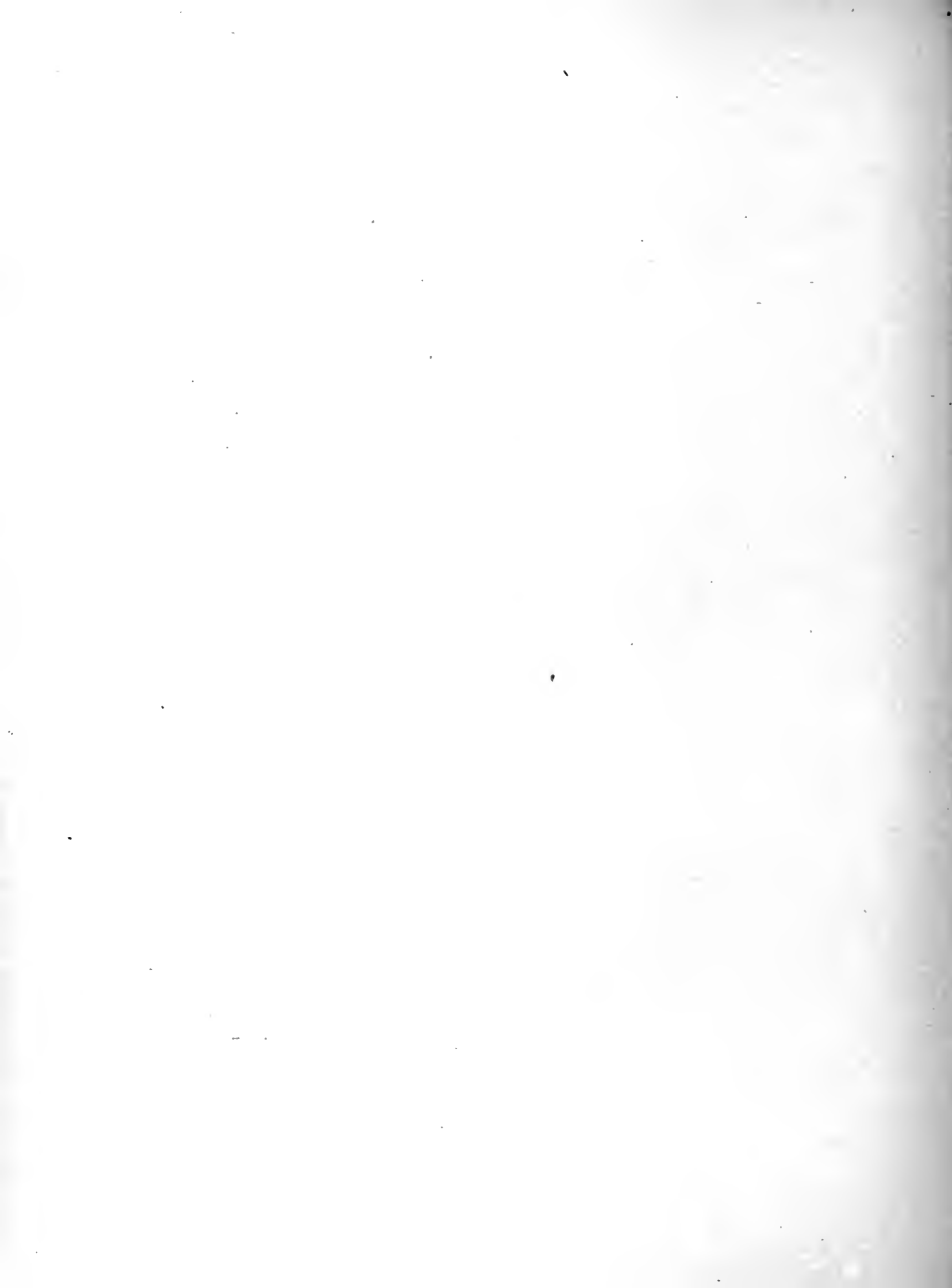

Fig. 4, VERTICAL SECTION

CHALLENGE CRUSHER

Scale 3/8 in. = 1 ft.

From Company's Catalogue





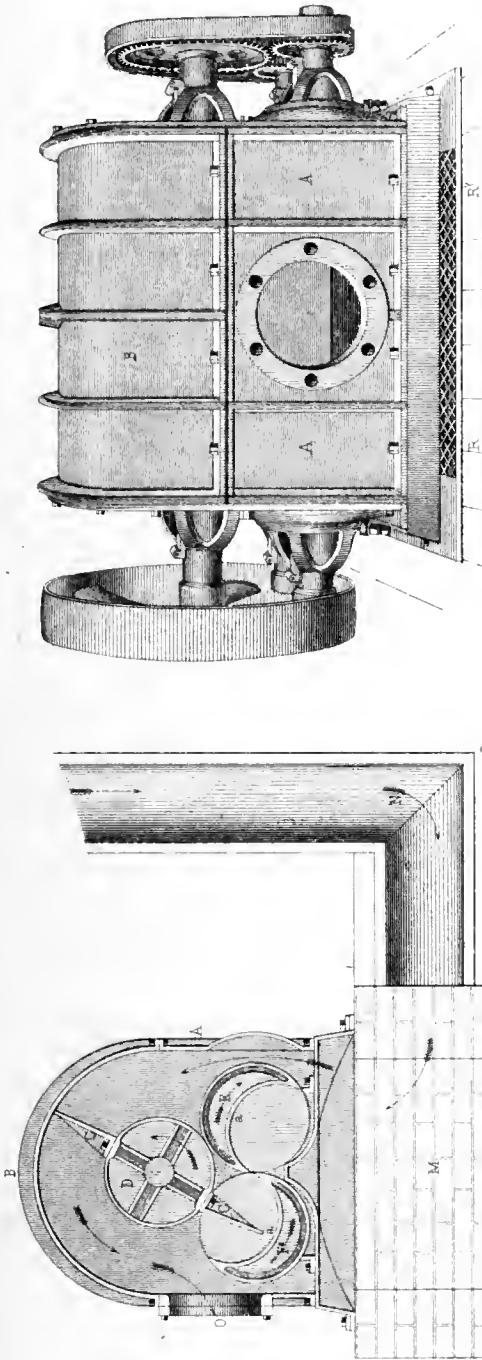

Fig. 1 PERSPECTIVE VIEW

BARK'S ROTARY BLOWER, FORCED BLAST

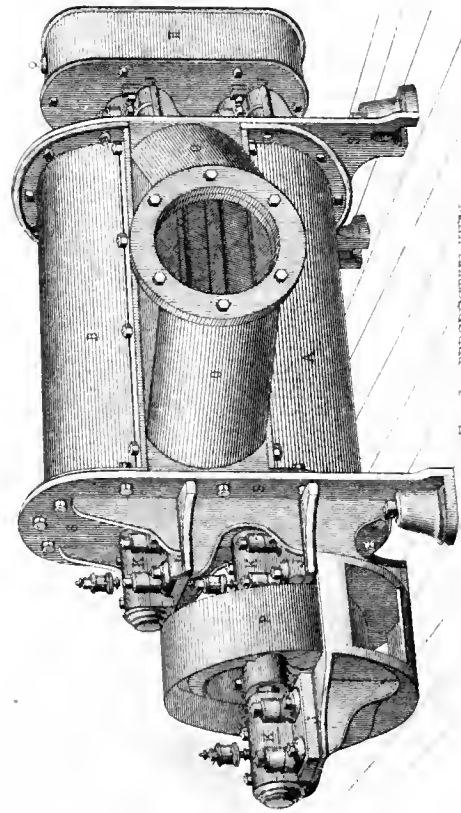

Fig. 3 PERSPECTIVE VIEW

ROOT'S POSITIVE BLAST BLOWER

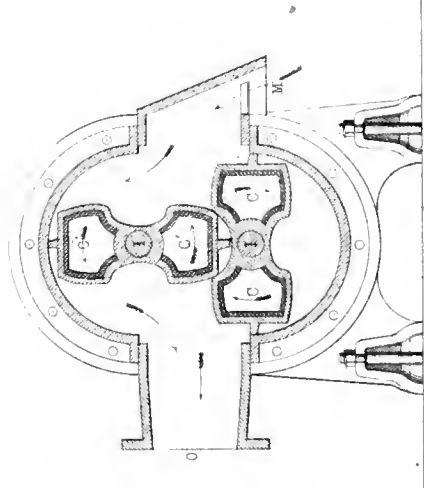

Fig. 4 SECTION  
Scale 2/3

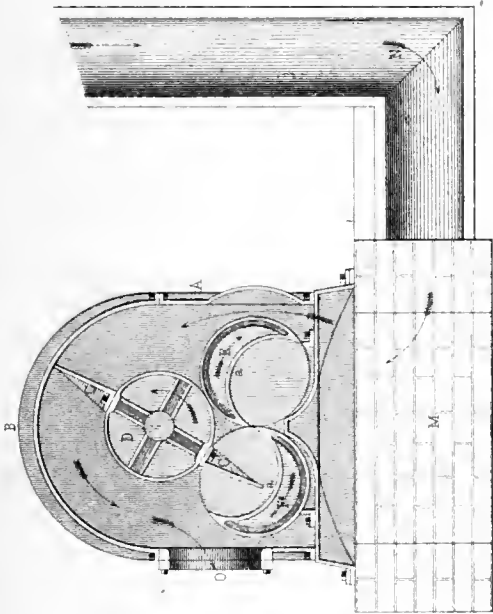

Fig. 2 SECTION  
Scale 2/3 - 1/4

From Company's Catalogue

Julius Bon & Co. lith.

A. Guyard, Metallurgist.

BLLOWERS.

S. F. Simmons, Geologist-in-Charge

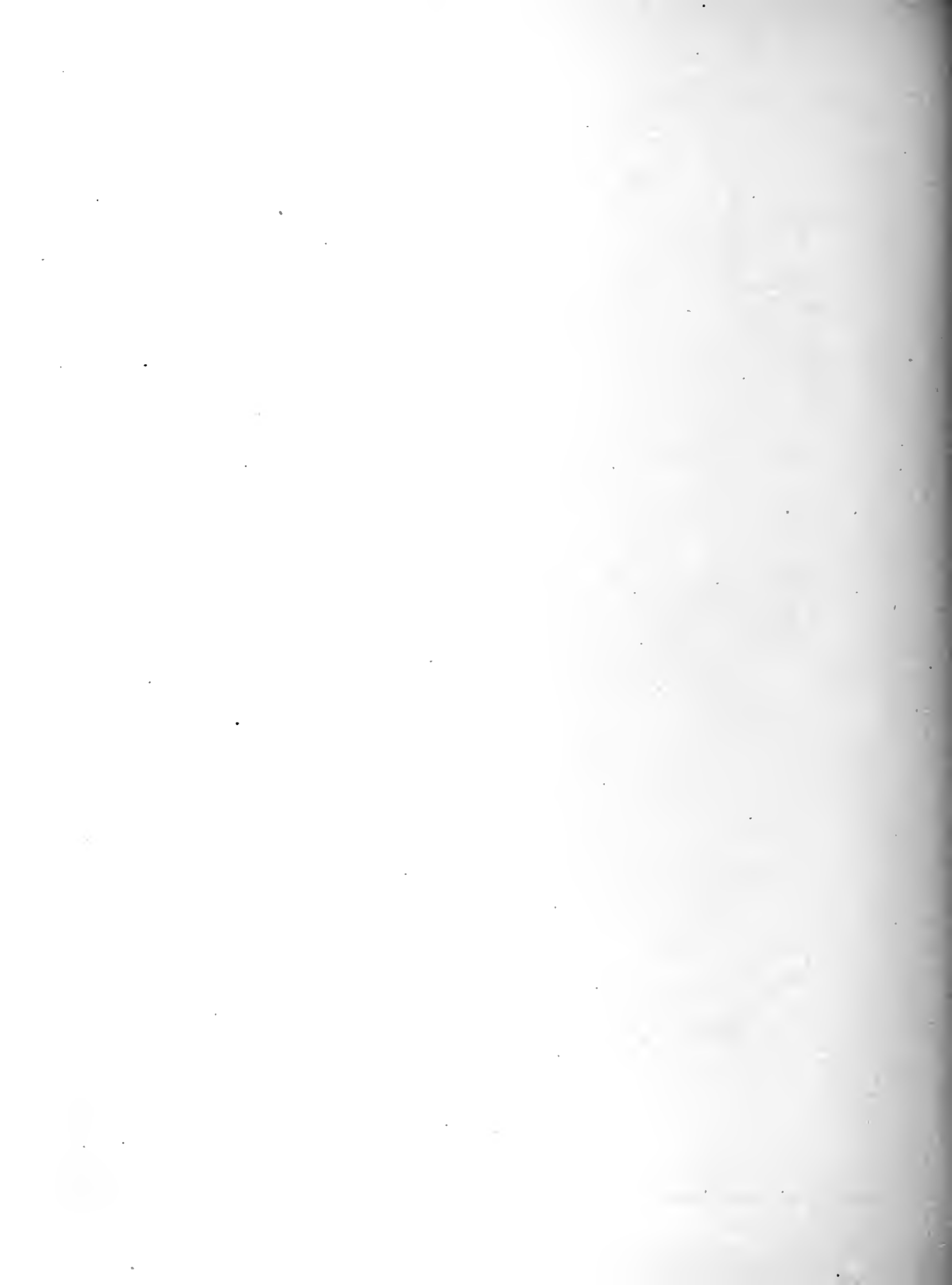

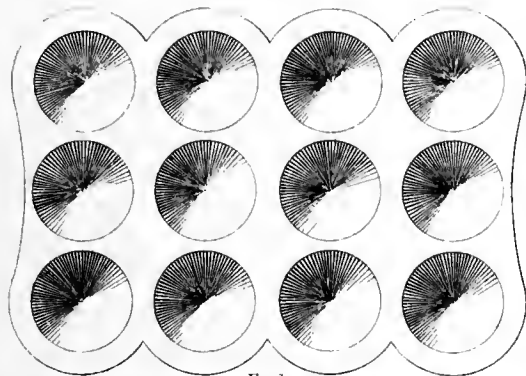

Fig. 1.

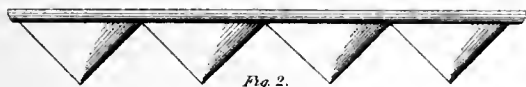

Fig. 2.  
Scale, 1/4

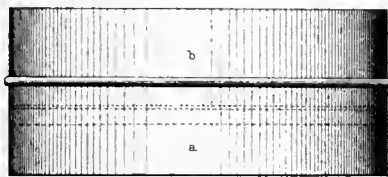

Fig. 8.  
Scale, 1/4



Fig. 9.  
Scale, 1/2



Fig. 10.  
Scale, 1/2

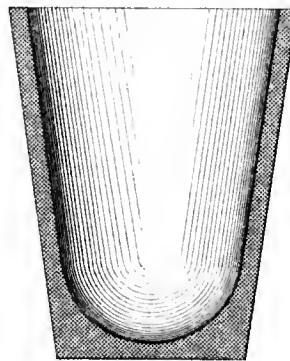

Fig. 3.  
Scale, 1/2

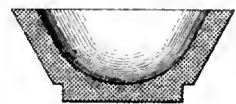

Fig. 4.  
Scale, 1/2

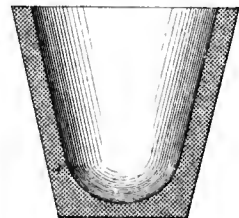

Fig. 5.  
Scale, 1/2

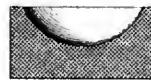

Fig. 6.  
Scale, 1/2

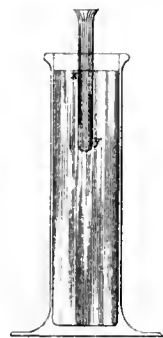

Fig. 7.  
Scale, 1/8

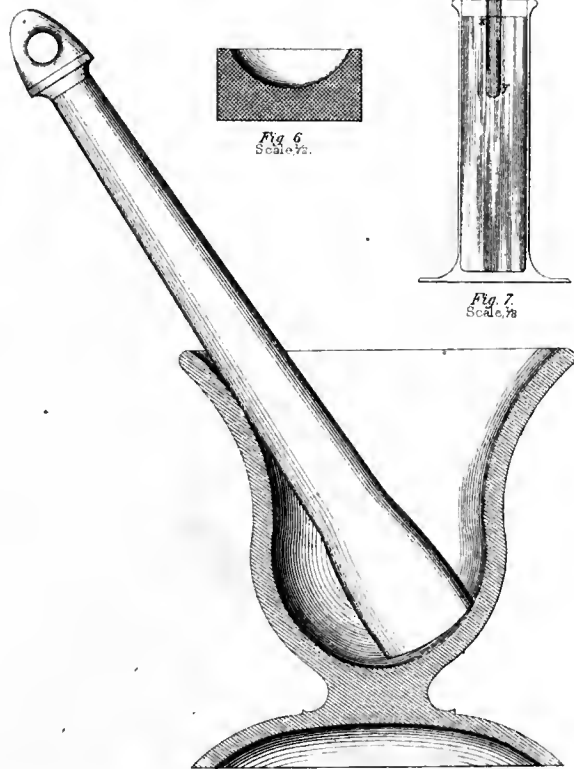

Fig. 12.  
Scale, 1/4

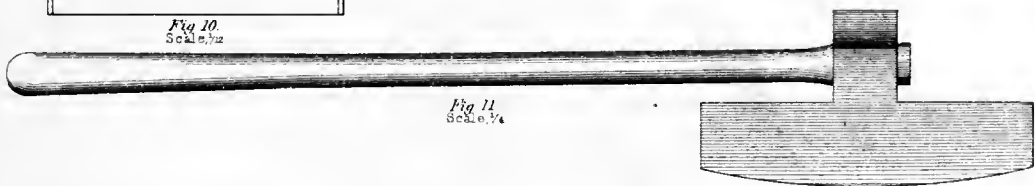

Fig. 11.  
Scale, 1/4

M. Bien, del.



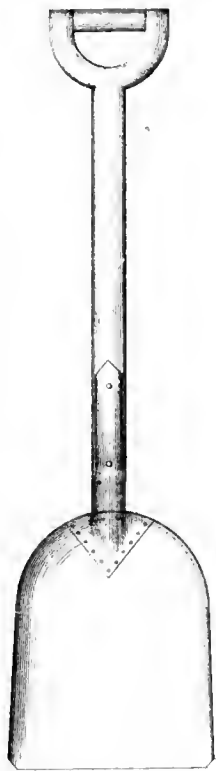

Fig. 1.

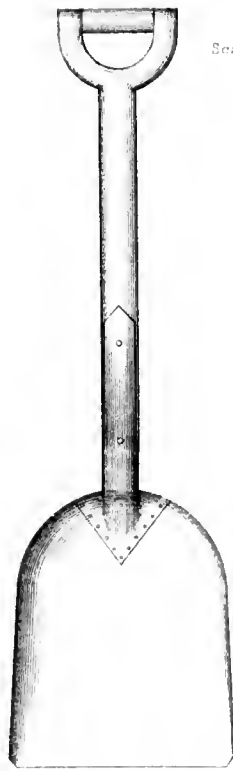

Fig. 2.

Scale 1/2



Fig. 3.

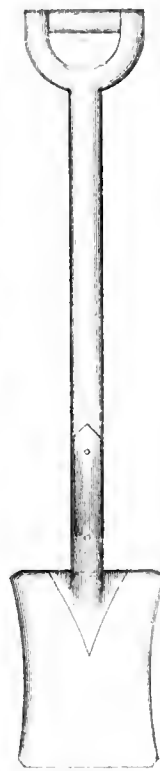

Fig. 4.



Fig. 5.

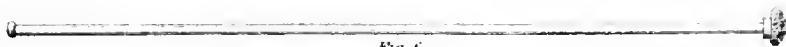

Fig. 6.  
Scale, 1/32



Fig. 7.  
Scale, 1/32



Fig. 8.  
Scale, 1/32



Fig. 9.  
Scale, 1/32



Fig. 10.  
Scale, 1/32



Fig. 11.  
Scale, 1/32



Fig. 12.  
Scale, 1/4

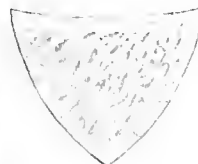

Fig. 13.  
Scale, 1.



Fig. 15.  
Scale, 1/2



Fig. 14.  
Scale, 1/4

M. Dem. del.



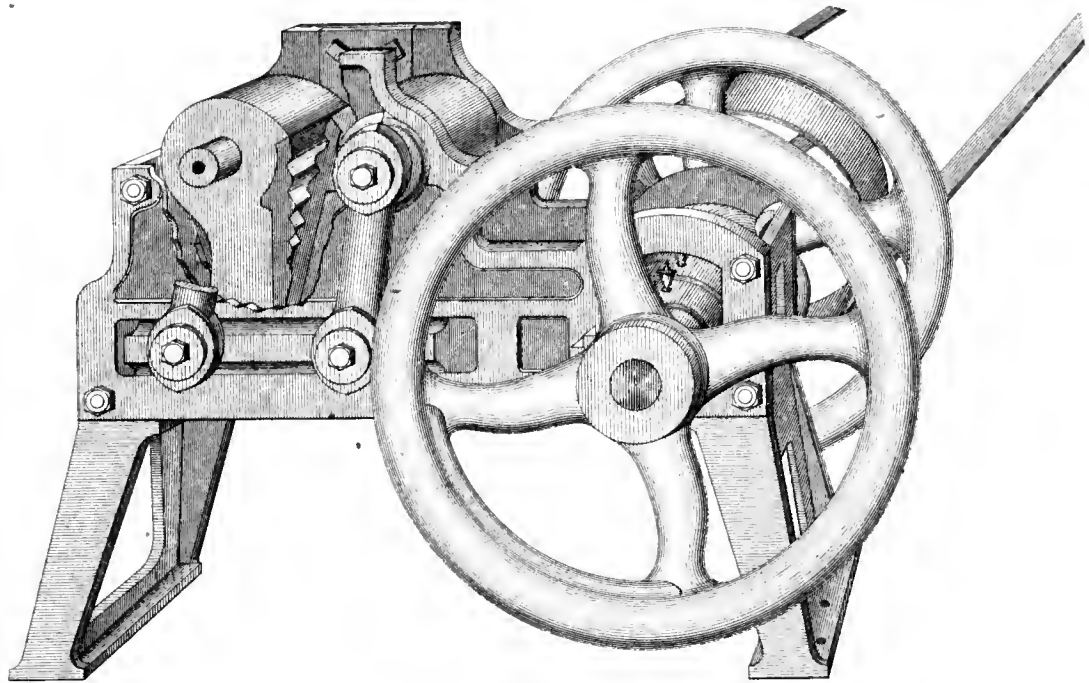

Fig 1 ALDEN ORE CRUSHER

From Companies Catalogue

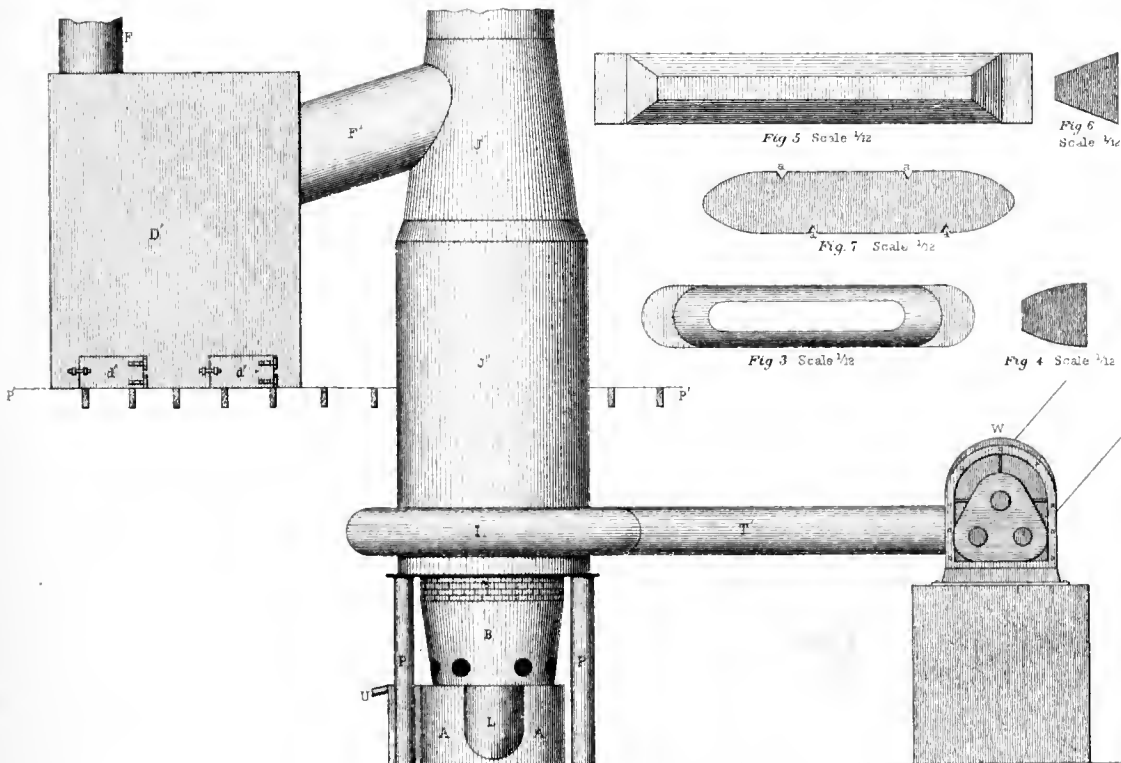

Fig 2 FURNACE AND DUST CHAMBER SMELTER I

Scale 1 inch to 6 feet. or 1/2.

M. B. B. Co.





# INDEX.

[Small capitals indicate headings of chapters, sections, or subsections. The names of all mines or prospects mentioned in the work will be found under "Mines."]

A.	Page.	Analysis of—Continued.	Page.
ACCRETIONS.....	725	COKES.....	642
hearth.....	725	Dolomite, Blue Limestone.....	65, 596, 644, 645, 646
peculiar.....	730	Cambrian limestone.....	59
shaft.....	727	White limestone.....	596
ADELAIDE FAULT.....	243, 402	Embolite.....	548
MINE.....	407	ERUPTIVE ROCKS.....	358, 589
ore, analysis of.....	544, 648	Feldspar from Gray Porphyry.....	589
Porphyry.....	241, 403	Fumes from Bartlett filter.....	717
Smelter.....	625, 626, 691, 693	Galena.....	556
AGENTS OF ALTERATION of Leadville ores.....	552	Granite from Little Cottonwood, Wasatch	. . .
Age of Archean rocks.....	51	Mountains.....	313
eruptive rocks.....	298, 319	Gray Porphyry.....	332, 358, 589
gold deposits.....	515	Hypersthene-andesite.....	589
LEADVILLE DEPOSITS.....	376	from andesite.....	589
Alden crusher.....	632	Iron sow or salamander.....	722
Alkali determinations of eruptive rocks.....	590	KAOLIN AND CHINESE TALC.....	603
Allanite.....	329, 335, 341, 300	Lime sand.....	450
analysis of.....	329	Limestone, altered and unaltered.....	214
Alma.....	106, 123	Blue.....	65, 596, 643, 644, 645, 646
Alteration, agents of.....	532	Cambrian.....	59, 119
of Leadville deposits.....	378, 550	Cañon City.....	646
American Smelter.....	625, 626, 643, 646, 693, 698, 708, 725	Robinson.....	598
AMIE MINE.....	471	White.....	65, 214, 596
AMPHIBOLITE.....	50	Lincoln Porphyry.....	332, 358, 589
Analyses, methods employed in.....	576	Misttes.....	723
Analysis of—		Mount Zion Porphyry.....	326, 358, 589
Adelaide ore.....	544	Muscovite from White Porphyry.....	589
Allanite.....	329	Nevadite.....	349, 358, 589
Amphibole from dolomitic limestone.....	598	Orthoclase from Lincoln Porphyry.....	332, 589
Andesite.....	589	Peculiar accretions.....	730, 731
Average ore of Leadville.....	544, 620	Porphyrites.....	340, 358, 589
Basic ferric sulphate.....	556, 606	Pyrite.....	556
Blende.....	556	Sanidine from Nevadite.....	589
Breccia iron ore.....	647	Serpentine.....	598
Bullion.....	694	Shaft accretions.....	727
CARBONATE ORES.....	544	Skimmings of bullion.....	696
from Adelaide.....	618	Slags.....	701, 704
Little Chief.....	618	Speiss.....	720
Chamber dust.....	712	Sulphide ores.....	556
roasted.....	715	Tapping clay.....	641
Chinese talc.....	603	Vein materials.....	557, 599
CHLORIDE ORES.....	619	White Limestone.....	65, 214, 596
from Amie mine.....	619	White Porphyry.....	326, 358, 589
Big Pittsburgh.....	619	Anatase.....	325, 327, 357
Robert E. Lee.....	619	ANDESITE.....	88, 353

	Page.		Page.
Andesite—Continued.		Baldhead Mountain .....	135
analysis of .....	589	BALL MOUNTAIN .....	219, 221, 223
silver in .....	579, 594	FAULT .....	215
Anthracite in Weber Shales .....	67, 148	AREA BETWEEN AND WESTON	
Appalachians, sedimentation in the .....	54	FAULT .....	219
structure compared with Rocky		Barite in Leadville ores .....	561
Mountains .....	201, 292	Barium in eruptive rocks .....	326, 358, 677, 591, 599
ARCHEAN formations .....	45, 276	BARRING-DOWN OF THE FURNACES .....	666
bedding planes in .....	277	at Smelter C .....	677
rocks, relative age of .....	51	Bartlett filter described .....	673
ARGENTIFEROUS LEAD-SMELTING AT LEADVILLE .....	613	fumes from, analyzed .....	717
ARGENTINE MINE .....	465	Mountain .....	198, 199, 201
ARKANSAS AMPHITHEATER .....	199	BARTTA DETERMINATIONS .....	577
DIKE .....	339	Basic ferric sulphates, defined .....	376
Lake .....	30, 41, 71, 92, 249, 387, 441	analyses of .....	549, 666
Valley, earliest exploration of .....	7	Basin region structure, compared with Rocky Mount-	
EROSION .....	40	ains .....	26
topography of .....	4	Beaver Creek Valley .....	104
A. R. Meyer .....	12, 14	Ridge .....	104
A. R. Meyer & Co., sampling works .....	629	Beeger, Prof. Herman .....	12
Ascension theory .....	569, 576	Bell, I. Lowthian, cited .....	736, 737
Assay furnaces in smelting works .....	632	Bergen's Creek, fossils from .....	62
ASSAYING .....	632	Berthier, P., cited .....	732-735
Assays of bullion .....	695	Bien, Julius .....	613
chamber dust .....	711	Morris .....	x, 613
country rocks .....	594, 608	BIO EVANS ANTICLINE .....	260
hearth accretions .....	726	BIG PITTSBURGH MINE .....	482
mattes .....	725	Billing & Eilers (Utah) smelter .....	613, 625, 626, 642, 643, 646, 693,
shaft accretions .....	728	695, 698, 701, 708, 710, 711, 712, 719, 721, 722, 725, 727, 729	
speiss .....	721	Bird's Eye gulch .....	190, 191
various ores .....	608, 621, 622, 623, 624, 625	Bischof, G., cited .....	575, 676
vein materials .....	557, 608	Bismuth .....	377
Assay ton, explained .....	653	BLACK HILL .....	170
Atlas sheets referred to in text:		referred to .....	28, 362
VI .....	168, 469	RHYLITE .....	349
VIII .....	162, 168, 136, 135, 138, 140, 143, 146, 151, 184, 185, 191,	Black Hills of Dakota .....	22, 45
IX .....	194, 198, 199, 205, 206, 287	Blake crushers .....	630, 631
X .....	135, 138, 152, 154, 155, 158, 162, 165, 172, 176, 177, 179,	Blanket deposit defined .....	371
XIII and XIV .....	184, 204	BLAST APPARATUS in general .....	661
XV and XVI .....	116, 185, 212, 523	PIPES in general .....	663
XVII and XVIII .....	202, 412	system .....	664
XIX and XX .....	264, 265, 266, 500	Block porphyry defined .....	77
XXI .....	235, 239, 267, 269, 500	BLOWING-IN OF THE FURNACE .....	665
XXII .....	264, 223, 228, 276, 271, 272, 518	BLOWING-OUT OF THE FURNACE .....	668
XXIII .....	236, 273, 500	BLUE LIMESTONE .....	63
XXIV .....	274, 512, 517	analyses of .....	65, 596, 643-646
XXV .....	232	favorable to ore deposition .....	541
XXVI .....	232, 383, 395, 396, 397, 399, 400	how distinguished from White	
XXVII .....	232, 386, 388, 390, 392	Limestone .....	65
XXVIII .....	401	on Fryer Hill .....	449
XXIX .....	402, 403, 404	specimens of, figured .....	64
XXX .....	409, 412, 420	Boggs, William R., jr., analyses by .....	550
XXXI .....	409, 414, 419, 425, 427, 428, 429	BREECE FAULT .....	236
XXXII .....	454	AREA NORTH OF .....	237
XXXIII .....	454, 456, 458, 464, 467, 487, 488	HILL .....	235, 506
XXXIV .....	449, 454, 458, 464, 466, 467, 468, 476, 478	IRON MINE .....	237, 499
XXXV .....	456, 454	oro .....	550, 647
Angite-bearing diorite .....	84, 334	Breithaupt, A., cited .....	575
Angitic rocks from Henry Mountains .....	361	Brierton, James .....	613, 626
Average ore, analysis of .....	544, 620	Buckeye gulch .....	190
yield of Leadville ores .....	17	PEAK .....	193
		Buck-plate described .....	632
		BUCKSKIN AMPHITHEATER .....	123
		Joe .....	118, 128, 524
		Mountain .....	124, 125
		SECTION .....	128
B.			
BAKER'S ROTARY FORCED BLAST BLOWER .....	662		
Balances used in assaying .....	633		

	Page.		Page.
Buffalo Peaks .....	28, 175, 302	CHEMISTRY, by W. F. Hillbrand .....	585
rocks from .....	353, 354, 589, 607	Chicago Ridge .....	194
Bolkley, F. G .....	x	Chinese talc .....	377, 603
BULLION .....	692, 730	Chloride of silver, solubility of .....	554
analyses of .....	694	ORES .....	548, 619
assays of .....	695	Chlorine in dolomitic limestones .....	60, 279, 597, 598, 645
how made .....	634	Chroma iron ore .....	521
bars of .....	678	CHRYSLITE MINE .....	455
capacity of smelters. Table VIII .....	697	Circles of deposition of sediments .....	54
composition of .....	693	Circular furnaces .....	661
losses of .....	697	Claim outlines, how indicated on maps .....	455
production of .....	16, 638, 698	Classification, basis and object of .....	368
skimmings analyzed .....	696	of eruptive rocks .....	293, 320, 322
Bunsen, Robert, jr., cited .....	486, 698	Leadville deposits .....	375
		ore deposits in general .....	367
		by German authors .....	370
		on genetic principles .....	369, 374
		PORPHYRITES .....	337
		CLIMAX MINE .....	475
		Coal in Carboniferous formation .....	217, 278
		Cobalt in Leadville ores .....	547
		rhyolite and porphyry .....	501
		sows .....	723
		COKE .....	641, 642
		COLORADO PRINCE FAULT .....	224
		MINE .....	503
		Colorado Range, geological structure of .....	20
		topographical character of .....	3
		Como .....	106
		coke from .....	641
		Composition of ash of charcoal .....	643
		Blue Limestone .....	64, 643
		bullion .....	693
		carbonate ores .....	617
		LEADVILLE DEPOSITS .....	376, 543, 617
		ore-beds .....	648
		ores .....	543
		VEIN MATERIALS .....	556
		Comstock lode, compared with Leadville deposits .....	15
		CONCLUSIONS about smelting processes at Leadville .....	745
		CONSTRUCTION MATERIALS of smelters .....	641
		CONTACT METAMORPHISM .....	307
		Contemporaneous deposits .....	374
		Contraction, caused by replacement .....	446
		tangential and radial .....	288
		theory applied to Rocky Mountain structure .....	24
		Cooper's Hill .....	189
		Copper ore in Leadville mines .....	407, 408, 503
		Correspondence of horizons determined by facos .....	53
		COST AND PROFITS OF SMELTING at Leadville .....	668
		OF PLANT of smelters .....	626
		TRANSPORTATION of ores .....	628
		Cotts, B. von, cited .....	360, 370, 371, 375, 575
		Cottonwood granite .....	311, 313
		Country rocks, metals in .....	574
		CRESCENT MINE .....	430, 444
		Crooked Creek .....	106, 343
		Cross-cutting zone of White Porphyry .....	207, 402, 446, 495
		CRUCIBLES AND SCOFFERS .....	633
		CRUSHING of ores .....	629
		Cumming & Finn's smelter .....	625, 693, 695, 698, 700, 708, 710, 711, 721, 723, 725, 728, 729
		CUPELS .....	633
		Curtis, J. S., cited .....	15
		Curving of beds adjoining faults .....	146, 178, 286
C.			
Cadmium in Leadville ores .....	547, 714		
Calamine in Iron mine .....	398		
CALIFORNIA FAULT .....	385		
GULCH .....	252		
amount of gold taken from .....	9		
HEAD OF .....	233, 512		
south of .....	249		
smolter .....	625, 626, 643, 645, 646, 658, 693, 694, 695, 698, 701, 708, 711, 722		
CAMBRIAN .....	58		
irregularity in sea-bottom of .....	112, 186, 276		
limestone .....	59, 119		
section .....	132		
CAMERON AMPHITHEATER .....	111		
Mount .....	115		
Cañon City limestone, analysis of .....	646		
Capacity of crushers .....	630		
smelters, actual and nominal .....	659		
for bullion .....	697		
CARBONATE FAULT .....	248, 410		
AREA WEST OF .....	427, 430		
HILL .....	253		
AREA WEST OF .....	261		
first discoveries on .....	415		
GROUP .....	409		
NORTHERN GROUP OF MINES .....	429		
SOUTHWEST SLOPE OF .....	412		
TOP OF .....	427		
MINE .....	416		
WORKINGS .....	416		
CARBONIFEROUS FORMATIONS .....	63		
CATALPA MINE .....	431		
Castic phenomena, absence of .....	307		
Caves in limestone .....	394, 529		
CHALK MOUNTAIN .....	194, 302		
NEVADITE .....	87, 345, 589		
Ranch .....	194		
falls .....	194		
Ridge .....	196		
Challenge rock breaker .....	630		
CHAMBER DUST .....	711		
Chanarçillo, Chili, ores of .....	549		
Chandler, Prof. C. F .....	633		
CHARCOAL .....	642		
KILNS .....	642		
CHARGING OF THE FURNACES .....	665		
CHEMICAL DISCUSSION OF THE LEADVILLE FURNACES .....	737		
REACTIONS OF DIFFERENT ZONES OF FURNACES .....	744		

	Page.		Page.
		D.	
Daily output of Leadville mines .....	015	DUST CHAMBER at Smelter H. ....	688
Dana, Prof. J. D., cited .....	283, 548	and ventilation at Smelter G. ....	685
Daubrée, A., cited .....	284, 569	Dutton, Capt. C. E., cited .....	359, 360, 361, 362
Dechenite .....	411, 616	DYER MOUNTAIN .....	150, 212
Decomposition in eruptive rocks .....	356	fault .....	212
Decrease of silver in depth .....	398	Dynamic movements in Mosquito Range .....	32, 34
Delaware River, chlorine in water of .....	552		
Delmonico gulch .....	193	E.	
Democrat Mountain .....	124	Eagle River Porphyry .....	80, 188, 103, 330, 591
Deposition of ores, manner of .....	565	Eakins, L. G., analyses by .....	325, 590
Devonian in Rocky Mountains .....	56, 188	EAST ARKANSAS VALLEY .....	190
DIKES .....	296	BALL MOUNTAIN .....	215
influence of, on ore deposition .....	452	Leadville .....	153, 157
interrupted .....	124, 125, 179	Eddy & James' Sampling Works .....	629
of Gray Porphyry .....	447, 459, 461, 465, 468, 470, 472, 478, 481, 482, 483, 484, 496, 502, 511	Eilers, A., cited .....	710
White Porphyry .....	96, 97, 112, 114, 165, 178, 211, 324, 501	El Capitan Creek .....	169
Diller, J. S. ....	355, 359	MINE .....	534
DIORITE .....	84, 333	Elgin Smelter .....	625, 626, 643, 646, 693, 694, 695, 698, 708, 711, 723, 725
augite-bearing .....	120	El Moro coke .....	641
hornblende .....	124	Embolite, analysis of .....	548
in French gulch .....	192	EMMET FAULT .....	250, 386
mica .....	125	EMPIRE GULCH .....	181
silver in .....	579, 594	RHVOLITE .....	351
Discussion, chemical, of Leadville furnaces .....	737	HILL .....	178
OF GEOLOGICAL PHENOMENA .....	276	Endlich, F. M., cited .....	56
smelting charges .....	659	English gulch .....	191, 192, 200
Displacement, amount of, in Mosquito Range .....	39	Epidote, as alteration product .....	330, 341, 357
Disposition of smelting works, general .....	626	Erosion, in Mosquito Range, general .....	40
works at Smelter A .....	669	glacial .....	29, 41, 126
B .....	672	ERUPTIVE FORMATIONS .....	74, 292
C .....	674	ROCKS, capability of absorbing sediment- ary rocks .....	308
E .....	680	complete analyses of .....	358, 589
F .....	681	their influence on structural forms .....	26
G .....	683	why intrusive and not surface flows .....	300
H .....	685	Eureka, Nevada .....	15, 63
Distribution of gold in placer deposits .....	515	EVANS AMPHITHEATRE .....	211
intrusive rocks in the Rocky Mount- ains .....	305	EVENING STAR MINE .....	433
Leadville deposits .....	377	Expenses of smelting per 24 hours .....	668
porphyry bodies in Leadville region .....	206		
rich ore in Leadville deposits .....	494	F.	
sedimentary formations in Mosquito Range .....	72	Fairplay .....	106, 157
DOLLY VARDEN MINE .....	523	FANNY BARRETT MINE .....	526
DOLOMITES, relative solubility of .....	542	Fault:	
used in smelting .....	643	ADELAIDE .....	243, 402
DOLOMITIC SEDIMENTS discussed .....	276	BALL MOUNTAIN .....	215
DOME FAULT .....	386	BREECE .....	236
MINE .....	389	CALIFORNIA .....	385
RIDGE .....	246	Carbonate .....	248, 410
the .....	180, 191, 192	COLORADO PRINCE .....	224
DOUBLE-DECKER MINE .....	408	Connection with folds .....	284
DRUSY CAVITIES in Nevadite .....	347	Curving of beds adjoining a .....	146, 178, 286
DRYING OF THE FURNACE .....	664	DOME .....	386
Dudley, Lincoln Porphyry near town of .....	120	Dyer Mountain .....	212
Dugan quarry .....	167	EMMET .....	250, 386
dolomite analyzed .....	643	HADE OF .....	287
DUST CHAMBER at Smelter A .....	671	IOWA .....	221
B .....	673	IBOX .....	244, 384, 402
C .....	678	London .....	136, 286, 532, 533
D .....	680	MIKE .....	180, 226
E .....	681	Morning Star .....	411, 438, 441
F .....	682	Mosquito .....	181, 184, 198, 211, 285
		Pendery .....	411, 429

	Page.
Fault—Continued.	
Pilot .....	227
reversed .....	225
Sheridan .....	179, 181, 182, 211
Sherman .....	158
South Dyer .....	211, 214
Union .....	180, 228
Weston .....	176, 180, 181, 184, 220
Figures (in the text):	
No. 1. Sandine from Nevadite .....	348
2. Section through Highland Chief mine....	501
3. Section through Colorado Prince mine ...	564
4. Section through Florence mine .....	510
5. Section through Taylor Hill .....	535
6. Section through El Capitan mine .....	536
FILLING OF THE CRUCIBLE .....	665
Fissure veins, theoretical formation of .....	572
Flue-dust, treatment of, at Smelter C .....	679
Fluegger, Th., cited .....	544, 620
Fluorite .....	527
Fluxes, annual consumption of, by smelters .....	637
Fohr, F .....	626
FOLDS AND FAULTS .....	284
Forest rock .....	77
Formation of Leadville deposits, mode of .....	378, 568
FORSAKEN MINE, MORNING STAR AND .....	441
Fortieth Parallel Reports, cited .....	45, 48, 55, 57, 290, 294, 310
Fossils, in Blue Limestone .....	66
Cambrian formations .....	60, 62
Upper Coal Measures .....	70
Weber Grits .....	67
Shales .....	69
White Limestone .....	61, 62
names of, and where mentioned:	
Amplexus .....	70
Archæocidaris .....	67, 70, 103, 177
Astartella .....	70, 177
Athyris subtilita .....	66, 69, 70, 103, 118, 141, 177
Aviculopecten carboniferus .....	155
interlineatus .....	69
rectilateratus .....	67, 178
Bathyrus similimus .....	62
Bellerophon .....	70, 163
crassus .....	70
percarinatus .....	70
Chonetes Glabra .....	70, 177
granulifera .....	67, 162, 177, 178
Cyrtilites .....	62
Dicellocephalus Minnesotensis .....	60, 99
Discina Meeki .....	178
nitida .....	67
Endoceras .....	62
Entolium .....	70
Eocidaris Halliana .....	67
Equisetæ .....	69, 164
Enomphalus .....	70, 118, 480
Spergenensis .....	66
Fenestella .....	70, 103, 155
perelegans .....	67, 177
Glytociastites .....	62
Griffithides .....	155
Leptena melita .....	62
Lingula .....	62
mytiloides .....	162, 381
Lingulepis pinnaeformis .....	62

	Page.
Fossils, names of, and where mentioned—Continued.	
Loxomena .....	70, 103
Macrocheilus primigenius .....	70
ventricosus .....	67, 177
Meekella striæcostata .....	69
Metoptoma .....	62
Microdoma conica .....	70
Microdon obsoletum .....	70
tennistriatum .....	70
Murchisonia .....	70
Myalina peratenuata .....	67, 162
Naticopsis Altonensis .....	70
Nautilus .....	70
Nucula .....	177
Beyriche .....	70
ventricosa .....	70
Orthis carbonarius .....	67, 178
desmoplens .....	62
Orthisina pepinensis .....	62
Orthoceras .....	62
Palæschara .....	67, 177
Phillipsia .....	162, 177
Major .....	67, 162
Piana .....	67
Pleurophorus .....	509
oblongus .....	66, 118
occidentalis .....	70
Pleurotomaria Greyvillensis .....	70
valvatiformis .....	103
Polyphemopsis chrysalis? .....	67
Polypora .....	67, 177
Productus cora .....	67, 70, 103, 155, 162
costatus .....	66, 69, 70, 118, 141, 155, 177
muricatus .....	67, 69, 155
Nebrascensis .....	67, 69, 177
nodosus .....	162
pertenus .....	67, 155
Prattenana .....	70, 177
semireticulatus .....	67, 155, 162
Rhombopora .....	155
lepidodendroides .....	67, 177
Rhyconella .....	412
Endlichi .....	56
Iodianensis .....	61
neglecta .....	61
Spirifera .....	155, 509
camerata .....	67, 70, 155
(Martina) lineata .....	66, 70
Rockymontana .....	62, 70, 118, 157, 177
Spiriferina .....	66
Kentuckensis .....	69, 141
Spergenensis .....	118
Streptorhynchus crassus .....	66, 70, 118, 177, 178
(crenistris) .....	67
Synocladia .....	70, 177
Zaphrentis .....	66, 100, 101
FOUR-MILE AMPHITHEATER .....	153, 158
Freeland, F. T., cited .....	556
Fremont's Pass .....	7, 197
French gulch .....	192
Frontispiece described .....	210
Fryer, Geo., discoveries of .....	13, 464
FRYER HILL .....	255
GROUP .....	445
map explained .....	454

	Page.		Page
Fryer Hill, ore discovered on .....	13	Gray porphyry, lead in .....	578, 591
FUELS AND FLUXES .....	641	silver in .....	579, 594
annual consumption of, by smelters .....	638	strontium in .....	578
used in assaying .....	633	Great Basin region .....	290
Fulgurite on Mount Lincoln .....	111	Green Mountain .....	222, 507
FUMES FROM BARTLETT FILTER .....	717	Green Porphyry .....	83, 97, 117, 132, 231, 343
FURNACES at Smelter A .....	670	silver in .....	579, 594
B .....	673	Grimm, Dr. Joh., cited .....	369, 370, 371, 375
C .....	670	Groddeck, Dr. A. von, cited .....	370, 371, 375
D .....	679	Gunnison region, intrusive bodies in the .....	306
E .....	681	Guyard, Antony .....	ix, 613
F .....	682		
G .....	684	H.	
H .....	687	Hadelberg, cited .....	695
general description of .....	659	HADE OF FAULTS .....	287
G.		Hagno, Arnold, cited .....	63, 805, 355
Gage, Hagsaon & Co's smelter .....	625, 626, 693, 694, 695, 698, 708, 725, 731	Hahn, H. C., cited .....	554
Galena richer than cerussite .....	432	Hardman, J. E., cited .....	645, 658, 698, 701
GANGUE, ESTIMATION OF .....	635	Hare, R. B., cited .....	283
Garnet in porphyrite .....	360	Harrison Reduction Works .....	625, 626, 643, 646, 693, 694, 695, 698, 708, 711
Geikie, Prof. A., cited .....	309, 310, 313, 372, 373, 374, 375	Hayden Atlas of Colorado, referred to .....	56, 62, 106, 153, 193, 342, 343
Gelatinous silica in ore deposits .....	407	Reports, cited .....	3, 4, 23, 53, 70, 161
GEMINI PEAKS .....	140	HEARTH ACCRETIONS .....	725
GENESIS OF LEADVILLE DEPOSITS .....	538	Heinrich, Carl .....	626
ore deposits, Le Conte on the .....	575	Hematite formed from pyrite .....	499
Genetic divisions of eruptive rocks .....	320	used as flux .....	646
Geological history of the Mosquito Range .....	30	HENRIET MINE .....	440
horizons peculiar to ore deposits .....	540	Henry Mountains .....	296, 305
structure of Carbonate Hill .....	409	NOTES ON ROCKS FROM .....	359
Fryer Hill .....	445	HIBERNIA MINE .....	482
Iron Hill .....	361	Higginbotham, Joseph .....	524
North Iron Hill .....	401	HIGHLAND CHIEF MINE .....	501
Gilbert, G. K., cited .....	296, 305, 306, 359	Hohenburg, rhyolite from .....	347
Gillespie & Ballou's Sampling Works .....	629	Holmes, W. H., cited .....	261
Glacial deposits in Mosquito Range .....	93	HOOPER PASS RIDGE .....	100
erosion, amount of .....	127	section .....	101
influence on topography .....	20	RIDGE .....	108
in Mosquito and Buckskin gulches .....	126	Hornblende-diorite .....	84, 333
Mosquito Range .....	44	HORSESHOE GULCH .....	152
FORMATIONS in Mosquito Range .....	92	north wall of .....	155
GNEISS .....	48	THE .....	160
age of .....	52, 277	Horsetails .....	164
Gold, amount taken from California gulch .....	9	Howland post-office .....	190
ASSAYS .....	635	Huantajayit .....	554
DEPOSITS .....	513	Huber, H .....	x
first discovery of, in this region .....	8, 9	Hunt, T. Sterry, cited .....	279
in eruptive rocks .....	579, 584	Huronian, in the Rocky Mountains .....	45
galena .....	514, 545	Hyatt, A., cited .....	71
placer deposits .....	515	Hypersthene-andesite .....	69, 353, 354, 355
method of determination of, in eruptive rocks .....	595	analysis of .....	589
GRAHAM PARK .....	250	barium and strontium in .....	577
GRANITE .....	46	I.	
age of .....	52, 277	Iddinga, J. P., cited .....	305, 329, 355, 356
Creek .....	175	Iles, Dr. M. W., cited .....	411, 616, 646, 674, 699, 700, 701, 710, 726, 727
lead in .....	578, 591	Indiana gulch .....	191
Graut, J. B .....	626	Indium in ores .....	377, 547
Grant smelter .....	625, 626, 641, 643, 644, 646, 693, 694, 695, 698, 699, 700, 701, 708, 711, 717, 725	smelting products .....	714
Grannlar, term defined .....	310	Injection theory .....	570
GRAY PORPHYRY .....	80, 330, 382, 447	INTERNAL STRUCTURE of eruptive rocks .....	302
analysis of .....	332, 358, 589	Intrusive bodies, strata curving round .....	104, 150
distribution of, in Leadville region .....	207	force, amount of .....	298
in dikes .....	230, 447, 459, 461, 463, 465, 466, 468, 470, 472, 478, 481, 482, 483, 484, 490, 502, 511	SHEETS .....	295
		Iodine, method of determination of, in limestone .....	597

	Page.		Page.
Iowa amphitheater .....	210	LEADVILLE DEPOSITS .....	375
FAULT .....	221	GENESIS OF .....	539
GULCH .....	230, 246, 511	why in Blue Limestone .....	540
IRON ASSAYS at smelting works .....	635	East .....	153, 157
-DOME FAULT .....	244	elevation of .....	3
AREA BETWEEN, AND CARBONATE		geological structure under .....	261
FAULT .....	248	metallic products of .....	15
FALLT .....	384, 402	origin of name .....	14
displacement of .....	385	PORPHYRY .....	76
in Chlefftain mine .....	497	position of .....	3, 5, 614
its relation to ore bodies .....	399	routes of approach to .....	6
HILL .....	380, 381	Smelter .....	708
GROUP .....	380	view of, Plate II .....	6
south slope of .....	247	Le Conte, Prof. Jos., cited .....	372, 570
in Leadville ores .....	547	Leffingwell, W. H. .....	ix, 613
MINE .....	394	LENGTH OF RUNS of furnaces in general .....	668
SOWS OR SALAMANDERS .....	722	at Smelter C .....	678
analysis of .....	723	Lesquerens, Prof. L. .....	71
term defined .....	466	Lencexene in Archean schists .....	49, 51
J. .....		Levels in smelting works .....	626
Jacob, Ernest, cited .....	viii, ix, 225, 397, 614	LIME AND MAGNESIA DETERMINATIONS in limestones ..	598
Jamesonite .....	527	SALTS in Leadville ores .....	561
Jarosite .....	376, 550, 605, 607	MINE .....	391
Jelly's specific gravity spring balance, described ...	635	Lime-sand, analysis of .....	450
Jordan, cited .....	734	Limestones, analyses of .....	596, 646
Jorissen, cited .....	593	not formed in deep seas .....	54
JOSEPHINE PORPHYRY .....	245	LINCOLN MASSIVE .....	107
K. .....		PORPHYRY .....	78, 328
Kanab, Paleozoic section in the .....	56	analyses of .....	332, 358, 580
KAOLIN AND CHINESE TALC .....	560	lead in .....	578, 591
analysis of .....	603	silver in .....	579, 594
Keck, Rudolph, cited .....	404	strontium in .....	578
Kellogg, Samuel B .....	8, 10	typical occurrence of .....	111
Keyes, W. S. .....	459	Lithia in eruptive rocks .....	332, 333, 349, 358
King, Clarence .....	vii, 294, 299	Lithium, determination of, in eruptive rocks .....	592
L. .....		Little Bartlett Mountain .....	198
Labor employed at smelters, tabulated .....	640	CHIEF MINE .....	465
Laccolites .....	110, 140, 155, 164, 185, 190, 191, 193, 296, 297, 301, 305, 306	Chief smelter .....	708, 711, 722
LADLING-OUT OF MELTED BULLION .....	667	Cottonwood Cañon .....	369, 310, 311
Lagerio, A., cited .....	283	ELLEN HILL .....	216, 506
Lake beds .....	71, 92, 176, 181, 183, 187, 246, 263, 281, 439, 458, 514, 517, 518	EVANS ANTICLINE .....	259
marl, analyzed .....	598	GIANT MINE .....	424
Lakes, Prof. A., cited .....	viii, 71, 113, 155, 157, 158, 520, 521, 526, 527, 528	PITTSBURGH MINE .....	468
LAMB MOUNTAIN .....	163	Platte Valley .....	173
LA PLATA MINE .....	390	SACRAMENTO GULCH .....	151
smelter .....	625, 626, 643, 693, 694, 695, 698, 706, 708, 711	SLIVER MINE .....	485
Lapparent, A. de, cited .....	570	STRAY HORSE GULCH .....	488
Laramie Hills, Paleozoic formations in .....	55	SYNCLINE .....	253, 260, 495
Lasaulx, A. von, cited .....	49	Zion Mountain .....	186
Lateral secretion theory .....	575	Lizzie smelter .....	698
LATER INTRUSIVE SHEETS on Iron Hill .....	382	LONDON FAULT .....	135, 286, 532, 533
Laurentian in Rocky Mountains .....	45	Hill .....	137, 140, 141
LEAD ASSAYS at smelters .....	635	MINE .....	532
combination in Leadville ores .....	540	Leng, J. T., cited .....	141
DETERMINATIONS in eruptive rocks .....	577	LONG AND DERRY HILL .....	508
in eruptive rocks .....	578, 591	MINE .....	508
lost in fumes .....	717	RIDOE .....	228, 245
Leadville Circular, cited .....	614	Loss of bullion in smelting .....	697
Consolidated Mining Company .....	415	lead in fumes .....	717
		weight of smelting charges .....	741
		Lettner, Prof. H., cited .....	369, 371, 372, 375
		LOVELAND HILL .....	130, 528
		LOWER HENRIETT MINE .....	440
		Printer Boy Mine .....	513
		QUARTZITE .....	58

	Page.		Page.
Lower Quartzite on Fryer Hill .....	453	Mines—Continued.	
WATERLOO MINE.....	440	Alta (t) (E-24).....	220, 233
M.		American Eagle (s).....	262
McALLISTER CHARCOAL KILN.....	642	Amie .....	471
MacFarlane, Thomas, cited.....	628, 700	analysis of kaolin from.....	560, 603
Machines used in crushing.....	629	ore from.....	548, 800, 610
McNULTY GULCH RHYOLITE.....	350	assay of silicious iron from.....	608
MAIN CREST FROM MOSQUITO PEAK TO MOUNT EVANS.	137	White Limestone from.....	608
NORTH OF PTARMIGAN PEAK.....	182	daily output of.....	615
Malta smelter.....	608, 708	Andy Johnson (s) (P-1).....	240, 242, 406
Manganese, a good indication for silver.....	562	Antelope (s) (F-20).....	223
in Leadville deposits.....	547	Argentine.....	405
Manitou Park, hay in Cambrian ocean.....	22	daily output of.....	615
Cambrian formations in.....	62	Argentine (t) (O-28).....	405
Manner of formation of gold deposits.....	515	Argo (s) (R-5).....	260
occurrence of eruptive rocks.....	205	Australian (s) (G-28).....	500
Leadville deposits.....	375, 540	A. Y.....	390
MATCHLESS MINE.....	480	assay of ore from.....	608
MATERIALS USED IN SMELTING.....	636	Aztec (s) (P-54).....	497
MATTES.....	723	Badger Boy.....	154, 533
analysis of.....	724	Bangkok (s) (P-77).....	255, 496
AND ACCRETIONS, treatment of, at Smelter C.	679	Bank of France (s).....	240, 387
AND SPEISS, how taken from furnace.....	667	Belcher (t) (M-5).....	229, 236, 509
assays of.....	725	chief ores of.....	616
defined.....	723, 724	daily output of.....	615
Melvinia tunnel, barium in porphyry from.....	577	Bello Vernon (s) (E-42).....	233
MESOZOIC formations.....	70, 158	Ben Burb (s) (N-21).....	367
METALLIC CONTENTS OF COUNTRY ROCKS.....	574	analysis of chert from.....	602
Metals in Pyriticiferous Porphyry, amount of.....	580, 582	Ben Franklin (t and s) (M-30 and 31).....	234
Metamorphism, contact and regional.....	308	Best Friend.....	211
Metasomatic, term defined.....	565	Bevis.....	498
Method of ore buying.....	627	Discovery (s) (P-6).....	240
sampling.....	628	No. 3 (s) (P-5).....	240
Meyer, A. R.....	12, 14	Big Chief (s) (T-8).....	438
Microcline in ; neiss.....	49	Big Pittsburg.....	482
Micro-sections of andesite, figured on Plate XXI.....	354	analysis of Chinese talo from.....	560
Nevadite, Plate VIII.....	58	kaolin from.....	603
porphyrito, Plate XX.....	336	ore from.....	548, 600, 610
White Porphyry, Plate VIII.....	58	Big Six (s) (K-40).....	239, 240
zircon, Plate XXI.....	354	Birdie Tribble (s) (P-42).....	254
MIKE FAULT.....	180, 226	Bismark (s) (P-20).....	241
AREA BETWEEN, AND IRON-DOME FAULT.....	244	Black Cat (s) (N-23).....	240, 512
MINE.....	235	Black Cloud (s) (E-5).....	222
Mineral deposition, time of.....	33	Black Prince No. 3 (s) (G-49), No. 2 (s) (G-52).....	224
Park.....	117	Blacksmith (s) (Crescent).....	431
Mines: *		Blacktail (t) (M-40).....	232
Abe Lincoln (t) (M-36).....	234, 260	Blind Tom (s) (T-47), Carbonate Hill.....	252, 413
Across the Ocean (s) (K-31).....	239, 500, 601	(s) (O-51), Iron Hill.....	250
assay of silicious iron from.....	608	Bloomington (s) (E-9).....	222
Adelaide.....	408	Bob Ingersoll (s and h h) (S-56).....	262, 267
analysis of carbonate ore from.....	509, 618	Bohtail (s) (P-40).....	241
chief ores of.....	610	Boettcher (t) (Q-20).....	258
daily output of.....	615	Bosco (s) (K-28).....	230, 500
Aerial Queen (s) (E-34).....	229	(s) (I-12).....	258
Etua (s) (T-30 and 36).....	248	Boulder (i) (K-8).....	225
daily output of.....	615	Boulder Nest (s) (P-8).....	246, 498
Agassiz (s) (T-3).....	251, 252, 401, 487, 490	Brecca Iron (K-30 and L-36).....	237, 499
chief ores of.....	616	analysis of ore from.....	617
daily output of.....	615	assay of Hematite from.....	608
Alleghany (t) (D-3).....	222	daily output of.....	615
All Right (Chrysolite).....	257, 455	Brian Born (s) (M-37).....	232, 511
Alps.....	506	Brick Top (s) (I-4).....	258
		Broadway (s) (T-34).....	412

\* Under this entry, s, signifies shaft; t, tunnel; i, incline; b h, bore hole. The letters and numbers (e. g., M-30) denote the location on the Leadville map.



INDEX.

761

	Page.
<b>Mines—Continued.</b>	
Brookland (s) (T-6) .....	430, 438
Buckeye .....	461
Buffalo (s) (P-50) .....	260
Buncombe (s) (Q-13) .....	258
Burt (s) (M-13) .....	234
Caledonia (s) (G-50) .....	225
Caledonian (t), Long and Derry Hill .....	228
California (t) (T-48) .....	413
California Rose .....	228
Campbell (E-25 and E-26) .....	229
Camp Bird (t) (O-27) (Argentine) .....	401, 404, 405
daily output of .....	615
Capitol (s) (F-57) .....	223
Carbonate (i) (T-31 and 32) .....	416
analysis of dolomite from .....	646
daily output of .....	615
Carbonate King (s) (Q-36), Prospect Mountain ..	259
Carbonate No. 2 (s) (Q-37), Prospect Mountain ..	259
Carboniferous, No. 1 (s), No. 5 (s) (Chrysolite) ..	457, 461
Cardinal (s) (Q-39) .....	258
Catalpa (s) (T-24 and 27) .....	431, 443
assay of limestone from .....	608
chief ores of .....	616
daily output of .....	615
Catawba (t) (Q-41) .....	259
Charlie P. (t) (L-28) .....	234
Chemung (t) (K-5) .....	224, 268, 502
Chicago Boy (s) (P-67) .....	260
Chlefftain (t) (P-43) .....	238, 244, 254, 497
daily output of .....	615
Christian Aid .....	529
Chrysolite .....	455
analysis of hematite from .....	557, 602
assay of black iron from .....	608
lime-sand from .....	608
chief ores of .....	616
daily output of .....	615
City Bank .....	249, 387
City of Paris (s) (O-52) .....	250, 385
Clara Dell (s) (P-10) .....	242, 244, 498
Cleopatra (or End Squeeze) (s) (F-12) .....	215
Cleveland (s) (G-27) .....	226, 506
Climax .....	475
assay of black iron from .....	608
White Limestone from .....	608
daily output of .....	615
Clontarf .....	438
Codfish Balls (O-37) .....	245, 248, 384, 402
Coffee (t) .....	228
Colonel Sellers (s and b h) (O-8) .....	247
Colorado Chief (s) (Chrysolite) .....	458
Colorado Prince (G-43 and 47) .....	503
daily output of .....	615
Colorado Springs .....	120, 526
Columbia (t) (O-49), California gulch .....	250, 384, 388
(s) (Q-25), Prospect mountain .....	260
Combination (i) (Carbonate) (T-32) .....	417
Comique (s) .....	461
Commercial Drummer (U-1) .....	249
Comstock (s) (L-17), Broeze Hill .....	236
(t) (L-33), California gulch .....	234
silver in porphyry from .....	504
Continental (s) (M-50) .....	246
Coon Valley (s) (N-22) .....	387, 512

	Page.
<b>Mines—Continued.</b>	
Copenhagen (s) (Q-43) .....	259
Cora Bell (s) (P-78) .....	255, 490
Cordalis Edmonston (s) (P-41) .....	241, 254, 497
Crescent (i) (T-26) .....	430
assay of pyrolusite from .....	608
chief ores of .....	616
daily output of .....	615
lower shaft .....	444
Crascentia (s) (O-50) .....	250, 388, 430
Criterion .....	118, 120, 525
Cullen (s) (P-57) .....	497
Cumberland (s) (L-32) .....	225
Currau (s) (G-56) .....	502
Cyclops (s) (T-1) .....	268, 496
D-4 (s) .....	222
Daly (s) .....	467
Dana (s) (M-3) (Long & Derry) .....	230, 509
Dania (s) (P-30) .....	241
Dauntless (s) (C-12 and 13) .....	217
Day (b h) (O-14) .....	242
Deadbroke (t) (T-16) .....	102, 252, 412
Deer Lodge (s) .....	475
Del Monte (s) (P-45) .....	254
Denver City (s) (P-82) .....	244, 255, 486, 495
Devlin (s) (O-29) .....	245, 250, 401
Dolly Vardeu .....	117, 523
lead in porphyry from .....	591
silver in porphyry from .....	594
Dolphin .....	488
Dome (i) (N-17) .....	359
daily output of .....	615
Dominion .....	527
Double Decker (P-47 and 48) .....	408
daily output of .....	615
Douglas (s) (R-4a) .....	260
Dunkin (s) (S-8) .....	478
assay of lime-sand from .....	608
ore from .....	608
chief ores of .....	616
daily output of .....	615
Dwight .....	522
Dyer .....	213
chief ores of .....	616
E-18 (s) .....	222
E-20 (s) .....	222
E-21 (s) .....	221
Eaton No. 2 (s) (Q-10) .....	456, 457
Echo (s) (N-3) .....	272
Eclipse (t) (M-7 and M-9) .....	232, 513
No. 2 (s) (M-8) .....	234
El Capitan .....	534
analysis of ore from .....	602
lead in porphyry from .....	591
Eliza No. 1 (s) (G-58) .....	224, 501, 502, 503
No. 2 (K-3) .....	224
Ells (t) (F-39) .....	220, 233
Ells Beeler (t) (E-7) .....	220, 221, 228, 229
Ellesmere (B-2) .....	217
El Paso (s) (P-65), Little Stray Horse Park ..	255, 497
analysis of chert from .....	602, 607
El Paso (t) Clinton gulch .....	590
silica in porphyry from .....	594
silver in porphyry from .....	594
Emma (t) (C-10) .....	219

	Page.		Page.
<b>Mines—Continued.</b>		<b>Mines—Continued.</b>	
End Squeeze (or Cleopatra) (s) (F-12) .....	215	Greenback (s) (O-53) .....	221, 496
Equator (t) (E-17) .....	222	Green Mountain (s) (E-12) .....	222, 508
Ernest .....	528	Greenwood (s) (P-14) .....	242, 267
Esmeralda (s) (I-1) .....	258	Grey Eagle (l) (M-53) .....	235
Endora (s) .....	488	Hancock (s) (Q-31) .....	250
Enreka (s) (K-54) .....	236, 352	Half-Way House (s) (S-49) (Henriett) .....	440, 441
Evening Star .....	433	daily output of .....	615
analysis of breccia from .....	602	Hard Cash (s) (P-31 and 35) .....	243, 245
porphyry from .....	557	(P-46) .....	245, 254
assay of ore from .....	608	Harker (s) (Henriett) .....	443
chief ores of .....	616	Hartford, lead in porphyry from .....	591
daily output of .....	615	silver in porphyry from .....	594
main shaft (T-21) .....	433	Hattle (b h) .....	186
No. 5 shaft .....	435	Hazzard (s) (S-31) .....	461
upper shaft (T-11) .....	434	Hecla (s) (Q-2) .....	258
Excelsior (s) (T-12) .....	118, 426, 427, 526	Henriett .....	253, 257, 269
F-6 (s) .....	218	lower .....	410
F-38 (t) .....	233	assay of ore from .....	668
Faint Hope (t) (M-2 and 4) .....	230, 509	Herculeanum (t) (E-14) .....	229
Fairplay (s) (P-34) .....	254	Hercules .....	461
Fairview (s) (S-54) .....	257	Hibernia (s) (S-5) .....	482
Fanny Barret .....	528	chief ore of .....	617
Fat Purse (s) (F-17) .....	215	daily output of .....	615
Fenian Queen (s) (K-22) .....	239	Hidden Treasure (s) (P-7) .....	241
First Chance (s) (P-37) .....	241	Highland Chief (L-1 and G-54) .....	501
First National (s) (E-31) .....	231, 511	chief ore of .....	617
Fitchburg (l) .....	225	daily output of .....	615
Fitz-James (s) (?) (M-54) .....	235	Highland Mary (s) (P-52) .....	238, 250, 255, 401, 495, 496
Five-twenty (s) (L-40) .....	234, 513	(G-55) .....	502
Florence (s) (M-17) .....	231, 510, 511	Highland Queen (s) (F-50) .....	223
chief ores of .....	616	Himalaya (s) (E-35) .....	229
gold ore in .....	545	H. M. L. (s) (K-50) .....	239
Forepaugh (s) (P-76) .....	255, 496	Holden (s) (P-24) .....	241
Forest City .....	486, 495	Homestake (s) (E-36) .....	229, 538
Four Per Cent (s) (S-21) .....	471	chief ores of .....	617
Forseken (Morning Star) (S-55a) .....	441	Hoodoo (N-4) .....	272
analysis of basic sulphate from .....	600	Hoosier (s) (E-19) .....	222, 229
daily output of .....	615	Hoosier Girl (s) (G-44) .....	225, 267
Frank (s) (L-26) .....	234	Horse Shoe (s) (O-9) .....	247
Galesburg (Little) (s) (K-33) .....	240	Humboldt (s) (Q-22) .....	260
Gambetta (s) (S-24) .....	488	Hunkidori (s) (P-72) .....	244, 255, 496
(Pierson) (s) (S-14) .....	487	Hynes (s) (Argentine) .....	396, 465, 466
Garden City (s) (O-48) .....	384, 386, 388	Ida Nyce (s) (S-41) .....	428
analysis of granite from .....	591	Independent (s) (K-42) .....	239
limestone from .....	557, 602	Indiana (s) (P-53) .....	244, 254, 496
Garland (s) (Q-33) .....	258	(P-64) .....	255, 497
Geneva Lake (s) (Q-3) .....	258	Irish Giant (s) (T-35) .....	252, 412, 417
Gildersleeve (s) (E-27) .....	229	Iron (l) (O-34, 35, and 38) .....	247, 389, 393, 394
Glasgow (s) (K-27) .....	236	chief ores of .....	617
Glass No. 2 (s) (T-37) .....	248, 427, 646	daily output of .....	615
Glass-Pendery, analysis of dolomite from .....	644, 645, 646	Iron Duke .....	234, 513
daily output of .....	615	Iron Hat (s) (O-36) .....	402
Globe (s) (O-46) .....	384, 386	Isbpeping (s) (L-42) .....	236
G. M. Favorite (t) (M-44) .....	232, 511	Izzard (s) (G-3) .....	217
Gnome (s) (G-2) .....	217, 506	Jersey .....	529
Gneisson (s) (La Plata) .....	390	J. B. Grant (s) (P-28) .....	241, 266, 498
Golden Eagle (t) (K-1) .....	226	J. D. Ward (s) (M-14) .....	231
Golden Edge .....	326	J. Harlan (s) (T-17) .....	252, 412
lead in porphyry from .....	591	Joe Bates (s) (S-26) .....	463, 487
Gone-Aboard (s) (T-4) .....	251, 268, 496	John Mitchell (s) (F-11) .....	215, 218
Grand View .....	394	Jolly (s) (S-55) .....	441
Great Hope (s) (K-30) .....	228, 239, 240, 266, 500, 501	Jordan (t) (T-14) .....	252, 412
chief ores of .....	616	Julia (s) (K-62) .....	529
Great Prince (s) (Q-50) .....	259	K-14 (s) .....	225, 226

INDEX.

763

	Page.		Page.
<b>Mines — Continued.</b>		<b>Mines — Continued.</b>	
Kansas .....	529	Little Pittsburgh (s) (S-22 and 23) .....	408
Katie .....	324	analysis of chert from .....	557, 602
Katie Sullivan (s) (Q-11) .....	258	daily output of .....	615
Kennebec (s) (P-55) .....	254, 497	Prince (s) (K-32) .....	500, 501
Keno (s) (O-7 and 11) .....	242, 387	daily output of .....	615
Kenosha (t) (M-25) .....	227	Providence (s) (C-8) .....	217
analysis of ore from .....	557, 602	Rische (s) (G-6) .....	217
Kent (s) (L-43) .....	236	Rosie (s) (X-20) .....	250, 387
Keystone (s) (K-58) .....	239	Schnylkill (t) (E-30) .....	233
Kid (t) (M-23) .....	234	Sliver (s) (P-81) .....	255, 485, 495, 496
Kit Carson (Chrysolite) .....	257, 455	Stella (s) (P-21) .....	241, 266
L-34 .....	228	Willie (s) (Q-49) .....	258
L-44 .....	235	L. M. (s) (O-42) .....	384
Lady Jane (s) (L-33a) .....	236	Logan No. 1 (s) (P-27) .....	244, 412
La Harpe (t) (K-12) .....	220, 226	2 (s) (P-23) .....	243
Lalia Rookh (t) (F-61) .....	236	Loker (s) .....	405, 406
lead in porphyry from .....	591	London .....	142
La Plata (t) (N-9) .....	390	analysis of White Porphyry from .....	142, 607
chief ores of .....	617	Long and Derry (t) (E-32) .....	230, 508
daily output of .....	615	assay of ore from .....	608
La Sallo .....	529	daily output of .....	615
Last Chance (s) (G-30 and 31) .....	267, 506	Louis Tell .....	228
Last Rose of Summer .....	252	Louisville (s) (O-13) .....	242, 268
Laura Lynn (s) (O-15) .....	242, 402	Lovejoy (s) (M-29) .....	232
Lawrence (s) (E-10) .....	222	Lower Henriett .....	440
Leavenworth (s) (P-4) .....	242, 244, 498	Morning Star .....	441
Leonard (s) .....	481	Printer Boy (s) (M-47) .....	228, 513
Liberator (s) (Q-12) .....	258	assay of ore from .....	608
Liokeumdidrix (s and b) (P-68) .....	255, 497	Waterloo .....	440
silver in porphyry from .....	594	analysis of basic sulphate from .....	550, 606
Lida (s) (S-52) .....	257, 261, 453	Chinese tale from .....	560
Lillie (t) (C-9) .....	236	Lowland Chief (s) (G-53) .....	168
Lily (s) (O-5) .....	242	Lucknow (s) (Q-54) .....	259
Lime (i) (O-22 and 23) .....	391	Lulu (s) (G-4) .....	217, 506
Little Alice (s) (K-2) .....	224	M-41 (s) .....	246
Annie (t) (E-8) .....	228	McCormick (s) (S-6) (Big Pittsburgh) .....	483
Birdie (s) (N-18) .....	246	McKeon (s) (Iron) .....	395, 400
Blonde (t) (Q-44) .....	259	Magnolia (s) .....	488
Champion (s) (P-11) .....	242, 267, 498	Mahala (s) (T-2) .....	251, 495
Chief (s) (S-27, 28, and 29) .....	465	Maid of Erin (s) (S-38) .....	429, 433
analysis of ore from .....	544, 599, 618	analysis of basic sulphate from .....	550, 606
daily output of .....	615	Mammoth (s) (E-39) .....	231
Christine .....	531	Mary Able (s) (K-35) .....	220
Clara (s) (Q-63) .....	259	Mary Ann (s) (Q-51 and 56) .....	259
Corinne .....	139	Mary Ella (s) (Q-4) .....	258
Daisy (s) .....	488	Maryland (R-3) .....	258
Diamond (s) (T-43) .....	488	Matchless (s) (S-7) .....	480
Ellen (s) (G-5) .....	217, 506	assay of ore from .....	608
daily output of .....	615	chief ores of .....	617
lead, &c., in porphyry from .....	590, 591	daily output of .....	615
Eva (s) (S-53) .....	257, 453	May Queen (S-4) .....	486
Frank (s) (D-2) .....	222	Melvina (t) .....	
Giant .....	424	barium in porphyry from .....	577, 591
daily output of .....	615	lead in porphyry from .....	591
Harry .....	325	Meyer (s) (T-30) (Zetna) .....	410, 428
analysis of porphyry from .....	589, 590	Mike (s) (O-2) .....	235, 507
Hercules (t) (E-6) .....	222	Mineral Park (t) .....	523
Hoosier (s) (P-19) .....	260	Miner Boy daily output of .....	615
Johnny (s) (F-29) .....	224, 503	(Kentucky) (t) (G-42) .....	503, 505
Louise (t) (K-9) .....	220	No. 1, (s) (G-50) .....	503, 505
Maud (t) (I-3) .....	258	2, (s) (G-51) .....	503, 504, 505
Miami (s) (P-58) .....	255, 497	3, (s) (G-48) .....	503
Nell .....	427, 529	Minnehaha (M-15 and 16) (s) .....	230

	Page.	Mines—Continued.	Page.
Mines—Continued.		Mines—Continued.	
Minnie, analysis of ore from.....	556	P-38 .....	260
Minor (t) (M-11) .....	231, 511	Pacific (s) (Q-35) .....	259
Modoo .....	427	Park (s) (O-1 and 4).....	227, 242, 402
Moutans (s), silver in porphyry from.....	594	Pearson (s) (S-14).....	465
Monte Cristo.....	520	Peerless .....	533
Montgomery.....	384	Pendery (s) (T-38).....	236
Moonstone (s) (P-32).....	243	Pennsylvania (s) (K-19).....	236
Moose .....	522	Peoria (s) .....	263
Morning Star (s) (T-0, 10, and 22).....	436, 441	Peru (s) (I-5) .....	258
analysis of basic sulphate from.....	550, 606	Phillips.....	120, 524
Chinese talc from .....	603	Pilot (t) (M-34 and 35) .....	235
kaolin from .....	560	Pine .....	401, 404
assays of ore from .....	608	Pine Forest (t) (D-1).....	222
chief ores of .....	616	P. I. R. (t) (L-29) .....	234
daily output of.....	615	Pittsburgh (s) .....	487, 488
Mountain Boy (s) (K-60).....	237, 498	Pocahontas (s) (T-40).....	262
Lion (s) (Q-21).....	192, 258, 529	Porphyry (s) (E-37) .....	230, 509
Mount Carbon (t) (E-4).....	222	Powhatan (Q-7 and 9).....	260
Moyamensing (s) (S-12).....	487, 495	Present Help .....	110
Mudsill .....	531	Pride of the West (s) (E-15) .....	229
Mystic (s) (R-9) .....	261	Prince of Orleans (s) (P-71).....	496
Nestor (s) (M-28) .....	232	Princeton (t) (Q-52).....	250
Nettie Morgan (s) (K-38) .....	240	Printer Boy.....	234, 271, 382, 513
Nevada (t) (F-14).....	218	discovered .....	10
New Discovery (s) (S-35, 36, 37, and 42) .....	462	Girl (t) (L-39) .....	236, 326
analysis of Chinese talc from.....	560, 603	lead in porphyry from .....	591
kaolin from .....	560	Prospect (l) (T-33).....	252, 412
assay of silicious iron from .....	608	Providence (s) (Q-31) .....	259
New Waterloo (s) (Morning Star).....	441	Q-19 (s) .....	258
New York .....	142, 531	Q-45 (s) .....	259
analysis of White Porphyry from.....	607	Q-46 (s) .....	259
Nightingale (t) (M-33).....	234	Quandary (s) (F-24).....	223
Niles-Augusta .....	443	R-4a (t) .....	260
assay of ore from .....	608	Rarus (s) (P-61).....	254, 496
Nisi Prius (s and t) (N-7, 8, and 10).....	246, 512	Rattling Jack (s) (F-28).....	224, 503
Nora (s) (K-23) .....	239, 500	Raven (s) (P-63) .....	244
Norcom (s) (Q-55) .....	259	Ready Cash .....	598
North Bull's Eye .....	389	Ready Pay.....	101
Star (North Peak ridge) .....	160, 520	Rebel Warrior, lead in porphyry from .....	591
(s) (E-23) .....	220, 233	silver in porphyry from .....	594
Northern Light.....	129, 528	Red-Headed Mary (s) (P-22) .....	243
analysis of porphyrite from.....	580	Resumption (s) (Q-60) .....	249, 258
Now-or-Never (s) (M-49).....	227, 233	Right Angle (s) (P-69).....	244
O-6 (s) .....	242	Robert E. Lee .....	483
O-10 (s) .....	242	analysis of ore from .....	548, 619
O-12 (s) .....	242	chief ore of .....	617
Ocean (s) (F-9).....	218	daily output of .....	615
O'Donovan Rossa (s) (T-44) .....	252, 413	Robert Emmet (t) (O-45).....	250, 495
Ohio Bonanza .....	233	(s) (S-3) .....	251, 496
O. K. (s) (S-30) .....	461	(t) (S-13) .....	251
Olive Branch (s) (P-70) .....	496	Roberts (s) (S-34) (Chrysolite).....	449, 459, 460
Onota (s) (K-56) .....	239, 332, 500	Robinson .....	538, 542
analysis of porphyry from .....	589	Rock (t) (N-14) .....	389
lead in porphyry from .....	591	chief ores of .....	617
silver in porphyry from.....	594	daily output of .....	615
strontium in porphyry from.....	577	Rock Island.....	528
Ontario (s and t) (F-50 and E-51) .....	222, 223, 507	Rome (s) (Q-6) .....	260
assays of ore from .....	608	Rosebud (t) (T-18) .....	252, 412
Oolite (s) (S-57).....	261, 262, 265	Rosie (s) (N-20).....	250, 387
Oro City (s) .....	249, 387	Rothschild (s) (P-9) .....	242, 244
La Plata (t) (N-9) .....	271	Rough and Ready (s) (F-26) .....	262
Orphan Boy.....	529	Russia .....	521
P-25 .....	243	Rustin (s) (La Plata) .....	391
P-29 .....	260	S-10 (s) .....	260

INDEX.

765

	Page.
<b>Mines — Continued.</b>	
Sacramento .....	539
Saint Louis (s) .....	259
Saint Mary's (s) (T-39).....	429
Sammy's Barrel.....	521
Sangamon (t) (M-24).....	232, 511
Sappho (s) (P-13).....	241
Scooper (s) (P-44).....	254, 267, 497
analysis of ore.....	551, 602
assay of ore.....	608
daily output of.....	615
Seek-no-Further (s) (E-38).....	231
Seneca (s) (S-39).....	218
Sequa (s) (S-58).....	261, 262, 265
Shamus O'Brien (a) (P-73).....	255, 324, 496
Shenango (a) (P-16).....	243
Silver Basin (s) (P-33).....	243, 244
Cloud (s) (K-59).....	236
Cord (s) (O-24).....	392
analysis of basic sulphate from.....	606
Pilot (s) (K-3).....	261
Star (a).....	412
Tooth (b h) (G-45).....	225, 266
Wave (a) (O-32a).....	384, 389, 391, 394
analysis of Blue Limestone from.....	596
daily output of.....	615
Slim Jim (s) (G-40).....	225
Sliver.....	456
Smuggler.....	391
daily output of.....	615
Snowbird.....	233
lead in porphyry from.....	591
Snowatorm (s) (I-59).....	255
Soda Card (s) (M-20).....	234
South Bull's Eye.....	392
Spotted Tail (s) (I-2).....	258
Stars and Stripes (t) (M-19).....	232
Stillwell (t) (K-11).....	220, 226
Stone.....	396
Stonewall Jackson (a) (S-15).....	487
Sullivan (s).....	387
Superior (s) (K-61).....	237, 498
Surprise (a) (S-2) (May Queen).....	486
Swamp Angel (t) (T-15).....	252, 412
analysis of Chinese talc from.....	560, 603
Sweet Home.....	527
Swing (t) (Q-42).....	259
T-46.....	252
Tanner Boy.....	527
Tcuderfoot (s) (G-26).....	226, 506
Terrible.....	401, 408
Texas Boy's Chance (a) (I-15).....	258
Ranger (I-7).....	253
Theresa (s) (K-57).....	237, 499
Thesplan.....	427
Thin Space (s) (I-6).....	253
Third Term (s) (S-44).....	261
Tiger (a and b h) (E-22) (K-47).....	226, 222, 239, 507
Tinker (s) (E-43).....	233
Tip Top (s) (P-75).....	255, 485, 496
Tootic Gaylord (a) (K-40).....	239
Triangle.....	456, 457, 462
Tribuno (a) (L-11).....	236
Tucson (s) (O-29).....	396, 398
daily output of.....	615

	Page.
<b>Mines — Continued.</b>	
Uncle Sam (s and t) (F-32 and 33).....	224, 259, 269, 503
Union Emms (a) (P-79).....	255, 400
United States Mint (s) (G-38).....	226
Uranus (a) (K-53).....	239
Vanderbilt (s) (S-25).....	405, 487
assay of silicious hematite from.....	608
Vining (s) (N-19).....	249, 386, 387
Virginus (s) (S-9).....	477
chief ores of.....	617
daily output of.....	615
(t) (G-24).....	506
Vulture No. 1, 2 (S-45 and 50) (Chrysolite).....	455-457, 460
Wall Street (s) (G-J).....	217
Ward (s) (Adelaide) (O-17).....	494, 407, 408
Washburne (s) (T-29).....	262
Waterloo (a) (S-48).....	440
analysis of basic sulphate from.....	559
granular quartz from.....	557, 602
ore from.....	544, 599, 608
Wednesday (t) lead in porphyry from.....	591
Weldon (s) (T-41).....	262
West Shamrock (i) (Carbonate).....	416
White Check (s) (K-48).....	239
White Cloud (s) (K-15).....	225
White Prince (s) (K-36).....	240
White Rabbit (s) (P-17).....	241
Wild Cat (a) (T-28).....	443
William and Mary (t) (P-12).....	241
William Wallace.....	427
Wilson (s) (M-38).....	232, 511
Wionemuck (s) (Little Pittsburgh).....	471
Wolfe Tone (s) (T-5).....	251, 252, 439, 405
Woodruff (a) (P-15).....	243, 244
Wright (a) (P-74) (Denver City).....	255
Wynan (a) (M-12).....	234
Yankee Doodle (T-20 and 25).....	425
daily output of.....	615
Yates (s) (F-66).....	220
Young Caribou (P-59).....	255
Ypailanti (s) (S-46).....	488
Zulu King (N-24).....	249
<b>MINES AND PROSPECTS IN THE LEADVILLE REGION ...</b>	<b>493</b>
<b>OUTSIDE THE LEADVILLE RE-</b>	
<b>GION .....</b>	<b>519</b>
where mentioned in text. ( <i>See</i>	
<b>MINES.)</b>	
Mine workings of Carbonate Hill, northern group..	429
southern group..	414
Fryer Hill.....	445
Iron Hill.....	389
North Iron Hill.....	495
Mode of formation of Leadville deposits.....	378, 565
Moesta, Dr. F. A. cited.....	549, 551
Moisture, estimation of, by smelters.....	635
Molybdenum in furnace products.....	721, 723
Monte Amiats, Tuscan, trachyte from.....	321
<b>MONTE CRISTO MINE .....</b>	<b>529</b>
Montgomery quarry dolomite, analyses of.....	643
towu of.....	96, 521
<b>MOOSE MINE.....</b>	<b>522</b>
<b>MORNINO STAR FAULT.....</b>	<b>411, 438, 441</b>
<b>MINE.....</b>	<b>430, 441</b>
<b>MOSQUITO FAULT.....</b>	<b>181, 184, 198, 211, 285</b>

	Page.	N.	Page.
MOSQUITO FAULT, AREA BETWEEN, AND BALL MOUNTAIN FAULT .....	215	NEVADITE .....	87, 195, 201, 205, 300, 303, 345, 580
AREA EAST OF .....	209	analysis of .....	349, 358, 580
map explained .....	90	definition of .....	345
Pass .....	137	figured .....	88
road .....	130	metallic contents of .....	581
Peak .....	139, 142	sanidine from, figured .....	348
Porphyry .....	83, 96, 113, 125, 327	topaz in .....	87, 347
RANGE .....	27	Newberry, Prof. J. S., cited .....	54, 372, 568
age of uplift of .....	31	NEW DISCOVERY MINE .....	462
amount of displacement in .....	39	New metal .....	714
dynamic movements in .....	32, 35	Nickel in Leadville ores .....	547, 720, 724
geological history of .....	30	separation from cobalt .....	721, 723
topographical description of .....	27	Nigrine in amphibolite .....	50
volcanic rocks in .....	39	NILES-AUGUSTA MINE .....	443
section of Paleozoic formations .....	57	NON-ABSORPTION OF SEDIMENTARY ROCKS BY ERUPTIVE MASSES .....	308
Mottled porphyry, why so named .....	383	No Name gulch .....	189
Mountain elevation, theory of .....	24	Non-conformity by erosion in Paleozoic .....	61, 188
STRUCTURE .....	24	NORTH IRON HILL .....	248, 401
Mountains and peaks:		MOSQUITO AMPHITHEATER .....	125
Arkansas .....	200	SECTION .....	131
Baldhead .....	135	Peak ridge .....	98
Ball .....	219, 221, 223	NOTES UPON METHODS OF ANALYSES .....	589
Bartlett .....	198, 190, 201	THE HENRY MOUNTAIN ROCKS .....	350
Bross .....	115		
Buckeye (peak) .....	193	O.	
Bucksakiu .....	124, 125	Ohio and Missouri smelter .....	625, 626, 693, 694, 695, 698, 708, 711, 712
Buffalo (peaks) .....	28, 175, 302	OLDER ERUPTIVES .....	323
Camerou .....	115	ORE BEDS .....	648
Chalk .....	194, 302	BUYING .....	627
Democrat .....	124	currents, direction of .....	571, 573
Dyer .....	150, 212	Deposition, previous to faulting .....	399
East Ball .....	215	on Iron fault, secondary .....	400
Evas .....	139, 214	DEPOSITS .....	367
Gemini (peaks) .....	149	GENESIS OF LEADVILLE .....	539
Green .....	222, 507	manner of occurrence of .....	540
Lamb .....	163	mode of formation of .....	565
Lincoln .....	107, 110	on Carbonate Hill .....	411
Little Bartlett .....	198	Fryer Hill .....	451, 490
Little Zion .....	180	North Iron Hill .....	404
Mosquito (peak) .....	139, 142	replacement of limestone .....	406, 407
North (peak) .....	98	scientific study of .....	368
Peerless .....	159, 182	PROSPECTS IN UNEXPLORED AREAS .....	518
Prospect .....	184, 257	ORES AND VEIN MATERIALS, composition of .....	543, 599
Ptarmigan (peak) .....	182	annual consumption of, by smelters .....	637
Quandary .....	98	deposited as sulphides .....	562
Sheep .....	168	of chief mines described .....	616
Sheridan .....	182	ORIGIN OF METALS in Leadville deposits .....	379, 569
Sherman .....	159, 210	SERPENTINE .....	282
Silverheels .....	105	structure in eruptive rocks .....	320
South (peak) .....	174	Orthoclase in porphyrite .....	336, 339
Spanish (peaks) .....	306	Orthoclastic and plagioclastic rocks .....	304
West Dyer .....	214	OTHER GROUPS OF MINES .....	493
Sheridan .....	212	Outcrop deposits richer than those in depth .....	554
Weston's (peak) .....	172	Output of Leadville mines, tabulated .....	615
Zion .....	186		
MOUNT ZION PORPHYRY .....	76, 185, 323, 326	P.	
analysis of .....	326, 358, 589	PALEOZOIC FORMATIONS .....	53, 277
Mourne Mountains, Ireland, granite in .....	309	ore in .....	541
MUFFLES, used in assaying .....	633	sections of .....	57, 133, 166, 213, 381
Murray, John, cited .....	54	Park city .....	131
Muscovite, alteration product of biotite .....	324, 325, 357	province .....	291
feldspar in sandstones .....	68		

INDEX.

767

	Page.		Page.
Park Range, propriety of name.....	23	Plates, where described or referred to—Continued.	
PARKS of Colorado, geological structure of.....	22	XXXIV.....	682
PARTING QUARTZITE.....	61, 453	XXXV.....	684
Patent tuyeres at smelter F.....	682	XXXVI.....	685, 739
Peale, Dr. A. C., cited.....	306, 342	XXXVII.....	666, 687, 688
PECULIAR ACCRETIONS.....	730	XXXVIII.....	635, 688
analyses of.....	730, 731	XXXIX.....	632
Peerless Mountain.....	159, 182	XL.....	689
Pegmatite, age of.....	52	XLI.....	630
defined.....	43	XLII.....	636, 662, 663
PENDERY FAULT.....	411, 428	XLIII.....	632-635
PENNSYLVANIA HILL.....	135, 137, 138, 144	XLIV.....	657, 666, 667, 677, 685, 686
Percy, Dr. John, cited.....	550, 551, 732-737	XLV.....	632, 678, 685, 686, 692
Permo-Carboniferous.....	69, 71	Pogonip limestoue, fauna of.....	62
PETROGRAPHY, by Whitman Cross.....	319	PORPHYRITE.....	85, 334
Phillips, J. Arthur, cited.....	372	analyses of.....	340, 358, 589
Phyllite in Archean.....	51	defined.....	75, 319
Pigtail gulch.....	234	dikes.....	124-126, 134, 160, 200, 201
Pike's Peak excitement.....	8	figured.....	84
Pilot fault.....	227	lead in.....	578, 591
Piney Creek.....	189	silver in.....	579, 594
River.....	7	strontium in.....	577
PLACER DEPOSITS.....	515	Porphyry bodies causing swelling out of strata.....	104, 156
PLANT AND SMELTING OPERATIONS in general.....	659	form of, indeterminable.....	584
of individual smelt- ops.....	669	possible contents of.....	582
OF SMELTERS, tsbulated.....	639	Pošepeň, F., cited.....	371, 374
COST OF.....	626	POST-GLACIAL FORMATIONS.....	72
Plateau region.....	289	Pre-existing cavities, ores deposited in?.....	371, 373, 374, 378, 394, 467, 563, 617
PLATTE AMPHITHEATER.....	94	PRELIMINARY CONDITIONS OF SMELTING.....	614
glacier.....	106	Prime, Fred., jr.....	371
Plates, where described or referred to:		PRINTER BOY HILL.....	231, 510
I (frontispiece).....	210	porphyry.....	234, 382, 513, 514, 516
II.....	5, 6, 140	PROCESSES OF ALTERATION of Leadville ores.....	550
III.....	28, 149	smelting, conclusions in regard to.....	745
IV.....	52, 94, 124, 200	Production, tables of, of metals.....	16, 18
V.....	60, 70, 134, 177	PRODUCTS OF SMELTING.....	692
VI.....	64, 280, 384	Profits of smelting (per 24 hours).....	669
VII.....	84-86, 134, 200, 338, 339	PROPERTIES OF SLAGS.....	702
VIII.....	87, 346	PROSPECT MOUNTAIN.....	184, 257
IX.....	91, 94, 95, 107, 117	Ridge.....	215
X.....	98, 99	Pseudomorphs of cerussite after galena.....	452
XI.....	111, 112	Ptarmigan Peak, main crest north of.....	182
XII.....	113, 114	PULVERIZATION of ores for assaying.....	632
XIII.....	128, 527, 529	Pumpelly, R., cited.....	372-375
XIV.....	131, 132	Pyrite, analysis of.....	556
XV.....	37, 147, 148, 152	in White Porphyry.....	495, 499
XVI.....	37, 153, 154	original in Pyritiferous Porphyry.....	82, 327
XVII.....	153, 158, 160	replacing fossils.....	177
XVIII.....	37, 164, 165	PYRITIFEROUS PORPHYRY.....	82, 222, 233, 235, 326
XIX.....	195, 196	area of.....	582
XX.....	336-339	barium in.....	577, 591
XXI.....	330, 354	distribution of, in Leadville region.....	208
XXII.....	420, 428, 435, 441, 560	gold in.....	579, 594
XXIII.....	666, 670	lead in.....	578, 591
XXIV.....	671	metallic contents of.....	580, 582, 583
XXV.....	669-671	silver in.....	579, 594
XXVI.....	659	PYROXENE-BEARING HORNBLende-ANDESITE.....	353
XXVII.....	661		
XXVIII.....	642, 673	Q.	
XXIX.....	664, 676	QUANDARY PEAK.....	98
XXX.....	678	QUARTZIFEROUS TRACHYTE.....	352
XXXI.....	627, 651, 664, 674, 677	QUARTZ-MICA DIORITE.....	84, 333
XXXII.....	676, 680	PORPHYRY.....	323
XXXIII.....	682		

	Page.		Page.
Quartzville, town of .....	122, 521	SACRAMENTO MINE .....	530
QUATERNARY .....	71	PORPHYRITE .....	341
		PORPHYRY .....	81, 150
R.		silver in .....	579, 594
Raimondi, cited .....	554	Sablite in gneiss .....	49
Rammelsberg, cited .....	50	SALE OF BULLION .....	692
Rates paid for ore at Leadville .....	628	SAMPLING of ores .....	628
Rath, G. vom, cited .....	321	bullion at Smelter C. ....	678
RAW MATERIALS entering into smelting charges .....	738	WORKS .....	629
Raymond, R. W., cited .....	372	Sandberger, F., cited .....	561, 570, 575, 576
Raymond, Sherman & McKay's smelter .....	625, 626, 693, 708	Sandy limestones, term defined .....	59
REACTIONS IN THE BLAST-FURNACES .....	731	Sangre de Cristo Range, Archean areas in .....	24
of iron compounds .....	736	Sanidine from Nevadite, figured .....	348
lead compounds .....	732	satin-like luster of .....	348
silver compounds .....	735	San Juan region, Archean areas in .....	24
READY CASH MINE .....	508	secondary eruptives in .....	306
RECENT FORMATIONS .....	72	Sawatch Range, Archean land mass .....	23
RED AMPHITHEATER .....	119	Scoria, defined .....	701
Red-cast beds .....	134, 169	SECONDARY ERUPTIVES .....	74
specimen from, figured .....	60	felds .....	122, 130
RELATION OF FORM TO COMPOSITION, intrusive bodies .....	297	Section of Cambrian .....	119, 132
RELATIVE AGE of Archean rocks .....	51	Paleozoic .....	57, 58, 120, 128, 133, 155, 166, 187, 213, 381
eruptive rocks .....	319	Weber grits .....	101, 123
RICHNESS OF GALENA AND CERUSSITE .....	553	on Iron fault .....	400
Replacement, evidence of .....	394, 407, 414, 419, 420, 424, 435, 446, 480, 548, 566, 568	Sections of Leadville map explained .....	263
Rhedocresites .....	527	Selenium in Leadville ores .....	547, 714
RHYOLITE .....	87, 181, 345	Sénarmont, cited .....	509
cobalt in .....	591	Serio, Prof. A., cited .....	370
from Black Hill .....	170, 171, 349	Serpentine .....	60, 120, 121, 234, 281
Chalk Mountain .....	345	analyses of .....	598
Empiro gulch .....	351	SHAFT ACCRETIONS .....	726
McNulty gulch .....	350	Sheep Creek .....	171
silver in .....	579, 594	MOUNTAIN .....	168
zinc in .....	591	Ridge, structure of .....	162
Rhyolitic breccia from Enreka shaft .....	230, 352	RIDGE .....	169
tufa from South Park .....	170, 352	Sheridan fault .....	179, 181, 182, 211
Richtshofen, W. B. v. .....	x	Mount .....	182
Ricketts, L. D., cited .....	436, 437, 438, 443, 549, 553, 604, 605	Sherman fault .....	158
ROASTED CHAMBER DUST .....	715	Mount .....	159, 210
ROASTING FURNACE, at Smelter A .....	671	SHIPMENT OF BULLION. Table VII .....	693
ROBERT E. LEE MINE .....	483	Sierra Abaje, laccolites in .....	306
Robinson, Geo. H. .....	x	Carriso, laccolites in .....	306
Limestone .....	69, 198, 279, 506, 646	El Late, laccolites in .....	306
Rock constituents of eruptive rocks .....	356	La Sal, laccolites in .....	306
FORMATIONS .....	45	SILICA AND ALKALI DETERMINATIONS .....	590
on Carbonate Hill .....	409	SILURIAN .....	60
Fryer Hill .....	447	SILVER AND GOLD DETERMINATIONS .....	579
Iron Hill .....	381	in eruptive rocks .....	579, 594
North Iron Hill .....	402	as chloride in Leadville ores .....	548
MINE .....	380	ASSAYS .....	634
ROCKY MOUNTAINS IN COLORADO .....	19	CORD MINE .....	392
uplift, shore-line .....	211	method of determination of, in eruptive rocks .....	595
Rodwell, cited .....	734	SILVERHEELS MASSIVE .....	164
ROOT'S POSITIVE-BLAST BLOWER .....	663	Mount .....	105
Rosenbusch, H., quoted .....	46, 320	PORPHYRITE .....	342
Roth, J., cited .....	283, 551, 563, 564	PORPHYRY .....	83, 105
Rough-and-Tumbling Creek .....	175	Siphon-tap, described .....	660
Round Hill .....	169	Skimmings of bullion analyzed .....	696
RUNNING WITH DAER-TOP .....	666	SLAO .....	698
RUSSIA MINE .....	521	analyses of .....	701, 704
Rutile .....	49, 50, 324, 325, 327, 328, 330, 332, 342, 357	assays of .....	698
S.		defined .....	701, 703
SACRAMENTO AMPHITHEATER .....	140	in smelting charges, composition of .....	739
ARCH .....	147	MOLDS .....	633



INDEX.

769

	Page.		Page.
Slag, opacity of.....	702	Specimens of Contorted limestone (Upper Coal Measure), figured.....	60
physical character and contents of.....	708	Nevadite, figured.....	88
properties of.....	702	Porphyrite, figured.....	336
SPECIAL RESEARCHES ON.....	701	Red-cast beds (Cambrian), figured.....	60
treatment of, at Smelter C.....	678	SPEISS.....	710
Slide, defined.....	381	analysis of.....	720
SMELTING CHARGES.....	649	assays of.....	721
at Smelter G.....	685	defined.....	721
composition in pounds of.....	740	SPRING VALLEY.....	152
constituents of.....	738	Square furnaces, general description of.....	659
loss of weight in different zones of furnace.....	741	S-shaped fold.....	147, 163, 284, 286, 287, 290, 292
Smelting of fine and chamber dust.....	666	Stalactites in Sacramento mine.....	530
OPERATIONS IN GENERAL.....	664	Staa, J. S., cited.....	554
PLANT IN GENERAL.....	659	STATISTICS OF LEADVILLE SMELTERS.....	637
as furnished by Fraser & Chalmers.....	689	Steamboat Springs.....	570
WORKS of Leadville.....	625	Stevens, W. H.....	11
Smelter A: Plant and operations of.....	669	STONE MINE.....	390
Smelting charges at.....	649	STREAM EROSION.....	42
B: Plant and operations of.....	672	Streng, cited.....	332
Smelting charges at.....	650	Strike faults.....	284
C: Barring-down at.....	677	Strontium in eruptive rocks.....	326, 332, 340, 358, 577
Plant and operations of.....	674	STRUCTURAL FEATURES.....	284
Sampling of bullion at.....	678	FORMS of porphyrito.....	337
Smelting charges at.....	682	RESULTS OF DYNAMIC MOVEMENTS.....	34
Treatment of slags at.....	678	Strüver, cited.....	348
Zones of temperature in furnace of.....	739	Sublimation theory.....	570
D: Plant and operations of.....	679	Subsidence and elevation, interchangeable terms.....	289
Smelting charges at.....	654	Sulphates, solubility of metallic.....	551
E: Plant and operations of.....	680	Sulphide ore, analysis of.....	556
Smelting charges at.....	654	Sulphides, dolomites.....	645
F: Plant and operations of.....	681	solubility of metallic.....	551
Smelting charges at.....	655	Sulphur Bank.....	570
G: Plant and operations of.....	683	native, from galena.....	397
Smelting charges at.....	656	SURFACE FEATURES of Mosquito Range.....	91
H: Plant and operations of.....	685	waters, composition of.....	552
Smelting charges at.....	656	defined.....	280
I: Plant and operations of.....	688	SYNCLINE EAST OF YANKEE HILL.....	500
Smelting charges at.....	657		
J: Plant and operations of.....	688	T.	
K: Plant and operations of.....	689	Tabor, H. A. W.....	8, 13
L: Plant and operations of.....	690	TAKING SPECIMENS OF SLAG FOR ASSAY.....	667
M: Plant and operations of.....	690	Tapping clay, analysis of.....	641
N: Plant and operations of.....	691	TAPPING OF SLAG.....	666
O: Plant and operations of.....	691	Taylor Hill.....	189, 535
P: Plant and operations of.....	691	Tellurium in Leadville ore.....	547, 714
Smith, M. E.....	626	TEN-MILE AND CLINTON AMPHITHEATERS.....	201
SMUGGLER MINE.....	391	district.....	537, 540, 562, 578
Selfataric waters, defined.....	563	Tennessee gulch.....	189
SOURCE OF INTRUSIVE FORCE.....	299	PARK.....	189
SOURCE OF METALS.....	571	TERTIARY BRUPTIVES.....	86
SOUTH BULL'S EYE MINE.....	392	Thallium.....	714
Dyer fault.....	211, 214	THEORETICAL DISCUSSION of smelting processes.....	731
EVANS ANTICLINE.....	225, 501	Thermal spring origin for fissure veins.....	576
MOSQUITO AMPHITHEATER.....	140	Timber line, elevation of.....	28, 91
SECTION.....	153	Tin.....	377, 694, 729
Park coke.....	642	Titanite in amphibolite.....	50
PEAK RIDGE.....	174	Titanomorphito in gneiss.....	49
WALL OF HORSESHOE GULCH.....	161	TOOLS for assaying.....	633
Sows or salamanders.....	722	Topaz in rhyolite.....	87, 347
Spanish Peaks, laccolites at.....	306	Topley & Lebour, cited.....	297
SPECIAL RESEARCHES ON SLAGS.....	701	Topography, influence of glacial action on.....	29
SPECIFIC GRAVITY DETERMINATIONS OF SLAGS.....	635, 686, 700	and geology, interdependence of.....	29
Specimens of andesite (hornblende), figured.....	354	Tourmaline in Archean schists.....	51
Blue Limestone, figured.....	64		

	Page.		Page.
Trachyte .....	88, 352, 362	WASSON'S PASS .....	173
silver in .....	579, 594	WEST SHERIDAN .....	212
Triassic limestone, analysis of .....	598	Wet Mountains, Archean areas in .....	24
True fissure veins .....	375	Whin Sill .....	297
TWELVE-MILE AMPHITHEATER .....	172	WHITE LIMESTONE .....	60, 453
CREEK .....	171	analysis of .....	65, 214, 596
Tyson, S. T. ....	626	PORPHYRY .....	70, 324
		analysis of .....	326, 358, 589
U.		barium in .....	577, 591
Utah Range .....	290, 291	cross-cutting zone of .....	207, 402, 446, 495
Unexplored areas, ore prospects in .....	518	cutting Lincoln Porphyry .....	112, 114
Union fault .....	180, 228	distribution of, in Leadville region .....	206
UPPER COAL MEASURES .....	69	included in Sacramento Porphyry .....	150
limestone figured .....	60	in dike .....	96, 97, 112, 114, 164, 165, 178, 211, 324, 501
UPPER TEN-MILE VALLEY .....	197	lead in .....	578, 591
		main laccolite of .....	154
V.		on Fryer Hill .....	448
VALLEYS, classified .....	42	Iron Hill .....	383
Vanadium .....	377	silver in .....	579, 594
Vela materials, analysis of .....	557, 599	typical development of .....	167
COMPOSITION OF .....	556	WHITE RIDGE .....	153
on Fryer Hill .....	451	Whitfield, R. P., cited .....	56
VIOGINIUS MINE .....	477	Whitney, J. D., cited .....	372, 373, 375
Vogel, A., cited .....	554	WILD CAT MINE .....	443
VOLCANIC ROCKS in Mosquito Range .....	39	Wilson, A. D. ....	viii
Volhard .....	593	Wilson, N. R. ....	626
		Wolf, Fritz .....	626
W.		Wood, A. B. ....	11
Walcott, C. D., cited .....	56, 57, 62	Wood, T. S. ....	483
Warm Spring .....	169		
Pass .....	169	Y.	
Wasatch Range .....	55, 58, 306	YANKEE DOODLE MINE .....	425
Wash defined .....	41, 72	HILL ANTICLINE .....	240, 260, 498
WATCHING THE FURNACE .....	667	NORTH SLOPE of .....	240
Water level in mines .....	378	SOUTH SLOPE of .....	241
WATERLOO MINE .....	440	SOUTHWEST SLOPE of .....	243
Waverly formation .....	55, 56	SYNCLINE EAST of .....	238
WERER GRITS .....	68	YOUNGER ERUPTIVES .....	345
SHALES .....	67		
WEIGHT OF BLAST in Leadville furnaces .....	740	Z.	
gases in Leadville furnaces .....	741	Ziuc, in eruptive rocks .....	591
Werner, A. G., cited .....	569	area .....	547, 618
Werner, Aug., cited .....	613, 626, 682	Zinkenite .....	527
WESTERN SLOPES of Mosquito Range .....	175	Zircon figured, Plate XXI .....	354
WESTON FAULT .....	170, 180, 181, 184, 220	in eruptive rocks .....	323, 327, 328, 329, 330, 333, 334, 335, 336, 341, 340, 359
area between Ball Mt. fault and .....	219	Zirkel, F., cited .....	viii, 347
area between, and Mike fault .....	226		
Weston's Creek .....	176		











