

JOHN YOUNG,  
BOOKSELLERS,  
23, Yonge St.  
TORONTO.

1188

RB 29-413



*Presented to the*  
LIBRARY *of the*  
UNIVERSITY OF TORONTO

*by*

E. J. Revell

Digitized by the Internet Archive  
in 2018 with funding from  
University of Toronto

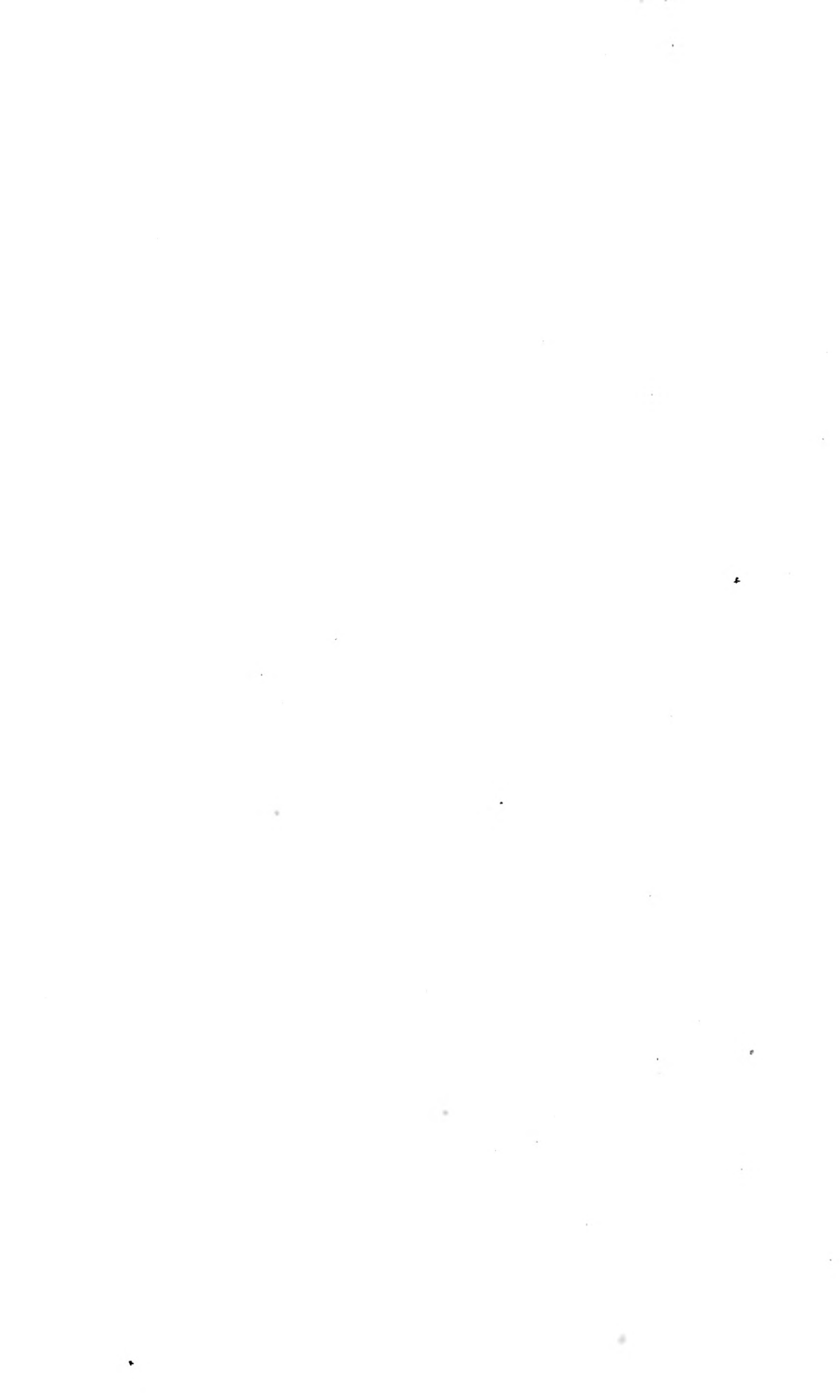

*Published by James Miller, 522 Broadway.*

---

ELIZABETH BARRETT BROWNING'S

POEMS:

newly stereotyped edition, containing all the Poems of this highly  
gifted Poetess; with a Memoir by THEODORE TILTON,  
and a Portrait on Steel.

**Four Volumes. Four Dollars.**

---

*In a separate form,*

AURORA LEIGH.

One Dollar.

LAST POEMS.

WITH A MEMORIAL BY THEODORE TILTON, AND A  
PORTRAIT ON STEEL.

One Dollar.

---

JUST PUBLISHED,

ESSAYS

ON THE

GREEK CHRISTIAN POETS

AND THE

ENGLISH POETS,

FROM CHAUCER TO WORDSWORTH.

One Dollar.

---

\*.\* *The above can be had either in blue and gold,  
or brown cloth.*

*Published by James Miller, New York.*

---

THE STORY  
OF THE  
REDBOOK OF APPIN:

A Fairy Tale of the Middle Ages.

WITH

AN INTERPRETATION.

By the Author of "Alchemy and the Alchemists," "Swendborg,  
Hermetic Philosopher," and "Christ the Spirit."

Price \$1.00.

---

THE ICE MAIDEN,

And other Tales.

By HANS CHRISTIAN ANDERSEN.

Translated by FANNY FULLER.—Price 75 cents.

---

ON THE  
CHARACTER AND INFLUENCE  
OF  
WASHINGTON.

By M. GUIZOT.

75 cents.

---

FRIENDS IN COUNCIL:

A SERIES OF READINGS, AND DISCOURSES THEREON.

4 vols. 12mo.

A GUIDE  
TO THE  
SCIENTIFIC KNOWLEDGE  
OF THINGS FAMILIAR;

BY

REV. DR. BREWER,

TRINITY HALL, CAMBRIDGE,

Head Master of King's College School, Norwich—in union with King's  
College, London.

Carefully Revised, and adapted for use in Families  
and Schools of the United States.

---

NEW YORK:  
JAMES MILLER, 522 BROADWAY,

(SUCCESSOR TO C. S. FRANCIS & CO.)

1864.

---

Entered, according to Act of Congress, in the year 1850,  
By C. S. FRANCIS & Co.,  
in the Office of the Clerk of the District Court of the Southern  
District of New York.

---



## PREFACE.

---

No science is more generally interesting than that which explains the common phenomena of life. We see that salt and snow are both white, a rose red, leaves green, and the violet a deep purple; but how few persons ever ask the reason why! We know that a flute produces a musical sound, and a cracked bell a discordant one—that fire is hot, ice cold, and a candle luminous—that water boils when subjected to heat, and freezes from cold; but when a child looks up into our face and asks us “why”—how many times is it silenced with a frown, or called “very foolish for asking such silly questions!” The object of the present book is to explain about 2000 of these questions (which are often more easily asked than answered) in language so simple that a child may understand it, yet not so childish as to offend the scientific. In order to secure the strictest accuracy in the answers, the most approved modern authors have been consulted, and each edition has been submitted to the revision of gentlemen of acknowledged reputation for scientific attainments. Sincere thanks are due to the REV. A. BATH POWER, M. A., and to ROBERT JAMES MANN, Esq., M. R. C. S., of Buxton, for their most careful revisions of the whole book, for many excellent hints and useful additions. In conclusion, the almost unparalleled success of this little volume, of which 25,000 copies

have been printed, since the year 1848, is an incontrovertible proof of its acceptability; and has induced the author to spare neither labor nor expense to render his "Guide to the Scientific Knowledge of Things Familiar" instructive and amusing to the young, as well as to those of maturer life.

To teachers of schools it may be advisable to state, that, as every question has been again and again submitted to a most rigid investigation, no material alterations will be made in future editions.

---

A remarkable instance came before the author a few months since of the statement made in the early part of this preface. The conversation was about smoke—why it was black, and not white like the fine dust of lime. A little child who was present, asked, "Why is the kettle so black with smoke?" Her papa answered, "Because it has been on the fire;" "But" (urged the child) "what is the good of its being black?" The gentleman replied, "Silly child—you ask very foolish questions—sit down and hold your tongue." He might have read pp. 185, and 186, and answered the child more discreetly.

---

THE AMERICAN PUBLISHERS offer their revised edition of this useful book, in full confidence that it will meet with an equal and universal acceptance both in families and schools, throughout this country. They believe it will be found to contain an amount of useful information never before collected in a shape so convenient for study, and so easy for reference.

# SUBJECTS OF THE CHAPTERS.

---

## PART I.—HEAT.

---

	PAGE
Introduction . . . . .	9
I.—The SUN a source of heat . . . . .	10
II.—ELECTRICITY a source of heat . . . . .	11
II.—Thunder and lightning . . . . .	11—36
III.—CHEMICAL ACTION a source of heat . . . . .	36
III.—Chemical action . . . . .	36
IV.—Combustion . . . . .	39
V.—Smoke and smoky chimneys . . . . .	62
VI.—Lamps and candles . . . . .	74
VII.—Animal heat . . . . .	83
VIII.—MECHANICAL ACTION a source of heat . . . . .	94
VIII.—Percussion . . . . .	94
IX.—Friction . . . . .	97
X.—Condensation, or Compression . . . . .	100
XI.—EFFECTS OF HEAT . . . . .	102
XI.—Expansion . . . . .	102
XII.—Same subject continued . . . . .	117
XIII.—Liquefaction . . . . .	121
Vaporization (clouds) . . . . .	121
XIV.—Evaporation . . . . .	147
XV.—COMMUNICATION OF HEAT . . . . .	155
XV.—Conduction . . . . .	155
XVI.—Absorption . . . . .	173
XVII.—Reflection . . . . .	179
XVIII.—Radiation (dew) . . . . .	182
XIX.—Convection (boiling) . . . . .	213

## PART II.—AIR.

---

	PAGE
XX.—THE ATMOSPHERE . . . . .	219
Gases. The Blood. Rust. Tarnish, &c.	
XXI.—CARBONIC ACID GAS . . . . .	238
Froth. Effervescence. Fermentation, &c.	
XXII.—CARBURETTED HYDROGEN GAS . . . . .	261
Fire-damp. Safety lamp, &c.	
XXIII.—PHOSPHURETTED HYDROGEN GAS . . . . .	265
Ignis Fatuus. Ghosts, &c.	
XXIV.—WIND . . . . .	268
XXV.—BAROMETER . . . . .	296
Ten Special Rules, &c.	
XXVI.—SNOW. HAIL. RAIN . . . . .	309
XXVII.—WATER . . . . .	319
XXVIII.—ICE . . . . .	325
Freezing mixtures. Frost. Swimming, &c.	
XXIX.—LIGHT . . . . .	338
Reflection. Telescopes. Refraction. Spectacles. Rainbows. Color.	
XXX.—SOUND . . . . .	377
Ear trumpets. Echoes, &c.	
<b>PART III.—MISCELLANEOUS.</b>	
Attraction. Anti-putrescents. Dreams. Color. Ink. Iron. Bread. Horn. India-rubber. Starch. Meat. Butter. Mirrors. Brieks. Milk. Steel. Manure. Soap, etc. . . . .	387
Antidotes to Poisons . . . . .	452
Glossary . . . . .	454
Index . . . . .	455
Index to Part III.—Miscellaneous Questions . . . . .	485

## PART I.

# HEAT.

### INTRODUCTION.

Q. *What is HEAT?*

A. The sensation of warmth.

Q. *How is this sensation produced?*

A. When we touch a substance hotter than ourselves, *a subtile invisible stream flows from the hotter substance, and produces on our nerves the "sensation of warmth."*

Q. *What is that "subtile invisible stream" CALLED, which flows from the hotter substance?*

A. CALO'RIC. *Caloric, therefore, is the agent, which produces the sensation of warmth; but HEAT is the sensation itself.*

Q. *What are the four principal SOURCES of heat?*

A. 1.—The Sun. 2.—Electricity. 3.—Chemical Action; and 4.—Mechanical Action.

Q. *What are the principal EFFECTS of heat?*

A. Expansion, Liquefaction, Vaporization, and Ignition.

---

## CHAPTER I.

### THE SUN.

Q. *What is the PRINCIPAL source of heat?*

A. The SUN.

Q. *Why do BURNING GLASSES set fire to substances submitted to their power?*

A. Because, when the rays of the Sun pass *through* the burning glass, they are bent toward *one point*, called the "focus;" in consequence of which, the light and heat at *this point* are very greatly increased.

Q. *Why is there a DARK RIM round this focus?*

A. Because the rays of light are bent *from the rim* into the *focus*; and, as the rim is *deprived of these rays*, it is darkened.

Q. *Are ALL the rays bent into one point?*

A. Not quite all: and, therefore, the rim round the focus is *not quite* black, but only dim.

## CHAPTER II.

## ELECTRICITY.

Q. *What is the SECOND chief source of heat?*

A. ELECTRICITY.

Q. *What is LIGHTNING?*

A. Lightning is *accumulated electricity discharged from the clouds.*

Like that from a "Leyden jar."

Q. *What CAUSES the discharge of an electric cloud?*

A. When a cloud, *overcharged* with electric fluid, approaches another which is *undercharged*, the fluid rushes from the former into the latter, till both contain the same quantity.

N. B. It is generally supposed that there are two different sorts of Electricity—one Vitreous, and the other Resinous.

Q. *Is there any OTHER cause of lightning, besides the one just mentioned?*

A. Yes; sometimes mountains, trees, and steeples, will discharge the lightning *from* a cloud floating near; and sometimes electric fluid rushes *out of the earth* into the clouds.

Q. *What produces ELECTRICITY in the CLOUDS?*

A. 1st—The *evaporation* from the earth's surface;

2dly—The *chemical changes*, which take place on the earth's surface; and

3dly—Currents of air of unequal temperature, which excite electricity by *friction*, as they pass by each other.

Q. *How HIGH are the LIGHTNING CLOUDS from the earth?*

A. Sometimes they are elevated 4 or 5 miles high; and sometimes actually *touch the earth* with one of their edges: but they are rarely *discharged* in a thunder storm, when they are more than 700 yards above the surface of the earth.

Q. *How high are the clouds GENERALLY?*

A. In a *fine day*, the clouds are often 4 or 5 miles above our heads; but the *average* height of the clouds is from  $1\frac{1}{2}$  to 2 miles.

Q. *Why is lightning sometimes FORKED?*

A. Because the lightning-cloud is a *long way off*; and the *resistance of the air* is so great, that the electrical current is diverted into a zig-zag course.

Q. *How does the resistance of the air make the lightning zig-zag?*

A. As the lightning *condenses* the air in the immediate advance of its path, it flies from side to side, in order to pass where there is the *least resistance*.



Q. *Why are there sometimes TWO flashes of forked lightning at the same moment?*

A. Because (in very severe storms) the flash will divide *into two or more parts*; each of which will assume the zig-zag form.

Q. *Why is the FLASH sometimes quite STRAIGHT?*

A. Because the lightning-cloud is *near the earth*; and, as the flash meets with very little resistance, it is *not diverted*; (in other words) the flash is straight.

Q. *What is SHEET LIGHTNING?*

A. Either the *reflection of distant flashes* not distinctly visible; or else several flashes intermingled.

Q. *What OTHER form does lightning occasionally assume?*

A. Sometimes the flash is *globular*; which is the most *dangerous* form of lightning.

Q. *What are those BALLS of FIRE, which sometimes fall to the earth in a thunder-storm?*

A. Masses of explosive gas, formed in the air: they generally move more slowly than lightning.

Q. *Why are BALLS of FIRE so very DANGEROUS?*

A. Because, when they fall, they

explode like a cannon ; and occasion much mischief.

Q. *Do these BALLS of FIRE ever run along the ground ?*

A. Yes ; sometimes they run a considerable way along the ground, and explode *in a mass* :

At other times they *split* into numerous *smaller balls*, each of which explodes in a similar manner.

Q. *What MISCHIEF will these balls of fire produce ?*

A. They will set houses and barns on fire ; and kill all cattle and human beings, which happen to be in their course.

Q. *Why does LIGHTNING sometimes KILL men and beasts ?*

A. Because (when the electric current passes through a man or beast) it produces so *violent an action upon the nerves*, that it destroys life.

Q. *WHEN is a person struck DEAD by lightning ?*

A. Only when his body forms a part of the *lightning's path* ; i. e. when the electric fluid (in its way to the earth) actually passes *through his body*.

Q. *Why are MEN sometimes MAIMED by lightning ?*

A. Because the electric fluid produces an *action upon the nerves sufficient to injure* them, but not to *destroy life*.

Q. *What is THUNDER?*

A. The noise made by the concussion of the air when it *closes* again, after it has been parted by the lightning flash.

A part of the noise is owing to certain *physical and chemical changes* produced in the air by the electric fluid.

Q. *Why does LIGHTNING part the air through which it passes? it does not part a rod of iron.*

A. As iron is a *conductor*, it allows the fluid to pass *freely over it*; but air (being a *non-conductor*) *resists* its passage.

Q. *Why is THUNDER sometimes ONE VAST CRASH?*

A. Because the lightning-cloud is *near the earth*; and as all the vibrations of the air (on which sound depends) reach the ear at *the same moment*, they seem like *one vast sound*.

Q. *Why is the PEAL sometimes an IRREGULAR, broken ROAR?*

A. Because the lightning-cloud is a long way off; and as *some* of the vibrations of the air have much further to travel than *others*, they reach the ear at *different times*, and produce a *continuous sound*.

Q. Which vibrations will be soonest heard?

A. Those produced in the *lowest* portions of the air.

Q. Why will those vibrations be heard FIRST, which are made LAST?

A. Because the flash (which produces the sound) is almost *instantaneous*, but sound takes a whole *second* of time to travel 380 yards.

Q. If a thunder-cloud were 1900 yards off, how long would the peal last?

A. *Five seconds*: we should *first* hear the vibrations produced in those portions of the air *contiguous to the earth*; then those *more remote*; and it would be 5 seconds before those vibrations reached us, which were made in the immediate *vicinity of the cloud*.

$$380 \times 5 = 1900.$$

A popular method of telling how far the storm is off is this—Immediately you see the flash, put your hand upon your pulse, and count how many times it beats before you hear the thunder: if it beats 6 pulsations, the storm is 1 mile off; if 12 pulsations, it is 2 miles off, and so on.

Q. Why is the THUNDER sometimes like a deep GROWL?

A. Because the storm is *far distant*, and the sound of the thunder indistinct.

Q. Is not the sound of thunder affected by LOCAL circumstances?

A. Yes; the *flatter* the country, the more unbroken the peal. *Mountain*

scenery *breaks* the peal, and makes it harsh and irregular.

Q. *What is the cause of ROLLING THUNDER?*

A. The vibrations of air (having *different lengths* to travel) reach the ear at *successive intervals*.

The reverberation (or echo) amongst the massive clouds contributes in some measure to this effect.

Q. *Why is a flash of lightning generally followed by POURING RAIN?*

A. The flash produces a change in the *physical condition of the air*, rendering it unable to hold so much water in solution as it could before; in consequence of which, a part is given off in heavy *rain*.

Q. *Why is a flash of lightning generally followed by a GUST OF WIND?*

A. Because the *physical condition of the air* is disturbed by the passage of the lightning, and wind is the result of this disturbance.

Q. *Why is there NO THUNDER to what is called SUMMER LIGHTNING?*

A. Because the lightning-clouds are *so far distant*, that the sound of the thunder is *lost*, before it reaches the ear.

Q. *Do THUNDER-BOLTS ever drop from the clouds?*

A. No; the notion of *thunder-bolts*

arises, either from the *globular* form which lightning sometimes assumes; or else from the gaseous *fire-balls*, which sometimes fall from the clouds.

See page 13.

Q. *Why is the THUNDER often several moments AFTER the FLASH?*

A. Because it has a long way to come. Lightning travels nearly *a million* times faster than thunder; if, therefore, the thunder has *a long way to come*, it will not reach the earth, till a considerable time *after the flash*.

Q. *Can we not tell the DISTANCE of a thunder-cloud, by observing the interval which elapses between the flash and the peal?*

A. Yes; the flash is *instantaneous*,\* out thunder will take a whole *second of time* to travel 380 yards: hence, if the flash be 5 seconds before the thunder, the cloud is 1900 yards off. (*See note, p. 16.*)

i. e.  $380 \times 5 = 1900$  yards.

Q. *What PLACES are most DANGEROUS during a STORM?*

A. It is very dangerous to be near a tree, or lofty building; and also to be near a river, or any running water.

---

\* The speed of lightning is so great, that it would go 480 times round the earth in one minute: whereas thunder would go scarcely 13 miles in the same space of time.

Q. *Why is it DANGEROUS to be NEAR a TREE, or lofty building, during a thunder-storm?*

A. Because a tall pointed object (like a tree or spire) will frequently *discharge* a lightning-cloud; and if any one were standing near, the lightning might diverge from the tree, and pass through the fluids of the human body.

Q. *How can a TREE or SPIRE DISCHARGE a lightning-cloud?*

A. A lightning-cloud (floating over a *plain*) may be *too far off* to be discharged by it; but, as a tree or spire would *shorten* this distance, it might no longer be *too far off* to be discharged.

For example. If a lightning-cloud were 700 yards above the earth, it would be *too far off* to be discharged: but a tree or spire 50 yards high would make the cloud only 650 yards off a conductor; in consequence of which, the cloud would be instantly *discharged*.

Q. *Is not AIR a CONDUCTOR of lightning?*

A. No; dry air is *not* a conductor of lightning.

Q. *Why would lightning fly from a tree or spire, into a MAN standing near?*

A. Because the electric fluid (called lightning) always chooses for its path the *best conductors*; and, if the human fluids proved the better conductor, would pass through the man standing near the tree rather than down the tree itself.

There would be no danger if the tree or spire were made of *metal*; because metal is a better conductor than the human fluids.

Q. *Does lightning go through the inside, or down the OUTSIDE of a tree?*

A. It runs down the *outside* of a *tree*; but passes through the *inside* of a *man*.

Q. *Why does lightning pass down the OUTSIDE of a tree?*

A. Because it always makes choice of the *best conductors*; and the *outside* of a tree is a better conductor than the *inside*.

Q. *Why does lightning pass through the INSIDE of a man?*

A. Because the *fluids* of the human body make a better conductor than the *skin*; therefore, lightning passes *through* a man, and not down his skin.

Q. *Why is it DANGEROUS to be near a deep RIVER, or any other running water, during a thunder-storm?*

A. Because running water is a good conductor; and lightning always takes in its course the *best conductors*.

Q. *Why is it dangerous for a man to be NEAR WATER in a thunder-storm?*

A. Because the *height of a man* may be sufficient to discharge a cloud: and (if there were no *taller* object nigh) the



lightning might make the *man* its conductor to the water.

See note on p. 19.

Q. *Why is it DANGEROUS to RING CHURCH BELLS during a thunder-storm?*

A. For two reasons: 1st—Because the steeple may *discharge* the lightning-cloud, merely from its *height*; and  
2dly—As the swinging of the bells puts the *air in motion*, it diminishes its *resistance* to the electric fluid.

Q. *Why is it unsafe to RUN or DRIVE FAST during a thunder-storm?*

A. Because it produces a *current of air*; and, as air in motion affords *less resistance* to the flash, it is a better conductor than *air in a state of rest*.

Q. *What PARTS of a DWELLING are most DANGEROUS during a thunder-storm?*

A. The fire-place, especially if the fire be *lighted*; the attics and cellar. It is also imprudent to sit close by the walls, to ring the bell, or to bar the shutters, during a thunder-storm.

Q. *Why is it DANGEROUS to sit BEFORE A FIRE during a thunder-storm?*

A. Because the heated air and soot are *conductors* of lightning; especially when connected with such excellent

conductors as the stove, fender and fire-irons.

Q. *Why are ATTICS and CELLARS more DANGEROUS in a thunder-storm, than the middle story of a house?*

A. Because lightning sometimes passes *from the clouds* to the earth, and sometimes *from the earth* to the clouds; in either cases the *middle story* would be the safer place.

Q. *When does lightning pass FROM THE EARTH to the CLOUDS?*

A. When the clouds are in a "negative" state of electricity.

Q. *When does lightning pass FROM THE CLOUDS to the EARTH?*

A. When the clouds are in a "positive" state of electricity.

Q. *What is meant by the clouds being in a "positive state of electricity?"*

A. When the clouds contain *more* electric fluid than they *generally* do, they are said to be in a "*positive* state of electricity."

Q. *What is meant by the clouds being in a "negative state of electricity?"*

A. When the clouds contain *less* electric fluid than they ought to do, they are said to be in a "*negative* state of electricity."

Q. Does the flash proceed from a negative or POSITIVE body?

A. Always from a positive body; that is, from one over-charged with electric fluid.

It is generally thought that there are two sorts of electricity, one called VITREOUS, corresponding to positive electricity; and the other called RESINOUS, corresponding to negative electricity.

Q. When lightning flashes from the earth to the clouds, what is the flash called?

A. It is popularly called the "returning stroke;" because the earth (being over-charged with electric fluid) returns the surplus quantity to the clouds.

Q. Why is it DANGEROUS to lean AGAINST A WALL during a thunder-storm?

A. Because the electric fluid will sometimes run down a wall; and (as a man is a better conductor than a wall) would leave the wall, and run down the man.

Q. Why is it dangerous to RING a BELL during a thunder-storm?

A. Bell-wire is an excellent conductor; and (if a person were to touch the bell-handle) the electric fluid, passing down the wire, might run through his hand and injure it.

Q. Why would the lightning run through a man touching a bell-handle?

A. Because the human body is a better conductor than the *wall* (between the bell-handle and the floor); and as lightning always chooses the *best* conductor for its path, it would (in this case) pass through the *man*, and injure him.

Q. *Why is it DANGEROUS to BAR a SHUTTER during a thunder-storm?*

A. Because the iron shutter-bar is an *excellent conductor*; and the electric fluid might run from the bar *through the person touching it*, and injure him.

Q. *Why is it dangerous to be in a CROWD during a thunder-storm?*

A. For two reasons: 1st—Because a *mass* of people forms a *better conductor* than an individual; and

2dly—Because the *vapor* arising from a crowd *increases* its conducting power.

Q. *Why is a MASS of bodies a better conductor than a single body?*

A. *Each* living body is a *conductor of electricity*; and a connected *mass* of such conductors is more likely to be struck, than a *single individual*.

Q. *Why is the danger increased by the VAPOR which rises from a crowd?*

A. Because *vapor* is a conductor; and the more *conductors* there are, the greater the danger will be.

Q. *Why is a THEATRE dangerous during a thunder-storm?*

A. Because the *crowd*, and *great vapor* arising from so many living bodies, render it an *excellent conductor of lightning*.

Q. *Why is a FLOCK of sheep in greater danger than a smaller number?*

A. 1st—Because *each* sheep is a *conductor* of lightning, and the conducting power of the *flock* is increased by its *numbers*: and

2dly—The very *vapor* arising from a flock of sheep *increases its conducting power*, and its danger.

Q. *Why is a HERD of cattle in danger during a storm?*

A. 1st—Because the *number* of living bodies increases the conducting power of their *animal fluids*: and

2dly—The very *vapor* arising from a herd increases its conducting power.

Q. *If a person be ABROAD in a thunder-storm, what place is the SAFEST?*

A. Any place about 20 or 30 feet from some tall tree or building; except it be near to running water.

Q. *Why would it be safe to stand 20 or 30 feet from some tall tree, in a thunder-storm?*

A. Because the lightning would al-

ways choose the *tall tree* as a conductor; and we should not be sufficiently *near* the tree, for the lightning to diverge from it to us.

Q. *If a person be in a CARRIAGE in a thunder-storm, in what way can he travel most SAFELY?*

A. He should not lean *against* the carriage; but sit upright, without touching any of the four sides.

Q. *Why should not a person lean AGAINST the carriage in a storm?*

A. Because the electric fluid might run down the sides of the carriage; and (if a person were leaning against them) would make choice of *him* for a conductor, and perhaps destroy life.

Q. *If a person be in a HOUSE during a thunder-storm, what place is SAFEST?*

A. Any room in the *middle story*. The middle of the room is best; especially if you place yourself on a mattress, bed, or hearth-rug.

Q. *Why is the MIDDLE STORY of a house SAFEST in a thunder-storm?*

A. Because the fluid (if it struck the house at all) would be diffused among the several conductors of the *upper* part of the house, before it reached the *middle* story; in consequence of which, its force would be weakened.

Q. *Why is the MIDDLE of the ROOM more SAFE than any other part of it, in a thunder-storm?*

A. Because the lightning (if it struck the room at all) would come down the chimney, or walls of the room; and, therefore, the further distant from these, the better.

Q. *Why is a MATTRESS, BED, or HEARTH-RUG a good security against injury from lightning?*

A. Because they are all non-conductors; and, as lightning always makes choice of the *best* conductors, it would not choose for its path such things as these.

Q. *Is it better to be WET or dry during a storm?*

A. To be *wet*: if a person be in the open field, the best thing he can do, is to stand about 20 feet from some tree, and get *completely drenched to the skin*.

Q. *Why is it better to be WET than dry?*

A. Because *wet clothes* form a *better conductor* than the *fluids of our body*; and, therefore, lightning would pass down our wet clothes, *without touching our body at all*.

Q. *What is the SAFEST thing a person can do, to avoid injury from lightning?*

A. He should draw his bedstead into the middle of the room, commit

himself to the care of God, and go to bed; remembering that our Lord has said, "The very hairs of your head are all numbered."

N. B. No great danger needs really to be apprehended from lightning, if you avoid taking your position near tall trees, spires, or other elevated objects.

Q. *What is a LIGHTNING-CONDUCTOR?*

A. A metal rod fixed in the earth, running up the whole height of a building, and rising in a point above it.

Q. *What metal is the best for this purpose?*

A. Copper makes the best conductor.

Q. *Why is COPPER better than iron?*

A. 1st—Because copper is a better conductor than iron:

2dly—It is not so easily fused or melted: and

3dly—It is not so much injured by weather.

Q. *What is the USE of a lightning-conductor?*

A. As metal is a most excellent conductor, lightning (which makes choice of the *best conductors*) will run down a *metal rod*, rather than the walls of the building.

Q. *How FAR will the beneficial influence of a lightning-conductor extend?*

A. It will protect a space all round,



4 times the length of that part of the rod which *rises above the building*.

Q. *Give me an example.*

A. If the rod rise 2 feet above the house, it will protect the building for (at least) 8 feet all round.

Q. *Why are not lightning-conductors more generally used?*

A. Because many accidents have arisen from conductors of defective construction.

Q. *How can lightning-conductors be productive of HARM?*

A. If the rod be *broken* by weather or accident, the electric fluid (being obstructed in its path) will damage the building.

Q. *Is there any other evil to be apprehended from a lightning-rod?*

A. Yes; if the rod be not big enough to conduct the *whole* current to the earth, the lightning will *fuse* the metal, and injure the building.

The conducting rod should be (at least) *one inch* in diameter.

Q. *How does LIGHTNING sometimes KNOCK DOWN HOUSES and churches?*

A. The steeple or chimney is first struck; the lightning then darts to the iron bars and cramps, employed in the

building ; and (as it darts from bar to bar) shatters to atoms the bricks and stones which oppose its progress.

Q. *Can you tell me how St. Bride's Church (London) was nearly destroyed by lightning, about 100 years ago ?*

A. The lightning first struck the metal vane, and ran down the rod ; it then darted to the iron cramps, employed to support the building ; and (as it flew from bar to bar) smashed the stones of the church which lay between.

Q. *Why did the lightning fly about from place to place, and not pass down in a straight course ?*

A. Because it always takes in its course the *best conductors* ; and will fly both right and left, in order to reach them.

Q. *Why does LIGHTNING turn milk SOUR ?*

A. Lightning causes the gases of the air (through which it passes) to *combine*, and thus produces a poison, called *nitric acid* ; some small portion of which, mixing with the milk, turns it sour.\*

---

\* The air is composed of two gases, called oxygen and nitrogen, *mixed* together, but *not combined*. Oxygen *combined* with nitrogen, produces five deadly poisons, viz.—nitrous oxide, nitric oxide, hyponitrous acid, nitrous acid, and nitric acid, according to the proportion of each gas in the combination.

N. B. Sometimes the mere *heat* of the air, during the storm, turns milk sour.

Q. *What is the difference between COMBINING and MIXING?*

A. When different ingredients are mingled together *without undergoing any chemical change*, they are said to be *mixed*; but when the natural properties of each are *altered by the union*, then those ingredients are said to be *combined*.

Q. *Give me an example.*

A. Different colored sands (shaken together in a bottle) will *mix* together, but not combine: but water poured on quicklime, will *combine* with the lime, and not mix with it.

Q. *Why are different grains of sand said to be MIXED, when they are shaken together?*

A. Because (though mingled together) the property of each grain remains the *same as it was before*.

Q. *Why is water, poured on lime, said to COMBINE with it?*

A. Because the properties of each are *altered* by the mixture; the lime alters the character of the water, and the water that of the lime.

Q. *Do oxygen and nitrogen COMBINE, or only MIX together, in common atmospheric air?*

A. They only *mix* together, as grains

of sand would do when shaken in a bottle. When oxygen and nitrogen combine, they do not constitute *air*, but acid poisons. (See note on p. 30.)

Q. Why does LIGHTNING turn BEER SOUR, although contained in a close cask?

A. Because, if beer be *new* and the process of fermentation incomplete, lightning will so *accelerate* the process, as to turn the sugar into *acetic acid* at once, without passing through the intermediate state of *alcohol*.

Q. Why is NOT OLD beer and strong PORTER made SOUR by lightning?

A. Because the *fermentation is more complete*; and, therefore, is less affected by electrical influence.

Q. Why is METAL sometimes FUSED by lightning?

A. Because the dimension of the metal is *too small* to afford a path for the electric current.

Q. Why does LIGHTNING PURIFY the AIR?

A. For two reasons: 1st—Because the electric fluid produces “nitric acid” in its passage through the air:

2dly—Because the agitation of the storm *stirs up the air*.

The "nitric acid" is produced by the *combination* of some portions of the oxygen and nitrogen of the air.\*

Q. *How does the production of nitric acid PURIFY the air?*

A. Nitric acid acts very powerfully in *destroying the exhalations*, which arise from putrid vegetable and animal matters.

Q. *Why is LIGHTNING more common in SUMMER and in AUTUMN, than in spring and winter?*

A. Because the heat of summer and autumn produces *great evaporation*; and the conversion of *water into vapor* always develops *electricity*.

Q. *Why does a THUNDER-STORM generally follow very dry weather?*

A. Because *dry air* (being a non-conductor) will not relieve the clouds of their electricity; so the fluid accumulates, till the clouds are discharged in a storm.

Q. *Why does a THUNDER-STORM rarely succeed WET weather?*

A. Because moist air or falling rain (being a conductor) carries down the electric fluid gradually and silently to the earth.

Q. *What is the general DIRECTION of a THUNDER-STORM?*

\* The oxygen and nitrogen are not *combined*, but simply *mixed*, in the ordinary air; but lightning causes some portions of the mixed elements to *combine*. See note, p. 30.

A. Either from east to west ; or from north to south.

Q. *Why is ELECTRICITY excited by FRICTION ?*

A. Electricity, like heat, exists in *all* matter ; but is often in a *latent state* : friction *disturbs* it, and brings it into active operation.

“ Latent,” see p. 37.

Q. *Why is a TREE sometimes SCORCHED by lightning, as if it had been set on fire ?*

A. Lightning scorches by its own *positive heat*, just the same as fire would.

Q. *Why is the BARK of a TREE often ripped quite off by a flash of lightning ?*

A. Because the latent heat of the tree (being very rapidly developed by the electric fluid) forces away the bark in its impetuosity to escape.

Some part of this is probably due to the simple *mechanical force* of the lightning.

Q. *Why are BOUGHS of TREES broken off by lightning ?*

A. Because the *mechanical force* of lightning is very great ; and, as the boughs of a tree are imperfect conductors, they will often be broken off by this force.

Q. *Why is an electric shock felt MOST at the ELBOW JOINT ?*

A. Because the path of the fluid is

*obstructed by the joint ; and the shock (felt at the elbow) is caused by the fluid leaping from one bone to another.*

Q. *Is electricity accompanied with any odor ?*

A. Yes ; near a large electrical machine in good action, there is always a peculiar odor, resembling *sulphur* and *phosphorus* ; this odor is called " OZONE."

Pronounce o-ZONE, in two syllables.

Q. *Has this peculiar odor, called " OZONE," been observed in thunder-storms ?*

A. Yes ; sometimes the *sulphurous* odor prevails, and sometimes the *phosphoric*.

If the gaseous body disengaged by lightning, reaches us in a *concentrated* form, the odor is *SULPHUROUS* ; if in a *diluted* form, it is *PHOSPHORIC*.

Q. *What are FUL'GURITES ?*

A. Hollow tubes produced in sandy soils by the action of lightning.

Q. *How does lightning produce fulgurites ?*

A. When it enters the earth, it fuses the flinty matter of the soil into a vitreous (or glassy) substance, called a fulgurite.

Q. *Does not lightning sometimes affect the character of IRON and STEEL ?*

A. Yes ; bars of iron and steel are sometimes rendered *magnetic* by lightning.

Q. *Give me an instance of the magnetic effects of lightning.*

A. Sometimes it will *reverse* the magnetic needles of the electric telegraph, and sometimes *destroy* their magnetism altogether.

Q. *What is meant by the magnetic needles being REVERSED?*

A. That part of the needle which ought to point toward the *north*, is made to point toward the *south*; and that part which ought to point south, is made to point toward the north.

Q. *How does lightning act upon the magnetic needles of the electric telegraph?*

A. The electric fluid is conveyed along the *conducting wires* to the telegraphic needles.

---

## CHEMICAL ACTION.

### CHAPTER III.

Q. *What is the THIRD chief source of heat?*

A. CHEMICAL ACTION.

Q. *What is meant by chemical action being the source of heat?*

A. Many things, when their chemical constitution is changed (either by the



abstraction of some of their gases, or by the combination of others not before united) evolve *heat*, while the change is going on.

Q. *Explain by illustration what you mean.*

A. Water is cold, and sulphuric acid is cold; but if these two *cold* liquids be mixed together, they will produce *intense heat*.

Q. *Why does COLD WATER, poured on LIME, make it intensely HOT?*

A. Because heat is evolved by the *chemical action* which takes place, when the cold water combines with the lime.

N. B. Heat is always *evolved*, when a fluid is converted into a *solid* form. Heat is always *absorbed*, when a solid is changed into a *liquid* state. As the water is changed from its liquid form when it is taken up by the lime, therefore, heat is given off.

Q. *Where does the heat come from?*

A. It was in the water and lime before; but was in a *latent state*.

Q. *Was there heat in the cold water and lime, before they were mixed together?*

A. Yes. *All* bodies contain heat; the coldest ice, as well as the hottest fire.

Q. *Is there HEAT even in ICE?*

A. Yes; but it is *latent* (i. e., not perceptible to our senses.)

Latent, from the Latin word *Lateo*, (to lie hid.)

Q. *How do you KNOW there is heat, if you cannot PERCEIVE it?*

A. Thus:—Ice is  $32^{\circ}$  by the thermometer; but if ice be melted over a fire, (though  $140^{\circ}$  of heat are absorbed by the process,) it will feel no *hotter* than before.

i. e., it will be only  $32^{\circ}$ , and not  $172^{\circ}$ .\*

Q. *What becomes of the  $140^{\circ}$  which went into the ice to melt it?*

A. It is hidden in the water; or (to speak more scientifically) it is stored up in a *latent state*.

Q. *How MUCH heat may be thus secreted or made latent?*

A. *All* things contain a vast quantity of latent heat; but as much as  $1140^{\circ}$  of heat may remain latent in *water*.

Q. *How can  $1140^{\circ}$  of heat be added to water, without being perceptible to our feelings?*

A. 1st— $140^{\circ}$  of heat are hidden in water, when *ice is melted* by the sun or fire.

2dly— $1000^{\circ}$  more of heat are secreted, when water is converted into *steam*. Thus, before *ice* is converted into steam,  $1140^{\circ}$  of heat become *latent*.

One pint of boiling water, ( $212^{\circ}$  according to the thermometer,) will make 1800 pints of steam; but the steam is no hotter to the touch than boiling water—both are  $212^{\circ}$ ; therefore, when water is converted into steam,  $1000^{\circ}$

---

\*  $32^{\circ}$ , i. e., 32 degrees;  $140^{\circ}$ , i. e., 140 degrees, &c.

of heat become latent. Hence, before ice is converted into steam, it must contain  $1140^{\circ}$  of latent heat.

Q. *Can we be made to FEEL the heat of ICE or snow?*

A. Yes. Into a pint of snow put half as much *salt*; then plunge your hands into the liquid; and it will feel so intensely cold, that the snow itself will seem *warm* in comparison to it.

Q. *Is SALT and SNOW really COLDER than snow?*

A. Yes, many degrees; and by dipping your hand into the mixture *first*, and into snow *afterward*, the snow will seem to be comparatively warm.

---

## CHAPTER IV.

### COMBUSTION.

Q. *What is FIRE?*

A. Heat and light, produced by the combustion of inflammable substances.

Q. *How is HEAT evolved by combustion?*

A. By *chemical action*. As latent heat is liberated, when water is poured upon lime, by chemical action; so latent heat is liberated in *combustion*, by chemical action also.

Q. *What* CHEMICAL ACTION *takes place in combustion?*

A. The *elements of the fuel* combine with the *oxygen of the air*.

Q. *What is meant by the* "ELEMENTS OF FUEL?"

A. As bread is a compound of flour, yeast, and salt; so fuel is a compound of hydrogen and carbon.

Q. *What are the* ELEMENTS *of atmospheric AIR?*

A. Oxygen and nitrogen, *mixed together* in the following proportions; 4 gallons of nitrogen and one of oxygen will make 5 gallons of common air.

Q. *What is* CARBON?

A. The solid part of fuel. Carbon abounds in all animal bodies, earths, and even in some minerals.

Q. *Mention some different species of* CARBON.

A. Common charcoal, lamp-black, coke, and the diamond.

Q. *What is* HYDROGEN?

A. An inflammable gas. The gas used in our streets is hydrogen *driven out of coals by heat*.

Coal gas (more correctly speaking) is carburetted hydrogen, i. e., carbon and hydrogen. See p. 262.

Q. *What are the peculiar characteristics of hydrogen gas?*

A. 1st—It is the *lightest* of all known substances:

2dly—It will burn immediately it is ignited: and

3dly—A lighted candle (immersed in this gas) will be instantly extinguished.\*

Q. *What is OXYGEN?*

A. A gas, much heavier than hydrogen; it gives brilliancy to flame, and is essential to animal life.†

\* Hydrogen gas may be made thus:—Put some pieces of zinc or iron filings into a glass: pour over them a little sulphuric acid (vitriol) diluted with twice the quantity of water; then cover the glass over for a few minutes, and hydrogen gas will be given off.

#### EXPERIMENTS.

If a flame be put into the glass, an EXPLOSION will be made.

If the experiment be tried in a phial, which has a piece of tobacco-pipe run through the cork, and a light held a few moments to the top of a pipe, a FLAME will be made.

If a balloon be held over the phial, (so that the gas can inflate it,) the balloon will ascend in a very few minutes.

† Oxygen gas is much more troublesome to make than hydrogen. The *cheapest* plan is to put a few ounces of manganese (called the black oxide of manganese) into an iron bottle, furnished with a bent tube; set the bottle on a fire till it becomes red hot, and put the end of the tube into a pan of water. In a few minutes, bubbles will rise through the water; these bubbles are oxygen gas.

These bubbles may be collected thus:—Fill a common bottle with water; hold it inverted over the bubbles which rise through the pan, but be sure the mouth of the bottle be held *in the water*. As the bubbles rise into the bottle, the water will run out; and when all the water has run out, the bottle is full of gas. Cork the bottle while the *mouth remains under water*; set the bottle on its base; cover the cork with lard or wax, and the gas will keep till it be wanted.

N. B. The *quickest* way of making oxygen gas, is to rub together in a mortar half an ounce of oxide of copper

Q. *What is* NITROGEN ?

A. An invisible gas, which abounds in animal and vegetable substances. The following are its peculiar characteristics :

1. It will not burn ;
2. An animal cannot live in it ;
3. It is the principal ingredient in common air.\*

Nearly 4 gallons out of every 5 being nitrogen gas.

---

and half an ounce of chlorate of potassa. Put the mixture into a common oil flask, furnished with a cork which has a bent tube thrust through it. Heat the bottom of the flask over a candle or lamp; and when the mixture is red hot, oxygen gas will be given off. Note—the tube must be immersed in a pan of water, and the gas collected as before.

(Chloride of potassa may be bought at any chemist's; and oxide of copper may be procured by heating a sheet of copper red hot, and when cool, striking it with a hammer; the scales that peel off, are oxide of copper.)

EXP. Put a piece of red hot charcoal (fixed to a bit of wire) into your bottle of oxygen gas; and it will throw out most dazzling sparks of light.

Blow a candle out; and while the wick is still red, hold the candle (by a piece of wire) in the bottle of oxygen gas; the wick will instantly ignite, and burn brilliantly.

(Burning sulphur emits a *blue* flame, when immersed in oxygen gas.)

\* Nitrogen gas may easily be obtained thus:—Put a piece of burning phosphorus on a little stand, in a plate of water; and cover a bell glass over it. (Be sure the edge of the glass stands *in the water*.) In a few minutes the *oxygen* of the air will be taken up by the burning phosphorus; and nitrogen alone will be left in the bell glass.

(N. B. The white fume, which will arise and be absorbed by the water in this experiment, is phosphoric acid; i. e. phosphorus combined with oxygen of the air.)

Q. *Why is there so MUCH nitrogen in the air?*

A. In order to *dilute* the oxygen. If the oxygen were not thus diluted, fires would burn out too quickly, and life would be too rapidly exhausted.

Q. *What three elements are necessary to produce COMBUSTION?*

A. Hydrogen gas, carbon, and oxygen gas: The two former in the *fuel*; and the last in the *air*, which surrounds the fuel.

Q. *What causes the combustion of the fuel?*

A. The hydrogen gas of the fuel (being set free, and excited by a match), *unites* with the *oxygen of the air*, and makes a yellow flame; this flame heats the *carbon of the fuel*, which (also uniting with oxygen of the air) produces *carbonic acid gas*.

Q. *What is CARBONIC ACID GAS?*

A. Only carbon (or charcoal) combined with oxygen gas.

Q. *Why does FIRE produce HEAT?*

A. Because it liberates *latent heat* from the air and fuel.

Q. *What CHEMICAL CHANGES in air and fuel are produced by COMBUSTION?*

A. 1st—Some of the oxygen of the air, combining with the *hydrogen* of the fuel, condenses into *water*: and

2dly—Some of the oxygen of the air combining with the *carbon* of the fuel, forms *carbonic acid gas*.

Q. *Why is a FIRE (after it has been long burning) RED HOT?*

A. Because the whole surface of the coals is so thoroughly heated, that every part of it is undergoing a rapid union with the oxygen of the air.

Q. *In a BLAZING fire, why is the UPPER surface of the COALS BLACK, and the LOWER surface RED?*

A. Because carbon (being solid) requires a great degree of heat to make it unite with the oxygen of the air. In consequence of which, the hot *under* surface of coals is frequently *red* from its union with oxygen, while the cold *upper* surface remains *black*.

Q. *Which burns the more quickly, a BLAZING fire, or a RED HOT one?*

A. Fuel burns quickest in a *blazing* fire.

Q. *Why do BLAZING COALS BURN QUICKER than red hot ones?*

A. Because the inflammable *gases* of the fuel (which are then *escaping*) greatly assist the process of combustion.

Q. *Why do the coals of a CLEAR BRIGHT fire burn out more slowly than blazing coals?*

A. Because most of the *inflammable*



*gases*, and much of the *solid fuel*, have been consumed already; so that there is less food for combustion.

Q. *What is SMOKE?*

A. *Unconsumed* parts of fuel (principally carbon) separated from the solid mass, and carried up the chimney by currents of hot air.

Q. *Why is there MORE SMOKE when COALS are FRESH added, than when they are red hot?*

A. Because carbon (being solid) requires a great degree of heat to make it unite with oxygen, (or, in other words, to bring it into a state of perfect combustion:) when coals are fresh laid on, *more carbon is separated* than can be *reduced to combustion*, and the surplus flies off in smoke.

Q. *Why is there so LITTLE SMOKE with a RED HOT FIRE?*

A. Because the *entire surface* of the coals is in a *state of combustion*; and, as very little carbon remains unconsumed, there is but little smoke.

Q. *Why are there DARK and BRIGHT SPOTS in a CLEAR cinder FIRE?*

A. Because the *intensity* of the combustion is *greater in some parts* of the fire, than it is in *others*.

Q. *Why is the intensity of the combustion so UNEQUAL?*

A. Because the air flies to the fire in various and unequal currents.

Q. *Why do we see all sorts of GROTESQUE FIGURES in hot COALS?*

A. Because the *intensity* of combustion is *unequal*, (owing to the gusty manner in which the air flies to the fuel :) and the various shades of red, yellow, and white heat (mingling with the black of the unburnt coal), produce strange and fanciful resemblances.

Q. *Why does PAPER BURN more readily than wood?*

A. Because it is of a *more fragile texture*; and, therefore, its component parts are more easily heated.

Q. *Why does WOOD BURN more readily than coal?*

A. Because it is not so *solid*; and, therefore, its elemental parts are more easily separated, and made hot.

Q. *When a FIRE is LIGHTED, why is PAPER laid at the BOTTOM, against the grate?*

A. Because paper (in consequence of its fragile texture) very readily catches fire.

Q. *Why is WOOD laid on the top of the paper?*

A. Because wood (being more *substantial*) burns longer than paper; and,

therefore, affords a *longer contact of flame* to heat the coals.

Q. *Why would not paper do WITHOUT wood?*

A. Because paper burns out so *rapidly*, that it would not afford sufficient *contact of flame* to heat the coals to combustion.

Q. *Why will not wood do WITHOUT shavings, straw, or paper?*

A. Because wood is too *substantial* to be heated into combustion by the feeble flame issuing from a *match*.

Q. *Why would not the paper do as well, if placed on the TOP of the coals?*

A. Because every blaze *tends upward*; if, therefore, the paper were placed on the *top* of the coals its blaze would afford *no contact of flame* to the fuel lying *below*.

Q. *Why should COAL be placed ABOVE the wood?*

A. Because otherwise, the *flame* of the fuel would *not* rise *through the coal*, to heat it.

Q. *Why is a FIRE KINDLED at the LOWEST BAR of a grate?*

A. That the flame may *ascend through the fuel*, to heat it. If the fire were kindled from the *top*, the flame would *not come in contact* with the fuel placed below.

Q. *Why does COAL make such EXCELLENT FUEL?*

A. Because it contains a large amount of *carbon* and *hydrogen gas*, in a very compact and convenient form.

Q. *Why will CINDERS become RED HOT more quickly than COALS?*

A. Because they are sooner reduced to a state of combustion, as they are *more porous* and *less solid*.

Q. *Why will not IRON CINDERS burn?*

A. Because they contain *impurities*, which are not so ready to combine with oxygen, as *carbon* and *hydrogen* are.

Q. *Why are CINDERS lighter than COALS?*

A. Because they are full of little holes; from which vapor, gases, and other volatile parts, have been driven off by *previous combustion*.

Q. *Why will not STONES do for fuel as well as COALS?*

A. Because they contain no *hydrogen*, and little or no *carbon*.

Q. *Why will not WET KINDLING light a fire?*

A. 1st—Because the moisture of the wet kindling prevents the *oxygen of the air from getting to the fuel*; and

2dly—The heat of the fire is perpetually *drawn off*, by the conversion of *water into steam*.

Q. *Why does DRY wood burn BETTER than GREEN?*

A. 1st—Because none of its heat is *carried away* by the conversion of *water into steam*; and

2dly—The pores of dry wood (being *filled with air*) supply the fire with oxygen.

Q. *Why do TWO pieces of WOOD burn BETTER than ONE?*

A. 1st—Because they help to entangle the *heat of the passing smoke*, and *throw it on the fuel*; and

2dly—The air, impinging against the pieces of wood, is thrown upon the fire in a kind of *eddy* or draught.

Q. *Why does SALT CRACKLE, when thrown into a FIRE?*

A. Salt contains *water*; and the *crackling* of the salt is owing to the sudden *conversion of this water into steam*.

Q. *Why will not wood or paper burn if steeped in a solution of POTASH, phosphate of LIME, or AMMONIA (hartshorn)?*

A. Because any “*al’kali*” (such as potash) will *arrest the hydrogen* which escapes from the fuel, and prevent its *combination with the oxygen of air*.

Q. *What is an al’kali?*

A. The *con’verse* of an *acid*; as

*bitter* is the con'verse of *sweet*, or *insipid* the con'verse of *pungent*.

Q. Why does a JET of FLAME sometimes burst into the room THROUGH THE BARS OF A STOVE?

A. Because the iron bars conduct heat to the *interior of some lump of coal*; and its volatile gas (bursting through the weakest part) is kindled by the glowing coals over which it passes.

Q. Why is this JET sometimes of a GREENISH YELLOW color?

A. Either because some lump of coal lies *over the hot bars*; or else the coals below it are not *red hot*: in consequence of which, some of the gas *escapes unburnt*, and is of a greenish color.

Q. Why does the gas escape UNBURNT?

A. Because neither the *bars*, nor *coals* over which it passes, are *red hot*.

Q. Why does a BLUISH FLAME sometimes flicker on the surface of hot cinders?

A. Because the gas from the hot coals *at the bottom of the grate*, mixing with the *carbon of the coals above*, produces an inflammable gas (called carbonic oxide), which burns with a blue flame.

Q. Why is the FLAME of a good fire YELLOW?

A. Because both the hydrogen and carbon of the fuel are in a state of *perfect*

*combustion*. It is the *white heat of the carbon*, which gives the pale yellow tinge to the flaming hydrogen.

Q. *What is LIGHT?*

A. Rapid *undulations* of a fluid called *ether*, striking on the eye.

Q. *How does COMBUSTION make these undulations of LIGHT?*

A. The atoms of matter (set in motion by heat) *striking against* this ether, produce *undulations* in it; as a *stone* thrown into a stream, produces undulations in the *water*.

Q. *How can UNDULATIONS of ether produce LIGHT?*

A. As *sound* is produced by *undulations of air* striking on the *ear*; so *light* is produced by undulations of *ether* striking on the *eye*.

Q. *What is ETHER?*

A. A very subtle fluid, which pervades and surrounds *everything we see*.

N. B. This theory of LIGHT is not altogether satisfactory; but has been retained, as the most plausible hitherto projected.

Q. *Does HEAT ALWAYS produce LIGHT?*

A. No; the heat of a stack of hay, or reeking dunghill, though very *great*, is not sufficient to produce *light*.

Q. *Why is a YELLOW FLAME brighter than a RED HOT COAL?*

A. Because *yellow rays* produce the greatest amount of *light*, though *red rays* produce the greatest amount of *heat*.

Q. *Why is the LIGHT of a fire MORE INTENSE sometimes than it is at others?*

A. The *intensity* of fire-light depends upon the *whiteness* to which the carbon is reduced by combustion. If carbon be *white hot*, its *combustion is perfect*, and the light intense; if not, the light is obscured by *smoke*.

Q. *Why will not CINDERS BLAZE, as well as FRESH coals?*

A. The *flame* of coals is made chiefly by *hydrogen gas*. As soon as this gas has been consumed, the hot cinders produce only a gas, called carbonic acid, which is neither luminous nor visible.

Q. *Where does the hydrogen gas of a fire come from?*

A. All fuel is *composed* of carbon and hydrogen gas, which are separated from each other by the process of combustion. (See p. 40.)

Q. *Why does not a FIRE BLAZE on a FROSTY NIGHT, so long as it does upon another night?*

A. 1st—Because air *condensed* by the cold contains more *oxygen* than the same quantity of warmer air; and



2dly—Air condensed by the cold is *heavier*. In consequence of which, it falls more quickly on the fire, to supply the place of the hot ascending air.

Q. *Why does a FIRE burn CLEAREST on a FROSTY night?*

A. Because the volatile gases are more quickly consumed; and the solid carbon is *plentifully supplied with oxygen* from the air, to make it burn brightly and intensely.

Q. *Why does a FIRE burn more intensely in WINTER than in SUMMER?*

A. Because the air is *colder* in winter, than it is in summer.

Q. *Why does the COLDNESS of the air increase the HEAT of a fire?*

A. 1st—Because air condensed by the cold, supplies more *oxygen* than a similar volume of warmer air; and

2dly—Condensed air, being *heavy*, falls more rapidly into the place of the hot ascending air, to supply the fire with nourishment.

Q. *Why does the SUN, shining on a FIRE, make it DULL; and often put it out?*

A. 1st—Because the air (being rarefied by the sunshine) *flows more slowly to the fire*; and

2dly—Even that which *reaches* the fire, affords *less nourishment*.

Sunshine produces also some *chemical effect* upon the air or fuel detrimental to combustion.

Q. *Why does the air flow to the fire more TARDILY for being RAREFIED?*

A. Because the greater the *contrast* (between the *external air* and that *which has been heated by the fire*), the more *rapid* will be the current of air toward that fire.

Q. *Why does rarefied air afford LESS NOURISHMENT to fire than cold air?*

A. Because rarefied air contains less *oxygen* than the same quantity of condensed air.

Inasmuch as the same quantity of oxygen is diffused over a larger volume of air.

Q. *Why does a FIRE burn more fiercely in the OPEN AIR?*

A. 1st—Because the *air out-of-doors* is more *dense* than the air in-doors; and  
2dly—It has freer *access* to the fire.

Q. *Why is the air out-of-doors more DENSE than that in-doors?*

A. Because it has freer circulation; and, as soon as any portion has been *rarefied*, it instantly escapes, and is supplied by *colder currents*.

Q. *Why does not a FIRE burn so freely in a THAW as in a FROST?*

A. Because the air is laden with *vapor*; in consequence of which, it both *moves too slowly*, and is too much *rarefied* to nourish the fire.

Q. *Why does a FIRE burn so fiercely in WINDY weather?*

A. Because *the air is so rapidly changed*, and affords plentiful nourishment to the fire.

Q. *Why does a pair of BELLOWS get a fire up?*

A. Because it *drives the air more rapidly to the fire*; and the plentiful supply of oxygen soon makes the fire burn intensely.

Q. *Why is the flame of a CANDLE EXTINGUISHEE when blown by the breath; and not made more intense like a fire?*

A. Because the flame of a candle is confined to a *very small wick*, from which it is *severed* by the breath; and (being unsupported) *must go out*.

Q. *Why is a SMOULDERING WICK sometimes RE-KINDLED by blowing it?*

A. Because air is carried to it by the breath with *great rapidity*; and the oxygen of the air kindles the *red hot wick*, as it would kindle charred wood.

Q. *Why is not the red hot wick kindled by the air AROUND it, without BLOWING?*

A. Because oxygen is not supplied

with sufficient freedom, unless air be *blown* to the wick.

Q. *When is this experiment most likely to succeed?*

A. In *frosty* weather; because the air contains more oxygen when it is *condensed by the cold*.

Q. *Why does a POKER LAID ACROSS a dull FIRE revive it?*

A. For two reasons; 1st—Because the poker *concentrates the heat*, and therefore increases it; and

2dly—Air is arrested in the narrow aperture between the poker and the coals, and a *draught* created.

See p. 49.

Q. *Why are STOVES fixed on the FLOOR of a room?*

A. In order that the air *on the lower part of the room* may be heated by the fire.

Q. *Would not the air of the lower part of a room be heated equally well, if the stoves were fixed higher up?*

A. No; the heat of a fire has a very little effect upon the air *below the level of the grate*; and, therefore, every grate should be as *near to the floor* as possible.

Q. *Our FEET are very frequently COLD when we sit close by a good fire. Explain the reason of this.*

A. As the fire consumes the air which passes over it, *cold air* rushes through the crevices of the doors and windows *along the bottom of the room* to supply the deficiency; and these currents of cold air, *rushing constantly over our feet*, deprive them of their warmth.

Q. *If a piece of PAPER be laid FLAT on a clear fire, it will NOT BLAZE but CHAR. Why so?*

A. Because the carbon of a clear fire, being sufficiently hot to unite with the oxygen of the air, *produces carbonic acid gas*, which soon envelops the paper laid flat upon the cinders: but carbonic acid gas will not *blaze*.

Q. *If you BLOW the paper, it will BLAZE immediately. Why so?*

A. Because by blowing or opening a door suddenly, *the carbonic acid is dissipated*, and the paper fanned into flame.

Q. *Why does WATER EXTINGUISH a FIRE?*

A. 1st—Because the water *forms a coating* over the fuel, which keeps it from the air; and

2dly—The conversion of *water into steam*, draws off the *heat* of the burning fuel.

Q. *A LITTLE WATER makes a fire FIERCER, while a LARGER quantity of water puts it OUT. Explain how this is.*

A. Water is composed of *oxygen* and *hydrogen*; when, therefore, the fire can decompose the water into its simple elements, it serves for *fuel* to the flame.

Q. *How can WATER serve for FUEL to fire?*

A. Because the *hydrogen* of the water burns with a *flame*; and the *oxygen* of the water increases the *intensity* of that flame.

Q. *When a house is on fire, is too LITTLE water worse than NONE?*

A. Certainly. Unless water be supplied so plentifully as to *quench the fire*, it will increase its *intensity*, like fuel.

Q. *When will water EXTINGUISH FIRE?*

A. When the supply is so rapid and abundant that the fire cannot decompose it.

Q. *Does not a very LITTLE water SLACKEN the heat of fire?*

A. Yes, *till it is decomposed*; it then increases the *intensity* of fire, and acts like fuel.

Q. *Why does the WICK of a candle (when the flame has been blown out) very readily CATCH FIRE?*

A. Because the wick is already *hot*, and a very little *extra* heat will throw it into flame.

Q. *Why does the EXTRA heat revive the flame?*

A. Because it again liberates the *hydrogen* of the tallow, and ignites it.

Q. *Cannot* WOOD be made to BLAZE without actual contact with fire?

A. Yes; if a piece of wood be held near the fire for a little time, it will blaze, even though it does not *touch* the fire.

Q. *Why* will WOOD BLAZE, even if it does not touch the fire?

A. Because the heat of the fire drives out the *hydrogen gas* of the wood; which gas is inflamed by contact with the red hot coals.

Q. *Why* will a NEIGHBOR'S HOUSE sometimes CATCH FIRE, though no flame of the burning house ever touches it?

A. Because the heat of the burning house sets at liberty the *hydrogen gas* of the neighboring wood-work; and this gas is ignited by the flames or red hot bricks of the house or fire.

Q. *What* is COKE?

A. Coal freed from its volatile gases by the action of artificial heat.

Q. *Why* do STOVES sometimes SMELL very strongly of SULPHUR?

A. Because coal and coke contain sulphur; and whenever the draught is not rapid enough to drive the sulphur up the flue, it is emitted into the room.

Q. *What is meant by SPONTANEOUS COMBUSTION?*

A. Combustion produced without the application of *flame*.

Q. *Give an example of spontaneous combustion.*

A. Coals stowed in the hold of a vessel, and goods packed in a warehouse, will often catch fire of *themselves*—especially such goods as cotton, flax, hemp, rags, &c.

Q. *Why do such GOODS sometimes CATCH FIRE of themselves?*

A. Because they are piled together in very *large masses* in a *damp* state or place.

Q. *Why does this produce spontaneous combustion?*

A. The damp produces *decay*, or the decomposition of the goods; and the great heat of the piled-up mass makes the decaying goods *ferment*.

Q. *How does this FERMENTATION produce COMBUSTION?*

A. During fermentation, *carbonic acid gas* is given off by the goods—a slow combustion ensues—till at length the *whole pile* bursts into *flame*.

Q. *Why is the HEAT of a LARGE MASS of goods GREATER than that of a smaller quantity?*

A. Because the carbonic acid cannot



escape through the massive pile; and the products of decomposition being *confined*, hasten further changes.

Q. *Why do HAY-STACKS sometimes CATCH FIRE of themselves?*

A. Either because the hay was got up *damp*; or else because *rain* has penetrated the stack.

Q. *Why will a HAY-STACK CATCH FIRE if the hay be damp?*

A. Because damp hay soon *decays*, and undergoes a *state of fermentation*; during which, *carbonic acid gas* is given off, and the stack catches *fire*.

Q. *Roasted COFFEE sometimes CATCHES fire spontaneously. Explain the reason of this.*

A. The *heat* of coffee is greatly increased by being *roasted*; and the *carbon* of the coffee, uniting with the *oxygen* of the air, produces *carbonic acid gas*, and bursts into *flame*.

Q. *Why do old RAGS, used for CLEANING LAMPS and CANDLESTICKS, sometimes set a HOUSE on fire?*

A. Because they very readily *ferment*, and (during fermentation) throw off exceedingly inflammable gases.

N. B. Lamp-black mixed with linseed oil is more liable to spontaneous combustion than anything that servants handle.

## CHAPTER V.

## SMOKE.

Q. *Why does SMOKE ASCEND the chimney?*

A. Because the air of the room (when it passes over the fire) becomes lighter for being *heated*; and (being thus made *lighter*) ascends the chimney, carrying the smoke with it.

Q. *What is SMOKE?*

A. Small particles of carbon, separated by combustion from the fuel, but not *consumed*.

Q. *Why do SMOKE and steam CURL as they ascend?*

A. Because they are pushed round and round by the ascending and descending currents of air.

Q. *Why does a CLOSE STOVE DRAW up more fiercely than an OPEN GRATE?*

A. Because the air which supplies the stove must pass *through the fire*, and, as it becomes exceedingly *heated*, rushes up the flue with great violence.

Q. *What produces the ROARING noise made by the fire in a close stove?*

A. Air rushing rapidly through the crevices of the *iron door*, and up the *chimney flue*.

Q. *Why is the ROAR LESS if the stove DOOR be thrown OPEN?*

A. Because *fresh air* gets access to the fire *more easily*; and, as the air is not so intensely heated, its motion is not so *violent*.

Q. *Why do some CHIMNEYS SMOKE?*

A. Because fresh air is not admitted into a room so *fast as it is consumed by the fire*; in consequence of which, a current of air *rushes down the chimney* to supply the deficiency, driving the smoke along with it.

Q. *Explain this by an illustration.*

A. If water be taken with a pail out of a river, *other* water will rush toward the hole as soon as the pail is lifted out; and, if air be taken from a room (as it is, when some of it goes up the chimney), *other air* will rush toward the void to fill it up.

Q. *What prevents air being supplied so fast as it is consumed by the fire?*

A. Leather and curtains round the doors: sand-bags at the threshold and on the window-frames; and other contrivances to keep out the draught.

Q. *Why will the air come down the CHIMNEY?*

A. Because it can get into the room

in no *other* way, if the doors and windows are all made *air-tight*.

Q. *What is the best REMEDY in such a case?*

A. The *speediest* remedy is to open the door or window: but by far the *best* remedy is to carry a small tube from the hearth into the external air.

Q. *Why is that the BEST remedy?*

A. Because the fire will be plentifully supplied with air by the tube: the doors and windows may all remain *air-tight*; and we may enjoy a warm fire-side, without the inconvenience of draughts and cold feet.

Q. *Why is a CHIMNEY raised so high above the ROOF?*

A. That it may not smoke; as all funnels do which are too short.

Q. *What is meant by the FUNNEL or FLUE of a chimney?*

A. That part of a chimney through which *the smoke passes*.

Q. *Why does a CHIMNEY SMOKE, if the funnel be very short?*

A. Because the *draught* of a short flue is *too slack* to carry the smoke up the chimney.

Q. *Why is the DRAUGHT of a SHORT FLUE more SLACK than that of a long one?*

A. 1st—Because *the fire is always dull and sluggish*, if the chimney be too short :

2dly—Because the smoke rolls *out* of the chimney, before it has acquired its *full velocity* ; and

3dly—Because the wind, rain, and air, have more influence over a *short* funnel, than over a *long* one.

Q. *Why is the FIRE always DULL and SLUGGISH, if the CHIMNEY-FLUE be very SHORT?*

A. Because the draught is bad ; and, as the rarefied air *passes very tardily up the chimney*—*fresh air* flows as tardily toward the fire, to supply it with *oxygen*.

Q. *On what does the INTENSITY of fire depend?*

A. The *intensity* of fire is always in proportion to the *quantity of oxygen* with which it is supplied.

Q. *Why does not SMOKE acquire its full VELOCITY in a SHORT funnel?*

A. Because the *higher* smoke ascends, (provided the flue be clear and hot,) the *faster* it goes : if, therefore, a *funnel be very short*, the smoke never acquires its full velocity.

Q. *Does the DRAUGHT of a chimney depend on the SPEED of the SMOKE through the flue?*

A. Yes. The more quickly *hot air* flies up the chimney, the more quickly

*cold* air will rush *toward the fire* to supply the place; and, therefore, the *longer the flue*, the *greater the draught*.

Q. *Why are the CHIMNEYS of MANUFACTORIES made so very LONG?*

A. To increase the intensity of the fire.

Q. *Why is the INTENSITY of a fire increased by LENGTHENING the FLUE?*

A. Because the draught being greater, more fuel is consumed in the same time; and, of course, the intensity of the heat is proportionally greater.

Q. *If a SHORT CHIMNEY cannot be lengthened, what is the best REMEDY to prevent smoking?*

A. To contract the opening of the chimney contiguous to the stove.

Q. *Why will a SMALLER OPENING against the stove PREVENT the chimney's SMOKING?*

A. Because the air will be compelled to pass *nearer the fire*; and (being more *heated*) will rise through the chimney more rapidly. This *increase of heat* will therefore compensate for the *shortness of the flue*.

Q. *Why will a ROOM SMOKE if there be TWO FIRES in it?*

A. Because the *fiercer* fire will exhaust the most air, and draw from the *smaller* one, to supply its demand.

Q. *Why will a chimney SMOKE if there be a FIRE in TWO ROOMS communicating with each other?*

A. Because (whenever the *door* between the two rooms is *opened*) air will rush from the chimney of the *inferior* fire to supply the *other*; and *both* rooms will be filled with smoke.

Q. *What is the best REMEDY in this case?*

A. Let a tube be carried from the hearth of each stove into the external air; and then *each* fire will be so well supplied, that neither will need to borrow from the other.

Q. *Why does a HOUSE in a VALLEY or by the side of higher buildings very often SMOKE?*

A. Because the wind (striking against the surrounding hills or buildings) *bounds back again upon the chimney*, and destroys its draught.

Q. *What is the REMEDY in these cases?*

A. To fix a *cowl* on the chimney-top, to turn like a weather-cock, and present its back to the wind.

Q. *Why will not a COWL always PREVENT a chimney SMOKING?*

A. Because if the wind be *strong*, it will keep the *opening* of the cowl *toward the higher building or hill*; and then the reflected wind will blow *into the cowl*, and *down the chimney*.

Q. *As a cowl is such a poor remedy, can any OTHER be suggested?*

A. Yes. If the chimney-flue can be carried *higher* than the other buildings or hills, no wind can enter the flue.

Q. *If a chimney-flue be carried up HIGHER than the buildings or hill, why cannot the wind enter it?*

A. Because the reflected wind would strike against the *sides* of the chimney-flue, and not pass over the *opening* at all.

Q. *In what OTHER cases will a CHIMNEY SMOKE?*

A. If the door and stove are both placed on *the same side of a room*, the chimney will often smoke.

Q. *Why will a CHIMNEY SMOKE, if the DOOR and STOVE are both on the SAME SIDE?*

A. Because (whenever the door is opened) a current of air will *blow obliquely into the chimney-place*, and drive the smoke into the room.

Q. *What REMEDY can be applied to this evil?*

A. The door must be set *opposite* to the chimney-place, or nearly so; and then the draught from the door *will blow the smoke up the chimney*, and not into the room.

Q. *Why will a CHIMNEY SMOKE if it NEEDS SWEEPING?*

A. Because loose soot obstructs the



free passage of the smoke, *delays its current*, and prevents the draught.

Q. *Why will a CHIMNEY SMOKE if it be OUT OF REPAIR?*

A. 1st—Because the *loose mortar and bricks* obstruct the smoke; and

2dly—*Cold air* (oozing through the chinks) *chills the air in the chimney*, and prevents its ascent.

Q. *Why will a STOVE SMOKE, if the joints of the flue do not fit air-tight?*

A. Because *cold air* (oozing through the joints) *chills the air in the flue*, and prevents its ascent.

Q. *Why does an old-fashioned FARM CHIMNEY-PLACE generally smoke?*

A. Because the opening is so *very large*, that much of the air which goes up the chimney, *has never passed near the fire*; and this *cold air* (mixing with the hot) so *reduces its temperature* that it ascends very slowly, and the draught is destroyed.

Q. *Why does a chimney smoke if the DRAUGHT be SLACK?*

A. Because the current of air up the chimney is not powerful enough to *buoy up the smoke* through the flue.

Q. *If the opening of a chimney be TOO LARGE, what REMEDY can be applied?*

A. The chimney-place must be contracted.

Q. *Why will CONTRACTING the chimney-place PREVENT its SMOKING?*

A. Because the air will then pass *nearer the fire*; and (being *more heated*) fly faster up the chimney.

Q. *Why do almost all CHIMNEYS SMOKE in GUSTY weather?*

A. Because the column of smoke is suddenly chilled by the wind, and (being unable to ascend) rushes back into the room.

Q. *What is the use of a CHIMNEY-POT?*

A. It serves to increase the draught, when the opening of a chimney is too large.

Q. *How does a CHIMNEY-POT INCREASE the DRAUGHT of a chimney?*

A. As the *same quantity* of hot air has to escape through a *smaller opening*, it must pass through more quickly.

Q. *Why do BLOWERS help to get a fire up?*

A. Because they compel the air to go *through* the fire, and not *over* it; in consequence of which, the fire is well supplied with oxygen, and the draught greatly increased.

Q. *Why does a BLOWER INCREASE the DRAUGHT?*

A. Because the air (by passing *through* the fire) is made much hotter, and ascends the chimney more rapidly.

Q. *Why is a fire better supplied with oxygen while the blower hangs before it?*

A. Because the blower increases the draught; and the faster the *hot* air flies *up the chimney*, the faster will *cold* air rush *toward the fire*, to supply it with oxygen.

Q. *Why does a parlor often SMELL disagreeably of SOOT in SUMMER-TIME?*

A. Because the air in the *chimney* (being *colder* than the air in the *parlor*) *descends into the room*, and leaves a disagreeable smell of soot behind.

Q. *Why are the CEILINGS of PUBLIC OFFICES generally BLACK and filthy?*

A. Because the heated air of the office buoys up the dust and fine soot; which (being unable to escape through the plaster) is deposited on the ceiling.

Q. *Why are SOME parts of the ceiling BLACKER and more filthy than others?*

A. Because the air, being unable to penetrate the thick *joists* of the ceiling *passes by those parts*, and deposits its soot and dust on others more penetrable.

N. B. The site of this deposit of soot and dust is frequently determined by draughts and currents of air.

## CHEMICAL ACTION.

Q. *What is CHARCOAL?*

A. Wood which has been exposed to a red heat, till it has been deprived of all its gases and volatile parts.

Q. *Why is a CHARCOAL FIRE hotter than a wood fire?*

A. Because charcoal is very *pure* carbon; and, as it is the *carbon* of fuel which produces the glowing heat of combustion, therefore, the *purer* the carbon, the more intense will the heat of the fire be.

Q. *Why does charcoal REMOVE the TAIN T of meat?*

A. Because it absorbs all putrescent effluvia, whether they arise from animal or vegetable matter.

Q. *Why is WATER PURIFIED by being filtered through charcoal?*

A. Because charcoal absorbs the *impurities* of the water, and removes all disagreeable tastes and smells, whether they arise from animal or vegetable matter.

Q. *Why are water and wine CASKS CHARRED inside?*

A. Because *charring* the inside of a cask reduces it to a *kind of charcoal*; and charcoal (by absorbing animal and

vegetable impurities) keeps the liquor sweet and good.

Q. *Why does a piece of BURNT BREAD make impure WATER fit to drink?*

A. Because the surface of the bread (which has been reduced to *charcoal* by being burnt) absorbs *the impurities of the water*, and makes it palatable.

Q. *Why should TOAST and WATER, placed by the side of the sick, be made of BURNT BREAD?*

A. Because the charcoal surface of burnt bread prevents the water from being affected by the impurities of the sick room.

Q. *Why should sick persons eat DRY TOAST rather than bread and butter?*

A. Because the charcoal surface of the dry toast helps to absorb the acids and impurities of a sick stomach.

There are other reasons which belong to the science of medicine.

Q. *Why are TIMBERS which are to be exposed to damp CHARRED?*

A. Because *charcoal undergoes no change* by exposure to air and water; in consequence of which, timber will resist weather *much longer* after it has been charred.

## CHAPTER VI.

## LAMPS AND CANDLES.

Q. *Of what are OIL, TALLOW, and WAX composed?*

A. Principally of carbon and hydrogen gas. The *solid* part is carbon, the *volatile* part is hydrogen gas.

Q. *What is CARBON?*

A. A solid substance, generally of a black color; well known under the forms of charcoal, lamp-black, coke, &c.

Q. *What is HYDROGEN GAS?*

A. The principal ingredient of water. It burns so readily that it used to be called "inflammable air."\*

Common coal gas is a mixture of carbon and hydrogen, called "carburetted hydrogen." See p. 262.

Q. *A CANDLE BURNS when lighted. Explain how this is.*

A. The heat of the lighted wick decomposes the tallow into its elementary parts of carbon and hydrogen; and the hydrogen of the tallow, combining with the oxygen of the air, produces flame.

Q. *WHERE is the tallow or wax of a candle decomposed?*

A. In the wick. The melted tallow

---

\* To make hydrogen gas, see p. 41.

or wax, rises up the wick by capillary attraction, and is rapidly decomposed by the heat of the flame.

Q. *What is capillary attraction?*

A. The power which very minute tubes possess of causing a liquid to rise in them above its level.

“Capillary,” from the Latin word “capillaris” (*like a hair*); the tubes referred to are almost as fine and delicate as a hair.

Water ascends through a lump of sugar, or piece of sponge, by capillary attraction. N. B.—The smaller a tube, the higher will a liquid be attracted by it.

Q. *Why is the FLAME of a candle HOT?*

A. Because the flame liberates *latent heat* from the air and tallow.

Q. *How is LATENT HEAT liberated by the flame of a CANDLE?*

A. When the elements of the tallow combine with the *oxygen* of the air, latent heat is liberated by the chemical changes.

Q. *Why does the flame of a CANDLE produce LIGHT?*

A. Because the chemical changes made by combustion excite *undulations of ether*, which (striking the eye) produce light.

See p. 51.

Q. *Why is the flame of a CANDLE YELLOW?*

A. It is *not* so altogether; only the *outer* coat of the flame is yellow—the

*lower part is violet*; and the *inside of the flame hollow*.

Q. *Why is the outside of the flame YELLOW?*

A. Because the *carbon of the tallow* (being in a state of *perfect combustion*) is made white hot.

See p. 50.

Q. *Why is the BOTTOM part of the flame purple?*

A. Because it is *overladen with hydrogen*, raised from the tallow by the burning wick; and this gas (which burns with a *blue flame*) gives the dark tinge to the bottom of the candle-flame.

Q. *Why is the INSIDE of the flame HOLLOW?*

A. Because it is *filled with vapor*, raised from the candle by the *heat of the wick*, and not yet reduced to a state of combustion.

Q. *Describe the different parts of the FLAME of a common CANDLE.*

A. The flame consists of *three cones*. The innermost cone is hollow; the intermediate one of a dingy purple hue; and the outside cone is yellow.

Q. *Why is the intermediate cone of a flame PURPLE as well as the BOTTOM of the flame?*

A. Because the gases are not in a state of *perfect combustion*; but contain



an *excess of hydrogen*, which gives the flame a purple tinge.

Q. *Why is not the MIDDLE cone in a state of perfect combustion as well as the outer one?*

A. Because the outer cone *prevents the oxygen of the air* from getting to the middle of the flame; and without the free access of oxygen gas, there is no such thing as complete combustion.

Q. *Why does the FLAME of a candle point UPWARDS?*

A. Because it *heats the surrounding air*, which (being hot) *rapidly ascends*, driving the flame upwards at the same time.

Q. *Why is the FLAME of a candle POINTED at the top like a cone?*

A. Because the *upper part* of a flame is more *volatile* than the lower; and, as it affords *less resistance to the air*, is reduced to a mere point.

Q. *Why are the LOWER parts of a flame less VOLATILE than the upper?*

A. Because they are laden with unconsumed gas and watery vapor, which present considerable resistance to the air.

Q. *Why is the FLAME of a candle BLOWN OUT by a puff of breath?*

A. Because it is *severed from the wick*, and goes out for want of support.

Q. *Why does the FLAME of a candle make a GLASS (which is held over it) DAMP?*

A. Because a "watery vapor" is made by the combination of the *hydrogen of the tallow* with the *oxygen of the air*; and this "vapor" is condensed by the *cold glass* held above the flame.

Q. *Why does our hand, held ABOVE a candle, suffer more from heat than when it is placed BELOW the flame, or on ONE SIDE of it?*

A. Because the hot gases and air (in their ascent) *come in contact* with the hand placed *above* the flame; but when the hand is placed *below* the flame, or on *one side*, it only feels heat from *radiation*.

Radiation: i. e., emission of rays. The candle-flame throws out rays of light and heat in all directions; but when the hand is held *above* the flame, it not only feels the heat of the *rays*, but also of the ascending current of *hot air*, &c.

Q. *Why is a RUSH LIGHT extinguished more quickly than a cotton-wick candle?*

A. Because a hard rush imbibes the melted fat or wax much more slowly than porous cotton; as it imbibes less fat, it supplies a smaller volume of *combustible gases*; and, of course, the light is more easily extinguished.

Q. *Why is it more difficult to blow out a COTTON wick than a rush light?*

A. Because porous cotton imbibes

the melted fat, or wax, much more quickly than hard rush; as it imbibes more fat, it supplies the flame with a larger volume of *combustible gases*; and, of course, the light is with more difficulty extinguished.

Q. *Why is a GAS FLAME more easily extinguished when the jet is very slightly turned on, than when it is in full stream?*

A. Because there is less volume of combustible gases in the small flame than in the full blaze.

Q. *Why does an EXTINGUISHER put a candle out?*

A. Because the air in the extinguisher is soon exhausted of its oxygen by the flame: and when there is no oxygen, flame goes out.

Q. *Why does not a candle set fire to a PIECE of PAPER twisted into an extinguisher, and used as such?*

A. 1st—Because the flame very soon exhausts the oxygen contained in the paper extinguisher: and

2dly — The flame invests the *inside of the paper extinguisher* with carbonic acid gas, which prevents it from blazing.

Q. *Why is a LONG WICK never upright?*

A. Because it is bent by its own weight.

Q. A LONG WICK is covered with an EFFLORESCENCE at the top. What does this arise from?

A. The knotty or flowery appearance of the top of a wick arises from an accumulation of particles *partly separated* but still loosely hanging to the wick.

Q. Why is not the END of a long wick BURNT OFF as it hangs over the flame?

A. Because the length of the wick diminishes *the heat of the flame*; so that it is no longer *hot* enough to *consume* the wick.

Q. Why do PALMER'S METALLIC WICKS never need SNUFFING?

A. Because the wick is divided into two parts, each of which bends toward the outside of the flame, where the *end is intensely heated*, and *separated* from the wick by the current of air up the candle.

N. B. The small wire twisted in the wick greatly assists the process.

Q. Why do common CANDLES require to be SNUFFED?

A. Because the heat of the flame is *not sufficient to consume the wick*; and the *longer* the wick grows, the *less heat* the flame produces.

Q. Why do WAX CANDLES NEVER need SNUFFING?

A. Because the wick of *wax* candles

is made of *very fine thread*, which the heat of the flame is sufficient to consume. The wick of *tallow* candles (on the other hand) is made of *coarse cotton*, which is too substantial to be consumed by the heat of the flame, and must be cut off by *snuffers*.

Q. *Why does a PIN stuck in a RUSH LIGHT EXTINGUISH it?*

A. Because a *pin* (being a good conductor) *carries away the heat of the flame from the wick*, and prevents the combustion of the tallow.

Q. *What is the SMOKE of a CANDLE?*

A. Solid particles of carbon, separated from the wick and tallow, but not consumed.

Q. *Why are SOME particles consumed and not OTHERS?*

A. The *combustion of the carbon* depends upon its *combining with the oxygen of the air*: now, as the outer surface of the flame *prevents the access of air to the interior parts*, much of the carbon of those parts passes off in smoke.

Q. *Why do LAMPS SMOKE?*

A. Either because the *wick is cut unevenly*, or else because *it is turned up too high*.

Q. *Why does a LAMP SMOKE when the WICK is cut UNEVENLY?*

A. 1st—Because the *points of the jagged edge* (being very easily separated from the wick) *load the flame with more carbon than it can consume*; and

2dly—As the heat of the flame is *greatly diminished by these bits of wick*, it is unable to consume *even the usual quantity of smoke*.

Q. *Why does a LAMP SMOKE when the WICK is turned up too HIGH?*

A. Because more carbon is separated from the wick *than can be consumed by the flame*.

Q. *Why do not "ARGAND BURNERS" smoke?*

A. Because a **c**urrent of air passes through the *middle of the flame*; in consequence of which, the carbon of the *interior* is consumed, as well as that *in the outer coating of the flame*.

Q. *Why does a LAMP-GLASS DIMINISH the SMOKE of a lamp?*

A. 1st—Because it increases the supply of *oxygen* to the flame, by producing a draught; and

2dly—It *concentrates and reflects the heat* of the flame; in consequence of which, the combustion of the carbon is

more *perfect*, and very little escapes unconsumed.

---

## CHAPTER VII.

## ANIMAL HEAT.

Q. *What is the cause of ANIMAL HEAT?*

A. Animal heat is produced *by the combustion of hydrogen and carbon in the capillary vessels.*

Q. *What are CAPILLARY VESSELS?*

A. Vessels *as small as hairs* running *all over the body*; they are called capillary from the Latin word "*capilla'ris*" (*like a hair*).

Q. *Do these CAPILLARY VESSELS run all over the human body?*

A. Yes. Whenever *blood flows from a wound*, some vein or vessel must be divided; and as you can bring blood from any part of the body by a very slight wound, these little vessels must run through every part of the human frame.

Q. *How do HYDROGEN gas and CARBON get into these very little vessels?*

A. The food we eat is *converted into*

*blood* ; and blood contains both *hydrogen* and *carbon*.

Q. *How does COMBUSTION take place in the capillary vessels?*

A. The *carbon of the blood* combines with *oxygen of the air we breathe*, and forms into *carbonic acid gas*.

Q. *What BECOMES of this CARBONIC ACID GAS formed in the human blood?*

A. The lungs throw off almost all of it into the air, by the act of respiration.

Q. *What GAS is generated in a common FIRE by COMBUSTION?*

A. *Carbonic acid gas*—formed by the union of the *carbon of fuel* with the *oxygen of the air*.

Q. *What GAS is generated by a lighted CANDLE or LAMP?*

A. *Carbonic acid gas*—formed by the union of the *carbon of the oil or tallow* with the *oxygen of the air*.

Q. *What is the cause of SPONTANEOUS COMBUSTION?*

A. The piled-up goods *ferment* from *heat and damp* ; and (during fermentation) *carbonic acid gas is formed*, which is attended with combustion.

Q. *Does the HEAT of the HUMAN BODY arise from the SAME CAUSE as the heat of FIRE?*

A. Yes, precisely. The *carbon of*



*the blood* combines with the *oxygen of the air inhaled*, and produces *carbonic acid gas*, which is attended with combustion.

Q. *If animal heat is produced by COMBUSTION, why does not the human body BURN UP like a coal or candle?*

A. It actually does so. Every muscle, nerve, and organ of the body, actually *wastes away* like a *burning candle*; and (being reduced to air and ashes) is rejected from the system as useless.

Q. *If every bone, muscle, nerve, and organ, is thus consumed by combustion, why is not the BODY entirely CONSUMED?*

A. It would be so, unless the parts destroyed *were perpetually renewed*: but as a lamp will not go out, so long as it is *supplied with fresh oil*—neither will the *body* be consumed, so long as it is *supplied with sufficient food*.

Q. *What is the principal DIFFERENCE between the combustion of a FIRE or LAMP and that of the HUMAN BODY?*

A. In the human body, the combustion is effected at a much *lower temperature*; and is carried on more *slowly*, than it is in a lamp or fire.

Q. *How is it that carbon can be made to burn at so LOW a temperature in the human body?*

A. Because the carbon in the blood

is reduced to very *minute particles*; and these particles are ready to undergo a rapid change as soon as oxygen is supplied.

Q. *When a man is STARVED, what parts of the body go first?*

A. First the *fat*, because it is the most combustible; then the *muscles*; last of all the *brain*; and then the man dies, like a *candle which is burnt out*.

Q. *Why does WANT of sufficient NOURISHMENT often produce MADNESS?*

A. Because after the *fat and muscles* of the body have been consumed by animal combustion, the *brain* is next attacked; and (unless the patient dies) *madness ensues*.

Q. *Why does a man SHRINK when STARVED?*

A. Because the capillary fires feed upon the human *body* when they are not supplied with food-fuel. A starved man shrinks *just as a fire does*, when it is not supplied with fuel.

Q. *What is the FUEL of the BODY?*

A. *Food* is the *fuel* of the *body*. The *carbon of the food* mixing with the *oxygen of the air*, evolves heat in the same way that a fire or candle does.

Q. *Why is EVERY part of the BODY WARM?*

A. Because the capillary vessels run through every part of the human body, and the combustion of blood *takes place in the capillary vessels.*

See p. 84.

Q. *Why does* RUNNING *make us* WARM?

A. Because we *inhale air more rapidly* when we run, and cause the blood to pass more rapidly through the *lungs* in contact with it. *Running* acts upon the capillary vessels as a pair of *bellows* on a common *fire.*

Q. *Why does* INHALING AIR RAPIDLY *make the body feel* WARM?

A. Because *more oxygen* is introduced into the body. In consequence of which, the combustion of the blood is *more rapid*—the blood itself *more heated*—and every part of the body is made warmer.

Q. *Why does* HARD WORK *produce* HUNGER?

A. Because it produces *quicker respiration*; by which means, a *larger amount of oxygen* is introduced into the *lungs*, and the *capillary combustion* increased. Hunger is the *notice* (given by our body) to remind us *that our food-fuel must be replenished.*

Q. *Why does* SINGING *make us* HUNGRY?

A. Because it *increases respiration*; and, as *more oxygen* is introduced into the lungs, *our food-fuel is more rapidly consumed*.

Q. Why does READING ALOUD make us feel HUNGRY?

A. Because it *increases respiration*; and, as *more oxygen* is introduced into the lungs, *our food-fuel is more rapidly consumed*.

Q. Why do we feel less HUNGRY in the night than in the DAY?

A. Because we *breathe more slowly during sleep*; therefore, less *oxygen* is introduced into the lungs, to *consume our food-fuel*.

Q. Why do we need WARMER CLOTHING by NIGHT than by DAY?

A. 1st—Because the *night is generally colder* than the day; and

2dly—Our *bodies are colder* also; because we *breathe more slowly*, and our animal combustion is retarded.

Q. Why do we PERSPIRE when very hot?

A. The pores of the body are *like the safety valves of a steam-engine*; when the heat of the body is very great, some of the combustible matter of the blood is thrown off in *perspiration*; and the heat of the body kept more temperate.

Q. *Why do persons feel LAZY and averse to exercise when they are HALF-STARVED or ILL-FED?*

A. *Animal food* contains great nourishment, and produces a desire for *active occupations*; but, when the body is not supplied with strong food, this desire for muscular action *ceases*, and the person grows slothful.

Q. *Why have persons who follow HARD, OUT-OF-DOORS OCCUPATIONS more APPETITE than those who are engaged in SEDENTARY pursuits?*

A. Hard bodily labor in the open air *causes much oxygen* to be conveyed into the *lungs by inspiration*; the combustion of the food is carried on quickly; *animal heat increased*; and need for nutritious food more quickly indicated by *craving hunger*.

Q. *Why have persons who follow SEDENTARY PURSUITS less APPETITE than ploughmen and masons?*

A. 1st—Because the air they inhale *is less pure*, being deprived of some of its oxygen: and

A. 2dly—Their respiration is neither *so quick, nor so strong*; and, therefore, the combustion of their food is carried on more slowly.

Q. *Why do we like strong MEAT and GREASY food when the WEATHER is very COLD?*

A. Because strong meat and grease

contain large portions of *carbon* and *hydrogen*; which (when burned in the blood) produce a larger amount of heat, than any other kind of food.

Q. *Why do persons EAT MORE food in COLD weather than in hot?*

A. Because the body requires more fuel in *cold weather*, to keep up the same amount of animal heat; and as we put more coals on a fire on a cold day, to keep our room warm; so we eat more food on a cold day, to keep our body warm.

Q. *Why does COLD produce HUNGER?*

A. 1st — Because the air contains more *oxygen* in cold weather; and, therefore, *fires burn more fiercely*, and *animal combustion is more rapid*: and

2dly—As we are more *active* in cold weather, our increased respiration acts like a pair of bellows on the capillary combustion.

Q. *Why does rapid DIGESTION produce a craving APPETITE?*

A. This is a wise providence to keep our bodies in health; they give notice (by hunger) that the *capillary fires need replenishing*, in order that the *body itself* may not be consumed.

Q. *Why do we feel a desire for ACTIVITY in cold weather?*

A. 1st—Because activity increases the warmth of the body, *by fanning the combustion of the blood*: and

2dly—The *strong food* we eat creates a desire for muscular exertion.

Q. *Why are the Esquimaux so passionately fond of TRAIN OIL and WHALE BLUBBER?*

A. Because oil and blubber contain large quantities of *carbon and hydrogen*, which are exceedingly combustible; and, as these people live in climates of intense cold, the heat of their bodies is increased by the *greasy nature of their food*.

Q. *Why do we feel a DISLIKE to strong meat and greasy food in very HOT weather?*

A. Because strong meat and grease contain so much *carbon and hydrogen*, that they would make us *intensely hot*: we therefore, instinctively refuse them in hot weather.

Q. *Why do we like FRUITS and VEGETABLES most in hot weather?*

A. Because they contain *less hydrogen and carbon* than meat; and, therefore, produce both *less blood*, and blood of a *less combustible nature*.

Q. *Why is the blood of a less COMBUSTIBLE nature, if we live chiefly upon FRUITS and VEGETABLES?*

A. Because fruits and vegetables

supply the blood with a very large amount of *water*; which is not combustible, like the *carbon and hydrogen* of strong meat.

Q. *How do FRUITS and VEGETABLES COOL the BLOOD?*

A. 1st—They diminish the amount of *carbon and hydrogen* in the blood, which are the chief causes of animal heat: and

2dly—They supply the blood with a large amount of *water*, which exudes *through the skin*, and leaves the body cool.

Q. *Why do we feel LAZY and averse to activity in very HOT WEATHER?*

A. 1st—Because muscular activity increases the heat of the body, by *quickening the respiration*: and

2dly—The food we eat in hot weather (not being *greasy*) naturally abates our desire for bodily activity.

Q. *Why do the inhabitants of TROPICAL countries live chiefly upon RICE and FRUIT?*

A. Because rice and fruit (by digestion) *are mainly converted into water*; and (by *cooling the blood*) prevent the tropical heat from feeling so oppressive.

Q. *Why are the ILL-FED instinctively AVERSE to CLEANLINESS?*



A. Because *cleanliness increases hunger*, which they cannot allay by food.

Q. Why are the ILL-CLAD also instinctively averse to CLEANLINESS?

A. Because *dirt is warm*, (thus pigs, who love *warmth*, are fond of *dirt*); to those, therefore, who are very *ill-clad*, the *warmth of dirt* is agreeable.

Q. Why are very POOR PEOPLE instinctively AVERSE to VENTILATION?

A. 1st—Because ventilation *increases the oxygen of the air*—the *combustion of food*—and the *cravings of appetite*: and

2dly—Ventilation *cools the air of our rooms*: to poor people, therefore, who are ill-clad, the *warmth* of an ill-ventilated apartment is agreeable.

Q. Why does FLANNEL, &c., make us WARM?

A. Flannel and warm clothing do not *make us warm*, but merely *prevent our body from becoming cold*.

Q. How does FLANNEL, &c., prevent our body from becoming cold?

A. Flannel (being a bad conductor) will neither *carry off the heat of our body* into the *cold air*, nor suffer the cold of the air *to come in contact with our warm body*: and thus it is, that flannel clothing keeps us warm.

Q. *Why are FROGS and FISHES COLD BLOODED animals?*

A. Because they consume very *little air*; and, without a plentiful supply of air, combustion is too slow to generate much animal heat.

Q. *Why is a DEAD BODY COLD?*

A. Because air is no longer conveyed to the lungs, after respiration has ceased; and, therefore, animal heat *is no longer generated by combustion.*

---

## MECHANICAL ACTION.

### CHAPTER VIII.

#### 1.—PERCUSSION.

Q. *How is heat produced by MECHANICAL ACTION?*

A. 1.—By Percussion. 2.—By Friction. And 3.—By Condensation.

Q. *What is meant by PERCUSSION?*

A. *The act of striking*; as when a blacksmith strikes a piece of iron on his anvil with his hammer.

Q. *Why does STRIKING IRON make it RED HOT?*

A. Because it *condenses the particles*

of the metal, and makes the latent heat *sensible*.

Q. *Does COLD iron contain HEAT?*

A. Yes; *everything* contains heat; but, when a thing *feels cold*, its heat is LATENT.

Q. *What is meant by LATENT HEAT?*

A. Heat *not perceptible to our feelings*. When anything contains heat without *feeling* the hotter for it, that heat is called "*latent heat*."

See p. 37.

Q. *Does COLD iron contain latent HEAT?*

A. Yes; and when a blacksmith *compresses the particles* of iron by his *nammer*, he brings *out* latent heat; and this makes the iron red hot.

Q. *How used blacksmiths to LIGHT THEIR MATCHES before the general use of lucifers?*

A. They used to place a soft iron nail upon their anvil; strike it two or three times with a hammer; and the point became *sufficiently hot to light a brimstone match*.

Q. *How can a NAIL (beaten by a hammer) IGNITE a brimstone MATCH?*

A. The particles of the nail being *compressed* by the hammer, can no longer contain so much heat in a *latent state*, as

they did *before*; some of it, therefore, becomes *sensible*, and increases the temperature of the iron.

Q. *Why does STRIKING a FLINT against a piece of STEEL produce a SPARK?*

A. Because it compresses those parts of the flint and steel which strike *together*. In consequence of which, some of their latent heat is disturbed, and exhibits itself in a spark.

Q. *How does this development of HEAT produce a SPARK and set TINDER on fire?*

A. A very small fragment (either of the steel or flint) is *knocked off red hot*, and sets fire to the tinder on which it falls.

Q. *Why is it needful to keep BLOWING the TINDER with the breath?*

A. In order that the increased supply of air may furnish the tinder with more *oxygen* to assist combustion.

Q. *Where does the OXYGEN of the air COME FROM, which is blown to the lighted tinder?*

A. From the air itself, which is composed of two gases (*nitrogen and oxygen*) mixed together.

Every 5 gallons of common air contain nearly 4 gallons of nitrogen, and 1 of oxygen.

Q. *What is the USE of OXYGEN GAS to lighted tinder?*

A. It *supports the combustion* of the tinder. *Blowing* lighted tinder carries *oxygen* to it and *quicken*s it, in the same way as a pair of bellows quickens a dull fire.

Q. *Why do* HORSES *sometimes* STRIKE FIRE *with their* FEET?

A. Because when their iron shoes strike against the flint stones of the road, *very small fragments* (either of the shoe or stones) are *knocked off red hot*, and look like sparks.

Q. *What makes these fragments* RED HOT?

A. The percussion *condenses* the part struck: In consequence of which, some of its *latent heat* is rendered *sensible*, and exhibits itself in these red hot fragments.

---

## CHAPTER IX.

### 2.—FRICTION.

Q. *What is meant by* FRICTION?

A. The act of *rubbing two things together*; as the Indians rub two pieces of *wood* together to produce fire.

Q. *How do the Indians produce* FIRE *by merely* RUBBING TWO PIECES *of dry* WOOD TOGETHER?

A. They take a piece of dry wood, sharpened to a point, which they rub quickly up and down a *flat piece*, till a *groove* is made; and the *dust* (collected in this groove) *catches fire*.

Q. *Why does the dust of the WOOD CATCH FIRE by RUBBING?*

A. Because *latent heat* is developed from the wood *by friction*.

The best woods for this purpose are *boxwood* against *mulberry*, or *laurel* against *poplar* or *ivy*.

Q. *Do not CARRIAGE WHEELS sometimes CATCH FIRE?*

A. Yes; when the wheels are *dry*—or *fit too tightly*—or *revolve very rapidly*.

Q. *Why do wheels catch fire in such cases?*

A. Because the *friction* of the wheels against *the axle-tree* disturbs their *latent heat*, and produces ignition.

Q. *What is the use of GREASING CART WHEELS?*

A. Grease *lessens the friction*; and, because there is *less friction*, the latent heat of the wheels is less disturbed.

Q. *Why does RUBBING our HANDS and FACES make them feel WARM?*

A. 1st—Because friction *excites the latent heat* of our hands and faces, and makes it sensible to our feeling: and

2dly—The blood is made to *circulate more quickly*; in consequence of which,

the quantum of heat (left in its passage) is increased.

Q. *When a man has been almost DROWNED, why is suspended animation RESTORED by RUBBING?*

A. 1st—Because friction *excites the latent heat* of the half-inanimate body: and

2dly—It makes the *blood circulate more quickly*, which increases the animal heat.

Q. *Why do two pieces of ICE (rubbed together) MELT?*

A. Ice contains 140 *degrees of latent heat*, and (when two pieces are *rubbed together*) some of this latent heat is made *sensible*, and melts the ice.

Q. *Are not FORESTS sometimes SET on FIRE by friction?*

A. Yes; when two branches or trunks of trees (blown about by the wind) *rub violently against each other*, their *latent heat is developed*, and sets fire to the forests.

Q. *Why do carpenters' TOOLS (such as gimlets, saws, files, &c.) become HOT when used?*

A. Because the friction of the tools against the wood disturbs its *latent heat*, and makes it *sensible*.

Q. *Give an ILLUSTRATION of this.*

A. When cannon is bored, the borers

become so intensely hot from friction, that they would blister the hands, if touched.

Q. *Why do these BORERS become so intensely HOT?*

A. Because the friction of the borers against the metal is so great, that it sets free a large quantity of latent heat.

---

## CHAPTER X.

### 3.—CONDENSATION or COMPRESSION.\*

Q. *What is meant by COMPRESSION?*

A. The act of *bringing parts nearer together*; as a sponge is *compressed* by being *squeezed in the hand*.

Q. *Cannot HEAT be evolved from common air merely by COMPRESSION?*

A. Yes; if a piece of *German tinder* be placed at the *bottom of a glass tube*, and the air in the tube *compressed by a piston*, the tinder will catch fire.

In a common syringe or squirt, the *handle* part (which contains the *sucker*, and is forced up and down) is called "the *Piston*."

---

\* N. B. The reduction of matter into a smaller compass by any *external* or *mechanical* force is called **COMPRESSION**.

The reduction of matter into a smaller compass by some *internal action* (as by the escape of caloric) is called **CONDENSATION**.



Q. *Why will the tinder catch fire?*

A. Because the *air is compressed*, and its *latent heat being squeezed out*, sets fire to the tinder at the bottom of the tube.

Q. *When an AIR-GUN is discharged in the dark, why is it accompanied with a slight FLASH?*

A. Because the *air is very rapidly condensed*, and its latent heat developed in a *flash of light*.

N. B. If a glass lens be fixed in the copper ball, (where the *air of the gun is condensed*,) a flash of light may be distinctly discerned at the stroke of the piston.

Q. *Why do DETONATING salt and powder EXPLODE on being rubbed or struck?*

A. Because the mechanical action of rubbing or striking, produces sufficient heat to ignite the explosive materials of which they are composed.

Q. *Why are SHOT and CANNON-BALLS HEATED by being discharged from a gun or cannon?*

A. Because the air is so rapidly condensed, when the discharge is made, that sufficient latent heat is developed to make the shot or balls hot.

Q. *Why does the HOLE made by a shot or cannon-ball in a wall or timber, look as if it were BURNT?*

A. Because the shot or cannon-balls were so heated by the discharge, as actually to scorch the material into which they penetrated.

## EFFECTS OF HEAT.

## CHAPTER XI.

## I.—EXPANSION.

Q. *What are the principal EFFECTS of HEAT?*

A. 1.—Expansion. 2.—Liquefaction. 3.—Vaporization. 4.—Evaporation; and 5.—Ignition.

Q. *Does HEAT EXPAND AIR?*

A. Yes; if a bladder (partially filled with air) be tied up at the neck, and *laid before the fire*, the air will expand till the bladder *bursts*.

Q. *Why will the AIR SWELL if the bladder be laid before the fire?*

A. Because the heat of the fire will drive the particles of air *apart from each other*, and cause them to occupy more room than they did before.

Q. *Why do unslit CHESTNUTS CRACK with a loud noise when ROASTED?*

A. Because they contain a great deal of air which is expanded by the heat of the fire; and not being able to escape, *bursts* violently through the thick rind, *slitting it*, and making a great noise.

Q. *What occasions the loud CRACK or report which we hear?*

A. 1st—The sudden bursting of the rind makes a report; in the same way as a piece of wood or glass would do, if snapped in two: and

2dly—The escape of hot air from the chestnut makes a report also; in the same way as gunpowder, when it escapes from a gun.

Q. *Why does the sudden BURSTING of the rind, or SNAPPING of a piece of wood, make a REPORT?*

A. Because a violent jerk is given to the air, when the attraction of cohesion is thus suddenly overcome. This jerk produces rapid undulations in the air, which (striking upon the ear) give the brain a sensation of sound.

Q. *Why does the ESCAPE of AIR from the chestnut, or the EXPLOSION of GUNPOWDER, produce a REPORT?*

A. Because the sudden expansion of the imprisoned air produces a partial vacuum; the report is caused by the rushing of fresh air to fill up this vacuum.

See Thunder, p. 15.

Q. *If a CHESTNUT be SLIT, it will NOT CRACK; why is this?*

A. Because the heated air of the

chestnut can then *freely escape* through the *slit in the rind*.

Q. *Why does an APPLE split and SPURT about when roasted?*

A. Because it contains a vast quantity of *air*, which (being expanded by the heat of the fire) *bursts through the peel*, carrying the juice of the apple along with it.

Q. *Does an APPLE contain MORE AIR in proportion than a CHESTNUT?*

A. Yes, much more. There is as much condensed air in a common apple, as would fill a space 48 *times as large as the apple itself*.

Q. *How can all this AIR be stowed in an APPLE?*

A. The *inside* of an apple consists of *little cells* (like a honey-comb), each of which contains a portion of the air.

Q. *When an APPLE is ROASTED, why is one part made SOFT, while all the rest remains hard?*

A. Because the air in those *cells next the fire* is expanded, and flies out; the *cells are broken, and their juices mixed together*; so the apple *collapses* (from loss of air and juice), and feels *soft* in those parts.

Q. *What is meant by the "apple COLLAPSING?"*

A. It means that the *plumpness* gives

way, and the apple becomes *flabby* and *shrivelled*.

Q. *Why do SPARKS of fire start (with a crackling noise) from pieces of WOOD laid upon a FIRE?*

A. Because the *air* (expanded by the heat) *forces its way through the pores of the wood*; and carries along with it the *covering of the pore*, which resisted its passage.

Q. *What is meant by the "PORES of the WOOD?"*

A. Very small *holes in the wood*, through which the *sap* circulates.

Q. *What are the SPARKS OF FIRE which burst from the WOOD?*

A. Very small pieces of wood made *red hot*, and separated from the log by the *force of the air*, when it bursts from its confinement.

Q. *Why does DRY PINE make more snapping than any OTHER WOOD?*

A. Because the pores of pine are *very large*, and contain *more air* than wood of a *closer grain*.

Q. *Why does GREEN WOOD make LESS SNAPPING than DRY?*

A. Because the pores being filled with *sap*, contain *very little air*.

Q. *Why does DRY WOOD make MORE SNAPPING than green?*

A. Because the sap is *dried up*, and the pores are filled with *air* instead.

Q. *Why does DRY wood BURN more easily than GREEN or wet wood?*

A. Because the pores of dry wood are *filled with air* which supports combustion; but the pores of green or wet wood are filled with *moisture*, which extinguishes flame.

Q. *Why does MOISTURE EXTINGUISH FLAME?*

A. 1st—Because it prevents the *hydrogen* of the fuel from mixing with the *oxygen* of the air, to form *carbonic acid gas*; and

2dly—Because heat is perpetually carried off, by the formation of the sap or moisture *into steam*.

Q. *Why do STONES SNAP and fly about when heated in the FIRE?*

A. Because the close texture of the stone prevents the hot air from escaping; in consequence of which, it *bursts forth with great violence*, tearing the stone to atoms, and forcing the fragments into the room.

Probably some part of this effect is due to the setting free of the *water of crystallization*.

Q. *When bottled ALE or PORTER is set before a FIRE, why is the CORK FORCED OUT sometimes?*

A. Because the *carbonic acid* of the

liquor *expands* by the heat, and drives out the cork.

Carbonic acid gas is a compound of carbon and oxygen. The *carbon* comes from the *fuel*, and the *oxygen* from the *air*. See p. 40.

Q. *Why does ALE or PORTER FROTH more after it has been set before the fire?*

A. Because the heat of the fire sets free the *carbonic acid* of the liquor; which is entangled as it rises through the liquor, and produces bubbles or froth.

Q. *When a boy makes a BALLOON, and sets fire to the cotton or sponge (which has been steeped in spirits of wine), why is the balloon INFLATED?*

A. Because the *air* of the balloon is *expanded by the flame*, till every crumple is inflated and made smooth.

Q. *Why does the BALLOON RISE after it has been inflated by the expanded air?*

A. Because the same quantity of air is *expanded to three or four times its original volume*; and made so much *lighter*, that even when all the paper, wire, and cotton are added, it is still lighter than common air.

Q. *Why does SMOKE RUSH UP a CHIMNEY?*

A. Because the heat of the fire *expands the air in the chimney*; which (being thus made *lighter* than the air around) *rises up the chimney*, and carries the smoke in its current.

Q. *Why will a LONG chimney SMOKE, unless the FIRE be pretty FIERCE?*

A. Because the heat of the fire will not be sufficient to *rarefy all the air in the chimney.*

Q. *WHY will the chimney smoke, unless the fire be FIERCE enough to heat ALL the air in the CHIMNEY FLUE?*

A. Because the *cold air* (condensed in the upper part of the flue) *will sink from its own weight*; and sweep the ascending smoke *back* into the room.

Q. *What is the use of a COWL upon a chimney-pot?*

A. It acts as a *screen*, to prevent the wind from blowing into the chimney.

Q. *What HARM would the WIND do if it were to BLOW into a CHIMNEY?*

A. 1st—It would prevent the smoke from getting out; and

2dly—The *cold air* (introduced into the chimney by the wind) *would fall down the flue*, and drive the smoke with it *into the room.*

Q. *Why are some things SOLID, others LIQUID, and others GASEOUS?*

A. Because the particles which compose some things are nearer together than they are in others. Those in which the particles are *closest* are *solid*; those



in which they are *furthest apart* are *gaseous*; and the rest *liquid*.

Q. *Why does heat change a SOLID (like ice) first into a LIQUID, and then into a GAS?*

A. Because heat drives the component particles further *asunder*; hence a certain quantity of heat changes solid ice into a *liquid*—and a further addition of heat changes the liquid into *steam*.

Q. *Why does WATER SIMMER before it boils?*

A. Because the particles of water near the *bottom* of the kettle (being formed into *steam* sooner than the rest) *shoot upwards*; but are *condensed* again (as they rise) *by the colder water*, and produce what is called “*simmering*.”

Q. *What is meant by SIMMERING?*

A. A gentle tremor or *undulation* on the surface of the water. When water *simmers*, the bubbles *collapse beneath the surface*, and the steam is condensed to *water again*; but when water *boils*, the bubbles *rise to the surface*, and the *steam is thrown off*.

Collapse, i. e., burst.

Q. *Why does a KETTLE SING when the water simmers?*

A. Because the *air* (entangled in the water) escapes by *fits and starts* through

the *spout* of the kettle, which makes a noise like a wind instrument.

Q. *Why does NOT a kettle SING when the water BOILS?*

A. Because *all* the water is *boiling hot*; so the steam escapes in a *continuous stream*, and not by *fits and starts*.

Q. *When does a kettle sing MOST?*

A. When it is set on the *hob* to boil.

Q. *Why does a kettle SING MORE when it is set on the SIDE of a fire, than when it is set in the MIDST of the fire?*

A. Because the heat is applied so *unequally*, that *one side is made hotter than the other*; in consequence of which, the steam is more *entangled*.

Q. *Why does a KETTLE sing, when the boiling water begins to COOL again?*

A. Because the *upper* surface cools *first*; and the steam (which rises from the lower part of the kettle) is *again entangled*, and escapes by *fits and starts*.

Q. *Why does BOILING WATER SWELL?*

A. Because it is *expanded by the heat*:  
 .. e.—The heat of the fire drives the particles of water *further apart* from each other: and (as they are not *packed so closely together*) they take up *more room*; in other words, the water *swells*.

Q. *What is meant when it is said, that "HEAT drives the PARTICLES of water further APART from each other?"*

A. Water is composed of little globules, like very small grains of sand; the heat *drives* these particles away from each other; and (as they then require more *room*) the water *swells*.

Q. *Why does BOILING WATER BUBBLE?*

A. Because the *vapor* (rising through the water) is *entangled*, and forces up bubbles in its effort to escape.

N. B. All the *air* of water is expelled at the commencement of its boiling.

Q. *Why does a KETTLE sometimes BOIL OVER?*

A. Because the water is *expanded by heat*; if, therefore, a kettle is *filled with cold water*, some of it must *run over*, as soon as it is *expanded by heat*.

Q. *But I have seen a KETTLE BOIL OVER, although it has not been filled FULL of WATER; how do you account for THAT?*

A. If a fire be *very fierce*, the air and vapor are expelled so *rapidly*, that the *bubbles are very numerous*; and (towering one above another) reach the *top of the kettle*, and *fall over*.

Q. *Why is a pot (which was full to OVERFLOWING, while the water was boiling HOT) NOT FULL, after it has been taken off the fire for a short time?*

A. Because (while the water is *boiling*) it is *expanded* by the heat, and fills the pot even to overflowing: but, when it becomes cool, it *contracts* again, and occupies a much less space.

Q. *Why does the water of a KETTLE run out of the SPOUT when it BOILS?*

A. Because the lid fits so tightly, that the steam cannot lift it up and escape: being confined, therefore, in the kettle, it *presses on the water* with great power, and forces it out of the spout.

Q. *What causes the RATTLING NOISE, so often made by the LID of a saucepan or boiler?*

A. The steam (seeking to escape) *forces up the lid* of the boiler, and the *weight* of the lid carries it *back again*: this being done *frequently*, produces a rattling noise.

Q. *If the steam COULD NOT LIFT UP THE LID of the boiler how would it escape?*

A. If the lid fitted so tightly, that the steam could not raise it up, the boiler would *burst into fragments*, and the consequences might be fatal.

Q. *When steam pours out from the spout of a kettle, the STREAM begins apparently HALF AN INCH off the SPOUT; why does it not begin CLOSE to the spout?*

A. Steam is really *invisible* and the

half-inch (between the spout and the "stream of mist", is the *real steam*, before it has been condensed by air.

Q. *Why is not ALL the steam INVISIBLE as well as that half-inch?*

A. Because the invisible particles are *condensed by the cold air*; and, rolling one into another, look like a thick mist.

Q. *What BECOMES of the STEAM? for it soon vanishes.*

A. After it has been condensed into mist, it is *dissolved by the air*, and dispersed abroad as *invisible vapor*.

Q. *And what BECOMES of the INVISIBLE VAPOR?*

A. Being *lighter* than air, it *ascends* to the upper regions of the atmosphere, where (being again *condensed*) it contributes to form *clouds*.

Q. *Why does a METAL SPOON (left in a saucepan) RETARD the process of BOILING?*

A. Because the metal spoon (being an excellent *conductor*) *carries off the heat from the water*; and (as heat is carried off by the spoon) the water takes a longer time to boil.

Q. *Why will a POT (filled with water) NEVER BOIL, when immersed in ANOTHER vessel full of water also?*

A. Because water can never be heated *above the boiling point*; all the heat

absorbed by water after it *boils*, is employed in generating *steam*.

Q. *How does the conversion of water into steam, prevent the INNER POT from BOILING?*

A. Directly the water in the larger pot is *boiling hot* (or  $212^{\circ}$ ), *steam is formed* and *carries off some of its heat*; therefore,  $212^{\circ}$  of heat can never *pass through it*, to raise the *inner vessel to boiling heat*.

Q. *Why do SUGAR, SALT, &c., RETARD the process of BOILING?*

A. Because they increase the *density* of water; and whatever increases the *density* of a fluid, retards its boiling.

Q. *If you want water to boil without COMING IN CONTACT with the SAUCEPAN, what plan must you adopt?*

A. We must *immerse the pot* (containing the water to be boiled) in a saucepan containing *strong brine*, or sugar.

Q. *Why would the INNER vessel boil, if the OUTER vessel contained strong BRINE?*

A. Because *brine* will not boil, till it is raised to  $218$  or  $220^{\circ}$ . Therefore,  $212^{\circ}$  of heat may easily pass through it, to *raise the vessel immersed in it to boiling heat*.

Q. *Why will brine impart to another vessel MORE than  $212^{\circ}$ , and water NOT SO MUCH?*

A. Because no liquid can impart so high a degree of heat, as its own *boiling* temperature: As water boils at  $212^{\circ}$  it cannot impart  $212^{\circ}$  of heat: but, as brine will not boil without  $21^{\circ}$  of heat, it can impart enough to make water boil.

Q. *Why can liquids impart no EXTRA heat, after they boil?*

A. Because all *extra* heat is spent in *making steam*. Hence water will not boil a vessel of *water* immersed in it, because it cannot impart to it  $212^{\circ}$  of heat; but *brine* will, because it can impart *more* than  $212^{\circ}$  of heat, before it is *itself* converted into steam.

Ether boils at - - 100	degs.	Syrup boils at - - 221	degs.
Alcohol - - - - - 173½	"	Oil of turpentine - 314	"
Water - - - - - 212	"	Sulphuric acid - - 472	"
Water, with one-		Linseed oil - - - - 640	"
fifth salt - - 219	"	Mercury - - - - - 656	"

Any liquid which boils at a *lower* degree can be made to boil, if immersed in a liquid which boils at a *higher* degree. Thus a *cup of ether* can be made to boil in a saucepan of *water*. A *cup of water* in a saucepan of *brine* or *syrup*. But a *cup of water* will not boil, if immersed in *ether*; nor a *cup of syrup* in *water*.

Q. *Why are CLOUDS HIGHER on a FINE DAY?*

A. Because they are *lighter*, and *more buoyant*.

Q. *Why are CLOUDS LIGHTER on a FINE DAY?*

A. 1st—Because the vapor of the clouds is *less condensed*; and

2dly—The *air itself* (on a fine day) retains much of its vapor in an *invisible* form.

Q. *Why is a CUP put INVERTED into a FRUIT-PIE?*

A. Its principal use is to *hold the crust up*, and *prevent it from sinking*, when the cooked fruit gives way under it.

Q. *Does not the cup PREVENT the FRUIT of the pie from BOILING OVER?*

A. No—it will rather tend to *make it* boil over, as there will be *less room* in the dish.

Q. *Explain this.*

A. When the pie is put into the oven the *air* in the cup will *begin to expand*, and drive every particle of juice from under it; in consequence of which, the pie-dish will have a cup-full *less room* to hold its fruit in, than if the cup were *taken out*.

Q. *If the juice is driven OUT of the cup, why is the CUP always FULL of JUICE when the pie is cut up?*

A. Because immediately the pie is *drawn*, the air in the cup begins to *condense again*, and occupy a *smaller space*; and, as the cup is no longer full of *air*, *juice* rushes in to occupy the void.

Q. *Why does JUICE rush into the cup when the cup is NOT FULL of AIR?*



A. Because the external air *presses upon the surface of the juice*, which rushes *unobstructed* into the cup; as mercury rises through the tube of a barometer.

N. B. Since the juice of the pie runs into the cup, as soon as it is taken out of the oven; the cup prevents the juice from being *spilt over the crust*, when the pie is carried about from place to place; although it does not prevent the fruit from boiling over.

---

## CHAPTER XII.

### EXPANSION FROM HEAT.

(Continued.)

Q. Does heat expand everything ELSE besides air and water?

A. Yes: every thing (that man is acquainted with) is expanded by heat.

Q. Why does a COOPER heat his HOOPS RED HOT when he puts them on a tub?

A. 1st—As iron expands by heat, the hoops will be larger when they are red hot; in consequence of which, they will fit on the tub more easily: and

2dly—As iron contracts by cold, the hoops will shrink as they cool down, and girt the tub with a tighter grasp.

Q. Why does a WHEELWRIGHT make the hoops RED HOT which he fixes on the NAVE of a WHEEL?

A. 1st—That they may *fit on more easily* : and

2dly—That they may *girt the nave more tightly*.

Q. *Why will the wheelwright's HOOP FIT the nave MORE EASILY, for being made RED HOT?*

A. Because it will be *expanded* by the heat ; and (being larger) will go on the nave more *easily*.

Q. *Why will the HOOPS which have been PUT ON HOT GIRT the nave more FIRMLY?*

A. Because they will *shrink* when they cool down ; and, therefore, *girt the nave with a tighter grasp*.

Q. *Why does a STOVE make a CRACKLING NOISE when a fire is very hot?*

A. Because it *expands* from the heat ; and the parts of the stove *rubbing* against each other, or driving against the *bricks*, produce a *crackling* noise.

Q. *Why does a STOVE make a similar CRACKLING NOISE when a large FIRE is TAKEN DOWN?*

A. Because it *contracts again*, when the fire is removed ; in consequence of which, the parts *rub against* each other again, and the *bricks are again disturbed*.

Q. *Why does the PLASTER round a STOVE CRACK and fall away?*

A. Because (when the fire is light ed) the *iron-work* expands more than

the brick-work and plaster, and *pushes them away*; but (when the fire is put out) the metal *shrinks* again, and leaves the "setting" behind.

The "setting" is a technical word for the plaster, &c., in immediate contact with the stove.

Q. *Why does the PLASTER FALL AWAY?*

A. As a *chink* is left (between the "setting" and the stove), the plaster will frequently fall away from its own weight.

Q. *What OTHER cause contributes to BRING the PLASTER DOWN?*

A. As the *heat of the fire* varies, the *size of the iron stove* varies also; and this swelling and contracting keep up such a *constant disturbance* about the plaster, that it *cracks and falls off*, leaving the fire-place very unsightly.

Q. *Why does the MERCURY of a THERMOMETER RISE in hot weather?*

A. Because heat *expands the metal*, which (being increased in bulk) occupies a *larger space*; and, consequently, rises higher in the tube.

Q. *Why is a GLASS BROKEN when HOT WATER is poured into it?*

A. Because the *inside* of the glass is expanded by the hot water, and *not the*

*outside*; so the *glass snaps*, in consequence of this unequal expansion.

Q. *Why is not the OUTSIDE of the GLASS expanded by the hot water as well as the INSIDE?*

A. Because glass is a *bad conductor of heat*, and *breaks* before the heat of the *inner* surface is conducted to the *outside*.

Q. *Why does a GLASS snap because the INNER surface is HOTTER than the OUTER?*

A. Because the *inner* surface is expanded and not the *outer*: in consequence of which, an *opposing force* is created, which breaks the glass.

Q. *Why is a CHINA CUP broken if HOT WATER be poured over it, or into it?*

A. Because it is a *bad conductor*; and, as the *inner* surface expands from the heat, (and *not* the *outer*,) an *opposing force* is created, which breaks the cup.

Q. *If a GLASS BEAKER be set on a warm HOB, why does the BOTTOM COME OFF?*

A. Because glass is a *bad conductor*; and (as the *bottom* of the glass expands from the warmth of the hot stove, before the *sides* are heated) the two parts *separate* from each other.

## CHAPTER XIII.

## 2.—LIQUEFACTION.

## 3.—VAPORIZATION.

Q. *What is meant by LIQUEFACTION ?*

A. *The state of being melted ; as ice is melted by the heat of the sun.*

Q. *Why is ICE MELTED by the HEAT of the SUN ?*

A. *Because, when the heat of the sun enters the solid ice, it forces its particles asunder ; till their attraction of cohesion is sufficiently overcome, to convert the solid ice into a liquid.*

See p. 109.

Q. *Why are METALS MELTED by the heat of FIRE ?*

A. *Because, when the heat of the fire enters the solid metal, it forces its particles asunder ; till their attraction of cohesion is sufficiently overcome, to convert the solid metal into a liquid.*

Q. *Why is WATER converted into STEAM by the heat of the FIRE ?*

A. *Because, when the heat of the fire enters the water, it separates its globules into very minute bubbles ; which (being lighter than air) fly off from the surface in the form of steam.*

Q. *Why does not WOOD MELT like metal ?*

A. Because the heat of the fire *decomposes* the wood into *gas, smoke, and ashes*; and the different parts *separate* from each other.

Q. *What is meant by VAPORIZATION?*

A. The *conversion* of a *solid or liquid into vapor*: as *snow or water* is converted into vapor by the heat of the sun.

Q. *What are CLOUDS?*

A. *Moisture evaporated from the earth*, and again partially *condensed* in the upper regions of the air.

Q. *What is the difference between a FOG and a CLOUD?*

A. Clouds and fogs differ only in one respect. *Clouds are elevated above our heads*: but *fogs come in contact with the surface of the earth*.

Q. *Why do CLOUDS FLOAT so readily in the air?*

A. Because they are composed of *very minute globules* (called *vesicles*); which (being lighter than air) float, like *soap bubbles*.

Q. *Why does VAPOR sometimes form into CLOUDS, and sometimes rest upon the earth as MIST or FOG?*

A. This depends on the *temperature* of the air. When the *surface of the earth is warmer than the air*, the vapor

of the earth (being condensed by the chill air) becomes *mist or fog*. But, when the *air is warmer than the earth*, the vapor rises through the air, and becomes cloud.

Q. Are ALL clouds ALIKE?

A. No. They vary greatly in *density, height, and color*.

Q. What is the chief CAUSE of fog and CLOUDS?

A. The changes of the wind.

Many *local* circumstances also favor the formation of clouds.

Q. How can the CHANGES of the WIND affect the CLOUDS?

A. If a *cold current of wind* blows suddenly over any region, it *condenses* the invisible vapor of the air into *cloud or rain*: but if a *warm current of wind* blows over any region, it *disperses* the clouds, by *absorbing their vapor*.

Q. What COUNTRIES are the MOST cloudy?

A. Those where the winds are *most variable*, as Britain.

Q. What COUNTRIES are the LEAST cloudy?

A. Those where the winds are *least variable*, as Egypt.

Q. What DISTANCE are the CLOUDS from the EARTH?

A. Some *thin, light clouds* are elevated above the highest mountain-top;

some *heavy* ones touch the steeples, trees, and even the earth : but the *average* height is between *one and two miles*.

N. B. Streaky, curling clouds, *like hair*, are often 5 or 6 miles high.

Q. WHAT CLOUDS *are the* LOWEST?

A. Those which are *most highly electrified* ; lightning clouds are rarely more than about 700 yards above the ground ; and often actually *touch the earth with one of their edges*.

Q. What is the SIZE of the CLOUDS?

A. Some clouds are 20 square miles in surface, and above a mile in thickness ; while others are only a few yards or inches.

Q. How can persons ascertain the THICKNESS of a cloud?

A. As the *tops* of high mountains are generally above the clouds, travellers may pass *quite through* them into a clear blue firmament ; when the clouds will be seen *beneath their feet*.

Q. What produces the great VARIETY in the SHAPE of the CLOUDS?

A. Three things : 1st—The cause and manner of their *formation* :

2dly—Their *electrical* condition : and

3dly—Their relations to *currents of wind*.



Q. *How can ELECTRICITY affect the SHAPE of CLOUDS?*

A. If one cloud be *full of electricity* and another *not*, they will be *attracted* to each other, and either *coalesce*—diminish in size—or *vanish altogether*.

Q. *WHAT CLOUDS assume the most FANTASTIC shapes?*

A. Those that are the most *highly electrified*.

Q. *What effect have WINDS on the SHAPE of CLOUD?*

A. They sometimes *absorb them entirely*; sometimes *increase their volume and density*; and sometimes *change the position of their parts*.

Q. *How can WINDS ABSORB CLOUDS altogether?*

A. *Warm, dry winds* will convert the substance of clouds into *invisible vapor*, which they will carry away in their own current.

Q. *How can WINDS INCREASE the bulk and density of CLOUDS?*

A. *Cold currents of wind* will *condense the invisible vapor* of the air, and *add it to the clouds* with which they come in contact.

Q. *How can winds CHANGE the SHAPE of CLOUDS, by altering the position of their parts?*

A. Clouds are so *voluble and light*,

that every breath of wind changes the position of their vesicles or bubbles.

Q. *What are the general colors of the CLOUDS?*

A. White and grey, when the sun is *above the horizon*: but red, orange, and yellow, at *sun-rise* and *sun-set*.

The *blue sky* is not *cloud* at all.

Q. *Why are the LAST CLOUDS of EVENING generally of a RED tinge?*

A. Because *red rays* (being the *least refrangible* of all) are the *last to disappear*.

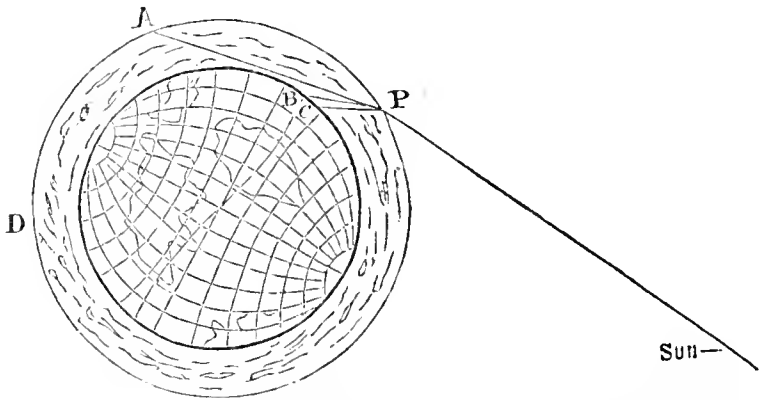

Suppose P A to be the red rays, P B the yellow, P C the blue. If the earth turns in the direction of P A D, it is quite manifest that a spectator will see A, (the red rays,) some time after P C and P B have passed from sight.

Q. *What is meant by being "LESS REFRANGIBLE"?*

A. Being *less able to be bent*. Blue and yellow rays are more easily bent *below the horizon* by the resistance of the air: but red rays are not so much *bent*

*down*; and, therefore, we see them later in the evening.

As at A in the figure on p. 126.

Q. *Why are MORNING CLOUDS generally of a RED tinge?*

A. Because red rays are the *least refrangible* of all; and not being *bent* so much as blue and yellow rays, we see them sooner of a morning.

Thus (fig. on p. 126) if the earth turned in the direction of D A P, a spectator at D would see A (the red rays) long before he saw P B and P C.

Q. *Why is not the color of clouds always ALIKE?*

A. Because their *size, density, and situation* in regard to the sun, are perpetually varying; so that sometimes *one* color is reflected and sometimes *another*.

Q. *What regulates the MOTION of the CLOUDS?*

A. Principally the *winds*; but sometimes *electricity* will influence their motion also.

Q. *How do you know that CLOUDS move by OTHER influences besides WIND?*

A. Because (in calm weather) we often see *small clouds meeting each other* from opposite directions.

Q. *How do you know, that ELECTRICITY affect the motion of the clouds?*

A. Because clouds often meet from *opposite directions*; and, having discharg-

ed their opposite electricities into each other, *vanish altogether*.

Q. *Into how many CLASSES are the different sorts of CLOUDS generally divided?*

A. Into three classes:—viz. Simple, Intermediate, and Compound.

Q. *How are SIMPLE CLOUDS sub-divided?*

A. Into 1.—Cirrus; 2.—Cum'ulus; and 3.—Stra'tus clouds.

Q. *What sort of CLOUDS are called CIRRUS?*

A. Clouds like *fibres, loose hair, or thin streaks*, are called “cirrus clouds.”

Q. *Why are these clouds called CIRRUS?*

A. From the Latin word *cirrus* (“a lock of hair, or curl”). Cirrus clouds are the *most elevated of all*.

Q. *What do CIRRUS clouds PORTEND?*

A. When the streamers point *upwards*, the clouds are *falling*, and *rain is at hand*: but when the streamers point *downwards*, westerly winds or drought may be expected.

Q. *What sort of CLOUDS are called CUM'ULUS?*

A. Cum'ulus clouds are lumps, like great *sugar-loaves—volumes of smoke—*or *mountains towering over mountains*.

Q. *Why are these monster masses called CUM'ULUS CLOUDS?*

A. From the Latin word *cum'ulus* (“a mass or pile”).

Q. What do CUM'ULUS clouds FORESHOW ?

A. When these piles of cloud are *fleecy*, and sail *against the wind*, they indicate *rain*; but when their outline is very *hard*, and they come up *with the wind*, they foretell *fine weather*.

Cum'ulus clouds should be *smaller* towards evening than they are at noon. If they *increase* in size at sun-set, a thunder-storm may be expected in the night.

Q. What sort of CLOUDS are called STRA'TUS ?

A. *Creeping mists*, especially prevalent in a summer's evening: these clouds rise at sun-set *in low, damp places*; and are always *nearer the earth* than any *other* sort of cloud.

Q. Why are these mists called STRA'TUS clouds ?

A. From the Latin word *stratus* ("laid low," or "that which lies low").

Q. What produces CIRRUS CLOUDS ?

A. Moisture in a visible form, deposited in the *higher regions* of the atmosphere by *ascending currents of heated air*.

Q. What produces CUM'ULUS CLOUDS ?

A. Masses of visible vapor passing from the places where they were *formed*, to other places where they are about to be either *dissolved*, or deposited as falling *rain*.

Q. What produces STRA'TUS CLOUDS ?

A. Beds of visible moisture, formed

by some chilling effects, acting along the *direct surface* of the *earth*.

Q. *How are the INTERMEDIATE CLOUDS subdivided?*

A. Into two sorts. 1.—The Cirro-Cum'ulus; and 2.—The Cirro-Stra'tus.

Q. *What are CIRRO-CUM'ULUS CLOUDS?*

A. Cirro-Cum'ulus clouds are cirrus clouds springing from a *massy centre*, or *heavy masses*, edged with *long streaks* generally called "*mares' tails*."

A system of *small round* clouds may be called cirro-cum'ulus.

Q. *What do CIRRO-CUM'ULUS clouds generally FOREBODE?*

A. Continued drought, or hot, dry weather.

Q. *What are CIRRO-STRA'TUS CLOUDS?*

A. They compose what is generally called a "*mackarel sky*." This class of clouds invariably indicates *rain* and *wind*; hence the proverb—

"Mackarel's scales and mares' tails  
Make lofty ships to carry low sails."

Q. *What produce CIRRO-CUM'ULUS clouds?*

A. *Cum'ulus* clouds dissolving away into *cirrus* produce the intermediate class called CIRRO-CUM'ULUS.

Q. *What produce CIRRO-STRA'TUS clouds?*

A. *Cirrus* clouds accumulating into

*denser* masses produce the intermediate class, called CIRRO-STRA'TUS.

Q. *How are* COMPOUND CLOUDS *sub-divided?*

A. Compound clouds are also sub-divided into two sorts. 1.—The Cum'u-lo-Stra'tus; and 2.—The Nimbus clouds.

Q. *What is meant by* CUMULO-STRA'TUS *clouds?*

A. Those clouds which assume all sorts of *gigantic forms*; such as vast towers and rocks—huge whales and dragons—scenes of battle—and cloudy giants. This class of clouds is the most romantic and strange of all.

Q. *What do the* CUMULO-STRA'TUS *clouds FORETELL?*

A. A *change of weather*; either from fine to rain, or from rain to fine.

Q. *What are* NIMBUS CLOUDS?

A. All clouds from which *rain falls*. Nimbus is the Latin word for "*clouds which bring a storm.*"

Q. *By what particular character may the* NIMBUS (*or rain-cloud*) *be at once* DISTINGUISHED?

A. By the want of a *defined outline*: Its edge is gradually shaded off from the *deep grey mass* into *transparency*.

Q. *What* APPEARANCE *takes place in the* CLOUDS *at the approach of* RAIN?

A. The *cum'ulus* cloud becomes *sta-*

*tionary*, and *cirrus streaks settle upon it*, forming cum'ulo-stratus clouds; *black* at first, but afterwards of a *grey* color.

Q. *Why do CLOUDS gather ROUND MOUNTAIN TOPS?*

A. Because the air (being *chilled* by the cold mountain tops) deposits its vapor there in a *visible form* or cloud.

Q. *What are the USES of CLOUDS?*

A. 1st—They act as *screens*, to arrest the radiation of heat from the earth;  
2dly—They temper the heat of the *sun's rays*; and

3dly—They are the great *store-houses of rain*.

“Radiation of heat,” i. e., the escape of heat, when no *conductor* carries it away.

Q. *Why is WIND said to BLOW UP the CLOUDS?*

A. Because a *dry, warm* wind (which has travelled over seas) having absorbed a large quantity of moisture, deposits some of it in the *visible form of clouds*, as soon as it reaches a *colder* region of air.

Q. *Why does WIND sometimes DRIVE AWAY the CLOUDS?*

A. Because it has travelled over *dry climes* or *thirsty deserts*, and become so *dry*, that it absorbs vapor from the clouds, and causes them to disappear.



Q. *What is the CAUSE of a RED SUN-SET?*

A. The vapor of the air, not being *actually condensed into clouds*, but only on the *point of being condensed*.

Q. *Why is a RED SUN-SET an indication of a FINE DAY to-morrow?*

A. Because the vapors of the earth are *not condensed into clouds*, by the cold of sunset. Our Lord referred to this prognostic in the following words: "When it is evening ye say it will be fair weather, for the sky is red." (Matt. XVI. 2.)

Q. *What is the cause of a coppery YELLOW SUN-SET?*

A. The vapor of the air being *actually condensed into clouds*.

Q. *Why do vapors (NOT ACTUALLY CONDENSED) refract RED rays, while condensed vapor refracts yellow?*

A. Because the beams of light meet with very little resistance; in consequence of which, those rays are bent down to the eye, which require the least refraction, such as *red*.

See figure on p. 126, where it is evident that the *red* ray P A, is less bent, than the yellow and blue rays, P B, P C.

Q. *Why do CONDENSED vapors refract YELLOW rays, whereas vapors not actually condensed refract red?*

A. Because the beams of light meet

with *more resistance* from the condensed vapor; in consequence of which, those rays are bent down to the eye, which are *more refracted* than the red, such as yellow.

See on figure p. 126, where it is evident that the yellow ray, P B, is more bent than the red ray, P A.

Q. *Why is a YELLOW SUN-SET an indication of WET?*

A. Because it shows that the vapors of the air *are already condensed into clouds*; rain, therefore, may be shortly expected.

Q. *What is the cause of a RED SUN-RISE?*

A. Vapor in the upper region of the air *just on the point of being condensed*.

Q. *Why is a RED and LOWERING sky at SUN-RISE an indication of a WET DAY?*

A. Because the higher regions of the air are *laden with vapor* on the very *point of condensation*, which the rising sun cannot disperse. Hence our Lord's observation, "In the morning ye say, it will be foul weather to-day, for the sky is red and lowering." (Matt. xvi. 3.)

Q. *Why is a GREY MORNING an indication of a FINE DAY?*

A. Because only the air *contiguous to the earth* is damp and full of vapor. There are no vapors in the *higher re-*

gions of the air, to bend down to the eye even the red rays of any beam of light.

Q. *What difference (in the state of the air) is required, to make a GREY and RED SUN-RISE?*

A. In a *grey* sun-rise, only that portion of air *contiguous to the earth is filled with vapor*; all the rest is clear and dry. But in a *red* sun-rise the air in the *upper regions* is so full of vapor, that the rising sun cannot disperse it.

Q. *Why is a GREY SUN-SET an indication of WET?*

A. Because it shows that the air on the *surface of the earth* is very *damp at sun-set*; which is a plain proof that the air is *saturated with vapor*; in consequence of which wet may be soon expected: hence the proverb—

“Evening red and morning grey  
Will set the traveller on his way;  
But evening grey and morning red  
Will bring down rain upon his head.”

Q. *What is meant by an AURORA BOREA'LIS, or northern light?*

A. *Luminous clouds* in the *north of the sky* at night-time. Sometimes streaks of blue, purple, green, red, &c., and sometimes flashes of light, are seen.

Q. *What is the cause of the AURORA BOREA'LIS, or northern light?*

A. *Electricity* in the higher regions of the atmosphere.

Q. *Why are there DIFFERENT COLORS in the Aurora Borealis, such as white, yellow, red and purple?*

A. Because the electric fluid passes through *air of different densities*. The most *rarefied air* produces a *white light*; the most *dry air*, *red*; and the most *damp* produces yellow streaks.

Q. *Does the AURORA BOREALIS forebode fine weather or WET?*

A. When its *coruscations are very bright*, it is generally followed by unsettled weather.

Q. *Why does a HAZE round the SUN indicate RAIN?*

A. Because the *haze* is caused by *very fine rain falling in the upper regions of the air*: when this is the case, a *rain of 5 or 6 hours' duration* may be expected.

Q. *Why is a HALO round the MOON a sure indication of RAIN?*

A. Because it is caused by *fine rain, falling in the upper regions of the air*. The *larger* the halo, the *nearer the rain-clouds*, and the sooner may rain be expected.

Q. *What is the cause of a BLACK MIST: and why does it bring WET weather?*

A. The mist is *black*, because it is *overshadowed by dense clouds*; and *wet* weather may be expected, because the air is saturated with vapor.

Q. *Why is MIST sometimes WHITE: and why does a white mist indicate FINE weather?*

A. The mist is *white*, because no *clouds blacken it with their shadow*; and *fine weather* may be expected, because the sky is cloudless.

Q. *Why do we FEEL almost SUFFOCATED in a hot cloudy night?*

A. Because the heat of the earth cannot escape into the upper region of the air; but is pent in by the clouds, and confined to *the surface of the earth*.

Q. *Why do we feel SPRIGHTLY in a clear, bright night?*

A. Because the heat of the earth can readily escape into the upper regions of the air, and is not confined and pent in by *thick clouds*.

Q. *Why do we FEEL DEPRESSED in SPIRITS on a WET, murky DAY?*

A. 1st—Because the air is laden with vapor, and has (proportionally) *less oxygen*.

2dly—The air being lighter than usual, *does not balance the air in our body*; and

3dly—Moist air has a tendency to depress the nervous system.

Q. *What is meant by the "air balancing the air in our body?"*

A. The human body contains air of a given density; if, therefore, we ascend into *rarer air*, or descend into *denser*, the balance is destroyed, and *we feel oppressed*.

Q. *Why do we feel OPPRESSED, if the air around is not of the SAME DENSITY as that in our body?*

A. Because if the air be *more dense* than our body, it will produce a feeling of *oppression*; if it be *less dense*, the air in our body will produce a feeling of *distension*.

Q. *Why do PERSONS, who ASCEND in BALLOONS, FEEL PAIN in their eyes, ears, and chest?*

A. Because the air in the upper regions of the atmosphere is more *rare* than the *air in their bodies*; and (till *equilibrium is restored*) pain will be felt in the more sensitive parts of the body.

More especially in the tympanum of the ear.

Q. *Why do PERSONS, who DESCEND in DIVING-BELLS, FEEL PAIN in their eyes, ears, and chest?*

A. Because the air in the diving-bell is *compressed* by the upward pressure of the water; in consequence of which,

great pain is felt in the more sensitive parts of the body.

The pressure thus caused is sometimes sufficient to *rupture* the membrane of the tympanum, and produce incurable *deafness*.

Q. *Why are PEARL DIVERS very frequently DEAF?*

A. Because the *pressure of the water* against the tympanum of their ears *ruptures* the membrane; and this rupture produces incurable deafness.

Q. *Why does the SEA HEAVE and SIGH, just PREVIOUS to a STORM?*

A. Because the density of the air is *very suddenly diminished*; and (as the density of the air is diminished) its power to transmit sound is diminished also; in consequence of which, the *roar* of the sea is less audible, and seems like heavy sighs.

Q. *Why is the AIR so universally QUIET, just PREVIOUS to a TEMPEST?*

A. Because the air is *suddenly and very greatly rarefied*; and (as the density of the air is diminished) its *power to transmit sound is diminished also*.

Q. *How do you KNOW, that RAREFIED air CANNOT TRANSMIT SOUND so well as dense air?*

A. Because the *sound of a bell, (in the receiver of an air-pump) can scarcely*

*be heard*, after the air has been partially exhausted; and the report of a pistol (fired on a high mountain) would be scarcely audible.

Q. *Why do we FEEL BRACED and LIGHT-HEARTED on a FINE spring or FROSTY morning?*

A. 1st—Because there is *more oxygen* in the air on a fine frosty morning, than there is on a wet day: and

2dly—A brisk and frosty air has a tendency to *brace* the nervous system.

Q. *Why do DOGS and CATS (confined to a room) feel LAZY and DROWSY, at the approach of rain?*

A. 1st—Because the air does not contain *its full proportion of oxygen*; and

2dly—The damp *depresses their nervous system*, and makes them drowsy.

Q. *When SHEEP lie under a HEDGE, and seem unwilling to go to pasture, RAIN is at hand: Explain the reason of this.*

A. 1st—As the air does not contain its full proportion of *oxygen*, they feel uneasy; and

2dly—As the damp air *relaxes their nervous system*, they feel listless and drowsy.

Q. *Why do HORSES neigh, CATTLE low, SHEEP bleat, and ASSES bray, at the approach of rain?*

A. 1st—As the air does not contain



its full proportion of *oxygen*, they feel a *difficulty in breathing*; and

2dly—As damp *relaxes their nerves*, they feel languid and uneasy.

Q. *Mention some OTHER ANIMALS, which indicate the approach of rain in a similar way.*

A. When pigs squeak, as if in great pain—frogs croak with a loud, hoarse noise—owls screech—woodpeckers cry—peacocks scream—guinea-fowls squall—or ducks and geese are unusually noisy, rain is close at hand.

Q. *Why do CANDLES and FIRES burn with a BLUER FLAME in wet weather?*

A. Because the air contains *less oxygen* in wet weather, and therefore, the heat of fire is *less intense*: The flame is *blue*, because the *fuel is not thoroughly consumed*.

Q. *Why do HILLS, &c., appear LARGER in WET weather?*

A. Because the air is *laden with vapor*, which causes the rays of light to *diverge more*; in consequence of which, they produce on the eye *larger images of objects*.

Q. *Why do TREES, &c., in WET weather appear FURTHER OFF than they really are?*

A. Because the fog or mist *diminishes the light* reflected from the object; and

as the object becomes *more dim*, it seems to be *further off*.

Q. *Why do CATS RUB their EARS, when it is likely to rain?*

A. Either because the *air is full of vapor*, and its humidity (piercing between the hair of the cat) *produces an itching sensation*: or more probably, because the air is *overcharged with electricity*.

Q. *How can the ELECTRICITY of air produce a sensation of ITCHING?*

A. If the *air is overcharged with electricity*, the *hair of the cat is overcharged also*; and this makes her feel as if she were *covered with cobwebs*.

Q. *Why does the CAT keep RUBBING herself?*

A. Because her *hair will not lie smooth*, but has a perpetual tendency to become *turgid and ruffled*; so the cat keeps rubbing her coat and ears, to *smooth the hair down*, and brush away the feeling of cobwebs.

Q. *Why do our HEADS and SKIN itch before rain?*

A. Probably because the *air is overcharged with electricity*; and, therefore, a sensation (like that of cobwebs) *irritates the skin*, and produces an itching.

Q. *When the plants called TREFOIL, DANDELION*

LION, PIMPERNEL, &c., FOLD up their leaves, RAIN is always close at hand : Explain this.

A. 1st—The cloudy weather diminishes the *light of the sun* ; and without the stimulus of sun-light, these flowers never open their leaves.

2dly—The vapor of the damp air, insinuating itself into the air-vessels of these delicate plants, causes them to *expand* ; in consequence of which, the leaflets *contract and close*.

All these plants close at sun-set also.

Q. Why do DOORS SWELL in RAINY weather ?

A. Because the *air is filled with vapor*, which (penetrating into the pores of the wood) *forces the parts further apart*, and swells the door.

Q. Why do DOORS SHRINK in DRY weather ?

A. Because the *moisture is absorbed from the wood* ; and, as the particles are *brought closer together*, the size of the door is *lessened*—in other words, the *wood shrinks*.

Q. Why is the AIR filled with offensive SMELLS, just previous to a coming RAIN ?

A. Because the volatile parts which rise from dunghills, sewers, &c., are prevented (by the *vapor of the air*) from *rising* so readily, as when the sun is *shining brightly*.

Q. *Why do FLOWERS smell SWEETER, and STRONGER, just previous to RAIN?*

A. Because the volatile parts which constitute the *perfume* of flowers, are prevented (by the vapor of the air) from *rising*; in consequence of which, they are confined to the lower regions of the atmosphere.

N. B. Many essential oils and other volatile substances, which produce odors in plants, require the presence of *much moisture* for their perfect development.

Q. *Why do HORSES and other animals stretch out their necks, and SNUFF up the AIR, just previous to a fall of RAIN?*

A. Because they *smell the odor of plants and hay*, and delight to snuff in their fragrance.

Q. *Why does SMOKE FALL, when RAIN is at hand?*

A. Because the air is *less dense*, and *cannot buoy up the smoke* so readily as *dry and heavy air*.

Q. *Why do SWALLOWS FLY LOW, when RAIN is at hand?*

A. Because the *insects* (of which they are in pursuit) *have fled from the cold, upper regions of the air*, to the *warm air* near the earth; and, as their *food is low*, the swallows *fly low*.

Q. *Why do these INSECTS seek the lower regions*

of the air in WET weather, more than in FINE weather?

A. Because (in wet weather) the upper regions of the air are colder than the lower; and, as insects enjoy warmth, they seek it near the earth.

Q. Why does a DOWNWARD current of COLD AIR bring RAIN?

A. Because it condenses the warm vapor; which (being condensed) descends in rain.

Q. The proverb says, "A SINGLE MAGPIE in spring, FOUL WEATHER will bring:" Why is this the case?

A. Because in cold, stormy weather, one magpie alone will leave its warm, snug nest in search of food, while the other stays with the eggs, or young ones; but in fine, mild weather (when their brood will not be injured by cold) both the magpies fly out together.

Q. Why is it UNLUCKY for ANGLERS to see a SINGLE MAGPIE in spring?

A. Because when magpies fly abroad singly, the weather is cold and stormy; but, when both birds fly out together, the weather is warm and mild, which is favorable for fishing.

Q. Why do SEA-GULLS fly about the SEA in FINE weather?

A. Because they *live upon the fishes*, which are found *near the surface* of the sea in fine weather.

Q. *Why may we expect STORMY RAINS, when SEA-GULLS assemble on the land?*

A. Because the fishes (on which they live) leave the *surface* of the sea in stormy weather, and are beyond the reach of the *sea-gulls*; in consequence of which, they are obliged to feed on the *worms and larvæ*, which are driven out of the *ground* at such times.

Larvæ, little grubs and caterpillars.

Q. *Why do PETRELS fly to the SEA during a storm?*

A. Because they *live upon sea insects*, which are always to be found in abundance *about the spray of swelling waves*.

N. B. Petrels are birds of the duck-kind, which live in the open sea. They run on the top of the waves, and are called Petrels, or rather Peter-els, from "St. Peter," in allusion to his walking on the sea, to go to Jesus.

Q. *Why do CANDLES and LAMPS SPIRT, when RAIN is at hand?*

A. Because the *air is filled with vapor* which *penetrates the wick*; where (being formed into *steam*) it expands suddenly, and produces a little explosion.

Q. *Why does a DROP of WATER sometimes ROLL along a piece of hot iron, without leaving the least trace?*

A. Because the *bottom* of the drop is turned into *vapor*, which *buoys the drop up*, without allowing it to touch the iron.

Q. *Why does it ROLL?*

A. Because the *current of air* (which is always passing over a heated surface) *drives it along*.

Q. *Why does a LAUNDRESS put a little SALIVA on a FLAT-IRON, to know if it be hot enough?*

A. Because when the saliva *sticks* to the box, and is *evaporated*, she knows it is *not* sufficiently hot; but, when it *runs along the iron*, it is.

Q. *Why is the FLAT-IRON HOTTER if the saliva RUNS ALONG it, than if it adheres till it is evaporated?*

A. Because when the saliva *runs along* the iron, the heat is sufficient to *convert the bottom of the drop into vapor*; but, if the saliva *will not roll*, the iron is *not* sufficiently hot to convert the bottom of the drop into vapor.

---

## CHAPTER XIV.

### 4.—EVAPORATION.

Q. *What is meant by EVAPORATION?*

A. The dissipation of liquid by its conversion into *vapor*.

Q. *What EFFECTS are produced by evaporation?*

A. The liquid vaporized *absorbs heat* from the body whence it issues; and the body *deprived of the liquid* by evaporation, *loses heat*.

Q. *If you WET your FINGER in your mouth, and hold it up in the air, why does it FEEL COLD?*

A. Because the saliva quickly *evaporates*; and (as it evaporates) *absorbs heat from the finger*, making it feel cold.

Q. *If you BATHE your TEMPLES with ether, why does it allay INFLAMMATION and feverish heat?*

A. Because ether very rapidly *evaporates*; and (as it evaporates) *absorbs heat from the burning head*, producing a sensation of cold.

Q. *Why is ETHER better for this purpose than WATER?*

A. Because ether requires *less heat to convert it into vapor*; in consequence of which, it evaporates more *quickly*.

N. B. Ether is converted into vapor with 100° of heat: but water requires 212° of heat to convert it into steam.

Q. *Why does ETHER very greatly RELIEVE a SCALD or BURN?*

A. Because it *evaporates very rapidly*; and (as it evaporates) *carries off the heat of the burn*.

Q. *Why do we FEEL COLD, when we have WET FEET or CLOTHES?*

A. Because the wet of our shoes or



clothes rapidly *evaporates*; and (as it evaporates) *absorbs heat from our body*, which makes us feel cold.

Q. *Why do WET FEET or CLOTHES give us "COLD?"*

A. Because the evaporation *absorbs heat* so abundantly from the surface of our body, that its temperature is *lowered below its natural standard*; in consequence of which, health is injured.

Q. *Why is it DANGEROUS to SLEEP in a DAMP BED?*

A. Because the heat is continually absorbed from the surface of our body, to *convert the damp of the sheets into vapor*; in consequence of which, our animal heat is reduced *below the healthy standard*.

Q. *Why is HEALTH INJURED, when the TEMPERATURE of the BODY is REDUCED below its natural standard?*

A. Because the *balance of the circulation* is destroyed. Blood is driven away from the *external surface* by the *chill*, and thrown upon the *internal organs*, which are *oppressed* by this increased *load of blood*.

Q. *Why do we not feel the same sensation of cold, if we throw a MACINTOSH over our WET CLOTHES?*

A. Because the macintosh (being air tight) *prevents evaporation*; and (as the *wet cannot evaporate*) no heat is absorbed from our bodies.

Q. *Why do NOT SAILORS get COLD, who are frequently wet all day with SEA-WATER?*

A. 1st—Because the *salt* of the sea *retards evaporation*; and (as the heat of their body is drawn off *gradually*) the sensation of cold is prevented.

2dly—The *salt* of the sea acts as a stimulant, and keeps the blood circulating in the skin.

Q. *Why does SPRINKLING a HOT ROOM with water COOL IT?*

A. Because the heat of the room causes a *rapid evaporation of the sprinkled water*: and as the water evaporates, *it absorbs heat from the room*, which cools it.

Q. *Why does WATERING the STREETS and roads COOL THEM?*

A. Because they part with their heat *to promote the evaporation of the water sprinkled on them*.

Q. *Why does a SHOWER of RAIN COOL the AIR in summer-time?*

A. Because the wet earth *parts with its heat to promote evaporation*; and when the *earth* is cooled, it *cools the air* also.

Q. *Why is LINEN DRIED by being exposed to the WIND?*

A. Because the wind *accelerates evaporation*, by removing the vapor from the *surface of the wet linen*, as fast as it is formed.

Q. *Why is LINEN DRIED sooner in the open AIR, than in a confined room?*

A. Because the particles of vapor are more rapidly removed from the surface of the linen by evaporation.

Q. *Why are WET SUMMERS generally SUCCEEDED by COLD WINTERS?*

A. Because the great evaporation (carried on through the wet summer) *reduces the temperature of the earth lower than usual*, and produces cold.

Q. *Why is THIS COUNTRY WARMER and the winters less severe than formerly?*

A. Because it is *better drained and better cultivated*.

Q. *Why does DRAINING land promote WARMTH?*

A. Because it *diminishes evaporation*, in consequence of which, *less heat is abstracted from the earth*.

Q. *Why does CULTIVATION increase the WARMTH of a country?*

A. 1st—Because *hedges and belts of trees* are multiplied :

2dly—The land is *better drained* : and

3dly —The vast *forests are cut down.*

Q. *Why do HEDGES and BELTS of TREES promote WARMTH?*

A. Because they *retard evaporation,* by keeping off the *wind.*

Q. *If belts of trees promote WARMTH, why do FORESTS produce COLD?*

A. 1st—Because they *detain and condense the passing clouds;*

2dly—They prevent the access of both *wind and sun;*

3dly—The soil of forests is always *covered with long, damp grass, rotting leaves, and thick brushwood;* and

4thly—In every forest there are always many hollows *full of stagnant water.*

Q. *Why do LONG GRASS and ROTTING LEAVES promote COLD?*

A. Because *they are always damp,* and evaporation, which they promote, is *constantly absorbing heat* from the earth beneath.

Q. *Why are FRANCE and GERMANY WARMER now, than when the vine would not ripen there?*

A. Chiefly because *their vast forests have been cut down;* and the soil is better *drained and cultivated.*

Q. *What becomes of the WATER of PONDS and TUBS in summer-time?*

A. Ponds and tubs are often left dry in summer-time, because their water is *evaporated by the air*.

Q. *How is this* EVAPORATION PRODUCED *and carried on?*

A. The heat of the air changes the *surface of the water into vapor*, which (blending with the air) *is soon wafted away*; and *similar evaporation* is repeatedly produced, till the pond or tub is left quite dry.

Q. *Why are the* WHEELS *of some machines kept* CONSTANTLY WET *with* WATER?

A. *To carry off* (by evaporation) *the heat* which arises from the *rapid motion* of the wheels.

Q. *Why is* MOULD HARDENED *by the* SUN?

A. Because the moisture of the mould is exhaled by *evaporation*; and, as the earthy particles are brought *closer* together, the mass becomes more solid.

Q. *Show the* WISDOM of GOD *in this arrangement.*

A. If the soil did not become *crusty* and *hard in dry weather*, the heat and drought would *penetrate the soil*, and kill both seeds and roots.

Q. *Why is* TEA cooled FASTER *in a* SAUCER *than in a cup?*

A. Because *evaporation is increased*

by *increasing the surface*; and, as tea in a saucer presents *a larger surface to the air*, its heat is more rapidly carried off by evaporation.

(The subject of "convection" will be treated of in a future chapter; it would scarcely be understood in this place. See p. 213.)

Q. *Why is not the VAPOR of the SEA SALT?*

A. Because the *salt* is always *left behind*, in the process of evaporation.

Q. *What is that WHITE CRUST, which appears (in hot weather) upon CLOTHES wetted by sea water?*

A. The *salt of the water*, left on the clothes by evaporation.

Q. *Why does this WHITE CRUST always DISAPPEAR in WET weather?*

A. Because the *moisture of the air dissolves the salt*; in consequence of which, it is no longer visible.

Q. *Why should NOT persons, who take violent exercise, WEAR very THICK CLOTHING?*

A. Because it prevents the perspiration from evaporating. When the heat of the body is increased by exercise, *perspiration reduces the heat* (by evaporation) *to a healthy standard*; as thick clothing *prevents* this evaporation, it is injurious to health.

## COMMUNICATION OF HEAT.

## CHAPTER XV.

## 1—CONDUCTION.

Q. *How is HEAT COMMUNICATED from one body to another?*

A. 1.—By Conduction. 2.—By Absorption. 3.—By Reflection. 4.—By Radiation. And 5.—By Convection.

Q. *What is meant by CONDUCTION of heat?*

A. Heat communicated from one body to another by *actual contact*.

Q. *Why does a PIECE of WOOD (blazing at one end) NOT feel HOT at the OTHER?*

A. Because *wood is so bad a conductor*, that heat does not traverse freely through it; hence, though one end of a stick be blazing the other end may be quite cold.

Q. *Why do SOME THINGS feel COLDER than others?*

A. Principally because they are *better conductors*; and draw off heat from our body much faster.

Q. *What are the BEST CONDUCTORS of HEAT?*

A. *Dense, solid bodies*, such as metal and stone.

Q. Which METALS are the most RAPID CONDUCTORS of HEAT?

A. The *best* conductors of heat are 1. gold, 2. silver, 3. copper:

The *next* best are 4. plat'inum, 5. iron, 6. zinc, 7. tin. Lead is a very *inferior* conductor to any of the preceding metals.

Q. What are the WORST CONDUCTORS of HEAT?

A. All *light* and *porous bodies*; such as hair, fur, wool, charcoal, and so on.

Two of the *worst* conductors known are hare's fur and eider down;—the two next worst are beaver's fur and raw silk;—then wood and lamp-blaek;—then cotton and fine lint;—then chareoal, wood ashes, &c.

Q. Why are COOKING VESSELS often furnished with WOODEN HANDLES?

A. Because wood is *not* a good conductor, like metal; and, therefore, *wooden handles* prevent the heat of the vessel from rushing into our hands, to burn them.

Q. Why is the HANDLE of a METAL TEA-POT made of WOOD?

A. Because *wood* is a *bad* conductor; therefore, the heat of the boiling water is *not so quickly conveyed* to our hand by a wooden handle, as by one made of metal.

Q. Why would a METAL HANDLE BURN the HAND of the tea-maker?

A. Because metal is an *excellent* conductor; therefore, the heat of boiling wa-



ter would *rush so quickly* into the *metal handle*, that it would burn our hand.

Q. *Prove that a METAL HANDLE would be HOTTER than a WOODEN ONE.*

A. If we *touch the metal collar* into which the wooden handle is fixed, we shall find that the wooden handle *feels cold*, but the metal collar *intensely hot*.

Q. *Why do persons use paper or WOOLLEN KETTLE-HOLDERS?*

A. Because paper and woollen are both very *bad conductors of heat*; in consequence of which, the heat of the kettle does not *readily pass through them* to the hand.

Q. *Does the heat of the boiling kettle NEVER get through the woollen or paper kettle-holder?*

A. Yes; but though the kettle-holder became as hot as the kettle itself, it would never *feel* so hot.

Q. *Why would not the kettle-holder FEEL so hot as the kettle, when both are of the same temperature?*

A. Because it is a very *bad conductor*, and *disposes of its heat too slowly* to be *perceptible*; but metal (being an *excellent conductor*) *disposes of its heat so quickly*, that the sudden influx is painful.

Q. *Why does HOT METAL FEEL MORE intensely WARM than HOT WOOL?*

A. Because metal gives out a much

*greater quantity of heat in the same space of time; and the influx of heat is, consequently, more perceptible.*

Q. *Why does MONEY in our pocket feel very HOT when we stand BEFORE a FIRE?*

A. Because metal is an *excellent* conductor, and becomes rapidly heated. For the same reason, it becomes *rapidly cold*, whenever it comes in contact with a body *colder than itself*.

Q. *Why does a PUMP-HANDLE feel intensely COLD in WINTER?*

A. Because it is an *excellent* conductor, and draws off the heat of our hand so rapidly, that the sudden loss produces a sensation of intense coldness.

Q. *Is the iron HANDLE of the pump really COLDER than the wooden PUMP itself?*

A. No; every inanimate substance (exposed to the same temperature) possesses in reality the *same degree of heat*.

Q. *Why does the IRON HANDLE seem so MUCH COLDER than the WOODEN PUMP?*

A. Merely because the *iron is a better conductor*; and, therefore, *draws off the heat* from our hand more rapidly than wood does.

Q. *Why does a STONE or marble HEARTH feel to the feet COLDER than a CARPET or hearth-rug?*

A. Because *stone and marble are good*

conductors; but *woollen carpets* and *hearth-rugs* are very *bad* conductors.

Q. *How does the STONE HEARTH make our FEET WARM?*

A. As soon as the hearth-stone has absorbed a portion of heat from our foot, it instantly disposes of it, and calls for a *fresh supply*; till the hearth-stone has become of the *same temperature as the foot placed upon it*.

Q. *Do not also the woollen CARPET and HEARTH-RUG conduct heat from the human body?*

A. Yes; but being very *bad* conductors, they convey the heat away so *slowly*, that the loss is scarcely perceptible.

Q. *Is the COLD HEARTH-STONE in reality of the SAME TEMPERATURE as the WARM CARPET?*

A. Yes; every thing in the room is really of *one temperature*; but some things *feel* colder than others, because they are *better conductors*.

Q. *How LONG will the hearth-stone feel cold to the feet resting on it?*

A. Till the *feet* and the *hearth-stone* are *both of the same temperature*; and then the sensation of cold in the hearth-stone will go off.

Q. *Why would not the HEARTH-STONE feel COLD, when it is of the SAME temperature as our FEET?*

A. Because the heat would no longer *rush out of our feet into the hearth-stone*, in order to produce equilibrium.

Q. *Why does the HEARTH-STONE (when the fire is lighted) feel HOTTER than the HEARTH-RUG?*

A. Because the hearth-stone is an *excellent conductor*, and parts with its heat *very readily*; but the woollen hearth-rug (being a *bad conductor*) parts with its heat *very reluctantly*.

Q. *Why does PARTING with HEAT RAPIDLY make the HEARTH-STONE feel WARM?*

A. Because the rapid influx of heat raises the temperature of our body *so suddenly*, that we cannot *help perceiving the increase*.

Q. *Why does the non-conducting power of the HEARTH-RUG prevent its feeling so HOT as it really is?*

A. Because it parts with its heat *so slowly and gradually*, that we scarcely *perceive its transmission* into our feet.

Q. *When we plunge our HANDS into a basin of WATER why does it produce a sensation of COLD?*

A. Because water is a *better conductor* than air; and, as it draws off the heat from our hands *more rapidly*, it *feels colder*.

Q. *Why does the CONDUCTING power of water make it feel COLDER than AIR?*

A. Because it *abstracts heat from our*

*hands so rapidly, that we feel its loss ; but the air abstracts heat so very slowly, that its gradual loss is hardly perceptible.*

Q. *Is water a GOOD CONDUCTOR of heat ?*

A. No ; *no liquid is a good conductor of heat ; but yet water is a much better conductor than air.*

Q. *Why is WATER a BETTER CONDUCTOR of heat than AIR ?*

A. *Because it is less subtile ; and the conducting power of any substance depends upon its solidity, or the closeness of its particles.*

Q. *How do you know that WATER is NOT a GOOD CONDUCTOR of heat ?*

A. *Because it may be made to boil at its surface, without imparting sufficient heat to melt ice a quarter of an inch below the surface.*

Q. *Why are NOT LIQUIDS GOOD CONDUCTORS of heat ?*

A. *Because the heat (which should be transmitted) produces evaporation, and flies off in the vapor.*

Q. *Why does a POKER (resting on a fender) feel COLDER than the HEARTH-RUG, which is further off the fire ?*

A. *Because the poker is an excellent conductor, and draws heat from the hand much more rapidly than the woollen*

hearth-rug, which is a very *bad conductor*: though both, therefore, are *equally warm*, the *poker* seems to be the *colder*. (See also p. 173.)

Q. *Why are HOT BRICKS (wrapped in cloth) employed in cold weather to KEEP the FEET WARM?*

A. Because bricks are *bad conductors* of heat, and cloth or flannel *still worse*: in consequence of which, a hot brick (wrapped in flannel) will *retain its heat a very long time*.

Q. *Why is a TIN PAN (filled with HOT WATER) employed as a FOOT-WARMER?*

A. Because *polished tin* (being a bad radiator of heat) *keeps hot a very long time*; and warms the feet resting upon it.

Q. *What is meant by being a "bad RADIATOR of heat?"*

A. To radiate heat is to *throw off heat by rays*, as the sun; a polished tin pan does *not throw off the heat of boiling water* from its surface, but *keeps it in*.

Q. *Why are TIN FOOT-WARMERS covered with FLANNEL?*

A. 1st—That the *polish* of the tin may not be injured:

2dly—Because the flannel (being a *very bad conductor*) helps to keep the tin hot *longer*: and

3dly—Lest the conducting surface of the tin should *feel painfully hot*.

Q. *What disadvantage would it be, if the POLISH of the tin were injured?*

A. If the tin foot-warmer were to *lose its polish*, it would get cold in a *much shorter time*.

Q. *Why would the tin foot-warmer get COLD SOONER, if the POLISH were INJURED?*

A. Because *polished tin* throws off its heat *very slowly*; but *dull, scratched, painted, or dirty tin*, *throws off its heat very quickly*.

Q. *Why are FURNACES and stoves (where much HEAT is required) built of porous BRICK?*

A. Because bricks are bad conductors, and *prevent the escape of heat*; in consequence of which, they are employed where great heat is required.

Q. *Why are FURNACE DOORS, &c., frequently COVERED with a paste of CLAY and SAND?*

A. Because this paste is a *very bad conductor of heat*; and, therefore, prevents the *escape of heat from the furnace*.

Q. *If a stove be placed in the MIDDLE of a room should it be made of bricks or IRON?*

A. A stove in the *middle of a room* should be made of *iron*; because iron is an *excellent conductor*, and rapidly communicates heat to the air around.

Q. *Why does the Bible say, that God "giveth SNOW like WOOL?"*

A. Because snow (being a *very bad conductor of heat*) protects vegetables and seeds from the frost and cold.

Q. *How does the non-conducting power of SNOW PROTECT VEGETABLES from the FROST and cold?*

A. It prevents the *heat* of the earth from being *drawn off* by the cold air which rests upon it.

Q. *Why are WOOLLENS and FURS used for CLOTHING in COLD weather?*

A. Because they are *very bad conductors* of heat; and, therefore, *prevent the warmth of the body from being drawn off* by the cold air.

Q. *Do not woollens and furs actually IMPART heat to the body?*

A. No; they merely *prevent the heat of the body from escaping*.

Q. *Where would the heat ESCAPE to, if the body were NOT wrapped in wool or fur?*

A. The heat of the body would *fly off* into the air; for the cold air (coming in contact with our body) would *gradually draw away its heat*, till it was as cold as the air itself.

Q. *What then is the PRINCIPAL USE of CLOTHING in winter-time?*

A. 1st—To prevent the animal heat from escaping too freely; and



2dly—To protect the body from the *external air* (or wind), which would carry away its heat too rapidly.

Q. *Why are BEASTS COVERED with FUR, HAIR or WOOL?*

A. Because fur, hair and wool, are *very slow* conductors of heat; and (as dumb animals cannot be clad, like human beings) God has given them *a robe of hair or wool, to keep them warm.*

Q. *Why are BIRDS covered with DOWN or FEATHERS?*

A. Because down and feathers are *very bad* conductors of heat; and (as birds cannot be clad, like human beings) God has given them *a robe of feathers, to keep them warm.*

Q. *Why are WOOL, FUR, HAIR, and FEATHERS, such SLOW CONDUCTORS of heat?*

A. Because a *great quantity of air* lurks entangled between the fibres; and *air* is a *very bad* conductor of heat.

The warmest clothing is that which fits the body *very loosely* in every part except at the *extremities*: Because more hot air will be confined by a *loose* garment than by one which fits the body *tightly*.

Q. *If AIR be a BAD CONDUCTOR of heat, why should we not feel as warm WITHOUT clothing, as when we are wrapped in wool and fur?*

A. Because the air (which is cooler than our body) is *never at rest*; and

every fresh particle of air *draws off a fresh portion of heat.*

Q. *How does the ceaseless CHANGE of air tend to DECREASE the WARMTH of a naked body?*

A. Thus:—the air (which cases the body) absorbs as much heat from it as it can, while it remains in contact; being then blown away, it makes room for a *fresh coat of air*, which absorbs *more* heat.

Q. *Does the AIR which encases a naked body become (by contact) as WARM as the BODY itself?*

A. It would do so, if it remained *motionless*; but, as it remains only a *very short time*, it absorbs as much heat as it can in the time, and passes on.

Q. *Why do we feel COLDER in WINDY WEATHER than in a CALM day?*

A. Because the particles of air *pass over us more rapidly*; and every *fresh* particle takes from us *some* portion of heat.

Q. *Show the wisdom of God in making the AIR a BAD CONDUCTOR.*

A. If air were a *good conductor* (like iron and stone) heat would be drawn so *rapidly from our body*, that we should be *chilled to death*. Similar evils would be felt also by *all* the animal and vegetable world.

Q. *Does not the bad conducting power of air*

enable persons to judge whether an EGG be NEW or STALE?

A. Yes; touch the larger end of the shell with your tongue; if it *feels warm*, the egg is stale; if *not*, it is new-laid.

Q. Why will the SHELL of a STALE EGG feel WARM to the tongue?

A. Because the thick end of an egg contains *a small quantity of air* (between the shell and the white); when the egg is stale the white *shrinks*, and the confined *air* accordingly *expands*.

Q. Why does the expansion of air (at the end of an egg) make it feel WARM to the tongue?

A. Because air is a very bad conductor, and the more *air* an egg contains, the *less heat will be drawn from the tongue* when it touches the shell.

Q. Why will a NEW-LAID egg feel COLDER to the tongue at the thick end than a stale one?

A. Because it contains *more white* and *less air*; and as the *white* of an egg is a better conductor than *air*, the heat of the tongue will be drawn off *more rapidly*, and the egg feel *colder*.

Q. Why does FANNING the face in summer make it COOL?

A. Because the fan *puts the air in motion*, and makes it pass *more rapidly over the face*; and (as the temperature of

the *air is always lower* than that of the human face) each puff of air carries off some portion of its heat.

Q. Does FANNING make the AIR itself COOLER?

A. No ; fanning makes the air hotter and hotter.

Q. How does FANNING the face increase the HEAT of the air?

A. By driving the air more rapidly over the human body, and causing it, consequently, to absorb more heat.

Q. If fanning makes the AIR HOTTER, why can it make a PERSON feel COOLER?

A. Because it takes the heat out of the face, and gives it to the air.

Q. Why is BROTH COOLED by BLOWING it?

A. Because the breath causes a rapid change of air to pass over the broth ; and (as the air is colder than the broth) it continually absorbs heat from it, and makes it cooler and cooler.

Q. Would not the air absorb heat from the broth just as well WITHOUT BLOWING?

A. No ; air is a very bad conductor ; unless, therefore, the change be rapid, the air nearest the surface of the broth would soon become as hot as the broth itself.

Q. Would not hot air PART with its heat instantly to the CIRCUMJACENT air?

A. No ; not instantly. Air is so bad

a conductor, that it parts with its heat *very slowly*: unless, therefore, the air be kept in *continual motion*, it would *cool the broth very slowly indeed*.

Q. *Why does WIND generally feel COOL?*

A. Because it drives the air more rapidly over our body; and this rapid *change* of air draws off a large quantity of heat.

Q. *Why does AIR ABSORB heat more QUICKLY by being set in MOTION?*

A. Because every fresh gust of air *absorbs a fresh portion of heat*; and the more rapid the *succession of gusts*, the greater will be the quantity of heat absorbed.

Q. *If the AIR were HOTTER than our body would the WIND feel COOL?*

A. No; the air would feel *insufferably hot*, if it were *hotter than our body*.

Q. *Why would the AIR feel INTENSELY HOT, if it were WARMER than our BODY?*

A. Because it would *add* to the heat of our body, instead of *diminishing* it.

Q. *Is the AIR EVER as HOT as the human BODY?*

A. Not in *this* country: in the hottest summer's day, the air is at least 10 or 12 degrees *cooler than the human body*.

Q. *Is the EARTH a good conductor of heat?*

A. No ; the earth is a very *bad* conductor of heat.

Q. *Why is the EARTH a BAD conductor of heat ?*

A. Because its particles are not *continuous* : and the power of *conducting* heat depends upon the *continuity of matter*.

Q. *Why is the earth (BELOW the SURFACE) WARMER in WINTER than the surface itself ?*

A. Because the earth is a *bad* conductor of heat ; and, therefore, (although the ground be frozen,) the frost never penetrates more than a *few inches below the surface*.

Q. *Why is the earth (BELOW the SURFACE) COOLER in SUMMER than the surface itself ?*

A. Because the earth is a *bad* conductor of heat ; and, therefore, (although the *surface be scorched* with the burning sun,) the intense heat cannot penetrate to the *roots* of the plants and trees.

Q. *Show the WISDOM of GOD in making the EARTH a BAD CONDUCTOR ?*

A. If the *heat and cold could penetrate the earth* (as freely as the heat of a fire penetrates iron), the springs would be dried up in summer, and frozen in winter ; and all vegetation would perish.

Q. *Why is WATER from a SPRING always COOL even in SUMMER?*

A. Because the earth is so *bad a conductor*, that the burning rays of the sun can penetrate only a few inches below the surface; in consequence of which, the *springs of water are not affected* by the heat of summer.

Q. *Why is it COOL under a SHADY tree in a hot summer's day?*

A. 1st—Because the overhanging foliage screens *off the rays of the sun*:

2dly—As the rays of the sun are *warded off*, the air (beneath the tree) is not heated by the *reflection of the earth*: and

3dly—The leaves of the trees, being *non-conductors*, allow no heat to penetrate them.

Q. *Why do the LAPLANDERS wear SKINS with the FUR INWARDS?*

A. Because the *dry skin* prevents the *wind* from penetrating to their body; and the *air* (between the hairs of the fur) soon becomes *heated by the body*: in consequence of which, the Laplander in his fur is clad in *a case of hot air*, *imperious to the cold and wind*.

Q. *Why does a LINEN SHIRT feel COLDER than a COTTON ONE?*

A. Because *linen* is a *much better*

*conductor* than cotton; and, therefore, (as soon as it touches the body) it draws away the heat *more rapidly*, and produces a greater sensation of cold.

Q. *Why is the FACE COOLED by wiping the temples with a fine CAMBRIC HANDKERCHIEF?*

A. Because the fine fibres of the cambric have a *strong capillary attraction for moisture*, and are *excellent conductors* of heat: in consequence of which, the moisture and heat are *abstracted from the face* by the cambric, and a sensation of coolness produced.

“Capillary attraction,” i. e., *the attraction of a thread or hair*. The wick of a candle is wet with grease, because the melted tallow runs up the cotton from capillary attraction.

Q. *Why would not a COTTON handkerchief do as well?*

A. Because the coarse fibres of cotton have very little capillary attraction, and are *very bad conductors*; in consequence of which, the heat of the face would be *increased* (rather than *diminished*) by the use of a *cotton handkerchief*.



## CHAPTER XVI.

## 2.—ABSORPTION OF HEAT.

Q. *What is the difference between CONDUCTING heat, and ABSORBING heat?*

A. To *conduct* heat is to *transmit it* from one body to another through a *conducting* medium. To *absorb* heat is to *suck it up*, as a sponge sucks up water.

Q. *Give me an example.*

A. *Black cloth absorbs*, but does not *conduct heat*; thus, if black cloth be laid in the sun, it will *absorb the rays* very rapidly; but if *one end* of the black cloth be made hot, it would not *conduct the heat* to the *other end*.

Q. *Are good CONDUCTORS of heat good ABSORBERS also?*

A. No; every *good conductor* of heat is a *bad absorber* of it; and *no good absorber* of heat can be a *good conductor* also.

Q. *Is IRON a good ABSORBER of heat?*

A. No; *iron* is a *good conductor*, but a very *bad absorber* of heat.

Q. *Why do the FIRE-IRONS (which lie upon a FENDER) remain COLD, although they are before a good fire?*

A. Because they are *bad absorbers* of

heat; in consequence of which, they remain *cold*, unless they come in *contact* with the stove or fire.

Q. *Why are the FIRE-IRONS intensely HOT, when they REST AGAINST the STOVE which contains a good fire?*

A. Because they are *excellent conductors of heat*, and draw it rapidly from the stove with which they are in contact.

Q. *Why does a KETTLE boil faster, when the bottom and back are COVERED with SOOT?*

A. Because the *black soot absorbs heat* very quickly from the fire, and the metal *conducts* it to the water.

Q. *Why will not a NEW KETTLE boil so fast as an OLD one?*

A. Because the *bottom and sides* of a new kettle are *clean and bright*: but in an *old* kettle they are *covered with soot*.

Q. *Why will a KETTLE be SLOWER BOILING if the BOTTOM and BACK are CLEAN and bright?*

A. Because *bright metal does not absorb heat, but reflects it*; and (as the heat is *thrown off* from the surface of *bright* metal by reflection) therefore, a new kettle takes a longer time to boil.

Reflects heat, i. e., throws it off.

Q. *Why do we wear WHITE LINEN and a BLACK outer DRESS, if we want to be warm?*

A. Because the *black outer dress*

quickly *absorbs heat* from the sun ; and the *white linen* (being a *bad* absorbent) abstracts no heat from the warm body.

Q. *Why do persons WEAR WHITE dresses in SUMMER time?*

A. Because white *throws off the heat* of the sun by *reflection*, and is a very bad absorbent of heat ; in consequence of which, white dresses never become so hot from the *scorching sun* as dark colors do.

Q. *Why do NOT persons WEAR WHITE dresses in WINTER time?*

A. Because *white will not absorb heat*, like black and other dark colors ; and, therefore, *white dresses are not so warm as dark ones*.

Q. *What COLORS are WARMEST for dresses?*

A. For *outside garments black* is the warmest, and then such colors as approach nearest to black, (as dark blue and green.) *White is the coldest color* for external clothing.

Q. *Why are DARK COLORS (for external wear) so much WARMER than LIGHT ONES?*

A. Because *dark colors absorb heat* from the sun more abundantly than *light ones*.

Q. *How can you prove that DARK colors are WARMER than LIGHT ones?*

A. If a piece of *black* and a piece of *white* cloth were laid upon snow, in a few hours the *black cloth will have melted the snow beneath*; whereas, the *white* cloth will have produced little or *no effect upon it at all*.

N. B. The *darker* any color is, the *warmer* it is, because it is a better absorbent of heat. The order may be thus arranged:—1.—Black (warmest of all) —2. Violet.—3. Indigo.—4. Blue.—5. Green.—6. Red.—7. Yellow: and 8. White (coldest of all).

Q. *Why are BLACK KID GLOVES unpleasantly HOT for summer wear?*

A. 1st—Because *black absorbs the solar heat*; and

2dly—*Kid* will not allow the heat of our hand to *escape through the glove*.

Q. *Why are LISLE THREAD GLOVES agreeably COOL for summer wear?*

A. 1st—Because thread *absorbs perspiration*: and

2dly—It *conducts away the heat* of our hot hands.

Q. *Are Lisle thread gloves ABSORBENTS of heat?*

A. No; Lisle thread gloves are generally of a *grey or lilac color*; and, therefore, do *not absorb solar heat*.

Q. *Why is a PLATE-WARMER made of UNPAINTED BRIGHT TIN?*

A. Because bright tin *reflects the heat*

(which issues from the fire in rays) upon the meat; and, therefore, greatly assists the process of roasting.

Reflects the heat, i. e., throws it *back* upon the meat.

Q. *Why would not the tin REFLECTOR do as well, if it were PAINTED?*

A. Because it would then *absorb* heat, and *not reflect it at all*. A plate-warmer should never be *painted*, but should be kept *very clean, bright, and free from all scratches*.

Q. *Why should a REFLECTOR be kept so very CLEAN and free from all SCRATCHES?*

A. Because if a reflector were *spotted, dull, or scratched*, it would *absorb* heat, instead of *reflecting* it; and, consequently, would be of no use whatsoever as a *reflector*.

Q. *Why does HOAR FROST remain on TOMB-STONES long after it has melted from the GRASS and GRAVEL-WALKS of a church-yard?*

A. Because tomb-stones (being *white*) will *not absorb heat*, like the darker grass and gravel; in consequence of which, they remain too *cold* to thaw the frost congealed upon their surface.

Q. *If black absorbs heat, why have those who live in HOT climates BLACK SKINS, and not WHITE skins, which would not absorb heat at all?*

A. Because *black* will not *blister* from

the heat of the sun. Although, therefore, the black skin of the negro *absorbs heat* more plentifully than the *white skin of a European*; yet the *blackness* prevents the sun from *blistering* or *scorching* it.

Q. *How is it known that the BLACK color prevents the sun from either BLISTERING or SCORCHING the skin?*

A. If you put a *white glove* on one hand, and a *black glove* on the other (when the sun is burning hot), the hand with the *white glove* will be *scorched*, but *not the other*.

Q. WHICH hand will FEEL the HOTTER?

A. The hand with the *black glove* will *feel* the *hotter*, but will not be *scorched* by the sun; whereas, the hand with the *white glove* (though much *cooler*) will be *severely scorched*.

Q. *Why does the BLACK skin of a NEGRO NEVER SCORCH or BLISTER with the hot sun?*

A. Because the *black color* *absorbs* the heat—conveys it *below the surface* of the skin—and converts it to *sensible heat* and *perspiration*.

Q. *Why does the WHITE EUROPEAN SKIN BLISTER and SCORCH when exposed to the hot sun?*

A. Because *white* will not *absorb* heat; and, therefore, the hot sun *rests on the surface of the skin*, and *scorches* it.

Q. *Why has a NEGRO BLACK EYES?*

A. Because the black color defends them from the strong light of the tropical sun. If a negro's eyes were not black, the sun would *scorch them*, and every negro would be blind.

Q. *Why is WATER (in hot weather) KEPT COOLER in a BRIGHT TIN POT than in an EARTHEN one?*

A. Because bright metal will *not absorb* heat from the hot air, like an *earthen* vessel; in consequence of which, the water is kept *cooler*.

Boiling water is also kept *hot* in bright metal better than in earthen vessels. *See p. 187.*

---

## CHAPTER XVII.

### 3.—REFLECTION OF HEAT.

Q. *What is meant by REFLECTING HEAT?*

A. To reflect heat is *to throw it back in rays* from the surface of the reflecting body towards the place whence it came.

Q. *What are the BEST REFLECTORS of heat?*

A. All *bright* surfaces and *light colors*.

Q. *Are GOOD ABSORBERS of heat GOOD REFLECTORS also?*

A. No; those things which *absorb* heat *best*, *reflect* heat *worst*; and those which *reflect* heat *worst*, *absorb* it *best*.

Q. *Why are those things which ABSORB HEAT unable to REFLECT it?*

A. Because if anything *sucks in* heat like a sponge, it cannot *throw it off* from its surface; and if anything *throws off* heat from its surface, it cannot *drink it in*.

Q. *Why are REFLECTORS always made of LIGHT COLORED and highly POLISHED METAL?*

A. Because *light* colored and *highly polished metal* makes the best of all reflectors.

Q. *Why do not PLATE-WARMERS BLISTER and scorch the WOOD behind?*

A. Because the bright tin front throws the heat of the fire *back* again, and will not allow it to penetrate to the wood behind.

Q. *If metal be such an excellent CONDUCTOR of heat, how can it REFLECT heat, or throw it off?*

A. Polished metal is a *conductor of heat*, only when that heat is communicated by *actual contact*: But whenever heat falls upon bright metal *in rays*, it is *reflected back* again, and the metal remains *cool*.

Q. *What is meant "by heat falling upon metal IN RAYS," and not "by contact?"*



A. If a piece of metal were thrust *into* a fire, it would be *in actual contact with the fire*; but if it were *held before a fire*, the heat of the fire would fall upon it *in rays*.

Q. *What is the use of the TIN SCREEN or REFLECTOR used in ROASTING?*

A. It *throws the heat of the fire back upon the meat*; and, therefore, both *assists the process of roasting*, and helps to *keep the kitchen cool*.

Q. *How does a tin REFLECTOR tend to keep the KITCHEN COOL?*

A. By *confining the heat of the fire to the hearth*, and preventing its dispersion throughout the kitchen.

Q. *Why are SHOES HOTTER for being DUSTY?*

A. Because dull, dusty shoes will *absorb heat* from the sun, earth, and air; but shoes brightly polished *throw off* the heat of the sun by reflection.

Q. *Why does it always FREEZE on the TOP of a MOUNTAIN?*

A. 1st—Because the air on a mountain is very *rarefied*; and rarefied air retains more heat in the *latent* form than *denser* air does: and

2dly—Air is heated by the *reflection of the earth*, and not by solar rays; therefore a mountain-top (which is *deprived of this reflection*) remains intensely cold.

## CHAPTER XVIII.

## 4.—RADIATION.

Q. *What is meant by* RADIATION?

A. Radiation means *the emission of rays*: thus the sun radiates both light and heat; that is, it emits *rays of light and heat* in all directions.

Q. *WHEN is heat* RADIATED *from one body to another?*

A. When the two bodies are *separated by a non-conducting medium*: thus the sun *radiates* heat towards the earth, because the *air* (which is a very bad conductor) *comes between*.

Q. *On WHAT does* RADIATION *DEPEND?*

A. On the *roughness* of the radiating surface: thus, if metal be *scratched*, its radiating power is increased; because the *heat has more points to escape from*.

Q. *Does a* FIRE *RADIATE heat?*

A. Yes; and because *burning fuel emits rays of heat*, therefore we *feel warm* when we stand before a fire.

Q. *Why does our* FACE *FEEL uncomfortably HOT when we approach a* FIRE?

A. Because the fire radiates heat upon the face; which (not being covered) feels the effect immediately.

Q. *Why does the fire catch the FACE more than it does the REST of the body?*

A. Because the *rest* of the body is covered with clothing; which (being a *bad* conductor of heat) prevents the same sudden and rapid transmission of heat to the skin.

Q. *Do those substances which RADIATE heat ABSORB heat also?*

A. Yes. Those substances which radiate most, also absorb most heat; and those which radiate least, also absorb the least heat.

Q. *Does anything ELSE radiate heat BESIDES the SUN and FIRE?*

A. Yes: *all* things radiate heat in some measure, but *not equally well*.

Q. *WHAT things RADIATE heat the NEXT BEST to the sun and fire?*

A. All *dull* and *dark* substances are good radiators of heat; but all *light* and *polished* substances are *bad radiators*.

Q. *Why should the FLUES (connected with stoves, &c.) be always BLACKENED with BLACK LEAD?*

A. In order that the heat of the flue may be more readily *diffused* throughout the room. Black lead radiates heat more freely than any other known substance.

In heating a room with *steam* it would be absurd to use *black pipes* for conveying the steam, because they would tend to *cool* the hot vapor.

Q. *Why does a POLISHED METAL TEA POT make BETTER TEA than a black earthen one?*

A. Because polished metal (being a very bad radiator of heat) keeps the water hot much longer; and the hotter the water is, the better it "draws" the tea.

Q. *Why will not a DULL BLACK TEA-POT make good tea?*

A. Because the heat of the water flies off so quickly through the dull black surface of the tea-pot, that the water is very rapidly cooled, and cannot "draw" the tea.

Q. *Do not pensioners and aged cottagers generally prefer the little BLACK EARTHEN TEA-POT to the bright METAL one?*

A. Yes; because they set it on the hob "to a draw;" in which case, the little black tea-pot will make the best tea.

Q. *Why will a BLACK TEA-POT make better tea than a bright metal one, if it be set upon the HOB to DRAW?*

A. Because the black tea-pot will absorb heat plentifully from the fire, and keep the water hot: whereas, a bright metal tea-pot (set upon the hob) would throw off the heat by reflection.

Q. *Then sometimes a BLACK EARTHEN tea-pot is the best, and sometimes a bright metal one?*

A. Yes; when a tea-pot is set on the

*hob "to draw," black earth is the best, because it absorbs heat : But, when a tea-pot is not set on the hob, bright metal is the best ; because it radiates heat very slowly, and therefore keeps the water hot.*

Q. *Why does a SAUCEPAN which has been USED boil in a shorter time than a NEW ONE ?*

A. *Because the bottom and back are covered with soot ; and black soot rapidly absorbs the heat of the glowing coals.*

Q. *Why should the FRONT and LID of a SAUCEPAN be clean and BRIGHT ?*

A. *Because they cannot absorb heat, as they do not come in contact with the fire ; and (being bright) they will not suffer the heat to escape by radiation.*

Q. *In what state should a SAUCEPAN be in order that it may BOIL QUICKLY ?*

A. *All those parts which come in contact with the fire, should be covered with soot, in order to absorb heat ; but all the rest of the saucepan should be as bright as possible, to prevent the escape of heat by radiation.*

Q. *Why should NOT the BOTTOM and BACK of a kettle be CLEANED and polished ?*

A. *Because, they come in contact with the fire, and (while they are covered with*

black soot) *absorb heat freely* from the burning coals.

Q. *Why should the FRONT and TOP of a kettle be CLEAN and well polished?*

A. Because polished metal *will not radiate heat*; and, therefore, (while the front and top of the kettle are well polished) *the heat is kept in*, and not suffered to escape by radiation.

Q. *Why is the BOTTOM of a KETTLE nearly COLD when the WATER is BOILING HOT?*

A. Because black soot is a very *bad conductor of heat*; and, therefore, the heat of the boiling water is some time before it gets *through the soot* which adheres to the bottom of the kettle.

Q. *Why is the LID of a KETTLE intensely HOT when the water boils?*

A. Because the bright metal lid is an *admirable conductor*; and, therefore, *the heat from the boiling water pours into our hand* the moment we touch it.

Q. *Show the benefit of SMOKE in COOKING?*

A. The carbon of the fuel (which flies off in smoke) naturally *blackens* all culinary vessels set upon the fire to boil, and thus renders them fit for use.

“Culinary vessels” are vessels used in kitchens for cooking, as saucepans, boilers, kettles, &c., (from the Latin word “Culina,” a kitchen.)

Q. *How does SMOKE make culinary vessels FIT for USE?*

A. By absorbing heat. If it were not for the *smoke* (which gathers round a kettle or saucepan) *heat would not be absorbed*, and the process of boiling would be greatly retarded.

Q. *Why is boiling water KEPT HOT in a BRIGHT METAL pot better than in an earthen vessel?*

A. Because bright metal (being a *bad radiator*) will not *throw off from its surface* the heat of the boiling water.

Q. *Would a metal pot serve to keep water hot if it were DULL and DIRTY?*

A. No. It is the bright *polish* of the metal which makes it a *bad radiator*: if it were *dull, scratched, or dirty*, the heat would *escape* very rapidly.

Water in hot weather is also kept *cooler* in bright metal than in *dull* or earthen vessels. *See p. 179.*

Q. *Why are DINNER-COVERS made of BRIGHT TIN or SILVER?*

A. Because light-colored and highly-polished metal is a *very bad radiator of heat*; and, therefore, bright tin or silver will not allow the heat of the cooked food to *escape through the cover by radiation*.

Q. *Why should a MEAT-COVER be very brightly POLISHED?*

A. To prevent the heat of the food

from escaping by *radiation*. If a meat-cover be *dull* or *scratched*, it will *absorb heat from the food beneath*; and (instead of keeping it *hot*) *make it cold*.

Q. *Why should a SILVER MEAT-COVER be PLAIN and not CHASED?*

A. Because a *chased* meat-cover would *absorb heat from the food*; and (instead of *keeping it hot*) *make it cold*.

Q. *What is DEW?*

A. Dew is the *vapor of the air condensed* by coming in contact with bodies *colder than itself*.

Q. *Why is the GROUND sometimes COVERED with DEW?*

A. Because the surface of the earth (at sun-set) is made so very *cold* by radiation, that the warm vapor of the air is *chilled* by contact, and condensed into dew.

Q. *Why is the EARTH made colder than the AIR after the sun has set?*

A. Because the *earth radiates* heat very freely, but the air does not; in consequence of which, the earth is often 5 or 10 degrees colder than the air (after sun-set); although it was much *warmer* than the air, during the whole day.

Q. *Why is the EARTH WARMER than the AIR during the day?*



A. Because the earth *absorbs* solar heat very freely, but the air does not; in consequence of which, it is often many degrees warmer than the air, during the day.

Q. *Why is the surface of the GROUND COLDER in a FINE clear NIGHT than in a CLOUDY one?*

A. Because, on a fine, clear star-light night, *heat radiates from the earth freely*, and is lost in open space: but on a *dull* night, the clouds *arrest the process of radiation*.

Q. *Why is DEW deposited only on a FINE, clear NIGHT?*

A. Because the *surface of the ground radiates heat most freely* on a fine night; and (being cooled down by this loss of heat) *chills the vapor of the air into dew*.

Q. *Why is there NO DEW on a dull, CLOUDY NIGHT?*

A. Because the clouds *arrest the radiation of heat from the earth*; and (as the heat cannot freely escape) the surface is not sufficiently cooled down *to chill the vapor of the air into dew*.

Q. *Why is a CLOUDY NIGHT WARMER than a FINE one?*

A. Because the clouds *prevent the radiation of heat from the earth*; in consequence of which, the surface of the earth remains *warmer*.

Q. *Why is DEW most ABUNDANT in situations most EXPOSED ?*

A. Because the radiation of heat is *not arrested* by houses, trees, hedges, or any other thing.

Q. *Why is there scarcely any DEW under a shady TREE ?*

A. 1st—Because the shady head of a tree *arrests the radiation of heat from the earth* : and

2dly—A leafy tree radiates some of its own heat *towards the earth* ; in consequence of which, the ground underneath a tree is not sufficiently cooled down to chill the vapor of the air into dew.

Q. *Why is there never much DEW at the foot of WALLS and HEDGES ?*

A. 1st—Because they act as screens, *to arrest the radiation of heat from the earth* : and

2dly—They themselves *radiate some portion of heat* towards the earth ; in consequence of which, the ground at the foot of walls and hedges is not sufficiently *cooled down*, to chill the vapor of the air into dew.

Q. *Why is there little or NO DEW beneath a FLOWER-AWNING, although that awning be open on all four sides ?*

A. 1st—Because the awning *arrests*

the radiation of heat from the *ground* beneath: and

2dly—It *radiates* some of its own heat *downwards*; in consequence of which, the ground beneath an awning is not sufficiently cooled down, to chill the vapor of air into dew.

Q. *How can a thin covering of BASS or even MUSLIN protect trees from FROST?*

A. Because *any covering* prevents the radiation of heat from the tree; and if trees are *not cooled down* by radiation the vapor of the air will *not be frozen*, as it comes in contact with them.

Bass pronounce bas—a kind of matting used by gardeners.

Q. *Why is the BASS or CANVASS itself (which covers the tree) always DRENCHED with DEW?*

A. Because it *radiates heat* both *upwards* and *downwards*; in consequence of which, it is *so cooled down* that it readily *chills the vapor* of the air into dew.

Q. *Why does SNOW (at the foot of a HEDGE or WALL) melt sooner than that in an open field?*

A. Because the hedge or wall *radiates heat into the snow beneath*, which melts it.

Q. *Why is there NO DEW after a WINDY NIGHT?*

A. 1st—Because the wind *evaporates*

*the moisture*, as fast as it is deposited.  
and

2dly—It *disturbs the radiation of heat* ;  
and thus diminishes the deposition of  
dew.

Q. *Why are VALLEYS and HOLLOWs often  
thickly covered with DEW, although they are sheltered?*

A. Because the surrounding hills  
prevent the *repose* of air from being *dis-  
turbed* ; but do not *overhang* and *screen*  
the valleys sufficiently to *arrest* their ra-  
diation.

Q. *Why does DEW fall more ABUNDANTLY on  
SOME THINGS than on OTHERS?*

A. Because some things radiate heat  
*more freely* than others ; and, therefore,  
become *much cooler* in the night.

Q. *Why are things which RADIATE HEAT  
MOST FREELY always the most THICKLY COVERED  
with DEW?*

A. Because the vapor of the air is  
*chilled into dew*, the moment it comes in  
contact with them.

Q. *WHAT kind of things RADIATE HEAT most  
FREELY?*

A. Grass, wood, and the leaves of  
plants, radiate heat *very freely* : but pol-  
ished metal, smooth stones, and woollen  
cloth, part with their heat *very tardily*.

Q. *To the leaves of ALL plants radiate heat  
EQUALLY WELL?*

A. No. Rough, *woolly leaves* (like those of a holly-hock) radiate heat much *more freely* than the *hard, smooth, polished leaves* of a common laurel.

Q. Show the WISDOM of GOD in making grass, the leaves of trees, and ALL VEGETABLES, EXCELLENT RADIATORS of heat?

A. As vegetables *require much moisture*, and would often *perish* without a plentiful deposit of dew, God wisely made them to *radiate heat freely*, so as to *chill the vapor* (which touches them) *into dew*.

Q. Will *polished METAL, smooth STONES, and woollen CLOTH, readily collect DEW*?

A. No. While grass and the leaves of plants *are completely drenched with dew* a piece of *polished metal*, or of *woollen cloth* (lying on the same spot), will be *almost dry*.

Q. Why would *POLISHED METAL and WOOLLEN CLOTH be DRY, while grass and leaves are drenched with DEW*?

A. Because the polished metal and woollen cloth *part with their heat so slowly*, that the vapor of the air is *not chilled into dew* as it passes over them.

Q. Why is a *GRAVEL WALK almost DRY, when a grass plat is covered thick with DEW*?

A. Because *grass is a good radiator*

and throws off its heat very *freely*; but *gravel* is a *very bad radiator*, and parts with its heat very slowly.

Q. *Is that the reason why GRASS is SATURATED with DEW, and the GRAVEL is NOT?*

A. Yes. When the vapor of warm air comes in contact with the *cold grass*, it is instantly chilled into dew; but it is *not so freely condensed* as it passes over gravel, because gravel is not so *cold* as the grass.

Q. *Why does DEW rarely fall upon hard ROCKS and BARREN lands?*

A. Because rocks and barren lands are so *compact and hard*, that they can neither *absorb nor radiate much heat*; and (as their *temperature varies but very little*) very little *dew* distils upon them.

Q. *Why does DEW fall more abundantly on CULTIVATED soils than on BARREN lands?*

A. Because cultivated soils (being *loose and porous*) very *freely radiate* by night the heat which they absorbed by day; in consequence of which, they are *much cooled down*, and plentifully *condense* the vapor of the passing air *into dew*.

Q. *Show the WISDOM of GOD in this arrangement.*

A. Every plant and inch of land,

which *needs* the moisture of dew, is adapted to *collect* it; but *not a single drop* is *wasted* where its refreshing moisture is *not required*.

Q. Show the advantage to us in having polished METAL and woollen CLOTH BAD RADIATORS of heat.

A. If polished metal collected dew as easily as grass, it *could never be kept dry* and *free from rust*. Again, if woollen garments collected dew as readily as the leaves of trees, we should be *often soaking wet*, and subject to *constant colds*.

Q. Show how this affords a beautiful illustration of GIDEON'S MIRACLE, recorded in the book of Judges, VI. 37, 38.

A. The *fleece of wool* (which is a very *bad* radiator of heat) was *soaking wet* with dew, when the *grass* (which is a most *excellent* radiator) was *quite dry*.

Q. Was not this CONTRARY to the laws of NATURE?

A. Yes; and was, therefore, a plain *demonstration* of the *power of God*, who could thus change the very *nature of things* at his will.

Q. Why do our CLOTHES FEEL DAMP, after walking in a fine evening in SPRING or AUTUMN?

A. Because the vapor (condensed by the cold earth) lights upon them like dew.

Q. *Why are WINDOWS often covered with thick MIST, and the frames wet with standing WATER?*

A. Because the temperature of the *external air* always *falls* at sunset, and *chills* the *window-glass* with which it comes in contact.

Q. *How does this account for the MIST and WATER on a WINDOW?*

A. As the warm vapor of the room *touches* the *cold glass* it is *chilled* and *condensed* into *mist*; and the mist (collecting into drops) *rolls down* the window-frame in little streams of water.

Q. *Does the GLASS of a window COOL down more RAPIDLY than the AIR of the room itself?*

A. Yes; because the air is *kept warm by fires*, and by the *animal heat* of the people in the room; in consequence of which, the air of a room suffers *very little* diminution of heat from the setting of the Sun.

Q. *Whence arises the VAPOR of a ROOM?*

A. 1st—The very *air* of the room contains *vapor*:

2dly—The *breath* and *insensible perspiration* of the inmates *increase* this vapor: and

3dly—*Hot dinners*, the *steam of tea*, and so on, *increase it* still more.



Q. *What is meant by "the INSENSIBLE PERSPIRATION?"*

A. From every part of the human body, an *insensible* and *invisible perspiration* issues all night and day; not only in the hot weather of *summer*, but also in the coldest day of *winter*.

Q. *If the perspiration be both INSENSIBLE and INVISIBLE, how is it KNOWN that there IS any such perspiration?*

A. If you put your naked arm into a *clean, dry glass tube*, the *perspiration* will *condense* on the glass like mist.

Q. *Why are CARRIAGE WINDOWS very SOON covered with thick MIST?*

A. Because the warm vapor of the carriage is *condensed* by the *cold glass*, and covers it with a thick mist.

Q. *WHY is the glass window COLD enough to condense the vapor of the carriage?*

A. Because the *inside* of a carriage is much *warmer* than the *outside*; and the glass window is made cold by contact with the *external air*.

Q. *WHERE does the WARM vapor of the carriage come from?*

A. The warm *breath* and *insensible perspiration* of the persons riding, load the air of the carriage with warm vapor.

Q. *What is the cause of the pretty FROST-WORK, seen on bed-room WINDOWS in winter-time?*

A. The *breath* and insensible *perspiration* of the sleeper (coming in contact with the ice-cold window) are *frozen* by the cold glass, and form those beautiful appearances seen in our bed-rooms on a winter morning.

Q. *Why is the GLASS of a window colder than the WALLS of a room?*

A. Because glass is so *excellent a radiator*, that it parts with its heat more *rapidly* than the *walls* do.

Q. *Why is a TUMBLER of cold WATER made quite DULL with mist, when brought into a room FULL of PEOPLE?*

A. Because the *hot vapor* of the room is *condensed* upon the cold tumbler, with which it comes in contact; and changes its invisible and gaseous form into that of a *thick mist*.

Q. *Why is a GLASS made quite DULL by laying a HOT HAND upon it?*

A. Because the insensible *perspiration* of the hot hand is *condensed* upon the cold glass, and made perceptible.

Q. *Why are WINE-GLASSES made quite DULL, when they are brought into a room FULL of COMPANY?*

A. Because the *hot vapor* of the room (coming in contact with the cold wine-glasses) is condensed upon them, and covers them with vapor, like dew.

Q. *Why does this misty appearance GO OFF, after a little time?*

A. Because the glass becomes of the same *temperature* as the *air* of the room; and will no longer *chill* the *vapor* which touches it, and *condense* it into *mist*.

Q. *Why is a WINE GLASS (which has been brought out of a CELLAR into the AIR) covered with a thick MIST in summer-time?*

A. Because the vapor of the hot air is *condensed* into a thick mist, by contact with the cold glass.

Q. *Why does BREATHING on a GLASS make it quite DULL?*

A. Because the hot breath is *condensed* by the cold glass; and therefore covers it with a thick mist.

Q. *Why are the WALLS of a house covered with WET in a sudden THAW?*

A. Because the walls (being thick) cannot *change* their *temperature* so fast as the air; in consequence of which, they *retain* their *cold* after the thaw has set in.

Q. *How does "RETAINING their COLD" account for their being so WET?*

A. As the vapor of the warm air touches the *cold walls*, it is *chilled* and *condensed* into *water*; which either *sticks* to the walls or trickles down in little streams.

Q. *Why does a thick WELL-BUILT HOUSE contract more DAMP of this kind than an ORDINARY one?*

A. Because the walls are much thicker; and (if the frost has penetrated far into the *bricks*) they will be some time before they are reduced to the same *temperature* as the *air*.

Q. *Why are BALUSTERS, &c., DAMP after a THAW?*

A. Because they are made of some very close-grained varnished wood, which cannot *change* its *temperature* so *fast* as the *air*.

Balusters—corruptly called banisters.

Q. *How does THIS account for the BALUSTERS being DAMP?*

A. The vapor of the warm air (coming in *contact* with the *cold balusters*) is *chilled* and condensed into *water* upon them.

Q. *Why is our BREATH VISIBLE in WINTER, and NOT in SUMMER?*

A. Because the intense cold condenses our breath into *visible vapor*; but in *summer* the air is *not cold enough* to do so.

Q. *Why are our HAIR and the BRIM of our HAT often covered with little drops of pearly DEW in winter-time?*

A. Because our breath is condensed

as soon as it comes in contact with our cold hair or hat, and hangs there in little dew-drops.

Q. *Why does the STEAM of a RAILWAY BOILER often pour down, like fine rain, when the steam is "let off?"*

A. Because in cold weather the steam from the chimney is *condensed* by the *chill air* and falls like fine rain.

Q. *Why is there LESS DEW when the WIND is WESTERLY, than when the wind is EASTERLY?*

A. Because *westerly* winds cross the *continent*, and, (as they pass over *land*) are dry and arid: But *easterly* winds cross the *Atlantic Ocean*, and (as they pass over *water*) are *moist* and *full of vapor*.

Q. *How does the DRYNESS of a westerly wind PREVENT DEW-FALLS?*

A. As *westerly* winds are very dry, they imbibe the moisture of the air; in consequence of which, there is *very little* left to be condensed into *dew*.

Q. *How does the MOISTNESS of an eastern wind PROMOTE dew-falls?*

A. As *easterly* winds are *saturated* with *vapor*, they require very little *reduction of heat* to cause a *copious deposition of dew*.

Q. *When is DEW most COPIOUSLY distilled?*

A. After a hot day in summer or autumn, especially if the *wind* be easterly.

Q. Why is DEW distilled most COPIOUSLY after a HOT day?

A. Because the surface of the hot earth *radiates* heat very freely at sunset, and (being made much *colder* than the air) *chills* the *passing vapor* and condenses it into dew.

Q. Does not AIR radiate heat, as well as the EARTH and its various plants?

A. No. The air never *radiates heat*; nor is the air made *hot* by the *rays* of the sun.

Q. How is the AIR made HOT or COLD?

A. By convection of *hot* or *cold* currents.

Q. Explain this.

A. The air which has been heated by the surface of the earth ascends, warming the air through which it passes. Other air (being warmed in a similar way) also *ascends*, carrying *heat*; and this is repeated, till all the air is made hot.

Q. How is the AIR made COLD?

A. The air resting on the earth is made *cold* by *contact*: this cold air makes the *air above* it *cold*; and cold currents (or winds) *shake* the *whole together*, till all becomes of one temperature.

Q. *Why is MEAT very subject to TAINT on a MOONLIGHT night?*

A. Because it *radiates heat very* freely in a bright moonlight night; in consequence of which, it is soon covered with *dew*, which produces rapid *decomposition*.

Q. *How do MOONLIGHT nights conduce to the rapid GROWTH of PLANTS?*

A. Radiation is carried on very rapidly on bright moonlight nights; in consequence of which, *dew* is very plentifully *deposited* on young plants, which conduces much to their growth and vigor.

Q. *Why is evening DEW INJURIOUS to HEALTH?*

A. Because it is always laden with *noxious exhalations* from the *earth*; especially in *marshy* countries.

Q. *Is HONEY-DEW a similar thing to DEW?*

A. No. Honey-dew is a sweet liquid shed by a very small *insect* (called the *a'phis*) and deposited in autumn on the under surface of favorite leaves.

Frequently also on Lime Trees, in the Spring.

Q. *Does HONEY-DEW INJURE leaves, or do them good?*

A. It injures them very much, by filling the *pores* with a thick, clammy liquid; in consequence of which, the leaf can

neither *transpire* nor *absorb* its needful food.

Q. *What EFFECT has honey-dew upon the APPEARANCE of a leaf?*

A. After a little time, the leaf (being *smothered* and *starved*) begins to turn a *dingy yellow*.

Q. *Are not ANTS very FOND of HONEY-DEW?*

A. Yes; and crawl up the loftiest trees in order to obtain it.

Q. *What is the cause of MIST (or earth-fog)?*

A. If the *night* has been very *calm*, the radiation of heat from the earth has been very abundant; in consequence of which, the *air* (resting on the earth) has been *chilled*, and its vapor condensed into a thick mist.

Q. *Why does not the MIST become DEW?*

A. Because the chill of the air is so *rapid*, that vapor is condensed *faster* than it can be *deposited*; and (covering the earth in a mist) prevents any further *radiation of heat* from the earth.

Q. *When the earth can no longer RADIATE heat upwards, does it continue to CONDENSE the vapor of the air?*

A. No; the air (in contact with the earth) becomes about equal in *temperature* with the surface of the earth itself, for which reason, the mist is not *con-*



*condensed* into dew, but remains *floating* above the *earth* as a thick cloud.

Q. *This* MIST *seems to* RISE HIGHER *and* HIGHER, *and yet remains quite as dense below as at first. Explain the cause of this.*

A. The air resting on the *earth* is first chilled, and *chills* the air resting on it; the air which touches this *new layer* of mist being *also* condensed, layer is added to layer: And thus the mist seems to be *rising*, when (in fact) it is only *deepening*.

Q. *Why do* MIST *and* DEW VANISH, *as the* SUN *rises?*

A. Because the air becomes *warmer* at sun-rise, and *absorbs* the vapor.

Q. *Why is a* DEW-DROP ROUND?

A. Because every part of it is *equally balanced*; and, therefore, there is no cause why *one part* of the drop should be further from the centre than *another*.

Q. *Why is the* DEW-DROP *(on a broad leaf)* sometimes FLATTENED?

A. Because two or more drops of dew *roll together*, and make one large *spheroid* (or flattened drop).

Q. *Why will* DEW-DROPS ROLL ABOUT CABBAGE-PLANTS, POPPIES, &c., *without wetting the surface?*

A. Because the leaves of cabbages

and poppies are covered with a very *fine waxen powder*, over which the dew-drop rolls without wetting the surface, as a drop of rain would over dust.

Q. *Why does not a drop of RAIN WET the DUST over which it rolls?*

A. Because dust has no *affinity* for water, and, therefore, repels it.

Q. *Why does not the DEW-DROP WET the POWDER of the CABBAGE-PLANT?*

A. Because the fine powder which covers the cabbage-leaves has no *affinity*, for water, and, therefore, repels it.

Q. *Why will DEW-DROPS ROLL over a ROSE, &c., without wetting the petals?*

A. Because the leaves of a rose contain an *essential oil*, which has no *affinity* for water, and, therefore, repels it.

Q. *Why can SWANS and DUCKS dive under water WITHOUT being WETTED?*

A. Because their feathers are covered with an *oily secretion*, which has no *affinity* for water, and, therefore, repels it.

Q. *What is the cause of MIST?*

A. Currents of air from the water coming in contact with *colder land* currents.

Q. *Why are the currents of air from the LAND COLDER than those blowing over WATER?*

A. Because the earth radiates heat after sun-set more freely than water; consequently the *air* which comes in contact with the land is more cold than that which comes in contact with water.

For other questions respecting land and sea breezes see Chapter XXIV.

Q. *Why is not the AIR which passes over WATER so COOL as that which passes over LAND?*

A. Because *water* does not cool down at *sun-set* so fast as *land* does; and, therefore, the air in contact with it *remains warmer*.

Q. *Why does not WATER cool down so fast as LAND?*

A. 1st—Because the *surface* of water is perpetually *changing*; and, as fast as one surface is made cold, *another* is presented: and

2dly—The moment water is made cold *it sinks*, and *warmer* portions of water *rise* to occupy its place: therefore, before the *surface of water is cooled*, the *whole volume* must be made cold: which is not the case with land.

Q. *What is the cause of a "pea-soup" LONDON FOG?*

A. These fogs (which occur generally in the winter time) are occasioned thus:—Some current of air (being sud-

denly cooled) *descends* into the *warm streets*, forcing back the smoke in a *mass* towards the earth.

Q. *Why are there not FOGS EVERY night?*

A. Because the air will always hold in solution a certain quantity of vapor, (which varies according to its temperature :) and, when the air is not *saturated*, it may be cooled without parting with its vapor.

Q. *When do FOGS occur at night?*

A. When the air is saturated with *vapor* during the day. When this is the case, it deposits some of its superabundant moisture in the form of dew or fog as soon as its capacity for holding vapor is lessened by the *cold night*.

Q. *Why is there very OFTEN a fog over MARSHES and RIVERS, at night-time?*

A. Because the air of marshes is almost always near *saturation*; and, therefore, the least depression of *temperature* will compel it to relinquish some of its moisture in the form of dew or fog.

Q. *What is the DIFFERENCE between DEW and RAIN?*

A. In *dew*, the condensation is made near the *earth's surface*.

In *rain*, the drops fall from a considerable height.

Q. *What is the CAUSE of both dew and rain?*

A. Cold *condensing* the vapor of the *air* when near the point of *saturation*.

Q. *Why do MIST and FOG VANISH at sun-rise?*

A. Because the condensed particles are again *changed* into *invisible* vapor by the heat of the sun.

Q. *What is the difference between a MIST and a FOG?*

A. MIST is generally applied to *vapors* condensed on *marshes*, *rivers*, and *lakes*.

Fog is generally applied to *vapors* condensed on *land*; especially if those vapors are laden with smoke.

Q. *What is the reason why condensed vapor sometimes forms into CLOUDS, and sometimes into FOG?*

A. If the surface of the *EARTH* is hotter than the *air*, the vapor of the earth is *chilled* by the *cold air*, and becomes *FOG*: But if the *AIR* is hotter than the *earth*, the vapor *rises through the air*, and becomes *CLOUD*.

Q. *If cold air produces FOG, why is it not foggy on a FROSTY MORNING?*

A. 1st—Because *less vapor* is formed on a *frosty day*: and

2dly—The vapor is *frozen* upon the *ground*, before it can rise from the earth, and becomes HOAR-FROST.

Q. *Why are FOGS more general in AUTUMN than in spring?*

A. 1st—Because the air in spring is generally much *drier* than it is in autumn; in consequence of which, it is not so near the point of *saturation*: and

2dly—The *earth* in spring is not so *hot* as it is in autumn; in consequence of which, its vapor is not chilled into fog as it issues into the air.

Q. *Why are FOGS more common in VALLEYS than on HILLS?*

A. 1st—Because valleys contain more *moisture* than *hills*: and

2dly—They are *not exposed* to sufficient *wind* to dissipate the vapor.

Q. *How does WIND dissipate FOGS?*

A. Either by *blowing* them away; or else by *dissolving* them into *vapor* again.

Q. *What is HOAR-FROST?*

A. There are two sorts of hoar-frost; 1.—FROZEN DEW: and 2.—FROZEN FOG.

Q. *What is the cause of the GROUND HOAR-FROST, or frozen DEW?*

A. Very *rapid radiation* of heat from the earth; in consequence of which, the

*surface* is so cooled down that it freezes the dew condensed upon it.

Q. *Why is HOAR-FROST seen only after a very CLEAR NIGHT?*

A. Because the earth will not have thrown off heat enough by radiation to freeze the vapor condensed upon its surface, unless the night has been very clear indeed.

Q. *Why does HOAR-FROST very often COVER the GROUND and TREES, when the water of rivers is not frozen?*

A. Because it is not the effect of cold in the *air*, but cold on the surface of the *earth* (produced by excessive radiation), which freezes the dew condensed upon it.

Q. *Why is the HOAR-FROST upon GRASS and VEGETABLES much thicker than that upon lofty TREES?*

A. Because the air (resting on the *surface* of the ground) is much colder after sun-set than the *air higher up*; in consequence of which, more *vapor* is condensed and frozen there.

Q. *Why is the AIR (resting on the surface of the EARTH) colder than that in the HIGHER regions?*

A. Because the *earth* radiates more heat than the *leaves* of lofty trees; and, therefore, more *rapidly* condenses and freezes the vapor of the air.

Q. *Why are EVERGREENS often FROST-BITTEN when lofty trees are NOT?*

A. Because they do not rise far above the surface of the earth; and (as the air *contiguous* to the earth is made *colder* by radiation than that in the *higher* regions), therefore, the *low evergreen* is often *frost-bitten*, when the lofty tree is uninjured.

Q. *Why is there little or NO HOAR-FROST under SHRUBS and shady TREES?*

A. 1st—Because the leafy top *arrests* the process of radiation from the earth:

2dly—Shrubs and trees radiate *heat* towards the earth: and, therefore, the *ground beneath* is never *cold enough* to *congeal* the little dew which rests upon it.

Q. *What is the cause of that HOAR-FROST which arises from FROZEN FOG?*

A. The thick fog which invested the earth during the night (being condensed by the *cold frost* of early morning), is *congealed* upon *every object* with which it comes in contact.



## CHAPTER XIX.

## 5.—CONVECTION.

Q. *What is meant by the CONVECTION of HEAT?*

A. Heat communicated by being *carried* to another thing or place; as the hot water resting on the *bottom* of a kettle carries heat to the water through which it ascends. (*See p. 226.*)

Q. *Are LIQUIDS good CONDUCTORS of heat?*

A. No; liquids are bad *conductors*; and are, therefore, made hot by *convection*.

Q. *Why are LIQUIDS BAD CONDUCTORS of heat?*

A. Because heat *converts a liquid into steam*; and flies off with the vapor instead of being *conducted through* the liquid.

Q. *Explain how WATER is made HOT.*

A. The water *nearest the fire* is *first* heated, and (being heated) *rises* to the *top*; while its place is supplied by *colder* portions, which are heated in turn, till *all* the water is boiling hot.

Q. *Why is WATER in such continual FERMENT, when it is BOILING?*

A. This commotion is mainly produ-

ced by the *ascending* and *descending currents* of hot and cold water.

The escape of *steam* from the water contributes also to increase this agitation.

Q. *How do these two currents PASS each other?*

A. The *hot ascending current* rises up through the *centre* of the mass of water; while the *cold descending currents* pass down by the *metal sides of the kettle*.

For other questions on the subject of boiling water, see from page 109 to 115.

Q. *Why is HEAT applied to the BOTTOM, and not to the top of a KETTLE?*

A. Because the heated water always *ascends* to the *surface*, heating the water through which it passes; if, therefore, heat were applied to the *top* of a vessel, the water *below the surface* would never be *heated*.

Q. *As the lower part of a GRATE is made RED-HOT by the fire ABOVE, why would not the WATER boil, if fire were applied to the TOP of a kettle?*

A. The *iron* of a grate is an excellent *conductor*; if, therefore, *one* part be heated, the heat is conducted to *every* other part: But *water* is a very *bad conductor*, and will not diffuse heat in a similar way.

Q. *Prove that WATER is a BAD CONDUCTOR of heat.*

A. When a blacksmith immerses his red-hot iron in a tank of water, the water

which surrounds the iron is made *boiling hot*, while that *below the surface* remains quite cold.

Q. *If you wish to COOL LIQUIDS, where should the cold be applied?*

A. To the *top* of the *liquid*; because the *cold* portions will always *descend*, and allow the warmer parts to come in contact with the cooling substance.

Q. *Does BOILING water get hotter by being KEPT on the FIRE?*

A. No:—not if the steam be suffered to escape.

Q. *WHY does not boiling water get HOTTER, if the steam be suffered to ESCAPE?*

A. Because the *water* is converted into *steam* as fast as it boils; and the steam *carries away* the additional heat.

Q. *Why does SOUP keep HOT longer than boiling water?*

A. Because the grease and various ingredients floating in the soup, oppose the ascending motion of the hot particles, and prevent their rising so freely to the surface.

Q. *If you wanted to keep WATER HOT for a long time, how could it be done?*

A. By adding a little *starch* or flour to the water.

Q. *Why would a little STARCH, added to boiling water, serve to keep it HOT?*

A. Because it would oppose the ascending motion of the hot particles of water, and prevent their rising so freely to the surface.

Q. *Why do THICK MILK, RICE MILK, &c., remain HOT longer than water?*

A. Because the ascending motion of the hot particles is opposed by the flour or rice, and cannot so quickly reach the surface.

Q. *Is STEAM visible or INVISIBLE?*

A. Steam is *invisible*; but when it comes in contact with the air (being *condensed* into small drops) it instantly becomes visible.

Q. *How do you know that STEAM is INVISIBLE?*

A. If you look at the spout of a boiling kettle, you will find that the steam (which issues from the spout) is always invisible for about *half an inch*; after which *it becomes visible*.

Q. *WHY is the steam INVISIBLE for HALF AN INCH?*

A. Because the air is not able to condense it, as it first issues from the spout; but when it *spreads* and comes in contact with a larger volume of air, the *invisible steam* is readily condensed into *visible drops*.

Q. *WHY do STEAM-ENGINES sometimes BURST?*

A. Because steam is very *elastic*, and this elasticity increases in a greater proportion than the heat which produces it; unless, therefore, some *vent* be freely allowed, steam will burst the vessel which confines it.

Q. *Is AIR a good CONDUCTOR?*

A. No; *air* is a very *bad conductor*; and is heated (like water) by *convection*.

Q. *How is a ROOM WARMED by a STOVE?*

A. The air *nearest* the fire is made hot *first* and rises; *cold air* then *descends*, is heated, and *ascends* in like manner; and this interchange goes on till *all* the air of the room is *warmed*. (*See p. 56.*)

Q. *Why are FIRES placed on the FLOOR of a room, and not towards the CEILING?*

A. Because heated air always *ascends*. If, therefore, the fire were not *near the floor*, the air of the *lower* part of the room would never be heated by the fire at all.

Q. *If you take a POKER out of the fire, and hold the HOT END DOWNWARDS, why is the HANDLE intensely HOT?*

A. Because the hot end of the poker *heats the air* around it; and this hot air (in its ascent) *scorches* the *poker* and the *hand* which holds it.

Q. *How should a RED-HOT POKER be carried, or as not to BURN our fingers?*

A. With the hot end *upwards*; for then the air (heated by the poker) would not pass over our hand and scorch it.

## PART II.

# AIR.

### CHAPTER XX.

#### THE ATMOSPHERE.

Q. *Of what is atmospheric AIR composed?*

A. Principally of two gases, *oxygen* and *nitrogen*, mixed together in the following proportion: viz., 1 gallon of oxygen to 4 of nitrogen.

It must not be forgotten that the air contains small quantities of other gaseous substances also, as *vapor of water*, *carbonic acid*, and *ammonia*.

Q. *What do you mean by a GAS?*

A. A *permanent elastic* fluid resembling air.

N. B. MOST GASES ARE INVISIBLE OR COLORLESS, LIKE AIR.

“PERMANENT,”—In this respect gas differs from *vapor*, which is *not* permanent; for vapor may be easily condensed by cold into a *liquid*, but gas never changes its gaseous form.

“ELASTIC,”—In this respect gas differs from a *liquid*, which is almost inelastic; whereas gas is exceedingly elastic.

“RESEMBLING AIR,” or aeriform.—The word “Gas” means *air*, but air is a compound of two gases. Some few gases are visible, as CHLORINE, which is a greenish yellow.

Q. *What is the difference between a GAS and a LIQUID?*

A. Gases are *elastic*, but liquids *not*.

Q. *Illustrate what is meant by "the ELASTICITY of GAS."*

A. If from a vessel full of gas *half* were taken out—the *other* half would immediately spread itself out, and fill the same space as was occupied by the *whole*.

Q. *Prove that a LIQUID is NOT ELASTIC.*

A. If from a gallon of water you take *half*, the remaining 4 pints will take up only *half* the room that the whole gallon previously did: a *liquid*, therefore, is not elastic like *gas*.

Strictly speaking, a liquid is *slightly* elastic; inasmuch as it may be *compressed* and will afterwards recover its former dimensions.

Q. *What are the uses of the OXYGEN of the air?*

A. To *support* combustion and *sustain* life.

Q. *What is meant, when it is said, that the OXYGEN of the air "SUPPORTS COMBUSTION?"*

A. It means this: It is the *oxygen* of the air which makes *fuel* burn.

Q. *How does the OXYGEN of the air make FUEL BURN?*

A. The fuel is decomposed (by heat) into *hydrogen* and *carbon*; and these elements combining with the *oxygen* of the air produce combustion.



Q. What GAS is produced by the combination of carbon and oxygen?

A. CARBONIC ACID GAS. (See p. 43.)

Q. What becomes of the HYDROGEN of the FUEL?

A. The *hydrogen* of the fuel combines with the *oxygen* of the air, and forms WATERY VAPOR; but the combination is attended by the production of *flame*, owing to the very inflammable nature of hydrogen gas.

Q. What becomes of the NITROGEN of the air, amidst all these changes and combinations?

A. The nitrogen escapes *unchanged*, to be again mixed with *oxygen*, and converted into common AIR.

Q. What is meant, when it is said, that OXYGEN "SUSTAINS LIFE?"

A. It means this: If a person could not inhale oxygen, he would die.

Q. What GOOD does this inspiration of OXYGEN do?

A. 1st—It gives *vitality* to the *blood*: and

2dly—It is the *cause* of *animal heat*.

Q. How is FOOD converted into BLOOD?

A. After it is swallowed, it is dissolved in the stomach into a *grey pulp*, called CHYME; it then passes into the intestines, and is converted by the "*bile*" into a *milky substance*, called CHYLE.

Chyme—pronounce kyme—chyle pronounce kyle—each as one syllable.

Q. What BECOMES of the milky substance called CHYLE?

A. It is absorbed by the vessels called "*lacteals*," and poured into the veins on the *left side of the neck*.

Lac'teals—pronounce Lac`-te-als.

Q. What becomes of the chyle, AFTER it is POURED into the VEINS?

A. It *mingles* with the *blood*, and is itself *converted* into blood also.

Q. How does the OXYGEN we inhale MINGLE with the BLOOD?

A. The oxygen of the air *mingles* with the blood *in the lungs*, and converts it into a *bright red color*.

Q. What color is the blood BEFORE it is oxidized in the lungs?

A. *A dark purple*. The oxygen turns it to a *bright red*.

Oxidized, i. e., impregnated with oxygen.

Q. Why are PERSONS so PALE, who live in CLOSE ROOMS and CITIES?

A. Because the blood derives its redness from the *oxygen* of the air inhaled; but, as the air in close rooms and cities is not *fresh*, it is *deficient in oxygen*, and cannot turn the blood to a beautiful bright red.

Q. Why are PERSONS, who live in the OFEN AIR and in the country, of a RUDDY complexion?

A. Because they inhale fresh air which has its full proportion of oxygen: and the blood derives its bright red color from the *oxygen* of the air inhaled.

Q. *Why is not the air in CITIES so FRESH as that in the COUNTRY?*

A. Because it is impregnated with the *breath* of its numerous *inhabitants*, the *odor* of its *sewers*, the *smoke* of its *fires*, and many other impurities.

Q. *How does OXYGEN convert the color of blood into a bright RED?*

A. The *coloring* matter of the blood is formed by very minute *globules* floating in it; the oxygen (uniting with the *coats of these globules*) makes them *milky*—and the dark coloring matter of the blood (seen through this *milky coat*) appears of a *bright red*.

Exp.:—If you put some dark *venous* blood into a *milky* glass, and hold it up towards the light, it will appear of a *bright florid* color like *arterial* blood.

Q. *How does the COMBINATION of OXYGEN with the BLOOD produce animal HEAT?*

A. The principal element of the blood is *carbon*; and this carbon (combining with the oxygen of the air inhaled) produces *carbonic acid gas*, in the same way as burning fuel. (See p. 43.)

Q. *What becomes of the NITROGEN of the air, after the oxygen enters the blood?*

A. It is thrown out from the lungs unchanged, by the act of breathing; to be again mixed with *oxygen* and converted into common AIR.

Q. *Why does the vitiated air (after the oxygen has been absorbed) COME OUT of the MOUTH, and not sink into the stomach?*

A. Because a mechanical provision is made in the upper part of the wind-pipe and gullet for this purpose.

N. B. The lungs are a *hollow, spongy mass*, capable of confining air and of being *dilated* by it. They are so situated in the thorax (or chest), that the air *must* enter into them, whenever the cavities of the thorax are enlarged. The process of breathing is performed thus: When we INHALE, the thorax (or chest) is expanded; in consequence of which, a *vacuum is formed round the lungs*, and heavy external air instantly enters (through the mouth and throat) *to supply this vacuum*.

When we EXHALE, the thorax *contracts* again; in consequence of which, it can no longer contain the *same quantity* of air as it did before; and some of it is necessarily *expelled*. When this expulsion of air takes place, the lungs and *muscular fibres* of the wind-pipe and gullet *contract* in order to assist the process.

Q. *If (both in combustion and respiration) the OXYGEN of the air is CONSUMED, and the NITROGEN REJECTED—Why are not the PROPORTIONS of the AIR DESTROYED?*

A. Because the *under surface of vegetable leaves* (during the day) gives out *oxygen*; and thus restores to the air the very element of which it has been deprived.

Q. *Whence do leaves OBTAIN the oxygen which they exhale?*

A. From the *carbonic acid*, absorbed by the *roots* from the soil, and carried to the leaves by the rising *sap*.

N. B. Carbonic acid (it must be remembered) is a compound of carbon and oxygen.

Q. *How do plants contrive to absorb carbonic acid from the soil?*

A. It rises (by capillary attraction) through the small fibrous roots, after it has been dissolved in the soil by water.

Q. *Whence does the SOIL obtain carbonic acid?*

A. 1st—From the air; from which it is driven by falling showers:

2dly—From the decomposition of vegetable and animal matters, which always produces this gas in abundance: and

3dly—All lime-stone, chalk, and calcareous stones, contain vast quantities of carbonic acid in a *solid* state.

Calcareous, i. e., of a limy nature.

Q. *If leaves throw off the OXYGEN of the carbonic acid, what becomes of the carbon?*

A. It is retained to give *firmness* and *solidity* to the plant itself.

Q. *Show how God has made ANIMAL life dependent on that of VEGETABLES.*

A. *Animals* require *oxygen* to keep them alive, and *draw it from the air* by

inspiration : The under surface of *leaves* gives out *oxygen* ; and thus supplies the air with the *very gas* required for the use of animals.

Q. Show how God has made VEGETABLE life dependent on that of animal.

A. Plants require *carbonic acid*, which is their *principal food* ; and all animals exhale the same gas from their lungs. Thus *plants* supply animals with *oxygen*, and *animals* supply plants with *carbonic acid*.

Q. How is AIR HEATED ?

A. By "convective currents."

Q. Explain what is meant by "CONVECTIVE CURRENTS."

A. When a portion of air is heated, it *rises upwards in a current*, carrying the heat with it ; other *colder air succeeds*, and (being *heated* in a similar way) *ascends also* : These are called "convective currents."

("Convective currents ;" so called from the Latin words, cum-vectus (*carried with*) ; because the *heat* is "carried with" the current.)

Q. Is AIR HEATED by the RAYS of the SUN ?

A. No ; air is *not heated* (in any sensible degree) by the action of the sun's rays passing through it.

Q. Why then is the AIR HOTTER on a SUNNY DAY, than on a CLOUDY one ?

A. Because the sun *heats the surface* of the *earth*, and the air (resting on the earth) is *heated by contact*: as soon as it is heated *it ascends*; while its place is supplied by *colder* portions which are heated in turn also.

Q. *If AIR be a BAD CONDUCTOR, why does hot IRON become COLD by EXPOSURE to the AIR?*

A. Because it is made cold—1st—By “convection;” and 2dly—By “radiation.”

Q. *How is hot iron made cold by CONVECTION?*

A. The air resting on the hot iron (being intensely heated), rapidly ascends with the heat it has absorbed; *colder* air succeeding *absorbs more heat* and ascends also; and this process is repeated till the hot iron *is cooled completely down*.

Q. *How is hot iron cooled by RADIATION?*

A. While its heat is being carried off by “convection,” the hot iron *throws off heat* (on all sides) *by radiation* also.

Q. *What is meant by RADIATION?*

A. Heat emitted (in all directions) from any surface by *rays*.

Q. *How is BROTH COOLED by being left exposed to the AIR?*

A. It throws off *some heat by radiation*; but it is *mainly* cooled down by *convection*.

Q. *How is hot BROTH cooled down by CONVECTION?*

A. The air *resting* on the *hot broth* (being heated) *ascends*; *colder* air succeeding *absorbs more heat*, and *ascends also*; and this process is repeated till the broth is *made cool*.

The particles on the surface of the broth *sink* as they are cooled down, and *warmer* particles rise to the surface; which gradually assists the cooling process.

Q. *Why is hot TEA and BROTH COOLED faster by being STIRRED about?*

A. 1st—Because the agitation assists in bringing its *hottest particles* to the *surface*.

2dly—The action of stirring *agitates the air*, and brings it more *quickly* to the broth or tea: and

3dly—As the hotter particles are more rapidly brought into contact with the air, therefore, *convection is more rapid*.

Blowing tea or broth cools it also. (See p. 168.)

Q. *If a shutter be closed in the day-time, the stream of light (piercing through the crevice) seems in CONSTANT AGITATION. WHY is this?*

A. Because little *motes and particles of dust* (thrown into agitation by the violence of the *convective currents*) are made *visible* by the strong beam of light thrown into the room through the crevice of the shutter.



Q. *Why is the GALLERY of a CHURCH or theatre HOTTER than the AISLE or pit?*

A. Because the hot air ascends from the *bottom* to the *top of the building*; while cold air flows to the *bottom* from the doors and windows.

Q. *Why do persons who ascend in balloons feel intense pain in their eyes and ears?*

A. Because the air of the upper regions is *more rarefied* than that on the earth; and the air inside their bodies (seeking to become of the same rarity) *bursts through their eyes and ears*, producing intense pain.

Q. *Why is it often PAINFUL and difficult to BREATHE, on a MOUNTAIN-TOP?*

A. Because the pressure of air on the mountain-top is *not so great as it is on the plain*; and the air inside our bodies (seeking to become of the same rarity) *bursts through the pores of the body* and produces great pain.

Q. *Why do we feel OPPRESSED just PREVIOUS to a storm?*

A. Because the air is greatly *rarefied by heat and vapor*; and the air inside us (seeking to become of the same rarity) produces an oppressive and suffocating feeling.

Q. *Why do DIVERS, when they are under water, suffer great pain in their eyes and ears?*

A. Because the air at the bottom of the sea *is more dense* than the air on the *surface*; and (till the air inside the diver's body is settled into the same density) he feels oppressed with pain, especially in the ears.

Q. *Why is this PAIN felt especially about the EARS of a DIVER?*

A. Because the ear is fitted with a small membrane called *the drum* (ortym'panum), through which the dense air bursts: The rupture of this membrane very often *produces incurable deafness*.

When the diver is not in a *bell* the dense *water* bursts into his ears and ruptures the tympanum.

Q. *Why do our CORNS ache just previous to RAIN?*

A. Because *our feet swell* from the sudden depression in the density of air; and the hard corn (*not being elastic*) is painfully stretched and pressed.

Some of this pain is due to electricity.

Q. *How do you know that the density of the air is lowered, previous to a storm?*

A. Because the *mercury* of a barometer rapidly *falls*.

Q. *Why do CELLARS feel WARM in WINTER?*

A. Because the external air has not

free access into them ; in consequence of which, they remain almost at an *even temperature*—which (in winter time) is about 10 degrees *warmer* than the external air.

Q. *Why do CELLARS feel COLD in SUMMER ?*

A. Because the external air has not free access into them ; in consequence of which, they remain almost at an *even temperature*—which (in summer time) is about 10 degrees *colder* than the external air.

Q. *Why does AIR rust IRON ?*

A. Because the *oxygen of the air* combines with the *surface* of the metal, and produces *oxide of iron* ; which is generally called “rust.”

An oxide of iron, copper, &c., is oxygen in *combination* with iron, copper, &c.

Q. *Why does hot iron SCALE and PEEL off, when struck with a HAMMER ?*

A. Because the *oxygen of the air* very readily unites with the surface of the *hot iron*, and forms a metallic oxide (or rust), which scales off when struck with a hammer.

Q. *Does iron RUST in DRY air ?*

A. No ; iron undergoes no change in dry air.

Q. *Why do STOVES and FIRE-IRONS become RUSTY in rooms, which are not OCCUPIED?*

A. Because the air is damp; and moist air *oxidizes* iron and steel.

Oxidizes, i. e., rusts.

Q. *In what part of the year is it most difficult to keep STOVES and FIRE-IRONS BRIGHT?*

A. In *autumn* and *winter*.

Q. *Why is it more difficult to keep STOVES and FIRE-IRONS bright in AUTUMN and WINTER than in spring and summer?*

A. Because the capacity of the air for holding water is constantly on the *decrease*, after the summer is over; in consequence of which, vapor is deposited on everything with which the air comes in contact.

Q. *Why does GREASING iron prevent its becoming RUSTY?*

A. Because *grease* prevents the humidity of air from coming in contact with the *surface* of the *iron*.

Q. *Why do not STOVES rust so frequently as POKERS and TONGS?*

A. Because stoves are generally *covered with plumbago*, or black lead.

Q. *What is plumbago, or black lead?*

A. A mixture of charcoal and iron.

Plumbago (strictly speaking) is a chemical union of *carbon* and *iron*, in the following proportions:—91 parts carbon and 9 iron. But the BLACK LEAD sold in shops is a mixture of charcoal and iron filings.

N. B. A most excellent varnish to prevent rust is made of 1 pint of fat oil varnish, mixed with 5 pints of highly rectified spirits of turpentine, rubbed on the iron or steel with a piece of sponge. This varnish may be applied to bright stoves, and even mathematical instruments, without injuring their delicate polish.

Q. *Why does ornamental STEEL (of a purple or LILAC color) rust more readily than polished WHITE steel?*

A. Because the lilac tinge is produced by *partial oxidation*; and the process which forms rusts has, therefore, already commenced.

Q. *How can lilac STEEL be kept FREE from RUST?*

A. By keeping it in a very *dry place*.

Q. *If DRY AIR contains OXYGEN, why does it NOT RUST IRON, as well as MOIST air?*

A. Because moisture is always needed, in order to bring into action the affinity of oxygen for steel.

Q. *Do any OTHER metals (besides iron) combine rapidly with oxygen?*

A. Yes; copper, lead, mercury, and even silver to some extent.

Q. *Why does COPPER TARNISH?*

A. The tarnish of copper is caused by its *oxidation*: that is, the oxygen of the air combines with the surface of the copper, and (instead of *rusting* it) covers it with a *dark tarnish*.

Q. *Why does LEAD become of a DARKER hue by being exposed to the air?*

A. Because the vapor of the air combines with the lead, and *oxidizes its surface*; but instead of becoming *rusty*, the surface assumes a *darker hue*.

Q. *Why does LEAD lose its BRIGHTNESS, and become DULL, by being exposed to the air?*

A. The *dullness* of the lead is caused by the presence of a *carbonate* of the oxide. When the oxide is formed, it attracts *carbonic acid* from the air, and (combining with it) produces a *carbonate*, which gives the *dull* tint to old lead.

Q. *Why is it difficult to keep SILVER BRIGHT?*

A. Because the vapor of the air oxidizes its surface, and *tarnishes* it.

Q. *Why do silver TEA-POTS and SPOONS tarnish more quickly than silver ore or bullion?*

A. Because alloy of some *baser metal* is used, to make them more *hard and lasting*; and this *alloy* oxidizes more quickly than silver itself.

Q. *Why does GERMAN silver turn a dingy yellow in a few hours?*

A. Because German silver has a great affinity for oxygen; and shows its oxidation by a *sickly yellow tarnish*, instead of rust.

Q. *If quicksilver (or mercury) will tarnish like copper and lead—why does it preserve its BRILLIANCY in BAROMETERS and THERMOMETERS?*

A. Because the *air* is excluded ; and no moisture can come in contact with it, to *oxidize* (or *tarnish*) it.

Q. *Is GOLD affected by the atmosphere ?*

A. Not readily ; gold will never combine with oxygen of itself, (i. e., without aid.)

Q. *WHICH of the METALS is capable of resisting oxidation altogether ?*

A. Plat'inum ; in consequence of which, the graduated arcs of delicate "instruments-for-observation" are made of plat'inum instead of any *other* metal.

Q. *Why is PLAT'INUM used for the graduated arcs of delicate mathematical instruments, instead of any other metal ?*

A. Because it will never oxidize ; but retains its *bright surface* in all weathers, free from both *rust* and *tarnish*.

Q. *Before plat'inum was discovered, which of the metals was employed for the same purpose ?*

A. Gold.

Plat'inum (a white metal), so called from "plata," the Spanish word for *silver*. It was introduced from South America into England by Mr. Wood, (A. D. 1749.)

Q. *For what other SCIENTIFIC purpose is PLAT'INUM now used ?*

A. For crucibles in which *acids* are employed : and for galvanic batteries.

Q. *Why are CRUCIBLES (in which acids are employed) made of PLAT'INUM ?*

A. Because the acid would act upon *other metals*, or upon *glass*; and prevent the experimenter's success.

Q. Which of the METALS have the GREATEST affinity for OXYGEN?

A. Those called *potas'sium* and *so'dium*.

Potas'sium and so'dium derive their names from potash and soda. Potas'sa is the oxide of potas'sium; and soda is the oxide of so'dium.

Q. How is the affinity of *potas'sium* and *so'dium* for oxygen shown?

A. They *decompose water* immediately they are brought into contact with it.

Q. What EFFECT has POTAS'SIUM on WATER?

A. It catches *fire* the moment it is thrown into water, and burns with a vivid flame—which is still further increased by the combustion of *hydrogen*, separated from the water.

N. B. Water is composed of oxygen and hydrogen; and potas'sium *separates* the two gases.

Q. What effect has SO'DIUM on WATER?

A. It does not take *fire*, as potassium does; but undergoes very rapid *oxidation*.

Q. Is the FURR of KETTLES an oxide?

A. No; the furr (or deposit of boiling water) is a precipitate of *lime and mineral salt*, separated from the water by the process of boiling.



Q. *Is not this FURR of boiling water often DANGEROUS?*

A. Yes; especially in *tubular boilers*, such as those employed in railways.

Q. *Why is this FURR especially TROUBLESOME in RAILWAY engines?*

A. Because it is a *bad conductor of heat*; in consequence of which, it hinders the *evaporating effect* of the fire, and prevents the economy of fuel.

Q. *Why is this FURR especially DANGEROUS in RAILWAY engines?*

A. Because, when it is deposited in the boilers, they are likely to become *over-heated*; and then *explosion* will take place, from the sudden generation of highly elastic steam.

Q. *Why cannot RAILWAY engines be fed with BRACKISH WATER?*

A. Because *brackish* water contains *mineral salt*; which makes a much larger deposit of furr than water which contains *only vegetable matters*.

## CARBONIC ACID GAS.

## CHAPTER XXI.

Q. *What is CARBONIC ACID GAS?*

A. A gas formed by the union of *carbon* and *oxygen*: It used to be called "FIXED AIR."

3 lbs. of carbon and 8 lbs. of oxygen will form 11 lbs. of carbonic acid.

Q. *Under what circumstances does CARBON most readily UNITE with OXYGEN?*

A. 1st — When its *temperature* is *raised*: Thus if carbon be *red-hot*, oxygen will most readily unite with it: and

2dly—When it forms part of the fluid *blood*.

Q. *Why do oxygen and carbon so readily unite in the BLOOD?*

A. Because the atoms of carbon are *so loosely attracted* by the *other* materials of the blood, that they unite very readily with the oxygen of the air inhaled.

Q. *Is carbonic acid WHOLESOME?*

A. No; it is *fatal to animal life*; and (whenever it is inhaled) acts like a narcotic poison—producing drowsiness, which sometimes ends in death.

Q. *How can any one KNOW, if a place be infected with CARBONIC ACID GAS?*

A. If a pit or well contain carbonic acid, *a candle* (let down into it) will be *instantly extinguished*. The rule, therefore, is this—Where a *candle will burn, a man can live*; but *what will extinguish a candle, will also destroy life*.

Q. *Why does a MINER lower a CANDLE into a mine, before he descends?*

A. Because the *candle will be extinguished*, if the mine contains carbonic acid gas: but if the candle is *not extinguished*, the mine is *safe*, and the man may fearlessly descend.

Q. *Why does a CROWDED ROOM produce HEAD-ACHE?*

A. Because we breathe air *vitiated* by the crowd.

Q. *Why is the AIR of a room VITIATED by a CROWD?*

A. Because it is deprived of its due proportion of *oxygen*, and laden with *carbonic acid*.

Q. *How is the air of a room affected thus by a crowd?*

A. The *elements* of the air inhaled are *separated* in the *lungs*:—the *oxygen* is converted in the blood into *carbonic acid*; and the carbonic acid (together with the nitrogen) is thrown back again by the breath into the room.

Q. *Is ALL the NITROGEN REJECTED by the lungs?*

A. Yes; *all* the nitrogen of the air is always *expired*.

Q. *Why is a CROWDED ROOM UNWHOLESOME?*

A. Because the oxygen of the air is *absorbed* by the *lungs*; and carbonic acid gas (which is a noxious poison) is substituted for it.

Q. *Mention the historical circumstances, so well known in connexion with the "BLACK HOLE of CALCUTTA."*

A. In the reign of George II., the Raja (or Prince) of Bengal\* marched suddenly to Calcutta, to drive the English from the country; as the attack was unexpected, the English were obliged to submit, and 146 persons were taken prisoners.

Q. *What became of these prisoners?*

A. They were driven into a place about 18 feet square, and 15 or 16 feet in height, with only two small grated windows. 123 of the prisoners died in one night; and (of the 23 who survived) the larger portion died of putrid fevers, after they were liberated.

Q. *Why were so many persons SUFFOCATED in*

---

\* The Sur Raja, at Dowlat; a young man of violent passions, who had but just succeeded to the throne. A. D. 1756.

a few hours, from confinement in this close, not PRISON-HOLE?

A. Because the *oxygen* of the air was soon *consumed* by so many lungs, and its place supplied by *carbonic acid*, exhaled by the hot breath.

Q. Why did the captives in the BLACK HOLE die SLEEPING?

A. 1st—Because the *absence of oxygen* quickly affects the vital functions, depresses the nervous energies, and produces a lassitude which ends in death: and

2dly — *Carbonic acid gas* (being a narcotic poison) produces *drowsiness* and *death*, in those who inhale it.

Q. Why are the JUNGLES of Java and Hindostan so FATAL to life?

A. Because vast quantities of *carbonic acid* are thrown off by decaying *vegetables* in these jungles; and (as the wind cannot penetrate the thick brushwood to blow the pernicious gas away) it *settles* there, and destroys animal life.

Q. Why do persons in a crowded CHURCH feel DROWSY?

A. 1st—Because the crowded congregation *inhale a large portion* of the *oxygen* of the air, which alone can sustain vitality and healthy action: and

2dly—The air of the church is impregnated with carbonic acid gas, which (being a strong narcotic) produces drowsiness in those who inhale it.

Q. *Why do PERSONS who are much in the OPEN AIR enjoy the best HEALTH?*

A. Because the air they inhale is *much more pure*.

Q. *Why is COUNTRY AIR more PURE than the air in CITIES?*

A. 1st—Because there are fewer inhabitants to vitiate the air :

2dly—There are more trees to restore the equilibrium of the vitiated air : and

3dly—The free circulation of air keeps it pure and wholesome : (In the same way as running streams are pure and wholesome, while stagnant waters are the contrary.)

Q. *Why does the SCANTINESS of a country POPULATION render the COUNTRY AIR more PURE?*

A. Because the fewer the inhabitants, the *less carbonic acid* will be exhaled ; and thus country people inhale *pure oxygen*, instead of air impregnated with the narcotic poison, called carbonic acid gas.

Q. *Why do TREES and FLOWERS help to make country AIR WHOLESOME?*

A. 1st—Because trees and flowers

*absorb the carbonic acid*, generated by the lungs of animals, putrid substances, and other obnoxious exhalations: and

2dly—Trees and flowers restore to the air the *oxygen*, which has been inhaled by man and other animals.

Q. *Why is the AIR of CITIES LESS wholesome, than COUNTRY air?*

A. 1st—Because there are more *inhabitants* to vitiate the air:

2dly—The *sewers, drains, bins, and filth* of a *city*, very greatly vitiate the air:

3dly—The streets and alleys prevent a free circulation: and

4thly—There are fewer trees to absorb the excess of carbonic acid gas, and restore the *equilibrium*.

Q. *Why are PERSONS, who live in CLOSE ROOMS and crowded CITIES, generally SICKLY?*

A. Because the air they breathe is not pure, but is (in the 1st place) *defective in oxygen*; and (in the 2d) is impregnated with *carbonic acid gas*.

Q. *Where does the CARBONIC ACID of close ROOMS and CITIES come from?*

A. From the lungs of the inhabitants, the sewers, drains, and other like places, in which organic substances are undergoing *decomposition*.

Q. *What BECOMES of the CARBONIC ACID of crowded cities?*

A. Some of it is *absorbed by vegetables*; and the rest is *blown away* by the *wind*, and diffused through the whole volume of the air.

Q. *Does not this constant diffusion of carbonic acid affect the PURITY of the WHOLE AIR?*

A. No; because it is wafted by the wind from place to place, and *absorbed* in its passage by the *vegetable world*.

Q. *What is CHOKE DAMP?*

A. *Carbonic acid gas* accumulated at the bottom of wells and pits, which renders them noxious, and often fatal to life.

Q. *Why is not this carbonic acid TAKEN UP by the AIR and DIFFUSED, as it is in cities?*

A. Because (being *heavier than common air*) it cannot *rise from the well or pit*: and no wind can get to it, to blow it away.

Q. *Why are PERSONS sometimes KILLED by leaning over BEER VATS?*

A. Because vats (where beer has been made) contain a large quantity of *carbonic acid gas*, produced by the "*viscous fermentation*" of the beer; and when a man incautiously *leans over a*



*beer vat*, and inhales the carbonic acid, he is immediately *killed* thereby.

Q. *Why are PERSONS often KILLED, who enter BEER VATS to clean them?*

A. Because carbonic acid (being heavier than *atmospheric air*) often rests upon the *bottom of a vat*: when, therefore, a person enters the vat, and *stoops to clean the bottom*, he inhales the pernicious gas, which *kills* him.

Q. *Why are PERSONS sometimes KILLED, by having a CHARCOAL FIRE in their bedrooms?*

A. Because the *carbon of the burning charcoal* unites with the *oxygen of the air*, and forms *carbonic acid gas*, which is a narcotic poison.

Q. *If carbonic acid settles at the BOTTOM of a room, how can it injure a person LYING upon a BED, raised considerably above the floor?*

A. Because all gases *diffuse* themselves *through each other*, as a drop of *ink* would diffuse itself through a cup of water. If, therefore, a person slept for 6 or 8 hours in a room containing carbonic acid, quite enough of the gas will be diffused throughout the room to produce death.

The *heat* of the fire assists the process of diffusion.

Q. *What are the chief SOURCES of CARBONIC ACID?*

A. 1st—The breath of animals.

2dly—The decomposition of vegetable and animal matter.

3dly—Lime-stone, chalk, and all calcareous stones,—in which it exists in a *solid* form.

Q. *From which of these sources is CARBONIC ACID most likely to ACCUMULATE to a noxious extent?*

A. From the fermentation and putrefaction of decaying vegetable and animal matters.

Q. *How can this ACCUMULATION of CARBONIC ACID be PREVENTED?*

A. By throwing *quick-lime* into places, where such fermentation and putrefaction are going on.

Q. *How will QUICK-LIME PREVENT the accumulation of CARBONIC ACID?*

A. Quick-lime will *absorb* the carbonic acid; and produce a combination called “carbonate of lime.”

Q. *Does not heavy RAIN prevent the ACCUMULATION of CARBONIC ACID, as well as quick-lime?*

A. Yes; an abundant supply of *water* will prevent the accumulation of carbonic acid, by *dissolving* it.

N. B. Red heat (as a pan of red-hot coals, or a piece of red-hot iron) will soon absorb the carbonic acid gas, accumulated in a pit or well.

Q. *What effect has CARBONIC ACID on the WATER in which it is dissolved?*

A. It renders it slightly *acid* to the taste.

Q. Can the CAPACITY of water for dissolving carbonic acid be increased?

A. Yes. Carbonic acid may be *forced* into water by *pressure* to a considerable extent.

Q. To what practical USES has this capacity of water (for dissolving carbonic acid) been applied?

A. *Effervescing draughts* are made upon this principle.

Q. Explain the cause of EFFERVESCENCE in these beverages?

A. The carbonic acid of the beverage (being prevented by the cork from *escaping*) is *forced* into the liquor by *pressure*, and *absorbed* by it: but when the cork (or *pressure*) is removed, some of the carbonic acid flies off in *bubbles* or *effervescence*.

Q. Why does AERATED WATER *effervesce* when the CORK is removed?

A. While the bottle remains *corked*, carbonic acid is *forced* into the water by *pressure*, and *absorbed* by it: but, when the cork (or *pressure*) is *removed*, some of the carbonic acid flies off in *effervescence*.

Q. Why does SODA WATER *effervesce*?

A. In soda water there is forced 8

times its own bulk of carbonic acid gas, which makes its escape in *effervescence*, as soon as the *cork is removed*.

Q. *Why does GINGER POP fly about in froth, when the string of the cork is cut?*

A. Because it contains carbonic acid gas. While the *cork is fast*, the carbonic acid is *forced into* the liquor; but when the *pressure is removed* the gas is given off in *effervescence*.

N. B. All vinous fermentation produces carbonic acid.

Q. *Why does BOTTLED ALE froth more than DRAUGHT ale?*

A. Because the *pressure* is greater in a *bottle* than in a tub which is continually tapped; and *effervescence* is always increased by *pressure*.

Q. *What produces the FROTH of BOTTLED PORTER?*

A. *Carbonic acid* generated by the *vinous fermentation* of the *porter*: This gas is *absorbed* by the *liquor*, so long as the bottle is well *corked*; but is given off in froth, when the pressure of the cork is removed.

Q. *What gives the pleasant ACID taste to soda water, ginger beer, champagne, and cider?*

A. The presence of *carbonic acid*, generated by fermentation; and liberat-

ed by effervescence, when the pressure of the cork is removed.

Q. *Why does fresh SPRING WATER SPARKLE, when poured from one vessel to another?*

A. Because fresh spring and pump water contain carbonic acid; and it is the presence of this gas which makes the water *sparkle*.

Much of the froth and bubbling of ale, beer, WATER, &c., when they are "poured high," is due to simple *mechanical* action.

Q. *What is the FERMENTATION of BEER and WINE?*

A. The escape of carbonic acid, produced by the change of *sugar* into *al'cohol*.

Q. *What is AL'COHOL?*

A. The *spirit* of beer and wine, obtained by fermentation.

Q. *Of what ELEMENTS is AL'COHOL composed?*

A. Of carbon, oxygen, and hydrogen.

Of AL'COHOL, 4 parts are carbon, 2 oxygen, and 6 hydrogen.

Q. *What are the ELEMENTS of grape SUGAR?*

A. Carbon, oxygen, and hydrogen, all in equal proportions.

Q. *What CHANGES does SUGAR undergo by FERMENTATION?*

A. It is first decomposed, and then its elements re-unite in different proportions, producing *al'cohol*, *carbonic acid*, and *water*.

Of SUGAR, one portion is alcohol; and another carbonic acid; as may be seen by the following table.

	Carb.	Oxy.	Hyd.
Every atom of anhydrous sugar contains	12	12	12
Two atoms of alcohol contain	8	4	12
Four atoms of carbonic acid contain	4	8	0
	12	12	12

N. B. "Anhydrous sugar" is sugar *dried* at 300°.

Q. *How does SUGAR form AL'COHOL by fermentation?*

A. *Two-thirds* of its carbon and *one-third* of its oxygen re-unite with the hydrogen, and generate *alcohol*.

Q. *How does SUGAR form CARBONIC ACID by fermentation?*

A. The remaining *one-third* of its carbon and *two-thirds* of its oxygen re-unite, and generate *carbonic acid*.

Q. *What BECOMES of the AL'COHOL which is thus generated by fermentation?*

A. It mixes with the *water*, and forms the *intoxicating* part of beer and wine.

Q. *What becomes of the CARBONIC ACID, which is generated by fermentation?*

A. It makes its *escape into the air*.

Q. *Why is BARLEY MALTED?*

A. Because *germination* is produced by the artificial heat; and in *germination*, the *starch* of the *grain* is converted into *sugar*.

Q. How is *barley malted*?

A. It is *moistened with water*, and *heaped up*; by which means, great heat is produced, which makes the *barley sprout*.

(See "spontaneous combustion.")

Q. Why is not the BARLEY suffered to GROW as well as SPROUT?

A. Because plants in the *germ* contain more sugar than in any *other* state: as soon as the germ *puts forth shoots*, the *sugar* of the plant is *consumed*, to support the shoot.

Q. How is BARLEY PREVENTED from SHOOTING in the process of MALTING?

A. It is put into a *kiln*, as soon as it sprouts; and the heat of the kiln checks or destroys the young shoot.

Q. What is YEAST?

A. The foam of beer (or of some similar liquor) produced by *fermentation*.

Q. Why is YEAST used in BREWING?

A. Because it consists of a substance called *glu'ten*, undergoing putrefaction; in which state it possesses the peculiar property of exciting *fermentation*.

If the gluten were not in a putrefying state, it could not produce fermentation.

Q. What is *glu'ten*?

A. A tough, elastic substance, com-

posed of carbon, oxygen, hydrogen, and nitrogen.

Q. *Does MALT contain glu'ten?*

A. Yes. The infusion of malt, called "sweet-wort" contains an *abundance* of glu'ten; and the yeast (which converts its *sugar* into *al'cohol*) converts this *glu'ten* into *yeast*.

Q. *Why is YEAST needful in order to make malt into BEER?*

A. Because the presence of a putrefying body containing nitrogen is essential, in order to convert sugar into al'cohol.

Q. *What EFFECT has yeast upon the SWEET-WORT?*

A. It causes the SUGAR to be converted into *al'cohol* and *carbonic acid*; and its GLUTEN into yeast.

Q. *What change is produced in gluten by PUTREFACTION?*

A. Its elements are loosened from their former *conditions of combination*, and re-arranged (with the addition of oxygen from the air) into a *new series*.

Q. *What is the DIFFERENCE between FERMENTATION and PUTREFACTION?*

A. FERMENTATION is a change effected in the elements of a body composed of carbon, oxygen, and hydrogen,



*without nitrogen.* PUTREFACTION is a change effected in the elements of a body composed of carbon, oxygen, hydrogen, and *nitrogen*.

Q. What NEW COMPOUNDS are produced by the change called FERMENTATION?

A. *Alcohol* and *carbonic acid*.—The alcohol is still further changed (unless the process be checked) into *acetic acid* or *vinegar*.

Q. What new compounds are produced by the change called PUTREFACTION?

A. The carbon, oxygen, hydrogen, and nitrogen, of the original substance (being separated by decomposition) reunite in the following manner. 1. Carbon and oxygen unite to form *carbonic acid*. 2. Oxygen and hydrogen unite to form *water*. 3. Hydrogen and nitrogen unite to form *ammonia*.

*Hartshorn* is a solution of ammonia in water.

N. B. When bodies containing sulphur and phosphorus putrefy, the *sulphur* and *phosphorus* unite with *hydrogen*, and form *sulphuretted* and *phosphuretted hydrogen* gases.

Q. What BECOMES of these several products of putrefaction?

A. They are all elastic bodies, and escape into the air.

N. B. *Water* is elastic and gaseous when in the condition of *vapor*.

Q. What is the cause of the OFFENSIVE SMELL which issues from putrefying bodies?

A. The evolution of *ammonia*, or of *sulphuretted* and *phosphuretted hydrogen* gases; all of which have pungent and offensive odors.

Q. *Why do boiled EGGS DISCOLOR a SILVER SPOON?*

A. Because they contain a small portion of *sulphur*, which *unites with the silver* (for which it has a great *affinity*) and *tarnishes it*.

Both the white and yolk contain sulphur—the latter more abundantly.

Q. *What causes the offensive smell of STALE hard boiled EGGS?*

A. The *hydrogen* of the egg combining with the *sulphur* and phosphorus, form *sulphuretted* and *phosphuretted hydrogen*; both of which gases have an offensive odor.

Of an egg 55 parts are carbon, 16 nitrogen, 7 hydrogen, and the remaining 22 are oxygen, phosphorus, and sulphur.

Q. *Why is it NOT needful to put YEAST into GRAPE juice, in order to produce fermentation?*

A. Because grape juice contains a sufficient quantity of a nitrogenized substance (like *yeast*) to produce fermentation.

Nitrogenized, i. e., containing nitrogen.

Q. *Why do NOT GRAPES ferment, while they hang on the VINE?*

A. Because the *water of the juice* evaporates through the skin, and allows the grapes to shrivel and dry up, after they are ripe.

Fermentation cannot occur unless the sugar be dissolved in a sufficient quantity of *water*.

Q. *What is the FROTH or SCUM of fermented LIQUORS?*

A. Putrefying glutinous substances (of a nature similar to yeast), which rise to the surface from their *lightness*.

Q. *Why is BEER FLAT if the cask be left open too long?*

A. Because too much of the *carbonic acid gas* (produced by fermentation) is suffered to escape.

Q. *Why are BEER and PORTER made STALE by being exposed to the AIR?*

A. Because too much of the *carbonic acid gas* (produced by fermentation) is suffered to escape.

Q. *Why does BEER turn FLAT if the VENT PEG be left out of the tub?*

A. Because the *carbonic acid gas* escapes through the vent hole.

Q. *Why will NOT beer RUN OUT of the tub till the VENT PEG is taken out?*

A. Because the upward pressure of the external air (admitted through the *tap*) holds the liquor back—not being

counterbalanced by any pressure of air on the *surface* of the liquid.

The *upward* pressure of air is illustrated by the following simple experiment:—Fill a wine glass with water; cover the top of the glass with a piece of writing paper turn the glass upside down, and the water will not run out. The paper is used merely to give the air a medium sufficiently dense to act against.

Q. *Why does the BEER RUN FREELY, immediately the VENT PEG is taken out?*

A. Because air rushes immediately *through the vent hole at the top of the tub*, to counterbalance the air admitted by the tap; in consequence of which the liquid escapes by its own downward pressure.

Q. *Why does liquor flow reluctantly out of a BOTTLE held upside down?*

A. Because the *upward pressure of the air* prevents the liquor from flowing out.

Q. *Why should a bottle be held OBLIQUELY in order to be emptied of its liquor?*

A. Because *air* will then *flow into the bottle*, and help the liquor out, by *counterbalancing the upward pressure*.

Q. *Why does wine (poured from a bottle QUICKLY) SPIRT about, without going into the decanter?*

A. Because it fills the *top of the decanter* (like a *cork*), and leaves *no room*.

for the air inside *to escape* ; the decanter, therefore, (being *full of air*) refuses to admit the *wine*.

Q. *Why does the EFFERVESCENCE of soda water and ginger beer so soon go off?*

A. Because the *carbonic acid*, (which produced the effervescence) very rapidly *escapes* into the air.

Q. *Why is BOILED WATER FLAT and insipid?*

A. Because the whole of the *carbonic acid* is expelled by boiling, and escapes *into the air*.

Q. *Why does YEAST make BREAD LIGHT?*

A. Because it produces a species of fermentation on the starch and gluten of flour, as it does in the sugar of malt.

Q. *How does FERMENTATION make the DOUGH RISE?*

A. During fermentation, *carbonic acid gas is evolved* ; but the sticky texture of the dough will not allow it to *escape* ; so it *forces up little bladders* all over the dough.

Q. *Why is DOUGH placed BEFORE the FIRE?*

A. 1st—Because the heat of the fire *increases the fermentation* ; and

2dly—It *expands the gas*, confined in the little bladders ; in consequence of which, the bladders are *enlarged*, and

the dough becomes lighter and more porous.

Q. *Why is BREAD HEAVY, if the dough be removed from the fire?*

A. Because the dough gets cold, and then the air in the bladders condenses—the paste falls—and the bread becomes close and heavy.

Q. *What causes the HEAT of FIRE?*

A. The carbon of fuel (when heated) combines with the oxygen of the air, and produces carbonic acid gas: Again, the hydrogen of the fuel combining with other portions of oxygen, condenses into water; by which chemical actions heat is evolved.

Q. *What causes the HEAT of our own BODY?*

A. The carbon of our blood combines with the oxygen of the air inhaled, and produces carbonic acid gas; which evolves heat in a way similar to burning fuel.

Q. *Whence does the HEAT of a DUNGHILL arise?*

A. As the straw, &c., of the dunghill decays, it undergoes fermentation, which produces carbonic acid gas; and heat is evolved by a species of combustion, (as in the two former cases.)

Q. *How does the formation of CARBONIC ACID (in all these cases) produce HEAT?*

A. *Carbonic acid* has less power of holding *latent heat* than *carbon* and *oxygen* have: When, therefore, these elements are changed into carbonic acid, latent heat is given off, and made *sensible*.

Q. *Why do persons throw LIME into BINS and SEWERS, to PREVENT their offensive SMELL, in summer time?*

A. Because they contain large quantities of *carbonic acid gas*, which readily *combines with lime*; and producing "*carbonate of lime*," neutralizes the offensive gases.

Q. *Why should WATER (used for washing) be exposed to the air?*

A. Because it is made more *soft* by exposure to the air.

Most spring water holds lime in solution as a *bicarbonate*, in consequence of the presence of abundant carbonic acid. Carbonic acid escapes by exposure to air—and the lime is, consequently, deposited as a carbonate.

Q. *Why is hard WATER made more SOFT by exposure to air?*

A. 1st—Because the *mineral salts* (which cause its hardness) *subside*: and  
2dly—Because the carbonic acid of the water makes its escape into the air.

Q. *How is the carbonic acid of water produced?*

A. From the presence of *lime*, which is frequently held in solution by hard water: When the carbonic acid *escapes* by exposure to the air, the *lime* is deposited as a *carbonate*.

Q. *Why is HARD WATER more agreeable to DRINK than soft water?*

A. Chiefly because it contains carbonic acid.

Q. *Why is water FRESH from the pump more SPARKLING, than after it has been drawn some time?*

A. Because water fresh from the pump contains carbonic acid, which soon escapes into the air, and leaves the water flat and stale.

Q. *Why is QUICK-LIME formed by burning chalk and marl in a KILN?*

A. Because the *carbonic acid* (which rendered it *mild*) is driven off by the heat of the kiln: and the lime becomes *quick* or *caustic*.

Q. *What is MORTAR?*

A. Quick-lime mixed with sand and water.

Q. *Wherein does LIME-STONE differ in appearance from quick-lime?*

A. LIME-STONE is a hard, *rocky* substance; but QUICK-LIME a loose *powder*.

Q. *Why does MORTAR become HARD after a few days?*



A. Because the lime *re-imbibes* from the air the carbonic acid which had been *expelled by fire*; and the loose *powder* again becomes as hard as the original *lime-stone*.

Q. *Explain in what way MORTAR is adhesive.*

A. When the carbonic acid is expelled, the hard lime-stone is *converted into a loose powder*, which (being mixed with sand and water) becomes a *soft and sticky plaster*; but as soon as it is placed between bricks, it *imbibes carbonic acid again*, and hardens into *lime-stone*.

---

## CARBURETTED HYDROGEN GAS.

### CHAPTER XXII.

Q. *What is CHOKE-DAMP?*

A. *Carbonic acid gas* accumulated at the bottom of wells and pits. It is called *CHOKE damp*, because it *chokes* (or suffocates) *every animal* that attempts to *inhale it*. (See p. 238.)

It suffocates without getting into the *lungs*, by closing the outer orifice *spasmodically*.

Q. *What is marsh-gas or FIRE-DAMP?*

A. *Carburetted hydrogen gas* accu-

culated on marshes, in stagnant waters, and coal-pits; it is frequently called "inflammable air."

Q. *What is CARBURETTED HYDROGEN GAS?*

A. *Carbon combined with hydrogen.*

Q. *How may CARBURETTED HYDROGEN GAS be PROCURED on marshes?*

A. *By stirring the mud at the bottom of any stagnant pool, and collecting the gas (as it escapes upwards) in an inverted glass vessel.*

Q. *What is COAL GAS?*

A. *Carburetted hydrogen extracted from coals by the heat of fire.*

Q. *Why is carburetted hydrogen gas called FIRE-DAMP or inflammable air?*

A. *Because it very readily catches fire and explodes, when a light is introduced to it.*

Provided atmospheric air be present.

Q. *Why is carburetted hydrogen gas frequently called MARSH-GAS?*

A. *Because it is generated in meadows and marshes from putrefying vegetable substances.*

See ignis fatuus, p. 266.

Q. *What gas is evolved by the WICK of a burning CANDLE?*

A. *Carburetted hydrogen gas: The carbon and hydrogen of the tallow com-*

*bine into a gas from the heat of the flame; and this gas is called carburetted hydrogen or inflammable air.*

Q. *Why do COAL-MINES so frequently EXPLODE?*

A. Because the *carburetted hydrogen gas* (which is generated in these mines by the coals) explodes, when a light is incautiously introduced.

Q. *How can miners SEE in the coal-pits if they may never introduce a LIGHT?*

A. Sir Humphrey Davy invented a lantern for the use of miners, called "the Safety Lamp," which may be used without danger.

Q. *Who was SIR HUMPHREY DAVY?*

A. A very clever chemist, born in Cornwall, 1778, and died in 1829.

Q. *What kind of thing is the SAFETY-LAMP?*

A. A kind of lantern, *covered with a fine gauze wire*, instead of glass or horn.

Q. *How does this fine GAUZE WIRE prevent an EXPLOSION in the coal-mine?*

A. By preventing the flame of the lamp from communicating with the inflammable gas of the mine.

N. B. The interstices of the gauze wire must not exceed the 7th of an inch in diameter.

Q. *Why will not FLAME PASS THROUGH very fine wire GAUZE?*

A. Because the metal wire is a very *rapid conductor of heat*; and when the flame (of gas burning in the lamp) reaches the wire gauze, so much heat is *conducted away by the wire*, that the flame is *extinguished*.

Q. *Does the gas of the COAL-PIT get THROUGH the wire gauze INTO the LANTERN?*

A. Yes; and the inflammable gas ignites, and burns *inside the lamp*: As soon as this is the case, *the miner is in danger*, and should withdraw.

Q. *Why is the miner in DANGER if the gas ignites and burns in the INSIDE of the safety lamp?*

A. Because the heat of the burning gas will soon *destroy the wire gauze*; and then the flame (being free) will set fire to the mine.

N. B. When the carburetted hydrogen gas takes fire from the miner's candle, the miner sometimes perishes in the *blast of the flame*, and sometimes suffers *suffocation* from the carbonic acid which is thus produced.

## PHOSPHURETTED HYDROGEN GAS.

### CHAPTER XXIII.

Q. *From what do the very OFFENSIVE EFFLUVIA of CHURCH-YARDS arise?*

A. From a gas called PHOSPHURETTED HYDROGEN; which is *phosphorus* combined with *hydrogen gas*.

Q. *What is PHOSPHORUS?*

A. A pale amber-colored substance, resembling wax in appearance. The word is derived from two Greek words, which mean "to produce or carry light." (*φως-φέρειν*).

Q. *How is PHOSPHORUS OBTAINED?*

A. By heating bones to a white heat; by which means, the animal matter and charcoal are *consumed*, and a substance called "*phosphate of lime*" is left behind.

Q. *What is the PHOSPHATE OF LIME?*

A. Phosphorus united to oxygen and lime; when *sulphuric acid* is added, and the mixture heated, the lime is attracted to the acid, and pure *phosphorus* remains.

If powdered charcoal be added, phosphorus may be procured by distillation.

Q. *Of what is the ignitable part of LUCIFER MATCHES made?*

A. Of phosphorus: and above 250 thousand lbs. are used every year in London alone, merely for the manufacture of lucifer matches.

Q. *Why does a PUTREFYING dead BODY SMELL so offensively?*

A. Because *phosphuretted hydrogen gas* always rises from putrefying animal substances.

The escape of *ammonia* and *sulphuretted hydrogen* contributes also to this offensive effluvia.

Q. *What is the cause of the IGNIS FATUUS, Jack o' Lantern, or Will o'the Wisp?*

A. This luminous appearance (which haunts meadows, bogs, and marshes) arises from the *gas of putrefying animal and vegetable substances*; especially from decaying fish.

Q. *What gases arise from these PUTREFYING substances?*

A. *Phosphuretted hydrogen* from putrefying animal substances: and

*Carburetted hydrogen*, from decaying vegetable matters. (See p. 262.)

Q. *How is the gas of the ignis fatuus IGNITED on bogs and meadows?*

A. Impure phosphuretted hydrogen bursts *spontaneously* into flame, whenever it mixes with *air* or *pure oxygen gas*.

*Pure phosphuretted hydrogen* will *not* ignite spontaneously—this spontaneous ignition is due to the presence of

A small quantity of the vapor of an exceedingly volatile liquid-compound of phosphorus with hydrogen, which is occasionally produced with the gas itself.

If phosphorus be boiled with milk of lime, and the beak of the retort be placed under water, bubbles of phosphuretted hydrogen will rise successively through the water, and (on reaching the surface) burst into flame.

Q. *Why does an ignis fatuus or Will o'the Wisp FLY from us when we RUN to MEET it ?*

A. Because we produce a current of air in front of ourselves, (when we run towards the ignis fatuus) which drives the light gas forwards.

Q. *Why does an ignis fatuus run AFTER us when we FLEE from it in a fright ?*

A. Because we produce a current of air in the way we run, which attracts the light gas in the same course ; drawing it after us as we run away from it.

Q. *Is not a kind of Jack o'Lantern sometimes produced by an INSECT ?*

A. Yes ; swarms of luminous insects sometimes pass over a meadow, and produce an appearance similar to the ignis fatuus.

Q. *May not many GHOST stories have arisen from some ignis fatuus lurking about church-yards ?*

A. Perhaps all the ghost stories (which deserve any credit at all) have arisen from the ignited gas of church-yards, lurking about the tombs ; to which fear has added its own creations.

## WIND.

## CHAPTER XXIV.

Q. *What is WIND?*

A. Wind is *air in motion*.

Q. *What PUTS the air in motion, so as to produce WIND?*

A. The principal causes are the *variations of heat and cold*, produced by the succession of *day and night*, and of the *four seasons*.

Q. *What effect has HEAT upon the air?*

A. Heat *rarefies* the air and causes it to expand.

Q. *How do you KNOW that heat causes the air to EXPAND?*

A. Thus, if a bladder *half full of air* (tied tight round the neck) be laid before a *fire*, the air will expand by the heat, and *fill* the bladder.

Q. *What EFFECT is produced upon air by RAREFACTION?*

A. It is made *lighter* and *ascends through colder strata*; as a cork (put at the bottom of a basin of water) rises to the surface.

Q. *Prove that rarefied air ASCENDS.*

A. When a boy sets fire to the cotton or sponge of his balloon, the flame *heats*



*the air* ; which becomes so *light*, that it ascends, and *carries the balloon with it*.

Q. *What effect is produced upon AIR by COLD?*

A. It is *condensed*, or squeezed into a smaller compass : in consequence of which, *it becomes heavier*, and descends towards the ground.

Q. *Prove that air is condensed by COLD.*

A. Lay a bladder half full of air before a fire, till it has become fully *inflated* ; if it be now removed *from the fire*, the bladder will *collapse* again, because the air condenses into its former bulk.

Q. *What is meant by the bladder "COLLAPSING?"*

A. The skin becoming *wrinkled, shrivelled, and flabby* ; because there is not sufficient air inside to *fill* it.

Q. *How do you KNOW that CONDENSED air will DESCEND?*

A. Because a fire balloon *falls* to the earth, so soon as the spirit in the cotton is *burnt out*, and the air of the balloon has become *cold again*.

Q. *Does the SUN HEAT the AIR as it does the EARTH?*

A. No ; the air is *not heated* by the *rays of the sun* ; because air (like water) is a very *bad conductor*.

Q. *How is the AIR HEATED?*

A. By *convection*, thus :—The *sun* heats the *earth*; and the *earth* heats the *air resting upon it*; the air thus heated *rises*, and is succeeded by *other air*, which is heated in a similar way; till the whole volume is *warmed* by “convective currents.”

Q. *What is meant by “CONVECTIVE CURRENTS” of hot air?*

A. Streams of air heated by the earth, which *rise upwards*, and *carry heat with them*. (See p. 226.)

Q. *Is the air in a ROOM in perpetual motion as the air ABROAD is?*

A. Yes; there are always *two currents of air* in the room we occupy; one of *hot air* flowing *out* of the room, and another of *cold air* flowing *into* the room.

Q. *How do you KNOW that there are these two currents of air in every occupied ROOM?*

A. If I hold a lighted candle near the crevice at the *top of the door*, the flame will be blown *outward* (towards the *hall*); but if I hold the candle at the *bottom of the door*, the flame will be blown *inwards* (into the *room*).

N. B. This is not the case if a *fire* be in the room. When a fire is lighted, an inward current is drawn through *all* the crevices.

Q. *Why would the flame be blown OUTWARDS*

(towards the HALL), if a candle be held at the TOP of the door?

A. Because the air of the room being heated, &c., *ascends*; and (floating about the upper part of the room) some of it escapes *through the crevice at the top of the door*, producing a current of air *outwards* (into the hall).

Q. *Why would the flame be blown INWARDS (into the ROOM), if the candle be held at the BOTTOM of the door?*

A. Because a partial *vacuum* is made at the *bottom of the room*, as soon as the warm air of the room has ascended to the ceiling, or made its escape from the room: and cold air from the hall *rushes under the door*, to supply the void.

Q. *What is meant by a "partial VACUUM being made at the BOTTOM of the ROOM?"*

A. A vacuum means a place *from which the air has been taken*: and a "partial vacuum" means a place from which a *part* of the air has been taken away. Thus, when the air on the floor *ascends* to the ceiling, a partial vacuum is made on the *floor*.

Q. *And how is the VACUUM filled up again?*

A. It is filled up by *colder* air, which *rushes* (under the *door*, and through the *window crevices*) into the room.

Q. Give me an ILLUSTRATION.

A. If I dip a pail into a pond and fill it with water, a hole (or vacuum) is made in the pond as *big as the pail*; but the moment I *draw the pail out*, the hole is *filled up* by the water around.

Q. Show how this illustration APPLIES.

A. The heated air, which ascends from the bottom of a room, is as much taken away as the water in the pail; and (as the void was instantly supplied by *other water in the pond*) so the *void of air is supplied* by the air around.

Q. What is the CAUSE of WIND?

A. The *sun* heats the *earth*, and the *earth* heats the *air* resting upon it; as the warm air ascends, the void is filled up by a *rush of cold air* to the place; and this *rush of air* we call WIND.

Q. Does the WIND ALWAYS blow?

A. Yes; there is always *some* motion in the air; but the *violence* of the motion is perpetually varying.

Q. Does the rotation of the earth upon its axis affect the motion of the air?

A. Yes, in two ways. 1st—As the earth moves round its axis, the *thin* moveable air is left somewhat *behind*; and, therefore, seems (to a stationary

object) to be blowing in the *opposite* direction to the earth's motion: and

2dly—As the earth revolves, different portions of its surface are continually passing under the vertical rays of the sun.

Q. *When are the rays of the sun called "VERTICAL RAYS?"*

A. When the sun is in a *direct line* above any place, his rays are said to be "vertical" to that place.

Q. *Illustrate the manner in which the earth's surface passes under the vertical sun.*

A. Suppose the brass meridian of a globe to represent the vertical rays of the sun; as you turn the globe round, *different parts* of it will pass under the brass rim, in constant *succession*.

Q. *Why is it NOON-DAY to the place over which the SUN is VERTICAL?*

A. Because the sun is *half-way* between rising and setting to that place.

Q. *Show how this ROTATION of the earth affects the AIR.*

A. If we suppose the brass meridian to be the vertical sun, the whole column of air *beneath* will be heated by the *noon-day rays*; that part which the sun has *left*, will become gradually *colder and colder*; and that part to which the sun

is *approaching*, will grow constantly *warmer and warmer*.

Q. Then there are THREE qualities of air about this spot?

A. Yes; the air over the place, which has *passed* the meridian, is *cooling*; the air under the *vertical sun* is the *hottest*; and the air, which is over the place *about to pass* under the meridian, is *increasing in heat*.

See fig. on next page. The column A (which the sun has passed) is *cooling*—B is under the *vertical sun*; and C is *increasing in heat*.

Q. How does this VARIETY in the HEAT of AIR produce WIND?

A. The air always seeks to *preserve an equilibrium*; so *cold air* rushes into the *void* made by the *upward current* of the *warm air*.

Q. Why does not the wind ALWAYS BLOW ONE way, following the direction of the SUN?

A. Because the direction of the wind is subject to perpetual interruptions from *hills*, and *valleys*, *deserts*, *seas*, &c.

Q. How can HILLS and MOUNTAINS ALTER the course of the WIND?

A. Suppose a wind (blowing from the north) comes to a mountain; as it cannot pass *through it*, it must either rush *back again*, or *fly off at one side*, (as a *marble*, when it strikes against a *wall*.)

Q. Do MOUNTAINS affect the wind in any OTHER way?

A. Yes; many mountains are *capped with snow*, and the *warm air is condensed*, when it comes in contact with them; but so soon as the *temperature of the wind is changed*, its *direction may be changed* also. (See *Fig.*)

THE SUN.

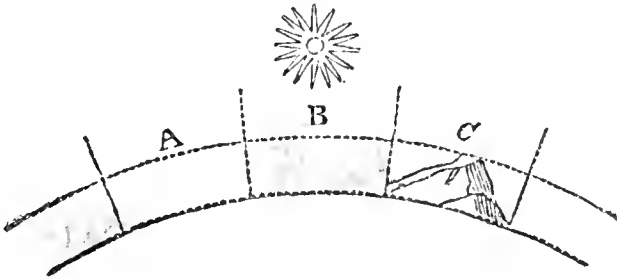

Suppose A B C to be *three columns of air*. A, the column of air which is *cooling down*; B, the column to which the *sun is vertical*; and C the column which is to be *heated next*. In this case the *cold air of A will rush towards B C*; because the air of B and C is *hotter than A*. But suppose now C to be a *snow-capped mountain*: As the *hot air of B reaches C*, it is *chilled*; and (being now *colder than the air behind*) it *rushes back again towards A*, instead of following the sun.

Q. How can the OCEAN affect the direction of the WIND?

A. When the ocean rolls beneath the *vertical sun*, the water is *not made so hot* as the *land*; in consequence of which, the general direction of the wind is directed from tracts of *ocean* towards tracts of *land*.

Q. Why is not the WATER of the sea made so

HOT, by the vertical sun, as the surface of the LAND?

A. 1st—Because the *evaporation* of the sea is greater than that of the land:

2dly—The constant *motion* of the water prevents the increase of temperature at the surface: and

3dly—The rays of the sun strike *into* the water; in consequence of which the immediate *surface* is much less affected.

Q. Why does the EVAPORATION of the sea prevent its surface from being HEATED by the vertical sun?

A. Because its heat is *absorbed* in the generation of *vapor* and carried off into the air.

Q. Why does the MOTION of the sea prevent its surface from being HEATED by the vertical sun?

A. Because each portion *rolls away*, as soon as it becomes heated, and is succeeded by *another*; and this constant motion prevents the *surface* of the sea from being *more* heated than the water *below* the surface.

Q. Do CLOUDS affect the WIND?

A. Yes. As passing clouds screen the direct heat of the sun from the earth, they diminish the *rarefaction* of the air *also*; and this is *another* cause why nei-



ther the strength nor direction of the wind is *uniform*.

Q. *Would the wind blow regularly from east to west, if these OBSTRUCTIONS were REMOVED?*

A. Without doubt. If the whole earth were covered with *water* the winds would always *follow the sun*, and blow uniformly in one direction.

Q. *Do winds EVER blow REGULARLY?*

A. Yes: in those parts of the world, which present a large surface of water, as in the Atlantic and Pacific Oceans.

Q. *What are the winds, which blow over the ATLANTIC and PACIFIC Oceans, called?*

A. They are called "Trade Winds."

Q. *Why are they called "TRADE WINDS."*

A. Because they are very convenient to merchants, who have to cross the ocean, inasmuch as they always blow in one direction.

Q. *In what DIRECTION do the TRADE WINDS blow?*

A. That in the *northern* hemisphere blows from the *north-east*; that in the *southern* hemisphere from the *south-east*.

Q. *Why do they not blow from the FULL NORTH and SOUTH?*

A. Because currents of air *flowing from the poles*, give them an *easterly* direction.

This effect is due in some measure to the rotation of the earth on its axis.

Q. *What is the cause of these currents of air from the POLES to the EQUATOR?*

A. The air about the equator constantly ascends, in consequence of being rarefied by the heat of the sun: as the hot equatorial air ascends, cold air from the north and south flows towards the equator, to restore the equilibrium.

Q. *Is there an UPPER as well as a LOWER CURRENT in the atmosphere?*

A. Yes; the *upper* current of rarefied air is *from the equator to the poles*; where it is condensed—and then returns again to the *equator*, forming the *lower* current.

Q. *These LOWER CURRENTS (from the poles to the equator) have an EASTERLY tendency. Explain the cause of this.*

A. All the atmosphere revolves *with the earth*; but when a current of air from the *poles* flows towards the *equator*, it comes to a part of the earth's surface which is moving *faster than itself*; in consequence of which it is *left behind*, and thus produces the effect of a current moving in the opposite direction.

Thus, to a person in a carriage, the hedges and trees seem to be running in an opposite direction.

As the circumference of the earth at the equator is

*much larger* than the circumference of the earth at the poles, therefore every spot of the earth's *equatorial* surface must move *much faster* than the corresponding one at the poles.

N. B. As the earth revolves on its axis from west to east, therefore the air which is carried with it will seem to blow *from the west*: As, however, the current of air from the poles seems to blow in the *opposite* direction, it will seem to blow from the *east* (or to be an *easterly* wind).

Q. *By what means are the north-east and south-east TRADE WINDS produced?*

A. By a combination of the two motions of the *polar currents*: which produces the intermediate directions of the *north-east* and *south-east*.

Q. *Are BOTH these motions of the polar currents REAL?*

A. No. The motion from the east to west is only *apparent*. As the earth revolves from *west* to *east*, the air carried with it will be a *west* wind; but the polar currents seem to blow in the *opposite direction*, merely because they have not *acquired the same velocity*.

Q. *Do trade winds blow from the north-east and south-east ALL the YEAR ROUND?*

A. Yes, *in the open sea*; that is, in the Atlantic and Pacific Oceans, for about  $30^{\circ}$  each side of the equator.

Q. *What do the north-easterly and south-easterly trade winds produce when they meet near the equator?*

A. A region of *calms*, in which thick

foggy air prevails, with sudden showers and thunder-storms.

Q. *Is this region of calms* FIXED *in its position?*

A. No; it shifts its place according to the sun's distance, and position in regard to the *equator*: being sometimes entirely to the *north* of the equator, and occasionally reaching as far as  $2^{\circ}$  *south* of it.

Q. *Do the TRADE WINDS blow uniformly from north-east and south-east in the INDIAN OCEAN?*

A. No; nor yet in those parts of the *Atlantic* and *Pacific* which verge on the continents.

Q. *How do the TRADE WINDS in the INDIAN OCEAN blow?*

A. From April to October a *south-west* wind prevails; but from October to April, a *north-east*.

Q. *What are these periodical currents of air (which affect the neighborhood of the Arabian, Indian, and Chinese Seas) called?*

A. They are called MONSOONS.

Q. *How far do the limits of the MONSOONS extend?*

A. They extend from the African shore to the longitude of New Guinea; and are felt *northward* as far as the parallel of latitude, which crosses the Loochoo Isles.

The Loochoo Isles are about  $24^{\circ}$  north latitude, and  $130^{\circ}$  east longitude.

Q. *Why do not the trade winds in the INDIAN OCEAN blow south-west from April to October?*

A. Because the air of Arabia, Persia, India, and China, *is so rarefied* by the enormous heat of their summer sun, that the cold air from the south rushes *towards these nations*, across the equator, (during these *six months*,) and produces a SOUTH-WEST wind.

Q. *To what distance does this SOUTH-WEST wind prevail?*

A. From  $3^{\circ}$  south of the equator, to the shores of the Arabian, Indian, and Chinese Seas.

Q. *Why do the trade winds (in the INDIAN OCEAN) blow north-east from October to April?*

A. Because the *southern part of the torrid zone* is most heated, when the sun has left the *northern* side of the equator for the *southern*: and the cold air from the north (rushing towards the southern tropic) is diverted into the direction of NORTH-EAST, where it continues for the *other six months* of the year.

Q. *Are the monsoons as POWERFUL as the trade winds?*

A. They are far *more* so, and very often amount to violent gales.

Q. *Why are the MONSOONS more USEFUL to the mariner than the fixed TRADE WINDS?*

A. Because the mariner is able to avail himself of these periodic changes, to go in *one* direction during *one* half of the year, and to *return* in the *opposite* direction during the *other* half.

Q. *How is the change of the monsoons marked?*

A. By an interval of alternating calms and storms.

Q. *When are the WINDS at the NORTH generally the HIGHEST?*

A. The winds in December and January are generally the highest. Those in February and November the next; and those in August and September are the *least* boisterous.

Q. *Why are the winds at the North generally HIGHEST in DECEMBER and JANUARY?*

A. Because the sun is *furthest south* in those months; and (as the heat in these northern regions rapidly *decreases*) the contrast between our temperature and that of the *torrid zone* is greater in December and January, than in any other two months throughout the year.

Q. *Why does this CONTRAST of heat increase the VIOLENCE of the WIND?*

A. Because the air always seeks to *preserve an equilibrium*; therefore the

greater the contrast, the more violent will be the rush of air to *equalize* the two volumes.

Q. *Why are the winds at the North generally most PLACID during the months of SEPTEMBER and AUGUST?*

A. Because August and September are the *warmest months*, when we approach nearest to the heat of the torrid zone; therefore the air (to and from the equator) *moves with less velocity* in our northern hemisphere in those two months than in any other.

Q. *Show the GOODNESS and WISDOM of GOD in this constant tendency of air to equilibrium.*

A. If the torrid zone were not tempered by cold air from the polar regions, *it would become so hot*, that no human being could endure it. If (on the other hand) the polar regions were never warmed by hot air from the torrid zone, they would soon become *insufferably cold*.

Q. *In what OTHER way does the mingling of the polar and equatorial atmosphere act BENEFICIA-  
LY?*

A. In the *equatorial* regions, the great abundance of *vegetable* life is productive of a very large amount of *oxy-  
gen*: In the *colder* regions, artificial *fires*

and dense masses of *animal life*, produce large quantities of *carbonic acid*: The mingling of the polar and equatorial atmosphere assists in supplying each of these regions with the very gas in which it would be otherwise defective.

Q. *How does the mingling of the POLAR and EQUATORIAL atmosphere serve to supply each region with the GAS it most requires?*

A. The *plants* of the EQUATORIAL regions require *carbonic acid*;—The *animals* of the COLDER regions require oxygen:—The currents of air from the *Poles* carry *carbonic acid* to the equatorial *plants*; and the currents of air from the *Equator* carry *oxygen* to the *animals* which abound nearer the *poles*.

Q. *Why are EAST WINDS in Europe, and WEST WINDS in the United States, generally DRY?*

A. Because they come over *vast continents*, and therefore absorb *very little water*; and being thirsty, they readily imbibe moisture from the air and clouds, and therefore *bring dry weather*.

Q. *Why is the NORTH WIND generally COLD?*

A. Because it comes from the *polar regions*, over mountains of snow and seas of ice.

Q. *Why are NORTH WINDS generally DRY and biting?*



A. Because they come from *colder* regions, and being *warmed* by the heat of our climate, *absorb moisture* from every thing they touch; in consequence of which, they are both *dry and parching*.

Q. *Why are SOUTH WINDS generally WARM?*

A. Because they come from the torrid zone, where they are much heated.

Q. *Why do SOUTH WINDS often bring RAIN?*

A. Because, coming from the torrid zone, they are much *heated*, and *imbibe water very plentifully*, as they pass over the Ocean.

Q. *How does this account for the RAINY character of SOUTH winds?*

A. As soon as they reach a cold climate they are *condensed*, and can no longer hold all their vapor in suspension; in consequence of which, some of it is deposited as rain.

Q. *Why are WEST WINDS in Europe, and EAST WINDS in the United States, generally RAINY?*

A. Because they come over the *Atlantic Ocean*, and are laden with *vapor*; if, therefore, they meet with the least *chill*, some of the vapor is deposited as rain.

Q. *Why is a fine CLEAR DAY sometimes OVERCAST in a few minutes?*

A. Because some *sudden change of temperature* has condensed the vapor of the air *into clouds*.

Q. *Why are CLOUDS sometimes DISSIPATED very suddenly?*

A. Because some *dry wind* (blowing over the clouds) *imbibes their moisture*, and carries it off in invisible vapor.

Q. *Why do SOUTH-EAST winds bring us RAIN?*

A. Because they come from the *torrid zone*, and get *laden with vapor* in their transit across the *ocean*. But when they reach our colder climate, (being condensed by the chill) some of the vapor is precipitated in rain.

Q. *Why do NORTH-WEST winds RARELY bring RAIN?*

A. Because they come from a climate *colder than our own*, and their capacity for imbibing vapor is *increased*, when they reach a warmer climate; in consequence of which, north-west winds *dry the air*, dispel the clouds, and promote evaporation.

Q. *Why does WIND sometimes bring RAIN and sometimes FINE weather?*

A. If the wind be *colder than the clouds*, it will condense their vapor into *rain*: But if the wind is *warmer than*

*the clouds, it will dissolve them, and cause them to disappear.*

Q. *What is the USE of dry MARCH winds?*

A. *They dry the soil, which is saturated with the floods of February, break up the heavy clods, and fit the land for the seed committed to it.*

Q. *Why is it said, that "MARCH COMES IN like a LION?"*

A. *Because it comes in with blustering winds, so essential to dry the soil, lest it rot the seeds committed to it.*

Q. *Why does "MARCH GO OUT like a LAMB?"*

A. *Because the water (evaporated by the high winds) falls again in showers, to fertilize the earth; and these constant showers break the violence of the winds.*

Q. *Why is it said, that "A bushel of MARCH DUST is worth a king's ransom?"*

A. *Because it indicates that there has been a continuance of dry weather; and unless March be dry, the seed will rot in the wet soil.*

Q. *Why is it said, "A DRY, cold MARCH never BEGS BREAD?"*

A. *Because the dry, cold winds of March prepare the soil for seeds; which germinate and produce fruit in the autumn.*

Q. *It is said, that "A WET MARCH makes a SAD autumn."* Explain the reason of this.

A. If *March* is *wet*, so much seed *rots* in the ground, that the autumn crops are spoiled.

Q. *It is said, that "MARCH FLOWERS make NO summer BOWERS."* Explain the reason of this.

A. If the *spring* be very *mild*, vegetation gets too forward, and is *pinched* by the *nightly frosts*, so as to produce neither fruits nor flowers.

Q. *It is said, "A LATE SPRING makes a FRUITFUL YEAR."* Explain the reason of this.

A. If the vegetation of spring be *backward*, the frosty nights will *do no harm*; for the fruits and flowers will not put forth their tender shoots, till the nights become *too warm to injure them*.

Q. *Why is it said, that "APRIL SHOWERS bring MAY FLOWERS?"*

A. Because April showers supply the principal nourishment, on which seeds depend for their development.

Before seeds can germinate, *three things* are essential:—Darkness, Heat, and Moisture.

Q. *Does RAIN-WATER possess any fertilizing properties, BESIDES that of mere MOISTURE?*

A. Yes; rain-water contains an abundance of *carbonic acid*, and a small quantity of *ammo'nia*; to which much of its fertilizing power may be attributed.

Ammonia is a compound of nitrogen and hydrogen. Common hartshorn is only ammonia and water.

Q. *Why is there MORE rain FROM SEPTEMBER to MARCH, than from March to September?*

A. Because the temperature of the air is *constantly decreasing*; on which account, its *capacity for holding vapor* is on the *decrease*, and the vapor is precipitated as rain.

Q. *What good purpose is effected under PROVIDENCE by this increase of rain in AUTUMN and WINTER?*

A. Because rain hastens the *putrefaction* of the *fallen leaves*; and this makes the earth fertile.

Q. *Why is there LESS rain FROM MARCH to SEPTEMBER, than from September to March?*

A. Because the temperature of the air is *constantly increasing*; on which account its *capacity for holding vapor* is on the *increase*, and very little is precipitated as rain.

Q. *Why is the RISING SUN in summer accompanied with a BREEZE?*

A. Because the heat of the rising sun *stops the radiation of heat* from the earth, and *warms its surface*.

Q. *How does this WARMTH produce a BREEZE?*

A. The air (resting on the earth's surface) being *warmed by contact* ascends,

and *colder air rushing in* to fill up the void, produces the *morning breeze*.

Q. *Why is there often an EVENING BREEZE during the summer months?*

A. Because the earth *radiates heat at sun-set* and the air is rapidly cooled down by contact: this condensation causes a *motion in the air*, called the evening breeze.

Q. *Why are TROPICAL ISLANDS subject to a SEA BREEZE every MORNING: (i. e., a breeze blowing from the sea to the land)?*

A. Because solar rays are unable to heat the surface of the *sea*, as they do the *earth*; therefore, the *air resting on the sea* is less *heated* than the *air resting on the earth*; and the colder sea air blows *inland* to restore the equilibrium.

Q. *Why is a LAND BREEZE UNHEALTHY?*

A. Because it is frequently laden with exhalations from *putrefying animal and vegetable* substances.

Q. *Why is a SEA BREEZE fresh and HEALTHY?*

A. Because it passes over the fresh sea, and is *not* laden with noxious exhalations.

It is particularly *healthy*, therefore, to walk on the sea-beach before ten o'clock in the morning; *but unhealthy after sun-set*.

Q. *Why is there generally a fresh breeze from the SEA during the summer and autumn MORNINGS?*

A. Because *land* is *more heated by the sun* than the *sea* is; and the *land* air becomes hotter than that over the *sea*; in consequence of which, the cooler sea air glides *inland* to restore the equilibrium.

Q. *Why does a SEA BREEZE feel COOL?*

A. Because the sun cannot make the surface of the *sea* so hot as the *land*; therefore, the air which blows from the sea is *cooler than the air of the land*.

Q. *Why are TROPICAL ISLANDS subject to a LAND BREEZE every EVENING (i. e., a breeze blowing from the land towards the sea)?*

A. Because the *surface of the land* cools down *faster* (after sun-set) than the surface of the *sea*: in consequence of which, the air of the cold land *is condensed—sinks down—*and spreads itself into the warmer *sea air—*causing the LAND BREEZE.

Q. *Why is the LAND BREEZE COOL?*

A. Because the surface of the land is cooled at sun-set *quicker than the surface of the sea*; therefore, seamen feel the air from the land to be chill.

Q. *Why is the TEMPERATURE of ISLANDS more EQUABLE than that of CONTINENTS?*

A. Because the *water* around the island *absorbs* the extreme heat of sum-

mer; and *gives out* heat to mitigate the extreme cold of winter.

Q. ISLANDS are WARMER *in winter than continents.* Explain the reason of this.

A. Unless the sea be frozen (which is rarely the case) it is warmer than the frozen land: and the warmth of the sea air helps to mitigate the intense cold of the land air.

Q. Explain the cause of sea WAVES?

A. The wind (acting on the surface of the sea) *piles up ridges of water,* leaving behind an *indentation*: as the water on all sides rushes to *fill up this indentation,* the disturbance spreads on all sides, and billow rolls after billow.

Q. Why does WIND generally feel COLD?

A. Because a *constantly changing surface* comes in contact with our body, to draw off its heat.

Q. Why is a ROOM (even without a fire) generally WARMER than the OPEN AIR?

A. Because the air in a room is *not subject to much change,* and soon becomes of the same temperature as our skin, when it no longer feels cold.

Q. Why do we generally feel COLDER *out-of-doors than in-doors?*

A. Because the air (which surrounds us) is *always changing;* and as fast as



*one* portion of air has become warmer by contact with our body, *another colder portion* surrounds us, to absorb more heat.

Q. *How does BLOWING HOT FOOD make it COOL?*

A. It causes the air (which has been heated by the food) to *change more rapidly*, and give place to fresh *cold air*.

Q. *Why do ladies FAN THEMSELVES in hot weather?*

A. That *fresh particles of air* may be brought in contact with their faces by the action of the fan; and as every fresh particle of air *absorbs some heat* from the skin, this constant *change* makes them cool.

Q. *Does a fan COOL the AIR?*

A. No; it makes the air *hotter* by imparting to it the heat *out of our face*; but it cools our *face* by transferring its heat to the *air*.

Q. *How fast does wind travel?*

A. A gentle breeze goes at about the rate of 5 miles an hour. A high wind from 20 to 60. A hurricane from 80 to 100 miles an hour.

Q. *How is the VELOCITY of WINDS ascertained?*

A. By observing the velocity of the

clouds; and by an instrument for the purpose, called an Anemometer.

Pronounce An-e-mom'-e-ter. From two Greek words *ανεμος* (wind) and *μετρον* (a measure). This term is applied more frequently to an instrument which measures the *force* of wind.

Q. *How is the VELOCITY of the CLOUDS ascertained?*

A. By observing the speed of their shadow along the ground; which is found (in a high wind) to vary from 20 to 60 miles an hour.

Q. *Why is there a strong DRAUGHT through the KEYHOLE of a door?*

A. Because the air in the room we occupy is *warmer* than the air in the hall; therefore, the air from the hall *rushes through the keyhole* in the room, and causes a draught.

Q. *Why is there a strong DRAUGHT UNDER the DOOR, and through the crevice on each side?*

A. Because cold air *rushes from the hall*, to supply the *void* in the room, caused by the escape of warm air up the chimney, &c.

Q. *Why is there always a DRAUGHT through the WINDOW crevices?*

A. Because the external air (being colder than the air of the room we occupy) *rushes through the window crevices to supply the deficiency*, caused by

the escape of warm air up the chimney, &c.

Q. *If you open the LOWER SASH of a window, there is more DRAUGHT than if you open the UPPER sash. Explain the reason of this.*

A. If the *lower* sash be open, *cold external air* will rush freely *into the room* and cause a great draught *inwards*; But if the *upper* sash be open, the *heat-ed air of the room* will rush *out*, and (of course) there will be less draught *inwards*.

Q. *By which means is a ROOM better VENTILATED—By opening the upper or the lower sash?*

A. A room is better *ventilated* by opening the *upper sash*; because the hot vitiated air (which always ascends towards the ceiling) *can escape more easily*.

Q. *By which means is a HOT ROOM more quickly COOLED—By opening the upper or the lower sash?*

A. A hot room is *cooled more quickly* by opening the *lower sash*; because the cold air can enter more freely at the *lower part* of the room, than at the *upper*.

Q. *Why does WIND DRY damp LINEN?*

A. Because dry wind (like a dry sponge) imbibes the particles of vapor from the surface of the linen, as fast as they are formed.

Q. Which is the HOTTEST PLACE in a church, chapel, or theatre?

A. The gallery.

Q. Why is the GALLERY of all public places HOTTER than the LOWER parts of the building?

A. Because the heated air of the building ascends; and all the cold air (which can enter through the doors and windows) keeps to the floor, till it has become heated.

Q. Why do PLANTS often grow out of WALLS and TOWERS?

A. Because the seed has been blown there with the dust, by the wind, or dropped by some bird flying over.

---

## BAROMETER.

### CHAPTER XXV.

Q. What is a BAROMETER?

A. A weather-glass, or instrument to measure the variations in the weight of the air; by means of which variations, we may judge what weather may be expected.

BAROMETER is a compound of two Greek words, *Βαρος* (weight) and *μετρον* (a measure).

Q. What is a THERMOMETER?

A. An instrument to show how *hot* or *cold* anything is.

THERMOMETER is a compound of two Greek words  $\theta\epsilon\rho\mu\omicron\varsigma$  (heat) and  $\mu\epsilon\tau\rho\nu$  (measure).

Q. *What is the DIFFERENCE between a THERMOMETER and a BAROMETER?*

A. In a THERMOMETER the mercury is *sealed up from the air*; and rises or falls, as the varying *temperature* of the air expands or contracts it: but

In a BAROMETER the mercury is left *exposed* (or open) *to the air*;\* and rises or falls, as the varying *weight* of the air presses upon the open column.

Q. *If the mercury of the thermometer be SEALED UP from the air, how can the air AFFECT it?*

A. The heat of the air passes *through the glass tube* into the mercury which causes the metal to expand and rise in the tube.

Q. *Why is the TUBE of a barometer left OPEN?*

A. That the air may *press upon it* freely; and, as this pressure varies, the mercury *rises or falls* in the tube.

The top of the tube must be a "*vacuum*;" otherwise the pressure of the external air upon the lower part of the column cannot affect the mercury.

Q. *How can a barometer, which measures the WEIGHT of air, be of service as a WEATHER glass?*

---

\* At its lower extremity.

A. When air is *moist*, or filled with vapor, it is *lighter* than usual; and the column of mercury stands *low*:

When air is *dry* and free from vapor, it is *heavier* than usual; and the mercury stands *high*: Thus the barometer (by showing the variations in the *weight of the air*) indicates the changes of the *weather also*.

Q. *Why can you tell (by looking at a BAROMETER) what KIND of WEATHER it will be?*

A. Because the mercury in the tube *rises and falls*, as the air becomes heavier or lighter: and we can generally tell by the *weight* of the air, what kind of weather to expect.

Q. *Does the WEIGHT of the air VARY MUCH?*

A. Yes; the atmosphere varies as much as *one-tenth part* more or less.

Q. *What USE is a BAROMETER to sailors?*

A. It warns them to *regulate their ships*, before squalls come on.

Q. *How can a BAROMETER warn SAILORS to regulate their SHIPS?*

A. As it indicates when *wind, rain, and storm* are at hand, the sailor can make his ship trim before they overtake him.

Q. *Are there any RULES which can be depended on?*

A. Yes; there are *ten special rules* to direct us how to know the changes of weather, by marking the mercury of a barometer.

Q. *Mention the 1ST SPECIAL RULE with regard to the barometer?*

A. The barometer is *highest of all* during a *long frost*; and it generally rises with a *north-west wind*.

Q. *Why is the barometer HIGHEST of all during a long FROST?*

A. Because a long frost *condenses the air very greatly*; and the more condensed air is, the greater is its *pressure* on the mercury of a barometer.

Q. *Why does the barometer generally RISE with NORTH-WEST winds?*

A. Because NORTH-WEST winds make the air both *cold and dry*: and being both *condensed*, and *without vapor*, it is much heavier.

Q. *Mention the 2D SPECIAL RULE with regard to the barometer?*

A. The barometer is *lowest of all* during a *thaw, which follows a long frost*: and it generally falls with SOUTH or EAST wind.

Q. *Why does the barometer fall LOWEST of all at the BREAKING UP of a long FROST?*

A. 1st—Because the air (which had

been much *dried* by the frost) *absorbs the moisture* of the fresh warm current of wind from the south or south-west: and

2dly—The air (which had been much *condensed* by the frost) is suddenly *expanded* by the warm wind, which is introduced.

Q. *Why does the barometer fall very low with SOUTH and EAST winds?*

A. Because SOUTH and EAST winds come heavily *laden with vapor*; and *vaporized* air is lighter than *dry* air.

Q. *What effect has WIND on the mercury?*

A. The barometer is *high*, when the wind blows between the WEST and the NORTH; but it is *low*, when the wind blows between the SOUTH and the EAST.

Q. *Why do these winds affect the mercury of a barometer?*

A. Because the pressure of the air is *increased* by *cold winds*, and diminished by *warm* ones.

Q. *Why is the pressure of air INCREASED with cold winds from the NORTH?*

A. Because the air *contracts*, when it is *cooled* by winds from the north and east, and *warmer* air flows in from all sides to fill up the vacuum; in conse-



quence of which, its volume is increased, and the barometer *rises*.

Q. *Why is the PRESSURE of air DIMINISHED by warm winds from the SOUTH?*

A. Because the air *ascends* when it is heated by south winds, and flows away in all directions; in consequence of which, its volume is *diminished*, and the mercury *falls*.

Q. *What is the 3D SPECIAL RULE with regard to the barometer?*

A. While the barometer stands above 30, the air must be very *dry*, or very *cold*, or perhaps *both*—and *no rain* may be expected.

Q. *Why will there be NO RAIN if the AIR be very DRY?*

A. Because *dry* air will *absorb moisture*, and not part with it in *rain*.

Q. *Why will there be NO RAIN if the AIR be very COLD?*

A. Because it is so *much condensed*, that it has already parted with as much moisture as it can spare.

Q. *What is the 4TH SPECIAL RULE with regard to the barometer?*

A. When the barometer stands *very low* indeed, there will never be *much* rain; although a *fine day* will seldom occur at such times.

Q. *What kind of WEATHER is there likely to be, when the barometer is UNUSUALLY LOW?*

A. *Short heavy showers, with sudden squalls of wind from the west.*

Q. *Why will there be VERY LITTLE RAIN, if the barometer is UNUSUALLY LOW?*

A. *Because the air must be very warm, or very moist, or perhaps both.*

Q. *Why will there be little or no rain, if the AIR be very WARM?*

A. *Because warm air has a tendency to imbibe more moisture and not to part with what it has.*

Q. *Why will there be little or no rain, if the air be MOIST and the barometer very LOW?*

A. *Because rain will never fall (even though the air be saturated), till cold air has been introduced to condense the vapor: And, as soon as cold air has been introduced, the barometer will rise instantly.*

Q. *Name the 5TH SPECIAL RULE with regard to the barometer?*

A. *In summer-time (after a long continuance of fair weather) the barometer will fall gradually for 2 or 3 days before rain comes: But if the fall of the mercury is very sudden, a thunder-storm may be expected.*

Q. *What is the 6TH SPECIAL RULE with regard to the barometer?*

A. When the sky is cloudless, and seems to promise fair weather—if the barometer is *low*, the face of the sky will soon be suddenly *overcast*.

Q. *What is the 7TH SPECIAL RULE with regard to the barometer?*

A. Dark dense clouds will pass over *without rain*, when the barometer is *high*; but if the barometer be *low*, it will often rain *without* any appearance of clouds.

Q. *What is the 8TH SPECIAL RULE with regard to the barometer?*

A. The *higher* the barometer, the greater the probability of *fair weather*.

Q. *Why is the barometer HIGH in FINE weather?*

A. Because the air in fine weather contains *very little vapor*. The *drier* the air, the *higher* does the mercury of the barometer rise.

Q. *What is the 9TH SPECIAL RULE with regard to the barometer?*

A. When the mercury is in a *rising* state, *fine* weather is at hand; but, when the mercury is in a *sinking* state, *foul* weather is near.

Q. *Why does the mercury RISE at the approach of FINE weather?*

A. Because the air is becoming more

*dry*; and, therefore, its *pressure is increased*.

Q. *Why does the mercury SINK at the approach of FOUL weather?*

A. Because the air is *laden with vapor* or *disturbed by wind*.

Q. *Why does VAPOR in the air make the mercury SINK?*

A. Because vaporized air is *lighter than dry air*; and its *pressure on the barometer less*.

Q. *What is the 10TH SPECIAL RULE with regard to the barometer?*

A. If (in frosty weather) it *begins to snow*, the barometer generally rises to 30; where it remains, so long as the snow continues to fall: If, after this, the weather *clears up*, you may expect *very severe cold*.

Q. *How can you know if the MERCURY of the barometer is RISING?*

A. When the top of the column is *convex* (i. e., higher in the *middle* than at the *sides*), the mercury is in a *rising state*.

Q. *How can you tell if the MERCURY of the barometer is FALLING?*

A. When the top of the column is *concave* (i. e., *hollow* in the middle), the mercury is in a *falling state*.

Q. *Why is the mercury CONVEX when it is RISING?*

A. Because the parts of the mercury in contact with *the tube* are delayed by the glass; in consequence of which, the *middle* part rises faster than the *sides*; and the surface is CONVEX.

Q. *Why is the mercury CONCAVE when it is FALLING?*

A. Because the parts of the mercury in contact with *the tube* are delayed by *capillary attraction*; in consequence of which, the *middle* part sinks faster than the *sides*: and the surface is CONCAVE.

Q. *What effect does a THUNDER-STORM produce on the weather?*

A. It is generally preceded by hot weather, and followed by cold and showery weather.

Q. *What effect does a SUDDEN CHANGE of temperature produce on the weather?*

A. A great and sudden change (either from hot to cold, or from cold to hot) is generally followed by rain within 24 hours.

Q. *Why is a sudden CHANGE from HOT to COLD followed by RAIN?*

A. Because cold condenses the air; and some of its vapor is given off in rain.

Q. *Why is a sudden CHANGE from COLD to HOT followed by RAIN?*

A. Because the air is quickly *saturated* with *moisture*: but when *night* comes on, and *chills* the temperature, some of the abundant moisture is given off in rain.

Q. *Why is the air quickly SATURATED with MOISTURE, when HEAT rapidly succeeds to COLD?*

A. Because the evaporation (which was checked by the cold) is *carried on very rapidly*, in consequence of the *diminished* pressure of the air.

N. B. The *less the pressure* of the air, the more *rapid the evaporation* of moisture will be.

Q. *When does the barometer VARY MOST?*

A. In winter-time.

Q. *Why does the barometer vary MORE in WINTER, than in SUMMER-time?*

A. Because the *difference* of temperature between the torrid and temperate zones is much *greater* in winter than in summer: and produces a greater disturbance in the state of the air.

Q. *When does the barometer VARY LEAST?*

A. In summer-time.

Q. *Why does the barometer vary LESS in SUMMER than in WINTER-time?*

A. Because the temperature of the torrid and temperate zones in summer is so *nearly equal*, that its state is *not much* disturbed by interchange of currents.

Q. *Have* HEAT *and* COLD *any effect on the barometer?*

A. No, not of themselves; but because *cold* weather is generally either *dry*, or *rough* with north-west winds, therefore the mercury *rises* in cold weather: And because warm weather is often *moist*, or *fanned* by south-east winds, therefore the mercury *sinks* in warm weather.

Q. *Why is the mercury of a barometer LOWER in the TORRID than in the FRIGID zone?*

A. Because the warm air of the torrid zone contains much more *vapor* than the condensed air of the frigid zone; and the *moister* the air, the *less* is its pressure.

Q. *In what MONTHS is the barometer HIGHEST?*

A. In May and August; then in June, March, September, and April.

Q. *In what MONTHS is the barometer LOWEST?*

A. In November and February; then in October, July, December, and January.

Q. *Why is there LESS wet from MARCH to AUGUST than there is from August to March?*

A. Because the heat is *constantly increasing*; and the capacity of air to absorb and retain moisture increases likewise.

Q. *Why is there MORE wet from AUGUST to MARCH than from March to August?*

A. Because the heat is *constantly decreasing*; and the capacity of air to retain moisture decreases also; so that although it often rains, yet the air is always on the point of saturation.

Q. *Why does the mercury of a barometer RISE in a FROST?*

A. Because frost *condenses the air*; and condensed air is heavier than rarefied air.

Q. *Why does the mercury of a barometer FALL in a THAW?*

A. Because the air is filled with *vapor*.

Q. *What does a SUDDEN rise or fall of the barometer indicate?*

A. If the *rise* be sudden, fine weather will not continue long:

If the *fall* be sudden, foul weather will not continue long.

Q. *What sort of weather may we expect, if the barometer is very FLUCTUATING?*

A. If the mercury fluctuates much, the weather will be very *changeable* and *unsettled*.

#### THE FALL OF THE BAROMETER.

In very *hot* weather, the fall of the mercury denotes *thunder*. Otherwise, the sudden falling of the barometer denotes high wind.



In *frosty* weather, the fall of the barometer denotes *thaw*. If *wet* weather happens soon after the fall of the barometer, expect but *little* of it.

In *wet* weather, if the barometer falls, expect much *wet*.

In *fair* weather, if the barometer falls and *remains* low, expect much *wet* in a few days, and probably *wind*.

N. B. The barometer sinks lowest of all for wind and rain together; next to that for wind, (except it be an east or north-east wind.)

#### THE RISE OF THE BAROMETER.

In *winter*, the rise of the barometer presages *frost*.

In *frosty* weather, the rise of the barometer presage *snow*.

If *fair* weather happens *soon* after the rise of the barometer, expect but *little* of it.

In *wet* weather, if the mereury rises high and *remains* so, expect continued *fine weather* in a day or two.

In *wet* weather, if the mereury rises suddenly very high, *fine weather* will not last long.

N. B. The barometer rises highest of all for north and west winds; for all *other* winds it sinks.

#### THE BAROMETER UNSETTLED.

If the motion of the mereury be *unsettled*, expect *unsettled* weather.

If it stand at "MUCH RAIN" and rise to "CHANGEABLE," expect *fair weather of short continuance*.

If it stand at "FAIR" and fall to "CHANGEABLE," expect *foul* weather.

N. B. Its motion *upwards* indicates the approach of *fine* weather; its motion *downwards* indicates the approach of *foul* weather.

---

## SNOW. HAIL. RAIN.

### CHAPTER XXVI.

Q. What is SNOW?

A. The condensed vapor of the air *frozen*, and precipitated to the earth.

Q. *What is the CAUSE of SNOW?*

A. When the air is nearly saturated with vapor, and condensed by a current of air *below freezing point*, some of the vapor is condensed, and frozen into snow.

A few years ago, some fishermen (who wintered at Nova Zembla), after they had been shut up in a hut for several days, *opened the window*, and the cold external air rushing in, instantly condensed the air of the hut, and its vapor fell on the floor *in a shower of snow*.

Q. *Why does SNOW fall in WINTER time?*

A. Because the sun's rays are too *oblique* to heat the surface of the earth; and (as the earth has no heat to radiate into the air) the air is very cold.

Q. *What is the cause of SLEET?*

A. When flakes of snow (in their descent) pass through a bed of air *above freezing point*, they partially melt; and fall to the earth as half-melted snow, or sleet.

Q. *What is the USE of SNOW?*

A. To keep the earth *warm*, and to *nourish* it.

Q. *Does snow keep the EARTH WARM?*

A. Yes, because it is a very *bad conductor*; in consequence of which, when the earth is covered with snow, its temperature very rarely descends *below*

*freezing point*, even when the air is 15 or 20 degrees colder.

Q. WHY is SNOW a BAD CONDUCTOR of heat and cold?

A. Because *air* is confined and entangled among the crystals; and *air* is a very *bad* conductor: When, therefore, the earth is covered with snow, it cannot throw off its heat by radiation.

Q. Tell me the words of the PSALMIST (cxlvii. 16) respecting snow; and explain what he means?

A. The Psalmist says—"The Lord giveth snow like wool;" and he means, not only that snow is as *white as wool*, but that it is also as *warm as wool*.

Q. Why is WOOL WARM?

A. Because *air* is entangled among the fibres of the wool; and air is a very *bad* conductor.

Q. Why is SNOW WARM?

A. Because *air* is entangled among the crystals of the snow; and air is a very *bad* conductor.

Q. Why does SNOW NOURISH the earth?

A. Because it supplies *moisture* containing carbonic acid; which penetrates slowly into the soil, and insinuates itself through every clod, ridge, and furrow.

Q. Why is there NO SNOW in SUMMER time?

A. Because the *heat of the earth* melts it in its descent, and prevents it from reaching the surface of the earth.

Q. *Why are some MOUNTAINS ALWAYS COVERED with SNOW?*

A. 1st—Because the *air* on a high mountain is more *rarefied*; and rarefied air retains much heat in a latent state: and

2dly—Mountain-tops are not *surrounded by earth*, to radiate heat into the air; and, therefore, the snow is *not melted* in its descent, but falls on the mountain, and lies there.

Q. *Why is SNOW WHITE?*

A. Because it is formed of an infinite number of very minute crystals and prisms, which reflect all the colors of the rays of light from different points; and these colors, *uniting* before they meet the eye, cause snow to appear white.

The same answer applies to salt, loaf-sugar, &c. (See p. 372.)

Q. *What is HAIL?*

A. Rain, which has passed in its descent *through some cold bed of air*, and has been frozen into drops of ice.

Q. *What makes ONE bed of air COLDER than another?*

A. It is frequently caused by *electricity unequally distributed* in the air.

Q. *Why is HAIL frequently accompanied with THUNDER and LIGHTNING?*

A. 1st—Because the *congelation of water into hail* disturbs the electricity of the air: and

2dly—The *friction* (produced by the fall of hail) excites it still more.

Q. *Why does HAIL fall generally in SUMMER and AUTUMN?*

A. 1st—Because the air is *more highly electrified* in summer and autumn than in winter and spring: and

2dly—The vapors in summer and autumn (being rarefied) ascend to more elevated regions, which are *colder* than those nearer the earth.

Q. *What TWO things are essential to cause HAIL?*

A. Two *strata of clouds* having *opposite electricities*, and *two currents of wind*. The *lower cloud* (being negative) is the one *precipitated* in hail.

Q. *What is RAIN?*

A The vapor of the clouds or air *condensed*, and precipitated to the earth.

Q. *When is the vapor of the air or clouds PRECIPITATED in hail, rain, or snow?*

A. When the air is *saturated with vapor*, and a cold current *condenses* it; it is then no longer able to hold all its vapor in solution, and some of it falls as rain.

Q. *Why does RAIN fall in DROPS?*

A. Because the vapory particles in their descent *attract each other*; and those which are sufficiently near *unite*, and form into drops.

Q. *Why does not the COLD of NIGHT ALWAYS cause rain?*

A. Because the air is not always near saturation; and unless this be the case, it will be able to hold its vapor in solution, even after it is condensed by the chilly night.

Q. *Why does a PASSING CLOUD often drop RAIN?*

A. Because the cloud (travelling about on the wind) comes into contact with *something that chills it*; and its vapor being condensed, *falls to the earth as rain*.

Q. *Why are RAIN-DROPS sometimes much LARGER than at OTHER times?*

A. Because the rain-cloud is floating *near the earth*; when this is the case, the drops are large, because such a

cloud is much more *dense* than one more elevated.

The size of the rain-drop is also increased, according to the *rapidity* with which the vapors are condensed.

Q. Does not WIND sometimes INCREASE the SIZE of rain-drops?

A. Yes; by blowing two or more drops into one.

Q. Why do CLOUDS FALL in RAINY weather?

A. 1st—Because they are *heavy* with abundant vapor: and

2dly—The density of the air being *diminished*, is less able to buoy the clouds up.

Q. How do you KNOW that the DENSITY of the air is DIMINISHED in RAINY weather?

A. Because the mercury of a barometer *falls*.

Q. Why is RAIN-WATER more FERTILIZING than PUMP-WATER?

A. 1st—Because it contains more carbonic acid: and

2dly—It contains also a small quantity of *ammonia*, with which it supplies the young plants.

It is probable that the ammonia of rain-water is merely that which escapes from putrefying animal matters, beaten back by the force of the shower.

Q. Why does RAIN PURIFY the AIR?

A. 1st—Because it *beats down* the

*noxious exhalations* collected in the air, and *dissolves* them :

2dly—It mixes the air of the *upper* regions with that of the *lower regions*: and

3dly—It *washes the earth*, and sets in motion the stagnant contents of sewers and ditches.

Q. *Why are MOUNTAINOUS countries more RAINY than flat ones?*

A. Because the air (striking against the sides of the mountains) is *carried up the inclined plane*, and brought in contact with the *cold air* of the higher regions: in consequence of which, its vapor is *condensed*, and deposited in rain.

Q. *Why does a SPONGE SWELL when it is WETTED?*

A. Because the water *penetrates the pores* of the sponge by capillary attraction, and drives the particles *further from each other*; in consequence of which, the *bulk* of the sponge is greatly *increased*.

Q. *Why do FIDDLE-STRINGS SNAP in WET weather?*

A. Because the moisture of the air (penetrating the string) causes it to *swell*; and (as the cord *thickens*) its *tension is increased*, and the string snaps.



Q. *Why does PAPER PUCKER when it is WETTED ?*

A. Because the moisture (penetrating the paper) *drives its particles further apart*; and (as the moisture is absorbed *unequally* by the paper) some parts are more enlarged than others; in consequence of which, the paper *blisters or puckers*.

Q. *Why do the weather-toys (called CAPUCHINS) lift the cowl over the figures in wet weather, and remove it in dry ?*

A. Because the cowl of the cap'uchin is attached to a *piece of cat-gut* in such a manner, that when the cat-gut is *shortened by moisture*, it pulls the cowl up; but in *dry* weather the string is *loosened*, and the cowl falls down by its own weight.

Q. *In another weather-toy the MAN comes out in WET weather, and the LADY in FINE:—Why is this ?*

A. Because the two figures are attached to a *piece of cat-gut* in such a manner, that when the cat-gut is *shortened by moisture*, it pulls the *man out*; but when it is *loose*, the *woman falls out* by her own weight.

Q. *Why are WET STOCKINGS DIFFICULT to PULL ON ?*

A. Because the moisture penetrates the threads of the stockings, and causes them to *shrink in size*.

Q. *In which PART of the DAY does the MOST RAIN fall?*

A. More rain falls by *night* than by day; because the cold night *condenses the air*, and diminishes its capacity for holding vapor in solution.

Q. *Does more rain fall in SUMMER or in WINTER?*

A. There are *more rainy days* from September to March; but *heavier rains* between March and September.

Q. *Why are there MORE RAINY DAYS from September to March than from March to September?*

A. Because the temperature of the air is *constantly decreasing*, and its capacity for holding vapor decreases also; in consequence of which, it is frequently obliged to part with some of its vapor in rain.

Q. *In what PART of the WORLD does RAIN fall MOST ABUNDANTLY?*

A. Near the *equator*; and the quantity of rain *decreases*, as we approach the *poles*.

Be it remembered that there are fewer rainy *days*, although more *rain* actually falls during the wet season of the equator, than falls in 12 months at any other part of the globe.

## WATER.

## CHAPTER XXVII.

Q. *Of what is WATER composed?*

A. *Of two gases, oxygen and hydrogen.*

In 9lbs. of water—8 are oxygen, and 1 is hydrogen.

Q. *Why is WATER FLUID?*

A. Because its particles are kept separate by *latent heat*: When a certain quantity of this latent heat is driven out, *water becomes solid*, and is called ice.

By increasing its *latent heat*, the particles of water are again subdivided into *invisible steam*.

Q. *Why is PUMP-WATER called "HARD water?"*

A. Because it is laden with foreign matters, and will not readily *dissolve substances* immerse d in it.

Q. *What makes PUMP-WATER HARD?*

A. When it filters through the earth, it becomes impregnated with *sulphate of lime*, and many other impurities from the *earths and minerals* with which it comes in contact.

Q. *What is the cause of MINERAL SPRINGS?*

A. When water trickles through the ground, it dissolves some of the substances with which it comes in contact; if

these substances are metallic, the water will partake of their mineral character.

Some water is imbued with *lime*; some with *salt*, &c., &c.

Q. *Why is it difficult to WASH our HANDS clean with HARD water?*

A. Because the *soda of the soap* combines with the *sulphuric acid* of the hard water—and the *oil of the soap* with the *lime*—and floats in flakes on the top of the water.

N. B. Sulphate of lime consists of sulphuric acid and lime.

Q. *Why is it difficult to wash in SALT WATER?*

A. Because it contains *muriotic acid*; and the *soda of soap* combines with the *muriotic acid of the salt water*, and produces a cloudiness.

Q. *What is the cause of PETRIFICATIONS?*

A. While water rolls underground, its impurities are held in solution by the presence of carbonic acid: but when the stream reaches the open air, its carbonic acid escapes, and these impurities are precipitated on various substances lying in the course of the stream.

These impurities are especially carbonate of lime and iron.

Q. *Why does a BLACK HAT turn RED at the SEA-SIDE?*

A. Because the *muriotic acid* of the

sea water disturbs the *gallic acid* of the black dye, and turns it red.

Q. *Of what is SOAP made?*

A. Of kelp (or the ashes of sea-weed dried and burnt in a pit) mixed with oil or fat.

YELLOW SOAP is made of whale oil, soda, and resin. SOFT SOAP is made of oil and potash. HARD SOAP, of oil and soda.

Q. *Why does WATER CLEAN dirty LINEN?*

A. Because it *dissolves* the stains, as it would dissolve salt.

Q. *Why does SOAP greatly INCREASE the cleansing power of water?*

A. Because many stains are of a *greasy nature*; and soap has the power of *uniting with greasy matters*, and rendering them soluble in water.

Q. *Why is RAIN-WATER SOFT?*

A. Because it is not impregnated with *earths and minerals*.

Q. *Why is it MORE EASY to WASH with SOFT water, than with HARD?*

A. Because soft water unites freely with soap, and *dissolves* it; instead of decomposing it, as hard water does.

Q. *Why do WOOD ASHES make HARD water SOFT?*

A. 1st—Because the *carbonic acid* of wood ashes combines with the *sulphate*

*of lime* in the hard water, and converts it into *chalk* : and

2dly—Wood ashes convert some of the soluble salts of water into insoluble, and throw them down as a sediment ; in consequence of which, the water remains more pure.

Q. *Why has RAIN-WATER such an UNPLEASANT SMELL, when it is collected in a rain-water tub or tank ?*

A. Because it is impregnated with *decomposed* organic matters, washed from roofs, trees, or the casks in which it is collected.

Q. *Why does WATER MELT SUGAR ?*

A. Because very minute particles of water insinuate themselves into the *pores* of the sugar, by capillary attraction ; and force the crystals apart from each other.

Q. *Why does WATER MELT SALT ?*

A. Because very minute particles of water insinuate themselves into the *pores* of the salt, by capillary attraction ; and force the crystals apart from each other.

Q. *Why does melted SUGAR or SALT give a FLAVOR to water ?*

A. Because the sugar or salt (being disunited into very minute pieces) *floats*

about the water, and mixes with every part.

Q. *Why does HOT water melt sugar and salt QUICKER than COLD water?*

A. Because the *heat* (entering the pores of the sugar or salt) opens a passage for the water.

Q. *Why is SEA-WATER brackish?*

A. 1st—Because the sea contains *mines of salt* at the bottom of its bed :

2dly—It is impregnated with *bituminous matter*, which is brackish : and

3dly—It contains many *putrid substances* of a brackish nature.

Q. *Why is NOT RAIN-WATER SALT, although most of it is evaporated from the SEA?*

A. Because *salt* will not *evaporate*; and therefore when sea-water is turned into vapor, its *salt* is left behind.

Q. *Why does STAGNANT water PUTREFY?*

A. Because leaves, plants, insects, &c., are decomposed in it.

Q. *Why is STAGNANT water full of WORMS, EELS, &c.?*

A. Because numberless insects *lay their eggs* in the leaves and plants floating on the surface; these eggs are soon hatched, and produce swarms of worms, eels, and insects.

Q. *Why is FLOWING water FREE from these IMPURITIES?*

A. 1st—Because the motion of running water prevents *fermentation* :

2dly—It dissolves the *putrid substances* which happen to fall into it : and

3dly—It casts on the *bank* (by its current) such substances as it cannot dissolve.

Q. *Why does RUNNING water OSCILLATE and WHIRL in its current?*

A. 1st—Because it *impinges* against its *banks*, and is perpetually diverted from its forward motion : and

2dly—Because the *centre* of a river flows faster than its sides.

Q. *Why do the SIDES of a river flow more TARDILY than its CENTRE?*

A. Because they *rub* against the *banks*, and are delayed in their current by this friction.

Q. *Why does SOAPY water BUBBLE?*

A. Because soap makes the *water tenacious* ; and prevents the bubbles from *bursting* as soon as they are formed.

Q. *Why will not water bubble WITHOUT SOAP?*

A. Because it is not tenacious enough to hold together the *bubbles* that are formed



Q. When SOAP-BUBBLES are blown from a pipe why do they ASCEND?

A. Because they are filled with warm breath, which is lighter than air.

---

ICE.

CHAPTER XXVIII.

Q. What is ICE?

A. FROZEN WATER. When the air is reduced to 32 degrees of heat, water will no longer remain in a fluid state.

Q. Why is SOLID ICE LIGHTER than WATER?

A. Because water expands by freezing; and as the bulk is increased, the gravity must be less.

Nine cubic inches of water become ten when frozen.

Q. Why do EWERS BREAK in a FROSTY NIGHT?

A. Because the water in them freezes; and (expanding by frost) bursts the ewers to make room for its increased volume.

Q. Why does it not expand UPWARDS (like boiling water), and RUN OVER?

A. Because the surface is frozen first; and the frozen surface acts as a plug, which is more difficult to burst than the earthen ewer itself.

Q. *Why do TILES, STONES, and ROCKS often SPLIT in winter?*

A. Because the moisture in them *freezes*; and (expanding by frost) *splits the solid mass*.

Q. *In winter-time, FOOT-MARKS and WHEEL-RUTS are often covered with an icy NET-WORK, through the interstices of which the soil is clearly seen:—WHY does the water freeze in NET-WORK?*

A. Because it freezes first at the *sides* of the foot-prints: other crystals gradually shoot across, and would cover the whole surface, if the earth did not *absorb* the water before it had time to freeze.

Q. *In winter-time, these FOOT-MARKS and WHEEL-RUTS are sometimes covered with a perfect SHEET of ice, and not an icy net-work:—Why is THIS?*

A. Because the *air is colder* and the *earth harder* than in the former case, in consequence of which, the *entire surface* of the foot-print is frozen over before the earth has had time to absorb the water.

Q. *Why is not the ice SOLID in these ruts?—WHY is there only a very thin FILM or NET-WORK of ice?*

A. Because the earth *absorbs most of the water*, and leaves only the *icy film behind*.

Q. Why do WATER-PIPES frequently BURST in FROSTY weather?

A. Because the water in them *freezes*; and (*expanding by frost*) bursts the pipes to make room for its increased volume.

Q. Does not water expand by HEAT as well as by COLD?

A. Yes; it expands as soon as it is more than 42 degrees, *till it boils*; after which time, it flies off in steam.

Freezing water, 32°.

212°, Boiling water.

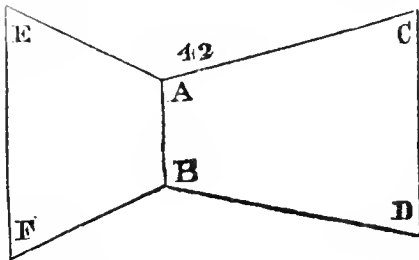

Here A B measures the bulk of a portion of water at 42 degrees.

It goes on increasing in bulk to C D, when it boils.

It also goes on increasing in bulk to E F, when it freezes.

Q. WHEN does WATER begin to EXPAND from cold?

A. When it is reduced to 42 degrees. Water is wisely ordained by God to be an *exception* to a very general rule—it *contracts* till it is reduced to 42 degrees, and then it *expands till it freezes*.

The general rule is this—That cold *condenses* and *contracts* the volume of nearly everything; but water is *not contracted* by cold after it freezes, (which it does at 32°).

Q. WHY does water expand when it freezes?

A. Because it is converted into *solid crystals* which do not fit so closely as particles of water do.

Q. Why is the BOTTOM of a river NEVER FROZEN?

A. Because water *ascends* to the surface, so soon as it becomes colder than 42 degrees; and (if it freezes) *floats there* till it is melted.

Q. Show the WISDOM of GOD in this wonderful exception to a general law.

A. If ice were *heavier than water*, it would *sink*; and a river would soon become a *solid block of ice*, which could never be dissolved.

The general rule is--that all substances become *heavier* from condensation; but ice is *lighter* than water.

Q. Why does not the ICE on the SURFACE of a river CHILL the water BENEATH and make it freeze?

A. 1st—Because water is a *very bad conductor*, and is heated or chilled by CONVECTION only:

2dly—If the ice on the surface were to communicate its *coldness* to the water beneath, the water beneath would communicate its *heat to the ice*, and the ice would instantly *melt*: and

3dly—The ice on the surface acts as a *shield*, to prevent the cold air from

*penetrating through the river, to freeze the water below the surface.*

Q. *Why does WATER FREEZE at the SURFACE first?*

A. Because the surface is in *contact with the air*, and the air carries away its heat.

Q. *Why does the coat of ice grow THICKER and THICKER if the frost CONTINUES?*

A. Because the *heat* of the water (immediately below the frozen surface) *passes through the pores of the ice* into the cold air.

Q. *Why are not WHOLE RIVERS FROZEN (layer by layer), till they become solid ice*

A. Because water is so *slow* a conductor, that our frosts never continue *long enough* to convert a whole river into a solid mass of ice.

Q. *Why does not RUNNING water freeze so FAST as STILL water?*

A. 1st—Because the motion of the current *disturbs the crystals*, and prevents their forming into a continuous surface: and

2dly—The heat of the *under* surface is communicated to the *upper* surface by the *rolling of the water*.

Q. *When RUNNING water is FROZEN why is the ICE generally very ROUGH?*

A. Because little flakes of ice are first formed and *carried down* the stream, till they meet some *obstacle* to *stop* them; *other* flakes of ice, (impinging against them) are arrested in like manner; and the *edges* of the different flakes *overlapping* each other, *make the surface rough*.

Q. *Why do SOME parts of a RIVER FREEZE LESS than OTHERS?*

A. Because *springs* issue from the bottom; and (as they bubble upwards) *thaw the ice*, or make it thin.

Q. *When persons FALL into a RIVER in winter-time why does the WATER feel remarkably WARM?*

A. Because the *frosty air* is at least 10 or 12 degrees *colder* than the water is.

The water below the surface is at least 42°; but the air 32°, or even less.

Q. *Why is SHALLOW water FROZEN more QUICKLY than DEEP water?*

A. Because the *whole volume* of water must be cooled to 42 degrees, before the *surface can be frozen*: and it takes a longer time to cool down a *deep* bed of water than a *shallow* one.

Q. *Why is SEA-WATER RARELY FROZEN?*

A. 1st—Because the *mass of water* is so great, that it requires a very long time to cool the whole volume down to 42 degrees:

2dly—The *ebb and flow* of the sea interfere with the cooling influence of the air : and

3dly—*Salt* water never freezes till the surface is cooled down 25 degrees *below freezing point*.

Q. *Why do some LAKES RARELY (if ever) FREEZE ?*

A. 1st—Because they are *very deep* : and

2dly—Because their water is supplied by *springs*, which bubble from the bottom.

Q. *Why does the DEPTH of water RETARD its FREEZING ?*

A. Because the *whole volume of water* must be reduced to 42 degrees, before the *surface will freeze* : and the *deeper* the water, the *longer* it will be before the whole volume is thus reduced.

Q. *Why do SPRINGS at the bottom of a lake PREVENT its FREEZING ?*

A. Because they keep continually sending forth *fresh* water, which prevents the lake from being reduced to the necessary degree of coldness.

Q. *It is COLDER in a THAW, than in a FROST. Explain the reason of this.*

A. When frozen water is *thawed*, it *absorbs* heat from the *air*, &c., to melt

the ice; in consequence of which, the heat of the air is greatly reduced.

Q. *It is WARMER in a FROST than in a THAW. Explain the reason of this.*

A. When water *freezes*, it gives out *latent heat*, in order that it may be converted into *solid ice*; and, as much heat is liberated from the water to the atmosphere, the air feels *warmer*.

Q. SALT DISSOLVES ICE. *Explain the reason of this.*

A. Water freezes at  $32^{\circ}$ , but *salt* and water will not freeze till the *air* is 25 degrees *colder*; if, therefore, salt be added to frozen water, it dissolves it.

Unless the thermometer stands below  $7^{\circ}$ .

Q. *Will any thing DISSOLVE ICE besides SALT?*

A. Yes; any *acid*, such as sulphuric acid, nitric acid, &c.

Q. *Why is a mixture of SALT and SNOW colder than SNOW itself?*

A. Because *salt dissolves the crystals* of snow into a fluid: And whenever a solid is converted into a fluid, *heat is absorbed*, and the cold made more intense.

Q. *Why does FROST make the EARTH CRACK?*

A. Because the water absorbed by the earth in warm weather, expanding by the frost, thrusts the particles of



earth apart from each other, and leaves a chink or crack between.

Q. *Show the WISDOM of God in this arrangement.*

A. These *cracks* in the earth let in air, dew, rain, and many gases favorable to vegetation.

Q. *Why does the EARTH CRUMBLE in SPRING?*

A. Because the *ice* of the clods *dissolves*; and the particles of earth (which had been thrust apart by the frost) being left *unsupported*, tumble into minute parts, because their *cement of ice is dissolved*.

Q. *Why does MORTAR CRUMBLE away in FROST?*

A. Because it was not *dried in the warm weather*; therefore its moisture *freezes, expands*, and thrusts the particles of the mortar away from each other; but as soon as the frost goes the *water condenses*, and leaves the mortar full of cracks and chinks.

Q. *Why does STUCCO PEEL from a WALL in FROSTY weather?*

A. Because the stucco was not *dried in the warm weather*; therefore its moisture *freezes, expands*, and thrusts its particles away from the wall; but, as soon as the water condenses again by the

thaw, the stucco (being unsupported) *falls by its own weight.*

Q. *Why cannot BRICKLAYERS and PLASTERERS work in FROSTY weather?*

A. Because *frost* expands mortar, and causes the bricks and plaster to *start from their position.*

Q. *Why do BRICKLAYERS COVER their work with STRAW in spring and autumn?*

A. Because straw is a non-conductor; and prevents the mortar of their new work from *freezing*, during the cold nights of spring and autumn.

Q. *Why are WATER PIPES often covered with STRAW in winter-time?*

A. Because straw (being a non-conductor) prevents the *water of the pipes from freezing*, and the *pipes from bursting.*

Q. *Why are delicate TREES covered with STRAW in WINTER?*

A. Because straw (being a non-conductor) prevents the *sap of the tree* from being frozen.

Q. *Can WATER be FROZEN in any way BESIDES by frosty weather?*

A. Yes; in very many ways. For example—a bottle of water wrapped in *cotton*, and frequently *wetted with ether*, will soon freeze.

Q. *Why would WATER FREEZE if the bottle were kept constantly wetted with ETHER?*

A. Because *evaporation* would carry off the heat of the water, and reduce it to the *freezing point*.

Q. *Why does ETHER freeze under the RECEIVER of an AIR-PUMP, when the air is exhausted?*

A. Because *evaporation* is very greatly increased by the *diminution of atmospheric pressure*; and the ether freezes by evaporation.

## FREEZING MIXTURES.

1. If nitre be dissolved in water, the heat of the liquid will be reduced 16 degrees.

2. If 5 oz. of nitre, and 5 of sal-ammoniac (both finely powdered) be dissolved in 19 oz. of water, the heat of the liquid will be reduced 40 degrees.

3. If 3lbs. of snow be added to 1lb. of salt, the mixture will fall to 0° (or 32 degrees below freezing point).

The two following are the coldest mixtures yet known—

1. Mix 3lbs. of muriate of lime with 1lb. of snow.

2. Mix 5lbs. of diluted sulphuric acid with 4lbs. of snow.

Q. *Why is it more easy to SWIM in the SEA than in a RIVER?*

A. Because the *specific gravity* of salt water is *greater* than that of fresh; and, therefore, it *buoys up* the swimmer better.

Q. *How do cooks ascertain if their BRINE be SALT ENOUGH for pickling?*

A. They put an egg into their brine. If the egg *sinks*, the brine is *not strong enough*; if the egg *floats*, it is.

Q. *Why will an EGG SINK, if the brine be NOT STRONG enough for pickling?*

A. Because an egg will be the *heavier*: but if as much *salt* be added as the water can dissolve, an egg will be lighter than the strong brine, and consequently float on the surface.

Q. *WHY will an EGG FLOAT in strong BRINE and not in water?*

A. Because the specific gravity of *salt and water* is greater than that of *water only*.

Q. *Why do persons SINK in water when they are UNSKILFUL SWIMMERS?*

A. Because they struggle to keep their *head out of water*.

Q. *Explain how this is.*

A. When the head is thrown back boldly into the water, the mouth is kept *above the surface*, and the swimmer is able to breathe:

But when the head is kept *above the surface* of the water, the chin and mouth sink *beneath* it, and the swimmer is suffocated.

This may be illustrated thus:—If a piece of wood be of such specific gravity, that only *two square inches* can float out of water; it is manifest, that if two *other* inches are raised out, the two *former* inches must be plunged *in*. The body (in floating) resembles this piece of wood—If two square inches of the *face* float out of the water, the swimmer can breathe; but if part of the *back* and *crown*

of the head be forcibly raised above the surface, a proportional quantity of the face must be plunged *in*; and the mouth becomes covered.

Q. . *Why can* QUADRUPEDS *swim* MORE EASILY *than* MAN?

A. 1st—Because the *trunk* of quadrupeds is *lighter* than water; and this is the greatest part of them: and

2dly—The *position* of a beast (when swimming) is a *natural* one.

Q. *Why is it* MORE DIFFICULT *for a* MAN *to swim than for a* BEAST?

A. 1st—Because his body is more *heavy* in proportion than that of a beast: and

2dly—The *position* and muscular action of a *man* (when swimming) differ greatly from his ordinary habits; but beasts swim in their *ordinary* position.

Q. *Why can* FAT *men* SWIM *more* EASILY *than* SPARE *men*?

A. Because *fat is lighter than water*; and the *fatter* a man is, the more *buoyant* will he be.

Q. *How are* FISHES *able to* ASCEND *to the* SURFACE *of* *water*?

A. Fishes have an *air-bladder* near the abdomen; when this bladder is *filled with air* the fish increases in size, and (being lighter) ascends through the water to its surface.

Q. *How are fishes able to DIVE in a minute to the BOTTOM of a stream?*

A. They *expel the air* from their air-bladder; in consequence of which, their *size is diminished*, and they sink instantly.

---

## LIGHT.

### CHAPTER XXIX.

Q. *What is LIGHT?*

A. Rapid undulations of a fluid called ether, made sensible to the eye by striking on the optic nerve.

See p. 51.

Q. *How FAST does LIGHT TRAVEL?*

A. Light travels so fast, that it would go eight times round the earth while a person counts "ONE."

Q. *Does ALL light travel equally fast?*

A. Yes; the light of the sun—the light of a candle—or the light from houses, trees, and fields.

Q. *Where does the LIGHT of HOUSES, TREES, and FIELDS, come from?*

A. The light of the sun (or of some lamp or candle) is *reflected* from their *surfaces*.

Q. *Why are SOME surfaces BRILLIANT (like glass and steel), and OTHERS DULL, like lead?*

A. Those surfaces which *reflect the most light*, are the most brilliant; and those which *absorb light* are dull.

Q. *What is meant by REFLECTING LIGHT?*

A. Throwing the rays of light *back again* from the surface on which they fall.

Q. *What is meant by ABSORBING LIGHT?*

A. Retaining the rays of light on the surface on which they fall; in consequence of which, their presence is not made sensible by *reflection*.

Q. *Why can a THOUSAND persons SEE the SAME OBJECT at the same time?*

A. Because it throws off from its surface an infinite number of rays in all directions; and one person sees *one* portion of these rays, and another person *another*.

Q. *Why is the EYE PAINED by a SUDDEN light?*

A. Because the nerve of the eye is *burdened with rays* before the pupil has had time to contract.

Q. *Why does it give us I N, if a CANDLE be brought suddenly towards our BED at night-time?*

A. Because the *pupil* of the eye *dilates* very much in the dark, in order to *admit more rays*. When, therefore, a

candle is brought suddenly before us, the enlarged pupils *overload* the optic nerves *with rays*, which causes pain.

Q. *Why CAN we BEAR the candle-light after a few moments?*

A. Because the pupils *contract again* almost instantly; and adjust themselves to the quantity of light which falls upon them.

Q. *Why can we SEE NOTHING, when we leave a WELL-LIGHTED room, and go into the DARKER ROAD or STREET?*

A. Because the pupil (which *contracted* in the bright room) does not *dilate instantaneously*; and the contracted pupil is not able to collect rays enough from the darker road or street to enable us to see objects before us.

Q. *Why do we SEE BETTER, when we get USED to the DARK?*

A. Because the pupil *dilates* again, and allows more rays to pass through its aperture; in consequence of which, we see more distinctly.

Q. *If we look at the SUN for a few moments, why do all OTHER things appear DARK?*

A. Because the pupil of the eye becomes so much *contracted* by looking at the sun, that it is *too small* to collect sufficient rays from *other objects* to enable



us to distinguish their colors. (*See* "Accidental colors;" pp. 375, 376.)

Q. *If we watch a bright FIRE for a few moments, why does the ROOM seem DARK?*

A. Because the pupil of the eye becomes so much *contracted* by looking at the fire, that it is *too small* to collect sufficient rays from the objects around to enable us to distinguish their colors.

Q. *Why can we see the PROPER COLORS of every object again, after a few minutes?*

A. Because the pupil dilates again and accommodates itself to the light around.

Q. *Why can TIGERS, CATS, and OWLS, see in the DARK?*

A. Because they have the power of *enlarging the pupil of their eyes* so as to collect several scattered rays of light; in consequence of which, they can see *distinctly* when it is not light enough for us to see *any thing at all*.

Q. *Why do CATS and OWLS SLEEP almost all DAY?*

A. Because the pupil of their eyes is *very broad*, and daylight *fatigues* them; so they close their eyes for relief.

Q. *Why do CATS keep WINKING, when they sit before a FIRE?*

A. Because the pupil of their eye is

*very broad*, and the light of the fire is painful ; so they keep shutting their eyes to relieve the sensation of too much light.

Q. *Why do* TIGERS, CATS, OWLS, &c., PROWL *by* NIGHT *for* prey ?

A. Because they *sleep* all *day* when the strong light would be painful to them ; and as they can see clearly in the *dark*, they prowl then for prey.

Q. *Why do* GLOW-WORMS *glisten* *by* NIGHT *only* ?

A. Because the light of day is so *strong* that it *eclipses* the feeble light of a glow-worm ; in consequence of which, glow-worms are *invisible* *by* day.

Q. *Why can we* NOT *see* the STARS *in* the DAY-TIME ?

A. Because the light of day is so powerful that it *eclipses* *the feeble light of the stars* : in consequence of which, they are invisible by day.

Q. *Why can we* see the STARS *even* at MID-LAY, *from* the bottom of a deep WELL ?

A. Because the light of the stars is not overpowered by the rays of the sun, which are lost in the numerous reflections which they undergo in the well.

The rays of the *sun* will enter the well *very obliquely* : whereas, many *stars* will shine *directly* *over* the well. See pp. 348, 349.

Q. *What is the USE of TWO EYES, since they present only one image of any object?*

A. To *increase the light*—or to take in *more rays of light* from the object looked at, in order that it may appear *more distinct.*

Q. *Why do we NOT see things DOUBLE, with TWO EYES?*

A. 1st—Because the *axis of both eyes is turned to one object*; and, therefore, the *same impression* is made on the retina of *each eye*: and

2dly—Because the nerves (which receive the impression) have *one point of union* before they reach the brain.

This is not altogether satisfactory, although it is the explanation generally given. The phenomenon probably is rather psychological than material.

Q. *Why do we SEE OURSELVES in a GLASS?*

A. Because the rays of light from our face *strike against the surface of the glass*, and (instead of being absorbed) *are reflected*, or sent back again to our eye.

Q. *Why are the rays of light REFLECTED by a MIRROR?*

A. Because they cannot *pass through the impenetrable metal* with which the back of the glass is covered; so they *rebound back*, just as a *marble* would do, if it were thrown against a wall.

Q. When a marble is rolled towards a wall, what is the path THROUGH WHICH IT RUNS called?

A. The line of INCIDENCE.

Q. When a marble REBOUNDS back again, what is the path it THEN describes called?

A. The line of REFLECTION.

See figure below. If AB be the line of incidence, then BC is the line of reflection; and *vice versa*.

Q. When the light of our face goes TO the GLASS, what is the path through which it goes CALLED?

A. The line of *incidence*.

Q. When the light of our face is reflected BACK again from the mirror, what is this RETURNING path called?

A. The line of *reflection*.

Q. What is the ANGLE of *incidence*?

A. The angle between the line of *incidence* and the *perpendicular*.

Q. What is the ANGLE of *reflection*?

A. The angle between the line of *reflection* and the *perpendicular*. (See *Fig.*)

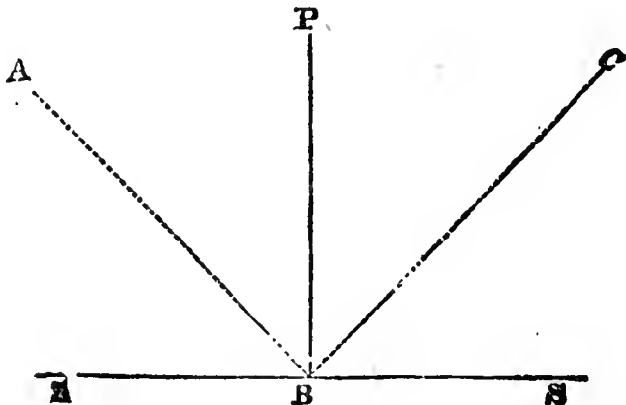

Let  $SS$  be any surface,  $PB$  a perpendicular to it.—If a marble were thrown from  $A$  to  $B$ , and bounded back to  $C$ ; then  $ABP$  would be called the angle of *incidence*, and  $CBP$  the angle of *reflection*.

Q. *Why does our reflection in a mirror seem to APPROACH us, as we walk TOWARDS it; and to RETIRE FROM us, as WE retire?*

A. Because the lines and *angles of incidence* are always equal to the lines and *angles of reflection*; in consequence of which, the *image* will always seem to be as far *behind* the mirror as the *real object* is *before* it.

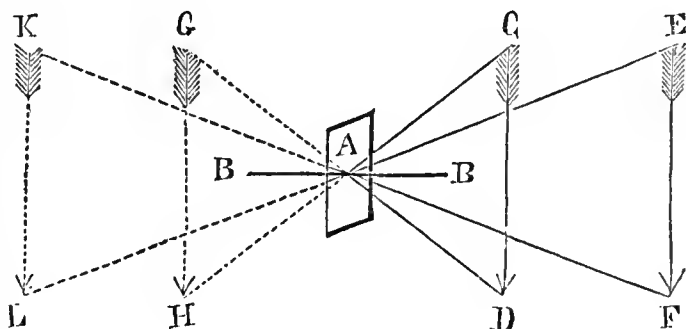

Suppose  $A$  to be a mirror— $CA$ ,  $EA$  and  $DA$ ,  $FA$ , the lines of incidence; then  $GA$ ,  $KA$  and  $HA$ ,  $LA$ , are the lines of reflection. When the arrow is at  $CD$ , its image will appear at  $GH$ , because line  $CA=GA$ , and line  $DA=HA$ ; and also the angle  $CAB=\text{angle } GAB$ , and angle  $DAB=HAB$ . For a similar reason, if the arrow were at  $EF$ , the image would seem to be at  $KL$ .

Q. *Why can a man see his WHOLE PERSON reflected in a LITTLE MIRROR, not 6 inches in length?*

A. Because the *lines and angles of incidence* are always equal to the *lines and angles of reflection*; in consequence of which, his image will seem to be as

far *behind* the mirror as his person is *before* it.

Take the last figure—CD is much larger than the mirror A; but the head of the arrow C is reflected obliquely behind the mirror to G; and the barb D appears at H.—Why? Because line CA=GA, and line DA=HA; also the angle CAB=angle GAB, and angle DAB=HAB.

Q. *Why does the IMAGE of any object in WATER always appear INVERTED?*

A. Because the *angles of incidence* are always equal to the *angles of reflection*.

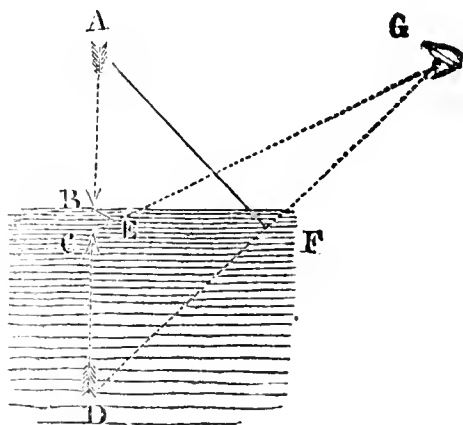

Here the arrow-head A strikes the water at F, and is reflected to D; and the barb B strikes the water at E, and is reflected to C.

If a spectator stands at G, he will see the reflected lines CE and DF produced as far as G.

It is very plain, that A (the more *elevated* object) will strike the water, and be projected from it more perpendicularly than the point B; and, therefore, the image will seem inverted. *See p. 345.*

Q. *When we see our REFLECTION in WATER, why do we seem to STAND on our HEAD?*

A. Because the *angles of incidence*

are always equal to the *angles of reflection*.

Suppose our head to be at A, and our feet at B; then the shadow of our head will be seen at D, and the shadow of our feet at C. (*See figure on p. 346.*)

Q. *Why do WINDOWS seem to BLAZE at SUN-RISE and SUN-SET?*

A. Because glass is a good *reflector of light*; and the rays of the sun (striking against the window-glass) are *reflected*, or thrown back.

Q. *Why do NOT windows reflect the NOON-DAY rays also?*

A. They do, but the reflection is *not seen*.

Q. *Why is the reflection of the RISING and SETTING sun seen in the window, and NOT that of the NOON-DAY sun?*

A. Because the rays of the noon-day sun enter the glass *too obliquely* for their reflection to be seen.

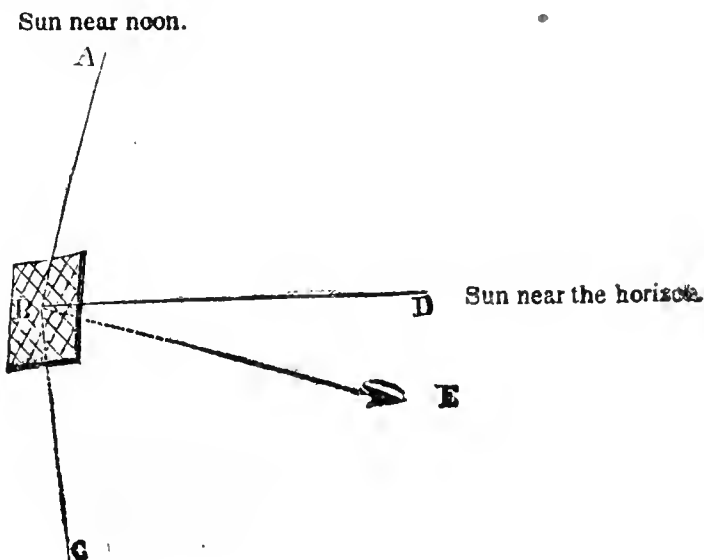

In the preceding cut, AB represents a ray of the noon-day sun striking the window at B; its reflection will be at C.

But DB (a ray of the rising or setting sun) will be reflected to E (the eye of the spectator.)

Q. *Why can we not see the REFLECTION of the SUN in a WELL, during the day-time?*

A. Because the rays of the SUN *fall so obliquely* that they *never reach* the surface of the water at all, but strike against the brick sides.

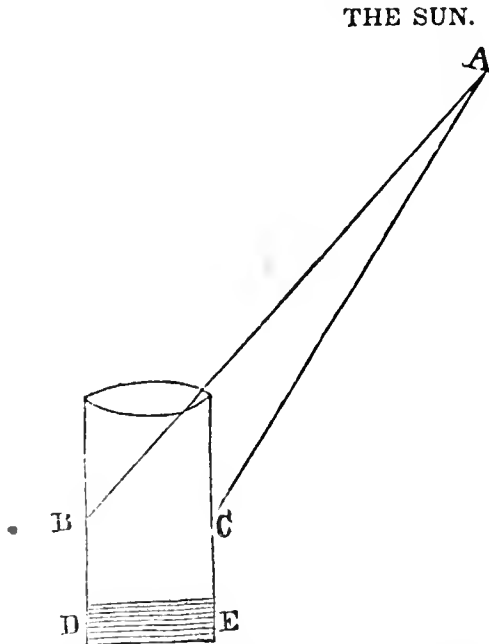

Let BDEC be the well, and DE the water.

The ray AB strikes against the brick-work *inside* the well; and

The ray AC strikes against the brick-work *outside* the well.

None will ever touch the water DE.

Q. *Why are STARS REFLECTED in a WELL although the SUN is NOT?*

A. Because the rays of those STARS, which pass nearly *over-head*, will not fall



so obliquely into the well as the rays of the sun.

## THE MOON OR A STAR.

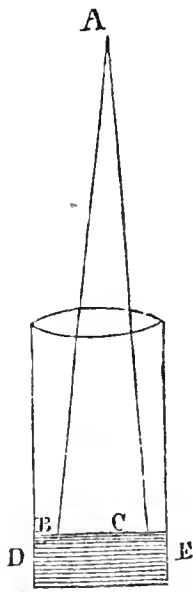

Here the star's rays AB, AC, both strike the water DE, and are reflected by it.

Q. *On a lake of water, the MOON seems to make a PATH of light towards the eye of the spectator, while all the REST of the lake seems DARK—WHY is this?*

A. Because the lake is in deep shadow; and many rays which would be eclipsed by the broad light of day become visible.

The same *path* of light may be discerned in the day-time, when a *cloud* passes over the sun.

Q. *In a sheet of water at noon, the sun appears to shine upon only ONE spot, and all the REST of the water seems DARK—WHY is this?*

A. Because the rays fall at various degrees of obliquity on the water, and

are reflected at *similar angles*; but as only those which *meet the eye of the spectator* are visible, all the water will appear dark except *that one spot*.

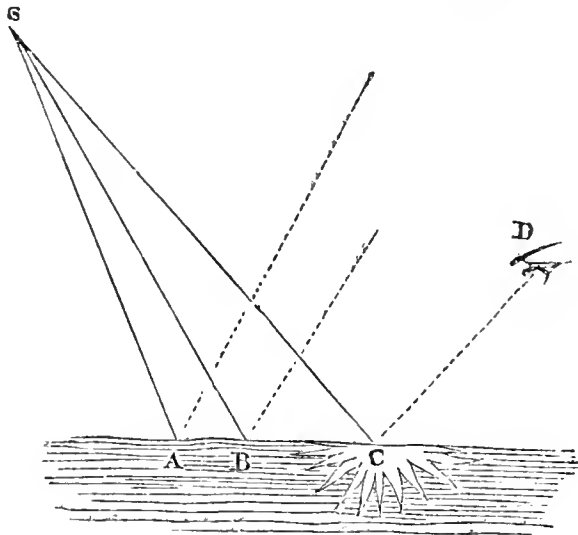

Here, of the rays SA, SB, and SC, only the ray SC meets the eye of the spectator D.

The spot C, therefore, will appear luminous to the spectator D, but no other spot of the water ABC.

Q. *Why are MORE STARS visible from a MOUNTAIN than from a PLAIN?*

A. Because they have less *air* to pass through. As air *absorbs* and *diminishes* light; therefore, the *higher* we ascend, the *less light* will be absorbed.

Q. *Why do the SUN and MOON seem LARGER at their RISING and SETTING, than at any other time?*

A. Because the arch of the sky (in which the sun and moon are seen) is

further distant at the horizon than it is over-head.

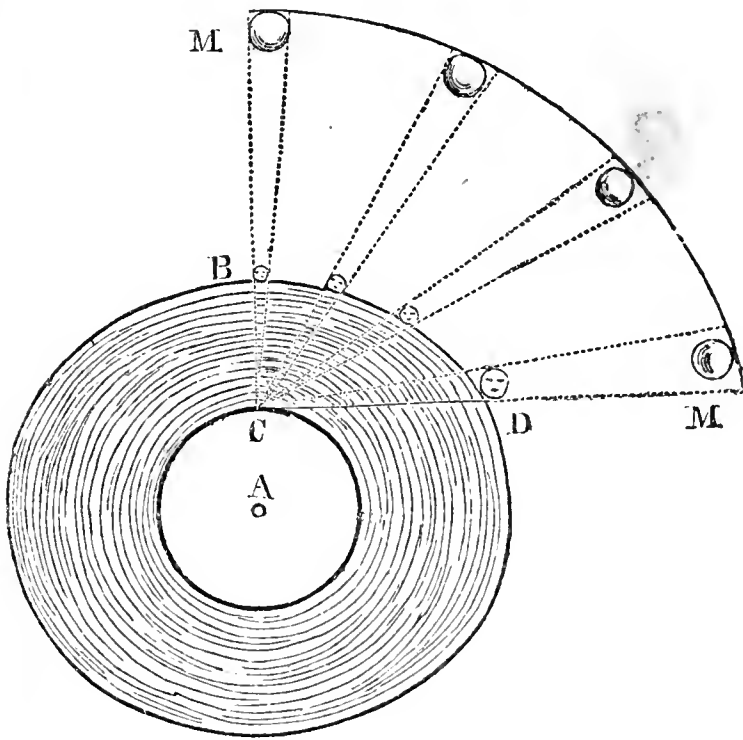

Let MM be the orbit of the sun or moon.

Let BD be the arch of the sky, in which the sun and moon are seen by us.

It will be seen from the figure, that the sun or moon at the horizon will appear much larger, because CD is longer than CB.

The Phenomenon referred to on p. 350, (called the horizontal Sun and Moon), has perplexed philosophers to the present hour. The solution given is not altogether satisfactory—Sir J. Herschell says, “The dilated size of the sun or moon, when seen near the horizon, has nothing to do with *refraction*. It is an illusion of the *judgment*, arising from the terrestrial objects interposed, or placed in comparison with them. Actual measurement with a proper instrument corrects our error, without, however, dispelling our illusion—the whole is owing to the effect of *parallax*.”

Q. Why can we NOT SEE into the STREET or road, when CANDLES are LIGHTED ?

A. 1st—Because glass is a reflector, and throws the candle-light *back into the room* again : and

2dly—The pupil of the eye (having become *contracted* by the light of the room) is *too small* to collect rays enough from the dark street to enable us to see *into it*.

Q. Why do we often see the FIRE REFLECTED in our parlor WINDOW in winter-time ?

A. Because glass is a *good reflector* ; and the rays of the fire (striking against the window-glass) *are reflected back into the room again*.

Q. Why do we often see the image of our CANDLES in the window, while we are sitting in our parlor ?

A. Because the rays of the candle (striking against the glass) are *reflected back into the room* ; and the *darker* the night, the *clearer* the reflection.

Q. WHY is this reflection more clear, if the external AIR be DARK ?

A. Because the reflection is not *eclipsed* by the brighter rays of the sun striking on the other side of the window.

Q. If the SHADOW of an object be thrown on a wall—the CLOSER the object is held to the CANDLE, the LARGER will be its SHADOW. Why is this ?

A. Because the rays of light *diverge* (from the flame of a candle) *in straight lines* like lines drawn from the centre of a circle.

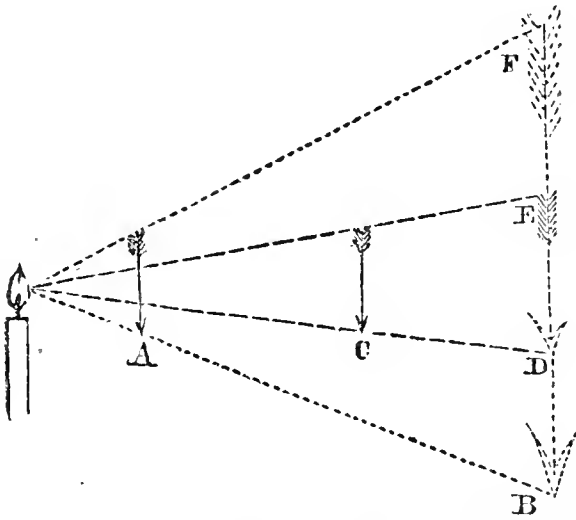

Here the arrow A held close to the candle, will cast the shadow BF on a wall; while the same arrow held at C would cast only the little shadow DE.

Q. *When we enter a long AVENUE of TREES, WHY does the avenue seem to get NARROWER and narrower till the two sides appear to MEET?*

A. Because the *further the trees are off*, the more *acute will be the angle* that any opposite two make with our eye.

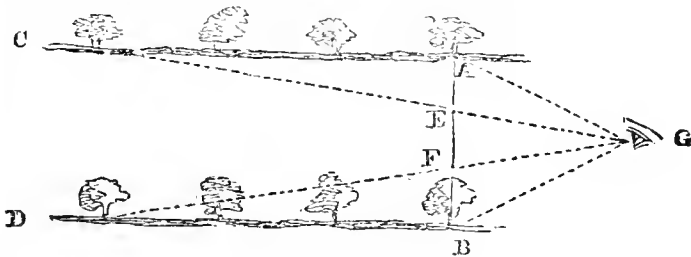

Here the width between the trees A and B will seem to be as great as the line AB:

But the width between the trees C and D will seem to be no more than EF.

Q. In a long, straight STREET, WHY do the houses on the opposite sides seem to APPROACH NEARER together as they are more DISTANT?

A. Because the more *distant the houses* are the more *acute will be the angle* which any opposite two make with our eye.

Thus in the last figure,

If A and B were two houses at the *top* of the street, the street would seem to be as wide as the line AB :

And if C and D were two houses at the *bottom* of the street, the street there would seem to be no wider than EF.

Q. In an AVENUE, WHY do the TREES seem to be SMALLER as their distance increases?

A. Because the *further the trees are off*, the more *acute will be the angle* made by their perpendicular height with our eye.

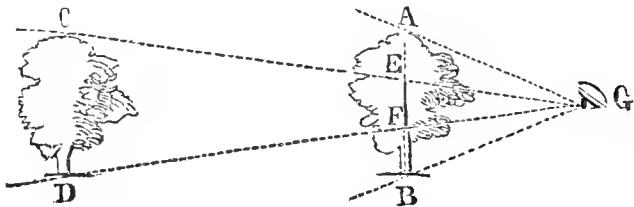

Here the first tree AB will appear the height of the line AB; but the last tree CD will appear only as high as the line EF.

Q. In a long, straight STREET, WHY do the houses seem to be SMALLER and smaller, the FURTHER they are OFF?

A. Because the *further any house is off*, the more *acute will be the angle* made by its perpendicular height with our eye.

Thus in the last figure,

If AB be a house at the top of the street, its perpendicular height will be that of the line AB.

If CD be a house at the bottom of the street, its perpendicular height will appear to be that of EF.

Q. *Why does a man on the TOP of a MOUNTAIN, or church spire, seem to be no BIGGER than a CROW?*

A. Because the angle made in our eye by the *perpendicular height of the man* at that distance, is no bigger than that made by a *crow close by*.

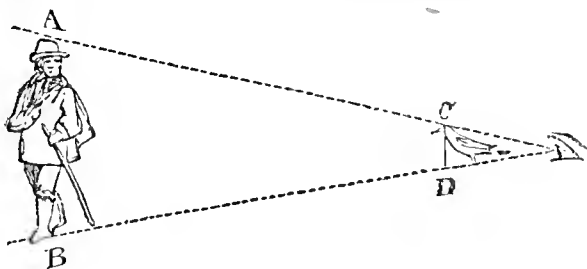

Let AB be a man on a distant mountain, or spire, and CD a crow close by:

The man will appear only as high as the line CD, which is the height of the crow.

Q. *Why does the MOON appear to us so much LARGER than the STARS, though, in fact, it is a great deal SMALLER?*

A. Because the moon is *very much nearer to us* than any of the stars.

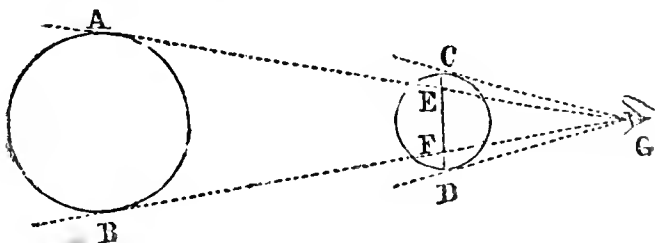

Let AB represent a fixed star, and CD the moon.

AB, though much the larger body, will appear no bigger than EF; whereas the moon (CD) will appear as large as the line CD to the spectator G.

The moon is 240,000 miles from the earth, not quite a quarter of a *million* of miles. The nearest fixed stars are 20,000,000,000,000. (i. e., 20 billions.)

If a ball went 500 miles an hour, it would reach the moon in twenty days: but it would not reach the nearest fixed star in 4,500,000 years. Had it begun, therefore, when Adam was created, it would be no further on its journey than a coach (which has to go from the Land's End, Cornwall, to the most northern parts of Scotland) after it has passed about three-quarters of a mile.

Q. *Why does the MOON (which is a sphere) APPEAR to be a FLAT surface?*

A. Because it is so *far off* that we cannot distinguish any difference between the *length of the rays* issuing from the *edge* and those which issue from the *centre*.

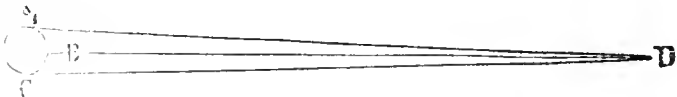

The rays AD and CD appear to be no longer than the ray BD; but if all the rays seem of the same length, the part B will not seem to be *nearer* to us than A and C; and therefore ABC will look like a flat or straight line.

The rays AD and CD are 240,000 miles long.

The ray BD is 238,910 miles long.

Q. *Why do the SUN and STARS (which are spheres) appear to be FLAT surfaces?*

A. Because they are such an *immense way off*, that we can discern *no difference of length* between the rays which issue from the *edge* and those



which issue from the *centre* of these bodies.

The rays AD and CD appear no longer than BD; and as B appears to be no nearer than A or C, therefore A, B, C, must all seem equally distant; and ABC will seem a flat or straight line. (See last figure, p. 356.)

Q. *Why does DISTANCE make an object INVISIBLE?*

A. Because no visible perpendicular can be inserted between the lines which form the angle; or because the lines actually cross before they meet our eye.

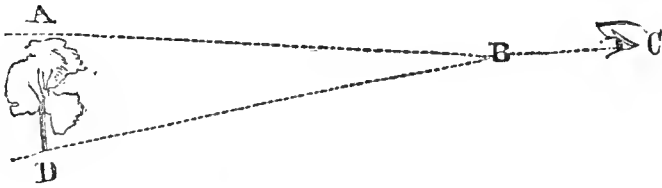

Here the tree AD would not be visible to the spectator C, even if he were to approach as far as B; because no visible perpendicular can be inserted between the two lines AC, DC, at the point B, and after B the lines would cross: Therefore, the tree would be invisible from C, till after the spectator had passed B.

Q. *Why do TELESCOPES enable us to SEE objects INVISIBLE to the naked eye?*

A. Because they gather together more luminous rays from obscure objects than the *eye* can; and form a bright image of them in the tube of the telescope where they are magnified.

As many times as the dimensions of the *object-glass* exceed the dimensions of the *pupil of the eye*, so many times the penetrating powers of the telescope will exceed that of the naked eye.

Q. When a SHIP (out at sea) is approaching the shore, why do we SEE the small MASTS before we see the bulky HULL ?

A. Because the *earth is round*; and the *curve of the sea hides the hull* from our eyes after the tall *masts* have become visible.

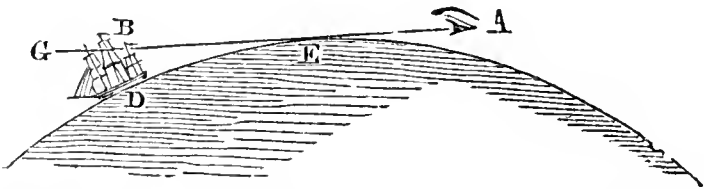

Here, only that part of the ship above the line AG can be seen by the spectator A; the rest of the ship is hidden by the swell of the curve DE.

Q. What is meant by REFRACTION ?

A. *Bending a ray of light*, as it passes from one medium to another.

Q. How is a ray of light BENT, as it passes from one medium to another ?

A. When a ray of light passes into a *denser* medium it is bent *towards* the perpendicular. When it passes into a *rarer* medium it is bent *from* the perpendicular.

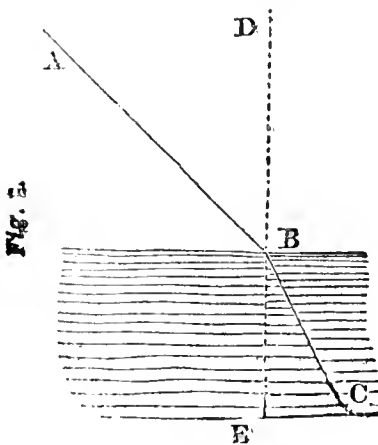

FIG. 2.

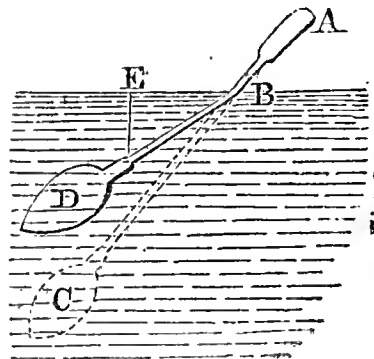

FIG. 2.

Suppose DE to be a perpendicular line.

If AB (a ray of light) enters the water, it will be bent *towards* the perpendicular to C.

If (on the other hand) CB (a ray of light) emerges *from* the water, it would be bent *away from* the perpendicular towards A.

Q. *Why does a SPOON (in a glass of water) always appear BENT?*

A. Because the light (reflected from the spoon) is *refracted* as it *emerges from the water*.

See Fig. 2, p. 358. The spoon ABC will appear bent, like ABD.

Q. *Why does a river always appear more shallow than it really is?*

A. Because the light of the bottom of the river is REFRACTED, as it emerges out of the water.

See Fig. 2, p. 358. The bottom of the river will appear elevated like the bowl of the spoon D.

Q. *How much deeper is a river than it seems to be?*

A. About one-third. If, therefore, a river seems only 4 feet deep, it is really 6 feet deep.

The exact apparent depth would be  $4\frac{1}{3}$ . To find the real depth, multiply by 4 and divide by 3—thus  $4\frac{1}{3} \times 4 \div 3 = 6$ , real depth.

N. B. Many boys get out of their depth in bathing, in consequence of this deception. Remember, a river is always one-third deeper than it appears to be:—thus, if a river seems to be 4 feet deep, it is in reality nearly 6 feet deep, and so on.

Q. *Why do fishes seem to be nearer the surface of a river than they really are?*

A. Because the rays of light from the fish are *refracted*, as they emerge from the eye: and (as a bent stick is not so far from end to end, as a straight one) so the fishes appear nearer to our eye than they really are.

*See Fig. 2, p. 358.*

Q. *Why are some persons NEAR-SIGHTED?*

A. Because the COR'NEA of their eye is so *prominent*, that the image of distant objects is formed *before it reaches the RET'INA*; and, therefore, is not distinctly seen.

Q. *What is meant by the "COR'NEA of the EYE?"*

A. All the *outside* of the visible part of the *eye-ball*.

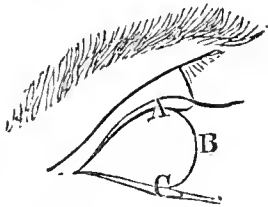

The curve ABC is called the COR'NEA.

If this curve be too prominent (or convex), the eye is near-sighted.

If too flat (or concave), the eye is far-sighted.

Q. *What is meant by the "RET'INA of the EYE?"*

A. The net-work, which lines the *back of the eye*, is called the *ret'ina*.

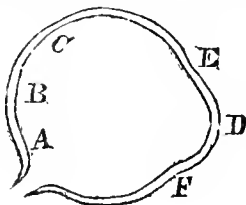

The net-work ABC is called the *ret'ina*, and the projecting part DEF is called the *cor'nea*.

N. B. This net-work is composed of a spreading out of the fibres of the nerve of vision.

Q. — *What sort of GLASSES do NEAR-SIGHTED persons wear?*

A. If the cor'nea be *too convex* (or projecting), the person must wear double *concave glasses*, to counteract it.

Q. *What is meant by "DOUBLE CONCAVE GLASSES?"*

A. Glasses hollowed-in *on both sides*.

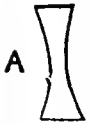

The figure A is double concave, or concave on both sides.

Q. *Where is the IMAGE of objects formed, if the cornea be too convex?*

A. If the cor'nea be *too convex*, the image of a distant object is formed in the *vitreous humors* of the eye, and not on the *ret'ina*.

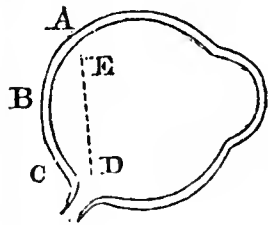

Thus the image is formed at **DE**, and not on **ABC** (the retina).

Q. *What is the use of DOUBLE CONVEX SPECTACLE glasses?*

A. To *cast the image further back*, in order that it may be thrown upon the *ret'ina* and become visible.

Q. *Why are OLD people FAR-SIGHTED?*

A. Because the humors of their eyes are *dried up by age*; in consequence of

which, the COR'NEA *sinks in*, or becomes flattened.

Q. *Why does the FLATTENING of the COR'NEA prevent persons seeing objects which are NEAR?*

A. Because the cor'nea is *too flat*, and the image of near objects is not *completely* formed, when their rays reach the RET'INA; in consequence of which, the image is imperfect and confused.

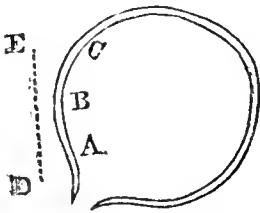

The perfect image is made at DE; and not on ABC (the retina).

Q. *What sort of GLASSES do OLD people WEAR?*

A. As their cor'nea is *not sufficiently convex*, they must use *double convex glasses*, to enable them to see objects near at hand.

Q. *What sort of glasses are "DOUBLE CONVEX SPECTACLE-GLASSES?"*

A. Glasses which *curve outwards* on both sides.



The figure A is double convex, or convex on both sides.

Q. *What is the use of DOUBLE CONVEX spectacle-glasses?*

A. To shorten the focus of the eye,

and bring the image of distant objects upon the retina.

Q. *Why do NEAR-SIGHTED persons bring objects CLOSE to the eye, in order to SEE THEM?*

A. Because the distance between the *front and back of the eye is so great*, that the image of distant objects is formed in *front* of the *retina*; but when objects are brought *near to the eye*, their image is thrown *further back*, and made to fall on the retina.

Q. *Why do OLD people HOLD objects FAR OFF, in order to see them better?*

A. Because the distance between the *front and back of their eyes is not great enough*: when, however, objects are held further off, it compensates for this defect; and a perfect image is formed on the retina.

Q. *Why are HAWKS able to see such an IMMENSE way off?*

A. Because they have a muscle in the eye which enables them to *flatten their cor'nea*, by drawing back the crystalline lens. *See p. 362.*

This muscle is called the Marsupium.

Q. *Why can HAWKS see objects within half-an-inch of their eye, as well as those a long way off?*

A. Because their eyes are furnished with a flexible bony rim, which throws

the *cor'nea forward*, and makes the hawk *near-sighted*. See p. 360.

Q. *Into how many PARTS may a RAY of LIGHT be DIVIDED?*

A. Into three parts: BLUE, YELLOW, and RED.

N. B. These three colors, by combination, make seven. 1.—RED. 2.—ORANGE (of red and yellow). 3.—YELLOW. 4.—GREEN (of yellow and blue). 5.—BLUE. 6.—INDIGO (a shade of blue); and 7.—VIOLET (or blue and red).

Q. *How is it known, that a ray of light consists of several different colors?*

A. Because, if a ray of light be cast upon a triangular piece of glass (called a prism), it will be distinctly divided into seven colors: 1.—Red; 2.—Orange; 3.—Yellow; 4.—Green; 5.—Blue; 6.—Indigo; and 7.—Violet.

Q. *Why does a PRISM DIVIDE a ray of light into VARIOUS COLORS?*

A. Because all these colors have *different refractive susceptibilities*. Red is refracted *least*, and blue the *most*; therefore, the *blue* color of the ray will be bent to the *top* of the prism, and the *red* will remain at the *bottom*.



Here the ray AB (received on a prism at B), would



have the blue part bent up to C; the yellow part to D; and the red part no further than E.

Q. *What is meant by the REFRACTION of a ray?*

A. *Bending it from its straight line.*

Thus the ray AB of the last figure is refracted at B into three courses, C, D, and E.

Q. *What is the cause of a RAINBOW?*

A. When the clouds opposite the sun are very dark, and rain is still falling from them, the rays of the bright sun are divided by the rain-drops, as they would be by a prism.

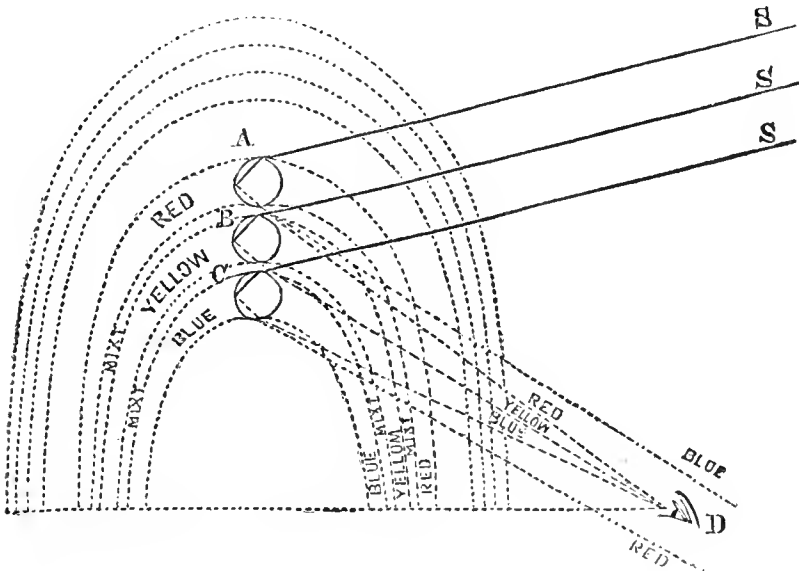

Let A, B, and C, be three drops of rain; SA, SB, and SC, three rays of the sun. SA is divided into three colors; the blue and yellow are bent *above* the eye D, and the red enters it.

The ray SB is divided into the three colors; the blue is bent *above* the eye, and the red falls *below* the eye D; but the yellow enters it.

The ray SC is also divided into the three colors. The blue (which is bent most) enters the eye; and the other

two fall below it. Thus the eye sees the blue of C, and of all drops in the position of C; the yellow of B, and of all drops in the position of B; and the red of A, and of all drops in the position of A; and thus it sees a rainbow.

Q. Does EVERY person see the SAME colors from the SAME DROPS?

A. No; no two persons see the same rainbow.

To another spectator, the rays from SB might be red instead of yellow; the ray from SC yellow; and the blue might be reflected from some drop below C. To a third person, the red may issue from a drop above A, and then A would reflect the yellow, and B the blue, and so on.

Q. Why are there often TWO RAINBOWS at one and the same time?

A. In one rainbow we see the rays of the sun entering the rain-drops at the top, and reflected to the eye from the bottom.

In the other rainbow, we see the rays of the sun entering the rain-drops at the bottom, and reflected to the top, whence they reach the eye.

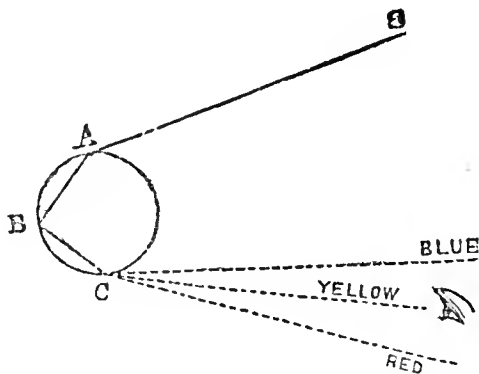

Here the ray SA (of the primary rainbow) strikes the drop at A—is refracted or bent to B—is then reflected

to C, where it is refracted again, and reaches the eye of the spectator. (*See below.*)

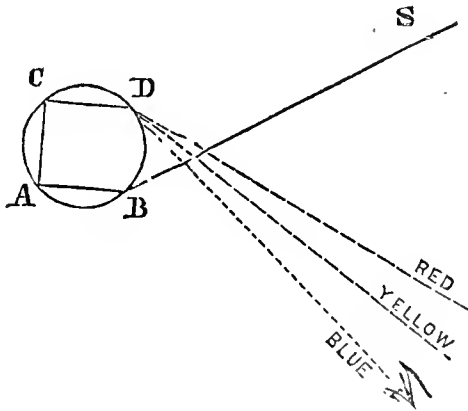

Here the ray of SB (of the secondary rainbow) strikes the drop at B—is refracted to A—is then reflected to C—is again reflected to D, when it is again refracted or bent, till it reaches the eye of the spectator.

Q. *Why are the COLORS of the SECOND bow all REVERSED?*

A. Because in *one* bow we see the rays, which enter at the *top* of the rain-drops, *refracted from the bottom*:

But in the *other* bow we see the rays which enter at the *bottom* of the rain-drops (after two reflections), *refracted from the top*.

*See figure on next page.*

Here ABC represent three drops of rain in the SECONDARY (or upper) RAINBOW.

The *least* refracted line is RED, and BLUE the *most*.

So the RED (or *least* refracted rays) of all the drops in the position of A—the YELLOW of those in the position of B—and the BLUE (or the *most* refracted rays) of the lowest drops, all meet the eye D, and form a rainbow to the spectator.

The reason why the primary bow exhibits the stronger colors is this—because the colors are seen after *one* reflec-

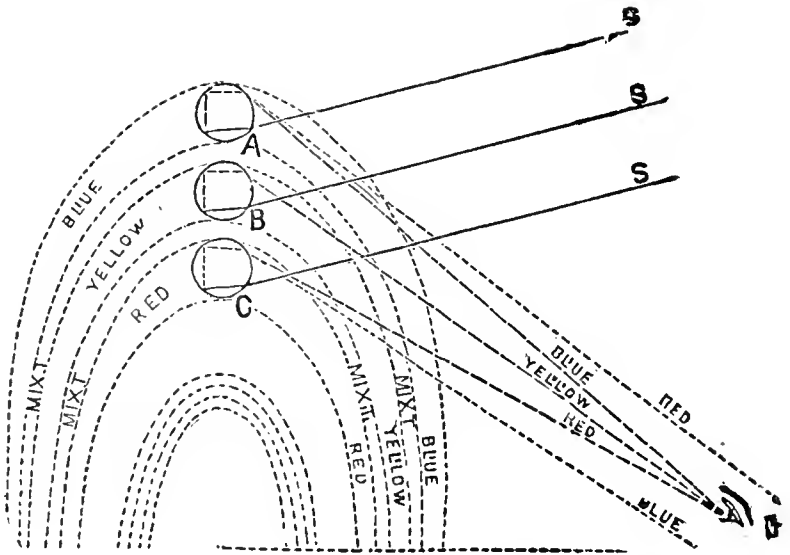

tion and *two* refractions; but the colors of the secondary (or upper) rainbow, undergo *two* reflections and *two* refractions.

(See figure on p. 365.) Here also the *least* refracted ray is RED, and the *most* refracted BLUE (as in the former case); but the position of each is reversed.

Q. Why does a SOAP BUBBLE exhibit such a VARIETY of COLORS?

A. Because the *thickness* of the film through which the rays pass, is constantly varying.

Q. How does the THICKNESS of the FILM affect the COLOR of the soap bubble?

A. Because different *degrees* of thickness in the film produce different powers of refraction; and, therefore, as the *thickness* of the film varies, different colors reach the eye.

Q. Why is a SOAP BUBBLE, so constantly CHANGING its THICKNESS?

A. Because the water *runs down from the top* to the bottom of the bubble, till the crown becomes so *thin* as to burst.

Q. *Why are the late EVENING CLOUDS RED?*

A. Because RED rays, being the *least refrangible*, are the *last* to disappear.

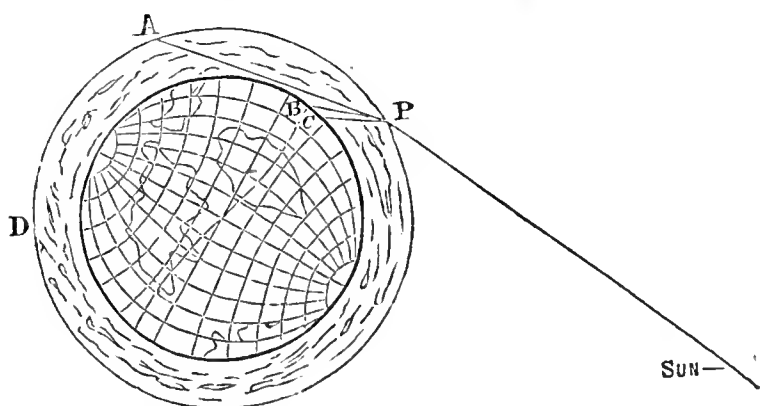

Suppose PA to be a red ray, PB yellow, and PC blue--if the earth turns in the direction of CBD, it is quite manifest that a spectator standing at C or B (carried round in the same direction), would lose sight of the red rays (A) last of all.

Q. *Why are the early MORNING clouds RED?*

A. Because RED rays being the *least refrangible* are the *first* to appear.

*See last figure.*—We must suppose the sun to be on the left side of the diagram—or (what will answer the same purpose) suppose the earth to be turning in the direction of DAP, then it is quite clear, that every person on the earth's surface will pass under A (the red rays) before he passes under B or C, (and therefore his early morning rays will be red.)

Q. *Why are the EDGES of CLOUDS more LUMINOUS than their CENTRES?*

A. Because the *body of vapor is thinnest* at the edges of the clouds.

Q. *What is the cause of morning and evening TWILIGHT?*

A. When the sun is below the horizon, the rays which strike upon the atmosphere or clouds are *bent down towards the earth*, and produce a little light called twilight.

*See figure on p. 369.*—Here the rays of PA will give some light.

Q. *WHY is a ray of LIGHT composed of VARIOUS COLORS?*

A. To vary the color of different objects. If solar light were of *one color only*, all objects would appear of *that one color*, or else black.

Q. *Some things are of ONE COLOR, and some of ANOTHER. Explain the cause of this.*

A. As every ray of light is composed of all the colors of the rainbow; *some things reflect one of these colors* and *some another*.

Q. *WHY do some things reflect ONE COLOR, and some ANOTHER?*

A. Because the *surface* of things is so *differently constructed*, both physically and chemically.

Q. *Why is a ROSE RED?*

A. Because the surface of a rose *ab-*

*absorbs* the *blue* and *yellow* rays of light, and *reflects* only the *red*.

Q. *Why is a VIOLET BLUE?*

A. Because the surface of the violet *absorbs* the *red* and *yellow* rays of the sun, and *reflects* the *blue* only.

Q. *Why is a PRIMROSE YELLOW?*

A. Because the surface of the primrose *absorbs* the *blue* and *red* rays of solar light, and *reflects* the *yellow*.

The chief reason why some rays are *absorbed* and others *reflected*, is, because the *corpuscles* which compose the colored substance vary in magnitude:—thus, for example, if the diameter of a corpuscle of equal density with air be 21 millionth of an inch, it will reflect purple; if, on the other hand, it be 29 millionth of an inch, it will reflect red, and so on.

Q. *Why are some things BLACK?*

A. Because they *absorb all the rays* of light and reflect *none*.

Q. *Why are some things WHITE?*

A. Because they *absorb none of the rays* of light, but reflect them all.

Q. *Why are COALS BLACK?*

A. Because they *absorb all the rays of the sun* which impinge upon them.

Q. *Why are FROTH, and SPRAY, and many CLOUDS, WHITE?*

A. Because they consist of an infinite number of small bubbles or vesicles, which act like *prisms* in dividing the

rays of light ; which, by *uniting* again before they meet the eye, give the appearance of white.

Q. *Why are SNOW, SUGAR, and SALT WHITE ?*

A. (See page 312.)

N. B. The combination of *all* colors makes WHITE.

Q. *Why are the LEAVES of plants GREEN ?*

A. Because a peculiar chemical principle, called chlo'rophyll, is formed within their *cells* ; which has the property of absorbing the *red* rays and of reflecting the blue and yellow ; which mixture produces *green*.

Chlorophyll (*χλωρον φυλλον*, a green leaf) is the green matter of vegetable substances. *Pronounce* klo-ro-fill.

Q. *Why are leaves a LIGHT green in SPRING ?*

A. Because the chlo'rophyll is not fully formed.

Q. *Why do leaves turn BROWN in AUTUMN ?*

A. Because the chlo'rophyll undergoes *decay*, and is not replaced as it is in spring.

Q. *Why are plants a PALE YELLOW, when kept in the DARK ?*

A. Because chlo'rophyll can be formed only by the agency of the *sun's rays*.

Q. *Why are POTATOES YELLOW ?*

A. Because they are grown *underground* ; and, therefore, can form no chlo'rophyll in their tubers.



Q. *Why are potatoes which grow EXPOSED to the air and light GREEN?*

A. Because chlo'rophyll is formed in them under the influence of the sun's light.

Q. *Why are SOME things TRANSPARENT?*

A. Because every part between the two surfaces has a *uniform refracting* power, or (in other words) has in every place the same density.

And, therefore, the rays of light *emerge* on the opposite side.

Q. *Why are some things NOT TRANSPARENT?*

A. Because the particles which compose them are separated by minute *pores* or *spaces*, which have a different density from the particles themselves.

Therefore, the rays of light are reflected and refracted too often to emerge.

Q. *Why are DRY PAPER and calico (which are OPAQUE) made transparent by being OILED?*

A. Because the pores are filled by the oil, which has nearly the same density as the substance of the paper itself —by which means a uniform density is effected, and the substance becomes transparent.

Q. *Why is GLASS (which is transparent) rendered OPAQUE by being ground or pulverized?*

A. Because the whole substance

from surface to surface is no longer of one uniform density.

Q. *Why are SOME things SHINING, and others DULL?*

A. Because some things *reflect* rays, and are *bright*; but others *absorb* them.

Q. *Why do DESERTS DAZZLE from sunshine?*

A. Because each grain of sand *reflects the rays of the sun* like a mirror.

Q. *If you move a stick (burnt at one end) pretty briskly AROUND, it seems to make a CIRCLE OF FIRE—WHY is this?*

A. Because the eye *retains the image* of any bright object, *after the object itself is withdrawn*; and as the spark of the stick returns *before the image has faded* from the eye, it seems to form a *complete circle*.

Q. *If separate figures (as a man and a horse) be drawn on separate sides of a card, and the card TWISTED quickly, the man will seem to be seated on the horse—WHY is this?*

A. Because the image of the horse *remains upon the eye* till the man appears.

The Thaumatrope is constructed on this principle.

Q. *Why do the STARS TWINKLE?*

A. Because the inequalities and undulations in the atmosphere produce *unequal refractions of light*; and these

unequal refractions cause the *twinkling* or irregular brilliancy of the stars.

Q. *If we look at a RED-HOT FIRE for a few minutes, WHY does every thing seem TINGED with a BLUISH GREEN color?*

A. Because bluish green is the "ACCIDENTAL COLOR" of red; and if we fix our eye upon *any color whatsoever*, we see every object tinged with its *accidental color* when we turn aside.

The *accidental color* is the color which would be required to be added, in order to make up *white light*. See p. 360.

Q. *Why does the eye perceive the ACCIDENTAL COLOR when the fundamental one is removed?*

A. Because the nerve of the eye has become tired of the one, but still remains fresh for the perception of the *other*.

Q. *If we wear BLUE GLASSES, why does every thing appear tinged with ORANGE when we take them off?*

A. Because *orange* is the "*accidental color*" of blue; and if we look through *blue glasses*, we shall see its "*accidental color*" when we lay our glasses aside.

Q. *If we look at the SUN for a few moments, every thing seems tinged with a VIOLET color—WHY is this?*

A. Because *violet* is the "*accidental color*" of *yellow*; and as the sun is *yellow*, we shall see its "*accidental color*" *violet* when we turn from gazing at it.

Q. Does not the DARK SHADOW (which seems to hang over every thing after we turn from looking at the sun) arise from our eyes being DAZZLED ?

A. Partly so : the pupil of the eye is very much contracted by the brilliant light of the sun, and does not adjust itself immediately to the feebler light of terrestrial objects ; but, independent of this, the " ACCIDENTAL COLOR " of the sun being *dark violet*, would tend to throw a shadow upon all things. (See p. 340.)

Q. Why is BLACK glass for spectacles the BEST for wear in this respect ?

A. Because *white* is the accidental color of *black* ; and if we wear *black glasses*, every thing will appear in *white light* when we take them off.

Q. Why does every thing seem shadowed with a BLACK MIST when we take off our common SPECTACLES ?

A. Because the glasses are *white* ; and black being its " accidental color," every thing appears in a *black shade* when we lay our glasses down.

The accidental color of red	is bluish green.
" " " of orange	" blue.
" " " of violet	" yellow.
" " " of black	" white.

And the converse of this is true :—

The accidental color of bluish green	is red.
" " " of blue	" orange.
" " " of yellow	" violet.
" " " of white	" black.

(The law of an accidental color is this—The accidental color is always half the spectrum. Thus, if we take half the length of the spectrum by a pair of compasses, and fix one leg in any color, the other leg will hit upon its accidental color.)

N. B. The spectrum means the seven colors (red, orange, yellow, green, blue, indigo, and violet), divided into seven *equal* bands, and placed side by side in the order just mentioned.

---

## SOUND.

### CHAPTER XXX.

Q. *How is SOUND produced?*

A. The vibration of some sonorous substance produces motion in the air, called SOUND-WAVES, which strike upon the *drum of the ear* and give the sensation of sound.

Q. *What are MUSICAL SOUNDS?*

A. Regular and uniform successions of vibrations.

Q. *How FAST does SOUND TRAVEL?*

A. About 13 miles in a minute, or 1142 feet in a second of time.

Light would go 480 times round the whole earth, while sound is going its 13 miles.

Q. *Why are SOME things SONOROUS and others NOT?*

A. The sonorous quality of any substance depends upon its *hardness and elasticity*.

Q. *Why are COPPER and IRON SONOROUS and not LEAD?*

A. Copper and iron are *hard and elastic*; but as lead is neither hard nor yet elastic, it is *not sonorous*.

Q. *Of what is BELL-METAL made?*

A. Of *copper and tin* in the following proportions:—In every 5 pounds of bell-metal there should be 1 pound of tin, and 4 pounds of copper.

Q. *Why is this mixture of tin and copper used for BELL-METAL?*

A. Because it is much *harder* and more *elastic* than any of the pure metals.

Q. *Why is the SOUND of a bell STOPPED by TOUCHING the bell with our finger?*

A. Because the weight of our finger *stops the vibrations* of the bell; and as soon as the bell *ceases to vibrate*, it ceases to make sound-waves in the air.

Q. *Why does a SPLIT BELL make a hoarse, disagreeable sound?*

A. Because the *split* of the bell causes a *double vibration*: And as the sound-waves *clash and jar*, they impede each other's motion, and produce discordant sounds.

Q. *Why does a FIDDLE-STRING give a musical sound?*

A. Because the bow drawn across the string *causes it to vibrate*; and this

vibration of the string *sets in motion the sound-waves of the air*, and produces musical notes.

Q. *Why does a DRUM sound?*

A. Because the parchment head of the drum *vibrates* from the blow of the drum-stick, and sets in motion the sound-waves of the air.

Q. *Why do MUSICAL GLASSES give sounds?*

A. Because the glasses *vibrate* as soon as they are struck, and set in motion the sound-waves of the air.

Q. *Why do FLUTES, &c., produce musical sounds?*

A. Because the breath of the performer causes the *air in the flute to vibrate*; and this vibration sets in motion the sound-waves of the air.

Q. *Why do PIANO-FORTES produce musical sounds?*

A. Because each *key of the piano* (being struck with the finger) lifts up a little hammer which *knocks against a string*; and the vibration thus produced sets in motion the sound-waves of the air.

Q. *Why are SOME notes BASS, and some TREBLE?*

A. Because *slow vibrations produce bass or deep sounds*; but *quick vibrations produce shrill or treble ones*.

Q. *Why is an instrument FLAT when the STRINGS are UNSTRUNG?*

A. Because the vibrations are *too slow*; in consequence of which, the sounds produced are not *shrill* or *sharp* enough.

Q. *Why can persons, living a mile or two from a town, HEAR the BELLS of the town churches SOME-TIMES and not at OTHERS?*

A. Because fogs, rain, and snow, obstruct the passage of sound; but when the air is *cold and clear*, sound is propagated more easily.

Q. *WHY can we NOT hear sounds (as those of distant church bells) in RAINY weather so well as in FINE weather?*

A. Because the falling rain *interferes with the undulations of the sound-waves*, and breaks them up.

Q. *Why can we not hear sounds (as those of distant church bells) in SNOWY weather so well as in FINE weather?*

A. Because the falling snow *interferes with the undulations of the sound-waves*, and stops their progress.

Q. *Why can we HEAR distant clocks MOST distinctly in CLEAR COLD weather?*

A. Because the air is of more *uniform density*, and there are fewer *currents of air* of unequal temperature to interrupt the sound-waves.



Besides, dense air can propagate sound-waves more readily than rarer air.

Q. *Why can persons (near the POLES) hear the VOICES of men in conversation for a MILE distant in winter-time?*

A. Because the air is very *cold, clear, and still*; in consequence of which, there are but few *currents of air* of unequal temperature to interrupt the sound-waves.

Captain Ross heard the voices of his men in conversation a mile and a half from the spot where they stood.

Q. *Why are not SOUNDS (such as those of distant church bells) heard so distinctly on a HOT DAY as in FROSTY weather?*

A. 1st—Because the density of the air is *less uniform* in very hot weather:

2dly—It is *more rarefied*; and, consequently, a worse conductor of sound: and

3dly—It is more liable to *accidental currents*, which impede the progress of sound.

Q. *Why can we not hear SOUNDS (such as those of distant clocks) so distinctly in a thick MIST or HAZE as in a CLEAR night?*

A. Because the air is not of uniform density when it is laden with mist; in consequence of which, the sound-waves are obstructed in their progress.

Q. *Why do we hear SOUNDS better by NIGHT than by DAY?*

A. 1st—Because night air is of *more*

*uniform density* and less liable to *accidental currents* : and

2dly—Night is more *still* from the suspension of business and hum of men.

Q. *Why is the air of more UNIFORM DENSITY by NIGHT than it is by day?*

A. Because it is less liable to accidental currents ; inasmuch as the breezes (created by the action of the sun's rays) generally *cease* during the night.

Q. *How should PARTITION WALLS be made, to PREVENT the voices in adjoining rooms from being HEARD?*

A. The space between the laths should be filled with *shavings* or *saw-dust* ; and then no sound would ever pass from one room to another.

Q. *Why would SHAVINGS, or saw-dust, PREVENT the transmission of sound from room to room?*

A. Because there would be *several different media* for the sound to pass through : 1st—the air ; 2dly—the laths and paper ; 3dly—the saw-dust or shavings ; 4thly—lath and paper again ; 5thly—the air again : And every change of medium diminishes the *strength of the sound-waves*.

Q. *Why can DEAF people hear through an EAR-TRUMPET?*

A. Because the ear-trumpet restrains

*the spread of the voice* and limits the *diameter of the sound-waves*: in consequence of which, their *strength* is increased.

Q. *Why are MOUNTAINS NOISELESS and quiet?*

A. Because the air of mountains is *very rarefied*; and, as the air becomes *rarefied*, sound becomes less *intense*.

Q. *How do you know that the RARITY of air DIMINISHES the intensity of SOUND?*

A. If a bell be rung in the receiver of an air-pump, the sound becomes *fainter and fainter* as the air is exhausted; till at last it is almost *inaudible*.

Q. *What is the cause of ECHO?*

A. Whenever a sound-wave strikes against any *obstacle* (such as a wall or hill), *it is reflected* (or thrown back); and this *reflected sound* is called an ECHO.

The same laws govern echo as light. (See p. 338.)

Q. *What places are most famous for ECHO?*

A. Caverns, grottoes, and ruined abbeys; the areas of halls; the windings of long passages; the aisles of cathedral churches; mountains and icebergs.

Q. *Why are caverns, grottoes, and ruins, FAMOUS for ECHOES?*

A. 1st—Because the sound-waves cannot pass *beyond* the cavern or grotto, and, therefore, *must flow back*: and

2dly—The *return-waves* (being entan-

gled by the cavern) are *detained* for a short time, and come *deliberately* to the ear.

Q. *Why are halls, winding passages, and cathedral aisles, FAMOUS for ECHOES?*

A. Because the sound-waves *cannot flow freely forward*; but perpetually strike against the winding walls, and are beaten *back*.

Q. *Why are MOUNTAINS and icebergs FAMOUS for ECHOES?*

A. Because they present a *barrier* to the sound-waves, *which they cannot pass*, and are sufficiently elastic to *throw them back*.

Q. *Why do not the WALLS of a ROOM or church produce ECHO?*

A. Because sound travels with such *velocity* that the echo is *blended with the original sound*; and the two produce but *one impression* on the ear.

Sound travels 13 miles in a minute; and no echo is heard, unless the surface (against which the sound strikes) is 65 feet from the place whence the sound originally proceeded.

Q. *Why do very LARGE buildings (as cathedrals) often REVERBERATE the voice of the speaker?*

A. Because the walls are so *far off from the speaker* that the echo does not *get back in time* to blend with the origi-

nal sound ; and, therefore, *each* is heard separately.

Q. *Why do SOME echoes repeat only ONE syllable?*

A. Because the echoing body is very *near*. The *further* the echoing body is off, the *more sound* it will *reflect*: If, therefore, it be very *near*, it will repeat but one syllable.

Q. *Why does an ECHO sometimes repeat TWO or more syllables?*

A. Because the echoing body is *far off*; and, therefore, there is time for one reflection *to pass away* before *another* reaches the ear.

N. B. All the syllables must be *uttered*, before the echo of the first syllable reaches the ear—If, therefore, a person repeats 7 syllables in 2 seconds of time, and hears them *all* echoed, the reflecting object is 1142 feet distant; (because sound travels 1142 feet in a second, and the words take one second to *go to* the reflecting object, and one second to *return*.)

Q. *Why are TWO or more ECHOES sometimes heard?*

A. Because separate reverberating surfaces receive the sound and reflect it in succession.

17 miles above Glasgow (Scotland) near a mansion called Rosneath, is a very remarkable echo. If a trumpeter plays a tune and stops, the echo will begin the same tune and repeat it all accurately:—as soon as this echo has ceased, *another* will echo the same tune in a lower tone; and after the second echo has ceased, a *third* will succeed with equal fidelity, though in a much feebler tone.

At the Lake of Kilkarney in IRELAND, there is an echo which plays an excellent "*second*" to any simple tune played on a bugle.

Q. *Why do WINDOWS RATTLE when CARTS pass by a house?*

A. 1st—Because glass is *sonorous*; and the air communicates its vibrations to the glass, which echoes the same sound: and

2dly The *window-frame* being *shaken*, contributes to the noise.

Window frames are shaken, 1.—By sound-waves impinging against them; 2.—By a vibratory motion communicated to them by **the walls** of the house.

## PART III.

---

### MISCELLANEOUS.

---

\*\*\* This part is little else than a collection of various questions propounded by different correspondents, pupils, and private friends, set down, without regard to arrangement, in the order in which they were proposed ; together with a few leading questions to break up some which would have been otherwise too intricate, and others which naturally arose out of the subject under consideration.

Q. *Why do the BUBBLES in a CUP of TEA range round the SIDES of the CUP ?*

A. Because the cup *attracts them.*

Q. *Why do all the LITTLE BUBBLES tend towards the LARGE ones ?*

A. Because the large bubbles (being the superior masses) *attract them.*

Q. *Why do the BUBBLES of a CUP OF TEA FOLLOW a TEA-SPOON ?*

A. Because the tea-spoon *attracts them.*

Q. *Why are the SIDES of a pond covered with LEAVES, while the MIDDLE of the pond is quite CLEAR ?*

A. Because the shore *attracts* the leaves to itself.

Q. *Why do all fruits, &c., (when severed from the tree,) FALL to the EARTH?*

A. Because the earth *attracts* them.

Q. *Why do persons who water PLANTS very often pour the water into the SAUCER, and not over the PLANTS?*

A. Because the water in the saucer is *drawn up* by the mould (through the hole at the bottom of the flower-pot) and is transferred to the stem and leaves of the plant by CAPILLARY ATTRACTION. (See p. 75.)

Q. *Why is vegetation on the MARGIN of a RIVER more LUXURIANT than in an open FIELD?*

A. Because the porous earth on the bank *draws up water* to the roots of the plants by CAPILLARY ATTRACTION.

Q. *Why is a LUMP of SUGAR (left at the bottom of a cup) so LONG in MELTING?*

A. Because (as it melts) it makes the tea above it *heavier*; and (so long as it remains at the bottom) is surrounded by tea fully *saturated* with sugar; in consequence of which, the *same* portions of liquid will hold *no more sugar in solution*.

Q. *Why does the LUMP of SUGAR MELT more QUICKLY when STIRRED ABOUT?*

A. Because *fresh portions of unsatu-*



*rated tea* come in contact with the lump, and soon dissolve it.

Q. *Why does a* PIECE OF SUGAR *(held in a spoon at the TOP of our tea) melt very RAPIDLY?*

A. Because, as the tea becomes *sweetened*, it *descends to the bottom of the cup* by its own gravity; and *fresh* portions of unsweetened tea are brought constantly into contact with the sugar till the lump is entirely dissolved.

Q. *How can a* SICK ROOM *be kept FREE from unhealthy* EFFLUVIA?

A. By sprinkling it with vinegar boiled with myrrh or camphor.

Q. *Why does* LIME *destroy the offensive smells of* BINS, SEWERS, &c. ?

A. Because it decomposes the offensive gases upon which the smell depends, and destroys them.

Q. *Why does* CHLORIDE of LIME *fumigate a sick room?*

A. Because the chlorine absorbs the *hydrogen of the stale air*; and by this means removes both the *offensive smell* and the *infection* of a sick room.

Q. *How can the* TAIN *t of* MEAT *be removed?*

A. Either by washing with PYROLIGNEOUS ACID—or by covering it for a few hours with common CHARCOAL—or by

putting a *few lumps of charcoal* into the *water in which it is boiled.*

Q. *Why do these things DESTROY the TAIN*T OF *meat?*

A. Because they *combine* with the *putrescent particles*, and neutralize their offensive taste and smell.

Q. *Why should BED-ROOMS, COTTAGES, HOSPITALS, and STABLES, be washed occasionally with LIME WHITE?*

A. Because the lime *is very caustic*, and removes all organic matters adhering to the walls.

Q. *Why will strong SOUCHONG TEA POISON FLIES?*

A. Because it contains *prussic acid*, which destroys their *nervous system.*

Q. *Why is strong GREEN TEA UNWHOLESOME?*

A. Because it contains *prussic acid*, which destroys the *nervous system.*

Q. *Why is a DEAD man TALLER than a living one?*

A. Because at death the CARTILAGES are *relaxed.* So, also, after a night's rest, a man is *taller* than when he went to bed.

Q. *What is SLEEP?*

A. Sleep is the *rest of the brain and nervous system.*

Q. *Why can we not SEE, when we are asleep with our EYES OPEN?*

A. Because the "RETINA of the eye" is *inactive* and at rest.

Q. *Why can we not HEAR in sleep?*

A. Because the nerve of hearing (seated within the TYMPANUM of the ear) is at rest.

Q. *Why can we not TASTE when we are asleep?*

A. Because the nerves *at the end of the tongue* (called papillæ) are inactive and at rest.

Q. *Why can we not FEEL when we are asleep?*

A. Because the *ends of the nerves* (called papillæ) situated in the skin, are inactive and at rest.

Q. *Why have persons in sleep no WILL of their own, but may be moved at the will of ANY one?*

A. Because the "CEREBELLUM" (or *posterior* part of the brain) is inactive and at rest.

Q. *Why have DREAMERS no power of JUDGMENT or REASON?*

A. Because the "CEREBRUM" (or *front* of the brain) is inactive and at rest.

Q. *Why do some persons LOSE all POWER of SENSATION?*

A. Because the "CEREBRUM" (or *front* of their brain) *has been injured*.

Q. *Why does a person FEEL when he is TOUCHED?*

A. Because the ends of certain

nerves (called "PAPILLÆ") situated in the skin, are *excited*; and produce a nervous sensation called FEELING.

Q. *Why are persons able to TASTE DIFFERENT FLAVORS?*

A. Because the "PAPILLÆ" of the tongue and palate are *excited* when food touches them, and produce a nervous sensation called TASTE.

Q. *Why are OLD people UNABLE to WALK?*

A. Because their *muscles become rigid*.

Q. *Why does ABUNDANCE of DEW in the morning indicate, that the day will be FINE?* p. 189.

A. Because dew is never deposited in *dull, cloudy* weather, but only in very *clear, calm* nights; when the cold currents of air are not mixed with those of a warmer temperature.

Q. *Why does an OAR in water appear bent?* p. 358.

A. Because the part *out* of the water is seen in a different medium to the part *in* the water; and the rays of these two parts, meeting together at the surface of the river, *form an angle* -or, in other words, make the oar look as if it were bent.

As all the rays of light are refracted (or bent) more in their passage through *water* than in their passage through

air, they will tend to cross each other at the surface of the water, and, of course, form an elbow or angle.

Q. If a piece of BROWN PAPER be submitted to the action of a BURNING GLASS, it will catch fire much SOONER than a piece of white paper would; Explain the reason. p. 175.

A. Because *white* paper reflects the rays of the sun, or throws them back; in consequence of which, it appears more luminous, but is not so much heated, as dark *brown* paper, which *absorbs* the rays and readily becomes heated to ignition.

Besides, brown paper is of a looser and more combustible fabric than white paper.

Q. Why does a lady's BLUE DRESS appear GREEN by CANDLE LIGHT? pp. 76, 364.

A. Because the light of a candle is tinged with *yellow*; and this *yellow* tinge, mixing with the *blue* dye of the dress, produces *green*.

Q. Why does the SUN look red in a FOG? p. 127.

A. Because *red* rays have a greater momentum than any other rays; and this superior momentum enables them to penetrate the dense atmosphere more readily than either blue or yellow rays, which are either *absorbed* or *reflected* by the fog.

“Momentum” means, the impetus or *power of penetrating the fog*.

Q. *Why is an INK-SPOT on linen BLACK when first made?*

A. Because the ink produces a chemical change in the internal condition of the fibres of the linen, by which it loses its power of *reflecting* light; and, as it *absorbs* the rays of the sun, the spot seems *black*.

The *black* color of ink is composed of a compound of Tannic acid, sesqui-oxide of iron, and water.

“Tannic acid” is an acid which exists in oak trees, especially in the bark, but is abundant in nutgalls. It derives its name from its property of combining with the skins of animals and converting them into leather, which is called *tanning* them.

“Sesqui-oxide of iron” means, that *one atom and a half* of oxygen is mixed with one atom of iron.—The amount of oxygen in an oxide is always expressed by some similar affix, thus

Protoxide—1 atom of oxygen	} and one of the substance oxidized called the <i>base</i> .
Binoxide—2 atoms of oxygen	
Teroxide—3 atoms of oxygen	
&c.	

Per-oxide—the highest possible degree of oxidation, &c.

Sesqui-oxide— $1\frac{1}{2}$  atom of oxygen and 1 of base.

Q. *Why does the black ink-spot on linen turn YELLOW after a few days?*

A. Because the compound, which composes the blackness of ink, is destroyed by exposure to air; and the linen partially recovers its power of reflecting colors, but with a preference to *yellow* rays.

The tannic acid and water are in a measure taken up by the air, and the oxide of iron leaves a yellow iron mould behind.

Q. *Why does BRUSHING the HAIR much make the head itch?* p. 142.

A. 1st—Because the friction of the hair-brush excites *electricity* in the hair, which thus becomes overcharged and irritates the skin: and

2dly—The hair-brush excites increased action in the vessels and nerves of the scalp, producing a slight degree of inflammation, which is indicated by a sensation of itching.

Q. *Why does a CANDLE FLICKER, especially just previous to its being BURNT OUT?* pp. 76, 80.

A. Because it is *unequally* supplied with combustible gases.—When a candle is nearly burnt out, there is not sufficient tallow or wax to keep up the regular supply of combustible gas; in consequence of which, the flame flickers, i. e. *blazes*, when it is supplied with gas, and *goes out* for a moment, when the supply is defective.

Q. *If the "COPPER" (or boiler) attached to a kitchen range, be filled with cold water AFTER the fire has been some time lighted, it will very often CRACK (or burst). Why is this?* p. 118.

A. Because the heat of the fire has caused the "copper" to *expand*; but the cold water very suddenly *condenses* again those parts with which it comes in

contact : and, as one part is *larger* than the other, the copper cracks or bursts.

Q. *What is color ?*

A. An inherent property in *light*.—The reason why different things appear of different colors, is owing to their power of *reflecting* some rays and *absorbing* others.

N. B. It must not be forgotten, that color is not an inherent property of the *flower, carpet, rainbow, &c.*, but an inherent property of the *light*, which falls upon them.

The reason why one thing reflects one ray, and another thing reflects another ray, is owing to the different thickness of the corpuscles which compose them—the acid or alkaline properties of their juices or dyes—the uniformity and texture of their parts—and so on; in consequence of which, some ray or rays are reflected in preference to others.

Q. *Why, do all things appear BLACK in the DARK ?* p. 371.

A. Because there is no *light*; and as color is the inherent property of *light*, therefore, in the dark all things are *without* color.

Of course, in certain degrees of darkness, objects are actually *invisible*. The question refers to that peculiar degree of darkness, when the *forms* of objects may be seen, but not their *hues*.

Q. *Why are the FLAG-STONES of our streets frequently LOOSENED after a FROST ?* p. 326.

A. Because the moisture beneath them, *expanded* during the frost and raised the flag-stones from their beds; but afterwards, the moisture thawed and



condensed again, leaving the flag-stones loose.

Q. *Why is a ROOM WARMER, when the window CURTAINS are DRAWN?* p. 165.

A. Because air is a bad conductor; and the air, confined between the curtains and the window, opposes both the escape of *warm* air out of the room, and of *cold* air into the room.

Q. *Why are rooms much WARMER, for being furnished with DOUBLE DOORS and WINDOWS?* p. 165.

A. Because air is a *bad conductor*; and the air confined between the double doors and windows, opposes both the escape of *warm* air out of the room and of *cold* air into the room.

Q. *Why is LOOSE clothing WARMER than that which fits closely?* p. 165.

A. Because air is a bad conductor; and the quantity of air, confined between our body and clothing, prevents; 1st—the heat of our body from escaping; and 2dly—The external air from coming into contact with our body.

Q. *Why does WETTING a CORNELIAN make it more TRANSPARENT?* p. 373.

A. Because the pores of the cornelian are then filled with *water*; and as the density of the mass is rendered some-

what more uniform than when those pores were filled with air, the stone becomes more transparent.

The water on the surface of the stone acts also as a varnish, to make the external coating more lustrous.

N. B. Transparency depends on the uniformity of parts. If the parts of any substance are not pretty uniform, the rays of light are refracted and absorbed so frequently, that no part of them can emerge on the opposite side.

Q. *Why does IRON rust?*

A. Because water is decomposed, when it comes in contact with the surface of iron; and the oxygen of the water combining with iron produces an oxide, which is generally called rust.

N. B. Water is a compound of Oxygen and Hydrogen, in the following proportions: 8 lbs. of oxygen, and 1 lb. of hydrogen = 9 lbs. of water.

Q. *Why does PAINTING iron prevent it from RUSTING?* p. 232.

A. Because paint prevents the moist air from coming in contact with the iron.

Q. *Why is a dull FIRE REVIVED by sweeping clean the hobs, bars, ash-grate, &c. of the stove?* pp. 52, 53.

A. Because the air, which was arrested by the loose dust and coals, finds its way *freely* to the fire, so soon as these obstacles are swept away.

N. B. The brightness of a fire depends on its supply of oxygen, derived from the air.

Q. *Why does STIRRING a dull FIRE serve to quicken it?* pp. 52, 53.

A. Because it breaks up the clotted

cinders and coals, making a passage for the air into the very heart of the fire.

A fire should be stirred from the bottom, and not from the top.

Q. *Why does SOAPY WATER "lather?"* p. 324.

A. Because soap makes the water *tenacious*, and prevents its bubbles from bursting; "Lather" is only an accumulation of bubbles.

Q. *Why is well-made BREAD full of holes or eyes?* p. 257.

A. Because the fermentation of the dough throws up little bubbles filled with carbonic acid gas; and when the dough is baked, these bubbles are made *permanent* in the bread.

Q. *Why do the SAILS of a WIND-MILL turn round?* p. 108.

A. Because the wind, blowing against the oblique surface of the sails, pushes them out of the way, driving them from place to place in a restless round.

Q. *After striking a finger-glass, why is the SOUND SILENCED, upon touching the glass with your finger?* p. 378.

A. Because the pressure of your finger stops the *vibrations* of the finger-glass; and, so soon as the finger-glass *ceases to vibrate*, it ceases to make sound-waves in the air.

Q. *Why does a WET SPONGE CLEAN a SLATE ?*  
p. 321.

A. Because the water of the wet sponge *dissolves* the pencil marks made upon the slate.

Something is due to the mechanical action of the mere friction.

Q. *Why do STARS TWINKLE more than usual, just previous to RAIN ?* p. 374.

A. 1st—Because the air is unequally filled with vapor, which offers constant obstructions to the passage of the rays: and

2dly—Because clouds and other opaque vapors passing through the air, veil for a little time the light of the stars, which again becomes apparent after the clouds have passed:—This constant *shutting* off the light for very brief intervals, produces what is called *twinkling*.

The answers are not altogether satisfactory: probably diffraction and the interference of different rays with each other, will be found, at some future time, to explain the phenomenon better.

Q. *Why does MILK BOIL OVER more readily than water ?* p. 324.

A. Because the bubbles of milk, produced by the process of boiling, are more tenacious than the bubbles of water; and these bubbles, accumulating and climb-

ing one above another, soon overtop the rim of the saucepan and run over.

Q. *If a PICTURE be GLAZED, you cannot see the "print" in certain positions; why not? p. 352.*

A. 1st—Because glass is a reflector; and, whenever the strong light of the sun is reflected from the glass to the eye of the spectator, the glass becomes intensely luminous, and the picture remains in comparative darkness: and

2dly—When the spectator is so placed, as to catch the rays of light reflected from the glass, his eye is *dazzled* with the strong light, and cannot see the more faintly illuminated picture behind it.

Q. *DUST very RARELY flies by NIGHT: why is this? p. 188.*

A. 1st—Because the dews of night moisten the dust, and prevent its rising into the air: and

2dly—As the surface of the earth is *colder* than the air after sunset, the current of the wind will incline *downward*; and tend rather to press the dust down than to buoy it up.

Q. *When the cork of a SODA-WATER bottle is drawn, why is a loud REPORT made? p. 102*

A. Because soda-water contains eight

tunes its own bulk of carbonic acid gas ; which, being suddenly liberated, strikes against the air, and produces a report.

In the same way, as when we strike our hand upon **the** table.

Q. *Why does the CORK of a SODA-WATER bottle FLY OFF, the instant it has been released from the bond which held it in ? p. 102.*

A. Because the vast quantity of carbonic acid gas forced into the soda-water can no longer be confined ; and seeking to escape, drives out the cork with great violence.

Q. *Why do our HANDS and LIPS CHAP in frosty and windy weather ? p. 295.*

A. 1st—Because the wind or frost absorbs the moisture from the surface of the skin : and

2dly—The action of wind or frost produces a kind of inflammation on the skin.

Cold acts very readily upon the skin, exciting a kind of erysipelas, of a *red* color ; if the cold is continued, the skin becomes pale and languid, and the patient suffers from chaps, chilblains, &c. The question, however, is one belonging to the physician, rather than the natural philosopher.

Q. *When a BLACK SUBSOIL is dug or ploughed up, it turns of a reddish BROWN color after a short time ; why is this ? p. 233.*

A. Because the soil contained a certain compound of iron, called the “*pro-*

*toxide*," which is black: This protoxide of iron, absorbing more oxygen from the moist air, is converted into another compound, called the "per-oxide of iron," which is of a reddish rusty color.

There are two oxides of iron, the one containing more oxygen than the other. The protoxide, which contains the least oxygen, is *black*; the peroxide, which contains the most oxygen, is *red*. p. 394.

Q. *Why are DECAYING VEGETABLES always WET?* p. 253.

A. Because the *hydrogen* and *oxygen* of the vegetables are given up by decay, and form into *water*.

Water is composed of the two gases oxygen and hydrogen in the following proportions: 8 lbs. of oxygen and 1 lb. of hydrogen = 9 lbs. of water.

N. B. Decaying vegetables combine into the following new forms: 1st, The oxygen and hydrogen form into water: and 2dly, The carbon unites with the oxygen of the air, and produces carbonic acid gas.

Q. *If a house be faced with STUCCO to resemble stone, why does the facing very often FLAKE OFF in winter, and leave the house unsightly?* p. 333.

A. Because the stucco was not quite dry; therefore, its moisture freezing and expanding, thrusts the stucco away from the wall; and when the thaw sets in, the stucco being unsupported, will fall by its own weight.

Q. *Why do the LUSTRES of a CHANDELIER seem tinted with VARIOUS brilliant colors?* p. 364.

A. Because each "drop" of the chan-

delier is so cut, as to act like a prism : It decomposes the light, and reflects the different rays thereof from its different points or angles.

Q. HORN is TRANSPARENT, *why are NOT horn SHAVINGS transparent also?* p. 373.

A. Because the surface of the shaving has been torn and rendered rough ; and the rays of light are too much reflected and refracted by the rough surface to be transmitted through the shaving, so as to produce transparency.

Q. *When a glazier is mending a window, and cleans the pane with his brush, why do the loose pieces of putty (on the OPPOSITE side of the window-pane) DANCE up and down?* p. 142.

A. When glass is rubbed, electricity is excited in the parts submitted to the friction, and on the part *opposite* also ; the electricity attracts light substances, such as loose fragments of putty : As soon as these fragments have touched the excited part of the glass they become charged, and fall back again ; the ledge on which they fall deprives them of their burden, and they then fly up again to receive a fresh charge : This process being repeated often, makes the commotion in the loose fragments of putty, referred to in the question.



A very pretty experiment of a similar kind may be made thus: Take a common window glass, wipe it quite dry and warm, and support it on two wine glasses like the slab of a table: Place *underneath* the window glass, at the distance of about two inches, some bran, sand, small pieces of paper, Dutch gold, pith, &c.: If you now rub the *upper* surface of the window glass with a silk rubber, the light substances beneath will dance up and down.

N. B. The rubber may be made thus: Take a common cork cut evenly and flat, cover it with a piece of silk, and run a skewer into the upper surface for a handle. A little amalgam applied to the rubber will greatly improve the experiment.

Q. *When you rub a piece of paper with INDIAN RUBBER, why is the paper sticky?* p. 34.

A. Because the friction of the Indian rubber against the surface of the paper develops electricity, to which this stickiness is mainly to be attributed.

Q. *If you dry a piece of common BROWN PAPER by the fire and draw it once or twice between your two KNEES, why will it STICK fast to the wall?* p. 34.

A. Because the friction develops electricity on the paper, which manifests itself by this property of adhesion.

Q. *Why can noises be HEARD (in a calm day) at a GREATER DISTANCE on the sea than on land?* p. 381.

A. 1st—Because the air over the sea is generally denser and more laden with moisture, than the air over the land is: p. 139.

2dly—The density is more *uniform*: p. 380, and

3dly—Water being more *elastic* than and, is a better propagator of sound.

Q. *The height of MOUNTAINS may be ascertained by a BAROMETER : Explain the reason of this ?* p. 383.

A. As we ascend a high mountain, the quantity of air above us becomes less and less every step we ascend, and requires less mercury to balance it; in consequence of which the mercury in the tube of the barometer *falls*.

If a pile of books be placed on a table, the bottom book will sustain the *most* weight, and every book will sustain less and less, as we get nearer and nearer to the top: The air somewhat resembles this pile. That on the surface of the earth resembles the *bottom* book of the pile; and, as we ascend a mountain, the quantity of air above keeps diminishing, and the weight to be sustained is in proportion less.

For general practical purposes we may take this for a rule: for every 100 feet of perpendicular height, the barometer will fall  $\frac{1}{10}$  of an inch. If, therefore, the barometer has fallen  $1\frac{1}{2}$  inch, you know the mountain is 1500 feet high.

Q. *How does STARCH assist in giving a smooth GLAZED SURFACE to LINEN ?* p. 373.

A. It fills up the interstices between the threads; and makes the fabric of more uniform density.

“Interstices between the threads.”—Put your fingers close, and lay your open hand on the table—a little *groove* may be seen, where the fingers divide; these grooves may be called *interstices*; and, when we speak of the “interstices of linen,” we mean the groove or space between thread and thread.

Q. *If a DROP of WATER be spilt on a table-cloth, why will it SPREAD in all directions ?* p. 75.

A. Because the threads of the cloth absorb the water by capillary attraction.

Q. *Why does SALT PRESERVE meat?*

A. Because it removes the *water* contained in the animal fibre; absorbing it, and leaving the meat dry.

The reason stated above is not the *sole* reason, though it is certainly the chief one. The following have some influence also:

2. Salt is composed of chlorine and sodium; the chlorine of the salt takes up the hydrogen of the meat as it is given off, and prevents the offensive taste and smell of decay:

3. Brine draws away the *albumen* from between the muscular fibres, which is very subject to putrefaction.

4. The salt *unites* with the muscular fibre, and makes a new chemical compound, much less subject to decay: and

5. It keeps the *air* from the meat, the flies, &c.

Q. *Is SALTED meat equally nutritious as fresh meat?*

A. No: Because the *albumen* of the meat is separated from the flesh by the brine; as well as the alkaline phosphates and some other substances of great value.

“Phosphates” pronounce fos'-fates.—Phosphates are alkaline, and mineral.—ALKALINE PHOSPHATES are *phosphoric acid* combined with some *alkali*, such as soda, potash, magnesia, &c.

“Albumen of the meat”—a substance like the *white of an egg*, which lies between the muscular fibres of all flesh, and makes the meat *tender*.

“The alkaline phosphates of meat” are such as these: the phosphate of soda, the phosphate of potash, and the phosphate of magnesia, which are extracted from the *meat* by the *acid* re-action of the brine.

Q. *Why is the FLESH of OLD animals very TOUGH?*

A. Because it contains very little *albu'men*, and much muscular fibre.

Q. *Why is MEAT always TOUGH, if it be put into the boiler before the water boils?*

A. Because the water is not hot enough to coagulate the albumen between the muscular fibres of the meat, which therefore runs into the water, and rises to the surface as a scum.

Q. *Why is MEAT TOUGH, which has been BOILED TOO LONG?*

A. Because the *albu'men* becomes hard, like the white of a hard boiled egg.

The best way of boiling meat to make it tender is this. Put your joint in very brisk boiling water; after a few minutes, add a little cold water. The boiling water will fix the *albu'men*, which will prevent the water from soaking into the meat—keep all the juices in—and prevent the muscular fibre from contracting. The addition of cold water will secure the cooking of the *inside* of the joint, as well as of the surface.

Q. *Why should VEGETABLES be ALWAYS eaten with salted meat?*

A. Because they are all rich in POT-ASH, which the brine has deprived the meat of.

Q. *Why are LAMB and VEAL more TENDER than beef and mutton?*

A. Because they contain more albu'men, and less muscular fibre.

Albu'men is a substance like the white of an egg.

Q. *Why do LAMB and VEAL TAIN'T more quickly than beef and mutton?*

A. Because they contain a large quantity of albu'men, which is very liable to undergo putrefaction.

Q. *Why are small birds, such as quails, larks, partridges, &c., covered with lard, when they are roasted?*

A. To make them tender and savory. The covering of lard prevents the savory constituents of the bird from evaporating with the water: in consequence of which, the flesh is more tender and sapid.

“Sapid” i. e. full of flavor.

Q. *Why does melted WAX become HARD, when cold? p. 109.*

A. Because the particles collapse; and, being packed more closely together, form a solid.

The sole difference between a liquid and a solid is this—In a SOLID the particles are packed more closely together, than they are in a *liquid*. The tendency of heat is, to drive the particles further apart from each other, and thus to liquify solids.

Q. *Why does PAINT often BLISTER from heat?*

A. Because the heat, penetrating through the paint, extracts some little moisture from the wood, and turns it in-

to vapor or steam. As this vapor requires room, it throws up blisters in the paint, to make room for its expanded bulk.

Q. *Why are* ROTTING LEAVES HOT? pp. 60, 253.

A. Because the fermentation of rotting leaves produces *carbonic acid gas*, which production is always attended with heat. In fact *rotting* is a species of *slow combustion*.

N. B.—The carbon of the leaves unites with the oxygen of the air, to produce carbonic acid gas. p. 259.

The new combinations disturb *latent heat*, and make it sensible.

Q. *Why are* ROTTING LEAVES DAMP? p. 253.  
Answered before, see page 403.

Q. *Why does* BREAD *become* HARD, *after it has been* KEPT *a few days*? p. 153.

A. Because the vapor and gases escape, leaving the solid particles dry; so that they collapse, and become more solid and hard.

Q. *Why is* NEW BREAD INDIGESTIBLE?

A. Because the change called “panary fermentation,” is not completed.

“Panary” from the Latin word *Panis* (bread); “panary fermentation” means, the fermentation that dough undergoes in order to become bread.

The *sugar* of the dough is converted into alcohol and carbonic acid by fermentation; the dough being adhesive, prevents the escape of these products, till the mass is

*baked*; when the gas expands, bursts through the mass, leaving a number of holes or bladders, to show where it was confined.

So long as the bread is warm, the process of fermentation is going on; and, therefore, bread should never be eaten, till it is 24 hours old.

Q. *Why are PLANTS WHITE, which are kept in the DARK?* p. 372.

A. Because chlo'rophyll can be formed only by the agency of the sun's rays; and it is this peculiar chemical principle, which gives the green tinge to healthy leaves and plants.

Chlo'rophyll is the green coloring matter of leaves.

Q. *Why does OIL become THICK in WINTER-TIME?* p. 268.

1st—Because it is condensed by the cold, and rendered more solid: and

2dly—Because the "ste'arine," which is held in solution in warm weather, is separated by the action of the cold; and deposited as a thick white almost-solid matter.

"Stearine" (from the Greek word *στεαρ*, *suet*) is the *solid* or *hard* ingredient of all fat, suet, oil, &c. The *soft* or *liquid* part is called oleine from the Latin word *oleum* (*oil*.)

Q. *Why is mutton FAT, &c., solid, and OIL liquid?*

A. Because fat contains a predominance of solid ste'arine; and only a very small quantity of the liquid oily substance, called oleine. On the other hand, oil

contains more of the liquid oleine, and less of the solid matter, called ste'arine.

Q. *Why is BUTTER HARD in winter, and SOFT in SUMMER-time?*

A. Because in winter-time the weather is too cold to melt the ste'arine, and the butter is solid; but the heat of summer dissolves it, or holds it in solution in the oily substance called oleine, and the butter is soft and liquid.

Q. *Why does a POP-GUN make a loud REPORT, when the paper bullet is discharged from it? p. 102.*

A. Because the air, confined between the paper bullet and the discharging rod, is suddenly liberated, and strikes against the surrounding air; this makes a report in the same way, as when any two *solids* (such as your hand and the table) come into collision.

Q. *How does STEAM make the whistle of a locomotive engine sound? p. 110.*

A. The whistle is so constructed, as very frequently to obstruct the free passage of the steam through the jet; in consequence of which, very rapid vibrations are caused in the air, producing the sharp shrill sound of the locomotive whistle.

No sound is ever produced in any sounding body, unless there are  $12\frac{1}{2}$  vibrations in a second of time; if there are



7680 vibrations, the sound is sharp and shrill; the shrillness increasing, as the vibrations increase in number.

Q. *Why will BRIGHT IRON LOSE its POLISH by being put into a FIRE? p. 231.*

A. Because the oxygen of the air very readily unites with the surface of *hot iron*, and forms a metallic oxide; which displays itself, in this case, by a *dull leaden* color, instead of a red *rust*.

Q. *Why does SOUND SEEM LOUDER in CAVES, than on a plain? p. 381.*

A. Because the sides of the cave confine the sound-waves, and prevent their spreading; in consequence of which their *strength* is greatly increased.

Q. *Why does PAINT PRESERVE wood?*

A. 1st—Because it covers the surface of the wood, and prevents both air and damp from penetrating into the pores:

2dly—Because paint (especially of a white color) being a bad conductor, preserves the wood of a more uniform temperature: and

3dly—Because it fills up the pores of the wood, prevents insects and vermin from harboring therein and eating up the fibre.

Q. *Why does UNSEASONED WOOD DECAY much more rapidly than wood well seasoned?*

A. Because the albu'men which the

sap contains, produces a species of fermentation; during which, the cellulose and ligneous matter of the wood are turned into carbonic acid and water.

“Albu'men,” a substance resembling the *white* of an egg.

“Cellulin,” the substance which composes the *cells* of wood, as wax composes the cells of a honey-comb in a bee-hive.

“Ligneous matter,” or vegetable fibre, is the hard or woody part of wood.

Q. *Why is WOOD placed in a stream of running WATER to SEASON it?*

A. Because the running water washes away the sap; and thus prevents fermentation and decay.

Q. *Why will solutions of salts PREVENT the DECAY of wood steeped therein?*

A. Because the salts unite with the albu'men of the sap, coagulate it, and prevent fermentation.

Q. *Why does MOTHER of PEARL show so many colors? pp. 364, 370.*

A. Mother of pearl consists of a vast number of very thin half-transparent layers of unequal thickness, over-lapping each other like the scales of a fish.

Where these layers terminate are very small grooves or streaks running in all directions, which act like prisms.

It is these *streakings* or grooves, which

cause the various and changing colors of mother of pearl.

The same thing may very easily be imitated, and is frequently done in what are called "iris ornaments," first invented by John Barton, Esq., of the Royal Mint. These iris ornaments are made of steel, and have about 30,000 grooves per inch; they are used in court dresses, for buttons, sword handles, &c., and are very brilliant indeed.

Mother of pearl may be also imitated by taking impressions of it in wax, balsam of tolu, isinglass, or gum; these impressions will exhibit all the shades and colors of mother of pearl, merely because the impression will be streaked or grooved in a similar way.

Q. *Why can you fill a DRY GLASS BEYOND the level of the brim? p. 206.*

A. Because the mass of water in the glass holds the overplus back, by the power of attraction.

Q. *Why will the overplus instantly flow over, if the edges of the glass are wet?*

A. Because the water on the edge of the glass has an affinity to the water towering above it, no less than the water in the body of the glass has; and in this state of equilibrium the force of gravity, acting on the elevated particles of water, causes them at once to fall over.

Q. *If you leave a little tea in your cup, and rest your spoon on the bottom of the cup, why does the TEA RUSH to the SPOON? p. 387.*

A. Because the spoon attracts it, by what is called capillary attraction.

The sloping spoon makes with the sides or bottom of the cup a space in the shape of a very small wedge; where

the aperture is small, the cup and spoon draw the tea up by the force of attraction; and the *narrower* the opening, the *stronger* the attraction.

Q. *When LIQUOR is decanted or poured from a bottle, why does it GURGLE? p. 256.*

A. This bubbling noise is made by the air bursting *into* the bottle, and the liquor bursting *out*.

The liquor, filling the neck of the bottle, prevents the air from getting freely in; and the air, pressing against the mouth of the bottle, prevents the liquor from getting freely out: in consequence of which, the air bursts into the neck of the bottle, and the liquor runs from the same, by fits and starts, as either is able to prevail: as this process is repeated, the noise produced is called a gurgle.

Q. *Why will LUCIFER MATCHES IGNITE by merely drawing them across any rough surface? pp. 99, 221.*

There are two sorts of lucifer matches; those that ignite *silently*, and those that ignite with an *explosion*.

A. SILENT LUCIFERS are made of *phosphorus*, which has an affinity to oxygen at the lowest temperature; in-somuch that the little additional heat, caused by the friction of the match across the bottom of the lucifer-box, is sufficient to ignite it; and, at the same time, to ignite the sulphur with which the match is tipped.

EXPLOSIVE LUCIFERS are made of *chlorate of potash*, which will *explode* by very slight friction, and produce combustion.

“Chlorate of potash” is a compound of chloric acid and potash. Chloric acid is a compound of two gases, chlorine and oxygen.

Q. *Why will not lucifer matches ignite, if they are DAMP?* p. 48.

A. 1st—Because the cold, produced by the *evaporation* of the water, neutralises the heat produced by the friction of the match across the bottom of the lucifer-box : and

2dly—Because the damp prevents the free accession of oxygen to the match, without which it cannot burn.

Q. *When our likeness is reflected in a looking-glass, the entire image is REVERSED; so that our RIGHT cheek is the LEFT cheek of the reflection, &c.; why is this?* p. 345.

If a person stands *opposite* to us, his position in regard to the cardinal points of the compass is altogether reversed.

As in a mirror all the lines and angles of *incidence* equal the lines and angles of *reflection*, it is manifest that those parts of the person which are *nearest* the mirror, will *seem* to be nearer than those more remote; but, if our right cheek were to cross over to the right cheek of the reflection, then this law would be broken.

Our right cheek would cross over to the right cheek in the mirror, and our left to the left,  $\overset{B}{A} \times \overset{A}{B}$  in which (without doubt) the extreme points of the diagonals A A, and B B, are further apart than A is from B.

Q. A SILVER tea-spoon becomes MORE HEATED by hot tea, than one of INFERIOR metal (as German silver, Nickel, &c.); why is this? p. 156.

A. Because silver is a better conductor than German silver or Nickel.

The three best conductors of heat are, 1. Gold, 2. Silver, 3. Copper.

Q. If you scrape a slip of paper with a knife, why will the PAPER CURL?

A. Because the under surface of the paper is contracted by the scraping, which brings the particles closer together; this contraction of the under surface bends the slip of paper into a curl or arch.

Q. Why does the STOPPLE of a decanter STICK fast, if it be put in damp?

A. If the stopple be damp, it fits the decanter air-tight; and if the decanter was last used in a heated room, as soon as the hot air inclosed in the inside has been condensed by the cold, the weight of the external air will be sufficient to press the stopple down, and make it stick fast.

Q. Why does the STOPPLE of a SMELLING-BOTTLE very often STICK fast?

A. Because the contents of a smelling-bottle are very volatile, and leave the neck of the bottle, and the stopple, damp.

If the smelling-bottle was last used in

a hot room, as soon as the hot air and volatile essence, inside the bottle, have been condensed by the cold, the weight of the external air will be sufficient to press the stopple down and make it stick.

In the last two instances, the pressure of air forces the stopple down too far, so that it is like a cork which has been forced into a bottle: Hence there are two mechanical forces to contend against; 1st, The weight of air on the stopple which holds it down, as an exhausted receiver is held tight on the plate of an air-pump: and 2dly, The neck of the bottle, (expanded by heat when the stopple was put in,) will girt it with great pressure, so soon as it is contracted again by cold.

Q. *Decaying vegetables are first of a brownish tint, why do they afterwards turn of a DEEP BLACK?*

A. Because the hydrogen of the decaying vegetables is separated from the mass by the process of decay, and leaves a larger proportion of carbon behind.

Vegetable fibre contains	52½	per cent.	of carbon.
When partially decayed	54	"	"
When black with decay	56	"	"

Q. *Why is an OAK STRUCK by LIGHTNING more frequently than any other tree?*

A. Because the *grain* of the oak, being *closer* than that of any other tree of equal bulk, renders it a better conductor.

It is said, that the sap of the oak contains a large quantity of *iron* in solution, which impregnates the wood and bark, thus increasing its conducting power.

Q. *Why does a LOBSTER, which is black while alive, turn RED by being BOILED?*

A. The *blackness* is due to a peculiar

coloring matter secreted by the lobster ; which, however, turns *red* when exposed to the heat of boiling water.

Q. *Why does a SHRIMP, which is nearly WHITE while alive, turn RED by being BOILED ?*

A. The delicate pinky whiteness is due to a peculiar coloring matter secreted by the shrimp ; which, however, turns *red* when exposed to the heat of boiling water.

Many coloring matters pass into each other under very slight changes of condition. *g. e.*

*Blue* indigo changes to *white* indigo, if only one atom more of hydrogen be added. So also, the green chlorophyll of leaves changes into the infinite hues of the petals of flowers.

The science of colors is not at present sufficiently understood to give very lucid explanations of these changes ; the *facts* are known, and little else besides.

Q. *Why is the SHADOW of the MOON stronger than the shadow of the sun ?*

A. Because the *light* of the moon is not so *strong* as the light of the sun ; in consequence of which, the dispersed and reflected rays of the moon cannot reduce the opacity of shadows so much, as the more intense rays of dispersed and reflected daylight.

“ The opa'city of shadows,” i. e. the darkness of shadows.

Q. *Why does HARTSHORN take out the red spot in cloth, produced by any ACID ?*

A. Because hartshorn is an *alkali*.



and the peculiar property of every alkali's to neutralize acids.

“Alkali” pronounce Al'-ka-li. Soda, potash, magnesia, &c., are alkalies.

Upon this principle effervescing drinks are made of a carbonate of soda (an alkali), and citric or tartaric acid. Effervescence is produced, by the giving off of carbonic acid during the process of neutralization.

N. B.—The carbonic acid is made from the *carbon* (of the carbonate of soda) combining with the oxygen of the acid. p. 43.

Q. *Why will POWDERED SULPHUR QUENCH FIRE more readily than water?*

A. 1st—Because powdered sulphur has a very strong affinity for oxygen, and converts it into *sulphurous acid*; as this is the case, the fire is deprived of its essential food (oxygen), and is, in fact, *starved out*: and

2dly—Because sulphurous acid throws off dense white *fumes*, and surrounds the fire with an extinguishing atmosphere.

The difference between sulphurous acid and sulphuric acid is this: sulphurous acid contains less oxygen than sulphuric acid. When we burn sulphur in air, it throws off suffocating white fumes, called sulphurous acid.

Q. *How does STARCH STIFFEN linen?*

A. By filling the interstices of the fabric with a solution of starch, by which means the linen is made more rigid.

Q. *Why should LIGHTNING-CONDUCTORS be POINTED?*

A. Because points conduct electricity

away *silently* and *imperceptibly*: but knobs produce an *explosion*, which would endanger the building.

Points empty the clouds of electricity, acting at a much greater distance than knobs; thus a Leyden jar of considerable size may be safely and silently discharged, by holding the point of a needle an inch or two off.

Blades of grass, the ears of corn, and other pointed objects, serve to empty the clouds of their electricity.

Q. *Why do BRICKS turn GREEN, after they have been exposed to the weather?*

A. The "green" is a moss or lichen, which grows on the bricks; the seeds of which were carried to the surface by the winds.

Q. *When POTATOES are boiled, why are those at the TOP of the boiler COOKED SOONER than those nearer the fire?*

A. 1st—Because the *hottest* particles of the water rise to the *top* of the boiler, and the *coldest* particles sink to the bottom: and

2dly—Because the top of the boiler is always enveloped with very hot escaping steam; in consequence of which, the potatoes on the top are subjected to more intense heat, than those at the bottom of the boiler are.

Q. *If a SILVER SPOON, which has been tarnished by an EGG, be rubbed with a little SALT, why will the tarnish disappear?*

A. The tarnish in this case is *sulphu-*

*ret of silver*, produced by the sulphur of the egg combining with the silver spoon. Salt acts upon this sulphuret of silver thus—

The sodium of the salt combines with the sulphur, and produces sulphate of soda. The sulphur being thus taken away from the silver, the tarnish disappears.

“Sulphuret of silver,” i. e. sulphur in combination with silver.

Salt is a compound of the metal called sodium, and the gas called chlorine.

“Sulphate of soda” is a combination of sulphuric acid and soda.

Q. *Why are BOOKS discolored by AGE or DAMP?*

A. Because the fibre of the paper becomes partially decomposed, and various impurities from the atmosphere (or other sources) become mixed with it.

Q. *Why does SOUR MILK CURDLE?*

A. Milk consists of five ingredients: 1, Ca'sein or curd; 2, Butter; 3, Sugar; 4, Water; 5, Certain Salts.

The Ca'sein or curd of *sweet* milk is like the white of an egg before it is boiled; but the casein or curd of sour milk is like the white of an egg after it is boiled.

This casein or curd of milk is coagulated by acids:—When milk is sour, the

*lactic acid* of the sour milk, mixing with the casein, *coagulates* it; in consequence of which, it separates from the water and becomes an insoluble mass; or (in other words) the milk curdles.

“Lactic acid” (from the Latin word *Lac, milk*) is the acid of sour milk. But it is found in several other substances also, as in the fermented juice of beet-root, turnips, carrots, rice-water, tanning bark, &c.

Q. *Why does MILK turn SOUR by KEEPING?*

A. Because it undergoes a fermentation; during which “lactic acid” is formed, which turns the milk sour.

The lactic acid is formed from the sugar of milk by fermentation.

Q. *Why does MILK turn SOUR in HOT weather, much sooner than in cold?*

A. Because heat very greatly accelerates the process of fermentation; during which lactic acid is formed, which turns the milk sour.

Q. *Why can you NEVER BOIL STALE MILK without curdling it?*

A. Because stale milk is in an incipient state of fermentation, which the heat of the fire greatly accelerates: The lactic acid which is formed during fermentation, mixing with the casein of the milk, coagulates it.

Casein (*pronounce cas'-e-in*) is the curd of milk. coagulated by *acids* only.

Q. *Why does RENNET CURDLE MILK?*

A. Because it converts the sugar of milk into lactic acid, which mixes with the casein and coagulates it.

Milk contains soda and potash; so long as these alkalis are combined with the casein of the milk, the compound is soluble in water, and the milk sweet: but when the acid deprives the casein of the alkalis by combining with them itself, then the casein is no longer soluble in water, but is precipitated or curdled.

Rennet is the prepared inner membrane of the stomach of a calf so called from the German word *rinnen* (to curdle.)

Q. *Why does CHURNING cream convert it into BUTTER?*

A. Cream is the *fat* or butter of milk, contained in little globular cases of albu'men:

By churning, this film or envelop of albu'men is broken, and the butter or fat set free.

The globules are invisible to the naked eye, but may be distinctly seen floating about milk, by a tolerable microscope.

Albu'men is a substance resembling the white of an egg.

Q. *Why does the SUN or fire WARP WOOD?*

A. Because heat draws out the moisture from that part of the wood which faces it, and causes the heated surface to shrink; as, therefore, the heated surface of the wood *shrinks*, and is smaller than the *other* surface, it draws it into a curve, and the wood is warped.

Q. *Why does the SUN, for the most part, FADE artificial COLORS?*

A. Generally, the loss of color arises from the oxidation of the substances used in dyeing; as tarnish and rust are an oxidation of metals.

Sometimes, however, the ingredients of the dye are otherwise decomposed by the sun; and the color (which is due to a *combination* of ingredients) undergoes a change, as soon as the sun deranges or destroys that combination.

Q. *When a KNIFE is sharpened on a GRINDSTONE, why is OIL or water used?*

A. To make the contact more perfect. The oil or water fills up the interstices of the rough stone, and makes a more uniform surface: In consequence of which, the *entire edge* of the blade is submitted to an equal portion of friction, which would otherwise be rough and uneven.

Q. *Why does BAKING dough convert it into BREAD?*

A. When flour is baked in an oven its starch is changed into a gum called dextrin: and

A similar change is produced upon the farinaceous portion of the dough. The *yeast* (added to the dough) converts part of the starch and sugar into alcohol

and carbonic acid: Of these, the alcohol evaporates in the oven, and the carbonic acid forces the dough into bubbles, in its effort to escape, rendering the bread light and full of eyes.

In 100 lbs. of bread, and 100 lbs. of dough, we have

	STARCH.	SUGAR.	DEXTRIN.
In dough,	68 lbs.	5 lbs.	0=100
In bread,	53½ "	3½ "	18=100

whereby it will be seen that 16½ lbs of starch have been converted into the gum called dextrin by baking.

Dextrin is a gummy matter similar to that which composes the cells of wood (called cellul'in), only it is soluble in cold water.

Diastase (*pronounce* di-as'-tase) is a peculiar vegetable principle of malt extracted by water, which converts starch into dextrin or sugar.

Q. *Why does BREAD become mouldy, after it has been KEPT a few days?*

A. Because spores of the mould fungus, floating in the air, fix themselves in the decaying bread and germinate.

Fungi germinate only in *decaying* bodies.

Spores (*one syllable*) or Sporules (*two syls.*) from the Greek word σπορα (*seed*) is a word used by botanists to indicate the seed of cryptogamic or flowerless plants. They differ from seeds in this respect, every part of the spore shoots into a plant, and not one particular point alone, as in common seeds.

Q. *Why does MEAT PUTREFY sooner in hot, DAMP weather, than in cold?*

Putrefaction is simply the decomposition of the original elements, and their reunion in a new order. The new order is as follows:

1st. Carbon and oxygen unite to form carbonic acid;

2dly. Hydrogen and oxygen " " " water;

3dly. Hydrogen and nitrogen " " ammonia.

N. B.--Carbon unites with oxygen with a readiness pro

portioned to its heat: When *red* hot, the combination is *most* readily effected.

The reason why meat taints more rapidly in *hot* weather than cold, is this; Because the carbon of the meat unites with the oxygen of the air more readily when hot than cold: and

The reason why damp aids putrefaction is this; Because the *damp*, deposited on the surface of the meat, is of itself one of the compounds of putrefaction, and leaves an excess of hydrogen in the meat: and

Thus the original proportions and combinations of the meat are altered and decomposed.

The chief reason why salt *preserves* meat is because it absorbs the water from it, and deprives it of hydrogen.

Q. *Why does MEAT PUTREFY most rapidly in very CHANGEABLE weather?*

A. Because moisture is more freely deposited on the meat in very changeable weather; and this moisture is a chief compound of putrefaction.

Q. BIRDS, *after they are killed, KEEP longer in their FEATHERS, than when they are plucked; why is this?*

A. Because the feathers prevent the *air* or *damp* from getting so readily to the bird, to produce fermentation or decay.



Q. Why do PLANTS, which are kept on a window, BEND to the GLASS?

A. Because the side *away* from the light grows faster, than the side *facing* the light, and pushes the top of the plant over in a curve.

Wood is *warped* by the fire, because the *under* surface is smaller than the upper.

And paper is made to curl by seraping the under surface with a knife for the same reason.

N. B.—Woody tissue is deposited in the stem most abundantly on the side *nearest the light*; and where wood is formed most, *growth* is slowest, because the part is less succulent.

Q. Why does INDIAN-RUBBER erase PENCIL MARKS from paper?

A. Indian-rubber contains a very large quantity of carbon: Black-lead is carbon and iron.

Now, the carbon of the Indian-rubber has so great an attraction for the black-lead, that it takes up the loose traces of it left on paper by a pencil.

Q. Why does WATER ROT WOOD? and why does AIR rot WOOD?

A. Because it converts the solid part of the wood into what is called *humus*, by oxidation; thus—

1st—The *carbon* of the wood is oxidised into carbonic acid; and

2dly—The *hydrogen* of the wood is oxidised into water—the residue becomes humus or mould.

“Humus,” *pronounce* U'-mus. The black mould of our gardens is called humus, and is produced by the decay of vegetable matter by the action of air and water.

Q. *Why does* WATER *make a* HISSING *noise, when it is poured on* FIRE ?

A. Because the part which comes in contact with the hot coals is immediately converted into *steam*; and, as it flies upward, meets other particles of water not yet vaporised; the collision produces very rapid vibrations in the air, and a hissing noise is the result.

Q. *Why does* HOT IRON *make a* hissing *noise, when plunged into* WATER ?

A. Because the hot iron converts into steam the particles of water, which come in immediate contact with it; and, as the steam flies upwards, it passes by other particles of water not yet vaporised: the collision produces very rapid vibrations in the air, and a *hissing* noise is the result.

Q. *Why will* HOT IRON BEND *more easily than* cold ?

A. Because it is not so *solid*. The particles are driven further apart by heat, and the attraction of cohesion weakened; in consequence of which, the particles can be made to move on each other more readily.

By a still further application of heat, the particles will

be driven so far asunder from each other, that the solid iron will liquefy: in which state the particles will move on each other almost without resistance.

Q. *Why does IRON turn first RED and then WHITE from HEAT?*

A. Light and heat depend upon vibrations; the more rapid the vibrations, the more intense the light and heat; *White* heat is a more intense degree of heat than red, and occurs only when the vibrations are most rapid.

Candescence occurs when bodies are heated to  $800^{\circ}$ . It begins with a dull red color, passes to an orange tint, and ultimately to a shining white.

The more perfect the combustion of carbon the whiter its color.

Probably these varying colors depend upon some variety in the thickness of the molecules of the heated substance, caused by the influence of heat; whereby it is made to reflect different colors according to the varying thickness of the molecules. But the subject is not well understood at present.

Molecules (*pronounce* mo'-le-cules) are very small particles of matter in a *mass*. ATOMS have no regard to aggregation.

Q. *Why does WATER FREEZE more quickly than MILK?*

A. Because milk contains *salts* in solution; in consequence of which, it requires a greater degree of cold to congeal it than water.

Water freezes at  $32^{\circ}$ , but *salt* and water will not freeze unless the thermometer sinks below  $7^{\circ}$ .

Q. *Why does HOT WATER FREEZE more quickly than cold?*

A. Because there is a slight *agitation*

on the surface of hot water, which promotes congelation; by assisting the crystals to change their positions, till they take up that which is most favorable to their solidification.

Other causes may have a minor influence, as for example: In hot water, the particles are subdivided into smaller globules by the heat, and offer less resistance to the action of cold than larger ones. 2dly. The *air* has been expelled from the water by the process of boiling—hence the Indians always used *boiled* water in their ice-pits.

N. B.—Air must be expelled from water before it can be frozen.

Q. *Why will a little OIL on the surface of water prevent its FREEZING?*

A. Because oil is a bad conductor, and prevents heat from leaving the water.

The surface of water never freezes, till the whole mass is cooled down to 42°.

Q. *Why does water in a very EXPOSED place freeze more rapidly than that which is under cover, or in places less exposed?*

A. 1st—Because evaporation goes on more rapidly, when water is exposed; and carries away heat from the general mass: and

2dly—Any covering will radiate *heat* into the water below, and prevent the mass from cooling down to 42°.

“Radiate heat” means, to send heat out in rays.

Q. *Why are GLUE, GUM, STARCH, and PASTE, adhesive?*

A. Because the water used with them rapidly evaporates, and leaves them solid.

They lose their adhesiveness when dissolved in water; and, therefore, must always be suffered to become *dry*, before they will hold with tenacity.

Q. *Why does a rail-way TRAIN make more NOISE, when it passes over a BRIDGE or MEADOW, than when it runs over SOLID GROUND?*

A. Because the bridge (or meadow) is very elastic, and *vibrates* much more from the weight of the train, than the solid earth; in consequence of which, it produces more definite sound-waves.

The bridge acts as a sounding-board; and the water or earth, below the bridge, *repeats* the sound.

Q. *Why does MILK BOIL more QUICKLY than water?*

A. Because *less steam* is carried off from the *thick* liquid (milk), than from the *thin* liquid (water); in consequence of which, the heat of the whole mass rises more quickly.

Q. *Why will MILK BURN very easily, when boiled, while water will not do so?*

A. 1st—Because milk contains solid organic substances, capable of burning; which water does not:—and

2dly—Because the heat of the fire coagulates the albumen of the milk.

which falls to the bottom, and adheres to the boiler.

Albu'men is a substance resembling the white of an egg

Q. *Why does WAX become SOFT, before it turns LIQUID?*

A. Because it absorbs heat sufficient to *loosen* the contact of its particles, before it has absorbed sufficient to *liquefy* the mass.

Q. *If you heat STEEL RED HOT in the fire, and then plunge it suddenly into cold water, it becomes HARD and BRITTLE; why is this?*

A. Because the sudden chill violently expels the latent heat, which would have settled in the steel, had it been allowed to cool slowly.

The malleability and toughness of metals depend upon their power of absorbing heat.

Q. *Why are the ICE-PITS of India lined with straw and coarse blanketing—stopped up with STRAW at the mouth, instead of a door—and THATCHED on the roof, instead of being covered with slates or tiles?*

A. Because straw and coarse blanketing, being very bad conductors indeed, prevent the external heat from getting to the ice-pits to dissolve the ice.

Q. *How do the natives of INDIA provide themselves with ICE, when the temperature is much higher than the freezing point?*

A. They make a hole in the earth about 2 feet deep, and 30 feet square: They cover the bottom of this hole, to

the depth of a foot, with the stalks of Indian corn or sugar-canes :

On this bed they place fleet unglazed earthen pans about an inch and a quarter deep, and pour into them (at sun-set) soft water, which has been *boiled* and suffered to cool. At sun-rise the water is found to be frozen, and is thrown into the ice-pit.

The reason of this is : The vessels being porous, part of the water evaporates through the pans, and reduces the heat of the water sufficient for congelation.

Q. *Why is it customary, in very HOT COUNTRIES, to sit in rooms separated by CURTAINS, instead of walls; and to keep these curtains constantly sprinkled with WATER ?*

A. Because curtains are bad conductors of heat ; and the rapid evaporation of water reduces the temperature of the room 10 or 15 degrees.

Q. *Why is it impossible to WRITE on GREASY PAPER ?*

A. Because grease has no affinity for water or ink, and, therefore, will not mix with it.

Q. *Why is rain said to "bring down the cold ?"*

A. Because the change in the atmosphere, which causes rain to fall, *sets free latent heat*, and makes it sensible.

*Frost* is broken up by the rains; and the sharp, piercing *wind*, being laden with vapor, is much mitigated.

Q. *Why does TURPENTINE take out GREASE spots from cloth?*

A. Because it dissolves fixed oils.

The *fixed* oils are all greasy oils, such as sperm oil, olive oil, &c. The other sort of oils, called *volatile* or *essential* oils, are those used in perfumery, &c.

Q. *Why does OXALIC acid take out INK spots?*

A. Because it dissolves the tannate of iron, of which the black portion of the ink consists.

“Tannate of iron” is tannic acid combined with iron. Tannic acid is the acid of tan, or oak bark.

Q. *When COPPER is exposed to moist air, it is incrustated with a green coating, called VERDIGRIS; why is this?*

A. Because the oxygen of the moist air combines with the copper, and forms what is called a hydrate of the carbonate of the protoxide of copper.

“Protoxide” ( $\pi\rho\omega\tau\omicron\varsigma$ -oxide, the lowest or first state of oxidation): The protoxide of copper is a combination of one portion of oxygen, and one of copper. Hydrate (from the Greek word  $\nu\delta\omega\rho$ , *water*) is a compound containing water; but in all hydrates, the substance forms so intimate a union with water, as to solidify it, and render it a component part. A “hydrate of the carbonate of copper,” is a compound of water, carbonic acid, and copper; and “A hydrate of the carbonate of the protoxide of copper,” is copper in its lowest state of oxidation, in which carbonic acid and water is so united, as to form a solid.

Q. *Why does ZINC TARNISH in the air?*

A. Because the oxygen of the moist air combines with the zinc, and forms an oxide of zinc.



An "oxide of zinc" is oxygen in union with zinc.

Q. *Why does SALT turn silver BLACK?*

A. Because it precipitates an oxide of silver on the surface of the spoon, the color of which is black.

"Marking ink" is made of soda and the nitrate of silver; the black mark being due to the oxide, precipitated on the cloth.

Q. *How can the BLACK stain of SILVER, made by salt, be REMOVED?*

A. By washing the silver in hartshorn, or common ammonia; by which means, the oxide will be re-dissolved and the blackness entirely disappear.

Q. *Why does WAXING cotton or thread make it STRONGER?*

A. Because it cements the loose filaments to the cord; and makes the strands of the thread more compact.

The "filaments of the cotton," are the loose fibres hanging about it. The "*strands*" are the twists or single yarns twisted into a thread. Sewing cotton contains two, three, and occasionally more than three strands.

Q. *The comb of walking-sticks is made by BOILING the end of the stick, and then bending it into an arch; why is a STICK made FLEXIBLE by BOILING?*

A. Wood contains many substances soluble in hot water, as starch, sugar, gum, &c., and several other substances which are softened by it: as, therefore, several substances are dissolved, and

others softened by boiling water, the stick is rendered flexible.

Cellular fibre and woody matter, when boiled in water, become soft and gelatinous.

Q. *Explain how MANURE makes LAND FERTILE.*

A. As plants extract a certain amount of *salts* from the soil, which are entirely removed at harvest, it is obvious that the soil will become gradually impoverished, unless these matters are restored; this restoration is made by *manuring* the soil.

Q. *Why is GUANO valuable as a MANURE?*

A. Because it contains nitrogen and ammonia, both of which are essential to plants.

Q. *What is the use of LIMĒ, MARL, &c., as MANURE?*

A. 1st—They decompose vegetable substances: and

2dly—They liberate the alkalies in union with the silica of the soil.

Silica (*pronounce Sil'-i-cah*), from the Latin word *Silex*, *flint*—one of the most common substances on the earth—containing the following varieties—white chuckstone—violet amethysts—red quartz—yellow cairngorum—Brazil pebbles for spectacle glasses—rock crystal—chalcedony—agate—blood-stones—cornelian—flint, &c.

Q. *Why do you see the reflection of two candles, or two fires, in a looking-glass or window-pane, though there is only ONE candle or fire in the room?*

A. Because each surface of the look-

ing-glass or window-pane makes a reflection.

N. B.—In order to see these two reflections, you must not stand directly before the glass, but a little on one side.

Q. *Why is the SKY BLUE on a fine day, and not red or orange?*

A. Because the momentum of red and orange rays (being greater than that of blue) causes them to penetrate *beyond* the clouds; but the blue rays are stopped on their passage, and reflected.

Q. *Why is it LIGHT when the heavens are covered with thick CLOUDS?*

A. Because the multiplied reflections of the sun in the atmosphere are sufficient to give light upon the earth, even when thick clouds are passing over the disc of the sun.

Q. *Why are putrefying FISH LUMINOUS?* p. 266.

A. Because the carbon of the fish, uniting with oxygen, forms carbonic acid; and the *phosphoric acid* of the fish (being thus deprived of oxygen) is converted into *phosphorus*: as soon as this is the case, the phosphorus begins to unite with the oxygen of the air, and becomes luminous.

Carbonic acid is a compound of carbon and oxygen.

Phosphoric acid is a compound of phosphorus and oxygen. If you take the oxygen away from phosphoric acid, the residue, of course, is phosphorus.

The luminousness spoken of is due to the *slow combustion* of the phosphorus, while it is uniting with the oxygen of the air.

Q. *Why is the SEA often LUMINOUS in summer-time?* p. 266.

A. Because the small jelly fish decay; the phosphoric acid which they contain (being deprived of oxygen) is converted into *phosphorus*, unites with the oxygen of the air, and becomes luminous.

Q. *What causes the disease commonly called the itch?*

A. It is produced by an *insect* called the "itch insect," which burrows in the skin, and is greatly encouraged by filth. Sulphur, corrosive sublimate, &c., will destroy the insect, and cure the disease.

Corrosive sublimate is made of 200 parts of mercury with 72 of chlorine. It is plain to see how the disease is contagious.

Q. *Why does the use of SALT BEEF produce scurvy?*

A. Because the soluble salts are removed from the beef by brine: in consequence of which, it cannot restore to the human system those salts, which are essential to preserve the blood in a healthy state.

Q. *Why is LIME-JUICE a perfect CURE for SCURVY?*

A. Because it contains the very salts,

+

removed from the beef by the action of brine.

Namely—alkaline phosphate—and sulphate, chloride and phosphate of lime.

“Alkaline phosphates” are such as these—phosphate of soda, phosphate of potash and phosphate of magnesia; i. e. soda, potash, or magnesia, in combination with phosphoric acid.

“Sulphate of lime,” a compound of sulphuric acid and lime.

“Chloride of lime,” a compound of chlorine gas and lime.

“Phosphate of lime,” a compound of phosphoric acid and lime.

Q. *Why does the use of VEGETABLES generally PREVENT SCURVY?*

A. Because they contain the soluble salts removed from the beef by brine; which being restored by the vegetables, preserve the blood in a healthy state.

Q. *Why does WOOD DECAY?*

A. Because the oxygen of the air unites with the carbon and hydrogen of the wood, and forms carbonic acid and water.

Q. *When WINE is spilt on a TABLE-CLOTH, napkin, or handkerchief, how can the STAIN be REMOVED?*

A. By dipping it in a weak solution of chlorine.

Bleaching powder is only lime impregnated with chlorine.

Q. *When WINE is spilt on a table-cloth, &c.,*

*why do persons generally cover the part immediately with SALT?*

A. Because salt is a compound of chlorine and sodium; and the chlorine of the salts acts as a bleaching powder.

Q. *When INFECTIOUS DISEASES prevail, how can the contagious matter be removed from bed-rooms, hospitals, houses, &c.?*

A. By using a solution of chlorine, or of sulphurous acid; which will not only remove the contagious matter, but also the offensive smell of a sick room.

Q. *What is an excellent remedy against RATS and MICE?*

A. Sulphuretted hydrogen. All that is necessary is to introduce the beak of a retort into a rat-hole, while sulphuretted hydrogen is being given off.

It will destroy the rats and make the hole unfit for others to frequent.

*Sulphuretted hydrogen* is made thus. Put into a retort or glass bottle a quantity of sulphuret of iron, prepared by heating a rod of iron red hot; bring it in contact with a roll of sulphur—allow the sulphuret of iron formed to drop into water; pour over it a small portion of water, and then add an equal quantity of sulphuric acid; sulphuretted hydrogen will be given off most copiously.

Q. *Why does GUNPOWDER EXPLODE?*

A. Because of the instantaneous production and expansion of carbonic acid, sulphurous acid, and nitrogen.

Gunpowder consists of 76 parts of nitre, 13 charcoal, and 11 sulphur.

Q. *An object in the SHADE is not so bright and apparent, as an object in the sun; why is it not?*

A. Because objects in the shade are seen by reflected light *reflected*, i. e. the light is *twice* reflected: and, as the rays of light are always absorbed in some measure by every substance on which they fall, therefore, some light is lost; 1st—Before the *second* reflection is made, and 2dly—In the object that *makes* the second reflection:

Part of the rays are absorbed, and part are scattered in all directions by irregular reflections; so that rarely more than *half* is reflected, even from the most polished metals.

Q. *Why are GREEN GOOSEBERRIES, CURRANTS, &c., HARD; and RIPE ones SOFT?*

A. Because they contain an infinite number of little cells, with thick walls; these become thinner from day to day, as the fruit ripens, until they break; when the fruit becomes soft.

Q. *Why is PORTER much DARKER than ale or beer?*

A. Because the malt of which porter is made is dried at a higher temperature and slightly *charred*.

*Small beer* is a weak wort fermented, and contains  $1\frac{1}{2}$  per cent. of alcohol.

*Ale* is a stronger wort, and contains 7 per cent. of alcohol.

*Porter* contains  $4\frac{1}{2}$  per cent. of alcohol.

*Brown stout* contains  $6\frac{3}{4}$  per cent. of alcohol.

*Burton ale* contains  $8\frac{1}{2}$  per cent. of alcohol.

Q. *If WINE or BEER be imperfectly corked, why does it rapidly turn sour?*

A. Because *air* gets into the liquor; and the oxygen of the air, combining with the alcohol of the liquor, produces acetic acid.

1 alcohol and 4 oxygen, become 1 hydrous acetic acid and 2 water.

Q. *Why does pyroligneous acid PRESERVE MEAT and remove its taint?*

(Pyroligneous acid, is vinegar extracted from wood.)

A. Because it contains a small quantity of creasote, which is a great preservative of all animal substances.

Creasote, pronounce Cre-a-sote (from two Greek words, κρεας, *flesh*, and σωζω, *I save*), an extract from the oil of tar, and a powerful antiseptic.

Q. *Why are HAMS preserved by SMOKING them?*

A. Because the smoke of a wood fire contains creasote, which is a great preservative of all animal substances.

Q. *Is TEA a NUTRITIOUS beverage?*

A. Yes; the tea-leaf contains the largest amount of nutritive matter of any plant used as human food; though only a portion is extracted by our common method of making tea. When soda is added, the *casein* of the leaves is dissolved, and the nutritive quality of the tea is much increased.



Casein *pronounce* Cas'-e-in, from the Latin word *caseus*, *cheese*; because cheese consists chiefly of the casein of milk. It is found in many vegetable substances, as peas, beans, lentils, &c., and is the same as the substance called legu'mine.

Q. *How do the Tartar tribes make a most nutritious food from tea?*

A. They boil the leaves with soda, and eat them with salt and butter.

Q. SOAP is made of oil or fat. How is it that oil and fat make water greasy, whereas SOAP destroys grease?

A. Oil contains two parts; the solid part called *stearine*, and the liquid part called *oleine*.

Stearine of oil is not soluble in water; but when soda or potash is boiled with it, the oily principle flies off, and the stearine is converted into an oxide of potassium, which is quite soluble in water.

Stearine (*pronounce* Ste'-a-rine), from the Greek word *στέαρ*, *suet*; the *acid* of stearine unites with the soda or potash, and the oily principle called *glycerine* flies off.

Oxide of potassium is the fundamental part of potash; it is what chemists call a metallic oxide.

Q. *What is the difference in composition between HARD soap and SOFT SOAP?*

A. The *hard* soaps are made of soda, and the soft soaps are made of potash.

Q. *Why is sorrel sour?*

A. Because it contains oxalic acid.

Oxalic, from the Greek word *οξάλις*, *sorrel*. Oxalic acid is sometimes erroneously called "salt of lemons."

Q. *Why are unripe APPLES, GOOSEBERRIES, and RHUBARB, SOUR.*

A. Because they contain malic acid.

Mal'ic, from the Latin word *malum*, an *apple*.

Q. *Why are tamarinds and unripe GRAPES sour?*

A. Because they contain tartaric acid.

Tartaric acid is the acid of tartar. Tartar is a substance deposited by wine; adhering, like a hard crust, to the sides of the casks.

Q. *Why does TANNING hides convert them into LEATHER?*

A. Because oak bark contains tannic acid; and, on evaporation, this acid precipitates a solution of *glue* upon the hides, which converts them into leather.

Q. *Why are citrons, limes, LEMONS, and unripe ORANGES, SOUR?*

A. Because they contain citric acid.

Citric, from the Latin word *citrus*, a *lemon* or *citron*.

Q. *Why is VINEGAR SOUR?*

A. Because it contains ac'e'tic acid.

Ac'e'tic, from the Saxon word *æced*, *vinegar*; whence also *acid*, i. e. *like vinegar*.

Q. *Why do old WINE CASKS SMELL OFFENSIVELY?*

A. Because wine (and whiskey) contain an acid called œnanthic acid; which unites with the alcohol of the wine, and forms a salt of an offensive smell.

This salt is called the œnanthate of ethyle, i. e. the wiley acid of ether.

œnanthate, from the Greek word *οινος*, wine; and "ethyle," from the two Greek words, *αιθηρ-υλη*, the basis or fundamental principle of ether.

Q. *When a CANDLE is BLOWN OUT, whence arises the OFFENSIVE ODOR?*

A. The tallow distills a substance in the smoke, called acryle, which has a very offensive smell.

"Acryle" (*pronounce ac'-ryle*) from two Greek words, *ακρη-υλη*, the basis or principle of a wick or end, i. e. the odor which issues from a wick-end, after it has been blown out.

Q. *What causes the decay of teeth?*

A. After the enamel is worn off, the dentine or ivory of the tooth is left bare: This dentine or ivory is full of little tubes, filled with *lime*; Now, the acids of saliva, mucus, and food, dissolve this lime, and fill the tubes with foreign matters; after which, the tubes *dissolve* or crumble away, leave the *nerve* exposed, and the pain of tooth-ache ensues.

Dentine (from the Latin word *dens*, a *tooth*) is the main part of the tooth.

Q. *Why does CREASOTE CURE TOOTH-ACHE?*

A. Creasote acts as a caustic, and burns away the mortified bone, or ulcer formed upon it, which produced the pain.

Tooth-ache arises from numerous causes, as cold, stomach, caries, or decay, &c. Creasote is a remedy for tooth-ache only when the pain arises from caries.

Ca'-ri-es is a Latin word which signifies, mortification or ulcer of the bone.

Q. *What is Indian rubber ?*

A. The oil or resin from various species of ficus, oxidised in contact with air.

“ Fi'-cus,” the fig-tribe.

Q. *What is gutta percha ?*

A. The oil or resin of a tree which grows in Malacca (Asia), called Isonandra gutta, oxidised in contact with air.

Q. *What wines contain the most spirit, and what the least ?*

A. *Champagne* is one of the weakest wines, then *hock*, then *claret*, then *sherry*, and *port* is one of the most potent. Four glasses of port being nearly equal to five glasses of sherry.

Champagne contains about 12 per cent. of alcohol.

Hock	“	“	13	“	“
Claret	“	“	16	“	“
Sherry	“	“	19	“	“
Port	“	“	23½	“	“

Q. *What is the origin of the term PROOF spirit ?*

A. It is derived from the old method of testing spirit, which was thus: the spirit to be tested was poured over *gun-powder*, and ignited; if the powder exploded, the spirit was said to be *above proof*; if it did not explode, it was said to be *below proof*.

Q. *What do we mean, at the present day, by spirit above and below PROOF?*

A. If we say that spirit is 10 over proof, we mean this—that 100 gallons of it will require 10 *gallons of water* to reduce the spirit *to* proof strength. So on the converse, if we say that spirit is 10 *under* proof, we mean that 10 *gallons of water* must be taken *from* the spirit to raise it to proof strength.

Proof spirit has .91833 specific gravity; the strength of spirit is now tested by an instrument called an hydrom'eter.

Q. *How is STEEL made from IRON?*

A. The iron is surrounded with charcoal, and placed for six or eight days in a furnace, intensely heated; the carbon unites with the iron, and forms what is called "carburet of iron" (or steel).

Q. *What is meant by "SHEAR STEEL?"*

A. Steel used for making *shears*, for dressing woollen cloth: Shear steel is broken and welded frequently.

Welded, i. e. hammered together again.

Q. *What is common MARKING INK?*

A. There are generally *two* bottles—one containing a solution of the carbonate of soda: and another containing a solution of nitrate of silver. The cloth is first moistened with the carbonate of soda, dried, and then written on with a

pen dipped in the nitrate of silver. An oxide of silver is thus precipitated, and leaves a black mark behind.

Q. *What is JEWELLER'S GOLD?*

A. An alloy of gold and copper with silver—this gold is liable to tarnish, but its brilliancy can easily be restored, by immersing the metal in ammonia.

Q. *How is IRON GALVANIZED?*

A. By plunging it into melted zinc; when an alloy is formed on the surface, which prevents oxidation.

Q. *What is the difference between LEAD and SOLDER?*

A. Solder is a mixture of lead and tin.

*Fine solder is 2 tin and 1 lead.*

*Coarse solder is 1 tin and 4 lead.*

Q. *What is WHITE LEAD, used for paint?*

A. It is prepared by placing sheets of lead over earthen pots, which contain weak acetic acid, and stand upon tan or dung. The lead, being corroded with the acid, unites with the carbon and oxygen evolved from the dung.

Q. *What is PEWTER?*

A. An alloy of lead (or bismuth) and tin.

In the following proportions: 1 part lead and 20 parts tin.

Q. *What is* BLOCK TIN ?

A. Tin purified by heat, and run into moulds, which form blocks of great size.

Some 3 cwt., and some even more.

Q. *How is the* GREEN FIRE *of fireworks produced ?*

A. By the nitrate of bary'tes, which burns with a green hue.

(Barytes, *pronounce ba-ry'-tes*) an earth so called from a Greek word which signifies *heavy*, (*βαρυς*.) It is made thus; 100 parts of nitrate of bary'tes well dried, 9 of sulphur, 7 of chlorate of potash, 2 charcoal, 4 sulphuret of antimony, all well dried and mixed in a mortar.

Q. *How is the* RED FIRE *of fireworks produced ?*

A. By the *nitrate of stron'tian*, which burns with a red hue.

(Stron'tian is an earth, so called from a village in Argyleshire of the same name, where it was first discovered.) It is made thus; 100 parts of dry nitrate of stron'tian, mixed with 12 parts of chlorate of potash, 30 sulphur, 10 sulphuret of antimony, and 3 charcoal, well dried and *rubbed carefully* in a mortar.

N. B.—Unless care be taken the mixture will explode.

## ANTIDOTES FOR POISONS.

Q. *If a person has swallowed a MINERAL poison, such as ARSENIC, what is the best antidote?*

A. A tea-spoonful of sulphur—or half a tea-spoonful of pearl-ash—or a wine-glass of soap-suds :

After a little while, give a table-spoonful of antimonial wine, and plenty of warm water.

Q. *If a person has swallowed a VEGETABLE poison, such as SULPHURIC ACID, AQUA-FORTIS, or OXALIC ACID, what is the best antidote?*

A. Lime, chalk, pearl-ash, magnesia, carbonate of soda, or soap-suds, and a plenty of warm water; a dessert-spoonful of antimonial wine should be added, if at hand.

The chalk or lime, &c., unites with the oxalic acid, and forms oxalate of lime, which is quite innocuous.

Q. *If LAUDANUM has been taken, what is the best antidote?*

A. A tea-spoonful of common mustard; and to keep the patient walking.

Q. *If CHLORINE has been taken, what is the best antidote?*

A. Ammonia, which will neutralize the ill effects of chlorine.

Q. *If IODINE has been taken in too large a quantity, what is the best antidote?*



A. *Iron-filings* are the best antidote for an over-dose of iodine.

Q. *If a person feels faint from the fumes of PRUSSIC ACID, what is the best antidote?*

A. To smell the vapors of strong ammonia, which will soon restore consciousness.

Q. *How can WARTS, &c., be REMOVED?*

A. By rubbing them with common solid potash.

Q. *What is the best antidote to VERDIGRIS?*

A. Sugar, or white of egg.

Q. *What is the best antidote to CORROSIVE SUBLIMATE?*

A. White of egg, or milk; which will combine with them, and neutralize their poisonous qualities.

Q. *If a person has eaten too much FRUIT, what is the best antidote?*

A. Lime, chalk, pearl-ash, magnesia, carbonate of soda, or soap-suds.

Great relief is often found by eating the hard part of cheese (cut close to the rind) thickly covered with common salt; the reason is plain.

## GLOSSARY.

---

<i>Acetic</i>	Acid.	called	Distilled Vinegar.
<i>Citric</i>	"	"	Juice of Lemons.
<i>Nitric</i>	"	"	Aqua Fortis.
<i>Oxalic</i>	"	"	Salt of Lemons.
<i>Sulphuric</i>	"	"	Oil of Vitriol.
<i>Sulph. of Alumina</i>	"	"	Alum.
"	<i>Lime</i>	"	Plaster of Paris.
"	<i>Iron</i>	"	Green Copperas.
"	<i>Copper</i>	"	Blue Vitriol.
"	<i>Magnesia</i>	"	Epsom Salts.
"	<i>Soda</i>	"	Glauber Salts.
"	<i>Zinc</i>	"	White Vitriol.
<i>Nitrate of Potash</i>	"	"	Saltpetre.
"	<i>Silver</i>	"	Lunar Caustic.
<i>Prussiate of Potash</i>	"	"	Prussian Blue.
<i>Tartrate of Potash</i>	"	"	Rochelle Salt.
<i>Acetate of Copper</i>	"	"	Verdigris.
<i>Muriate of Soda</i>	"	"	Table Salt.
<i>Oxide of Lead</i>	"	"	Goulard.
<i>Carb. of Ammonia</i>	"	"	Smelling Salts.
"	<i>Lime</i>	"	Chalk, Marble, &c.
<i>Sup. Acetate of Lead</i>	"	"	Sugar of Lead.

SUBLIMATES are chemical preparations, the basis of which is quicksilver. In CORROSIVE SUBLIMATES, the quicksilver is *extinguished* either by vitriol, potter's clay, or some other ingredient.

SUBLIMATION is a similar process to distillation; only *solids* (such as metals) are employed, instead of *liquids*.

Thus the fine *blue* used by painters is a sublimate, and made thus:—Take 2 parts of quicksilver, 3 flower of brimstone, 8 sal ammoniac; and (having ground them) put them with the quicksilver into a glass retort, luted at the bottom: place the retort in a sand-heat; and (when the moisture is given off) you will have a splendid blue sublimate for painting.

N. B. It may be profitable to remind the pupil that when the termination "ous" is used, it implies that the substance has less oxygen than when the termination "ic" is added—thus, sulphurous acid contains less oxygen than sulphuric acid, &c

# INDEX.

---

	Page		Page
<b>ABSORBERS</b> , .....	173	Air dries linen .....	151
not conductors	173	elements of .....	219
not reflectors.	179	expanded by heat	102, 268
radiators. ....	182	full of smells .....	143
<b>ABSORPTION OF HEAT</b> ..	173	gets fire up .....	54
not conduction	173	healthful .....	242
of light .....	339	heated .... 202, 226,	270
<b>ACCIDENTAL COLORS</b> ..	375	not by the sun	181, 226
Acetate of copper ....	454	hotter when the sun	
Acetic acid .....	454	shines .....	227
Acid of drinks.....	248	in a room .....	270
of fermentation ..	248	inflammable, <i>see hy-</i>	
Acids dissolve ice ....	32	<i>drogen.</i>	
Activity affected by		needful for fire .....	53
cold .....	90	non-conductor.....	19
“ by heat .....	92	of cities unhealthy	
Acrated water.....	247	223, 242	242
Aeronauts feel pain	138, 229	of the country heal-	
Age affects power of		thly .....	223, 242
walking.....	392	on land colder than	
Aged people far-sighted		on water .....	207
	361, 363	on land cold at night	211
<b>AIR</b> .....	219, 268	preserved normal ...	224
always in motion ..	270	purified by lightning	32
ascends when hot ..	268	radiates no heat ....	202
bad conductor	15, 165, 217	rarefied is noiseless.	139
bad radiator. ....	202	rarefied, bad conduc-	
cold. ....	166	tor of sound. 383	
colder than blood ..	169	“ by a crowd..	239
composed of two		rusts iron.....	231
gases .....	30, 219	still before a tempest	139
condensed by cold ..	269	use of oxygen in....	220
cooled by convection	202	varies in tempera-	
cooled by rain.....	150	ture. ....	313
cools hot iron .....	227	Air-gun .....	101
density diminished by		Air-pump freezes water	335
rain .....	315	Aisles famous for echoes	384
descends when cold	269	colder than galleries	229
double current in a		<b>Alcohol</b> .....	249
room .....	270	from sugar .....	250

	Page		Page
Alcohol, boiling point of	115	Balloons . . . . .	138
ALF . . . . .	107	inflated . . . . .	107
bottled . . . . .	248	rise ( <i>see aeronauts.</i> )	107
froth of . . . . .	248	Balls of fire . . . . .	14
" increased by heat	107, 248	Balusters wet . . . . .	200
Alkali . . . . .	50	Banisters, <i>see balusters.</i>	
Ammonia . . . . .	251	Barley malted . . . . .	251
Anemometer . . . . .	294	BAROMETER . . . . .	296
Anglers hate a magpie	145	affected by cold ..	300
Angle of incidence . . . .	344	" frost ..	299
of reflection . . . . .	344	" heat ..	302
Anhydrous sugar . . . . .	250	" thaw ..	300
Animal fluids conduc-		" wind ..	299
tors . . . . .	20	rules for its rise	
ANIMAL HEAT . . . . .	83, 258	and fall ..	299, 308
caused by com-		sudden change in	302
bustion . . . . .	85	use of . . . . .	298
Animal and vegetable		varies most in win-	
life dependent . . . . .	225	ter . . . . .	306
Animals for bode rain ..	141	" least in summer	306
Ants love honey-dew ..	204	when highest . . .	306
Appetite, <i>see hunger.</i>		" lowest . . .	307
Apples full of air . . . . .	104	Barren land collects no	
roasted . . . . .	103	dew . . . . .	194
soft . . . . .	104	Bass notes in music ..	379
April showers . . . . .	288	Bass preserves flowers	
Aqua-fortis . . . . .	454	from frost . . . . .	191
Argand lamps . . . . .	82	Bathing, danger of . . . .	359
Ascent in balloons pain-		" with ether for in-	
ful . . . . .	138	flammation . . . . .	148
Ashes soften water . . . .	322	Beakers broken by hot	
Asses bray in wet wea-		water . . . . .	120
ther . . . . .	141	Beasts covered with hair	165
Atmosphere ( <i>see air</i> ) ..	284	Beds damp . . . . .	149
Aurora borealis . . . . .	136	BEER, fermentation of	249
colored . . . . .	136	flat . . . . .	255
white . . . . .	136	froth increased by	
a prognostic ..	136	bottling . . . . .	248
Autumn tints . . . . .	372	froth increased by	
Avenues . . . . .	353	heat . . . . .	107, 248
Azote, <i>see nitrogen.</i>		stale . . . . .	255
Bales catch fire spon-		soured by lightning	32
taneously . . . . .	60	not <i>old</i> beer . . . .	32
		spoiled, if the vent-	
		peg be left out	255

	Page.		Page
Beer, yeast added to make it work .....	251	Blood, red .....	222, 223
(see <i>vent peg</i> .)		Blowers .....	70
Beer-vats dangerous ..	245	Blowing cools broth, tea, &c. ....	168, 293
Bells heard at a distance	380	Blue .....	454
cracked, sound harsh	378	sky .....	126
ringing dangerous ..	23	spectacles.....	375
silenced by a touch	378	sublimate.....	454
Bell-metal .....	378	Body, fuel of .....	86
Bellows .....	55	warm .....	84, 258
Bible explained..	164, 195	Boiler, <i>see saucepan</i> .	
	311	Boiling .....	213
Birds covered with fea- thers .....	165	" WATER bubbles..	111
Bins purified by lime	259	furr of.....	236
BLACK .....	371	makes it flat ..	257
cloth warm .....	174	is in a ferment	214
eyes .....	179	kept hot .....	187
glass for spectacles	376	rattles.....	112
hat turns red at the sea-side.....	321	runs over .....	111
hole of Calcutta ..	240	swells .....	110
Black kid gloves.....	176	one pot will not boil in another .....	113
lead .....	232	retarded by a spoon	113
prevents rust ..	232	" by salt, sugar	114
mist.....	137	without touching the boiler.....	114
skin.....	178	Boiling point .....	115
tea-pot .....	184	Boots hot when dusty	181
used by cotters	184	Bottled ale, &c. ....	248
set on a hob to draw .....	184	Brackish water unfit for railway engines ....	237
will never blister..	178	Bracing weather.....	140
Blacksmiths strike fire by nails ..	95	Bread heavy .....	258
Bladders inflated by heat .....	102, 269	made with yeast	257
BLAZE, blue.....	50	Breath exhaled .....	223
green.....	50	inhaled.....	221
yellow.....	50	visible in winter	200
between the bars of a grate....	50	Breathing described ..	224
Blazing coals burn quickly.....	44	difficult on a moun- tain .....	229
Blood .....	222, 238	previous to a storm	229
purple.....	222	BREEZE at watering places .....	291
		evening.....	290
		land .....	291

	Page		Page
Breeze, morning.....	289	Candle-flame purple be-	
of islands.....	291	low.....	76
sea.....	290, 291	tends upwards	77
speed of.....	293	yellow.....	75
( <i>see wind.</i> )		Candles, gas of....	84, 262
Bricks for cold feet ...	162	held at a door	270, 271
Brick stoves .....	163	hottest <i>above</i> the	
Bricklayers cannot work		flame.....	78
in a frost ....	334	give light.....	75
cover work with		make glass damp	78
straw.....	334	need snuffing ....	80
Bright day exhilarating	137	Palmer's.....	80
Brilliancy.....	339	prevent our seeing	
Brine retards boiling..	114	abroad .....	352
tested .....	335	reflected in a win-	
Britain cloudy.....	123	dow.....	352
Broth cooled by breath	227	rekindle quickly..	55
by convection	228	rush, easily go out	78
by stirring ..	228	shadow cast by ..	352
Bubbles in tea.....	387	smoke of.....	81
of boiling water	111	spirt .....	146
Bulk for bulk.....	107	suddenly introduced	
Burns cured.....	148	give pain.....	339
Burnt stick twisted ..	374	wax, need no snuf-	
Burning glasses .....	10	fing .....	80
Calcutta, black hole of	210	Candlestick rags catch	
Calcareous.....	225	fire spontaneously..	61
Caloric .....	9	Cannon balls hot .....	101
Cambric handkerchiefs		boring.....	100
cool .....	172	Canvass flower-awning	191
Camphor antiseptic ...	389	Capillary attraction	75, 172
CANDLES.....	74		388
burn.....	74	vessels .....	83
cotton, not easily		Captain Ross.....	381
blown out .....	78	Capuchin.....	317
easily blown out	55, 77	Carbon.....	40, 74
extinguished.....	79	in the blood....	238
by a pin .....	81	Carbonate of ammonia	454
breath.....	77	of lime ....	454
paper .....	79	CARBONIC ACID GAS	43, 238
flame blown out ..	55	absorbed by leaves	225
hot .....	76	accumulation of,	
hollow .....	76	prevented.....	246
pointed.....	77	deleterious ..	238
		detected.....	239

	Page		Page
Carbonic acid gas dis-		CHEMICAL ACTION . . . . .	36
sipated by red heat	246	Chestnuts crack when	
in human bodies..	84	roasted . . . . .	102
of the soil . . . . .	225	not if slit . . . . .	103
sources of . . . . .	245	Chimney pots . . . . .	70
CARBURETTED HYDROGEN		flues long . . . . .	64
GAS . . . . .	263	" short . . . . .	64
Carpenters' tools hot..	99	raised above a	
Carpets warm . . . . .	157	house . . . . .	64, 68
Carriage in a storm ..	26	CHIMNEYS SMOKE . . . . .	63
wheels catch fire	98	if a room be too	
windows misty .	197	close . . . . .	63
Casks charred . . . . .	72	remedy . . . . .	64
Cart-grease . . . . .	98	in old farm houses	69
Cathedral aisles famous		valleys . . . . .	67
for echoes . . . . .	384	in wind . . . . .	70, 108
CATS in wet weather ..	140	if too long ..	64, 108
prowl by night ...	342	Chimneys smoke if too	
rub their ears . . . .	142	short . . . . .	64
sec in the dark ...	341	remedy . . . . .	66
wink before a fire	342	large . . . . .	69
Cattle low in wet wea-		remedy . . . . .	70
ther. . . . .	140	when the draught	
in a storm . . . . .	25	is slack . . . . .	65, 69
Caustic lime . . . . .	390	when the door is on	
lunar . . . . .	454	the same side ..	68
Caverns famed for ech-		remedy . . . . .	68
oes . . . . .	383	when they need re-	
Ceilings sooty . . . . .	71	pairing . . . . .	69
Cellars cold in summer	231	sweeping . . . . .	69
warm in winter	231	when two fires are	
Cerebellum . . . . .	391	in one room . . . .	67
Cerebrum . . . . .	391	remedy . . . . .	67
Chalk . . . . .	454	China broken by hot	
Champagne acid . . . . .	248	water . . . . .	120
CHARCOAL . . . . .	72	Chlorophyll . . . . .	372
bad conductor . . . .	156	Choke damp . . . . .	244, 261
fire very hot . . . . .	72	Church bells heard at a	
" deleterious . . . . .	245	distance 139, 380	
purifies water . . . .	72	congregation drowsy	241
removes taint . . . .	72	Churchyards smell offen-	
Charring bread . . . . .	73	sively . . . . .	265
casks . . . . .	72	Chyle . . . . .	221
wood . . . . .	73	Chyme . . . . .	221

	Page		Page
Cinders, iron .....	48	Clouds, distance from	
lighter than coals	48	the earth .....	123
soon heated .....	48	edges most lumi-	
will not blaze....	52	nous .....	369
Cirro-cumulus clouds	130	electrical .....	125
Cirro-stratus clouds...	130	fall in rainy wea-	
Cirrus clouds .....	128	ther.....	315
Citizens pale .....	222	fantastic .....	131
Citric acid .....	454	float.....	123
City air unhealthy ....	242	gather round hills	132
Clay for furnaces ....	163	height of.....	12, 124
Clean kettles.....	174	highest.....	124
Cleanliness connected		highest in a fine day	115
with the dietary	93	increased by wind	166
poverty.....	93	intermediate .....	130
Clear day overcast....	285	light .....	115
fire burns slowly ..	41	lowest.....	124
nights exhilarat-		morning red.....	127
ing.....	137	motion of.....	127
Clocks heard at a dis-		nimbus .....	131
tance.....	380	rain indicated by .	131
Close rooms unhealthy	240	red .....	126, 369
Cloth collects but little		round mountain-	
dew.....	143	tops.....	132
Clothes gather damp in		simple.....	128
summer .....	195	size of.....	124
wet .....	148	stratus .....	129
Clothing for workmen	154	sun-set .....	133
loose, warmest....	165	thickness of.....	124
promotes warmth	164	how ascertained	124
want of makes dirt		thunder .....	15
agreeable .....	93	vary in shape....	124
Cloudiest countries ...	123	in color .....	127
Clouds .....	122	where most abund-	
absorbed by wind	125	ant.....	123
cause of .....	122	where least .....	123
cirro-cumulus .!	130	use of .....	132
cirro-stratus .....	130	velocity of.....	294
classes of .....	128	wind affects them	
color of .....	124, 126	123, 125	
compound .....	130	yellow .....	133, 134
cumulo-stratus ...	131	indicate wet.....	134
cumulus .....	129	Cloudy night warm ...	189
differ from fog	122, 209	oppressive ...	137
dissipated ...	125, 133	Coal gas.....	74, 262



INDEX.

461

	Page		Page
Coal mines explode...	262	COMPRESSION .....	100
Coals black .....	371	differs from con-	
blazing .....	44	densation .....	99
grotesque figures of	46	CONDENSATION .....	99
for fuel .....	48	Condensed air .....	269
smoke .....	45	CONDUCTION .....	55
Coffee, spontaneous		not absorption..	173
combustion of....	61	CONDUCTORS, best....	56
Coke .....	59	worst .....	56
for fuel .....	48	animal fluids...	20
spontaneous com-		not absorbers ..	173
bustion of.....	60	of lightning....	27
COLD WEATHER affects		dangerous .....	29
the barometer		CONVECTION .....	202, 213
299, 306		Convective currents	226, 270
makes us love fat	89	cool broth .....	228
activity.....	90	iron .....	227
out of doors.....	293	Cooking vessels with	
promotes hunger .	90	wooden handles ....	156
Colder some things than		Cooper applies hot	
others.....	155	hoops .....	117
Colds from wet clothes	149	Copper for conductors	28
Collapsing.....	104, 269	sonorous .....	378
Color of clouds.....	123	tarnishes .....	233
electricity ...	35	Cork driven out by heat	106
Colors .....	364	Cornea .....	360
accidental .....	375	Corns ache in wet wea-	
dark, warm ....	175	ther.....	230
light, cold .....	175	Corpse cold .....	94
vary .....	370	Corrosive sublimate..	396
Combining not mixing	31	Cotton bales catch fire	60
COMBUSTION ( <i>see fire</i> )..	83	spontaneously.	60
animal .....	84	candles hard to	
cause of.....	43	blow out ....	78
chemistry of... 40,	43	handkerchiefs hot	172
from fermentation	60	oiled transparent .	373
elements of .....	43	Countries most cloudy	123
heat of .....	40	least cloudy	123
increased by wind	55	Country air salubrious	
in the veins.....	84	223, 242	
produces light....	51	Countrymen enjoy	
spontaneous ... 60,	84	health.....	242
COMMUNICATION OF HEAT		ruddy .....	222
	155	Cowls.....	67, 108
Compound clouds ....	130		

	Page		Page
Crowds dangerous in a storm .....	21	Dark colors warm .....	175
produce drowsiness .....	212	radiate heat ..	188
head-ache ..	239	Davy, Sir H. ....	263
vitate air .....	239	Day - light produces	
unhealthy .....	210	hunger .....	88
Crucibles made of platinum .....	236	mitigates cold ..	88
Culinary vessels .....	186	Dead bodies cold .....	94
have wooden handles ..	156	smell .....	266
should be sooty ....	186	taller than living ..	390
Cultivation promotes		Deafness .....	382
dew .....	191	Decanting liquor .....	256
warmth ...	152	spiriting ..	266
Cumulo-stratus clouds ..	131	Decomposition .....	246
Cumulus clouds .....	129	Deep water freezes	
Cup in a pie .....	116	slowly .....	331
use of .....	117	Depression of spirits ..	137
why full of juice ..	117	Descent in a diving bell	
Currents of air .....	270	painful .....	138
Damp balusters .....	200	Deserts hot and dazzling	374
beds .....	149	Detonating powder ...	101
clothes .....	195	Dew .....	188
house .....	200	cause of .....	209
Dandelion forebodes		deleterious .....	203
rain .....	142	differs from rain ..	209
DANGER IN A STORM ...	18	distilled after a hot	
in attics and cellars ..	22	day .....	202
a crowd .....	25	especially if the	
in a theatre, &c. ...	25	wind be westerly ..	202
before a fire .....	25	in fine nights only ..	189
near a tree .....	19	distilled unequally ..	192
in a river .....	19	in open places ....	190
flocks and herds are		in valleys and hollows	191
exposed to .....	25	on clothes .....	195
those who bar		cultivated lands ..	194
shutters .....	24	grass .....	194
those who drive		hair .....	201
fast .....	21	hat .....	201
lean against a		leaves, &c. ....	193
wall .....	23	none beneath a tree ..	190
or carriage. ..	26	a flower awning ..	191
who ring bells ..	19, 23	a hedge or wall ..	191
run .....	21	none in a cloudy night	189
		in a windy night ..	191
		especially if	
		easterly ....	201

- |                          | Page     |                          | Page     |
|--------------------------|----------|--------------------------|----------|
| Dew, none on stones,     | 191      | Dry wood burns best..    | 106      |
| cloth, deserts grav-     |          | snaps about..            | 106      |
| el, metal, rocks,        |          | Driest moulds.....       | 307      |
| wool .....               | 191      | Dublin, race of .....    | 317      |
| Dew drops round.....     | 205      | Duck dry in water....    | 206      |
| flattened.....           | 205      | noisy before rain        | 141      |
| roll on cabbages         | 205      | Dullness.....            | 339, 371 |
| " roses                  | 206      | Drughills hot.....       | 258      |
| Digestion.....           | 90       | Dusty shoes hot.....     | 181      |
| Dinner covers.....       | 187      | Ear trumpets .....       | 382      |
| Dirt warm.....           | 93       | Earth, bad conductor.    | 170      |
| Distant bells heard....  | 380      | cool in summer... 170    |          |
| clocks.....              | 381      | cool after sun set       | 189      |
| objects appear small     | 354      | in a fine night          | 189      |
| sight .....              | 361, 363 | cracks by frost... 332   |          |
| spectacles for           | 362      | crumbles in spring       | 333      |
| Distance makes things    |          | warm in winter... 170    |          |
| invisible.....           | 357      | warmer than air          |          |
| Distilled vinegar .....  | 454      | by day .....             | 189      |
| Divers suffer paine 138, | 230      | Earth fog.....           | 201      |
| Diving bell .....        | 138      | Earthen tea-pots .....   | 181      |
| Doors swell and shrink   | 143      | set on a hob to draw     | 181      |
| Dogs uneasy in wet       |          | Eat more in cold wea-    |          |
| weather .....            | 140      | ther.....                | 90       |
| Dough fermented.....     | 267      | less in warm wea-        |          |
| set before fire to rise  | 258      | ther.....                | 90       |
| Double concave glasses   | 361      | Echo.....                | 383      |
| convex glasses....       | 362      | Echoes, two or more..    | 385      |
| Down warm.....           | 165      | remarkable .. 385        |          |
| Draining lands promote   |          | EFFECTS OF HEAT .....    | 101      |
| warmth .....             | 151      | EFFERVESCENCE .....      | 217      |
| Draught at a door....    | 291      | boile subsides           | 257      |
| key-hole..               | 291      | Effervescing draughts.   | 217      |
| window..                 | 291      | Egg, component parts of  | 254      |
| slack.....               | 65, 23   | discolours silver spoons | 254      |
| Drums .....              | 390      | new laid, cold.....      | 167      |
| Driving in a storm       |          | stale, warm.....         | 167      |
| dangerous .....          | 21       | " smells offensively     | 254      |
| Drops of rain roll on    |          | tests brine.....         | 335      |
| dust .....               | 206      | tested .....             | 167      |
| Drowned men restored     | 99       | Egypt not cloudy.....    | 123      |
| Drowsiness at church..   | 212      | Elacrimery affects the   |          |
| Drums .....              | 379      | clouds ... 125, 127      |          |
| Dry toast for invalids,  | 73       | excited by friction      | 34       |
| wood for kindling        | 49       |                          |          |

	Page		Page
Electricity felt at the		Eyes affected by sud-	
elbow joints . . . . .	34	den light . . . . .	339
hot . . . . .	34	affected by the sun	375
odor of . . . . .	35	black . . . . .	179
of clouds . . . . .	11, 127	cornea of . . . . .	360
positive and nega-		retina of . . . . .	360
tive . . . . .	22	two, use of . . . . .	343
resinous and vitre-		" see single . . . . .	343
ous . . . . .	11, 23	Face soon scorched . . .	182
source of heat . . . . .	11	Fanning . . . . .	167, 293
Electric telegraph . . . . .	36	Far sight . . . . .	361, 363
Elements of air . . . . .	40	spectacles for . . . . .	362
of fuel . . . . .	40	Farm-houses smoke . . .	69
Emetic tartar . . . . .	454	Fat men swim best . . .	337
Epsom salts . . . . .	454	Fat pleasant in winter	89
Esquimaux love blubber	91	not in summer . . . . .	91
Equatorial current . . . . .	278	Feathers warm . . . . .	165
ETHER . . . . .	51	Feeling . . . . .	392
boiling point of . . . . .	115	Feet cold before a fire .	57
used for freezing . . . . .	335	wet dangerous . . . . .	148
" inflammation,		FERMENTATION . . . . .	249
scalds, burns . . . . .	148	differs from pu-	
vaporized . . . . .	148	trefaction . . . . .	252
European skin white . . . . .	178	of dough . . . . .	257
EVAPORATION . . . . .	147	produces com-	
freezes . . . . .	335	bustion . . . . .	60
of sea . . . . .	276	requires water . . . . .	155
EVENING CLOUDS . . . . .	126, 133	Fender and fire-irons	
grey . . . . .	135	cold . . . . .	173
red . . . . .	126, 133, 370	Fiddle-strings musical	378
yellow . . . . .	133, 234	snap from wet . . . . .	316
Evergreens frost-bitten	212	Fine weather braces . . .	140
Ewers broken by frost . . . . .	325	indications of . . . . .	134
EXPANSION by HEAT . . . . .	101, 117	Finger feels cold when	
Explosion of roasted		wet . . . . .	148
chestnuts . . . . .	102	FIRE . . . . .	39
of gunpowder . . . . .	103	air needful for . . . . .	63
of mines . . . . .	263	bellows, use of . . . . .	55
Extinguishers . . . . .	79	black and red . . . . .	44
made of paper . . . . .	79	blazes . . . . .	44
Eyes adapt themselves		not in frost . . . . .	52
to light . . . . .	340	burns blue . . . . .	141
affected by blue		cause of . . . . .	43
glasses . . . . .	375	charcoal . . . . .	72
affected by fire-light	374		

	Page		Page
Fire, charcoal danger-		Fishes ascend and dive	338
cus .....	245	seem nearer than	
clear .....	44, 53	they are .....	359
damp .....	261	cold .....	93
differs from animal		FLAME of a CANDLE ...	75
heat .....	85	described .....	76
dull, cause of ....	65	blown out easily..	77
effect upon the		damp .....	78
eyes .....	341, 374	hollow .....	76
extinguished ....	57	hot .....	75
by water 57,	106	hottest above ....	78
fiercest in winter .	53	luminous .....	75
out of doors..	54	pointed .....	77
gas generated by	84	purple and yellow	76
grotesque figures		smokes .....	81
in .....	46	Flame of a fire between	
heat of .....	258	the bars of a grate	50
how increased 53,	63	blue .....	50
hot .....	44	green .....	50
kindled at the bot-		Flame yellow .....	50
tom .....	47	Flannel warm .....	93
lighted with paper		used for foot-warm-	
and wood .....	46	ers .....	93
light dazzles .....	340	Flash, <i>see lightning</i> .	
light variable ....	52	Flat beer, &c. ....	255
luminous .....	50	iron .....	147
melts metal .....	121	Flavor discerned by the	
mottled .....	45	taste .....	392
out of doors .....	45	Flax burns spontane-	
poker draws up ..	56	ously .....	60
radiates heat. ....	182	Flint and steel strike	
red hot .....	44, 330	fire .....	96
reflected on win-		Flocks dangerous in	
dows .....	352	storms .....	25
spotted .....	45	FLOWING WATER freezes	
sun dulls it .....	53	slowly .....	329
thaw dulls it .....	55	makes rough ice..	330
wind intensifies it ..	55	oscillates .....	324
<i>See combustion.</i>		pure .....	324
Fire-irons cold ....	161, 174	Flower awnings arrest	
hot .....	174	dew .....	190
rust .....	231	purify air .....	232
" most in win-		Flowers smell sweetest	
ter .....	232	at night, and	
" prevented .	232	before rain. ....	144

	Page		Page
Flowers forebode rain	142	Friction excites electri-	
Flues .....	64	city .....	34
blacked .....	183	sets forests on fire	99
long, good for		Frogs cold .....	94
draught .....	66	croak before rain	141
short, bad " .....	65	Frost affects barome-	
<i>See chimney.</i>		ter .....	299
Flutes .....	379	" sound ..	380
Fly poison .....	390	braces .....	140
Foam, white .....	371	breaks ewers .....	325
Fogs .....	208	" tiles, stones, rock	325
arrest sound .....	381	" pipes .....	327
cause of .....	123	cracks earth .....	332
differ from cloud		" mortar .....	333
122, 209		expands water .....	325
mist .....	209	on windows .....	220
dispersed by wind	210	prevents fog .....	209
dispersed by sun	209	stops work .....	334
frozen .....	212	warmer than thaw	332
in autumn .....	209	Froth of beer ....	107, 248
increase distance .	141	of fermentation ..	255
in marshes .....	208	white .....	372
in valleys .....	210	Frozen water warm ..	330
magnify .....	141	ruts and foot-prints	326
none in a frosty night	209	Fruits cool the blood ..	92
Food converted to blood	221	fall to the earth ..	388
cooled by the		pleasant in summer	91
breath .....	293	Fuel, dry burns well ..	49
Food, want of, produces		elements of .....	40
hunger .....	89	for the body .....	86
want of, produces		wet burns badly ..	49
laziness .....	89	Fulgurites .....	35
aversion to clean-		Fumigation for sick	
liness .....	93	rooms .....	389
" to ventilation	93	Furnel ( <i>see flues</i> ) ....	64
Foot-prints frozen ....	325	FUR, bad conductor ..	156
Foot warmers .....	162	for clothing .....	164
Forked lightning .....	12	warm .....	165
Forests catch fire spon-		Furnaces of brick ....	163
taneously .....	99	lined with clay	163
cold .....	152	Furr of kettles .....	236
France warmer than of		steam-engines dan-	
yore .....	153	gerous .....	237
FREEZING MIXTURES ...	335	Gallery hot .....	229, 296
FRICION ( <i>see rubbing</i> )	97		

	Page		Page
Gas. ....	74, 109,	195, 225, 283, 289, 328,	333
differs from liquid	220	Gold never tarnishes..	235
elastic. ....	220	Goodness ( <i>see wis tom</i> ).	
invisible. ....	219	Grape sugar. ....	249
jet of. ....	79	Grape juice needs no	
of candles. ....	263	yeast. ....	254
Gauze wire of safety-		ferments. ....	249
lamps. ....	264	makes alcohol. ....	250
prevents explosion	264	" carbonic acid	250
Geese noisy before rain	141	Grapes never ferment .	254
German silver tarnishes	235	Grass promotes cold ..	152
tinder. ....	100	collects dew. ....	194
Germany warmer than		Grate ( <i>see stoves</i> ),	
of yore. ....	153	Gravel collects no dew	194
Germination. ....	288	Gravity. ....	387
Ghosts. ....	266	Gray morning, sign of a	
Gideon's miracle. ....	195	fine day. ....	134
Ginger-pop. ....	248	evening. sign of wet	135
acid. ....	248	GREASE liked in cold	
GLASSES broken by hot		weather. ....	89
water. ....	119	loathed in hot. ....	91
broken if set on a		prevents rust. ....	145
hob. ....	120	used for wheels ..	98
covered with mist	198	Green color. ....	372
" if brought from		wood does not burn	105
cellar. ....	199	" does not snap	
dulled by a hot		when burned	205
hand. ....	198	Grottoes famous for	
" by breath, &c	199	echoes. ....	383
mist of, soon sub-		Ground frost. ....	209
sides. ....	193	Growth promoted by	
<i>See spectacles.</i>		moonlight. ....	203
Glass a reflector. ....	352	Guinea fowls squall be-	
soon cools. ....	196, 122	fore rain. ....	141
ground not trans-		Gulls fly to sea. ....	145
paren'. ....	173	to land. ....	145
<i>See looking-glass</i>		Gunpowder explodes..	103
Glauber salts. ....	454	Gusty weather makes a	
Gloves, black HJ. ....	176	smoky house. ....	70
Lisle thread. ....	176	HAIL. ....	312
Glow-worms <i>güsten</i> by		accompanied with	
night. ....	342	thunder. ....	313
Gluten. ....	251	Hail, cause of. ....	313
ferments. ....	252	falls in summer..	313
God's wisdom 153, 166, 193			

	Page		Page
Hair, bad conductor ..	156	HEAT, LATENT.....	38, 95
covered with dew	201	of candles .....	75
warm .....	165	dunghills .....	253
Halls famous for echoes	384	fire .....	258
Halo round the moon	136	ice .....	38
Handles, wooden .....	156	human bodies 84,	258
metal .....	156	lime .....	265
Hard work promotes		radiates .....	182
hunger .....	87	reflection of.....	179
water bad for wash-		sensation of.....	9
ing.....	234	sources of ∴ 10 to	101
Hartshorn .....	253	Heating rooms by stoves	
Hat covered with dew	200	103, 183	
turned red at the		by steam ....	183
sea-side .....	320	Heavy bread .....	258
Hawks see near and far	363	Hemp, spontaneous com-	
Hay-stacks catch fire		bustion of .....	60
spontaneously.....	61	Herds dangerous in	
Haze round the sun... 136		storms .....	25
" the moon 136		Hedges increase warmth	152
affects sound .....	381	Hills larger in a fog... 141	
Head aches in a crowd 239		seem more distant 141	
itches in wet weather 142		HOAR FROST ..... 211	
Hearth-rug warm .... 159		not found on trees 212	
Hearth-stone cold .... 159		under shrubs, &c. 212	
hot..... 160		of frozen fog..... 212	
HEAT..... 9		on clear nights only 211	
absorbed .....	37	" grass .....	211
and light .....	51	" tombstones..... 177	
affects barometer. 302		very partial..... 211	
" sound .....	380	HONEY-DEW .....	203
animal ... 83, 223, 258		Honey-dew, ants fond of 204	
applied to the bot-		effects of .....	203
tom of boilers .. 214		injures plants .. 203	
communication of 155		Hoops used red-hot... 117	
conduction of .... 155		Horizontal sun and	
effects of ... 10 to 101		moon.....	350
evolved..... 37		Horses strike fire..... 97	
" by compres-		snuff up air .... 144	
sion..... 100		uneasy in dull	
expands air .....	102	weather .....	141
expands water.... 334		Hot, cloudy night op-	
from beaten iron . 94		pressive .....	137
increased by accu-		Hot water .....	187
mulation .....	60	melts sugar .... 323	



	Page		Page
<b>Hot</b> weather abates activity.....	92	<b>IRON</b> affected by lighting .....	36
abates appetite.	91	cinders .....	48
produces love of fruit ....	91	cold.....	159
“ dislike of grease... ..	91	contains latent heat	95
<b>Hottest</b> place at church	229, 296	cooled by air ....	227
<b>Houses</b> catch fire spontaneously .....	59	“ convection	227
gather damp ...	200	“ radiation .	227
seem more distant in a fog	141	good conductor... ..	173
smoke in valleys	67	heated by blows..	94
<b>Hull</b> of ships seen last	358	rust .....	231
<b>Hunger</b> .....	87 to 91	“ when most common.....	231
promoted by cold	90	“ prevented.....	232
“ day-light .....	88	“ scales .....	231
“ rapid digestion .	90	sonorous .....	378
“ singing, speaking, work....	88	stoves.....	163
<i>See appetite.</i>		<b>Ironing</b> box.....	147
<b>Hydrogen</b> gas.....	40, 74	<b>Islands</b> equable in temperature .....	291
of fuel .....	220	subject to wind... ..	290
<b>ICE</b> .....	325	warm .....	291
contains heat ....	38	<b>Itching</b> in wet weather	142
dissolved by acids	332	<b>Jack o'-lantern</b> ( <i>see ignis fatuus</i> ) .....	266
friction	99	<b>Java</b> ( <i>see jungles</i> ) .....	241
salt ...	332	<b>Jet</b> of flame through bars.....	50
sun ...	121	<b>Judges</b> vi. illustrated .	195
grows thicker....	329	<b>Juice</b> of lemons .....	454
lighter than water	325	<b>Jungles</b> of Hindostan fatal .....	241
<b>Ice</b> -bergs famous for echoes .....	384	<b>KETTLE</b> boils over ....	111
<b>IGNIS FATUUS</b> ....	266, 267	quickly if covered with soot .	174
cause of .....	266	slowly if clean..	174
<b>Impure</b> water purified	72	“ if new... ..	174
<b>Indian</b> mode of striking fire.....	97	bottom should be sooty.....	185
<b>Inflammable</b> air....	40, 74	cold when water boils .....	186
<b>Insects</b> in wet weather	145	furr of. ....	236
<b>Insensible</b> perspiration	197	holder.....	157
<b>Intermediate</b> clouds... ..	130		

	Page		Page
Kettle-lid clean.....	185	Leaves in a pond.....	387
hot.....	186	light green in spring	372
Kettle not full after		pale in dark places	372
boiling.....	111	promote cold....	152
runs over.....	111	yellow in autumn	372
through the spout	112	Lemons, juice of.....	454
sings.....	109	salt of.....	454
steam of.....	216	Lid of kettle bright...	185
top bright.....	185	hot.....	186
Kid gloves.....	176	rattles...	112
Kilkarney, echo of....	386	Light bread.....	257
Kindling fires.....	46	colors cool.....	175
dry.....	49	LIGHT.....	51, 338
wet.....	48	absorbed.....	339
Ladies fan.....	289	composed of vari-	
Lakes which never		ous colors 364,	370
freeze.....	331	divided by a prism	364
Lamps.....	74	from a flint.....	96
Argand.....	82	compression.....	100
smoke.....	82	of candles.....	76
spirit.....	149	fire.....	50, 52
<i>See candle.</i>		houses, trees, &c.	338
Lamp-glasses.....	82	the sun.....	338
Land air cold.....	207	reflected.....	339
Land breeze unhealthy	290	speed of.....	337, 338
cools faster than		sudden, painful...	339
water.....	207	Lighting fires.....	46
Laplanders clad in skin	171	LIGHTNING.....	11
Larvæ.....	146	affects iron & steel	35
LATENT HEAT.....	38, 95	' electric tele-	
Laundress.....	147	graph.....	36
Laziness caused by want		balls.....	13
of food..	89	barks & snaps trees	34
by heat....	92	clouds.....	12
Lead, dullness of.....	234	comes from clouds	22
tarnish of.....	234	" from earth.	22
Leanness from starva-		conductors.....	28
tion.....	86	dangerous.....	29
LEAVES absorb carbonic		followed by rain..	17
acid.....	225	" by wind...	17
collect dew une-		follows dry weather,	
qually.....	192	not wet.....	33
exhale oxygen ...	224	forked.....	12
green.....	372	fuses metal.....	32
		kills animals.....	14

	Page		Page
<b>Lightning</b> knocks down		Liquids heated .....	214
houses, churches,		not elastic .....	220
&c. ....	29	Lisle thread gloves ...	176
magnetic .....	36	LONDON FOG .....	208
maims .....	14	Long flues .....	107
odor of .....	35	grass promotes cold	152
passes down the out-		Logs, two burn better	
side of a tree ..	20	than one .....	49
passes through the		<i>See wood.</i>	
inside of animals	20	Looking-glass .....	343
produces fulgurites	35	a reflector .....	343
purifies air .....	33	reflects our image	
rare in winter ....	33	approaching, &c.	345
returning stroke ..	23	reflects our whole	
scorches trees ....	34	person .....	345
sheet .....	13	Lueifer matches .....	265
speed of .....	18	Lunar caustic .....	454
straight .....	13	Lungs described .....	224
summer .....	17		
common in ..	33	Mackarel seales, &c. ..	130
turns beer sour ..	32	Maekintosh prevents	
milk sour ....	30	cold .....	149
not old beer ..	32	Madness from starva-	
not porter ...	32	tion .....	86
two flashes .....	13	Magnetic effects of light-	
<i>See danger, safety.</i>		ning .....	36
<b>Lilac steel</b> rusts .....	233	Magpies indicate wea-	
prevented .....	233	ther .....	145
<b>LIME</b> and water ...	31, 37	Malt .....	252
burned .....	260	Malting .....	251
hot .....	260	Man a swimmer .....	337
purifies bins 259,	389	fat, swims best ...	337
"  sewers 259,	389	no bigger than a	
quick or caustic ..	260	crow .....	355
<b>Lime-wash</b> for rooms	389	Marble .....	454
<b>Line</b> of incidence ....	344	<b>MARCH</b> comes in like a	
of reflection .....	344	lion .....	287
<b>Linen</b> cool wear .....	171	goes out like a	
dried .....	151, 295	lamb .....	287
<b>Linseed</b> oil, boiling		dry good, wet	
point of .....	115	bad .....	288
<b>LIQUEFACTION</b> .....	121	flowers undesira-	
<b>LIQUIDS</b> .....	109	ble .....	288
bad conductors;	213	use of .....	287
cooled .....	215	wind dry .....	287

	Page		Page
Mares' tails .....	131	Mist increases distance.	141
Marsh gas .....	261	magnifies .....	141
Marsupium .....	363	on windows.....	196
Mast of ships seen first	358	seems to rise.....	206
May flowers .....	288	vanishes at sunrise	
MEAT COVERS .....	188	205, 209	
Meat liked in cold wea-		white .....	137
ther.....	90	Mixing not combining	30
loathed in hot....	91	Money hot in a pocket	158
roasted by reflect-		Monsoon.....	280, 282
ors.....	180	Months, driest .....	307
taint removed....	389	wettest .....	307
tainted by moon-		MOON, distance and size	356
light .....	203	largest at horizon.	350
MECHANICAL ACTION... 94		reflected in water.	349
Mercury of barometer.	297	seems flat.....	356
boiling point of.	115	larger than stars	356
bright.....	235	Moonlight makes plants	
concave .....	304	grow .....	203
convex .....	304	taints meat ..	203
its rise & fall, 303 to	308	MORNING breeze.....	290
rises from heat... 119		gray .....	134
METAL collects no dew	193	rainbow .....	135
conductors.....	156	red....127, 134,	369
feels colder than		streaks .....	127
wood.....	158	MORTAR .....	260
hotter than wool	157	adhesive.....	260
fused by fire .....	121	crumbles .....	333
by lightning	32	hardens .....	260
good conductor... 156		Motes in a sunbeam ..	228
handles burn.....	156	Mould hardened by sun	153
reflectors .....	180	Mountains cloudy ....	132
tea-pots .....	184	cold .....	181
Milk long in cooling ..	216	collect rain.....	316
soured by lightning	30	famous for echoes	384
Mineral springs.....	320	impede respiration	229
Miners' danger .....	264	noiseless .....	383
prevented	239	Muriate of soda .....	454
Mirror .....	343	Murky nights oppres-	
Mist arrests sound ... 381		sive .....	137
black.....	137	Musical instruments ..	379
cause of.....204, 206		flat..	386
differs from cloud	122	glasses .....	379
dew .	204	notes.....	379
fog..	209	sounds .....	377

	Page		Page
Myrrh antiseptic .....	389	Old people lose their	
Nails for matches .....	95	power of walking	392
Naves fitted on hot ...	118	spectacles for ..	362
Near-sight .....	360, 363	One pot will not boil in	
spectacles for	360	another .....	113
Negative electricity ...	22	how to make it	
Negroes, why black ...	178	boil .....	114
with black eyes	179	Out-of-door work pro-	
New kettles boil slowly	174	duces hunger ....	89
Night allays hunger ..	88	Owls prowl at night ..	342
exhilarating .....	137	see in the dark ..	341
oppressive .....	137	sleep all day ....	341
produces cold ....	88	screech before rain	141
rainbow at .....	135	Oxalic acid .....	396
warm, when cloudy	189	Oxide of copper .....	233
Nimbus clouds .....	131	iron .....	231
Nitrate of silver .....	454	lead .....	234
Nitric acid .....	30, 33, 454	Oxide of platinum ....	235
Nitrogen .....	42	potassium ...	236
expired ....	224, 239	silver .....	234
of air .....	221	sodium .....	236
Nitrogenized .....	254	Oxidised .....	222
Non-transparency .....	373	Oxygen .....	41
North wind cold .....	284	exhaled by leaves	226
dry .....	284	heats the blood ...	223
North-west wind dry	286	in the blood .....	238
	299	inhaled .....	222
Northern lights .....	135	makes blood red ..	223
Notes, bass .....	379	“ fuel burn ..	220
flat .....	380	of air .....	96
sharp .....	380	its use .....	220
treble .....	379	supports combus-	
November rainy .....	289	tion .....	97, 220
		sustains life .....	221
Odor of electricity ....	35	Ozone .....	35
Oil, elements of .....	74	Paleness .....	222
linseed, boiling point		Palmer's candles .....	80
of .....	115	Paper burns .....	46
of turpentine ....	115	not always	49, 57
of vitriol .....	454	extinguishers ....	79
Oiled paper transparent	373	oiled, transparent.	373
Old people far-sighted	361	puckers from wet.	317
hold objects at a		used for kindling .	46
distance .....	363	Papillæ .....	392

	Page		Page
Paris, plaster of .....	454	Poison for flies .....	390
Parlors smell of smoke in summer .....	71	Poker draws up fire ..	56
Partition walls to arrest sound .....	382	hot against a stove	173
Pea-soup fog .....	207	cold on a fender	161, 173
Peacocks forebode rain	141	how to carry it	
Pearl divers deaf .....	139	when hot .....	217
<b>PERCUSSION</b> .....	94	Poker rusts .....	232
<b>Perspiration</b> .....	88, 197	rust of, prevented	232
<b>Petals</b> .....	370	Polar current .....	278
<b>Petrels</b> .....	146	Polish, use of .....	163
<b>Petrifaction</b> .....	320	Polished metal tea-pots	184
<b>Phosphate of lime</b> ....	265	Ponds dried up .....	153
<b>Phosphoric acid</b> .....	43	Poor averse to cleanli- ness .....	92
<b>Phosphorus</b> .....	65	ventilation .....	93
<b>PHOSPHURETTED HYDRO-   GEN GAS</b> .....	265	lazy .....	89
<b>Piano fortes</b> .....	379	Pores of wood .....	105
<b>Pickle tested</b> .....	335	Porter, froth of ..	107, 248
<b>Pie with a cup</b> .....	116	set before a fire	107
full of juice .....	116	Porter, stale .....	255
<b>Pigs squeak before rain</b>	141	Porter vats dangerous	245
<b>Pimpernel forebodes   rain</b> .....	143	Positive electricity ...	22
<b>Pin puts a candle out</b>	81	Potatoes, green .....	372
<b>Pine snaps in fire</b> ....	105	yellow .....	372
<b>Pipes broken by frost</b>	327	Potash, tartrate of....	454
<b>Piston</b> .....	100	Potassium .....	236
<b>PLANTS collect dew</b> ...	192	burns in water	236
forebode rain ....	143	Primrose yellow .....	371
grow out of walls	296	Prisms divide light ...	364
after moonlight	203	Psalm cxlvii. 16, illus- trated. ....	164, 311
<b>Plaster of Paris</b> .....	454	Pump handle cold ....	158
of stoves falls		water hard ....	320
away .....	118	Purple steel rusts ....	233
<b>Plasterers cannot work   in frost</b> .....	334	its rust prevent- ed .....	233
<b>Plate warmer</b> ....	177, 180	<b>PUTREFACTION</b> .....	253
<b>Platinum, its use</b> .....	235	differs from	
never tarnishes	235	fermentation	253
<b>Ploughing promotes   warmth</b> .....	151	Putrefying bodies smell	
<b>Plumbago</b> .....	232	253, 266	
prevents rust	232	Quadrupeds swim ....	337
		Quick lime absorbs ear- bonic acid. ....	246, 266

	Page		Page
Quicksilver bright . . . .	235	Rainbow colors reversed	367
extinguished	454	Rainbows, two . . . . .	366
Quiet precedes storm..	139	Rain drops . . . . .	314
<b>RADIATION</b> . . . . .	182, 228	vary in size ..	314
cools iron . . . . .	228	Rain-water smells offen-	
Radiators are absorb-		sively . . . . .	322
ers . . . . .	182	fertilizing . . . . .	324
bad . . . . .	162	not salt . . . . .	323
Rags catch fire sponta-		soft . . . . .	321
neously . . . . .	60	stagnant . . . . .	323
especially candle-		unpleasant . . . . .	322
rags . . . . .	61	Rainy months . . . . .	318
Railway steamers . . . . .	201	Rare air bad for sound	383
water for . . . . .	237	Rattling of kettle-lid..	112
<b>RAIN</b> . . . . .	313	Ray of light divided ..	364
affected by wind..	315	Reading aloud produ-	
after lightning . . . . .	17	ces hunger . . . . .	88
arrests sound . . . . .	380	<b>RED</b> color . . . . .	222, 371
cause of . . . . .	209	rose . . . . .	371
clouds bode . . . . .	134	sky . . . . .	126, 369
cools air . . . . .	150	sun-rise . . . . .	127, 134
differs from dew..	208	sun-set . . . . .	134
dispels carb. acid..	246	Reflected light . . . . .	339
falls in drops . . . . .	314	<b>REFLECTION</b> of heat ..	179
fertilizing . . . . .	288, 315	in a mirror . . . . .	345
from passing clouds	315	in water . . . . .	346
heaviest in summer	318	<b>REFLECTORS</b> . . . . .	179
least at the poles..	313	help the roast . . . . .	181
most in mountain-		keep kitchen cool	181
ous places . . . . .	316	not absorbers . . . . .	180
most in winter	289, 318	should be clean and	
near the equator..	318	bright..	177, 179
not salt . . . . .	323	" not be painted	177
on dust . . . . .	206	<b>REFRACTION</b> . . . . .	358
cabbages . . . . .	206	Refrangible . . . . .	126
rose-leaves . . . . .	206	Resinous electricity . . . . .	23
prognostics of . . . . .	134	Retina . . . . .	360
from animals . . . . .	140	Returning stroke . . . . .	23
candles & fires	141	Reverberation . . . . .	383
clouds . . . . .	134	Rice for food . . . . .	92
flowers . . . . .	143	<b>RIVERS</b> flow slowest at	
purifies air . . . . .	315	sides . . . . .	324
sudden change . . . . .	302	freeze unequally	
<b>RAINBOW</b> . . . . .	364, 365	328, 326	
		invert our image	346

	Page		Page
<b>Rivers</b> never frozen at		Running water pure...	324
bottom .....	328	Rush lights easily blown	
not wholly frozen	329	out. ....	78
shallow, freeze		extinguished by	
fastest .....	330	a pin .....	81
seem shallower than		Rust.. .....	231
they are .....	359	prevented .....	232
warm if frozen....	330	when most trouble-	
<b>Roast</b> apples. ....	103	some .....	232
soft .....	103	Rustics healthy .....	242
chestnuts .....	102	Ruts frozen .....	326
<b>Road</b> dark from a light			
room .....	340	<b>SAFETY IN A STORM</b>	
<b>Rocks</b> collect no dew..	194	abroad....	25 to 27
broken by frost...	326	at a slight dis-	
<b>Room</b> cooled. ....	150, 295	tance from a tree	25
currents of air in a	270	best to be wet	27
ventilated .....	295	in a carriage....	26
vitiated by a crowd	295	in bed .....	27
warmed by fire ...	240	in doors. ....	26
<b>Rose</b> red .....	371	Safety lamp .....	263
<b>Rosneath</b> , echo of. ....	385	Sailors rarely catch cold	150
<b>Ross</b> , Captain .....	381	St. Bride's church de-	
<b>Rotation</b> of earth .....	272	stroyed by lightning	30
<b>Rotting</b> leaves promote		<b>SALT</b> .....	454
cold .....	152	and snow cold..	39, 332
<b>Rubbing</b> .....	98	and water boils	
<b>Rubbing</b> hands to warm		slowly. ....	114
them .....	98	crackles in a fire..	49
melts ice. ....	99	dissolves ice.....	332
restores suspended		dissolved by water	322
animation .....	98	especially by hot	
wood excites fire..	98	water .....	323
<i>See friction.</i>		flavors water.....	322
<b>Ruddiness</b> .....	223	of lemons .....	454
<b>Ruins</b> famed for echoes	383	retards boiling...	114
<b>Running</b> promotes		smelling. ....	454
warmth .....	87	white .....	372
in a storm dan-		water unfit for rail-	
gerous .....	21	way engines..	237
water freezes slow-		for washing....	320
ly .....	329	<b>Salts</b> , Epsom. ....	396
water makes.		Sand dazzling .....	374
rough ice .....	33	Saucepan boils best	
" oscillates....	324	when black.....	185



	Page		Page
<b>Saucepan</b> boils slowly		Shallow water soon	
when new....	185	freezes.....	330
lids should be		Sheep bleat before rain	141
clean and bright	185	in a storm.	25
rattle .....	112	lie under hedges	140
<b>Scald</b> cured.....	149	Sheet lightning.....	14
<b>Scripture</b> illustrated... 164		Sheets wet.....	149
	145, 311	Ships out at sea.....	358
<b>Scum</b> of fermentation..	255	hull of, last seen	358
<b>Sea-beach</b> healthy in		Shirts of linen.....	172
the morning....	290	Shoes cold when wet ..	148
not healthy at night	290	hot when dusty.	181
<b>Sea</b> before storm.....	139	Shot hot.....	101
gives out heat....	292	Shower cools air.....	150
heaves and sighs..	139	Shutters dangerous... 24	
less hot than land.	275	Sick rooms purified... 389	
not much heated		Sides of a pond covered	
by sun .....	275	with leaves.....	388
<b>Sea-gulls</b> .....	146	Sight affected by sud-	
<b>Sea-vapor</b> not salt.... 154		den light.....	339
<b>Sea-water</b> easier to swim		SILVER meat-covers... 188	
in than fresh... 335		should not be	
heavy and salt.... 323		chased ... 188	
rarely frozen.... 331		nitrate of..... 454	
" gives cold.. 150		tarnishes..... 234	
salt.....	323	Simmering .....	109
<b>Sea-waves</b> .....	292	Simple clouds.....	128
<b>Sedentary</b> pursuits abate		Singing of a kettle ... 110	
hunger .....	89	of boiling water	110
<b>SEEING</b> in a glass..... 343		produces hunger	88
into a dark street.	352	Single magpie unlucky 145	
" light room. 340		Size diminished by dis-	
ourselves in a small		tance.....	354
mirror .....	345	Skin, black, does not	
the same object... 339		scorch.....	176
when used to dark-		white does.....	179
ness.....	340	itches before rain.	142
<b>Sensation</b> destroyed .. 391		Sky blue.....	126
of feeling ... 391		Sleep elongates the	
of taste .....	391	body .....	390
<b>Sewers</b> purified by lime 259		body feels not in.. 391	
<b>Shade</b> cool.....	171	dreams in.....	391
<b>Shadow</b> in water... 345, 346		ears hear not in... 391	
<b>Shadow</b> larger as object		eyes see not in.... 391	
approaches a light.. 352		mind wills not in.. 391	

	Page		Page
Sleep, tongue tastes not		Soap-bubbles .....	368
in .....	391	ascend .....	325
Sleet .....	310	change color ...	368
Slit chestnuts .....	103	Soapy water bubbles..	325
Smelling salts .....	454	Soda, muriate of .....	454
SMELLS in wet weather	143	water .....	247
of bins and sewers	258	" acid .....	248
church-yards...	265	Sodium .....	236
putrefying bodies	253	decomposes water	236
SMOKE .....	45, 62	Soft soap .....	321
ascends .....	62	water for washing	321
curls .....	62	Solids .....	109
falls .....	144	Sonorous things .....	377
" down a chimney	65	Soot in summer .....	71
of fresh coals .....	45	on ceilings .....	71
candles .....	81	Sooty kettles .....	174
lamps diminish-		SOUND .....	377
ed by a glass.	83	affected by frost ..	381
red-hot coals...	45	heat ..	381
rises .....	107	arrested by mist ..	381
useful in cooking..	186	wet...	380
Smoky chimneys .....	63	diminished by rarity	
<i>See chimney.</i>		of air .....	383
Smoke jacks .....	108	heard best by night	381
Smouldering wicks .....	56	in a frost	380
Snow .....	309	inaudible on moun-	
arrests sound .....	380	tains .....	383
bad conductor ...:	311	velocity of .....	377
cause of. ....	310	Sounds musical .....	377
falls in winter ....	310	prevented from	
" not in summer	312	passing from	
like wool .....	164	room to room	381
nourishes the earth	311	Soup long cooling .....	215
on mountains .....	312	Sources of heat .. 9 to	15
soon melts beneath		South wind rainy 285,	300
a hedge or wall	191	warm ....	285
use of .....	310	South-east wind rainy	286
warm .....	310	Sparks from a fire ....	105
mixed with salt,		a flint ....	196
cold .....	332	a horse-	
white .....	312	shoe ...	97
Soap .....	321	Spectacles .....	361
cleansing .....	321	black .....	376
hard, soft .....	321	blue .....	375
yellow .....	321	for aged .....	362

	Page		Page
<b>Spectacles</b> for near sight	360	<b>Steam</b> , why visible . . . .	112
<b>Spectrum</b> . . . . .	377	what becomes of it	113
<b>Split bells</b> . . . . .	378	<b>STEEL</b> affected by light-	
<b>Sponge swells</b> when wet	316	ning . . . . .	36
<b>SPONTANEOUS COMBUS-</b>		and flint make a	
<b>TION</b> . . . . .	60, 84	spark . . . . .	96
of forests . . . . .	99	purple . . . . .	233
<b>Spoons</b> become dull . . . .	234	rusts . . . . .	233
bent in water . . . . .	359	prevented	233
discolored by eggs	254	<b>Stick</b> burnt makes a	
retard boiling . . . . .	113	circle of light . . . . .	374
<b>Speaking</b> produces hun-		<b>Stillness</b> before a storm	139
ger . . . . .	88	<b>Stirring</b> cools broth, &c.	228
<b>Spray</b> white . . . . .	371	<b>Stockings</b> difficult to	
<b>Spring</b> , best late . . . . .	288	draw on when wet . .	317
erumbles the earth	333	<b>STONES</b> broken by frost	326
bracing . . . . .	140	cold . . . . .	159
verdure . . . . .	372	collect no dew	193
<b>Spring water</b> cool . . . .	171	snap in fire . . . .	106
"    "    sparkles.	249	unfit for fuel . .	49
<b>Springs</b> prevent freez-		<b>STORMS</b> . . . . .	139
ing . . . . .	331	direction of . . . . .	34
<b>Sprinkling</b> to cool rooms	150	distance of, told	16, 19
<b>Stagnant water</b> . . . . .	323	follow dry weather	33
full of worms	323	places of danger in	19
<b>Stale beer</b> , &c. ( <i>see beer</i> )	255	"    safety in	26
<b>Stars</b> , distance and size		prevail in summer	
of . . . . .	355	and autumn . . . .	33
invisible by day . .	342	rare in wet weather	34
seem flat . . . . .	356	<b>STOVES</b> crack when	
seen in a well . . . .	342	lighted . . . . .	118
seen on mountains	350	when cooling . .	118
twinkle . . . . .	374	of bricks . . . . .	163
<b>Starvation</b> . . . . .	86	on a floor . . . . .	54, 217
produces dirtiness	93	rust . . . . .	240
laziness	89	most in win-	
leanness	86	ter . . . . .	232
madness	86	not often . . . .	232
<b>STEAM</b> . . . . .	122	prevented . . . .	232
engines burst . . . .	217	settings fall away	118
invisible . . . . .	112, 216	smell of sulphur . .	59
of a kettle . . . . .	216	smoke . . . . .	69
"    locomotive . . .	201	close . . . . .	62
pipes should not be		warm a room . . . .	21
black . . . . .	184	<b>Strata</b> of air . . . . .	1

	Page		Page
Stratus clouds . . . . .	129	Summer allays hunger	91
Straw covered over brick-		clothes for . . . . .	175
work . . . . .	334	creates dislike of	
over trees . . . . .	334	grease . . . . .	91
" water-pipes . . . . .	334	" love of fruit	92
Streets dark from a light		lightning . . . . .	17
room . . . . .	340	Sun-beams full of motes	228
seem to meet at		SUN affects eyes . . . . .	375
bottom . . . . .	354	dazzles . . . . .	340
watered . . . . .	150	dulls fire . . . . .	53
Striking iron makes it		hardens earth . . . . .	153
hot . . . . .	94	largest at horizon.	350
Struggling in water dan-		not seen in a well.	348
gerous . . . . .	336	radiates heat . . . . .	183
Stucco peels off in frost	333	reflected in water.	349
Sublimates . . . . .	454	seems flat . . . . .	356
Sublimation . . . . .	454	source of heat . . . . .	10
Sudden light painful . .	339	Sun-rise red . . . . .	127, 134
SUGAR . . . . .	249	Sun-set gray . . . . .	135
anhydrous . . . . .	250	red . . . . .	133, 135
ferments . . . . .	249	yellow . . . . .	133, 134
at top of tea melts		Super-acetate of lead . .	454
quickly . . . . .	389	Suspended animation	
flavors water . . . . .	322	restored . . . . .	99
left at the bottom		Swallows fly low . . . . .	144
of a cup melts		Swan dry in water . . . .	206
slowly . . . . .	388	Sweet-wort needs yeast	252
makes alcohol . . . . .	250	Swimmers sink . . . . .	336
" carbonic acid . . . . .	250	Swimming . . . . .	337
melted by water . . . . .	322	in the sea . . . . .	335
" especially by		Syrup, boiling point of	115
hot water . . . . .	322	Table salt . . . . .	454
of lead . . . . .	454	Tainted meat cured	72, 389
retards boiling . . . . .	114	in moonlight.	203
stirred melts quick-		water . . . . .	72
ly . . . . .	388	Tallow . . . . .	74
white . . . . .	372	Tarnish . . . . .	233
Sulphate of lime . . . . .	320, 454	Tartar emetic . . . . .	454
magnesia . . . . .	454	Tartrate of potash . . . .	454
soda . . . . .	454	Tarts have a cup inside	116
zinc . . . . .	454	full of juice . . . . .	117
Sulphuric acid . . . . .	454	Taste . . . . .	392
and water . . . . .	37	TEA cooled by blowing	228
boils . . . . .	115	by stirring	228
Summer, air in . . . . .	293		

	Page		Page
<b>Tea</b> cooled in a saucer	153	Tin-blowers reflectors	181
green, deleterious	390	<i>See reflectors.</i>	
poison for flies	390	Tinder blown . . . . .	96
<b>TEA-POT</b> , bright metal.	184	Toast and water . . . . .	73
tarnishes	234	dry, for the sick..	73
black earth . . . . .	184	Tomb-stones frosted ..	177
preferred by		Tongs rust . . . . .	232
some . . . . .	184	prevented..	232
set on a hob . . . . .	184	Tools hot from use . . .	99
<b>Tea-spoons</b> tarnished .	234	Trade winds . . . . .	277, 280
by eggs	254	Transparency . . . . .	373
Telescopes . . . . .	357	Treble . . . . .	379
Tempest . . . . .	139	<b>TREES</b> barked by light-	
affects weather	305	ning . . . . .	34
<i>See storms.</i>		collect dew . . . . .	190
Thaumatrope . . . . .	374	covered with	
<b>THAW</b> affects barometer	308	bass, &c. . . . .	334
cold . . . . .	331	look more dis-	
dulls fire . . . . .	55	tant in a fog..	141
Theatre dangerous . . . .	25	not frost-bitten.	211
Thermometer . . . . .	119, 296	promote warmth	152
Thick clothing un-		purify air . . . . .	242
healthy . . . . .	154	shade of, cool ..	171
Thread gloves cool . . . .	176	Trefoil forebodes rain .	143
<b>THUNDER</b> . . . . .	15	Tube of barometer . . . .	297
after lightning . . . . .	17	Tubs dried up . . . . .	153
bolts ( <i>see fulgurites</i> )	17	Tumblers ( <i>see glasses.</i> )	
deep growl . . . . .	16	Twilight . . . . .	370
distance of, told.	16, 18	Twinkling of stars . . . .	374
followed by rain..	17	Two eyes . . . . .	343
wind.	17	" see single ..	343
irregular roar . . . . .	15	logs burn best . . . . .	49
one crash . . . . .	15	Unslit chestnuts . . . . .	103
rolling . . . . .	17	Use of barometers . . . . .	298
<i>See danger, safety, storm.</i>		clouds . . . . .	132
<b>Tigers</b> prowl by night.	342	smoke in cooking	186
see in the dark.	341	snow . . . . .	310
sleep all day . . . . .	341	Valley chimneys smoke	67
<b>Tiles</b> broken by frost..	326	VAPORIZATION . . . . .	122
<b>Timber</b> charred . . . . .	73	Vapor a conductor . . . . .	25
<b>Tin-blowers</b> . . . . .	70	forms fog and	
foot-warmers . . . . .	162	cloud . . . . .	209
" covered with		of a carriage .	197
flannel . . . . .	162		
plate-warmer . . . . .	177		

	Page		Page
Vapor of a room . . . . .	196	WATER ( <i>see rain</i> ) . . . . .	319
of sea not salt	154	and lime . . . . .	31, 37
Varnish to prevent rust	232	and sulphuric acid	37
Vats fatal . . . . .	244	ashes soften . . . . .	321
Vegetable and animal		bad conductor	161, 214
life dependent . . . . .	225	boiling . . . . .	115, 213, 215
Vegetables absorb car-		bubbles . . . . .	111, 214
bonic acid . . . . .	225	rattles . . . . .	112
agreeable in sum-		runs over . . . . .	111
mer . . . . .	91	sings . . . . .	109
collect dew . . . . .	192	cleans dirty linen . . . . .	321
cool the blood . . . . .	92	cold . . . . .	160
exhale oxygen . . . . .	224	converted to steam	
Velocity of clouds . . . . .	294	121, 319	
light . . . . .	338	cools slowly . . . . .	207
sound . . . . .	384	deep. freezes slowly	330
wind . . . . .	294	dried up in summer	153
Vent peg . . . . .	255	elastic . . . . .	253
VENTILATION . . . . .	93, 295	expands by frost . . . . .	327
sought by the		by heat . . . . .	327
well-fed . . . . .	93	extinguishes fire	57, 106
sought not by the		not always	57, 58
ill-fed . . . . .	93	flat when boiled . . . . .	257
Verdigris . . . . .	454	fluid . . . . .	319
Vertical sun . . . . .	273	flowing, pure . . . . .	324
Vinegar antiseptic . . . . .	389	for washing . . . . .	259, 320
distilled . . . . .	454	freezes at the sur-	
Violets blue . . . . .	371	face . . . . .	328
Violins musical . . . . .	378	fresh, sparkles . . . . .	260
Vitreous electricity	11, 23	frozen by ether . . . . .	334
Vitriol, oil of . . . . .	454	air-pump	335
white . . . . .	454	fuel . . . . .	58
Walls to arrest sound . . . . .	382	furr of . . . . .	237
wet in winter . . . . .	199	hard . . . . .	320
" in a thaw . . . . .	199	agreeable to drink	260
Want connected with		unfit for washing	320
dirt . . . . .	92	how preserved cool	179
Warm clothes . . . . .	175	hot	179, 187
some things more		heated . . . . .	213
than others . . . . .	155	intensifies fire . . . . .	57
Warming rooms . . . . .	217	inverts images . . . . .	346
Wash-hand basin . . . . .	160	kept hot . . . . .	215
Washing, water for . . . . .	259	melts sugar, salt,	
should not be hard	320	&c. . . . .	322
		especially hot	373

	Page		Page
<b>Water mixed with salt,</b>		<b>Weather, prognostics of</b>	130
boils slower . . . . .	115	told by barometer	296
needful for ferment-		rules for . . . . .	299
ation . . . . .	255	<b>Weather-toys . . . . .</b>	317
not heated above		<b>Well, stars seen in . . . . .</b>	348
boiling . . . . .	215	sun not seen in . . . . .	348
of a spring cool ..	171	<b>West winds . . . . .</b>	201, 285
oscillates . . . . .	324	<b>Wet clothes give cold</b>	148
pump, agreeable..	260	safe . . . . .	27
hard . . . . .	319	feet dangerous . . . . .	148
purified . . . . .	72	finger cold . . . . .	148
purifies bins, &c. .	259	indications of 134 to	136
reflects sun by a spot	350	kindling . . . . .	48
moon by a path	349	night oppressive..	137
running, keeps pure	324	sheets . . . . .	149
salt, bad for wash-		summer, cold win-	
ing . . . . .	320	ter . . . . .	151
shallow, freezes		weather offensive	
fastest . . . . .	330		137, 140
simmers . . . . .	109	<b>Wettest months . . . . .</b>	307
slackens flame . . . . .	58	<b>Wheels catch fire . . . . .</b>	98
soft . . . . .	259, 321	greased . . . . .	98
best for washing	321	kept cool by water	153
sparkles . . . . .	249	<b>Wheel-ruts frozen . . . . .</b>	325
stagnant . . . . .	323	<b>Wheelwright . . . . .</b>	117
full of worms	323	<b>WHITE . . . . .</b>	371
stale . . . . .	257	blisters . . . . .	178
swells with boiling	110	body linen . . . . .	174
will not bubble		crust on clothes..	154
without soap..	324	dresses for summer	175
warm when frozen	330	" not fit for win-	
<b>Water-pipes broken by</b>		ter . . . . .	175
frost . . . . .	327	mist . . . . .	138
covered with litter	334	vitriol . . . . .	454
<b>Watering plants by the</b>		<b>Wicks, cotton, need</b>	
saucer . . . . .	388	snuffing . . . . .	80
streets . . . . .	150	gas of . . . . .	262
<b>Waves . . . . .</b>	292	have a nob when	
<b>Wax . . . . .</b>	74	long . . . . .	80
candles need no		not upright when	
snuffing . . . . .	80	long . . . . .	80
<b>Weather affected by</b>		Palmer's, need no	
tempests . . . . .	305	snuffing . . . . .	80
affected by weight		rekindled quickly	55, 58
of air . . . . .	297	smoke . . . . .	81

	Page		Page
		Windows rattle .. . . .	387
		Wine-glasses ( <i>see glasses.</i> )	
Will o' the wisp, ( <i>see ignis fatuus</i> ) . . . . .	266	Wine, fermentation of	249
WIND . . . . .	268, 296	made without yeast	254
affects barometer.	299	Winter clothing . . . . .	164
"    clouds	125, 127	Winters less severe . . .	157
after lightning . . . .	17	Winter cold . . . . .	151
altered by clouds . .	276	promotes hunger	90
"    by electricity	127	WISDOM OF GOD	153, 166,
"    by seas . . . . .	275	193, 195, 225, 283, 289,	328, 333
always blows . . . . .	272	Wood ashes soften water	322
brings clouds . . . . .	132	burns . . . . .	46
"    dry . . . . .	286	"    spontaneously	59
"    rain . . . . .	286	charred . . . . .	72
cause of . . . . .	268, 272	hot at one end, cold	
changes the shape		at the other . . . .	55
of clouds . . . . .	123, 125	ignited by friction	97
cold . . . . .	171, 184	kindling . . . . .	47
dispels clouds	125, 133	"    dry . . . . .	49
"    fog . . . . .	210	"    wet . . . . .	49
draws up fire . . . . .	55	made incombustible	49
dries linen . . . . .	295	sends forth sparks	105
effects on air . . . . .	268	snaps . . . . .	103
feels hot sometimes	169	two logs burn best	49
increases clouds . .	125	will not melt . . . . .	122
makes barometer		Wooden handles . . . . .	156
fall . . . . .	299	Woodpeckers cry before	
makes chimneys		rain . . . . .	141
smoke . . . . .	67, 108	WOOL bad conductor . .	156
near mountains . . .	276	collects no dew . .	193
of a morning . . . . .	289	warm . . . . .	165, 311
of an evening . . . . .	290	Woollen clothing . . . . .	164
prevents dew . . . . .	191	kettle holders . .	157
velocity of . . . . .	293	Work produces hunger	87
regular . . . . .	277	Yeast . . . . .	215
<i>See monsoon, north, south,</i>		makes light bread	275
<i>west, &amp;c., trade-winds,</i>		not used in wine	245
<i>&amp;c.</i>		used in brewing . .	215
Winding passages famed		Yellow flame gives best	
for echoes . . . . .	384	light . . . . .	51
Windows blazing with		soap . . . . .	321
the sun . . . . .	347	sun-set sign of wet	133
not at noon . . . . .	347	Zig-zag lightning . . . . .	12
covered with frost	197		
"    "    mist	196		
carriage, dull . . . .	197		



## INDEX TO PART III.

	Page		Page
Above proof.....	449	Books discolored by	
Abundance of dew a		age.....	423
sign of fine weather	392	Brazil pebbles.....	438
Acetic acid.....	446	Bread.....	426
Acid stains removed..	420	full of eyes....	399
Acryle.....	447	hard from age..	410
Agate.....	438	mouldy.....	427
Air rots wood.....	429	new, indigestible	410
Albumen.....	407	Bridges increase sound	433
Ale.....	443	Brine preserves meat.	407
Alkali.....	420	Brown paper burns well	393
Alkaline phosphates..	441	stieky from	
of meat	407	rubbing..	405
Amethyst.....	438	Brown stout.....	443
ANTIDOTES FOR POISONS	452	Brushing hair makes	
Apples sour.....	446	the head itch....	395
Aqua-fortis, antidote for	452	Burning glass ignites	
Arsenic, antidote for	452	paper.....	393
Baking dough into		Burton ale.....	443
bread.....	426	Butter hard from cold	412
Barometers measure		soft from heat.	412
heights.....	406	Cairngorum.....	438
Barytes.....	451	Candescence.....	431
Beer.....	443	Candle flickering.....	395
sour from bad cork-		Candle-wick smell....	447
ing.....	444	Carbonic acid.....	439
Below proof.....	449	Caries.....	447
Binoxide.....	394	Casein.....	424, 443
Birds kept in feathers	428	Caves increase sound.	413
Black earth turns red	402	Cellular fibre.....	438
Blackness from decay	419	Cellulin.....	414
Block-tin.....	451	Chalcedony.....	438
Bloodstones.....	438	Champagne.....	448
Blue looks green by		Chandelier lustrous...	404
candle-light.....	393	Chaps and chilblains..	402
Blue sky.....	439	Cheese.....	425
Boiled lobster red....	419	Chlorate of potash....	417
shrimp red....	429	Chloride of lime.....	440
Boiler bursts.....	395	Chlorine, antidote for.	442
Boiling meat.....	402	Chlorophyll.....	411
stale milk, curdles	424	Chucky stone.....	438
Boiling wood makes it		Churning makes butter	425
soft.....	437	Claret.....	448

	Page		Page
Clothing warm if loose	399	Dentine.....	417
Clouds do not hide light	439	Dextrin.....	427
Citric acid.....	446	Diastase.....	427
Citrons sour.....	446	Double doors increase	
Cold affects skin.....	402	heat.....	397
Color.....	396	Double reflexions in	
destroyed by dark-		glass.....	438
ness.....	396	Dough.....	426
faded by sun.....	425	made bread....	426
Contagion prevented..	442	Drops of water spread.	406
Copper bursting.....	395	Dust laid by night....	401
Copper cankers.....	436	Effervescing draughts.	420
Cork of soda-water flies	401	Egg tarnishes silver...	423
pops	401	tarnish removed by	
Cornelian.....	438	salt.....	422
shines, if wet	397	Electricity sticky.....	405
Corrosive sublimate...	440	Essential oils.....	436
antidote for	453	Explosive lucifers....	416
Court buttons.....	415	Explosion of gunpowder	442
Cream made butter...	425	Fat solid.....	411
Creasote.....	444	Ficus.....	448
for tooth-ache...	447	Filaments.....	437
to remove taint.	444	Fire destroys steel-pol-	
Crombs made by boil-		ish.....	413
ing.....	437	revived by brush	398
Crystal.....	438	by poker	398
Cup filled beyond brim	455	quenched by sul-	
not if edge be wet	415	phur.....	421
Curdling milk.....	423	warps wood....	425
Curling paper with		Fire-works.....	451
knives.....	418	Fish luminous.....	439
Currants hard.....	443	Fixed oils.....	436
ripe, soft.....	443	Flag-stones loose in frost	396
Curtains promote heat	397	Flickering of candles..	395
Damp lucifers.....	417	Flint.....	438
of decay.....	410	Flowers bend to sun..	429
Darkness spoils color.	396	Fog makes sun red....	393
Decanter-stopper sticks	418	Frost loosens pavement	396
Decanting liquor, gur-		Fruit, antidote for....	453
gles.....	416	Fungus.....	427
Decay, <i>see rot.</i>		Glasses filled above brim	415
black.....	402	not if wet.....	415
Decay of teeth.....	447		
theory of.....	403		

	Page		Page
Glazed pictures some- times invisible....	401	Ink-spots removed....	436
Glazier mending a win- dow.....	404	turn yellow	394
Glue adhesive.....	432	Interstices.....	406
Gooseberries hard....	443	Iodine, antidote for...	453
soft, if ripe	443	Iris ornaments.....	415
sour.....	446	Iron bends.....	430
Grapes sour.....	446	galvanized.....	450
Grease spots removed.	436	hisses.....	430
Greasy paper unfit for writing.....	435	melts.....	431
Green fire-works.....	451	rusts.....	398
fruit hard.....	443	turns red.....	431
wood rots.....	413	turns white.....	431
Grindstone wet.....	425	Itch.....	440
Guano.....	438	Itching caused by hair brush.....	395
Gum adhesive.....	432	Jeweller's gold.....	450
Gunpowder explosive.	442	Knife sharpened by grindstones.....	426
Gurgling explained... 416		Lactic acid.....	424
Gutta percha.....	448	Lamb soon taints.....	409
Hams smoked.....	444	tender.....	408
Hard bread.....	410	Larks roasted with lard	407
soap.....	445	Lather.....	399
Hartshorn removes acid stains.....	420	Laudanum, antidote for	452
Heat warps wood....	425	Lead differs from solder	450
Hock.....	448	Legumine.....	445
Horn shavings opaque	404	Lemons sour.....	446
Humus.....	436	Ligneous matter.....	414
Hydrate.....	436	Light, when cloudy... 439	
of the carbonate		Lightning conductors pointed.....	421
of copper....	436	Likeness reversed in a glass.....	417
Ice in India.....	434	Lime for manure.....	438
Ice-pits.....	434	Lime-juice cures scurvy	440
Indian houses kept cool	435	Limes sour.....	446
Indian-rubber.....	448	Linen starched.....	421
erases pencil marks	429	Liquor gurgles.....	416
Indian-rubber sticky..	405	Locomotive whistle... 412	
Indigo blue, white....	420	Lucifer matches.....	416
Infection prevented... 450		spoilt by damp.	417
Ink.....	394	Lustres variegated....	403
Ink-spots black.....	394		

	Page		Page
Manure for land.....	438	Oxalic acid.....	445
Marking ink.....	449	antidote for.....	452
Marl for manure.....	438	removes ink-spots	436
Meadows reverberate.	433	Oxide of potassium...	445
Meat, directions for		Paint blisters.....	409
boiling.....	408	preserves wood.	413
preserved.....	444	prevents rust... 398	
tough when old	408	Pannary fermentation.	410
overcooked	408	Paper curls by scraping	418
boiled in cold		discolored by age	423
water.....	408	Partridges roasted with	
putrefies from		lard .....	409
change .....	428	Paste adhesive.....	432
damp..	428	Pencil marks erased..	429
heat... 427		Peroxide.....	394
Mice destroyed.....	442	of iron red..	403
Milk boils over.....	400	Pewter .....	450
quickly... 433		Phosphate .....	407
burns.....	432	of lime.....	440
curdles .....	423	of meat....	407
by rennet	424	Phosphoric acid.....	439
sour from boiling	424	Pictures glazed invis-	
heat... 424		ble.....	451
keeping	424	Plants bend to sun....	429
Molecules.....	431	Plants white if kept in	
Moon shadow strong..	420	the dark.....	411
Mother of pearl.....	414	Plaster of walls peals off	403
Mouldy bread.....	437	Points discharge elec-	
Mountains, meted.....	406	tricity.....	422
Mutton fat hard.....	411	POISONS, antidotes for	452
Oak bark contains iron	419	Polish of steel destroy-	
Oak struck by lightning	419	cd by fire.....	413
Oar bent in water....	392	Pop-guns pop.....	412
Oil liquid.....	411	Porter, dark.....	453
prevents water		Port-wine.....	448
freezing.....	432	Potatoes boiled.....	422
thick in winter	411	Proof spirit.....	448
used on grind-		Protoxide.....	394
stones .....	426	of iron black	403
Oleine.....	411	of copper... 436	
Onanthate.....	447	Prussic acid, antidote	
of ethyle.. 447		for .....	453
Oranges sour.....	446	Putty dancing.....	404
Overboiled meat tough	408	Putrefaction.....	424

	Page		Page
Putrid fish luminous..	439	Sesquioxide of iron...	394
Pyroligneous acid.....	444	Shadow of moon and sun	420
Quails roasted with lard	409	dark.....	443
Quartz.....	438	Shear steel.....	449
Railway whistle.....	412	Sherry.....	448
train passing a bridge		Shrill sounds.....	412
or meadow.....	433	Shrimps red.....	420
Rain brings down cold	435	Silent lucifers.....	416
Rats destroyed.....	442	Silica.....	438
Red earth.....	403	Silver hotter than nickel	448
fireworks.....	451	tarnished by egg,	
Reflection in a glass		cleaned.....	422
double.....	438	by salt cleaned	437
reversed	417	Sky blue.....	439
Rennet.....	425	Small beer.....	443
curdles milk... ..	424	Smell of sick rooms re-	
Rhubarb sour.....	446	moved.....	442
Ripe fruit soft.....	443	Smelling-bottle stopple	
Rock crystal.....	428	sticks.....	418
Rooms kept warm by		Smoked meat.....	444
curtains.....	397	Soap made of fat.....	445
Rot.....	413, 429, 441	Soapy water lathers... ..	399
Rotting leaves hot....	410	Soda in tea.....	444
Rust.....	398	Soda water cork flies out	402
prevented by paint	398	pops..	401
Sails of mill turn.....	396	Soft soap.....	445
Salt.....	423	Solder.....	450
beef produces scurvy	440	Sorrel sour.....	445
remedy... ..	440	Sound.....	412
meat not nutritious	407	heard furthest	
meat needs vegetables	408	on sea.....	405
removes tarnish from		louder in caves.	413
silver.....	422	silenced by touch	399
wine stains.....	442	Sour milk.....	424
tarnishes silver.....	437	curdles.....	423
tarnishes removed..	437	Sponge cleans a slate.	400
Salts preserve meat... ..	407	Spores, Sporules.....	427
wood... ..	414	Stains removed....	420, 436
Sapid.....	409	Starch glazes linen....	406
Scraped paper curls... ..	418	stiffens linen... ..	421
Scurvy.....	440, 441	Stars twinkle.....	400
Sea luminous.....	440	Stearine.....	411, 445
		Steel made from iron.	449
		made brittle....	434
		Stirring a fire.....	399

	Page		Page
Stopples stick.....	418	Vegetables black from	
Strands.....	437	decay.....	419
Strontian.....	451	essential with salt	
Stucco falls off.....	403	meat.....	408
Sulphate of lime.....	441	prevent scurvy... 407	
soda.....	423	wet from decay... 403	
Sulphur quenches fire.	421	Verdigris.....	436
Sulphuret of silver....	423	antidote for..	433
Sulphuretted hydrogen	442	Vinegar sour...*	446
Sulphuric acid.....	421	Volatile oils.....	436
antidote for	452	Walking-stick crows.	437
Sulphurous acid.....	421	Water.....	388
Sugar of dough.....	410	freezes if exposed.	431
Sun fades colors.....	426	sooner than milk	431
red in fog.....	393	when boiled	432
warps wood.....	425	hisses on fire.....	430
Tainted meat.....	428	rots wood.....	429
Tamarinds sour.....	446	seasons wood.....	414
Tannate of iron.....	436	spreads on cloth..	406
Tannic acid.....	394, 436	used on grindstones	426
Tanning leather.....	446	Warm clothing.....	397
Tarnish of silver.....	437	Wax hard.....	409
removed, 423,	437	liquid.....	409, 434
of zinc.....	436	makes cotton strong	437
Tartaric acid.....	446	soft.....	434
Tea.....	444	Wet of decay.....	403
improved by soda	444	Wet sponge cleans slate	400
in Tartary.....	445	White lead.....	450
rushes to a spoon.	415	leaves.....	411
Teeth decay.....	447	Whistle of locomotive.	412
Teroxide.....	394	Windows mended.....	404
Tooth-ache, cause of..	447	Windmill sails.....	399
cure of... 447		Wine casks smell.....	446
Touch stills sound....	399	sour from corking	444
Tough meat.....	408	stains removed....	441
Turpentine removes		strength.of.....	448
grease spots.....	436	Wood, decay of.....	441
Twinkling.....	400	flexible, if boiled.	437
Unseasoned wood rots	413	preserved by paint	413
by salts		rotted by air....	429
Veal soon taints.....	409	warped by heat..	425
tender.....	408	Warts cured.....	453
Vegetable fibre.....	414	Zinc tarnish.....	436

Published by James Miller, 522 Broadway.

---

# THE FAVORITE SCHOLAR,

By Mary Howitt.

And Other Tales. 63 cts.

---

## THE BOY'S BOOK OF INDIAN BATTLES & ADVENTURES,

WITH ANECDOTES ABOUT THEM. 88 cts.

---

## TRAVELS AND SURPRISING ADVENTURES OF BARON MUNCHAUSEN.

Illustrated with 10 full-page, and 22 smaller Engravings. 88 cts.

---

## A M Y D E A N E, AND OTHER STORIES.

BY VIRGINIA F. TOWNSEND.

88 cts.

---

## THE CHILD'S OWN TREASURY OF FAIRY TALES.

Containing the best and most popular Fairy Tales.

Beautifully Illustrated. Square 16mo. \$1.25.

NEW AND ATTRACTIVE  
**JUVENILES**

JUST PUBLISHED BY JAMES MILLER.

---

**THE DREAM OF LITTLE TUK,**

AND OTHER TALES.

BY HANS CHRISTIAN ANDERSEN.

Illustrated. 50 cts.

---

**THE STORY OF CECIL AND HIS DOG**

Illustrated. 88 cts.

---

*Claudine, and the Garland of Everlastings.*

Illustrated. 63 cts.

---

**RIGHT AND WRONG, & THE GOLD CROSS**

Illustrated. 63 cts.

---

**ALWAYS HAPPY;**

Or, Anecdotes of Felix and his Sister Serena.

Illustrated. 63 cts.

---

**The Well in the Rock, and Other Stories**

BY VIRGINIA F. TOWNSEND.

Illustrated. 88 cts.



# NEW AND ATTRACTIVE JUVENILES, Just Published.

## TRAVELS AND SURPRISING ADVENTURES OF BARON MUNCHAUSEN.

Illustrated with 11 full-page, and 22 smaller Engravings. 88 cts.

## THE LIFE AND ADVENTURES OF ROBINSON CRUSOE.

By DANIEL DE FOE, including a Memoir of the Author, with an Essay on his writings. Printed on tinted paper, and beautifully illustrated by THWAITES. 63 cts.

## PEBBLES FROM JORDAN;

OR,

## BIBLE EXAMPLES OF EVERY-DAY TRUTH.

By MISS GRAHAM, with Engravings by J. A. ADAMS. 38 cts.

## BLIND ARTHUR, AND OTHER STORIES:

Being a collection of "Moral Lessons and Stories on the Proverbs," designed to render some of those inspired sayings more easy and familiar to children. By JANE STRICKLAND Illustrated by J. A. ADAMS. 38 cts.

## LILIES FROM LEBANON;

OR,

## SCRIPTURE SKETCHES.

By MISS GRAHAM, embellished with 8 beautiful Wood-cuts by ADAMS. 38 cts.

## THE CHILD'S OWN PICTURE AND VERSE BOOK.

Selected and arranged from the best authorities, by a "Grandfather." Illustrated with 100 full-page Engraving. Plain, 75 cts.; colored, \$1.25.

## FAVORITE FAIRY TALES

## FOR LITTLE FOLKS.

With 70 Illustrations by THWAITES and others, engraved by the best artists. 75 cts.

ALWAYS HAPPY;

OR

Anecdotes

OF

FELIX AND HIS SISTER SERENA.



NEW YORK:

PUBLISHED BY JAMES MILLER,

(SUCCESSOR TO J. S. FRANCIS & CO.,)

522 BROADWAY.

MDCCCLXIV.

**THE CHILD'S OWN  
TREASURY OF FAIRY TALES.**

Embracing the best and most popular of the old  
fashioned Fairy Tales, and Illustrated  
in the highest style of Art.

---

**FAVORITE FAIRY TALES  
FOR LITTLE FOLKS.**

With 70 Illustrations by THWAITES and others.

---

**POPULAR FAIRY TALES  
FOR LITTLE FOLKS.**

With 60 Illustrations from original designs.

---

This series of Fairy Stories has for generations been listened to and read by children with a delight which all others have failed to afford them.

That these editions may be more perfect than any others extant, they have been embellished with exquisite specimens of high Pictorial Art, from which children may derive those correct ideas that will mature into the beautiful and grand.

# AMY DEANE

And other Tales.

BY VIRGINIA F. TOWNSEND.



ILLUSTRATED.

NEW YORK:  
PUBLISHED BY JAMES MILLER,  
(SUCCESSOR TO C. S. FRANCIS & CO.,)  
522 BROADWAY.  
1864

# AMY DEANE,

AND OTHER STORIES.

BY VIRGINIA F. TOWNSEND.

Beautifully Illustrated.

---

The interesting character of these stories, and the high moral tone which, without becoming tedious, pervades them all, recommends this book in a special manner to our Young Friends. The Publisher is satisfied that on perusal it will be found to compare favorably with any of the tales of Mary Howitt, Miss Edgeworth, Mrs. Hofland, &c., &c.

---

## THE MAGIC RING,

AND OTHER ORIENTAL FAIRY TALES.

ILLUSTRATED.

---

The same simplicity of style and elegance of language, which have rendered the "Arabian Nights" so justly popular, will be found in the above book, which the Publisher now offers, and which will, he is confident, when better known, take rank amongst our most Popular Juvenile Literature.

---

## THE FAVORITE SCHOLAR.

By MARY HOWITT.

AND OTHER TALES.

PALEY'S  
EVIDENCES OF CHRISTIANITY.

With Annotations

By RICHARD WHATELY, D. D.,  
ARCHBISHOP OF DUBLIN.

One Volume, Octavo, Cloth, \$1.75.

The Publisher feels great pleasure in calling the attention of the religious and thinking portion of the community to his very handsome edition of this work of the celebrated PALEY, a man remarkable for vigor and clearness of intellect, and originality of character, and acknowledged by all to be the greatest among the divines of his age, and without a superior since the days of the early fathers of the Protestant Church. To add to the value of that which is intrinsically valuable in itself, the volume now presented to the American Public is enriched with "Annotations" by the celebrated Dr. Whately, Archbishop of Dublin, than whom there is no clearer thinker or more powerful writer in the Protestant Hierarchy of our day.

*Also, uniform with the above,*

BACON'S ESSAYS,

With Annotations

By RICHARD WHATELY, D. D.

One volume, Octavo, Cloth, - - - - \$2.50.

JAMES MILLER, Publisher,  
522 Broadway, New York.

# FESTUS;

A POEM,

BY PHILIP JAMES BAILEY,

BARRISTER AT LAW.

1 volume, Blue-and-gold, \$1. 00. 12mo, \$1 25.

"It is an extraordinary production."—*London Literary Gazette.*

---

## WORKS OF WILLIAM WARE.

---

ZENO B I A; or the Fall of Palmyra. In letters of L. Manlius Piso, from Palmyra, to his friend Marcus Curtius, at Rome. 1 vol., 12mo, - - - - \$1.50

A U R E L I A N; or Rome in the Third Century. In Letters of Lucius M. Piso, from Rome to Fausta, the daughter of Gracchus, at Palmyra. 1 volume, 12mo, - - - - - \$1.50

J U L I A N; or Scenes in Judca. 1 vol., 12mo, - \$1.50

JAMES MILLER, Publisher,

522 Broadway.







